

ACADEMICIA

ISSN (online) : 2249-7137

# ACADEMICIA

An International  
Multidisciplinary Research  
Journal

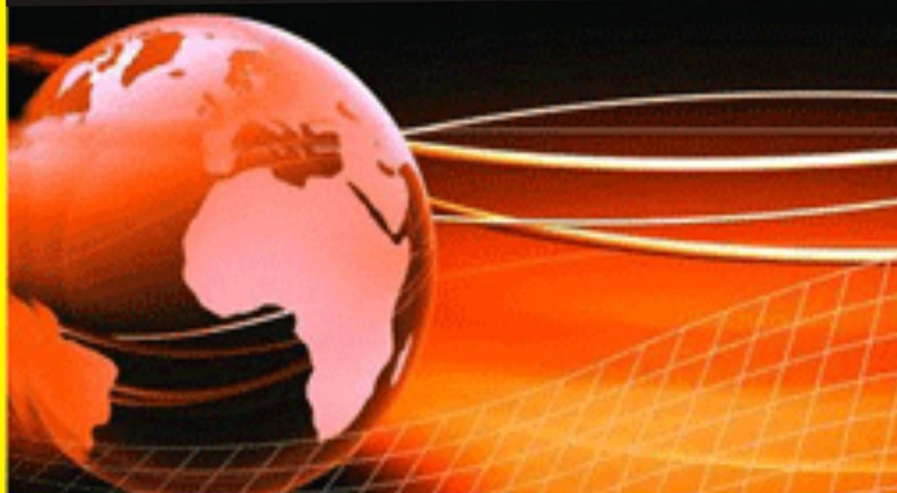

Published by  
**South Asian Academic Research Journals**  
A Publication of CDL College of Education, Jagadhri  
(Affiliated to Kurukshetra University, Kurukshetra, India)

**ACADEMICIA**

An International Multidisciplinary Research Journal

ISSN (online) : 2249 –7137

Editor-in-Chief : Dr. B.S. Rai

Impact Factor : SJIF 2021 = 7.492

Frequency : Monthly

Country : India

Language : English

Start Year : 2011

Indexed/ Abstracted : Scientific Journal Impact Factor (SJIF2020 - 7.13), Google Scholar, CNKI Scholar, EBSCO Discovery, Summon (ProQuest), Primo and Primo Central, I2OR, ESJI, IJIF, DRJI, Indian Science and ISRA-JIF and Global Impact Factor 2019 - 0.682

E-mail id: saarjournal@gmail.com

**VISION**

The vision of the journals is to provide an academic platform to scholars all over the world to publish their novel, original, empirical and high quality research work. It propose to encourage research relating to latest trends and practices in international business, finance, banking, service marketing, human resource management, corporate governance, social responsibility and emerging paradigms in allied areas of management including social sciences , education and information & technology. It intends to reach the researcher's with plethora of knowledge to generate a pool of research content and propose problem solving models to address the current and emerging issues at the national and international level. Further, it aims to share and disseminate the empirical research findings with academia, industry, policy makers, and consultants with an approach to incorporate the research recommendations for the benefit of one and all.



# ACADEMICIA

## An International Multidisciplinary Research Journal

(Double Blind Refereed & Peer Reviewed International Journal)



SR. NO.	PARTICULAR	PAGE NO.	DOI NUMBER
1.	<b>E-LEARNING IN INDIA: SOME DYNAMIC INITIATIVES IN HIGHER EDUCATION</b> Dr Sandeep Kaur, Pooja Gothwal	<b>1-10</b>	<b>10.5958/2249-7137.2021.01027.2</b>
2.	<b>ON THE SPIRITUAL UPBRINGING OF YOUNG PEOPLE IN THE WORKS OF AJINIEZ QOSIBAY OGLU</b> Taspanova J.K	<b>11-16</b>	<b>10.5958/2249-7137.2021.01015.6</b>
3.	<b>IMPROVING THE PRACTICE OF FORMING FINANCIAL RESOURCES OF ENTERPRISES</b> Xoliqov Sardor Botiroqli, Tajibekova Dilnoza Baxtiyarovna, Jiyanova Nargiza Esanbayevna	<b>17-21</b>	<b>10.5958/2249-7137.2021.01016.8</b>
4.	<b>FLAWS AND DIRECTIONS IN FINE ART, ARTISTIC PERCEPTION OF WORKS</b> Smaylova Gulmari Yuldashevna	<b>22-25</b>	<b>10.5958/2249-7137.2021.01017.X</b>
5.	<b>PSYCHOLOGICAL PROCESSES AND WAYS TO PREVENT INFECTION IN ADOLESCENTS LIVING WITH HIV</b> Karimjonova Yoqutxon	<b>26-28</b>	<b>10.5958/2249-7137.2021.01018.1</b>
6.	<b>STUDY OF EPIDEMIOLOGICAL FEATURES OF VISCERAL LEISHMANIASIS IN ENDEMIC AREAS OF THE REPUBLIC OF UZBEKISTAN</b> Gaybullaev Fazliddin Khayriddinogli	<b>29-32</b>	<b>10.5958/2249-7137.2021.01019.3</b>
7.	<b>INTERCULTURAL COMMUNICATION AND TEACHING FOREIGN LANGUAGES</b> Tukhlieva Gavkhar Nurislamovna, Qurbonova Mushtariy Abdujabborqizi, Abdullaeva Nigora Rustamovna, Azodova Mahliyo Neymatjonqizi	<b>33-39</b>	<b>10.5958/2249-7137.2021.01020.X</b>
8.	<b>PEDAGOGICAL TECHNOLOGIES OF ENGLISH TEACHING IN A MODERN EDUCATION SYSTEM</b> Dilkhumor Sherzodkizi Israilova, Shaxerizode Solijonqizi Kodirova, Arofat Ibroximqizi Shorasulova	<b>40-45</b>	<b>10.5958/2249-7137.2021.01007.7</b>
9.	<b>USE OF E-LEARNING RESOURCES IN FOREIGN LANGUAGE LESSONS AND REQUIREMENTS TO IT</b> Mavjuda Mardievna Bolibekova, Dilkhumor Sherzodkizi Israilova	<b>46-49</b>	<b>10.5958/2249-7137.2021.01008.9</b>
10.	<b>THE PROBLEM OF STUDYING THE ADAPTIVE SYSTEMS OF CHILDREN'S BODIES UNDER THE INFLUENCE OF ENVIRONMENTAL FACTORS IN THE SOUTH ARAL SEA REGION</b> N.P. Mirametova, U. Azilova, Q. Abdullaev, S. Kamalova	<b>50-55</b>	<b>10.5958/2249-7137.2021.01009.0</b>

11.	<b>CUSTOMS AND CEREMONIES OF POPULATION OF JIZZAKH OASIS ASSOCIATED WITH THE BIRTH OF CHILD</b> Jumanazarova Dilnoza, Davlatova Khakima	<b>56-59</b>	<b>10.5958/2249-7137.2021.01010.7</b>
12.	<b>THE METHODOLOGICAL PROBLEMS OF THE HISTORICO-PHILOSOPHICAL INVESTIGATIONS OF BERUNI</b> Gulnora Nosirkhodjaeva	<b>60-66</b>	<b>10.5958/2249-7137.2021.01013.2</b>
13.	<b>IN THE SOCIO-ECONOMIC LIFE OF UZBEKISTAN THE ROLE OF WOMEN: CHANGES AND DEVELOPMENT TRENDS</b> Khakimali Azimov	<b>67-72</b>	<b>10.5958/2249-7137.2021.01014.4</b>
14.	<b>THE PLACE OF DRUM INSTRUMENTS AND SONGS IN THE ART OF BAKHSHIL</b> Zafar Hayitov	<b>73-78</b>	<b>10.5958/2249-7137.2021.01042.9</b>
15.	<b>A STUDY OF MEASURING THE SOCIAL DETERMINANTS OF SUBJECTIVE WELL-BEING OF WORKING WOMEN (WITH SPECIAL REFERENCE TO BALANGODA DIVISIONAL SECRETARIAT DIVISION)</b> U.S. Thathsarani, N.M. Wijesekara	<b>79-83</b>	<b>10.5958/2249-7137.2021.01028.4</b>
16.	<b>SOCIO-ECONOMIC CHANGES IN UZBEK VILLAGES</b> Makhmudov Makhmudbek Avazovich	<b>84-86</b>	<b>10.5958/2249-7137.2021.01011.9</b>
17.	<b>OBTAINING HIGH-MOLECULAR HYDROCARBONS FROM SYNTHESIS GAS AND PHYSICO-CHEMICAL CHARACTERISTICS OF THE CATALYST</b> Shukurov J.H, Kunguratov K.A, Ortiqov N.R, Fayzullaev N.I	<b>87-95</b>	<b>10.5958/2249-7137.2021.01012.0</b>
18.	<b>ANALYSIS OF CHANGES IN FIBER PROPERTIES IN PROCESSES OPENING, CLEANING AND CARDING</b> Sodikov Muhamad Rashid ogli, Omonov Muhammad Turdialio'gli, Tojimirzaev Sanjar Turdialievich, Gofurov Adkhamjon Bahromjonogli	<b>96-104</b>	<b>10.5958/2249-7137.2021.01043.0</b>
19.	<b>THE CONFLICT OF WORDS AND SPIRIT IN ALISHER NAZAR'S POETRY</b> Kurbanbayev Ilhombek Aminbayevich	<b>105-110</b>	<b>10.5958/2249-7137.2021.01021.1</b>
20.	<b>INDIVIDUAL LEANER DIFFERENCES: THE ROLE OF MOTIVATION IN TEACHING FOREIGN LANGUAGE</b> Soibova Gulchiroy Bakhtiyorjonqizi, Qurbonova Mushtariy Abdujabborqizi, Alimova Iroda Khayritdinovna, Mengniyozova Zebo Ahmadovna	<b>111-114</b>	<b>10.5958/2249-7137.2021.01022.3</b>
21.	<b>THEORETICAL AND METHODOLOGICAL ASPECTS OF THE DEVELOPMENT OF CHILDREN'S INTELLECTUAL AND CREATIVE ABILITIES ON THE BASIS OF MEDIA EDUCATION</b> Shermanova Feruza Djumaboevna	<b>115-121</b>	<b>10.5958/2249-7137.2021.01023.5</b>
22.	<b>LOCAL PHYTOTHERAPY OF CHRONIC GENERALIZED PERIODONTITIS (REVIEW)</b> Shukurova U.A, Azizova Sh. Sh, Yakhoyeva M, Musashaikhova Sh.K	<b>122-128</b>	<b>10.5958/2249-7137.2021.01024.7</b>
23.	<b>PRIVILEGES AND PREFERENCES GIVEN TO ENTREPRENEURS ENGAGED IN EXPORT ACTIVITIES AND FURTHER DEVELOPMENT OF THE ELECTRICAL INDUSTRY</b> U.X.Normurzaev	<b>129-131</b>	<b>10.5958/2249-7137.2021.01025.9</b>

24.	<b>SOME PROBLEMS IN TEACHING ENGLISH AND NEW EDUCATIONAL TECHNOLOGIES</b> Kurbaniyazova Sarbinaz Ametovna, Esbergenova Gumshagul Bekbergenovna, Utepbergenova Damegul Najimatdinovna	<b>132-135</b>	<b>10.5958/2249-7137.2021.01026.0</b>
25.	<b>LEGAL BASIS OF IMPROVING THE SOCIAL PROTECTION SYSTEM</b> Kadirov Umidjon Abdimuratovich	<b>136-139</b>	<b>10.5958/2249-7137.2021.01031.4</b>
26.	<b>INTERPRETATIONS ON THE THEORY OF SUFISM (VIEWS ON THE TERM SUFISM, PLACE AND TIME OF ITS EMERGENCE)</b> Ismoilov Kahramonjon Abdumuminovich	<b>140-146</b>	<b>10.5958/2249-7137.2021.01032.6</b>
27.	<b>BASES FOR RELEASING JUVENILES FROM CRIMINAL LIABILITY</b> Akramova Muazzam	<b>147-153</b>	<b>10.5958/2249-7137.2021.01033.8</b>
28.	<b>EFFECT OF CLINICAL AND PHYSIOLOGICAL INDICATORS OF RABBITS IN FERULA ASSAFOETIDA</b> Eshmatov Gairat, Khudoikulov Islomjon, Hakimov Akbar	<b>154-157</b>	<b>10.5958/2249-7137.2021.01030.2</b>
29.	<b>THE ROLE OF SUBJECTS IN TEACHING FUTURE ENGINEERS TO SOLVE PROBLEMS RELATED TO PRODUCTION PRACTICE</b> Movlonov Maruf Qalandarovich	<b>158-161</b>	<b>10.5958/2249-7137.2021.01034.X</b>
30.	<b>LEADERSHIP STYLE AND ITS IMPACT ON EMPLOYEE'S JOB RELATED STRESS A STUDY BASED ON JAFFNA DISTRICT SECRETARIAT IN JAFFNA DISTRICT, SRI LANKA</b> Miss. Sorubini Murugiah	<b>162-172</b>	<b>10.5958/2249-7137.2021.01029.6</b>
31.	<b>SIGNIFICANCE OF MULTIMEDIA TUTORIAL ON LEARNING IN DISTANCE EDUCATION</b> Raximova Gulchexra Obidjonovna	<b>173-180</b>	<b>10.5958/2249-7137.2021.01044.2</b>
32.	<b>DEVELOPING ENGLISH SPEAKING SKILL THROUGH ONLINE INTERACTIVE AND COMMUNICATIVE LESSONS</b> Rasulova Dilnoza Boiskhanovna	<b>181-187</b>	<b>10.5958/2249-7137.2021.01045.4</b>
33.	<b>DEVELOPING STUDENTS' UNDERSTANDING ON THE USAGE OF BLOG IN LINGUISTICS COURSE</b> Aliyeva Dilorom Kholmatovna	<b>188-195</b>	<b>10.5958/2249-7137.2021.01046.6</b>
34.	<b>LEGAL EDUCATION IN THE PROCESS OF BUILDING A CIVIL SOCIETY</b> Djurayev Anvar Mukhammadiyevich, Makhmudov B.Kh	<b>196-200</b>	<b>10.5958/2249-7137.2021.01054.5</b>
35.	<b>SOCIAL CONTRADICTIONS AND THEIR FORMS OF MANIFESTATIONS</b> Hasanov Sharofiddin Shamshurovich	<b>201-207</b>	<b>10.5958/2249-7137.2021.01035.1</b>
36.	<b>TEACHING STUDENTS TO THINK INDEPENDENTLY AND CREATIVELY THROUGH THE ORGANIZATION OF TRAINING'S AS A TOPICAL ISSUE</b> Atkham Nisolmuhamedovich Ziyayev	<b>208-213</b>	<b>10.5958/2249-7137.2021.01036.3</b>
37.	<b>ORGANIZATION OF THE REPORTING OF THE CRIME PREVENTION INSPECTOR TO THE POPULATION AS A CONTROL SYSTEM</b> Kolmakov Ivan Konstantinovich	<b>214-219</b>	<b>10.5958/2249-7137.2021.01037.5</b>

38.	<b>THEORY OF POLITICAL COMMUNICATION</b> Ravshanjon Omonov	<b>220-224</b>	<b>10.5958/2249-7137.2021.01038.7</b>
39.	<b>THE EFFECT OF SOWING TIME, SOWING RATES AND FERTILIZATION RATES TO FIELD GERMINATION OF WINTER BREAD WHEAT VARIETIES</b> Azimova Mukhayyo Egamberdievna, Jononov Berdinazar Xudoynazarovich, Dilmurodov Sherzod Dilmurodovich	<b>225-231</b>	<b>10.5958/2249-7137.2021.01039.9</b>
40.	<b>THE ROLE OF CROWDFUNDING IN INVESTMENT PROCESS AND INTERACTION OF CROWDFUNDING PLATFORMS</b> Ruzibaeva Nargiza Khakimovna, Khotamkulova Madina Sanjar kizi	<b>232-241</b>	<b>10.5958/2249-7137.2021.01040.5</b>
41.	<b>FACTORS OF MORAL EDUCATION OF THE CHILD IN THE FAMILY</b> Sheralieva Munavvar Abdullaevna, Babakeldieva Aziza Abdusamatovna	<b>242-245</b>	<b>10.5958/2249-7137.2021.01041.7</b>
42.	<b>MODERN WATER EQUIPMENT: DESIGN FOUNTAINS</b> Rakhmatova Mekhrinis Murodovna	<b>246-250</b>	<b>10.5958/2249-7137.2021.01047.8</b>
43.	<b>IMPROVING THE STATUS, MOVEMENT AND OBSOLESCENCE ACCOUNT OF CONSTRUCTION MACHINERY</b> O. Kh. Kholikulov	<b>251-257</b>	<b>10.5958/2249-7137.2021.01048.X</b>
44.	<b>ROADS, ROAD LINES AND THERMOPLASTIC PRODUCTS USED IN THEIR DRAWING</b> Shukurov M.M, Nurdinov M.A, Hudoynazarov N.B, Ismoilov R.I	<b>258-263</b>	<b>10.5958/2249-7137.2021.01049.1</b>
45.	<b>NATIVITY VS FACTORS TOWARDS EMPOWERMENT- T TEST</b> Dr. S. Valli Devasena	<b>264-272</b>	<b>10.5958/2249-7137.2021.01055.7</b>
46.	<b>INVESTMENTS AND PROMOTION IN THE TRANSPORT SECTOR</b> Masharipov Masudjon Numonjonovich, Allamuratova Munira Saidmurotqizi, Nazirov Nozimjon Nodirjonogli	<b>273-277</b>	<b>10.5958/2249-7137.2021.01050.8</b>
47.	<b>INTERPRETATION OF HISTORICAL EVENTS IN THE WORK OF MUKIMI</b> Kuldosh Pardaev	<b>278-283</b>	<b>10.5958/2249-7137.2021.01051.X</b>
48.	<b>VALUE OF HEMOSTASIS SYSTEM INDICES IN RESPIRATORY RECURRENT PAPILLOMATOSIS</b> Nozima Shamsutdinovna Najimutdinova, Abdugafur Akhatovich Hadzhimetov	<b>284-288</b>	<b>10.5958/2249-7137.2021.01056.9</b>
49.	<b>THE RECENT PAST AND PRESENT OF THE PROTECTION OF HISTORICAL AND CULTURAL MONUMENTS IN UZBEKISTAN</b> Oybek Alikulovich Ostonov, Khamdam Alikulovich Akhmedov, Khusan Ochilboyevich Khushvaktov, Khidirov Kholmurod Norimovich	<b>289-294</b>	<b>10.5958/2249-7137.2021.01057.0</b>
50.	<b>BASIC CONCEPTS RELATED TO TERMS IN WORLD LINGUISTICS</b> Munavvar Sanakulovna Kayumova, Zamira Sharifovna Rozmetova, Nozima Kuchkarovna Muxtarova	<b>295-300</b>	<b>10.5958/2249-7137.2021.01058.2</b>
51.	<b>NEWS MEDIA TEXTS IN CONTEMPORARY ENGLISH: COGNITIVE SEMANTIC AND LINGUOCULTURAL CHARACTERISTICS</b> Khilola Otakhonova	<b>301-308</b>	<b>10.5958/2249-7137.2021.01070.3</b>

52.	<b>THE PECULIARITIES OF USING DISTANCE LEARNING AND INDEPENDENT WORK IN TEACHING PROCESS</b> Yusupova Shakhnoza Abdulkhafizovna	<b>309-315</b>	<b>10.5958/2249-7137.2021.01059.4</b>
53.	<b>LEGAL FRAMEWORK FOR THE ACTIVITIES OF POLITICAL PARTIES</b> Usmonova Nigora Aktamovna, E.A. Qadirov	<b>316-321</b>	<b>10.5958/2249-7137.2021.01060.0</b>
54.	<b>MODELING THE PROCESS OF DEFORMATION OF VISCOELASTIC TEXTILE MATERIALS</b> Gulara Abdieva, Aziza Adizova, Tulkin Mavlanov, Dilfuza Rakhimova	<b>322-327</b>	<b>10.5958/2249-7137.2021.01061.2</b>
55.	<b>INTERNATIONAL FINANCIAL ACCOUNTING STANDARDS IN UZBEKISTAN</b> Qudbiyev Nodir Tohirovich	<b>328-332</b>	<b>10.5958/2249-7137.2021.01062.4</b>
56.	<b>“TECHNOLOGY OF USING A NEW DEVICE THAT SOFTENS THE CRUST”</b> Juraev Azamat Jalil ugli, Farmonov Nozimjon Qosimovich, Ibodov Islom Nizamiy ugli, Najimov Dilshodbek Kuvonch ugli	<b>334-338</b>	<b>10.5958/2249-7137.2021.01071.5</b>
57.	<b>ABOUT METHODOLOGICAL COMPONENTS OF THE TEXTBOOK "BIOLOGY" FOR STUDENTS OF 11TH GRADE OF SECONDARY EDUCATIONAL INSTITUTIONS AND SECONDARY SPECIAL, VOCATIONAL EDUCATIONAL INSTITUTIONS</b> Ahmedova Odinaxon Hatamovna, Zokirov Kozimjon	<b>339-345</b>	<b>10.5958/2249-7137.2021.01072.7</b>
58.	<b>MEDICAL LINGUISTICS, LINGUISTIC ANALYSIS OF DISEASES</b> Shohida Olmasovna Ergashova	<b>346-350</b>	<b>10.5958/2249-7137.2021.01073.9</b>
59.	<b>THE ESSENCE OF ECOLOGICAL AND RECREATIONAL TOURISM IN OUR COUNTRY, AND THE IMPORTANCE OF DEVELOPING IT</b> Gapparov Azim Kayumovich	<b>351-355</b>	<b>10.5958/2249-7137.2021.01074.0</b>
60.	<b>ACCEPTABILITY AND CHALLENGES OF ONLINE ASSESSMENT AT ZCAS UNIVERSITY DURING THE COVID-19 ERA</b> Kelvin Mukolo Kayombo, Brian Mwiinga	<b>356-373</b>	<b>10.5958/2249-7137.2021.01086.7</b>
61.	<b>INTERACTIVE METHODS OF TEACHING MATHEMATICS IN PRIMARY EDUCATION</b> Laziza Gaybullaeвна Rasulova	<b>374-380</b>	<b>10.5958/2249-7137.2021.01088.0</b>
62.	<b>REVIEWS OF EFFECTIVE USE OF EDUCATIONAL METHODS IN TEACHING LATIN AND MEDICAL TERMINOLOGY</b> Makhmudov Zafar Mardanovich, Sharipov Bobur Salimovich, Buriyev Dilmurod Arzimurodovich	<b>381-386</b>	<b>10.5958/2249-7137.2021.01063.6</b>
63.	<b>RESEARCH POLYMER COATINGS MATERIAL PROPERTIES AND APPLICATION FEATURES</b> Makhammadjanov Khusanboy Alisherogli	<b>387-392</b>	<b>10.5958/2249-7137.2021.01064.8</b>
64.	<b>THE ATTITUDE TOWARDS WOMEN IN UZBEKISTAN DURING THE SOVIET PERIOD</b> Sobirova Dilfuza Tukhtasinovna, Abdullaev Farkhodbek Hasan ogli	<b>393-395</b>	<b>10.5958/2249-7137.2021.01065.X</b>
65.	<b>OPTIMIZATION OF THE PARAMETERS OF THE AURBAND PROCESS IN THE MANUFACTURE OF WARP THREADS FOR NATIONAL AURB FABRICS</b> Umarova Munavvar Omonbekovna, Siddikov Patxillo Siddiqovich	<b>396-400</b>	<b>10.5958/2249-7137.2021.01066.1</b>

66.	<b>THE ROLE OF HEALTH IN IMPROVING THE LIVING STANDARDS AND WELFARE OF THE POPULATION</b> Firdavs Urokov Ortikniyozovich	<b>401-405</b>	<b>10.5958/2249-7137.2021.01075.2</b>
67.	<b>THE ROLE OF HOTEL SERVICES IN THE DEVELOPMENT OF THE ECONOMY OF OUR COUNTRY AND THE THEORETICAL ISSUES OF THEIR DEVELOPMENT</b> Rakhimov Hasan Abdusaidovich	<b>406-410</b>	<b>10.5958/2249-7137.2021.01076.4</b>
68.	<b>SOME DISADVANTAGES OF THE ARCHITECTURAL DESIGN OF RESIDENTIAL BUILDINGS AND THEIR SOLUTIONS</b> Rakhmonov Gayrat Fazliddinovich	<b>411-416</b>	<b>10.5958/2249-7137.2021.01077.6</b>
69.	<b>CONTROL OF STOCK CURRENT IN FIELD-EFFECT TRANSISTORS BY GATE VOLTAGE</b> Suvonova Sohiba Ahmedjonovna, Turaev Akmal Ataevich	<b>417-421</b>	<b>10.5958/2249-7137.2021.01078.8</b>
70.	<b>“COMPOSITIONAL STRUCTURE AND DESIGN SOLUTION OF ARCHITECTURAL ENSEMBLES AND COMPLEXES OUTSIDE BUKHARA”</b> Usmonov Erkin Toyirovich	<b>422-425</b>	<b>10.5958/2249-7137.2021.01079.X</b>
71.	<b>THREE ASPECTS OF DETERMINING PEDAGOGICAL SKILLS (RESEARCH, EXPERIENCE AND RESULTS)</b> Nizom Toshmanov, Ahadxon Muhammadiev	<b>426-434</b>	<b>10.5958/2249-7137.2021.01080.6</b>
72.	<b>THE ACTIVE PARTICIPATION OF STUDENTS IN THE FORMATION OF THE EDUCATIONAL PROCESS IS A KEY TO EFFICIENCY</b> A.A. Kholmurzaev, I.Kh.Tokhirov	<b>435-439</b>	<b>10.5958/2249-7137.2021.01067.3</b>
73.	<b>DETAILED DESCRIPTION OF LEXICAL ITEMS IN “STRONG ARGUMENT”</b> Nurullaeva Zarina Hasanovna	<b>440-446</b>	<b>10.5958/2249-7137.2021.01068.5</b>
74.	<b>EVALUATION OF THE EFFECTIVENESS OF NEUROPROTECTIVE THERAPY ON RETINAL MORPHOMETRIC PARAMETERS IN PRIMARY OPEN-ANGLE GLAUCOMA</b> Karimova M.Kh, Abulkasimova Kh.Kh	<b>447-453</b>	<b>10.5958/2249-7137.2021.01069.7</b>
75.	<b>IMPACT OF DIVIDEND POLICY DETERMINANTS OF LISTED COMPANIES ON INDIAN CAPITAL MARKET</b> Ms. Anuriya K.J, Mr. Sreejith P.R, Dr. A. Ananth	<b>454-461</b>	<b>10.5958/2249-7137.2021.01089.2</b>
76.	<b>EFFECTIVE STRATEGIES IN TEACHING LISTENING SKILL</b> Hikmatova Dildora, Bakhridinova Odina, Mavutova Shakhlo	<b>462-465</b>	<b>10.5958/2249-7137.2021.01081.8</b>
77.	<b>OWN TORSIONAL VIBRATIONS OF A CYLINDRICAL SHELL IN AN ELASTIC MEDIUM</b> Saliyeva Olima Kamalovna, Sharipova Nazira Raxmatilloeyvna	<b>466-472</b>	<b>10.5958/2249-7137.2021.01082.X</b>
78.	<b>THE ROLE OF INTRODUCTORY WORDS AND PHRASES WITH A MODAL MEANING IN THE PROCESS OF STUDYING LITERARY STYLES AND WORKS</b> Baymatova Asal Rustamovna, Ishtukhtayeva Feruza Khurshid qizi, Toshmukhamedova Nafisa Shaxobiddin qizi, Hasanova Sevinch Hotam qizi, Mukhammadiyeva Shakhzoda Farkhodovna	<b>473-479</b>	<b>10.5958/2249-7137.2021.01083.1</b>



79.	VALENCE PROPERTIES OF THE VERB AND ITS POLY FUNCTIONALITY Gafurova Vazira Alisherovna, Raximova Madina Ramizovna, Amrillayeva Sabrina Azimjon qizi, Uktamova Shakhzoda Najmiddin qizi, Yuldasheva Sevara Ikhlos qizi	480-487	10.5958/2249-7137.2021.01084.3
80.	POLY FUNCTIONALITY OF A WORD IN THE CONTEXT OF SPEECH Sarimsokov Sirojiddin Shoyzokhovich, Sattarova Ismigul Bahtiyarovna, Khalilova Lenie Fevziyevna	488-491	10.5958/2249-7137.2021.01085.5
81.	IMPROVING THE USE OF DISTANCE LEARNING IN HIGHER EDUCATION Xidirova Barchinoy Ilxomovna, Goziev Rzoiddin Cholpon ogli	492-496	10.5958/2249-7137.2021.01090.9
82.	INFORMATION TECHNOLOGIES IN TEACHING PHYSICS IN A TECHNICAL HIGHER EDUCATION INSTITUTION Irkabaev Djumanali Usmanovich	497-500	10.5958/2249-7137.2021.01092.2
83.	THE METHODOLOGIES OF LEARNING ENGLISH VOCABULARY AMONG FOREIGN LANGUAGE LEARNERS Kuziyev Sarvarbek Ilmiddinovich	501-505	10.5958/2249-7137.2021.01093.4
84.	E-COMMERCE IN A MODERN BUSINESS SYSTEM Xidirova Barchinoy Ilxomovna, Goziev Rzoiddin Cholpon ogli, Karimova Shirin Zoxid qizi	506-510	10.5958/2249-7137.2021.01096.X
85.	ABOUT THE ONE METHOD OF CREATION OF ELECTRONIC TEXTBOOKS R. Raxmonkulov, K.K. Toshtemirov, G.A. Toshtemirov	511-518	10.5958/2249-7137.2021.01095.8
86.	TRENDS IN THE DEVELOPMENT AND FORMATION OF ARTIFICIAL INTELLIGENCE IN THE ECONOMY Qoldasheva Nargiza Komoliddin qizi, Xidirova Barchinoy Ilxomovna, Goziev Rzoiddin Cholpon ogli	519-525	10.5958/2249-7137.2021.01094.6
87.	THE EFFECTIVENESS OF USING THE CREDIT MODULE SYSTEM IN THE HIGHER EDUCATION SYSTEM Xidirova Barchinoy Ilxomovna, Goziev Rzoiddin Cholpon ogli	526-533	10.5958/2249-7137.2021.01091.0
88.	DEVELOPMENT OF EFFECTIVE COMPOSITIONS OF THERMAL-SALT-RESISTANT COMPOSITE CHEMICALS USING LOCAL AND SECONDARY MATERIALS Sharifov Gulomjon, Negmatova Komila, Sharipov Shavkat, Urazov Sharofiddin, Abdullaev Nurmukhammad	534-538	10.5958/2249-7137.2021.01087.9
89.	IMPROVING THE ORGANIZATION OF TEXTILE PRODUCTION BASED ON MARKETING RESEARCH Fayoza Tuxtamurodovna Bazarova	539-544	10.5958/2249-7137.2021.01097.1
90.	EFFICIENCY AND FINANCIAL SUSTAINABILITY OF MICROFINANCE INSTITUTIONS: A STUDY OF JAFFNA DISTRICT Velnamby, T, Ajanthan, A	545-561	10.5958/2249-7137.2021.01053.3
91.	PROSPECTS FOR SMALL BUSINESS AND ENTREPRENEURSHIP DEVELOPMENT IN UZBEKISTAN Sanjar Sabirjonovich Sabirjonov, Jamshid Nizam oglu Kubayev	562-566	10.5958/2249-7137.2021.01098.3
92.	MILITARY REFORMS AND MILITARY TRAINING IN THE REPUBLIC OF UZBEKISTAN Ravshan Siddikov	567-571	10.5958/2249-7137.2021.01099.5

93.	<b>THE ROLE OF THE TEACHER IN ENSURING THE QUALITY OF EDUCATION</b> Shaniyazova Dilafruz Sabirovna	<b>572-574</b>	<b>10.5958/2249-7137.2021.01100.9</b>
94.	<b>LINGUODIDACTIC BASES OF TEACHING OF THE TOURISM TERMS IN ENGLISH LANGUAGE AT EDUCATIONAL SYSTEM OF UZBEKISTAN</b> Nishanova Khafiza Vafokulovna	<b>575-581</b>	<b>10.5958/2249-7137.2021.01101.0</b>
95.	<b>THE EFFECT OF REPLANTING ON THE THICKNESS OF SEEDLING SEEDLINGS DEPENDS ON ITS VIABILITY AND SOIL FERTILITY</b> Komilova Dilfuza Kutbidinovna, Khalilova Marguba Gulomovna, Turgunbaev Khondamira khtiyorovich	<b>582-585</b>	<b>10.5958/2249-7137.2021.01102.2</b>
96.	<b>THE ROLE AND IMPORTANCE OF PROBLEMS IN THE THINKING OF PRIMARY SCHOOL STUDENTS</b> Dilfuza Tashpulatova	<b>586-588</b>	<b>10.5958/2249-7137.2021.01103.4</b>
97.	<b>EDUCATION IN PRESCHOOL EDUCATIONAL ORGANIZATIONS - THE IMPORTANCE OF USING THE MARIA MONTESSOR METHOD IN THE PROCESS OF EDUCATION</b> Boboqulova Nazokat Yusufovna	<b>589-594</b>	<b>10.5958/2249-7137.2021.01104.6</b>
98.	<b>SELECTION OF LARGE SEED AND HIGH YIELDING LINES OF BREAD WHEAT FOR DROUGHT CONDITIONS</b> Dilmurodov Sherzod Dilmurodovich, Shodiyev Sherzod Shomiljonovich, Abdumajidov Jaloliddin Raxmatullaevich, Hayitov Azizbek Sherkulovich, Mavlanov Javokhir Sarvar ogli	<b>595-606</b>	<b>10.5958/2249-7137.2021.01105.8</b>
99.	<b>HOMOCYSTEINE: EFFECT ON BIOCHEMICAL PROCESSES IN THE HUMAN BODY</b> Kucharova Inobat Sharofovna, Akbarov Nurislom Akhtamjon ogli	<b>607-612</b>	<b>10.5958/2249-7137.2021.01106.X</b>
100.	<b>THE CURRENT STATE OF THEORY AND TECHNOLOGY ENRICHMENT OF POLY METALLIC ORES AND ENRICHMENT PRODUCTS</b> Mutalova Markhamat Akramovna, Salidzhanova Gulnara Kakhkharovna, Ibragimov Izatilla Sulaymonovich, Suyarov Jakhongir Usmon ogli, Abdurakhmanova Nargiza Abdurasul qizi	<b>613-619</b>	<b>10.5958/2249-7137.2021.01107.1</b>
101.	<b>USE OF PORTFOLIO TECHNOLOGY TO EVALUATE TEACHERS AND STUDENT RATINGS</b> Xaitova Zarina Xobilovna, Yuldosheva Zulfizar Sayfulloqizi	<b>620-623</b>	<b>10.5958/2249-7137.2021.01108.3</b>
102.	<b>SCIENTIFIC AND METHODOLOGICAL BASES OF INTEGRATIVE IMPROVEMENT OF THE COURSE "POLYMER CHEMISTRY" UNDERGRADUATE EDUCATION "CHEMISTRY"</b> Kurbonova Gulchekhra Rayimovna, Nishonov Mirkozimjon Fozilovich	<b>624-627</b>	<b>10.5958/2249-7137.2021.01109.5</b>
103.	<b>CLINICAL SIGNS AND FREQUENCY OF POSTPARTUM ENDOMETRITIS IN BREEDING COWS</b> Abdiev S.B	<b>628-632</b>	<b>10.5958/2249-7137.2021.01110.1</b>
104.	<b>PREDICATIVITY AND INTONATION AS THE MAIN GRAMMATICAL FEATURES OF THE SENTENCE</b> Elvira Narbekova, Khurshid Khayrullayev	<b>633-638</b>	<b>10.5958/2249-7137.2021.01111.3</b>
105.	<b>FACTORS IN THE DEVELOPMENT OF LOGICAL THINKING IN MATHEMATICS LESSONS</b> B.H. Eshpulatov, B.T. Karamatov, G.SH. Ashurova, D.SH. Gafforova, G.M. Turlibaeva	<b>639-643</b>	<b>10.5958/2249-7137.2021.01112.5</b>

106.	IMPROVEMENT OF IRRIGATION REGIME OF COTTON VARIETIES DEPENDING ON SOIL AND CLIMATE CONDITIONS OF THE REPUBLIC OF KARAKALPAKSTAN Mambetnazarov Bisenbay Satnazarovich, Oteuliev Jaksilik Begdullaevich	644-647	10.5958/2249-7137.2021.01113.7
107.	THE IMPORTANCE OF INTEGRATED LESSONS IN PRIMARY EDUCATION B. A. Mavlonov, Jamshid Esirgapov	648-651	10.5958/2249-7137.2021.01114.9
108.	FORMATION OF NATIONAL PRIDE BASED ON HADITHS IN PRIMARY SCHOOL CHILDREN OF HOUSES OF KINDNESS Bibixol Khairullaevna Karimova, Munisa Shamsiddinova Oripova	652-665	10.5958/2249-7137.2021.01115.0
109.	ANALYSIS OF THE LEGISLATION ON CIVIL SERVICE IN THE REPUBLIC OF UZBEKISTAN Dilmurodjon Rakhimov	666-670	10.5958/2249-7137.2021.01116.2
110.	NEW WORLD ORDER AND INDIA, S POLICY TOWARD PROTECTION OF HUMAN RIGHTS IN AFGHANISTAN Sendhil kumar	671-677	10.5958/2249-7137.2021.01205.2
111.	READING CHARACTERISTICS AS A TYPE OF SPEECH ACTIVITY Kholmatova Shakhnoza Muminova	678-681	10.5958/2249-7137.2021.01200.3
112.	DEVELOPING INTERCULTURAL COMPETENCE OF PUPILS USING AUTHENTIC MATERIALS Ostonov Utkir Yangiboyevich, Uralova Charos G'anisherovna Babayeva Dilbar Xabibjanovna	682-692	10.5958/2249-7137.2021.01201.5
113.	THE IMPORTANCE OF MARKETING ACTIVITIES IN PLACEMENT TOOLS Salimova Sarvinoz Fazliddin kizi	693-699	10.5958/2249-7137.2021.01202.7
114.	IMPORTANCE OF ENTREPRENEURSHIP DEVELOPMENT IN TOURISM INDUSTRY (BUKHARA REGION) Umirov Jasur Temirkulovich	700-704	10.5958/2249-7137.2021.01203.9
115.	DEVELOPMENT OF COGNITIVE ACTIVITY IN FUTURE TEACHERS Yuldasheva Malohat Erkinovna	705-708	10.5958/2249-7137.2021.01204.0
116.	ISAJAN SULTAN'S CHARACTER CREATION SKILLS Gayrat Kenjabaevich Urazbaev	709-716	10.5958/2249-7137.2021.01117.4
117.	AGROTECHNICS OF GROWING RE-PLANTED BEAN VARIETIES Guliston Abdalova, Jasurbek Tajiyev, Sherali Odinayev	717-719	10.5958/2249-7137.2021.01118.6
118.	IMPROVEMENT OF COTTON NUTRITION PROCEDURE AND IRRIGATION TECHNOLOGIES Guliston Nuranovna Abdalova, Jamoliddin Saporbayugli Eshonkulov, Sarvar Olimugli Sulaymonov, Fazilat Marufqizi Abdullayeva	720-723	10.5958/2249-7137.2021.01119.8
119.	EFFECTIVE USE OF FUNGICIDES AGAINST THE FILLOSTIKTOZNOY P YATNISTOSTYU APPLE LEAVES UNDER FERGHANA VALLEY Mirzaitova M.K, Siddikova N.K	724-729	10.5958/2249-7137.2021.01120.4
120.	THE IMPORTANCE OF TEACHING ENGLISH TO CHILDREN IN PRESCHOOL EDUCATIONAL INSTITUTIONS Sayyora Yuldashovna Pulatova	730-733	10.5958/2249-7137.2021.01121.6

121.	<b>GENDEROLOGICAL CHARACTERISTICS OF UZBEK NICKNAMES</b> Shahnoza Ubaydullaevna Nizamova	<b>734-737</b>	<b>10.5958/2249-7137.2021.01122.8</b>
122.	<b>DYNAMICS OF JOURNALISTIC CONTENT: CHANGES IN FORM AND CONTENT</b> Sohiba Mullaeva	<b>738-745</b>	<b>10.5958/2249-7137.2021.01123.X</b>
123.	<b>IN THE SYSTEM OF PROFESSIONAL QUALIFICATION OF A MILITARY PEDAGOGUE - PSYCHOLOGICAL PROTECTION</b> Sukhrob Rustamjonovich Sadrididinov	<b>746-753</b>	<b>10.5958/2249-7137.2021.01124.1</b>
124.	<b>REVIEW OF ABDULLA KADIRI'S POETICS IN THE NOVEL "DAYS GONE BY" IN RUSSIAN TRANSLATIONS</b> Tulkin Khayriddinovich Saydaliev, Elmira Temirovich Erkaev, Dilshod Mamadiyarovich Djuraev, Islombek Khasanboy ugli Khasanov	<b>754-763</b>	<b>10.5958/2249-7137.2021.01125.3</b>
125.	<b>THE AMBIGUITY OF TURKISH WORDS THAT EXPRESS THINGS AND EVENTS IN THE EPIC "MALIKA AYYOR"</b> Umarov I	<b>764-769</b>	<b>10.5958/2249-7137.2021.01126.5</b>
126.	<b>PROPERTY OF GRAMMATICAL MEANINGS OF ADVERBS IN DIFFERENT SYSTEM LANGUAGES</b> Patila Mendirmanovna Zheenalieva, Kanymzhan Turdumamatovna Turgunbaeva, Nasiba Sayidmahamadovna Sayidirakhimova	<b>770-774</b>	<b>10.5958/2249-7137.2021.01207.6</b>
127.	<b>THEORETICAL FOUNDATIONS OF COLORING IN THE ORGANIZATION OF FINE ARTS CLASSES</b> Botir Boltabaevich Baymetov, Shoxidahon Odiljonovna Botirova	<b>775-782</b>	<b>10.5958/2249-7137.2021.01208.8</b>
128.	<b>THE USE OF MODULAR LEARNING TECHNOLOGY IN TEACHING PRIMARY SCHOOL STUDENTS TO THINK INDEPENDENTLY</b> Marguba Mirqobilovna Mirqosimova	<b>783-791</b>	<b>10.5958/2249-7137.2021.01211.8</b>
129.	<b>PROVERBS AND THEIR MORPHOLOGICAL SYSTEM</b> Nargiza Rustamovna Umarova, Odina Uktamovna Kholmatova	<b>792-797</b>	<b>10.5958/2249-7137.2021.01212.X</b>
130.	<b>INDIA NEEDS TO FOLLOW A COMPREHENSIVE POLICY TOWARD PROTECT SECULARISM: A CRITICAL ANALYSIS</b> D. Sendhil kumar	<b>798-804</b>	<b>10.5958/2249-7137.2021.01206.4</b>
131.	<b>CHALLENGES AND IMPORTANCE OF CENTRALIZATION AND DECENTRALIZATION OF LOCAL PUBLIC AUTHORITIES</b> Mardonov Aziz Botirovich	<b>805-809</b>	<b>10.5958/2249-7137.2021.01210.6</b>
132.	<b>THE PROBLEMS OF CONVERGENCE AND DIVERGENCE IN PRESENT DAY LINGUISTICS</b> Kuldashev Akram Makhmudovich, Kuldasheva Shakhnoza Akramovna	<b>810-816</b>	<b>10.5958/2249-7137.2021.01209.X</b>
133.	<b>INNOVATIVE APPROACH AND STATE TRAINING PROGRAM "FIRST STEP" IN THE IMPLEMENTATION OF THE PROCESS OF PRESCHOOL EDUCATION AND TRAINING</b> Olimov Kakhramon Tanzilovich, Turdieva Mokhira Jurakulovna	<b>817-821</b>	<b>10.5958/2249-7137.2021.01127.7</b>
134.	<b>CALCULATION OF THE PAYBACK PERIOD FOR THE INTRODUCTION OF REACTIVE POWER SOURCES INTO POWER SUPPLY SYSTEMS</b> A.B.Abubakirov, I.K.Gayipov, A.J.Sultanov, Sh.B.Kuatova	<b>822-826</b>	<b>10.5958/2249-7137.2021.01128.9</b>

135.	<b>THE LINGUOCULTURAL ANALYSIS OF ROBERT BURNS' AND BERDACH'S WORKS ON THE THEME OF "FREEDOM"</b> Toleubaeva Aliya Ondasinovna, Atanazarova Dilnaz Bakhtiyarqizi	<b>827-830</b>	<b>10.5958/2249-7137.2021.01129.0</b>
136.	<b>PHONETIC INTERFERENCE OF VOWEL PHONEMES IN UZBEK-RUSSIAN AND UZBEK-GERMAN BILINGUALISM</b> Askarova Shakhnoza Ismailovna	<b>831-836</b>	<b>10.5958/2249-7137.2021.01130.7</b>
137.	<b>FEATURES OF THE LIFESTYLE OF AQUATIC MOLLUSCS OF CENTRAL ASIA</b> Davronov Barno Orziyevich	<b>837-840</b>	<b>10.5958/2249-7137.2021.01131.9</b>
138.	<b>LINGUISTIC FEATURES OF UZBEK AND FRENCH WORDS WITH THE WORD "TOUR"</b> Hamzayev Hasan Rajabboyevich, Miyassarov Eldor Amanovich	<b>841-843</b>	<b>10.5958/2249-7137.2021.01132.0</b>
139.	<b>MODERN METHODS FOR DIAGNOSING THE FUNCTION OF EXTERNAL RESPIRATION IN CHILDREN WITH BRONCHIAL ASTHMA</b> Barno Turdikhodjaevna Khalmatova, Gulnoza Aloyevna Tashmatova, Nargis Khayrullayevna Mirsalikhova	<b>844-847</b>	<b>10.5958/2249-7137.2021.01133.2</b>
140.	<b>TO STUDY THE FREQUENCY OF PARASITOSIS AMONG CHILDREN WITH ALLERGIC DISEASES</b> Kasimova M.B, Mirrakhimova M.Kh, Yakhyayeva K. Z	<b>848-852</b>	<b>10.5958/2249-7137.2021.01134.4</b>
141.	<b>FIND THE LENGTHS OF TWO TRAJECTORIES THAT DIVIDE AN ARBITRARY TRIANGLE INTO THREE EQUAL ANGLES</b> Norkoziev Navruzbek Noralioglu	<b>853-857</b>	<b>10.5958/2249-7137.2021.01135.6</b>
142.	<b>THE IMPORTANT ROLE OF GYMNASTICS IN THE LIVES OF GIRLS</b> Asadova Shahlo Tulaboyevna	<b>858-860</b>	<b>10.5958/2249-7137.2021.01136.8</b>
143.	<b>PREPARING STUDENTS FOR RESEARCH ACTIVITIES BASED ON PROJECT TECHNOLOGY</b> G.S. Ergasheva, M. A. Sultanova	<b>861-864</b>	<b>10.5958/2249-7137.2021.01146.0</b>
144.	<b>BIO ECOLOGICAL PROPERTIES OF IRIS PSEUDACORUS L</b> Savutova Malohat Erkinovna	<b>865-868</b>	<b>10.5958/2249-7137.2021.01145.9</b>
145.	<b>POSSIBILITIES OF THE CREDIT-MODULAR SYSTEM IN TEACHER EDUCATION</b> Ibaidullaeva Balkhash Rahmatullakizi	<b>869-872</b>	<b>10.5958/2249-7137.2021.01144.7</b>
146.	<b>USE OF EXPERIMENTAL PLANNING METHODOLOGY TO STUDY THE FINAL DISTILLATION OF VEGETABLE OILS</b> Khabbirov Fakhridin Yusupovich	<b>873-878</b>	<b>10.5958/2249-7137.2021.01143.5</b>
147.	<b>ALISHER NAVOI TRADITION IN THE WORK OF MUAZZAMKHAN</b> Saydalieva Nasiba Farhodovna	<b>879-882</b>	<b>10.5958/2249-7137.2021.01219.2</b>
148.	<b>THE MAIN MORPHOLOGICAL FEATURES OF PHRASEOLOGY</b> Farhodova Maftuna Qudrat qizi, Karimboyeva Nodira	<b>883-886</b>	<b>10.5958/2249-7137.2021.01220.9</b>
149.	<b>EXPRESSION OF TEMPORALITY IN GERMAN AND KARAKALPAK LANGUAGES</b> Sapargul Tursinbaevna Bainiyazova, Azat Tursinbaevich Bainiyazov	<b>887-890</b>	<b>10.5958/2249-7137.2021.01221.0</b>

150.	<b>EMERGENCE OF WOMEN ENTREPRENEURSHIP VENTURES IN INDIA</b> Ms. Santika Timungpi, Dr. A. Ibemcha Chanu	<b>891-901</b>	<b>10.5958/2249-7137.2021.01223.4</b>
151.	<b>CRITERIA FOR THE FORMATION OF INNOVATIVE THINKING AND SOCIAL CONSCIOUSNESS IN YOUNG PEOPLE</b> Rajabboev Jurabek	<b>902-905</b>	<b>10.5958/2249-7137.2021.01217.9</b>
152.	<b>THE MAIN DIRECTIONS OF PREVENTION OF ADHESIONS IN ABDOMINAL AND THORACIC SURGERY</b> Eshonxodjaev Otabek Djuraevich, Dusiyarov Muxammad Mukumboevich, Sherbekov Ulugbek Axrorovich, Xujabaev Safarboy Tuxtayevich, Sherkulov Kodir Usmonkulovich	<b>906-915</b>	<b>10.5958/2249-7137.2021.01141.1</b>
153.	<b>THE IMAGE OF A BIRD IN THE WORKS OF ALISHER NAVOI</b> Mohira Islomova	<b>916-919</b>	<b>10.5958/2249-7137.2021.01140.X</b>
154.	<b>FOLKLORE AS A CRITERION OF SPIRITUAL AND MORAL DEVELOPMENT IN THE FORMATION OF THE PERSONALITY OF PRESCHOOL CHILDREN</b> Dilfuza Abdurahimova	<b>920-923</b>	<b>10.5958/2249-7137.2021.01139.3</b>
155.	<b>THE ROLE OF CHASHMAI AYUB BUKHARA WATER SUPPLY MUSEUM AND SOME ANCIENT WATER STRUCTURES IN THE FORMATION OF HYDRO LOGICAL OUTLOOK OF YOUNG PEOPLE</b> Yozil Qosimovich Hayitov, Malika Olimjonovna Rajabova, Iroda Ahmadali kizi Ramazonova	<b>924-935</b>	<b>10.5958/2249-7137.2021.01138.1</b>
156.	<b>THE ROLE OF TEACHING READING ACTIVITIES</b> Xakimboyeva Ozoda, Rozikova Madina, Pulatova Sabrina	<b>936-942</b>	<b>10.5958/2249-7137.2021.01137.X</b>
157.	<b>DIALOGIC SPEECH TRAINING UNITS</b> Paluanova M, Abishova G, Dauletbaeva R	<b>943-949</b>	<b>10.5958/2249-7137.2021.01156.3</b>
158.	<b>VISIBILITY IN TEACHING DIALOGIC SPEECH</b> Abishova G, Dauletbaeva R, Paluanova M	<b>950-954</b>	<b>10.5958/2249-7137.2021.01155.1</b>
159.	<b>GENITIVE CASE PREPOSITIONS IN GERMAN LANGUAGE AND THEIR PECULIARITIES</b> Babaeva Gulzira, Bakbergenov Aybek, Otebaeva Aysuliu	<b>955-962</b>	<b>10.5958/2249-7137.2021.01154.X</b>
160.	<b>LIOTRYPHON PUNCTULATUS – THE ECTOPARASITE OF CODLING MOTH</b> Berdiev Dzhura Khursandovich, Omonova Nafisa Rakhimovna, Norkobilova Zarina Boykobil kizi	<b>963-967</b>	<b>10.5958/2249-7137.2021.01153.8</b>
161.	<b>SOME ISSUES OF IMPROVING THE HYDRO GEOLOGICAL CONDITIONS OF THE SOILS OF KARAKALPAKSTAN</b> Abduvahob Ismonov, Gulnoza Kattayeva, Bakhtiyor Ramazonov	<b>968-973</b>	<b>10.5958/2249-7137.2021.01224.6</b>
162.	<b>PROBLEMATIC SITUATIONS IN HIGHER AUTHORITY ADMINISTRATION AND WAYS TO IMPROVE OF DEALING WITH THEM</b> Bekzod Shukhratovich Khaitov, Nargiza Muzaffarovna Babaeva	<b>974-977</b>	<b>10.5958/2249-7137.2021.01225.8</b>
163.	<b>HISTORY OF THE UZBEK NATIONAL THEATER AND MAKE-UP</b> Feruzat Suratovna Jalilova	<b>978-982</b>	<b>10.5958/2249-7137.2021.01226.X</b>

164.	<b>THE ROLE OF DIFFERENTIAL CALCULUS AND DIFFERENTIAL EQUATIONS IN SOLVING PRACTICAL PROBLEMS AIMED AT IMPROVING THE PROFESSIONAL TRAINING OF CIVIL ENGINEERS</b> Komiljon Kurbonalievich Turgunov	<b>983-991</b>	<b>10.5958/2249-7137.2021.01227.1</b>
165.	<b>THE NEED FOR A SPEECH DETECTION PROGRAM IN THE PROCESS OF SOCIAL INTEGRATION</b> Munavvara Abdujabbarovna Kurbanova	<b>992-995</b>	<b>10.5958/2249-7137.2021.01228.3</b>
166.	<b>CRITERIA FOR THE FORMATION OF INNOVATIVE MENTALITY AND SPIRITUAL AND MORAL QUALITIES OF YOUNG PEOPLE</b> Rajabboev Jurabek	<b>996-1000</b>	<b>10.5958/2249-7137.2021.01215.5</b>
167.	<b>SYSTEMATIC ANALYSIS OF FORMALIN PRODUCTION ON THE EXAMPLE OF WELL-KNOWN FOREIGN COMPANIES AND JSC "NAVOIAZOT"</b> Pulotova Mokhira Rakhmatiloevna, Jurayev Uchkun Yusuf ugli, Norkulov Intizor Odiljonovich, Rustamov Shakhzod Sirojiddin ugli, Saparboyev Ruzimboy Kadamboy ugli	<b>1001-1010</b>	<b>10.5958/2249-7137.2021.01152.6</b>
168.	<b>THE USE OF BLACK BOX METHOD IN AUTOMATION OF DRYING PROCESS OF FEED GRANULES ON THE BASIS OF AMARANTH</b> M. R. Pulotova, M. Sh. Abdullayev	<b>1011-1018</b>	<b>10.5958/2249-7137.2021.01150.2</b>
169.	<b>MAKING INFORMATION SECURITY STRATEGIC TO BUSINESS</b> S.M.Turdaliyev, A.R.Yuldashev, I.I.Djo'rayev, T.V.Mamadaliyev	<b>1019-1021</b>	<b>10.5958/2249-7137.2021.01149.6</b>
170.	<b>E-GOVERNANCE IN INDIA: CONCEPT, INITIATIVES AND CHALLENGES</b> Mrs. Anita, Dr. Pawan Kr. Sharma	<b>1022-1028</b>	<b>10.5958/2249-7137.2021.01222.2</b>
171.	<b>THE USE OF MODERN INTERACTIVE PEDAGOGICAL TECHNOLOGIES IN PRIMARY SCHOOLS</b> Oyshakhon Abdurasulova, Abdullaeva Gavkharoy, Ahmedova Mahfuza, Siddikova Mamura	<b>1029-1032</b>	<b>10.5958/2249-7137.2021.01148.4</b>
172.	<b>COMPARATIVE EVALUATION OF THE APPLICATION OF CALCIUM HYDROXIDE AND MATERIAL ON THE BASIS OF MINERAL TRIOXIDE OF THE BIO-DENT UNIT IN THE TREATMENT OF DEEP CARIES WITH TEMPORARY TEETH WITH LOW INVASIVE METHODS</b> Nigora Djuraeva	<b>1033-1037</b>	<b>10.5958/2249-7137.2021.01147.2</b>
173.	<b>THE RESULTS OF NEUTRON-ACTIVATION ANALYSIS OF THE ATMOSPHERE IN THE SOUTHERN REGIONS OF CENTRAL ASIA</b> Turaev Ergash Yuldashevich, Haydarova Muharram	<b>1038-1041</b>	<b>10.5958/2249-7137.2021.01166.6</b>
174.	<b>ANALYSIS OF THE CIRCUITS OF THE ELECTROMAGNETIC PRIMARY CURRENT AND VOLTAGE OF THE CONTROL AND CONTROL SYSTEMS</b> A.B.Abubakirov, M.N.Bekimbetov, R.J.Seytimbetov, Sh.B.Kuatova	<b>1042-1047</b>	<b>10.5958/2249-7137.2021.01165.4</b>
175.	<b>MOHLAROYIM NODIRA'S SKILL IN USING A SATELLITE</b> Imomaliyeva Musharrafhon Ilhomjon qizi	<b>1048-1052</b>	<b>10.5958/2249-7137.2021.01164.2</b>
176.	<b>PEDAGOGICAL AND PSYCHOLOGICAL FEATURES OF THE FORMATION OF THE CREATIVE ACTIVITY OF FUTURE TEACHERS THROUGH PERSONALITY-ORIENTED EDUCATION</b> Rakhimova Feruzakhon Mukhammadjonovna	<b>1053-1056</b>	<b>10.5958/2249-7137.2021.01163.0</b>

177.	<b>THE FACTORS OF INCREASING SOCIAL CREATIVE ACTIVITY OF YOUTH</b> Rajabboev Jurabek	1057-1061	10.5958/2249-7137.2021.01218.0
178.	<b>GENERAL CHARACTERISTICS OF THE MILITARY COMMITTEES OF THE ARMED FORCES OF THE REPUBLIC OF UZBEKISTAN</b> Boltaboyev. Abdugani, Yusupov Arabboy, Mansurov Mashrabbay	1062-1065	10.5958/2249-7137.2021.01161.7
179.	<b>THE IMPORTANCE OF PEDAGOGICAL IDEAS IN THE FORMATION OF YOUTH</b> Turgunboev Tohirjon Abdugafurovich	1066-1069	10.5958/2249-7137.2021.01160.5
180.	<b>DEVELOPMENT OF ENVIRONMENTAL LEGISLATION OF THE REPUBLIC OF KARAKALPAKSTAN AFTER GAINING INDEPENDENCE</b> Sultanbek Bazarbaevich Tanirbergenov	1070-1073	10.5958/2249-7137.2021.01159.9
181.	<b>LEGAL BASIS FOR THE DEVELOPMENT OF RADIO AND TELEVISION IN THE REPUBLIC OF KARAKALPAKSTAN</b> A.K. Utepbergenova	1074-1076	10.5958/2249-7137.2021.01158.7
182.	<b>THE CONCEPT OF «BUSINESS POTENTIAL»: ESSENCE, ECONOMIC SIGNIFICANCE</b> Bozorova Muborak Sharopovna	1077-1081	10.5958/2249-7137.2021.01157.5
183.	<b>IMPROVING TECHNOLOGIC EDUCATION ON THE BASIS OF THE STEAM METHOD</b> G.I. Ishmuradova, M. Kucharova	1082-1085	10.5958/2249-7137.2021.01176.9
184.	<b>THE IMPORTANCE OF INTERACTIVE GAMES IN ENGLISH LANGUAGE TEACHING AND THEIR IMPACT ON THE TEACHING PROCESS</b> Nosirova Dilfuza Nabieva	1086-1089	10.5958/2249-7137.2021.01175.7
185.	<b>THE FACTORS ACCELERATING THE INNOVATIVE ACTIVITY OF TEACHERS</b> Khalilova Feruza Abdulvosieva, Nasretdinova Feruza Nabieva	1090-1094	10.5958/2249-7137.2021.01174.5
186.	<b>PEDAGOGICAL BASES OF THE ORGANIZATION OF METHODOLOGICAL WORK IN PROFESSIONAL COLLEGES</b> Karimova Mukaddas Otajonovna, Nasirova Mavjudakhon Bakhodirovna, Tuychieva Ranokhon Nodirjon kizi	1095-1098	10.5958/2249-7137.2021.01173.3
187.	<b>THE MOTHERLAND IS HOLY AS A SACRED PLACE</b> Yusufjonov Kuyoshbek Komiljonugli, Mirzakarimov Davron Donyorjonugli, Tuxtaboyev Sardor Qahramonjonugli, Ruzaliyev Ozodbek Mashrabjonugli	1099-1102	10.5958/2249-7137.2021.01172.1
188.	<b>STRENGTHENING THE ROLE OF GERMAN IN EDUCATIONAL LANGUAGE SKILLS</b> Kakhorova Zabarjad	1103-1105	10.5958/2249-7137.2021.01171.X
189.	<b>EDUCATION REFORMS AND ITS EFFECTIVENESS</b> Z.A. Zulfikorova, Yu. R. Jurayeva	1106-1109	10.5958/2249-7137.2021.01170.8
190.	<b>TOWARDS CREATING A TECHNOLOGY-ENHANCED LANGUAGE CLASSROOM: SOME PEDAGOGIC CONSIDERATION FROM THE PERSPECTIVE OF BANGLADESH</b> Mizanur Rahman Jewel, Sheikh Alauddin	1110-1126	10.5958/2249-7137.2021.01229.5



191.	<b>THE IMPORTANCE OF USING LEGUMES TODAY</b> Mamadali Nazarov, Madina Gaybullaeva	1127-1131	10.5958/2249-7137.2021.01232.5
192.	<b>DEVELOPING SMALL BUSINESS AND ENTREPRENEURSHIP THROUGH THE TRANSITION TO THE DIGITAL ECONOMY</b> Obidjon Azizov	1132-1139	10.5958/2249-7137.2021.01233.7
193.	<b>PROGRESSIVE DEVELOPMENT OF ENIGMATIC TEXTS IN LINGUISTICS</b> Yakubova Nodirakhon Davlatbay kizi	1140-1143	10.5958/2249-7137.2021.01234.9
194.	<b>KOKTURK WRITING AND DIFFERENT IDEAS IN ITS STUDY</b> Dilorom Mirzaeva	1144-1148	10.5958/2249-7137.2021.01235.0
195.	<b>ORGANIZATION OF THE EDUCATION PROCESS BASED ON A CREDIT SYSTEM, ADVANTAGES AND PROSPECTS</b> Obidov J.G, Alixonov E.J	1149-1155	10.5958/2249-7137.2021.01236.2
196.	<b>ECOLOGIC AND ECONOMIC ASPECTS OF SOLVING THE WASTE PROBLEM</b> D. M. Akhmedova, T.Umarov	1156-1160	10.5958/2249-7137.2021.01237.4
197.	<b>THE IMPORTANCE OF “AL-FIQH AN-NOFE” IN SOLVING MODERN SOCIAL PROBLEMS</b> Bekzodbek Muxtarov	1161-1166	10.5958/2249-7137.2021.01238.6
198.	<b>MODERNIZATION OF INDUSTRIAL COMPRESSORS BASED ON MODERN AUTOMATION TOOLS</b> Abduraxmonov Sultanali Mukkaramovich, Sayitov Shavkatjon Samiddin ugli, Khasanov Ulugbek Shamilevich, Karabayev Fazdindin Sirojiddinovich	1167-1172	10.5958/2249-7137.2021.01239.8
199.	<b>THEORY AND PROBLEMS OF RUSSIAN LANGUAGE TRANSLATION IN THE FIELD OF TECHNOLOGY</b> Parpieva Makhsudakhon Makhmudjonovna	1173-1177	10.5958/2249-7137.2021.01240.4
200.	<b>METHODOLOGICAL RECOMMENDATIONS FOR THE ACTIVITIES OF THE CENTERS FOR EDUCATORS OF PRE-SCHOOL EDUCATIONAL ORGANIZATIONS</b> Abdukarimova Maftuna	1178-1185	10.5958/2249-7137.2021.01241.6
201.	<b>ENRICHMENT OF THE QUALITY OF EDUCATION AND ITS ESSENCE</b> N. T. Ishankulova	1186-1189	10.5958/2249-7137.2021.01169.1
202.	<b>THE ROLE OF UPBRINGING IN THE MATURITY OF THE PERSON AND ITS SPECIFIC FEATURES</b> Ravshanova Nasiba	1190-1193	10.5958/2249-7137.2021.01168.X
203.	<b>THE EFFECT OF SCIENTIFIC AND TECHNICAL MENTALITY AND INNOVATION ON THE FORMATION OF MODERN SPIRITUAL AND ETHICAL FACTORS IN YOUNG PEOPLE</b> Rajabboev Jurabek	1194-1198	10.5958/2249-7137.2021.01216.7
204.	<b>THE ADVANTAGES AND DISADVANTAGES OF MULTIMEDIA AND ITS USING IN TEACHING ESL</b> Xakimboyeva Ozoda, Safayeva Nigina	1199-1205	10.5958/2249-7137.2021.01186.1
205.	<b>THE DEPENDENCE OF THE RESISTANCE OF ESTRADIOL ON THE INFLUENCE OF THE MUTANT HENA OF THE ALLEL A WITH JUVENILE DYSMENORRHEA</b> Yakubova Oltinoy	1206-1211	10.5958/2249-7137.2021.01185.X

206.	<b>LANGUAGE AND CULTURE</b> G.Akramova, N.Mullaeva	1212-1215	10.5958/2249-7137.2021.01184.8
207.	<b>THE ENLIGHTENMENT ACTIVITY OF BEHBUDI</b> N.Urinbaev	1216-1219	10.5958/2249-7137.2021.01183.6
208.	<b>THE PROBLEM OF PROTECTION AND USE OF ARCHITECTURAL RESERVES OF HISTORICAL CITIES OF UZBEKISTAN</b> Kahhorov Azimjonc Xurramovich	1220-1223	10.5958/2249-7137.2021.01182.4
209.	<b>NEW GENERATION SPECIALISTS IN THE RENEWING UZBEKISTAN: COMPARATIVE ANALYSIS OF NATIONAL AND FOREIGN EXPERIENCE</b> Ganiev Oybek Nuriddinogli	1224-1231	10.5958/2249-7137.2021.01181.2
210.	<b>WOMEN AND INFORMATION COMMUNICATION TECHNOLOGY MICRO-LEVEL STUDY IN RURAL KERALA</b> R. Venkata Ravi, Aryanathu. V	1232-1240	10.5958/2249-7137.2021.01231.3
211.	<b>ISSUES OF FURTHER IMPROVEMENT OF WATER CADASTRE LEGISLATION OF UZBEKISTAN</b> Toshboeva Robiya Sobirovna	1241-1253	10.5958/2249-7137.2021.01258.1
212.	<b>THE ROLE OF CHESS IN THE DEVELOPMENT OF INTELLECTUAL ABILITIES OF SECONDARY SCHOOL STUDENTS (BASED ON COMPUTER TECHNOLOGY)</b> Toshev Murodjon Halilovich	1254-1258	10.5958/2249-7137.2021.01259.3
213.	<b>THE TECHNOLOGY OF INCREASING THE EFFECTIVENESS OF MATHEMATICS LESSONS IN INNOVATIVE EDUCATIONAL CONDITIONS</b> Muxamadaliyeva Madinabonu Bohodirjon qizi	1259-1262	10.5958/2249-7137.2021.01260.X
214.	<b>ON MODELING OF MECHANICAL VIBRATIONS OF ORTHOTROPIC BOARDS IN ELECTRONIC DEVICES</b> Abjalilov Sanakul Xujamovich, Ashurova Dilfuza Nabiyevna, Begmurodov Otabek Ahmadovich	1263-1270	10.5958/2249-7137.2021.01261.1
215.	<b>POSITIVE ASPECTS OF INTERACTIVE LEARNING METHODS</b> M. SH. Fayziev, S.S.Jumaev, Majidov Sh.A, Sadikova D.A	1271-1276	10.5958/2249-7137.2021.01262.3
216.	<b>IMPROVING SEED STORAGE METHODS</b> Mirzaeva Mutabar Azamovna, Xolmatov Sohijjon Normatjon ogli	1277-1280	10.5958/2249-7137.2021.01256.8
217.	<b>THE REFLECTION OF MIGRATION PROCESSES IN THE FUNERAL RITES OF THE POPULATION OF ANCIENT USTRUSHANA</b> Toshboev Furqat Eshboevich, Ropiev Allayor Saydullaevich, Jumaev Jorabek Boboqul ogli	1281-1286	10.5958/2249-7137.2021.01257.X
218.	<b>GENDER EQUALITY AND ITS IMPORTANCE IN UZBEKISTAN AND OTHER COUNTRIES OF THE WORLD</b> Khushbokova Nigora Ghayratqizi	1287-1290	10.5958/2249-7137.2021.01180.0
219.	<b>SCARS ON THE LUNGS: PULMONOLOGIST ON HOW TO PREVENT FIBROSIS AFTER COVID PNEUMONIA</b> Anvarzhon Dolimov, Dilfuzahon Mamarasulova, Nodirbek Yakubov	1291-1295	10.5958/2249-7137.2021.01179.4
220.	<b>THE ROLE AND IMPORTANCE OF ODR IN MODERN BUSINESS SOCIETY</b> Dr Nasiruddeen Muhammad, Mokhinur Bakhramova	1296-1304	10.5958/2249-7137.2021.01178.2

221.	<b>THE ROLE OF MULTIMEDIA IN EDUCATION</b> Xakimboyeva Ozoda, Xurramova Maftuna	1305-1312	10.5958/2249-7137.2021.01177.0
222.	<b>THE EFFECT OF COMBINED STRATEGY INSTRUCTION ON READING COMPREHENSION</b> Turdimatova Gulchiroy	1313-1317	10.5958/2249-7137.2021.01199.X
223.	<b>ADVANTAGES AND DISADVANTAGES OF INTERACTIVE PRONOUNCING METHODS WHILE TEACHING PRONUNCIATION</b> Nosirova Umida, Yuldosheva Vazira	1318-1324	10.5958/2249-7137.2021.01198.8
224.	<b>CONDITIONS FOR EFFECTIVE IMPLEMENTATION OF INNOVATIVE ACTIVITIES IN A PRESCHOOL EDUCATIONAL ORGANIZATION</b> Muminov Shermuhammad Karimovich	1325-1328	10.5958/2249-7137.2021.01197.6
225.	<b>PROFESSIONAL PERSONAL DEVELOPMENT IN THE EDUCATIONAL SPACE</b> Jumanazarova Zuxra Kosimjonovna	1329-1332	10.5958/2249-7137.2021.01196.4
226.	<b>INTEGRATED APPROACH TO ORGANIZATION OF INDEPENDENT WORK OF STUDENTS</b> Nurova Oliya Salomovna	1333-1335	10.5958/2249-7137.2021.01195.2
227.	<b>USE OF INNOVATIVE PEDAGOGICAL TECHNOLOGIES IN TEACHING ECONOMIC DISCIPLINES</b> Kanglibekov Kvatbai	1336-1339	10.5958/2249-7137.2021.01194.0
228.	<b>NATIONAL FEATURE-CRITERION OF LABOR ORGANIZATION</b> N.Urinbaev	1340-1343	10.5958/2249-7137.2021.01193.9
229.	<b>REGIONAL PRETRACHEAL LYMPHATIC THERAPY OF PULMONARY COMPLICATIONS COVID-19</b> Saidkhodjaeva Djurakhon, Djumabaev Ekin, Madazimov Madamin, Madazimov Komil	1344-1349	10.5958/2249-7137.2021.01192.7
230.	<b>“MODERATION EFFECT OF ORGANISATIONAL POLITICS WITH REFERENCE TO PRIVATE ENGINEERING COLLEGE FACULTY”</b> Dr Kota Neela Mani Kanta, Dr. P. Srivalli	1350-1358	10.5958/2249-7137.2021.01230.1
231.	<b>TRANSLATION HYPOTHESIS SPECIFICS AND PROBLEMS OF TRANSLATION OF SCIENTIFIC AND TECHNICAL MULTI COMPONENT TERMS</b> Nishonov Usmonkhon Ibragimovich	1359-1363	10.5958/2249-7137.2021.01242.8
232.	<b>INVESTIGATION OF BACKGROUND RADIATION AND THE POSSIBILITY OF ITS LIMITATION IN A SEMICONDUCTOR IONIZATION SYSTEM</b> Yuldashev H.T, Mirzaev S.Z	1364-1369	10.5958/2249-7137.2021.01243.X
233.	<b>APPLICATION AND RESEARCH OF ENERGY-SAVING LIGHTING DEVICES IN ENGINEERING NETWORKS</b> Obidov J.G, Ibrohimov J.M	1370-1375	10.5958/2249-7137.2021.01244.1
234.	<b>DESCRIPTION OF SOCIAL PROBLEMS IN “CANNERY ROW” BY JOHN STEINBECK</b> Ganieva Orzigul Khayriddinovna	1376-1379	10.5958/2249-7137.2021.01246.5
235.	<b>THE IMPORTANCE OF INTRODUCING INNOVATIVE EDUCATIONAL TECHNOLOGIES IN SOCIAL DEVELOPMENT OF SOCIETY</b> Diloram Kambarova	1380-1384	10.5958/2249-7137.2021.01245.3

236.	<b>INTERDISCIPLINARY BINARY LECTURE AS A METHOD OF TEACHING AT TECHNICAL UNIVERSITY</b> Avdeeva A. N, Filimonova L. Yu	1385-1389	10.5958/2249-7137.2021.01247.7
237.	<b>BIO ECOLOGICAL CHARACTERISTICS OF CLIMATIC LANDSCAPE PLANTS OF FERGANA CITY</b> D.M.Akhmedova, N.Turdieva	1390-1394	10.5958/2249-7137.2021.01248.9
238.	<b>TIPS AND TRICKS FOR LEARNING ENGLISH</b> Ataeva G.B, Kurbanova M.M	1395-1401	10.5958/2249-7137.2021.01249.0
239.	<b>THE MAIN TAXONOMIC FEATURES OF THE CAUSATIVE AGENTS OF URINARY TRACT INFECTIONS AND A DESCRIPTION OF THEIR VARIABILITY</b> Dilfuza Isanova, Yuriy Azizov	1402-1407	10.5958/2249-7137.2021.01191.5
240.	<b>ADVANTAGES AND DISADVANTAGES OF AUDIO-LINGUAL METHOD IN TEACHING</b> Shayusupova Kamola, Mamatova Feruza	1408-1415	10.5958/2249-7137.2021.01190.3
241.	<b>TEACHING VOCABULARY IN CONTEXT FOR A1 LEVEL LEARNERS</b> Xakimboyeva Ozoda, Djurayeva Dilnavoz, Turg'unova Dinara	1416-1422	10.5958/2249-7137.2021.01189.7
242.	<b>FOCUS ON PRESCHOOL EDUCATION - TODAY'S DEMAND</b> Parmanov Abdulla Esanturdievich, Mukhammadiev Kahramon Sodikovich, Esanturdieva Shahlo Abdullaevna	1423-1428	10.5958/2249-7137.2021.01188.5
243.	<b>PROBLEMS AND THE MAIN ERRORS IN TRANSLATION</b> Anypa Taekeeva, Dilnoza Jaksulikova, Utebaeva Bibizada	1429-1433	10.5958/2249-7137.2021.01187.3
244.	<b>TECHNOLOGY OF WATERMELON AND PAINTING IN FINE ART AND EXPRESSION OF COLORS</b> Yurdanidze Mehrali Kholisovich, Ismonov Khurshidbek Bakhtiyorovich	1434-1438	10.5958/2249-7137.2021.01213.1
245.	<b>YOUTH MENTALITY: SCIENTIFIC AND TECHNICAL KNOWLEDGE AND OBJECTIVE LAWS OF SPIRITUAL DEVELOPMENT</b> Rajabboev Jurabek	1439-1442	10.5958/2249-7137.2021.01214.3
246.	<b>INFLATION IN LAW MAKING: DEEP ANALYSIS OF UZBEK LEGISLATION</b> Akmal Sodikov, Islomjon Nabijonov	1443-1452	10.5958/2249-7137.2021.01167.8
247.	<b>THE GERMINATION OF SALSOLA ORIENTALIS S. G. GMEL SEEDS IN THE CONTEXT OF CULTURE</b> Baltabaev Muratbay Torebayevich, Karlibaeva Miyassar Abdinasir kizi	1453-1457	10.5958/2249-7137.2021.01151.4
248.	<b>IMPROVING THE METHODS OF DEVELOPING THINKING ABILITY OF PRIMARY SCHOOL STUDENTS IN MATHEMATICS</b> Shabnam Yusufzoda, Sitara Ortiqova	1458-1463	10.5958/2249-7137.2021.01142.3
249.	<b>ABDUNAZAR POYONOV VERSION EPIC OF THE ALPOMISH</b> Jumagulova Dilafroz Xushmurotqizi	1464-1468	10.5958/2249-7137.2021.01162.9
250.	<b>ANALYSIS OF THE DROPOUT TREND IN GOVERNMENT GIRLS PRIMARY SCHOOLS IN DISTRICT MARDAN (PAKISTAN)</b> Dr. Syed Wajid Ali Shah, Syed Muhammad Amir, Dr.Raisat Ali, Dr. Sajjad Hayat Akhtar	1469-1476	10.5958/2249-7137.2021.01263.5

251.	<b>ABOUT THE FEATURES OF ECONOMIC RELATIONS BETWEEN BUKHARA KHANATE AND INDIA</b> A. A. Erkuziev, R.Mahkamov	1477-1480	10.5958/2249-7137.2021.01250.7
252.	<b>RELATIONSHIP BETWEEN THE EXPRESSION OF PAIN SYNDROME AND THE SIZE OF THE INTER VERTEBRAL HERNIA OF THE LUMBAR SPINE</b> Fayzulin Ruslan Vadimovich, Pavlanova Matlyuba Satvaldiyevna, Ismailov Bakhromiddin Zakhridinovich	1481-1488	10.5958/2249-7137.2021.01252.0
253.	<b>THE USAGE OF ICT IN THE CLASSROOMS OF PRIMARY SCHOOL</b> N.U.Abraimova	1489-1492	10.5958/2249-7137.2021.01253.2
254.	<b>THE ROLE OF THE SOCIAL ENVIRONMENT IN THE FORMATION OF PERSONALITY</b> Rakhimbayeva Dilbarkhon	1493-1497	10.5958/2249-7137.2021.01254.4
255.	<b>THE ROLE OF SMALL BUSINESS IN THE DEVELOPMENT OF THE SERVICE SECTOR</b> Mahmudova Nozimakhon Baxriddinxonovna	1498-1501	10.5958/2249-7137.2021.01255.6
256.	<b>SOCIAL FACTORS OF ENTREPRENEURSHIP SUPPORT IN UZBEKISTAN</b> Qozoqov Sobirjon Zokirovich	1502-1507	10.5958/2249-7137.2021.01251.9
257.	<b>THE WORLD IMPORTANCE OF THE TEACHINGS OF KHOJA AHROR VALI</b> Rakhmatova Kholida Kholikovna	1508-1512	10.5958/2249-7137.2021.01264.7
258.	<b>ABOUT THE OBJECTS OF CULTURAL HERITAGE AND THE STATE OF THEIR PRESERVATION IN THE 20-30 YEARS OF THE XX CENTURY (EXAMPLE OF FERGANA VALLEY)</b> Mansur Mahmudov	1513-1518	10.5958/2249-7137.2021.01265.9
259.	<b>TAX POLICY IN THE YEARS OF INDEPENDENCE IN UZBEKISTAN</b> Omonov Izatillo	1519-1522	10.5958/2249-7137.2021.01266.0
260.	<b>ANALYSIS OF PATHOMORPHOLOGICAL CHANGES IN THE LUNG TISSUE IN PULMONARY EMBOLISM IN MALIGNANT TUMORS</b> Abadjan Avezov, Daniyar Nishanov, Ulugbek Ruzmetov, Nizom Ermatov	1523-1529	10.5958/2249-7137.2021.01272.6
261.	<b>CREATING A BIOPHYSICAL TRAPPING DEVICE BASED ON AN OPTICAL RADIATION SOURCE WITH A LIGHT-EMITTING DIODE</b> Abdurashid Khamidillaevich Yusupov	1530-1536	10.5958/2249-7137.2021.01273.8
262.	<b>PROFESSIONAL COMPETENCE OF FUTURE ENGINEERS IN HIGHER EDUCATION INSTITUTIONS SOME ASPECTS</b> Avazov J.D	1537-1544	10.5958/2249-7137.2021.01274.X
263.	<b>FIVE INITIATIVES IN EXTRACURRICULAR EDUCATION</b> Dildora Turgunovna Pulatova, Nargiza Kabulova	1545-1549	10.5958/2249-7137.2021.01275.1
264.	<b>FROM THE HISTORY OF STUDYING ALISHER NAVAI'S LYRIC POETRY</b> Dilnoza Ahmad qizi Rustamova	1550-1553	10.5958/2249-7137.2021.01276.3
265.	<b>EDUCATION OF YOUTH IN UZBEKISTAN, RAISING THEIR MORALE</b> Fakhridin Joylovich Yormatov	1554-1559	10.5958/2249-7137.2021.01277.5

266.	ASSESSMENT OF THE BALANCE OF INTRA-CARDIAC HEMODYNAMICS AND GLOMERULAR FILTRATION IN ANEMIA WITH DIFFERENT HEMODYNAMIC TYPES OF CHRONIC HEART FAILURE Feruz Abdjalolovna Xalilova, Mironshox Dilshodovich Kodirov	1560-1573	10.5958/2249-7137.2021.01278.7
267.	PSYCHOLOGICAL SERVICE AND MODELS OF PSYCHOLOGICAL ASSISTANCE FAMILY AS A NECESSARY FACTOR OF FAMILY STRENGTHENING Feruz Akmalovna Akramova	1574-1579	10.5958/2249-7137.2021.01279.9
268.	METHODS OF DEVELOPING "CREATIVE THINKING" SKILLS IN TEACHING PHYSICS Ganiev A.G	1580-1587	10.5958/2249-7137.2021.01280.5
269.	INTENSIVE IN TEACHING ENGLISH CHARACTERISTICS OF APPLICATION OF METHODS Ibragimov X.I, Salimova Z.K	1588-1594	10.5958/2249-7137.2021.01281.7
270.	ROLE OF SMALL SCALE INDUSTRIES IN ECONOMIC DEVELOPMENT Syed Waliullah Quadri	1595-1599	10.5958/2249-7137.2021.01285.4
271.	STRUGGLE AGAINST ISLAM RELIGION IN THE 20-40-s OF THE XX CENTURY AND ITS MAIN TRENDS Shavkatjon Tulanboev	1600-1604	10.5958/2249-7137.2021.01267.2
272.	AESTHETIC FUNCTIONS OF FLAME POETIC IMAGE IN UZBEK FOLK SONGS Karimova Feruz Muminovna	1605-1612	10.5958/2249-7137.2021.01268.4
273.	WORD EARTH TUSHUNCHASI CONCEPT AND ITS ESSENCE Oripov Khasan Abdivakhobovich	1613-1616	10.5958/2249-7137.2021.01269.6
274.	FUNCTIONAL SEMANTIC FEATURES OF EUPHEMISMS IN GERMAN AND UZBEK LANGUAGES Kholiyarov Lutfulla Tashkuvatovich, Rustamov Abdushukur Alibaevich, Mamaziyaev Zokhid Kholboevich	1617-1621	10.5958/2249-7137.2021.01270.2
275.	INNOVATIVE APPROACH TO ENSURING THE CONTINUITY OF TEACHING COMPUTER SCIENCE IN THE SYSTEM OF CONTINUOUS EDUCATION OF THE NEW UZBEKISTAN Rasulov Inom Muydinovich	1622-1629	10.5958/2249-7137.2021.01271.4
276.	FROM THE HISTORY OF COURTS IN BUKHARA Alimova Mokhichehra Muzaffarovna, Mirzaqulov Beshim Tangrievich	1630-1631	10.5958/2249-7137.2021.01286.6
277.	THE EFFECT OF TEACHING VOCABULARY THROUGH ICT ON EFL LEARNERS Munavvar Bahodirovna Fayzullayeva, Ismigul Baxtiyorovna Sattarova, Manzura Adashevna Makhmudova	1632-1637	10.5958/2249-7137.2021.01287.8
278.	A NEW APPROACH TO VOCAL-CHORAL SKILLS Botirova Xilola Tursunbaevna	1638-1654	10.5958/2249-7137.2021.01288.X
279.	CULTIVATION OF RADISH AND TURNIPS Kamilov Murodjon Mukumjonovich	1655-1657	10.5958/2249-7137.2021.01289.1
280.	LINGUO-STYLISTIC PECULIARITIES OF FOOTBALL DISCOURSE IN MODERN SPORT PUBLIC ISM Egamov Sohob Amonovich	1658-1663	10.5958/2249-7137.2021.01290.8

281.	<b>PROPERTIES OF THE DEMONSTRATION OF THE ECOLOGICAL OUTLOOK OF A PERSON IN A PERIOD WHEN GLOBAL ENVIRONMENTAL PROBLEMS ARE ESCALATING</b> Kandov Bakhodir Mirzaevich	1664-1673	10.5958/2249-7137.2021.01291.X
282.	<b>WHAT IS MOTIVATION AND ITS PECULIARITIES IN LEARNING A FOREIGN LANGUAGE</b> Rahimova Charos Odiljonovna	1674-1678	10.5958/2249-7137.2021.01292.1
283.	<b>PATHOMORPHOLOGICAL CHANGES IN POULTRY PODODERMATITIS IN COWS</b> Batiyor Zokirovich Mukhtorov, Nasriddin Bobokulovich Dilmurodov	1679-1684	10.5958/2249-7137.2021.01293.3
284.	<b>SOURCES OF TSARIST RUSSIA'S RESETTLEMENT POLICY IN TURKESTAN</b> Sultonova Maxfuza Ibroximovna	1685-1690	10.5958/2249-7137.2021.01294.5
285.	<b>SCIENTIFIC AND METHODOLOGICAL BASES OF INTEGRATIVE IMPROVEMENT OF THE COURSE "POLYMER CHEMISTRY" UNDERGRADUATE EDUCATION "CHEMISTRY"</b> Kurbonova Gulchekhra Rayimovna, Nishonov Mirkoziymjon Fozilovich	1691-1694	10.5958/2249-7137.2021.01295.7
286.	<b>THEORETICAL FOUNDATIONS OF DIGITAL ECONOMY</b> Turaev Khurshid Bakhriddinugli	1695-1699	10.5958/2249-7137.2021.01296.9
287.	<b>ECONOMIC AND SOCIAL IMPORTANCE OF CREATING COMPETITIVE INDUSTRIAL CHAINS AND INCREASING INVESTMENT PROJECTS IN STRENGTHENING ECONOMIC GROWTH</b> Yadgarov Akram Akbarovich, Yuldashev Golibjon Turgunovich, Mahmudov Mirabbos Fazliddinovich, Najimadinov Ravshanbek Dushamboevich	1700-1707	10.5958/2249-7137.2021.01297.0
288.	<b>THE ADVANTAGES OF USING MODULAR TECHNOLOGIES AT PRIMARY EDUCATION</b> Abdurasulova Shoira Kushakovna, Mamarahimov Shuhrat Uralovich, Mansurova Dilfuza Bakirovna	1708-1712	10.5958/2249-7137.2021.01298.2
289.	<b>LINGUISTIC ANALYSIS OF COMPUTER TERMINOLOGY</b> Zulfikorova Zuhra Allaberdievna	1713-1717	10.5958/2249-7137.2021.01299.4
290.	<b>A STUDY ON LIQUIDITY ASSESSMENT OF AUTO ANCILLARIES OTHERS IN AUTOMOBILE INDUSTRY</b> Dr. R. Vidya	1718-1726	10.5958/2249-7137.2021.01284.2
291.	<b>TRANSPORT AND ROAD CONSTRUCTION ISSUES IN BUKHARA</b> J. J. Majidov	1727-1732	10.5958/2249-7137.2021.01300.8
292.	<b>HOW TO USE OF VIDEO FILMS IN THE CLASSROOM</b> Yulduz Sayitmurodovna Sattorova	1733-1736	10.5958/2249-7137.2021.01301.X
293.	<b>DERIVATIVES MARKET: WORLD TRENDS AND DEVELOPMENT PROSPECTS</b> Orifjonova Mukhlisa Alisher kizi	1737-1742	10.5958/2249-7137.2021.01302.1
294.	<b>THE EFFECTIVE WAYS OF DEVELOPING CRITICAL THINKING AND ITS ROLE IN TEACHING PROCESS</b> Rabbimova Yulduz Karshiboy kizi, Petrosyan Nelya Valerovna	1743-1747	10.5958/2249-7137.2021.01303.3
295.	<b>GEOGRAPHICAL ROOTS AND BASIC CONCEPTS OF ETHNOECOLOGY</b> Komilova Nargizahon Urinovna	1748-1750	10.5958/2249-7137.2021.01304.5

296.	<b>RESULTS OF INDUSTRIAL TESTING OF OIL EMULSION DRILLING MUD IN THE USTYURT URBAN AREA</b> N.N. Yodgorov, A.A. Abdinazarov	1751-1754	10.5958/2249-7137.2021.01305.7
297.	<b>SPECIAL METHODS FOR STUDYING THE CHEMICAL COMPOSITION OF ENGINE OILS</b> Imomova M.Yo, Abduganiev B.Yo, Turdiboev A. Kh	1755-1760	10.5958/2249-7137.2021.01282.9
298.	<b>DATA ON JALALIDDIN RUMI'S LIFE IN THE WORK "SHARHI MASNAVIYI MAWLAVI" BY AYYUB</b> Iroda Amanullayevna Umarova	1761-1769	10.5958/2249-7137.2021.01283.0
299.	<b>THE TAX SYSTEM AS A STRUCTURAL LINK OF THE FINANCIAL SYSTEM</b> Javlonbek Butaev, Umurzoq Radjabov	1770-1780	10.5958/2249-7137.2021.01307.0
300.	<b>USE OF MULTIMEDIA TECHNOLOGIES IN THE EDUCATIONAL PROCESS</b> Lobar Abdimannobovna Muxtarova	1781-1785	10.5958/2249-7137.2021.01308.2
301.	<b>INSURANCE AGENTS AND SIGNIFICANT ASPECTS OF IMPROVING THEIR ACTIVITY</b> Matiyazova S.R	1786-1792	10.5958/2249-7137.2021.01309.4
302.	<b>THE BREATH OF THE PERIOD IN THE EPISODES OF THE NOVEL</b> Mekhrison Yadgarova	1793-1802	10.5958/2249-7137.2021.01310.0
303.	<b>SYSTEM AND INTEGRATED APPROACH TO ECONOMETRIC TRAINING</b> Muhaya Makhmanazarovna Ravshanova	1803-1806	10.5958/2249-7137.2021.01311.2
304.	<b>STATUSES OF SPIRITUAL PERFECTION</b> Murodkhoja Mukhtorov	1807-1813	10.5958/2249-7137.2021.01312.4
305.	<b>SYMBOLIC INTERPRETATION OF COLORS</b> Nasiba Saburovna Jumatova	1814-1818	10.5958/2249-7137.2021.01313.6
306.	<b>COMPARATIVE ANALYSIS OF THE PROPERTIES OF SIRO YARN SPINNED BY NATURAL AND CHEMICAL FIBERS</b> Nuriddin Nuraliogli Roziboyev, Vohid Tolaganovich Isakulov	1819-1826	10.5958/2249-7137.2021.01314.8
307.	<b>TYPES OF DIPLOMATIC TERMS IN THE UZBEK LANGUAGE ACCORDING TO THEIR SEMANTIC RELATIONS</b> Sanjar Mavlyanov	1827-1835	10.5958/2249-7137.2021.01315.X
308.	<b>MANUSCRIPTS OF AZIMKHOJA ESHAN AND HIS DEWANS</b> Sarvinoz Yokubjonkizi Azizkhonova	1836-1841	10.5958/2249-7137.2021.01316.1
309.	<b>THE ROLE OF MUSIC EDUCATION IN THE DEVELOPMENT OF PERSONAL QUALITIES OF CREATIVE PERSONS</b> Sevar Samatovna Malikova	1842-1846	10.5958/2249-7137.2021.01317.3
310.	<b>ORGANIZATIONAL COMMITMENT AS MEDIATOR OF THE RELATIONSHIP BETWEEN JOB SATISFACTION AND PERFORMANCE IN THE COMMERCIAL BANKS IN SRI LANKA- A STUDY</b> Sampath Kappagoda	1847-1858	10.5958/2249-7137.2021.01334.3



311.	THE MECHANISM FOR INCREASING THE SOCIAL ENGAGEMENT OF STUDENTS IN THE PROCESS OF TEACHING ENGLISH (ON THE EXAMPLE OF THE PROCESS OF PREPARING FUTURE ECONOMISTS) Pulatova Ziyoda Abdumalikovna	1859-1861	10.5958/2249-7137.2021.01306.9
312.	SEARCH FOR REGULARITIES BY INTERVALS OF VALUES OF QUANTITATIVE FEATURES Shavkat Fayzullaevich Madrakhimov, Alisher Khasanovich Khurramov	1862-1871	10.5958/2249-7137.2021.01318.5
313.	STARTUPS: THE ESSENCE AND FEATURES OF FORMATION ON THE EXAMPLE OF FOREIGN EXPERIENCE Shirin Shavkatkizi Achilova	1872-1880	10.5958/2249-7137.2021.01319.7
314.	GENDER CHARACTERISTICS OF UZBEK KIPCHAK DIALECTS Shoira Khushbokovna Islomova	1881-1885	10.5958/2249-7137.2021.01320.3
315.	COTTON OIL REFINING METHOD Sunnatullo Shamsulloyevich Ismatov	1886-1892	10.5958/2249-7137.2021.01321.5
316.	STUDY OF THE MATERIAL AND CULTURAL LIFE OF THE KARAKALPAK PEOPLE IN THE XIX-XX CENTURIES Timur Rustemovich Jabbarbergenov, Ajiniyaz Quralbaevich Paxratdinov	1893-1897	10.5958/2249-7137.2021.01322.7
317.	SELECTION OF TOOLS FOR MACHINING PARTS MADE OF POLYMER COMPOSITE MATERIALS Umida Shaozimova, Xabibjon Xamraev	1898-1903	10.5958/2249-7137.2021.01323.9
318.	THE MORPHOLEXICON OF THE UZBEK LANGUAGE AS A SOURCE FOR THE CORPUS Ural Menglievich Kholiyrov	1904-1910	10.5958/2249-7137.2021.01324.0
319.	SPECIFIC ASPECTS OF THE FORMATION OF PRACTICAL KNOWLEDGE IN THE TEACHING OF THE COURSE OF TECHNICAL MECHANICS Yulduz Akhmatovna Suyunova	1911-1916	10.5958/2249-7137.2021.01325.2
320.	PEDAGOGICAL FACTORS OF THE DEVELOPMENT OF SPEECH IN CHILDREN WITH HEARING IMPAIRMENT IN THE PROCESS OF LITERARY EDUCATION Zulfiya Narbaevna Mamarajabova	1917-1922	10.5958/2249-7137.2021.01326.4
321.	TRADITIONS AND HISTORICAL ANALYSIS OF THE FOOD INDUSTRIES OF THE SURKHANDARYA OASIS Gayrat Abdulkhakimovich Mamarajabov	1923-1927	10.5958/2249-7137.2021.01327.6
322.	NAMES OF THE INHABITED LOCALITIES OF THE TAKHTAKUPYR DISTRICT Akmaral Sakhratdinovna Serikbaeva	1928-1933	10.5958/2249-7137.2021.01328.8
323.	THE EFFECT OF APPLYING THE ADVANTAGES OF THE INFOGRAPHIC FORMAT IN THE PROCESS OF MEDIA LITERACY EDUCATION Hilola Ibragimova	1934-1941	10.5958/2249-7137.2021.01329.X
324.	EFFECT OF TUMAT BIOSTIMULATOR ON AUTUMN GRAIN WHEAT YIELD AND ITS QUALITY Muqumjon Yaqubjonovich Djurayev, Ilyosbek Inomovich Usmonov, Dilpuza Ergashboyevna Xoldarova	1942-1945	10.5958/2249-7137.2021.01330.6

325.	<b>BIO ECOLOGICAL PROPERTIES AND SIGNIFICANCE OF CALIFORNIA RED WORM</b> Shohista Qobiljonovna Yuldasheva, Bekzodjon Ergashaliogli Soyibnazarov	1946-1950	10.5958/2249-7137.2021.01331.8
326.	<b>TO THE QUESTION OF EVALUATION OF QUALITY INDICATORS OF FUR PLATES FROM WASTE</b> Ergasheva N, Akhmedov B.B, Nigmatova F.U, Shomansurova M.Sh, Galeeva A.R	1951-1957	10.5958/2249-7137.2021.01332.X
327.	<b>QUANTITY IN PHYSICS ON THE LAWS OF ELECTROLYSIS PROBLEM SOLUTION TECHNOLOGY</b> Yusup Ganievich Makhmudov	1958-1962	10.5958/2249-7137.2021.01333.1
328.	<b>READER-SPECIFIC ASPECTS OF THE FORMATION OF ECOLOGICAL CULTURE IN YOUNG PEOPLE</b> Umida Abdurahobovna Bovanova	1963-1970	10.5958/2249-7137.2021.01336.7
329.	<b>TYOLOGICAL FEATURES OF STUDENTS' LEARNING ABILITY IN THE STUDY OF MATHEMATICS IN HIGHER EDUCATION</b> Otabek Samandarovich Matchonov	1971-1974	10.5958/2249-7137.2021.01338.0

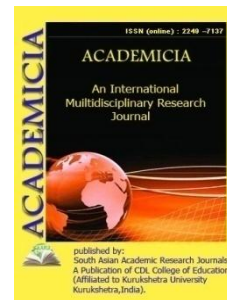
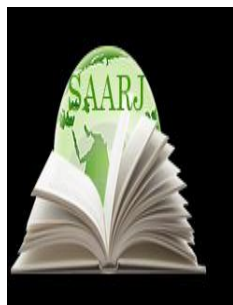

DOI: **10.5958/2249-7137.2021.01027.2**

## **E-LEARNING IN INDIA: SOME DYNAMIC INITIATIVES IN HIGHER EDUCATION**

**Dr Sandeep Kaur\*; Pooja Gothwal\*\***

\* Head Department,  
Public Administration,  
SGGS College, Chandigarh, INDIA

\*\*Research Scholar,  
Dept. Public Administration,  
Panjab University, Chandigarh, INDIA

### **ABSTRACT**

*The Indian higher education system is the world's third-largest in terms of students, next to China and the United States. E-learning has brought drastic change in the educational sector especially in higher education. Integration of Information and Communication technology along with e-learning initiatives has enhanced the teaching-learning process in higher education and also helped the government to improve the higher education structure in the country. Higher education institutions are implementing various E-learning initiatives as key component to facilitate the knowledge acquisition and to withstand the fast growing competition and digital technology. The basic objective of this paper is to understand the concept of e-learning and examine e-learning initiatives in higher education institutions while making passing reference to Covid-19 effects.*

**KEYWORDS:** *E-Learning, Implementing*

### **INTRODUCTION**

Recent technological and other advancements have turned the World into a Global Village where awareness and knowledge has become the key components. In such scenario, education has become a powerful tool of the society to raise awareness of the culture, environment, social diversity and also to increase the levels of knowledge to face the competitiveness among the people besides helping them to become Global Citizens. Recently, E-learning has emerged as strong and effective means to promote education worldwide. E-learning is super spreader of

education and knowledge in the world and India is no exception. With the help of E-learning tools and technology, India can attain the goal of reaching the remote citizens of in rural areas, motivating the learners for higher education as well as empowered women through the education.<sup>1</sup>

The emergence of internet in terms of its speed and availability has broadened up the usage of e-learning in Indian higher education Institutions. E-learning is becoming a part of the internet which experiences the highest growth rate and improves the teaching and learning process. E-learning environment has been widely implemented in many schools, colleges and universities. It is not only being used for education purposes alone, but for training purposes in many corporate and government departments. However, with the on-going demand for the e-learning technology, there is one major question asked by most professionals and scholars are on the effectiveness and success of various e-learning initiatives. Therefore, it is relevant that e-learning readiness will be conducted prior to the introduction of the e-learning tools and technology in organization and institutions. It is important to apply the e-learning readiness assessment.

Integration of Information and Communication Technologies (ICTs) has completely changed the dynamics of education sector; and has undeniable impact on learning outcomes. E-learning has emerged as a vital tool to improve the teaching- learning outcome as well as expand the learning opportunities for learners. E-Learning initiatives are a procedure of using digital technology to assist learning and teaching. Enhancement in how the Internet works, has allowed websites to deliver an effective and immersive learning experience on a computer, laptop or mobile device, which is helpful for encouraging learning.<sup>2</sup>

### **Emergence of E-Learning in Covid Times**

Covid-19, a deadly pandemic struck the world in late 2019. With the outbreak of the virus operating conditions all over the world have changed rapidly and the effects of the pandemic are visible, unstoppable and uncontrollable. Many sectors of importance have been badly affected leaving the economies and systems in shatters and education sector like many other important sectors got the severe whip. Face to face learning became a thing of the past as billions of students are forced to learn while sitting home through e-learning to avoid spread of the infection. E-learning has emerged as only viable alternative in the present times to impart education to keep moving the ball of societal obligations.

Thus, technologies and the circumstances have changed the traditional way of teaching-learning rather has replaced it with technology. To-day, all the higher education institutions and universities and even the schools are imparting online education.

### **Definition of e-learning**

There are many definitions given to e-learning (which stands for electronic learning) to enhance and support learning in higher education. E-learning is the integration of digital technology and learning, and with the use of network tools and technologies to facilitate learning anytime, anywhere. Thus, E-learning is covered under a larger term of technology-based learning through websites, learning portals, video conferencing, YouTube, mobile apps, and thousand types of free available websites for blended learning tools. Currently, E-Learning is enhancing student's knowledge, even the academic staff and professional and industry people skills through the internet.<sup>3</sup>

However, in present time, e-learning has become an important tool for enhancing the delivery, interaction, and facilitation of both teaching and learning process. The Commission on Technology and Adult Learning (2001) defined “e-learning as instructional content or learning experiences delivered or enabled by electronic technology.” With the increasing number of students in higher education institutions every year, it has become necessary to introduce e-learning initiatives and some alternative method of imparting education to all the students. Online programmes and courses through various e-learning platforms are a solution to this. However for e-learning implementation to succeed there is a need to assess the readiness of stakeholders (organizations, teachers and learners) to adopt this learning style. E-learning offers the multiple advantages of economy besides the enhancement in teaching learning outcomes. The desire for a well-educated technical workforce has driven many nations to redesign their education systems. Desire for a technical workforce is mentioned in Alvin Toffler’s declaration (in Rosenberg, 2001), that “the illiterate of the 21st century will not be those, who cannot read and write but those who cannot learn, unlearn, and relearn.” This signifies that learning institutions/universities will have to progressively change and adapt in their environments if they are not to lag behind.

### Higher Education Architecture in India

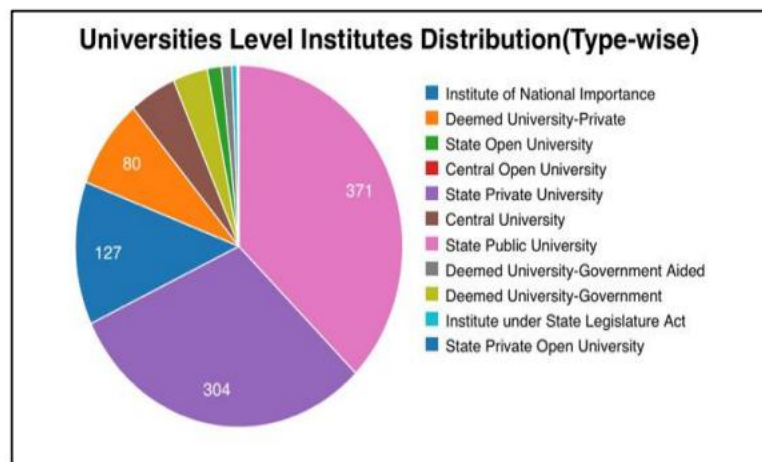

SOURCE: International Journal of Scientific and Research Publication

The Indian higher education system is the world's third-largest in terms of students, next to China and the United States. According to All India Survey of Higher Education report (2019) the Indian higher education comprises of 53,620 institutions with 37 million students. There are a total of 41,901 colleges, 10, 726 standalone institutions and 993 universities, out of which 385 Universities are private and 394 Universities, are located in rural areas. In which there are 548 General, 142 Technical, 63 Agriculture & Allied, 9 Language, 23 Law, 58 Medical, 13 Sanskrit, 13 Sanskrit, and 58 Medical Universities and rest 106 Universities belong to other subjects. A total of 26 million students study in colleges followed by 7 million students studying in universities and 2 million students studying in the standalone institutions. According to this report, Gross Enrolment Ratio GER) in higher education is 26.3. GER for the male and female population is 26.3% and 26.4% respectively

### Regulatory Framework Of Higher Education In India



### IMPORTANCE OF E-LEARNING IN HIGHER EDUCATION

The Four Rationales for Introducing E-Learning in Education (Source: Cross and Adam, 2007)	
Social	Perceived role that technology now plays in society and the need for familiarizing students with technology.
Vocational	Preparing students for jobs that require skills in technology.
Catalytic	Utility of technology to improve performance and effectiveness in teaching, management and many other social activities.
Pedagogical	To utilize technology in enhancing learning, flexibility and efficiency in curriculum delivery.

SOURCE: Cross and Adams, 2007

In higher education Institutions, the demand to create a virtual learning environment (VLE) is increasing day by day, in which all aspects of a course are handled through a consistent user interface throughout the institution. Many online courses and programmes are already initiated in our country, which are delivered online to students. In present time, several Higher Education Institution and university provide. Of a total of around 1.2 million students worldwide, 32% are from the U.S while 15% are from India. In India, especially in rural areas many colleges and universities are facing the problem of non-availability of qualified teachers, but with the help of E-learning tools and technology, they can overcome the problem of non-availability of adequately qualified teachers in their institutions. While there is no substitute for effective and organized classroom teaching, e-learning's is the best option. School dropouts and physically disabled student can be taught through e-learning study materials. Computerized Assessment of students' performance becomes easier to the teacher/professor, for the courses where the number of students is very high. However e-learning has its own limitations. People, who are oppose to the online learning and teaching saying that it is irrelevant and does not impart the education

effectively. On the other hand, some people oppose traditional school learning saying that self-learning with the help mobiles, computers and laptop etc., is always better than classroom learning as it does not encourage learners for self-learning.

Stakeholders	Benefits
<b>Students</b>	<ul style="list-style-type: none"> <li>✓ Enlarge access to education,</li> <li>✓ Global knowledge sharing</li> <li>✓ Feasibility of content delivery,</li> <li>✓ Combination of ICT and multimedia</li> <li>✓ Blending of work and education,</li> <li>✓ Learner –centric approach</li> <li>✓ Improvise-quality of education.</li> </ul>
<b>Employer's</b>	<ul style="list-style-type: none"> <li>✓ Increase training quality,</li> <li>✓ Cost effective strategy ,</li> <li>✓ Elevation of employee skills</li> <li>✓ Enlarged employee efficiency</li> <li>✓ Developing of a new learning culture,</li> <li>✓ Sharing of costs and of training time with the employees,</li> <li>✓ Increased portability of training.</li> </ul>
<b>Governments</b>	<ul style="list-style-type: none"> <li>✓ Increase the capacity and cost effectiveness of education and training systems,</li> <li>✓ To reach target groups with limited access to conventional education and training,</li> <li>✓ To support and enhance the quality and relevance of existing educational structures,</li> <li>✓ To ensure the connection of educational institutions and curricula to the emerging networks and information resources,</li> <li>✓ To promote innovation and opportunities for lifelong learning.</li> </ul>

The technological improvisation and globalization are the factors that enhance the growth of e-learning. Education plays a key role in enhancing the social and economic development of the nations all over the world. Higher education sector implements E-learning as vital component to facilitate the knowledge acquisition and to withstand the fast growing competition and technology. Along with ICT, development of multimedia has brought changes in the traditional way of teaching. E-Learning has a significant role in transforming knowledge, skill and performance improvement of the higher education. The implementation of e-learning tools have brought several drastic changes in the delivery of knowledge in higher education. Integration of Information and Communication technology along with e-learning has enriched the learning process in higher education. The role of e-learning has become imperative component of the higher education institution and universities. Education through e-learning enables access to the best tutors and the knowledge accessible worldwide (UNESCO, 2002).

**RECENT E-LEARNING INITIATIVES IN INDIA**

The learner with the use of digital tools and technology can access tremendous level of information

And it also provides world class resources of information from which the learners can benefit at their own phase of learning.<sup>4</sup> Followings are some e-learning initiatives:-

**EDUSAT:-**

This is a Geo-synchronous satellite developed on I-2K bus GSAT-3, also known as *EDUSAT is a dedicated communication satellite, launched by the Indian Space Research Organisation but exclusively serve in education sector. It was first “Educational Satellite”, meant for distant class room education from school level to higher education and also provides the country with satellite based two way communications to class room for delivering educational materials.*

**Net varsity:-**

Net varsity is the India’s first online educational enterprise also came with the private initiative. It is started by the National Institute of Information Technology (NIIT Limited) in 1996.

**NTFITSD:-**

The National Task Force on Information Technology and Software Development (NTFITSD) formed by the then Prime Minister of India in 1998, with the purpose to investigate the IT-potential of the nation. “The Task Force report presents the master plan that India has in place as a long term policy for capacity building of institutions, human resource development in IT related areas, and use of Information and Communication Technology in education sector.”<sup>5</sup>

**VCI:-**

The Indira Gandhi National Open University (IGNOU) on the recommendations of the Task Force started Virtual Campus Initiatives (VCI) in 1999. IT started in Bachelor of Information Technology and Advanced Diploma in Information Technology course.

**PDF:-**

In 2001, the School of Social Sciences at the Indira Gandhi National Open University (IGNOU) started a Post Graduate Certificate in Participatory Management of Displacement, Resettlement and Rehabilitation in 2001, with the help of the World Bank. It is a fully online programme that included both synchronous and asynchronous learning opportunities. It is a first programme, in which Participation in Discussion Forum (PDF) is used as a peer evaluation mechanism.

**OCPFS:-**

Online certificate programmes on Food Safety (OCPFS). OCPFS is an online initiatives of IGNOU, in collaboration with the Ministry of Health and Family Welfare, Government of India. It is Web-based Training Programme for the min career diplomat of the Government of India and also a web-enhanced training package on the Windows version of the UNESCOs popular database management package CDS/ISIS.

**NPTEL:-**



NPTEL (National Programme on Technology Enhanced Learning) was designed in 1999. NPTEL is funded by MHRD (Ministry of Human Resource and Development). Under the project, 7 Indian Institutes of Technology (IIT Bombay, Delhi, Guwahati, Kanpur, Kharagpur, Madras and Roorkee) and IISc (Indian Institute of Science) Bangalore have created 112 video courses and 116 web courses. All these courses are based on undergraduate engineering and science topics, and created to meet most of the requirements of an engineering undergraduate program (at any Indian university). These all programmes and courses are available to students, working professionals and colleges (both government and private) at virtually no cost or very low cost.

#### Some of the digital initiatives of UGC & MHRD for higher education are given below

- **e-gyankosh** (<http://egyankosh.ac.in/>) is a national digital Repository that preserves all the learning sources. All the digital study materials in e-gyankosh are protected by copyright, with all rights reserved by Indira Gandhi National Open University (IGNOU). It is the world's biggest repository of educational resources in higher education.
- **Gyandhara** (<http://ignouonline.ac.in/Gyandhara/>) is an internet audio counselling service offered by IGNOU, where learners can listen live discussions by teachers and experts on the topic of the day. Students can ask questions and interact with them through telephone, e-mail and also through chat mode.
- **SWAYAM** (Study Webs of Active-Learning for Young Aspiring Minds) is a programme initiated by the Government of India aimed at offering everyone, easy access to high-quality digital aids and resources. It provides Massive Open Online courses (MOOCs) with 140 universities approve credit transfer feature. Courses based on specific subjects, managed by SWAYAM are available free of cost to all the learners.
- **PG Pathshala** (<https://epgp.inflibnet.ac.in/>) is for postgraduate students. Postgraduate students can easily access this platform to get study materials, online courses and e-books..
- **Shodhganga** (<https://shodhganga.inflibnet.ac.in/>) is a platform for research students to deposit their PHD theses and make it available to the entire scholarly community in open access. It has the ability to capture, index, store, disseminate and preserve electronically thesis and dissertations submitted by the research scholar of any university in India.
- **VIDWAN** (<https://vidwan.inflibnet.ac.in/>) is a premier database and national research network which has profiles of scientists/researchers and other faculty members working at leading academic institutions and other Research & Developments organisation in India.
- **National Educational Alliance for Technology (NEAT)** (<https://neat.aicte-india.org/>) is an initiative for skilling of learners in latest technologies through a Public- Private partnership model between the Government (through its implementing agency AICTE) and the Education Technology companies of India. In education sector, it brings the best technological products on a single platform for the comfort of learners.

#### DISCUSSION

The current generations are synonymously called as “Netizens” and “digitals” as they have been born and brought up in the wraps of technology. They discover e-learning helpful and friendly as

it encourage them in pursuing their learning in their convenient space and time. In this technological age Indian government is also investing more on digital technology and tools across all the government service such as passport service, railway ticket booking, and online registration for water supply, e-bills, etc. The adaptive nature of e-learning technology imparts various intellectual capabilities to learners to utilize the best of knowledge without any time and spaces restriction.

#### SUMMARY OF STATES/UTS

	Activities	Andaman & Nicobar Islands	Andhra Pradesh	Arunachal Pradesh	Assam	Bihar	Chhattisgarh	Dadra & Nagar Haveli + Daman & Diu	Delhi	Goa	Gujarat	Haryana	Himachal Pradesh	Jammu & Kashmir	Jharkhand	Karnataka	Kerala	Ladakh
1	Digital Classroom	Y	Y	Y	Y	Y	Y	Y	Y	Y	Y	Y	Y		Y		Y	Y
2	ICT Labs	Y	Y	Y			Y	Y	Y		Y	Y	Y	Y	Y	Y	Y	Y
3	Online Admission		Y			Y	Y		Y		Y		Y			Y	Y	
4	E-content repository	Y	Y		Y	Y	Y	Y	Y	Y	Y	Y	Y	Y	Y	Y	Y	Y
5	E-Books	Y	Y	Y		Y	Y	Y	Y	Y	Y	Y	Y	Y	Y	Y	Y	
6	Offline books Text Books	Y	Y	Y	Y		Y	Y	Y		Y	Y	Y	Y	Y		Y	
7	Interactive Resources Online		Y	Y	Y	Y	Y	Y	Y	Y	Y	Y	Y	Y	Y	Y	Y	Y
8	Educational TV			Y	Y	Y	Y				Y	Y	Y	Y	Y	Y	Y	
9	Educational Radio channel			Y	Y						Y		Y	Y		Y	Y	
10	WebTV Channels	Y	Y			Y	Y	Y			Y	Y	Y		Y	Y	Y	
11	E-Learning Portal		Y			Y	Y	Y		Y		Y	Y	Y	Y	Y	Y	Y
12	Computer Based Learning	Y	Y	Y			Y	Y	Y	Y	Y	Y	Y		Y	Y	Y	Y
13	Mobile Application		Y		Y	Y	Y				Y		Y	Y	Y	Y		Y
14	Civil Society Partnership					Y	Y	Y	Y	Y	Y	Y	Y		Y	Y	Y	
15	Digital Initiatives for Competitive Exams						Y	Y	Y	Y	Y	Y	Y		Y	Y	Y	
16	Other Initiatives	Y	Y			Y	Y	Y	Y	Y	Y	Y	Y	Y	Y	Y	Y	Y

	Activities	Lakshadweep	Madhya Pradesh	Maharashtra	Manipur	Mizoram	Meghalaya	Nagaland	Odisha	Puduchery	Punjab	Rajasthan	Sikkim	Tamil Nadu	Telangana	Tripura	Uttar Pradesh	Uttarakhand	West Bengal
1	Digital Classroom			Y			Y		Y	Y	Y		Y	Y		Y	Y	Y	
2	ICT Labs	Y	Y	Y		Y	Y	Y		Y	Y	Y		Y	Y		Y		Y
3	Online Admission			Y			Y	Y	Y				Y	Y	Y				
4	E-content repository	Y	Y	Y	Y		Y		Y			Y	Y	Y	Y	Y	Y	Y	Y
5	E-Books	Y	Y	Y	Y		Y		Y	Y	Y	Y	Y	Y	Y	Y	Y	Y	Y
6	Offline books Text Books	Y		Y			Y	Y	Y	Y	Y	Y	Y	Y	Y	Y	Y		Y
7	Interactive Resources Online	Y	Y	Y	Y		Y		Y		Y	Y		Y	Y		Y	Y	Y
8	Educational TV			Y	Y	Y	Y	Y	Y		Y	Y		Y	Y	Y	Y	Y	
9	Educational Radio channel	Y	Y	Y	Y		Y	Y		Y	Y	Y	Y				Y	Y	
10	WebTV Channels		Y	Y			Y	Y	Y		Y	Y	Y	Y	Y		Y	Y	
11	E-Learning Portal	Y		Y	Y		Y	Y	Y		Y	Y	Y	Y	Y		Y	Y	Y
12	Computer Based Learning	Y		Y	Y		Y		Y	Y		Y		Y	Y		Y	Y	Y
13	Mobile Application		Y	Y			Y		Y		Y	Y	Y	Y	Y	Y	Y	Y	Y
14	Civil Society Partnership						Y		Y	Y		Y	Y	Y	Y		Y	Y	
15	Digital Initiatives for Competitive Exams			Y		Y	Y				Y			Y			Y		
16	Other Initiatives			Y	Y		Y	Y	Y	Y	Y	Y			Y			Y	Y

SOURCE- India Report on Digital Education 2020

The above table elaborate upon the various steps, both online and offline, taken by States/UTs to facilitate remote learning for students. Online teaching- learning process could not completely replace traditional education and school system as they provide many other qualities other than academic knowledge, which play an important role in learner's overall personality development and In online classes, the poor network connectivity especially in rural areas of the country creates a huge problem, even in the middle of the classes; the connection gets disconnected due to network problems, system error, software updates, etc.<sup>6</sup> E-learning can also create obstacles such as chances of piracy and plagiarism, ease of copy-paste, inappropriate selection skills, lack of interaction etc.

The education sector in India is no longer limited to just school classrooms. The e-learning and teaching market in India is estimated to be around \$3 billion. The central government's e-learning initiatives to make digital learning available to all learners in every corner of the country are also aiding the sector. Currently, online training in India focuses equally on school and college-based courses as well as professional courses.<sup>7</sup> However, education institution can improve and develop their skills and standards by imparting education through online platform with the help of digital technology and tools. Many online learning platforms and e-learning initiatives provide various programmes on the same subjects with different levels of certifications, methodology and assessment parameters. So, the quality of these programmes and courses may not be the same across different online learning platforms. Therefore, establishment of quality assurance mechanisms and quality benchmark for e- learning programmes must be developed and offered by HEIs in India keeping in view of rapid growth of the online learning platforms.<sup>8</sup>

## CONCLUSION

The growth of e-learning in India shows that, circumstantially, it has become acceptable substitute to the traditional class room learning in higher education especially under the present situations. E-Learning not only plays a major role in Indian higher education institutions but also acts as an emerging trend of education for future India. The majority of the learners believe that digital technology and flexibility are the key factors behind the development of e-learning in higher education. It has also discovered a new definition and dimension in teaching learning process and all government e-learning initiatives plays a very important role to make it available to all the students. For making e-learning more effective, it is essential to improve e-learning tools and technology and make few changes in the area of online assessment, investment in technology and faculty training and in policies and governance towards e-learning. All the educational institutions should focus on the technology and services that suit them and also security of data reliability and the personal information of teachers and learners should be secured. It can be concluded that the access to internet connectivity plays a crucial factor for growth of online education. In developing countries, e-learning raises the level of literacy and more so with the help of e-learning initiatives many opportunities can be captured and speedy development of educational sector is possible. It is also expected that if developing countries work as a joint venture on the issue of e-learning, it will be beneficial for the development of knowledge reservoirs throughout the world.

## REFERENCES

1. Gaikwad, A., & Randhir, V. S. (2015). E-Learning in India; Wheel of Change. *International Journal of e-Business, e-Management, and e-Learning*.
2. Wazalwar, A. N. (2020). Innovations in E-learning: The COVID-19 Impact. *International Journal of Grid and Distributed Computing*, 13, 113-117
3. <https://link.springer.com/article/10.1007/s11135-020-01028-z>
4. Vivekananda, M., & Ruvn, S. (2017). EMERGING TRENDS OF E-LEARNING IN INDIA. *International Journal Of Advance in Electronics and Computer Science*.
5. Ray, P. P. (2012). WEB BASED E-LEARNING IN INDIA: THE CUMULATIVE VIEWS OF. *Indian Journal of Computer Science and Engineering*, 1(4), 340-352
6. Dutta, D. A. (May 2020). Impact of Digital Social Media on Higher Education: Alternative Approaches of Online Learning during COVID-19 Pandemic Crisis . *International Journal of Scientific and Research Publications*.
7. Lone, Z. A. (2017). Impact of Online Education in Indian. *International Journal of Engineering Science and computing*.
8. Jana, P. K. (2020). Impact of COVID-19 on Higher Education in India. *International Journal of Advanced Education and Research*, 5, 77-81.

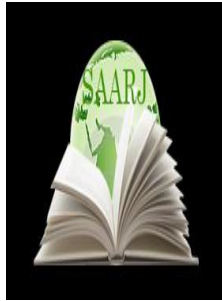

DOI: **10.5958/2249-7137.2021.01015.6**

## ON THE SPIRITUAL UPBRINGING OF YOUNG PEOPLE IN THE WORKS OF AJINIEZ QOSIBAY OGLU

**Taspanova J.K\***

\*Karakalpak State University,  
UZBEKISTAN

### ABSTRACT

*This article is about the spiritual upbringing of young people in the poetry of Ajiniyaz Qosibayoglu. It is said that Ajiniyaz's aesthetic participation in fiction is a realistic description of it, a description of the real world. The secrets of the work of art, the power of inspiration, which is difficult to express in words to the inner world of man, the service to ensure that people gain a deeper understanding of the beauty of life through art, and the main content of his literary and aesthetic views as part of the poet's worldview formed.*

**KEYWORDS:** *Spiritual, Life, Truth, Poetry, Thinker, Poem, Content, Thought, Creation, Work.*

### INTRODUCTION

Ajiniyaz Qosibayoglu is a poet who stood out in the history of Karakalpak literature for his philosophical ideas through sharia. His pen-shaking, nourished by the ideas of mystical teaching, was the basis for his success in literary-aesthetic considerations. The artist's mastery of poetry, his respect for the arts, his understanding of the importance of literature in society and its spiritual function among the people were the result of his mystical achievements.

The secrets of the work of art, the power of inspiration, which is difficult to express in words to the inner world of man, the service to ensure that people gain a deeper understanding of the beauty of life through art, and the main content of his literary and aesthetic views as part of the poet's worldview formed.

Therefore, the role of Ajiniyaz literature and music in society, especially its importance in giving beautiful feelings to man, its role as a tool to unite people for the benefit of the people, to call young people to fight against injustice, tyranny and ignorance, the conditions for the creation of art. In this regard, the poet's Central Asian thinkers: Navoi, Fuzuli, Makhtumkuli and many other

sages studied the richer and more meaningful aesthetic views, grew up receiving spiritual nourishment from the achievements of Khorezmian civilization in his youth. Known.

The poet's worldview of pantheism or Sufism: that everything in the world was created by God's command, that there is nothing but God's command and its execution, was also the basis for his understanding of the poetic ability of those who possessed high artistic expression. The famous Eastern thinker and sage, Ajiniez, in his literary and aesthetic views, first thought about the emergence of poetic talent in man, and considered the talent inherent in this art as a special gift given to man by God, which is not found in all.

Such aesthetic thoughts of the poet in connection with Sufism (mysticism) are vividly expressed in the poem "No":

Көңлимдеғам, дәрдиәлем,

Сөзләсәмшықардәмбәдәм

Меңасөздинбашқаигәм

Ҳешнәмәрсеберәнйокты[3-121] -

According to the author, if poets praise something unreasonably through their poetry, and write it with false images, such works will not be read by the selective people. In his time, Ajiniez also met some poets who created works in such a way. By pointing to the works of such masters of artistic expression, and by explaining that the life of superficially written lions is short, to the poets who have acquired a formalistic narrative: "I have seen with your own eyes that you're flattering words are a disgrace when they lie," he replied. [1-67] He said that only works written in real art will last a long time, and people will not forget such works from generation to generation.

Relying on his views based on mystical philosophy, Ajiniez said that masters of artistic expression will always serve the people with their talents, create new ideas and aesthetically pleasing works for the people, and will never forget that man is given the opportunity to live only once. Because he said, "There is no time to come back," so he said to himself, "Speak, my nightingale's tongue" [3-119].

Indeed, life in this world is given to every slave only once, and no matter who a person is, our way of life will come to an end in time. In the five-day world, he favored the wise use of life, the opportunity to express the people's dreams, aspirations, goals, and the desire to revive their good intentions with the help of "sweet words." These thoughts:

Зийўарайтур, саңакелүршумөлүм,

Сөзләқазанурып, содмайынғүлиң,

Сөзләмәкдиң қалур бу қызыл тилиң,

Бир күн шыбын киби жандын айрылса [3-64]

Can also be seen in the verses.

Calling the Shari'a a "sweet word," a "sweet language," Ajiniez said that the people of fiction, realizing the greatness of their service to society, encouraged them to believe in the "spiritual property" they give to the people and to seize the opportunity in time. He exemplified his

exemplary work on this subject to other masters of the art of speech, saying, "Before the poet dies his wise words" [1-66]. Through these ideas, Ajiniezh was able to further elaborate on the works that poets create during their lifetime and the services they render to the people.

The sage thinks that only the necklaces of the poetic works written by the poets are preserved by the people and passed down from generation to generation, enjoying them continuously and aesthetically. The ideas of justice, equality and humanity in these works of art have been nourishing the people for centuries.

Шийринтиладамныңтолықуаты,

Қаларкейингигесөздіңбәленті[1-66]

Indeed, a lion rich in wise thoughts, masterfully crushed, never wears out, never loses its power to influence people spiritually and aesthetically. Through these ideas, Ajiniezh explained that the value of the artistic word, the knowledge and advice contained in it, is inalienable. The reason is that poets, with their "sweet words", inspire the people to move forward. In this way, they feel happy for the rest of their lives because they have served their people, and they agree to live with the people of their creations:

Шайырлархәзметкенпалекрауана,

Шығарғаныкетернешшезамана [1-66]

Ajiniezh correctly understood the power of sharia, that it is an inexhaustible source of spiritual nourishment for man, the greatness of its power of aesthetic influence on human feelings. According to the poet, the people should not misunderstand the meaning of the content and ideas expressed in the works of art, to appreciate and enjoy the art of poetry, to understand and accept the ideas expressed in the poem, which is of great aesthetic importance.

Шайырларсөзетерелатымтыңлаң

Душпанларкүлерлер, досларымтыңлаң,

Дослар, мәнисин аўдырмай тыңлаң

Бул дүньяға шығып хәммесин көрдим[1-67]

According to the poet, only poetry that truly reflects life, depicts the goals in the hearts of the people, makes the existing life full of beauty and enjoys it. Far from aesthetics, meaningless works, first of all, undermine the reputation of the poet who created this work, lowering his value in this art, so the masters of the word believed that the events of life should be told in a realistic, fair way.

Ajiniezh believes that a person who correctly understands the content reflected in the sharia, who understands its aesthetic meaning, will never be satisfied with the spiritual pleasure that a lion gives. These sweet words were narrated by the people, especially the young ones, who listened with love and cheered and said so. To this end, in his poem "Kerak-Need" he explained:

Emphasizing the importance of art and literature in society, the role of keeping the people in high spirits, the poet reminded that without literature, especially without poetry, life would be uninteresting, depriving people of the joy of life. The word nourishes the souls of men, strengthens them spiritually, enriches the inner world of men, and helps them to understand

better than ever that the world is beautiful. In view of this, Ajiniez encourages people who are dissatisfied with a society where there is no equality and democracy, and urges them to fight for justice in society, especially in overcoming the difficulties of the times. Considered particularly large.

Зейинэйлепхэрнышанатүшмәге,

Кеўилқойыппәрўазетипушмаға,

Ғам-қайғыў, қәпестекөңлинашмаға,

Мунда, дәркаршийринсөздиңләззети [3-124]

Ajiniez's use of fiction, especially of singing lions, is a way for a person to lift his spirits, to remember the happy times in his life, to make them happy, and to use them wisely, orderly, and wisely. He wrote: "Ashyq (lyq) penenghazzelaytir, özoaqtymdykhoshetermen" [1-62]. The fact that the poets sang this love reminded them of the feelings of love in the youth, the uplifting spirit, which makes it more meaningful from an aesthetic point of view.

In his poem "Wounds", the poet vividly expresses these thoughts, explaining that the lion is an effective tool for rejuvenating the human soul and gaining strength from life: It is an effective weapon that satisfies the aesthetic needs of the people, increases their self-confidence and gives them great hope for the future.

According to the poet, the people remember and remember the influential lion, the "sweet word" together with the wise poet who created this work. This idea was reflected in the words of Ajiniez to the girl Mengesh in the language of Mengesh: It is known that Ajiniez fulfills these requirements through the services of aesthetic pleasure to the country at weddings among the people. Indeed, he showed his talent among the people: "If a poet (s) takes a pen, he (the people) will be satisfied with the word" [1-167]

The feudal Khiva regime of the Ajiniel period and the wealthy locals witnessed the humiliation and humiliation of the masters of the artistic word as they constantly condemned the atrocities committed by the officials and demanded justice. As a result, the poets who provided the people with spiritual food lived a difficult life without respect for their dignity in society, their leaders did not pay attention to the development of creative work, and he was one of such poets. az, I saw some of Shayir with my own eyes"[1- 66].

Indeed, in the poet's time, there was no time for the masters of the "sweet word" to freely write their works and give aesthetic pleasure to the people [3-39]. Dissatisfied with such a difficult situation, the poet read:

Сәнемлерқолындатилласазедим

Хәўижгекелтиррержәнәнболмады,

Туғырымдаталпынғаналғырбазедим

Қәлпе-саядларыммаманболмады. - [3-39]

He lamented the lack of opportunity in society to further develop his poetic talent, to create more of the lions that the people love to read.



The writer knew that the people knew the value of the poets who sang the life of the people, that their goal was to share their thoughts, that the people would listen to the wisdom they created, and that the task of the wise poets was to lead their people to peace. With this in mind, Ajiniez said: "My people knew my pain and I knew it, and those who heard it said what I heard. [3-138] - he reminded.

Noting that little attention is paid to the fiction loved by the people in the life of the society, Ajiniez supported the beginning of the efforts to spread the works of the poets for aesthetic enjoyment among the people. He wished that attention would be paid to introducing the achievements of artistic expression in the country for the benefit of the people, and that the importance of sharia in society would be taken into account. He lamented the fact that the sweet words, the "property of the soul" created by the poets with talent, did not move. This was stated in the above-mentioned poem "Dao'ranbolmady":

Әлипқаддимдалдекболыпбүгилди,

Көзлеримненқанлыяшымтөгілди.

Жолбойынауігенхасылйүгимди.

Базарғаелткендейкәрұанболмады. [3-39]

The poet believed that the sweet words created by the masters of artistic expression should be spread among the people, that people should be inspired by it, enjoy it, and enjoy it aesthetically. If these requirements were not met, he explained that the poet's works were aesthetically inferior, "like an old roof," if he did not use the wise words of the poet in public relations or, where necessary, to clarify the issue.

Ийемендепуллыатаққа,

Атыбелгилиелатқа,

Жайылмасасөзихалыққа

Шайыргөнетамғамегзер [3-73]

Ajiniez was well aware that in the Russian lands he visited, the Kazakh, Nogai, and Tatar peoples were publishing the works of poets in books or publishing them in newspapers and magazines. Seeing this, the writer tried to find ways to ensure that the "property of the soul" of the poets did not remain insignificant. He sent several people to Bukhara to publish his collection as a book. [5]

Ajiniez noted that the knowledge and experience of the poet played an important role in the meaningful creation of the Shari'a, the formation of wisdom in it, and considered the worldview of the masters of artistic expression to be richer. The lion was well aware that the "sweet word" arose from the intellect and learning of the poet, and was connected with the wisdom he possessed. When a master of artistic expression has a wide range of knowledge and understanding, his works will be deeply meaningful, full of wisdom and influential. Based on these experiences, he found that his poems were created in connection with the intellect, knowledge, and spiritual zeal he possessed:

He said, "My mind was raging like a river, and I was uttering words over and over again. There was no Armenian in my heart" [2-104]. At this point, Ajiniez also draws attention to the poetic

zeal associated with the art of artistic expression, implying that this quality is related to the mind, a spiritual quality that arises from the divine in man. He explained that poetic zeal, inspiration, is an important quality for a poet, that it flows like a river and that human words come out of each other in an effective, beautiful way.

Thus, Ajiniez explained the importance of fiction and music in society, as a necessary tool in the ideological armament of the people, and many issues necessary to increase the aesthetic effectiveness of art, in particular, the relationship of content and form, realistic expression of life, the participation of art in life. And b. he said. He was able to explain the great role of these arts in shaping a person's view of the world, the ideas and feelings expressed in poetry and music, the depiction of life events on the basis of a certain worldview.

#### REFERENCES:

1. Әжинияз. Таңламалышығармалары. Нөкис. ҚҚМБ. 1960. 180 бет.
2. Әжинияз. Таңламалышығармалары. Нөкис. «Қарақалпақстан», 1965.295 бет.
3. Әжинияз. Таңламалышығармалары. Нөкис. «Қарақалпақстан», 1975. 252 бет.
4. Әжинияз. Таңламалышығармалары. Нөкис. «Қарақалпақстан», 1988. 152 бет.
5. Ө.Өлеуов. Әжинияздыңағартыушылықойлары. Нөкис, «Қарақалпақстан», 1982.27-бет.

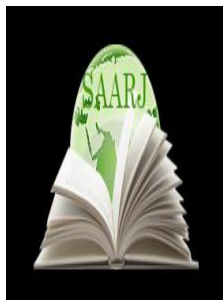

**ACADEMICIA**  
**An International  
 Multidisciplinary  
 Research Journal**  
 (Double Blind Refereed & Peer Reviewed Journal)

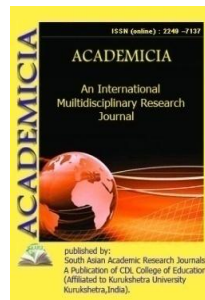

**DOI: 10.5958/2249-7137.2021.01016.8**

## **IMPROVING THE PRACTICE OF FORMING FINANCIAL RESOURCES OF ENTERPRISES**

**Xoliqov Sardor Botirogli\***; **Tajibekova Dilnoza Baxtiyarovna\*\***;  
**Jiyanova Nargiza Esanbayevna\*\*\***

\*4 year Student

Faculty of the Finance,  
 Tashkent Institute of Finance, UZBEKISTAN  
 Email id: kholikovsardor@gmail.com

\*\*Senior Lecturer

Department of "Public finance" Faculty of the Finance,  
 Tashkent Institute of Finance, UZBEKISTAN  
 Email id: dilnozza1980@gmail.com

\*\*\*Acting Professor,

Department of "Public finance" Faculty of the Finance  
 Tashkent Institute of Finance, UZBEKISTAN  
 Email id: nargiza\_omad@mail.ru

### **ABSTRACT**

*The article analyses the main sources of forming financial resources of enterprises. Furthermore, it describes some ways to improve the process of forming additional resources for enterprises. Management of financial resources of an enterprise is a set of purposeful methods, operations, levers, methods of influencing various types of finance to achieve a certain result. The financial resources of the firm are a part of the cash in the form of income and external income intended for the fulfillment of financial obligations and the implementation of the costs of ensuring extended reproduction. Financial resources and capital are the main objects of research of the firm's finances.*

**KEYWORDS:** *Financial resources, Sources of funds, Share capital, Authorized capital, Pricing policy.*

## INTRODUCTION

Management of financial resources of an enterprise is a set of purposeful methods, operations, levers, methods of influencing various types of finance to achieve a certain result. The financial resources of the firm are a part of the cash in the form of income and external income intended for the fulfillment of financial obligations and the implementation of the costs of ensuring extended reproduction. Financial resources and capital are the main objects of research of the firm's finances. In a regulated market, the concept of "capital" is more often used, which is a real object for the financier and which he can constantly influence in order to generate new income for the firm. As such, capital is an objective factor of production for the practical financier. Thus, capital is a part of the financial resources involved by the firm in the turnover and generating income from this turnover. In this sense, capital acts as a transformed form of financial resources.

The main link of the economy in the market conditions of management are enterprises that act as economic entities. They use certain types of resources for carrying out economic activities, obtaining products, income and savings: material, labor, and financial, as well as monetary funds. Many economists believe that "financial resources" are the money available to businesses. However, cash is an independent economic category. In their concept, the funds of enterprises that are on accounts in bank institutions, in cash registers, etc. are invested. They are taken into account in the active accounts of the accounting of enterprises and are reflected in the asset of their balance sheet. Financial resources are the sources of funds of enterprises that are directed to the formation of their assets. These sources can be owned, borrowed, or attracted. They are reflected in the corresponding sections of the balance sheet liability. Consequently, the financial resources of enterprises are their own, borrowed and attracted monetary capital, which is used by enterprises to form their assets and carry out production and financial activities in order to obtain the corresponding income and profit.

The formation of financial resources is carried out in the process of creating enterprises and implementing their financial relations in the implementation of economic and financial activities. When creating enterprises, the sources of formation of financial resources depend on the form of ownership on the basis of which the enterprise is created. Thus, when creating state-owned enterprises, financial resources are formed at the expense of the budget, funds of higher management bodies, funds of other similar enterprises during their reorganization, etc. For partnerships, this is the share capital, for limited liability companies – the authorized capital, for joint-stock companies-the share capital, for production cooperatives-the share fund, for unitary enterprises-the authorized fund. It turns out that the initial formation of financial resources occurs at the time of the establishment of the enterprise, when the authorized capital (share or stock capital) is formed.

Therefore, the authorized capital is the total value of assets fixed in the constituent documents, which are the contributions of the owners to the capital of the enterprise. The contribution to the authorized capital can be money, securities, other things or property rights that have a monetary value. The authorized capital minimally guarantees the rights of the company's creditors, so its lower limit is legally limited. The authorized capital is the main part of the company's own capital and the main source of its own financial resources. At the expense of its funds, fixed assets and current assets of enterprises are formed.

The investment attractiveness and the possibility of obtaining large loans largely depend on the size of the authorized capital of the organization. And many companies decide to increase it. When the authorized capital of the company is increased at the expense of its property, the nominal value of the shares of all participants of the company increases proportionally without changing the size of their shares. I.e., in fact, the amount by which the authorized capital increases is used to pay for additional shares placed among the participants.

The financial resources of the state and enterprises are the direct objects of financial management, that is, the management of their formation, use and flow of cash flows. The availability of sufficient financial resources, their effective use, determine the good financial position of the enterprise, solvency, financial stability, and liquidity. In this regard, the most important task of enterprises is to find reserves to increase their own financial resources and use those most effectively in order to improve the efficiency of the enterprise as a whole. Effective formation and use of financial resources ensure the financial stability of enterprises, prevents their bankruptcy.

The structure of sources of financial resources formation is important, first of all, the share of own funds in their total volume, the share of borrowed funds (over 50%) complicates the financial activities of the enterprise due to additional payments to banks (lenders), shareholders and shareholders (dividends, interest, etc.) and often makes the balance illiquid. Therefore, the financiers of enterprises are obliged to calculate the profitability of attracting borrowed funds into circulation every time. Effective financial activity of the enterprise is impossible without competent management of financial resources. So here the role of management and classification of financial resources is so much important factor in to the form the capital of enterprises. Here in Figure 2 all possible sources of formation of financial resources of the enterprise are considered in more detail:

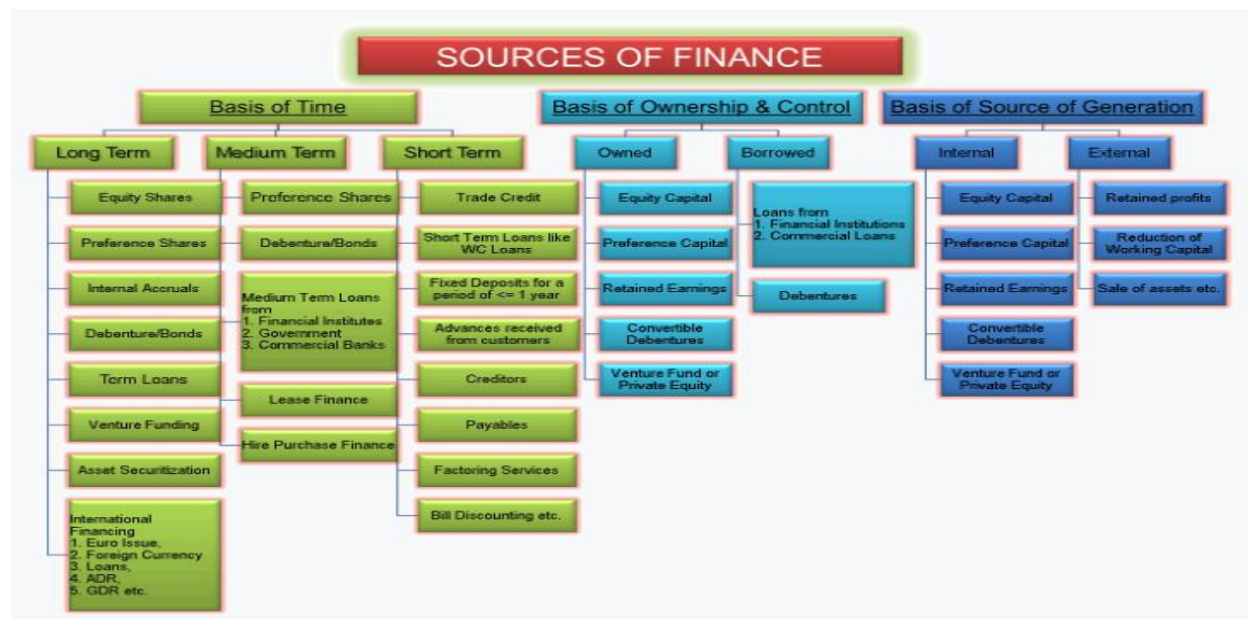

Additional contributions may be made by the company's participants within two months from the date of the decision of the general meeting of the company's participants to increase the authorized capital, unless the company's charter or the decision of the general meeting of the

company's participants sets a different deadline. Then, no later than one month from the date of the end of this period, the general meeting of the Company must be convened, at which the results of the increase in the authorized capital are approved. In case of non-compliance with this deadline, the increase in the authorized capital of the company will be declared invalid.

The main sources of funds used to finance the economic activities of the enterprise are:

- The own funds of a commercial company (profit, depreciation, etc.) —
- Credit funds and resources of banks whose activities are based on investments;
- Allocation of budgets of various levels;
- Financial resources of various types of commercial structures (investment companies, commercial banks, insurance companies, etc.);
- Investments of foreign companies;
- Private savings of individuals;
- Other types of investments.

We can consider such trends on the example of JSC «Uzbek commodity exchange» over the past five years (Figure 1). As we can see, the authorized capital of this joint-stock company did not change, but there was a stable growth in retained earnings. This was mainly due to the reforms in the legislation of our country, as well as the introduction of innovative methods in the operation of this enterprise.

Diagram 1.

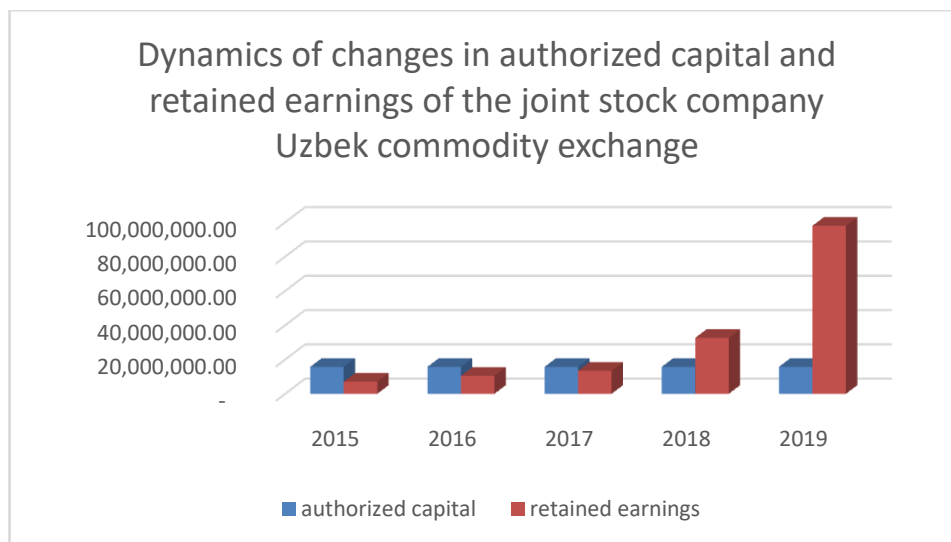

It is potentially possible to achieve a balance between the consumption of your own financial resources and those attracted from outside, between positive and negative cash flow, using the following ways:

- Sale or lease of unused or worn-out fixed assets, in order to improve the efficiency of the use of its own resources;

- Reduction of excess production stocks and non-current assets, in order to accelerate the turnover of assets;
- Establishing stricter control over the timely settlement of payments with both buyers and suppliers, in order to prevent the growth of accounts receivable;
- Use of a more effective pricing policy to promote their own products to the market in order to increase net income and increase the profitability of the enterprise;
- Forecasting of financial performance based on the actual conditions of economic activity and the availability of own financial resources.

These areas should be implemented within the framework of financial management, which is one of the most important subsystems of the overall management system of a modern enterprise and allows for more efficient formation and use of its financial resources.

Thus, the formation of the financial potential of the enterprise is one of the objects of the financial strategy, and its change is due to its effectiveness. The availability of sufficient financial resources and their effective use determine the financial viability of the organization: solvency, financial stability, and liquidity. They can arise from a wide variety of sources

#### REFERENCES:

1. Leasing: economic legal bases: textbook. Manual for universities. - 2nd ed., reprint. And additional / N. M. Korshunov. - M.: UNITY-DANA, 2008. - 190s.
2. Mazur, I. I. Quality management: A textbook / I. I. Mazur, V. D. Shapiro. - M.: Finstatinform, 2008 – - 302 p.
3. Malyavina, A.V. Leasing and anti-crisis management / A.V. Malyavina, N. B. Pashina, S. A. Popov. - Moscow.: Exam, 2008 – - 326 p.
4. Pavlova, L. N. Financial management: Textbook. - 2nd ed., reprint. And additional / L. N. Pavlova. - M.: UNITY-DANA, 2007 – - 458 p.
5. Raitsky, K. A. Enterprise economics: Textbook for universities. - 2nd ed. / K. A. Raitsky. - M.: Information and Implementation Center "Marketing", 2007 – - 696 p.
6. Raizberg, B. A. Modern economic dictionary. - 2nd ed., corrected. / B. A. Raizberg, L. Sh. Lozovsky, E. B. Starodubtseva. - M.: INFRA-M, 2006 – - 215s.
7. Savitskaya, G. V. Analysis of economic activity of the enterprise: Textbook. - 4th ed. pererab. And add. / G. V. Savitskaya. - M.: INFRA-M, 2007 – - 512 p.
8. [www.uzex.uz](http://www.uzex.uz)- official website of JSC «Uzbek commodity exchange».

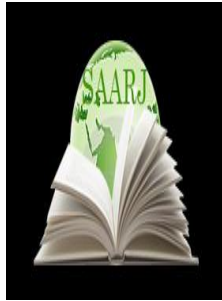

**ACADEMICIA**  
**An International  
 Multidisciplinary  
 Research Journal**  
 (Double Blind Refereed & Peer Reviewed Journal)



**DOI: 10.5958/2249-7137.2021.01017.X**

## FLOWS AND DIRECTIONS IN FINE ART, ARTISTIC PERCEPTION OF WORKS

**Smaylova Gulmari Yuldashevna\***

\*Associate Professor,  
 Regional Center for Retraining of Public Educators,  
 Republic of Karakalpakstan Applied Sciences and Extracurricular Teaching Methods,  
 UZBEKISTAN

### ABSTRACT

*The article focuses on currents and trends in fine arts classes in secondary schools, such as impressionism, post-impressionism, cubism, pointilism, fascism, which have a special place in the artistic perception of works and their important place in world art and also, information on flows and directions. Freedom in creativity cannot exist outside of society; society gives its meaning to art, expressed in the language of national styles. However, national styles are not the texture of a group of artists, nor are they a guide to all events in life or a top-down guide, a code of conduct or a way of thinking, but a spiritual unity of ethnic and linguistic brotherhood and it is the result of an action that has taken place in the collaboration of historical directions.*

**KEYWORDS:** *Currents and trends, Impressionism, Post-impressionism, Cubism, Pointillism, fauvism, Avant-garde, Neo-impressionism.*

### INTRODUCTION

As in the social life of Uzbekistan, radical changes are taking place in its art. Fine art, which has a rich heritage, especially its most popular type, differs from other types of painting in its development, its ease of depicting ideas in an avant-garde way. For this reason, in the history of fine arts, works in painting, which are divided into different streams, directions and styles, and created on the basis of symbolic forms, have a special place. There are two main opposing traditions in contemporary painting. One is “retro” that is, creation based on traditional realistic rules, and the other is “avant-garde”, and that is, a combination of currents and trends that transcend the boundaries of the advanced traditions of world art is a direct result. The theoretical roots of avant-garde were not born of abstractionism and its disconnection from reality. Because even if any work does not look like real life in one way or another, it is first and foremost a



combination of events. Freedom in creativity cannot exist outside of society; society gives its meaning to art, expressed in the language of national styles. However, national styles are not the texture of a group of artists, nor are they a guide to all events in life or a top-down guide, a code of conduct or a way of thinking, but a spiritual unity of ethnic and linguistic brotherhood and it is the result of an action that has taken place in the collaboration of historical directions. There are some periods in the development of world art that the current artistic method, direction and means of depiction do not fully meet the requirements of the time. Then, as a result of the artist's desire for innovation, he creates a unique direction and style. The art of Uzbekistan has entered the XXI century with great changes. That is why in many exhibitions we see the works of artists in different styles. At the same time, there are cases of misunderstanding of such works. This is due to the fact that they do not know how to “read” works of art, analyze them, currents and directions, styles, specific schools, and do not know about them.

This is due to the fact that they do not know how to “read” works of art, analyze them, currents and directions, styles, specific schools, and do not know about them. Given that the book's audience could expand, we decided to include information about them as well. Impressionism (French: impressionism) is one of the major artistic trends of the 19th century, which emerged and developed in opposition to the rigid, dogmatic academic-salon art. In 1874, an exhibition of works by The Humiliated (as unofficial artists were called) opened in a cafe in Paris. It contained pictures that did not look like the clocks that everyone was used to, and that at first glance contradicted “real art”. A journalist called the title of his article for the exhibition “Impressers” based on Claude Monet's work “Impressions before the Sunrise”. Originally used to describe the work of a group of artists, the term was later applied to sculpture, music, literature, and other forms of art. This style is realistic in its content and enriches its possibilities. The artists tried to use color greases freely and effectively. Color has become one of the tools of general perception of existence, of its objects. From nature itself, open-air painting (in the open air) became the main creative style of the Impressionists. This enriched their palette and enhanced the impact of their work. Impressionists have emerged in the history of art as innovative artists. The peculiarity of the direction of Imperialism is manifested in the works of Claude Monet, the founder and leader of this movement, such as “Pichantarami”, “Poppy field”, when objects are wrapped in light and air, lose their appearance and will become a color balance. Although Kamil Pissarro's works, such as “The Streets of Paris” and “Montmartre Avenue”, are small in size, the composition is complete, in keeping the beauty of nature alive and vibrant, Pierre Auguste Renoir's “Mrs. Samari” and “The Naked Woman” reflected youth, physical beauty, and cheerfulness with great skill. Edgar Degas's “Dancers in Blue Dress”, “Ballet Class” and Alfred Sisley's “Little Square in Argentina” are also examples of Impressionism. Representatives of Impressionism brought light and color to the art of world painting. They paid more attention to the brilliance of the colors, the play of light and shadow, than to the outlines of the objects, to the expression of its concrete form. They created works using “pure” colors close to the colors of the spectrum, using optical interference of colors. Impressionism existed as a trend for almost 30 years, and later gave way to post-impressionism. Despite much controversy and criticism, the Impressionists were more effective. Their contribution to the further development of world art is invaluable. In particular, Impressionism has laid the foundations for many currents and trends in contemporary art. The role of the representatives of Impressionism in understanding is incomparable.

Post-Impressionism (Latin for “post” later) is a movement influenced by Impressionism, in which members of the movement work in pure colors, such as the Impressionists, in contrast to them, they sought to create generalized images through conditionality. The term is conditional and is usually used to describe the work of artists who emerged after Impressionism and marked their path in art history without its achievements. While acknowledging the achievements of the Impressionists, the movement opposed the use of etiquette as etiquette, ignoring pencil painting as the basis of fine art, and avoiding social issues. Great artists such as Vincent Van Gogh, Paul Cézanne and Paul Gauguin are great representatives of post-impressionism.

Neo-impressionism (French: neo-impressionnisme) was a movement in late 19th-century French painting. Its major representatives are J.Syora and P.Sinyak. Neoimpressionism is also widespread in Belgium (T.VanReyselberg) and Italy (J.Segantini). Its representatives worked on thematic compositions, portraits in a three-dimensional space. Neo-Impressionists developed the traditions of recent Impressionism, including optical properties, and developed methods for applying complex shades of color. In this sense, they laid the foundations of divisionism, pointillism.

The great masters of neo-impressionism overcame the randomness of impressionism, the fragmentation of compositions, and came up with a decorative solution. This style usually led to cold intellectualism, the dryness of the images. Nevertheless, the brightness and excitement of the color system of artists such as P.Sinyak, A.Kross created the basis for the emergence of fascism.

Pointillism (French “pointillisme”, “point” means “dot”) – “pointiller” - means to write, draw with dots, is one of the major trends in painting. In this style, color smears are applied in the form of small round dots with a characteristic of neo-impressionism. In some cases, this style is called divisionism (“divisionism” - French – “separation”). In the 1880s and 90s, a number of trends and trends emerged in French art. Artists such as Paul Sinyak (1863-1935), George Syora (1859-1891), and Henri Edmond Cross sought to scientifically substantiate the optical addition of colors. They tried to work their works without touching the spectral color greases in the form of small cubes or round dots. These color greases are separated, creating a new, cohesive color system through the addition of optics. This method is called point, that is, the point method. In the history of art, this style is called “pointillism” and its representatives are called “pointillists”.

George Syora's “Grant Jatt Holiday”. Paul Sinyak's “Fractions in Avignon” reveals the peculiarities of the style of pointillism. Cubism (French “cubisme”). The homeland of this movement is France, which originated in the early twentieth century, and its great representatives, such as P.Picasso, J.Brock, F.Leté, R.Belonin sought to exaggerate the informational potential of the depicted objects, to divide them into simple geometric shapes. Fauvism (derived from the French word “fauvism”, “fauve”, meaning “savages”) is a movement in French painting of the early twentieth century. This is the nickname “les fauves” (the wicked), who in 1905 year took part in the Paris show “Salon of Independence” A.Metiss, A.Marge, J.Ruo, M.Vlemink, A.Deren, R.Dyufi, J.Brek, K.It was used in relation to Van Dongen and similar artists. They sought to solve the issues of form, plasticity in a primitive (extremely simple) way, similar to medieval art, including in a way peculiar to Oriental Art.

**REFERENCES**

1. ДелакруадоМатисса. СоставителиР.Бретел, Э.Нортон, С. Стайн, Г. Гинтероу. - Ленинград: 1988.
2. Популярнаяхудожественнаяэнциклопедия. Составители: В.М.Полевой, В.Ф.Маркузон, Д.В.Сарабьяков, В.Д.Синюков и др. - М.Энциклопедия, I-II часть. 1986.
3. Словарьиностранныхслов. - М. 1979.
4. Сорока-Цюпа О.С., Смирнов В.П., Строганов А.М. Мир в XX веке. Учебникдляобщеобразовательныхучебныхзаведений. -М.Дрофа, 2002.
5. Сулаймонов А.П. Импрессионистларнинг «тугилганкуни» ёхудмактабдатасвирийсанъатдагиоқимвайуналишларниурганиш. «Халктаълими» ж. - Т. 2007. №6.

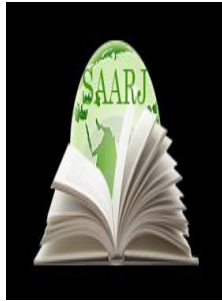

DOI: **10.5958/2249-7137.2021.01018.1**

## PSYCHOLOGICAL PROCESSES AND WAYS TO PREVENT INFECTION IN ADOLESCENTS LIVING WITH HIV

**Karimjonova Yoqutxon\***

\*Teacher of Psychology,  
FSU, UZBEKISTAN

Email id: Yoquthon\_86@mail.ru

### ABSTRACT

*The article describes the causes of HIV infection, its routes of transmission, this infection in adolescents and changes in psychological processes in adolescents under its influence, stressful situations and measures to prevent them. A person's health and life are above all. Therefore, a person should not be indifferent to his health throughout his life, otherwise he may face disappointments. Because there are different types of people in the society we live in, ming unfortunately among them the presence of people being treated for or infected with a contagious disease constantly calls us to vigilance.*

**KEYWORDS:** *HIV infection, adolescence, stress, remedy, correction, immunity, virus, mental processes, syndrome, cognitive.*

### INTRODUCTION

A person's health and life are above all. Therefore, a person should not be indifferent to his health throughout his life, otherwise he may face disappointments. Because there are different types of people in the society we live in, ming unfortunately among them the presence of people being treated for or infected with a contagious disease constantly calls us to vigilance. We want to reflect below on this very HIV infection and its classification, ways of transmission and its impact on the minds of young people. We will first consider the nature of the content of this infection.

HIV infection is a chronic infectious disease caused by the human immunodeficiency virus, which remains in the body of a sick person throughout his life. The infection is initially latent, has been shown to be transmitted vertically through breast milk.

As HIV infects a person, it attacks his or her immune system. When an organism fights a disease, it is called an "immune response," which is controlled by the human immune system. It

is a very complex system of blood cells. HIV only targets one type of white blood cell called CD4 (you can see this in the picture below). These T-helper cells play a key role in protecting the body from disease. Their main role is to direct the army of "killer cells". CD4 cells instruct these "killer cells" on what to do. Without CD4 cells, "killer cells" cannot fight, and the body's immune response becomes less effective. In addition to attacking CD4 cells, HIV can also use them as a "factory" to create its own. In this way, HIV creates billions of new cells in the body, attacking more CD4 cells in the body. In response, the body fights and produces more CD4 cells, "killer cells" and more antibodies.

Unless specific treatment for HIV infection is started, over the years, HIV will slowly destroy so many CD4 cells that our bodies will not be able to regenerate them. At this stage, the amount of CD4 cells in the blood is 200 cells / mm<sup>3</sup>. This test is called a CD4 count and is an important measure of the immune response. The normal CD4 level in an HIV-free adult is typically 800–1200 cells / mm<sup>3</sup>. Therefore, when the amount of CD4 drops to 200 cells / mm<sup>3</sup>, the immune system is actually on the trail begins to exit. After that, the person loses the ability to fight other infections that cause the disease, and AIDS develops. People living with HIV have no symptoms for a long time. You don't know if he has HIV or not. People living with HIV can look healthy and feel healthy. They can study, work and continue their daily activities. They do not show any signs for a long time. This period is called the "asymptomatic" period, ie the period without any symptoms. It can also infect other people without their knowledge. Therefore, it is important to get tested and use HIV prevention methods. In general, HIV develops slowly in the human body and symptoms appear over a long period of time. In some people, it develops rapidly, but in most adults, the AIDS stage develops in about 10 years. In people living with HIV, a number of factors, including food quality, general health, physical and mental stress, and drug use affect the developmental stages of the AIDS stage. Treatment with antiretroviral drugs may also play a role in the development of HIV infection. People with AIDS die within 1.5-2 years if left untreated. However, people living with HIV who are under medical supervision and treated with the necessary antiretroviral drugs can live a full life for many years to come. These were the reasons for the origin, and it is natural that the question arises as to how to inform the young people suffering from this disease.

What exactly to tell a child or adolescent is his age and some issues (for example, certain functions of the body and the nature of the disease).determined by understanding. It's better to be a parent. If a child has HIV, it is best to let him or her know between the ages of 7 and 11. If a child learns about the human immunodeficiency virus through the media or school, he or she may have a number of questions and comments. Therefore, the parent should inform the child in advance. This allows the child to be told that one of the family members is infected with HIV. If a parent has someone who can advise them on how to tell them what to do with their HIV infection and what words to use, it's a great light upon light. To do this, play different role-playing games with the children, during the game the children can give written or oral answers to various questions, or read a book about HIV / AIDS to them. In this regard, it is advisable to organize psychological trainings. Parents need to make sure that their children are well-informed. Young children can understand simple concepts about HIV. For example, "All people have white blood cells in their blood. They help people stay healthy. And in my blood, those cells are sick. That's why I'm often sick and tired. "Explanatory work should be carried out in the usual, simple cases, for example, when going to the doctor during the illness. The doctor

may say that the child has the ORZ virus. Parents say that they are also infected with the virus, but they are not infected with the flu in children, but with a larger virus, so the parent may feel unwell and "can't play with you" or "so for your mother or father must be hospitalized for the doctors to correct them." Can be explained. Parents should also discuss with their children that this information should be kept confidential. Children need to be made clear that this secret should not be told to anyone under any circumstances. They need to find an explanation that is appropriate for their age and explain why they should keep it a secret. For example, it can be explained that others have a negative view of HIV, which can lead to frustration. Children react differently when they find out that someone in the family is infected with HIV. Given that children's reactions can be severe for adults, it is best for parents to consult with and seek help from professionals who have been working with children and young people for a long time. In children, as well as in adults, the reaction may appear over time. They may grieve the loss of a loved one, even though he or she is still alive. It is also possible that they think that their normal family life will end. Their whole mind may be occupied with a dying loved one, they may lose their mental stability, and they may not be able to relate to their HIV-infected relative as before. Some children may be relieved if someone in the family suspects that they are infected with HIV and they hear about it from themselves. There is no need for him to torture himself with suspicions and pretend he doesn't know anything. At times, the child may appear to have no reaction to the information. In that case, you need to give him time to think about everything. If a parent or other adult provides spiritual support to the child, he or she can share his or her feelings, ask questions, and express his or her feelings. In such cases, it is very important that the child's psyche is not broken, that he does not feel like a useless person, but that he looks at life differently. Unfortunately, the psychology of all parents or children living with HIV is not always as positive as we think, it takes on a negative mood and consciousness, for which life seems to have come to a standstill. This is because it is difficult for a teenager to suddenly become aware of the disease when he is already accustomed to both psychological and physiological changes. In such a complicated situation, it is better for parents to deal with their children individually, under the supervision of a psychologist. It is important for the psychologist to talk to the child and explain with good examples that life is not over with him, that he should not be addicted, and that he can live with this disease for many years.

#### REFERENCES:

1. Yu...P. Lisisinobshestvennoezdorov'eizdravooxraneniyauchebnikdlyaVUZov M. - 2003g. STR. 5-24.
2. V.K.Yur'ev, G.I.Kuchenkoobshestvennoezdorov'eizdravooxraneniyauchebnik Sankt-Peterburg. 2000. P. 3-10.
3. Law "On protection of the health of citizens of Uzbekistan" August 29, 1926 years.
4. Law of the Republic of Uzbekistan "On drugs and pharmaceutical action".
5. E. Gaziyeu Text of the lecture "General Psychology" Tashkent-2010
6. E. Goziyeu "Psychology of ontogeny" textbook Tashkent - 2014

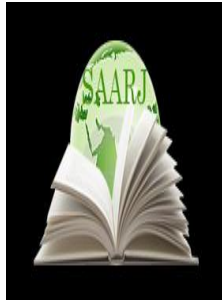

**ACADEMICIA**  
**An International**  
**Multidisciplinary**  
**Research Journal**  
 (Double Blind Refereed & Peer Reviewed Journal)



**DOI: 10.5958/2249-7137.2021.01019.3**

## STUDY OF EPIDEMIOLOGICAL FEATURES OF VISCERAL LEISHMANIASIS IN ENDEMIC AREAS OF THE REPUBLIC OF UZBEKISTAN

**Gaybullaev Fazliddin Khayriddinogli\***

\*Bukhara State Medical Institute named after Abu Ali Ibn Sino,  
 UZBEKISTAN

### ABSTRACT

*In the study of the clinical and epidemiological course of visceral leishmaniasis in the regions studied by the author, all 70 patients were children. The average age of the patients was  $5.8 \pm 0.8$ . 58.6% (41 people) were girls and 41.4% (29) were boys. In terms of regions studied, the highest rate is in Navoi region - from 3.3 to 4.1 per 100,000 population, the incidence rate increased by 1.2 times, followed by Samarkand region - by 2.2 times. In Namangan region, there was a 2-fold decrease.*

**KEYWORDS:** *Visceral leishmaniasis, sternal puncture.*

### INTRODUCTION

Leishmaniasis is a widespread disease worldwide, affecting 350 million people each year. The person is at risk of injury. Leishmaniasis is registered in 98 countries. [2] Leishmaniasis affects 700,000-1 million people a year. It is estimated that 50,000 to 90,000 cases are visceral leishmaniasis. [2]

The causative agent of visceral leishmaniasis (VL) is *L. infantum* (synonyms: Mediterranean leishmaniasis, pediatric leishmaniasis), mainly distributed in the Mediterranean, the Near and Far East, the Caucasus and Central Asia. VL is a more dangerous disease than other leishmaniasis: if the disease is not diagnosed and treated in time, it can lead to the death of the patient. The risk group includes children, especially young children. [1]

Currently, the main hearth of VL is located in Pop district of Namangan region. The first cases of the disease in Pop County have been registered since 1987. From 1987 to 2009, 95 cases of VL were observed in 9 settlements. The resurgence of BJI in the Republic of Uzbekistan requires a modern study of the spread of the disease among humans, the reservoir of infection, the clinic, the carriers. [2]

## MATERIALS AND METHODS

The study was conducted in 2016-2017 at the Samarkand Institute of Parasitology named after Isaeva, Navoi and Namangan Regional Infectious Diseases Hospitals, and during this period observed 70 patients diagnosed with visceral leishmaniasis.

All 70 patients in the follow-up group were children. The mean age of the patients was  $5.8 \pm 0.8$ . 58.6% (41 people) were girls and 41.4% (29) were boys. There was no statistically significant difference in the sex of patients in the follow-up group.

Patients were diagnosed by clinical signs and the detection of leishmaniasis on microscopic examination of the bone marrow puncture, and groups of patients were randomly selected according to their arrival at the hospital.

**TABLE (1). THE VOLUME OF RESEARCH METHODS CONDUCTED**

№	Research methods		Number of patients
1.	Clinical-laboratory	Clinical follow-up of patients	70
		Clinical analysis of blood, urine, feces when coming to the hospital and before discharge	70
		Blood biochemical analysis	70
		Sternal puncture	45
		Rk-39 test	20
2.	Statistical analysis		70

### The incidence of visceral leishmaniasis in Samarkand, Navoi and Namangan regions

The first task of the study was to analyze the data of the State Center for Sanitary Epidemiological Surveillance of the Republic of Uzbekistan for 2016-2017 in order to study the dynamics of the incidence of visceral leishmaniasis in Samarkand, Navoi and Namangan regions.

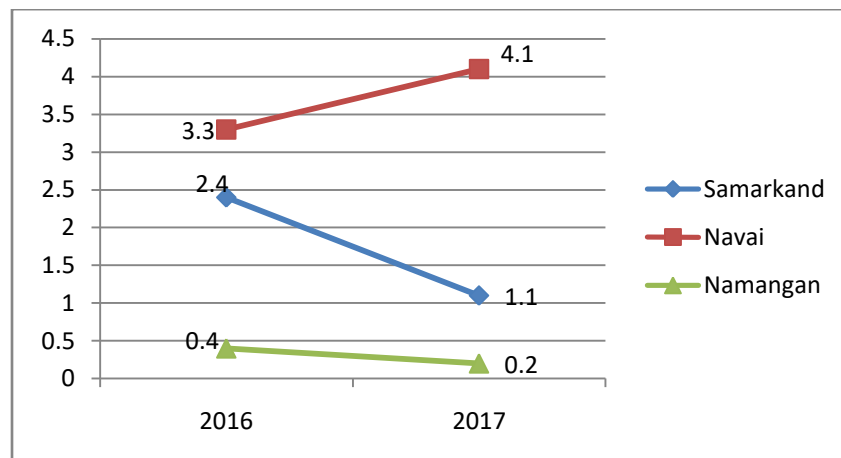

**Picture 1. The incidence of visceral leishmaniasis in the study areas (intensive)**

According to the results of the analysis, in 2017, 506 cases of visceral leishmaniasis were registered in the country. In 2016, the figure was 391. In terms of regions studied, the highest



rate is in Navoi region - from 3.3 to 4.1 per 100,000 population, ie the incidence rate increased by 1.2 times, followed by Samarkand region - by 2.2 times. In Namangan region, the number of cases decreased by 2 times.

[Picture1]

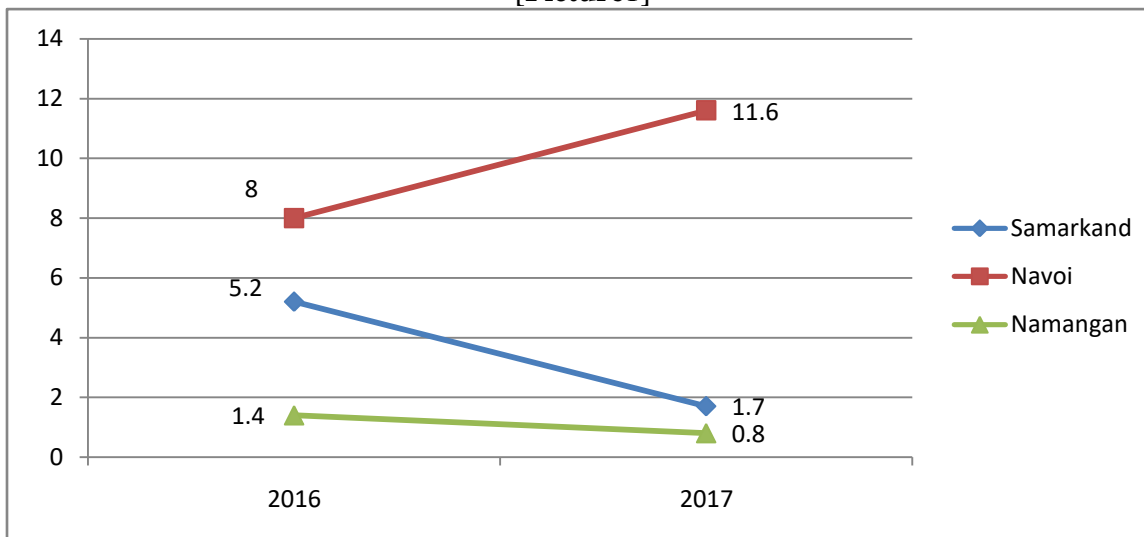

**Picture 2.** Incidence of visceral leishmaniasis among children under 14 years of age in the study areas (intensive rate)

In 2017, 44.5% (225) of patients with visceral leishmaniasis registered were children under 14 years of age. This figure is 1.2 times higher than in 2016, i.e. in 2016, the number of children under 14 years of age with visceral leishmaniasis was 188. In 2016, children accounted for 48.1% of all cases.

An analysis of children with visceral leishmaniasis in the studied regions showed that the incidence rate among children was highest in Navoi region, and in 2017 the incidence rate increased 1.5 times compared to 2016. In Samarkand and Namangan regions, the incidence among children decreased by 3.5 and 1.8 times, respectively, as in adults. [Figure 2]

## CONCLUSION

1. If you look at the cross-section of the studied regions, the highest rate is in Navoi region.
2. There was no statistically significant difference in the sex of patients in the follow-up group.
3. Samarkand region - over the years, the incidence rate decreased by 2.2 times, and in Namangan region - by 2 times.

## REFERENCES

1. Leishmaniasis: WHO bulletin. 2 March 2020 Link active on 20.09.20. Available at: <https://www.who.int/ru/news-room/fact-sheets/leishmaniasis>.
2. Obloqulov A.R., Narziev I.I., Kholov U.A., Niyazov G.E. (2018) Osobnostitecheniyakishechnogolyambliozauvzroslyx. New Day in Medicine 1 (21) 100-103;

3. Akhmedova M.D., Abidov Z.I., Gaybullaev F.X., TashpulatovaSh.A., Anvarov J.A., Imamova I.A. Predictor of severe treatment of visceral leishmaniasis // NEWSLETTER OF THE MEDICAL ACADEMY OF MEDICINE OF ONTUSTIK KAZAKHSTAN - 2018. - P 36-41. ]
4. Mirzoeva M.R. Character and frequency of complications in patients with chronic toxoplasmosis // New in medicine. - 2019. - C. 207-209.]
5. Gamal ShayfXaytemShayf Optimization of treatment of visceral leishmaniasis in children in Yemen // abstract on diss k.m.n.-Moscow.2006.-26s
6. Jirenkina E.N. Osobennostiochaga visceral leyshmanioza in Papskomrayona, NamanganskoyoblastiUzbekistana // avtoreferatnadiss k.m.n.-Moskva.2013.-29s
7. MaxtiFaxar.  
Sistematischeiyobzorimetanalizdiagnosticheskoytestamochidlyadiagnostikivisistralnogo leyshmanioza.PROSPERO 2017http: //www.crd.york.fc.uk
8. Chaturaka Rodrigo, Praveen Veratunga, SenakaRajapakse, Dipika Fernando. Amphotericin For the treatment of visceral leishmaniasis: Systematic review and metaanalysis Perspective guidelines for clinical trials, including the study of the dosage of PROSPERO 2017http: //www.crd.york.fc.
9. Charles Abongomera, Saskia Van Xenten, Rezika Mohammed, Florian Fogt, JozefenBuyze, ErmiasDiro, KoertRitmeyer, Tine Verdonk, Johann van Grevensven: Systematic review of the factors of risk of death in patients with acute respiratory infections. PROSPERO 2016http: //www.crd.york.fc.uk



**ACADEMICIA**  
**An International**  
**Multidisciplinary**  
**Research Journal**  
 (Double Blind Refereed & Peer Reviewed Journal)

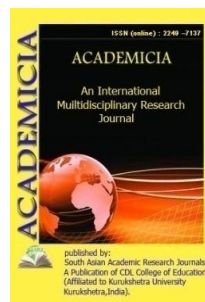

**DOI: 10.5958/2249-7137.2021.01020.X**

## INTERCULTURAL COMMUNICATION AND TEACHING FOREIGN LANGUAGES

**Tukhlieva Gavkhar Nurislamovna\***; **Qurbonova Mushtariy Abdujabborqizi\*\***;  
**Abdullaeva Nigora Rustamovna\*\*\***; **Azodova Mahliyo Neymatjonqizi\*\*\*\***;

\*PhD at the Foreign Philology Faculty,  
 National University of Uzbekistan, Named after Mirzo Ulugbek,  
 UZBEKISTAN

Email id: tuhlievagavhar@gmail.com

<sup>2,3,4</sup>Teacher at the Foreign Philology Faculty,  
 National University of Uzbekistan, Named after Mirzo Ulugbek  
 UZBEKISTAN

Email id: charlotta0103@gmail.com; fashionable01@mail.ru; azodovam@bk.ru

### ABSTRACT

*The article examines new conditions demanded an immediate and essential revision of both general methodology and specific teaching methods and techniques of TFL and the main tasks of TFL in Uzbekistan at present. Furthermore, the theoretical bases of intercultural communication in teaching and learning foreign language are covered in the work. The problem of modifying the foreign language as an instrument of production combined with culture, economics, law, applied mathematics, various branches of science - with those areas that require the use of foreign languages is touched. The work presents the results of the methodological and cultural analysis of materials used to describe the process of teaching language considering intercultural communication.*

**KEYWORDS:** *Intercultural communication, Consciousness, Non-philologists, Function of a message, Informative function, Language skills.*

### INTRODUCTION

The close connection and interdependence of teaching foreign languages and intercultural communication is so obvious that they hardly need long explanations. Each foreign language lesson is a crossroads of cultures, it is a practice of intercultural communication, because every

foreign word reflects foreign world and foreign values: behind every word there is a conditioned national consciousness view of the world.

Teaching foreign languages in Uzbekistan is experiencing today, like everyone else other spheres of social life, the hardest and most difficult period of the indigenous restructuring, reassessment of values, revision of goals, tasks, methods, materials. It makes no sense to talk now about huge changes in this area, about flourishing in public interest, about an explosion of motivation, about a radical change in the attitude towards this subject for quite certain socio-historical reasons are all too obvious. New time, new conditions demanded an immediate and radical revision both general methodology and specific teaching methods and techniques foreign languages. These new conditions are the "opening" of Uzbekistan, its rapid entry into the world community, crazy leaps in politics, economics, culture, ideologies, mixing and displacement of peoples and languages, changing relations between Uzbekistan and foreigners, absolutely new goals of communication - all this cannot but to pose new problems in the theory and practice of teaching foreign languages.

An unprecedented demand needed a unique supply. Unexpectedly for myself foreign language teachers are under the attention: impatient legions of specialists in various fields of science, culture, business, technology and all other areas of human activity required immediate teaching foreign languages as a tool of production. They are not interested in any theory, nor the history of the language - foreign languages, primarily English, they need exclusively functionally, for use in various spheres of social life as a means of real communication with people from other countries.

Under the circumstances, to meet socio-historical needs of society which was previously understood completely differently and, accordingly, they did not prepare specialists. The basic principles of this directions can be formulated as follows:

- 1) Learn languages functionally, in terms of using them in different fields of social life: in science, technology, economics, culture;
- 2) summarize the vast practical and theoretical experience of teaching foreign languages for specialists;
- 3) Scientifically substantiate and develop methods of teaching language as a means of communication between professionals, as an instrument of production combined with culture, economics, law, applied mathematics, various branches of science - with those areas that require the use of foreign languages;
- 4) Study languages in a synchronous context, against a broad social, cultural background, the political life of peoples speaking these languages, that is, in close connection with the world of the language being studied;
- 5) Develop a model for the training of foreign language teachers, specialists in international and intercultural communication, and specialists in public relations.

Thus, the motives for learning the language completely changed, in connection with which it was necessary to radically restrict the teaching of foreign languages, introduce the specialty "linguistics and intercultural communication" and start training teachers staff. The main task of teaching foreign languages in Uzbekistan at present teaching language as a real and full-fledged

means of communication. The solution to this applied, practical task is possible only on a fundamental theoretical base. To create such a base, it is necessary: 1) to attach the results of theoretical works on philology to the practice of teaching foreign languages, 2) theoretically comprehend and summarize the vast practical experience of foreign teacher's languages.

Traditional teaching of foreign languages in our country was reduced to reading texts. At the same time, at the level of higher education, philologists were trained at the basis of reading fiction; non-philologists read special texts according to their future profession, and everyday communication, if there was enough time and enthusiasm for both teachers and students, was presented by the so-called everyday topics: in a hotel, in restaurant, post office, etc. Exploring these famous topics in complete isolation and absolute impossibility of real acquaintance with the world of the studied language and practical the use of the knowledge gained was at best romantic, in the worst - useless and even harmful, annoying (the topic "in a restaurant" in food shortages, topics "at the bank", "how to rent a car", "Travel agency" and the like, which have always been the main content of foreign courses of English as a foreign and domestic, written in Western patterns).

Almost exclusively one function of the language was realized - function of a message, an informative function, and even then in a much narrowed form, since from four language skills (reading, writing, speaking, listening) only one developed, passive, oriented towards "recognition" - reading. This misfortune was widespread and had quite clear reasons and deep roots: communication with other countries and their peoples was also, to put it mildly, narrowed, the country was cut off from the world of Western languages, these languages were taught as dead - Latin and Ancient Greek.

Teaching foreign languages based on written texts only reduced the communicative capabilities of the language to the passive ability to understand texts created by someone, but don't create, don't generate speech, but without it real communication is impossible. A sudden and radical change in the social life of our country, its "Discovery" and rapid entry into the world - primarily Western - the community brought languages back to life, made them a real medium of different kinds communication, the number of which is growing day by day along with the growth of scientific and technical means of communication.

Nowadays, this is why at the higher education level, teaching foreign language as a means of communication between specialists from different countries, we do not understand it as a purely applied and narrowly special problem of teaching physics language of physical texts, geologists - geological, etc. A university specialist is a well-educated person with fundamental training. Accordingly, a foreign language of a specialist of this kind is both a tool of production and part of culture, and a means of humanizing education. All this assumes fundamental and versatile language training. The level of knowledge of a foreign language by a student is determined not only direct contact with teacher. In order to teach foreign language as a means of communication, you need to create a real communicative environment, to establish a connection between teaching foreign languages and life, actively use foreign languages in living, natural situations. It can be scientific discussions in the language with the involvement of foreign specialists and without it, abstracting and discussion of foreign scientific literature, reading individual courses in foreign languages, student participation in international conferences, work as a translator, which is precisely about communication, contact, ability understand and convey information. It is necessary to develop extracurricular forms of communication: clubs, circles,

open lectures in foreign languages, scientific societies on interests, where students of different specialties can gather. So, highly specialized communication through written texts is by no means language skills are exhausted as a means of communication, a means of communication.

The maximum development of communication skills is the main one, promising, but very difficult task facing teachers of foreign languages. To solve it, it is necessary to master new teaching methods, aimed at developing all four types of language proficiency, and fundamentally new teaching materials with which you can teach people effectively communicate. In this case, of course, it would be wrong to rush from one extreme to another and abandon all the old methods: from them all the best must be carefully selected, useful, proven by teaching practice. The main answer to the question about solving the urgent problem of teaching foreign languages as a means of communication between representatives of different peoples and cultures is that languages should be studied in an indissoluble unity with the world and the culture of the peoples who speak these languages.

Teaching people to communicate (verbally and in writing), teach to produce, create, and not only understanding a foreign language is a difficult task, complicated by the fact that that communication is not just a verbal process. Its effectiveness beyond knowledge language depends on many factors: conditions and culture of communication, rules of etiquette, and knowledge of non-verbal forms of expression (facial expressions, gestures), the presence of deep background knowledge and much more. Overcoming the language barrier is not enough to be effective communication between representatives of different cultures. To do this, you need to overcome the barrier cultural. In the passage below from an interesting study by I. Yu. Markovina and Yu. A. Sorokin presented national-specific components cultures, that is, exactly what creates the problems of intercultural communication: "In situations of contact between representatives of different cultures (linguocultural communities) the language barrier is not the only obstacle to mutual understanding. Nationally specific features of the most different components of cultural communicants (features that make it possible for these components of the ethno-differentiating function) can complicate the process intercultural communication.

To the components of culture, bearing a nationally specific coloring, you can include at least the following:

- a) Traditions (or stable elements of culture), as well as customs (determined as traditions in the "socionormative" sphere of culture) and rituals (performing the function of unconscious familiarization with the dominant system in this system regulatory requirements);
- b) Everyday culture, closely related to traditions, as a result of which it is often called the traditional everyday culture;
- c) Everyday behavior (habits of representatives of a certain culture, the norms of communication accepted in some society), as well as the associated mimic and pantomimic (kinesic) codes used by carriers of some linguocultural community;
- d) "National pictures of the world", reflecting the specifics of perception the surrounding world, national peculiarities of thinking of representatives of one or another culture;
- e) Artistic culture, reflecting the cultural traditions of one or another ethnos.

The native speaker himself has specific features and culture. In intercultural communication, it is necessary to take into account the peculiarities the national character of the communicants, the specifics of their emotional makeup, and nationally definite features of thinking". In new conditions, with a new formulation of the problem of teaching foreign languages, it became obvious that a radical increase in the level of communication learning, communication between people of different nationalities can be achieved only with clear understanding and real consideration of the sociocultural factor.

Many years of practice of teaching living languages as dead has led to that the aspects of the language were in the shadow, remained unclaimed. Thus, there is a significant gap in the teaching of foreign languages. One of the most important and radical conditions for filling this gap is expanding and deepening the role of the socio-cultural component in development communication skills.

According to American linguist E. Sapir, "every cultural system and every single act of public behavior explicitly or implicitly implies communication ". Thus, we are already talking about the need for a deeper and more thorough studying the world (not the language, but the world) of native speakers, their culture in a wide ethnographic sense of the word, their way of life, national character, mentality, etc., because the real use of words in speech, real speech reproduction is largely determined by knowledge of social and the cultural life of a community speaking a given language. "The language is not existing outside the culture, i.e. outside the socially inherited totality practical skills and ideas that characterize our way of life". Linguistic structures are based on sociocultural structures. Knowing the meanings of words and grammar rules is clearly not enough to actively use language as a means of communication. You need to know how you can deeper the world of the language being studied.

In other words, in addition to the meanings of words and grammar rules, you need to know:

- 1) When to say / write, how, to whom, with whom, where; 2) as a given meaning / concept, this subject of thought lives in the reality of the world of the language being studied. How do concepts such as sociolinguistics relate to each other, linguistic and cultural studies and the world of the target language?

Sociolinguistics is a branch of linguistics that studies conditioning linguistic phenomena and linguistic units by social factors: on the one hand, communication conditions (time, place, participants, goals, etc.), on the other parties, customs, traditions, features of social and cultural life speaking collective. Linguistic and regional studies is a didactic analogue of sociolinguistics, developing the idea of the need to merge teaching a foreign language as a set of forms of expression with the study of social and cultural life native speakers.

Sh. Usmanova and G. Rixsieva, Uzbek linguists have formulated this essential aspect of language teaching as follows: "Two national cultures never completely coincide, - this follows from the fact that each is composed of national and international elements. Aggregates coinciding (international) and divergent (national) units for each pair of compared cultures will be different ... So no wonder that you have to spend time and energy on mastering not only the plan of expression some linguistic phenomenon, but also a content plan, i.e. must be developed in the consciousness of students of the concept of new objects and phenomena that do not find analogy neither in their native culture nor in their native language. Therefore, we are talking about the inclusion elements of regional studies in language teaching, but this is the inclusion of

a qualitatively different kind in comparison with general geography. Since we are talking about connection in the educational process of the language and information from the sphere of national culture, this kind teaching work is proposed to be called linguistic and cultural teaching".

The world of the target language as a discipline inextricably linked with teaching foreign languages, focuses on the study of the aggregate in non-linguistic facts (in contrast to the two previous concepts), that is, those sociocultural structures and units that underlie language structures and units and reflected in these latter. In other words, the scientific discipline "the world of the target language" is based on study of the socio-cultural picture of the world, reflected in the linguistic picture of the world.

The picture of the world surrounding native speakers is not just reflected in the language, it and forms the language and its carrier, and determines the features of speech use. Here why it is impossible to learn the language as a medium without knowing the world of the target language generally. It can be studied as a piggy bank, a way of storing and transmitting culture, then is like a dead language. A living language lives in the world of its speakers, and learning it without knowledge of this world (without what is called differently in different scientific schools: background knowledge, vertical context, etc.) turns a living language into dead, that is, deprives the student of the opportunity to use this language as a means of communication. This, apparently, explains all the failures with artificial languages. Even the most famous of them, Esperanto, does not receive spread and is doomed to die primarily because there is no life-giving soil - carrier culture Relationship between linguistic and regional studies.

"Correlation of the concepts of" cultural linguistics" and "Linguistic and cultural studies" seems to be quite difficult today, and theoretical comprehension is fundamentally important for a number of reasons, primarily because all the growing interest in the problem "Language and culture" makes it is necessary to clarify sources, parameters, research methods, concepts, included in its scope of terminological inventory. Appeal to linguoculturology is not a betrayal of the already traditional the linguistic and cultural aspect of teaching the Russian language, methodological sound the ideas of which we accept, but caused and conditioned, first of all, by the urgent needs and reassessment of some linguo-methodological values of the problem "Language and Culture".

Studying the world of native speakers aims to help understand the features speech usage, additional semantic loads, political, cultural, historical and similar connotations of units of language and speech. Special attention given to realities, since a deep knowledge of realities is necessary for the correct understanding the phenomena and facts related to the everyday reality of peoples, speaking the given language. At the basis of any communication, that is, at the basis of verbal communication as such, lies the "shared code", mutual knowledge of realities, and knowledge of the subject communication between participants in communication: speaking / writing and listening / reading. To understand the linguistic facts of this excerpt from the sketch (not fiction works with his copyright liberties and focus on the function of influence), you need knowledge of realities, socio-cultural background, otherwise understanding the text becomes difficult, and hence, communication.

To clarify the meaning of the following passage from D. H. Lawrence's story, you need to have extensive background knowledge: to know what in a given society is involved in the concept of



"feminine woman", to be able to understand literary and biblical allusions (conditioned by the culture of a given speaking group):

He imagined to himself some really feminine woman, to whom he should be only fine and strong, and not for a moment "the poor little man". Why not some simple uneducated girl, some Tess of the D'Urbervilles, some wistful Gretchen, some humble Ruth gleaning an aftermath? Why not? Surely the world was full of such (Highlighted by me. - S. T.) \*. \* It imagined a truly feminine woman for whom he would always only beautiful and strong, and not at all a "poor little man." Why not some simple, uneducated girl, some kind of Tess D'Urberwills, some languid Gretchen or humble Ruth gathering ears of corn? Why not? Surely the world is full of these. So, in linguistic phenomena, the facts of the social life of a given speaking collective is of importance of studying. Tasks of teaching a foreign language as a means of communication inseparably merge with the tasks of studying the social and cultural life of countries and peoples speaking this language.

There is no human society without culture and there is in each culture a specific capital which links together the members of a particular community. Teaching about one's own culture, like the theoretical endeavor to lift the Globe with a lever, depends critically on the choice of a starting point: if one proceeds from too close, the sweep of force is suspended; if, alternatively, the levering bar is left too far, the object escapes the tool.

#### **THE LIST OF USED LITERATURE**

1. Kramersch, C. 1993. Context and Culture in language teaching. Oxford: Oxford University Press.
2. Lakoff, George and Johnson, Mark. 1998. Philosophy in the Flesh. The Embodied Mind and its Challenge to Western Thought. New York: Basic Books.
3. Michael Byram, Adam Nichols and David Stevens. 2001. Developing intercultural competence in practice. Great Britain.

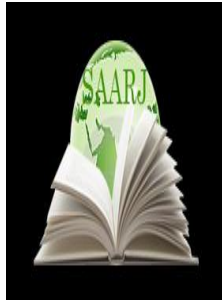

**ACADEMICIA**  
**An International**  
**Multidisciplinary**  
**Research Journal**  
 (Double Blind Refereed & Peer Reviewed Journal)

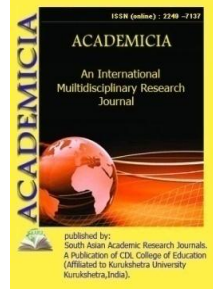

DOI: **10.5958/2249-7137.2021.01007.7**

## **PEDAGOGICAL TECHNOLOGIES OF ENGLISH TEACHING IN A MODERN EDUCATION SYSTEM**

**Dilkhumor Sherzodkizi Israilova\***; **Shaxerizode Solijonqizi Kodirova\*\***;  
**Arofat Ibroximqizi Shorasulova\*\*\***

\*EL Instructor,  
 Department of English Philology,  
 Foreign Philology Faculty, National University of UZBEKISTAN  
 Email id: isradil90@gmail.com

\*\*Lecturer,  
 National University of Uzbekistan named after Mirzo Ulugbek,  
 UZBEKISTAN  
 Email id: kadirova.sh.s@gmail.com

\*\*\*Lecturer,  
 National University of Uzbekistan named after Mirzo Ulugbek,  
 UZBEKISTAN  
 Email id: arofatshorasulova@gmail.com

### **ABSTRACT**

*As time goes on, people and their needs and requirements will change. This is an axiom that does not require proof. We can observe the same historical process in the study of foreign languages, as well as in various aspects of our lives. Thousands of years ago, the need and interest in foreign languages such as Arabic and Persian developed in our country, our great scholars organized their scientific research in these languages, and our ancestral poets and writers created masterpieces in these languages and left an immortal legacy.*

**KEYWORDS:** *Pedagogical technologies, English, Modern education system.*

### **INTRODUCTION**

All this is the need of that time, the demand of that time. So what is the state of the state's language policy today, in the first quarter of the 21st century? What is the impact of global development, new discoveries, especially the Internet, on language learning? Which foreign

languages should we pay more attention to in the 21st century, and for what purpose? By the way, the development of the period, the process of globalization taught several foreign languages to young people requires them to know. Based on these needs, the Resolution of the President of the Republic of Uzbekistan dated December 10, 2012 "On measures to further improve the system of learning foreign languages" laid the foundation for a new stage in the policy of teaching foreign languages in the Republic.

### **THE MAIN RESULTS AND FINDINGS**

The main goal of the system of continuing education is to train highly spiritual, competitive and intellectually gifted specialists. Following the implementation of this decision, the process of applying modern pedagogical technologies in the education system has become widespread. Today, scientific and technological progress requires the introduction of new modern technologies in all areas, including education. Therefore, the National Program of Personnel Training emphasizes the need to provide the educational process with advanced pedagogical technologies, and new models of education are being created. Research conducted by the authors in Uzbekistan has shown that citizens of a free, enlightened and democratic state should have the following social qualities: · Smart - able to think independently; · Politeness - has all the qualities of our nation; · Hardworking - labor has become a social need; · Knowledge - the ability to acquire a large and deep knowledge of religious, secular and cosmic knowledge and apply them in life; · Healthy - physical, mental and social health; · National pride - possessing the material and spiritual heritage of our ancestors, being proud of them and contributing to their enrichment; · Patriotic - a person who works selflessly for the Motherland, for the people, who is able to protect them and, if necessary, sacrifice his life for them; · Humane - one who wishes only good to the human race and does good deeds for them. · Brave and courageous - one who bravely enters into every task and completes it with courage. These ten social qualities stem from the needs of society are state orders and should be used by everyone working in the field of education as a common methodological framework. Achieving the goals Scientists of the Republic R.Kh. Jorayev, U.N. Nishonaliyev, A.A.Parpiyev, N.S. Saidakhmedov, MVKlarin, M.Dadahojayev, as well as Kazakh scientists MJAristanov, JSKHaydarov in their research tried to explain the essence and significance of the concept of "pedagogical technology". The introduction of advanced pedagogical technologies in the education system of the Republic of Uzbekistan will further enrich the content of the training process in the educational institutions of our country and bring it into line with world standards, as well as the ideology of independence, Uzbek folk pedagogy and national identity. Became the basis for the creation of mother-specific and appropriate pedagogical technology. The demand for learning foreign languages has become a necessity at the same time. Changes in the socio-economic spheres of the country, rapid development require the introduction of new pedagogical technologies in the educational process, the need to find and apply modern methods of language teaching in the educational process.

Research conducted by the authors in Uzbekistan has shown that citizens of a free, enlightened and democratic state should have the following social qualities: · Smart - able to think independently; · Politeness - has all the qualities of our nation; · Hardworking - labor has become a social need; · Knowledge - the ability to acquire a large and deep knowledge of religious, secular and cosmic knowledge and apply them in life; · Healthy - physical, mental and social health; · National pride - possessing the material and spiritual heritage of our ancestors,

being proud of them and contributing to their enrichment; · Patriotic - a person who works selflessly for the Motherland, for the people, who is able to protect them and, if necessary, sacrifice his life for them; · Humane - one who wishes only good to the human race and does good deeds for them. · Brave and courageous - one who bravely enters into every task and completes it with courage. These ten social qualities stem from the needs of society are state orders and should be used by everyone working in the field of education as a common methodological framework. Achieving the goals Scientists of the Republic R.Kh. Jorayev, U.N. Nishonaliyev, A.A.Parpiev, N.S. Saidakhmedov, MVKlarin, M.Dadahojayev, as well as Kazakh scientists MJAristanov, JSKhaydarov in their research tried to explain the essence and significance of the concept of "pedagogical technology". The introduction of advanced pedagogical technologies in the education system of the Republic of Uzbekistan will further enrich the content of the training process in the educational institutions of our country and bring it into line with world standards, as well as the ideology of independence, Uzbek folk pedagogy and national identity. Became the basis for the creation of mother-specific and appropriate pedagogical technology. The demand for learning foreign languages has become a necessity at the same time. Changes in the socio-economic spheres of the country, rapid development require the introduction of new pedagogical technologies in the educational process, the need to find and apply modern methods of language teaching in the educational process.

Leading scholars and methodologists have sought modern pedagogical technologies, methods and techniques of foreign language teaching.

The advantage of teaching a foreign language on the basis of pedagogical technology over previous methods is, firstly, that it considers the educational process as a whole, the purpose of education, its content, methods and means of teaching, design the stages of education, control the educational process and in the design of its project, bringing its components, such as the evaluation of learning outcomes, into an interdependent system. Second, it is not about students memorizing the knowledge they have been given, but about doing practical work at the end of the teaching and learning process. Pedagogical technology is the system that, based on the needs of society, effectively defines the social qualities of a predetermined person and sees it as a system of goal-oriented learning process. Is a technology-based educational activity that monitors the impact of a teacher (educator) on students in a particular sequence in a given setting and evaluates learning outcomes using teaching aids. Technology is derived from the Greek word "techne", which means skill, art and "logos" - the word, the meaning of education, and an ambiguous translation of the English word "an education technology". It should actually be translated as "Educational Technology". The introduction of technology into education has been going on for centuries. Until the late 50s, pedagogical technology was associated with the creation of a technical environment for traditional education, the construction of a set of automated tools. Today, educational technology is considered as a field of pedagogical sciences. Human psychology plays an important role in the development of technology. Historically, educational technology has operated and evolved tactically. Technology is a set of knowledge about the methods and means of implementation of processes, as well as the qualitative changes that occur at the facility. Educational technology is a set of concepts that includes: - Have an idea of the planned results; - A diagnostic tool to help learners determine their current status; - A set of training models; - Criteria for selecting the optimal model for specific conditions. Pedagogical methods do not depend on the tools used. Even the method, which is considered the best

technology, if it does not give a positive result, it is not a good way. Conversely, a simple question-and-answer method can significantly increase the effectiveness of education. There are specific aspects of the teaching process in the education system, and the guarantee of effective results is mainly based on pedagogical technologies.

In order to shed light on the essence of pedagogical technology, we consider it expedient to dwell on the definitions given by pedagogical didactics. "Pedagogical technology is a consistent method of creating, implementing and defining all processes of teaching and learning in technical and human factors and through their joint efforts, aimed at accelerating the forms of education" (UNESCO). "Pedagogical technology is the process by which a teacher (educator) influences students through the use of teaching (educational) tools under certain conditions, and as a product of this activity, the intensive formation of pre-defined personality traits in them." "Pedagogical technology is a social phenomenon that intensively shapes the pre-defined social qualities that are necessary for society as a result of the systematic influence of the teacher on students in certain conditions with the help of teaching aids." "Pedagogical technology as a factor in managing the pedagogical process has the following meaning: PT - organization of the educational process on the basis of design, features that guarantee its effective results, (pedagogical skills, pedagogical tact, pedagogical style, pedagogical accuracy) innovative features of pedagogical activity, high professionalism-acmeology, analytical and critical approach-reflection) is a systematic category that fully determines the creation and implementation of new forms and methods of education. Methodological qualities of pedagogical technology include: - Technological scheme; - Scientific basis; - Systematic; - Management; - Efficiency; - Repetition.

A new modern approach to the application of new technological processes and new modern methods of teaching in the educational process. The purpose of foreign language teaching is not only to educate students and develop certain, speaking skills, but also to development, increasing interest in the foreign language they are learning, activating the internal capacity of their memory, and building students' confidence in their own power. As you know, the educational process is complicated. Foreign language lessons include the stages of developing relevant speaking skills through the presentation of new learning material, its practice through a variety of exercises, and its application to a variety of speech situations. A number of interactive methods can be used to increase student engagement in the classroom. The term interactive method is derived from the English word "interactive", which means to increase students' internal activity. There are a number of types of this method, some of which are currently widely used interactive methods such as "brainstorming", "business games", "pinboard", "cluster", "sinkway", "cubic technology", role-playing games. Appearances are aimed at increasing the activity of students in the educational process. In interactive teaching, group teaching, small groups of 3-5 people are effective. Summarizing the above, it can be called "INNOVATIVE TECHNOLOGY". Innovative technology is a way to improve knowledge through the use of factors that increase the effectiveness of education, the design and implementation of various pedagogical processes. Its main purpose is to make innovations and changes in the activities of teachers and students in the educational process, which requires the use of interactive methods. Interactive methods are based on the active, free and independent thinking of each learner involved in the learning process. Using these methods, learning becomes a fun activity. When using interactive methods, the ability to work independently develops.

It is known that today there are more than a hundred types of interactive methods, most of which have been tested and given good results. The main conditions for the introduction of educational technologies in the educational process are: - The development of free communication of each student in the acquisition of knowledge in the teaching process; - The main focus in the educational process is to increase the activity of the learner and the use of methods and modern teaching aids that increase the activity in the classroom. Classes conducted on the basis of pedagogical technology nurture the desire of young people to express their attitudes to important life achievements and problems, give them the opportunity to think, to justify their views. Pedagogical technologies are innovations and changes in the pedagogical process and the activities of teachers and students, in the implementation of which mainly interactive methods are used. In interactive lessons, the teacher directs the activities of students to the purpose of the lesson. The peculiarity of these methods is that they are carried out only through the joint work of teachers and students. The process of such pedagogical cooperation has its own characteristics, such as ensuring that the student is not indifferent during the lesson, independent thinking, involvement in creativity and research, and the continuity of interest in science in the educational process, the teacher and ensures that student collaborative activities are organized on a regular basis. The main basis of pedagogical technology is the joint achievement of the teacher and the student from the set goal to the guaranteed result. Each lesson, topic, subject has its own technology. Pedagogical technology in the learning process is an integrated process in a clear sequence, which is focused on a single goal, carefully designed and guaranteed results, based on the needs and interests of the student. Pedagogical technology, in general, is based on reproductive (copying) teaching, in which the learning process allows students to master the actions of typical situations directed. A distinctive feature of pedagogical technology is that it designs and implements the learning process that ensures the achievement of learning objectives. The technological approach is primarily expressed in a practical instructional structure that allows the implementation of the designed results, rather than a description. The main way to understand pedagogical technology is to focus on clearly defined goals, to establish regular interaction with the learner, to teach through the learner's behavior, which is the philosophical basis of pedagogical technology.

## CONCLUSION

Interaction should form the basis of pedagogical technology and fully cover the learning process. In the process of reproductive education in pedagogical technology, the lesson is divided into specific sections, each of which shows the results that students need to know. Modern pedagogical technology cannot be considered as a separate branch of pedagogical science or as a system aimed only at optimizing educational practice. Pedagogical technology reflects the activities within the framework of combining theoretical and practical research in this area. Today, with the development of science and technology, the boundaries of human activity are expanding exponentially, new technologies are entering. Qualitative changes indicate that there are new technical, informational, audiovisual, audio tools that require new methods and introduce a certain feature of it, which is becoming an integral part of the educational process. Becomes a reality.

**REFERENCES:**

1. Mardievna, B. M., Mukhamadjanovna, J. S., Nematovich, N. O., & Azamovich, T. V. (2020). The importance of modern methods and technologies in learning English. *Journal of critical reviews*, 7(6), 143-148.
2. Bolibekova, M. M., & Elmuratova, N. X. (2021). The Structural and Functional Features of Polysemy In The Process Of Translation in the Uzbek and English Languages. *Journal of Contemporary Issues in Business and Government*, 27(1), 424-433.
3. Bolibekova, M. M., Juraeva, I. A., Kakharova, N. I., & Nazarova, D. O. (2021). Methods of Achieving High Effectiveness in Foreign Language Teaching. *Journal of Contemporary Issues in Business and Government*, 27(1), 370-379.
4. Nematov, O. (2020). CRYPTOGRAPHICAL METHODS OF INFORMATION PROTECTION. DEVELOPMENT STEPS OF CRYPTOGRAPHY. In *Молодой исследователь: вызовы и перспективы* (pp. 355-361).
5. Nazarov, A. Y. (2021, February). Classification Of Documents Of Turkestan Scientific Societies Kept In The National Archive Of Uzbekistan. In *INTERNATIONAL SCIENTIFIC AND CURRENT RESEARCH CONFERENCES* (pp. 9-12).
6. Sharei, S., Yazdanmehr, E., & Firoozian Pour Esfahani, A. (2017). Translation of anthroponyms in children's cartoons: A comparative analysis of English dialogues and Persian subtitles. *Journal of Language and Translation*, 7(4), 21-31.
7. Nazarov, A.Y. (2016). Organization of the use of documents of the Central State Archive of Cinema, Photo and Sound Documents of the Republic of Uzbekistan. Document. Archive. History. Modernity. — Yekaterinburg, 2016, 484-489...



**ACADEMICIA**  
**An International**  
**Multidisciplinary**  
**Research Journal**  
(Double Blind Refereed & Peer Reviewed Journal)

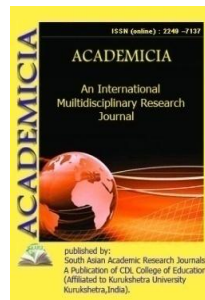

DOI: **10.5958/2249-7137.2021.01008.9**

**USE OF E-LEARNING RESOURCES IN FOREIGN LANGUAGE  
LESSONS AND REQUIREMENTS TO IT**

**Mavjuda Mardievna Bolibekova\*; Dilkhumor Sherzodkizi Israilova\*\***

\* PhD, Associate Professor,  
National University of UZBEKISTAN  
Email id: Mbolibekova1970@mail.ru

\*\*EL Instructor,  
National University of UZBEKISTAN  
Email id: isradil90@gmail.com

**ABSTRACT**

*Extensive work is being done in our country on the use of pedagogical and information technologies in the educational process. The scientific and theoretical basis of this problem, the specifics of each pedagogical technology have been developed and sufficient experience has been accumulated. Relevant organizations of foreign countries are closely assisting in the introduction of pedagogical and information technologies in the educational process. It is known that in the implementation of this direction was focused on the study of the first foreign language.*

**KEYWORDS:** *E-learning resources, foreign language lessons, requirements.*

**INTRODUCTION**

The use of the media in the study of a foreign language, especially English, and the development of programs in it also give results in the implementation of the requirements. Of course, all this is a modern program with a set of facilities that can be used in the learning process. An analysis of modern educational e-publications has shown that they have a complex structure and need to be classified. The classification of e-learning publications is based on the general methods of classification of both educational and electronic and software tools. The main type of learning process is the lecture. A lecture is a form of organization of the educational process, which forms the knowledge that is the guiding basis for the learning material to be mastered by students.



---

## THE MAIN RESULTS AND FINDINGS

There are three main types of lectures: introductory lectures, informational lectures and review lectures. Depending on the subject and didactic purposes, the following forms of lectures can be used: problem lectures, visual lectures, press-conference lectures, etc. Electronic educational publications used in lectures should enrich the narrated material with videos, audio animations, help the speaker to demonstrate complex processes. The following types of electronic textbooks can be used to organize the study of theoretical material:

- Video lecture. The lecture is recorded with the help of a video camera. The advantage of this type of lecture is that it can be heard over and over again and can be stopped in difficult places.
- Multimedia lectures. Interactive educational programs can be created for independent learning. When using such textbooks, each student can learn a trajectory that is convenient for him, the optimal pace of learning. And can choose the method. The mastery rate can also be increased in many ways by means of controls.
- Traditional publications: electronic lecture texts, basic abstracts, manuals for studying theoretical material, etc. Students' independent education based on information technology includes: work with electronic textbooks, watching video collections, listening to audiocassettes, working on computer simulators, computer testing, etc. [2, 21]. At present, all types of knowledge control can be carried out on the basis of specially developed computer programs with the help of e-learning publications. In particular, the use of e-learning publications in the current and intermediate control system is highly effective. Computer test programs are not only a means of self-monitoring for learners, but also take on the role of current and intermediate control. Such a test program can be an independent program that cannot be changed, or it can also be a modified shell program supplemented by an anthill. Teaching practice is important in history education. The computer serves as a tool for simulation models, simulators. With the help of computer programs can be organized trainings on archeological excavations, collection of ethnographic materials, reconstruction of monuments, and acquaintance with archival documents. Computerization of archives and museums Educational-methodical complexes play an important role among the electronic means of education. OUMs contain theoretical material as well as practical tasks, tests, applications, etc. OUMs can be presented as digital and analog multimedia courses consisting of structured and logically connected didactic elements. Modern educational multimedia course - video and not only text-based interactive material enriched with audio materials, but also educational materials should be placed in different forms and on different media. The multimedia course is a means of complex interaction with the learner through illustrative, informative, simulative and control parts. The basis of OUM is its interactive part. This part is realized only on the computer. It includes: -electronic textbook; - electronic reference book; - training complex; - a set of examples and problems; - electronic laboratory practicum; - computer test system. The e-textbook is designed for independent study of theoretical material, and its hypertext structure allows you to work with an individual educational trajectory. An electronic chrestomathy is a collection of texts that complements a textbook. The chrestomathy may include documents, works of art, and excerpts from them. The methodical instructions, which explain the features of the texts included in the chrestomathy, are important for the reader. These guidelines provide a link between the text and the study material and guide students in preparing for the workshop. The e-reference allows the user to quickly receive the necessary information in a compact form at any time. Typically, an e-reference consists of a list

of terms, and each element of the list is hyperactive, ie as a result of its activation, a hyperlink with the content, translation or interpretation of the term is referenced. Is a necessary condition. Internet resources in history education. The number of Internet resources on the Internet is growing among e-learning publications. The number of Internet resources on historical topics is also increasing. Gradually, databases of historical resources, special directories and search engines have emerged. Working with network scientific and educational resources has its own characteristics and requires skills in working with the network, browsers, and knowledge of how to search, process and store information on the Internet. A historian who wants to work on the Internet the first problem is the problem of information retrieval. The next challenge is to determine if the resources found are suitable for educational use. There are many historical resources that cannot be tested for compliance with state education standards. In the process of studying a voluntary course, there may be a problem that the textbook obtained from the Internet does not correspond to the curriculum of the educational institution. The information obtained from the Internet is very diverse in nature, the software needed to process it and there are many formats of text, graphics, and audio-video information. We will consider some ways to solve these problems. What to look for? - In answering this question, the historian in his educational activity refers to the curriculum.

## CONCLUSION

It is also useful to identify the nature of information that differs in structure, type of presentation, purpose, and form of presentation. How do I search? - To find the necessary information on the Internet, you need to search for resources that contain this information. Such information can be found in the databases of search engines, search directories. The main Russian search engines include rambler, yandex, apart, google. In such systems, the search is based on queries expressed in the form of text. In practice, it is advisable to use more than one search engine, because the databases of search engines are different from each other. Special historical directories can exist as part of a search, information or research resource, or as an independent resource. Unlike search engines, directories are more likely to live up to the expectations of users because the search is done within materials on a pre-selected topic. The role of basic multimedia devices in foreign language teaching is significant. In the implementation of these processes, visual materials and audio devices further strengthen the activation of the learning process. Although the development of technology in the teaching of multimedia means, that is, the beginning of the twentieth century, we can see that the effectiveness of its results is satisfactory.

## REFERENCES

1. Mardievna, B. M., Mukhamadjanovna, J. S., Nematovich, N. O., &Azamovich, T. V. (2020). The importance of modern methods and technologies in learning English. *Journal of critical reviews*, 7(6), 143-148.
2. Bolibekova, M. M., &Elmuratova, N. X. (2021). The Structural and Functional Features of Polysemy In The Process Of Translation inthe Uzbek and English Languages. *Journal of Contemporary Issues in Business and Government*, 27(1), 424-433.
3. Bolibekova, M. M., Juraeva, I. A., Kakharova, N. I., &Nazarova, D. O. (2021). Methods of Achieving High Effectiveness in Foreign Language Teaching. *Journal of Contemporary Issues in Business and Government*, 27(1), 370-379.

4. Nematov, O. (2020). CRYPTOGRAPHICAL METHODS OF INFORMATION PROTECTION. DEVELOPMENT STEPS OF CRYPTOGRAPHY. In *Young Researcher: Challenges and Prospects* (pp. 355-361).
5. Nazarov, A. Y. (2021, February). Classification Of Documents Of Turkestan Scientific Societies Kept In The National Archive Of Uzbekistan. In *INTERNATIONAL SCIENTIFIC AND CURRENT RESEARCH CONFERENCES* (pp. 9-12).
6. Sharei, S., Yazdanmehr, E., & Firoozian Pour Esfahani, A. (2017). Translation of anthroponyms in children's cartoons: A comparative analysis of English dialogues and Persian subtitles. *Journal of Language and Translation*, 7(4), 21-31.
7. Nazarov, A.Y. (2016). Organization of the use of documents of the Central State Archive of Cinema, Photo and Sound Documents of the Republic of Uzbekistan. Document. Archive. History. Modernity. — Yekaterinburg, 2016, 484-489.



**ACADEMICIA**  
**An International**  
**Multidisciplinary**  
**Research Journal**  
 (Double Blind Refereed & Peer Reviewed Journal)

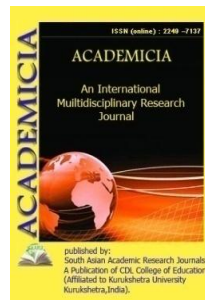

**DOI: 10.5958/2249-7137.2021.01009.0**

**THE PROBLEM OF STUDYING THE ADAPTIVE SYSTEMS OF  
 CHILDREN'S BODIES UNDER THE INFLUENCE OF  
 ENVIRONMENTAL FACTORS IN THE SOUTH ARAL SEA REGION**

**N.P. Mirametova\*; U. Azilova\*\*; Q. Abdullaev\*\*\*; S. Kamalova\*\*\*\***

\*PhD in Biological Sciences,  
 Nukus State Pedagogical Institute Nukus, UZBEKISTAN

\*\*Master student,  
 Nukus State Pedagogical Institute Nukus, UZBEKISTAN

\*\*\*Student,  
 Nukus State Pedagogical Institute Nukus, UZBEKISTAN

\*\*\*\*Student,  
 Nukus State Pedagogical Institute Nukus, UZBEKISTAN

**ABSTRACT**

*The article analyzes the results of a study of the adaptive systems of the body on the example of the physical development of children under the influence of environmental factors in the South Aral Sea region. The data obtained on the state and growth dynamics of girls make it possible to conclude that they do not have noticeable differences depending on the area of residence. A general regularity was revealed - some lag in the growth of the body of children living in different regions of the Aral Sea region.*

**KEYWORDS:** *Children's population, Physical development, Pesticide load, Environment.*

**INTRODUCTION**

In the world, the problem of environmental protection in the interests of preserving human health, in particular, reducing the influence of the negative consequences of exposure to harmful factors, remains a fundamental task of environmental research. In recent decades, the state of the air environment, water sources, and soil has become the most ecologically unstable. The quality of human health primarily depends on the quality of the environment in which he lives. The most urgent problems of environmental pollution in industrial centers, where more than 50% of environmentally hazardous areas are concentrated. The most serious consequences of the Aral

Sea catastrophe can be considered as the pollution of the natural environment under the influence of anthropogenic factors, which has led to widespread salinization of soils used in agriculture.

The main factors that transform the natural environment are a decrease in water supply to the territory, an increase in land salinity and a general aridization of conditions. The reason for the activation of these processes over the past 30 years was the coincidence of poor regulation of the water use system and the rapid increase in the scale of land use.

The drying up of the Aral Sea has changed the climatic situation in the region. Initially, the Aral Sea was a kind of temperature and humidity regulator [4, 5]. The main elements of the climate that determine the intensity of physical evaporation, transpiration, the degree of moisture, the recurrence of droughts, and the deflation of sandy loamy-sandy substances are air and soil temperature, precipitation, air humidity, drought, and wind. The dried-up bottom of the Aral Sea now extends over 4.5 million hectares. Two thirds of this area is salt marshes, saline sands and soils. According to experts, the drained bottom of the Aral Sea has turned into a powerful source of salt and dust removal. From this area, in all directions from the Aral Sea, annually up to 75 million tons of sand and dust are carried out. In recent years, there has been an increase in dust storms in the region by 4-10 times [2, 10]. At the same time, a significant part of aerosols of marine origin is contained in the atmosphere layer up to 1000 m; above 2500 m, such particles are practically absent. As you know, the smallest particles of salt and dust at low speeds can be transported over long distances, and larger particles fall out at a short distance from the source of removal [2].

### **THE MAIN FINDINGS AND RESULTS**

In the soils of Karakalpakstan, organochlorine pesticides are detected mainly hexachlorocyclohexane (HCH). From a soil sample contaminated with pesticides, 10 indigenous cultures of microorganisms - active destructors of HCH were isolated and a series of experimental works was carried out to identify the ratio of the isolated crops to various concentrations of lindane (250, 500, 750, and 1000 mg / l). It was found that the maximum amount of pesticides (by assortment) was used in 1990 (41 items), the lowest amount in 1992 (13 items in total). The most intensive use of pesticides in Karakalpakstan was observed in 1987. Then more than 3 thousand tons of 100% of the active ingredient were introduced into the external environment [6, 9].

As you know, physical development is one of the indicators of the health of the child population. Growth and body weight indicators are an important indicator of the physical development of children and adolescents [3, 8]. They are used to assess and interpret the health status of the child population. The growth and development of children remain the main indicators of their health status. Changes in growth processes, the ratio of the child's body weight and length, growth arrest are the main or even the only manifestations of chronic diseases [3]. At the same time, the physical development of children serves as the basis for predicting pathology.

Despite numerous studies on the problems of studying the adaptive systems of modern children, however, a number of issues were not discussed, or were not considered comprehensively, in a narrow range of ontogenesis. In recent years, most of the works of modern researchers are devoted to the physical development of children [1, 8], and the results of complex functional studies are much less represented.

The physical development of children and adolescents is currently being studied in various directions, and one of the topical problems continues to be the study of its features in unfavorable environmental conditions of residence, for example, in the Southern Aral Sea region. The least studied are the issues of individual variability of growth processes. At the same time, the study of the physiology of growth seems to be very important, especially in the case of deviations from the average indicators of body length, since lagging, and sometimes acceleration of growth rates can be the only symptoms of a fairly wide range of diseases [7].

The term “physical development” is usually understood as a complex of functional indicators, which determines the stock of physical strength of the body and its functional reserves [1, 3]. With regard to children, the concept of physical development should be expanded by assessing the processes of growth and development of the body, therefore, physical development in this case is understood as a complex of morphological and functional signs that characterize the age level of a child's biological development. There are two known periods of increasing growth rate: the first falls on the period from 4 to 7 years, the second - at a later period: for girls 10-11.5 years old, and for boys 13-15 years old. The first increase in the growth rate is called the half-growth jump the second is called the pubertal jump [3, 8].

A significant increase in body weight in boys and girls is noted during puberty. During this period (from 10 to 15 years old), the body weight of girls is greater than the body weight of boys, and from 15 years old, the rate of weight gain in boys is higher. Boys experience the most intense weight gain between 4-5 and 12-15 years of age. In girls, the most intense weight gain is observed between 4-5 and 10-11 years. The data of official statistics and scientific research indicate that negative trends in the change in demographic indicators in the Republic of Uzbekistan, including the health status of the child population, persist.

The least studied is the nature of the manifestation of the morphological and functional characteristics of the development of children with different growth rates living in different regions of the South Aral Sea region (by the example of the Republic of Karakalpakstan), which is characterized by a peculiar ecological background. Knowledge of the individual capabilities of a child and predicting his ontogenesis is a necessary prerequisite for successful education and upbringing without prejudice to health.

It is known that linear, volumetric and other parameters of an organism are closely related to its functional characteristics. Parameters such as height, body weight, age and gender are the argument, and the basal metabolic rate is their function [1]. Therefore, it is very important to know the dynamics of height and weight - the main indicators of a child's development.

When analyzing the annual anthropometric indicators, we came to the following results. At the age of 6, regardless of where they live, girls are slightly lower than the standard values (Fig. 1). As can be seen from the diagram, the growth of girls 6-8 years old from the southern regions slightly exceeds the growth of girls from the northern regions. The trend line is also similar for the two groups of indicators. The normative data are 111-120 cm, and in relation to them, the growth of girls is less by 4 and 6%, respectively, in the indicated areas. The increase in body length by the age of 7 was 7.3 cm, which, although it is within the limits of the existing norms, in spite of this, the growth of the body still remains closer to the lower limit of the physiological norm. The indicated dynamics persists annually throughout the analyzed period of the growth of

children, i.e. all years up to 10 years. By this age, the lag in body length in relation to the standard values was 4 and 6%, respectively, in the two surveyed groups.

The data obtained on the state and growth dynamics of girls make it possible to conclude that they do not have noticeable differences depending on the area of residence. There is a general pattern - some lag in the growth of the body. The body length values of girls correspond to the minimum standard age indicators (Fig. 1). The annual increase in body length also corresponds to the lower limit of the norm. Probably, in this regard, attention should be paid to the height values of girls at 6 years of age. With normative values from 111 to 120 cm, the indicators for the southern regions are lower by 4%, and for the northern regions - by 6%.

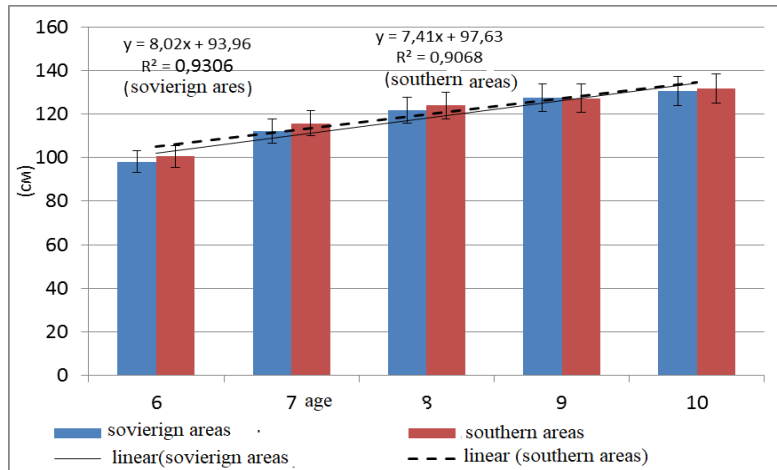

**Fig. 1 Growth rates of girls (cm) living in different areas South Priaralie ( $M \pm m$ )**

The obtained values of the height of boys from 6 to 10 years old are presented in Fig. 2, from which it follows that they are somewhat lower than the existing normative ones. As can be seen from the diagram, the most pronounced lag is traced among children born and living in the southern regions (group 2). As for boys from group 1 (northern regions), there are no noticeable differences in years between them. Growth retardation is traced as a general pattern and ranges from 5 to 8% (respectively). As for the value of the annual increase in body length, it is for children from the northern regions within the existing age norms, and for boys from the southern regions, it is mainly below it. By the age of 10, the body length of boys from the southern regions is below the standard by 13% and less than the minimum value - 141.8 cm (norm 155-170 cm).

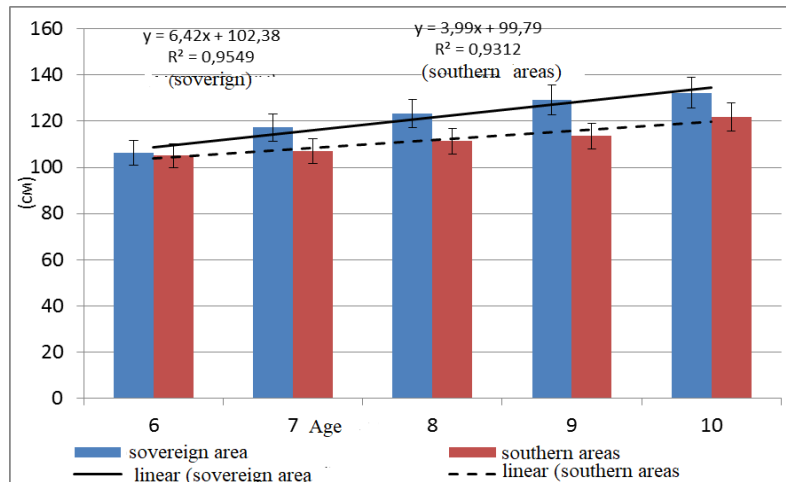

**Fig. 2. Growth rates of boys (cm) living in various regions of the Southern Aral Sea region ( $M \pm m$ )**

Attention is drawn to the initial inconsistency of the body length in boys with the existing norms, that is, by the age of 6. The gap was 13% in the southern regions and 7% in the northern regions, respectively.

## CONCLUSION

Summarizing the data obtained on the anthropometric indicators of children from different regions of the Southern Aral Sea region, which differ in the degree of environmental pollution, it can be noted that there are no significant differences in gender in the development of body length between children from the northern regions of Karakalpakstan. Boys from the southern regions are an exception. They have deviations in growth, which is below the average values of the norm by 13-16% (from other regions by 4-9%). A possible reason for this is the fact that the value of the annual body gain at the age of 7, 8 and 9 years is less than the existing normative ones.

The very dynamics of the processes of growth and development of children from different regions of the Aral Sea region differs little from each other and from the normative indicators, corresponding to their low values. The existing differences in age values from the normative ones are related, in all likelihood, to the peculiarities of the early period of ontogenesis, which lead to the above characteristics of the growth and body weight indicators of children and adolescents born and living in the Aral Sea region. When developing modern problems of adaptation and solving problems in the field of preserving the health of the younger generation, at least a three-dimensional assessment system is needed, which should include medical and biological, environmental and social criteria.

## REFERENCES

1. Alekseev S.V. Human ecology - a systematic view of the process of health formation. Bulletin of the Russian Academy of Medical Sciences Moscow: Medicine, 2002. №7. P. 3.
2. Arushanov M. L, Tleumuratova B. S. Dynamics of ecological processes in the Southern Aral Sea region. // Hamburg: Palmarium. – 2012. – P. 183.



3. Gubareva L.I., Ermolenko G.V. Physical development of adolescents and microelementosis // Stavropol, 2005-P. 38-40.
4. S.K. Kabulov The climatic effect of the desiccation of the Aral Sea // Bulletin of the KCO A RUz.-1997.-No.4- P.5-12.
5. Konstantinova L.G., Kurbanov A. B., Atanazarov K. M. Drinking water quality, health status of the population and prognosis of morbidity in the Republic of Karakalpakstan // Environmental factors and health of mothers and children in the Aral Sea crisis region: Proceedings of the Intern. Seminar. -Nukus: Science, 2001. -P. 87-95.
6. Kurbanov A.B., Eshchanov T.B., Ibragimov M.Yu., Konstantinova L.G., Temirbekov O., Kosnazarov K.A. Hygienic assessment of pesticides used in the Republic of Karakalpakstan. - Nukus. -Knowledge. - 2002. - P. 75.
7. Mambetullaeva S.M., Kamalova G.N., Atadzhanova A. Analysis of the influence of negative environmental factors on the incidence rate of the population in the conditions of the Republic of Karakalpakstan // Bulletin of the KCO AN RUz.-2011. -№ 1. -P. 41-42.
8. Maturazova E.M. Characteristics of indicators of the blood and circulatory system in children in the conditions of the Southern Aral Sea region – Author’s abstract. Cand. diss. – Tashkent:, 2008.- P.16.
9. Nishankhodzhaeva S.A., Toryannikova R.S., Konstantinova L.G. Potential sources of environmental pollution in the Southern Aral Sea region // Medico-ecological problems of the Aral Sea region and public health: - Nukus: 1991. - P. 23-26.
10. Tleumuratova B.S. Influence of salt and dust transfer on sedimentation in the Aral Sea region // Arid ecosystems. – 2009. –Volume 15. – № 3(39). – P.28-35.



**ACADEMICIA**  
**An International  
 Multidisciplinary  
 Research Journal**  
 (Double Blind Refereed & Peer Reviewed Journal)

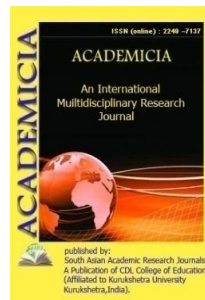

**DOI: 10.5958/2249-7137.2021.01010.7**

## CUSTOMS AND CEREMONIES OF POPULATION OF JIZZAKH OASIS ASSOCIATED WITH THE BIRTH OF CHILD

**Jumanazarova Dilnoza\*; Davlatova Khakima\*\***

\*Assistant Professor,  
 Jizzakh State Pedagogical Institute,  
 UZBEKISTAN

\*\*1st course of Magistrate,  
 Teaching methods of Socio-humanitarian Sciences,  
 Candidate of Pedagogical Sciences, Jizzakh State Pedagogical Institute,  
 UZBEKISTAN

### ABSTRACT

*In this article customs and ceremonies of population of Jizzakh oasis associated with the birth of child comparatively analyzed by field ethnographic researches, personal experiences, sociological questionnaires and scientific publications on the subject. As well as, ethnocultural features of customs and ceremonies of population of Jizzakh oasis associated with the birth of child were pointed.*

**KEYWORDS:** *Tradition, Custom, Ceremony, Chilla, Chilla dress, Belly hair, Navel, Umbilical cord, Omai mother, Cradle wedding.*

### INTRODUCTION

Practical works are being done for restoring ancient history and rich cultural heritage of people during the years of Independence in Uzbekistan and delivering them to the world. In this regard, with another historical ethnographic regions of Uzbekistan Jizzakh has also an important role, geographical and natural advantages had been reasons to forming of different cultures and traditions during thousand years. Furthermore, spiritual and material culture of population of the region has some local exceptions which are the product of historical and ethnocultural processes that have taken place in the region over many years.

Variety family and community ceremonies which are held in Uzbekistan distinguish with common and private features. When analyzing comparatively on a Republican scale, although

ceremonies and customs which are held in all regions look similar, there are some specific situations where this process is based on the peculiarities of the population's way of life, daily activities, aspirations and attitudes related to local traditions. This is because the emergence of traditions, customs and rituals and their important place in the social and religious life of the people is a complex process and is influenced by several factors. That is, national identity is based on socio-economic, political processes, natural and geographical location, mutual ethnocultural relations, religious affiliations of a long historical period, and it is on the basis of the spiritual and psychological views of the people, ancient traditions and customs [Ashirov A. 2014. 189 p].

Family ceremonies organized by the people of the Jizzakh oasis have both common Uzbek and private aspects.

While all activities from birth to death are called lifelong rites, in social anthropology they are called passage rites.

According to French ethnologist A. VanGennep, passage rites divided into two groups:

- a) Rituals related to the time of birth, puberty, engagement, marriage and death, which the transition to a certain stage of life.
- b) Seasonal ceremonies marked by changes in the Moon, the Sun and seasons [Arnold van Gennep. 1999. - C. 12.].

Category "B" seasonal ceremonies are, in fact, a distinctive product of the agrarian community, whose main job is farming. For this reason, these rituals have undergone significant changes in modern post-industrial societies, some of them have even disappeared. Category "A" ceremonies, regardless of the lifestyle and conditions of the population, the normal course of life and are a product of historical development. Therefore, for many centuries it has been passed from generation to generation and is used as an important source in the study of ancient culture and ethnic history of each nation [Arifkhonova Z. H. 2002. 173 p]. These ceremonies are also called family ceremonies, mainly because they are performed in the family circle.

One of the most important activities of the family in the historical development of mankind is growing children. For this reason, one of the most precious qualities of a woman is considered to be her childbearing. Loving the child, respecting large families, wishing the family to have many children are the expression of the Uzbek national spirit, and from ancient times the happiness of having children is the highest happiness among the people.

As a result, many proverbs, songs, fairy tales and stories have been created, which express the infinite joy and great spiritual strength of the child [Mirtursunov Z. 1973. 54 p]. For example, proverbs such as "A person with a child is energetic, without a child person's waist will be broken", "Home with a child is market, without a child is cemetery.", "10 children have their role, 40 children have their action" expresses the relationship, love and kindness to children.

If we observe the traditional ceremonies associated with the birth of the peoples of the Jizzakh oasis, we can see that in this series of ceremonies not only the navel of the child, but also his umbilical cord is protected [Toshboev F. 2016. pp. 383-385]. For instance, in the regions of Gallaorol, Bakhmal, Zaamin the baby's umbilical cord was not reported until it fell. Because if others knew about it, it would be difficult for the umbilical cord to fall.

In turn, it should be noted that in the peoples of the oasis, the baby's umbilical cord was considered a living being, and the child's brother, sister or protector of the child was considered to be in him [AkchaevF.Sh. 2020. 67 p].

Population of the Jizzakh oasis like the Uzbeks and Tajiks living in other regions also have a tradition of holding special ceremonies for babies in shrines.

Such ceremonies include the Aqeedah, the Sacrifice, the taking and burying braids, the bleeding, and mushkulkushod.

Holding such ceremonies in shrines is the idea and intention of the saint or patron saint of the shrine, named after the sacred step protects the child from various ins-jins.

In the oasis of Jizzakh, seven days after the birth of the child (after falling the umbilical cord), a special water was prepared for the first bathe of the child, which salt and soil were added to the water in the heat of the house. The baby was laid to a basin, where specially prepared water was first poured from the right side and then from the left side. As for the properties of the items in water, the salt hygienically tightens the skin of the baby, and prevent various diseases and ailments, it was a symbol of abundance, plenty and nourishment. The soil prevents the growth of various wisp and hairs on the body. After the baby was bathed in a ceremonial way, even the water used to wash the baby was spilled not underfoot, but under a fruit tree. It should be noted that the first ceremonial bathe of a child meant not only his hygienic purification, but also his symbolic transition from one world to another, that is, from the "natural" world to the human world.

The child was considered an official member of the family only after the ceremonial bathe. In the Jizzakh oasis, among relations and in the mahalla and in the village, respectable, uvali-juvali, and unmarried women were chosen to carry the child in the cradle. In the process of putting the child in the cradle, the intention is stated: "Be a fearless hero, grow up healthy, and live long!" In this way, after the child was tied to the cradle and his hands and feet were tied, people strew sweets, apricot, pistachio, almond, raisins, oleasters on the cradle. These bouquets were collected by the participants of the ceremony and distributed to their children with good intentions [field notes. 5.].

Getting the baby's first "Korin Sochi" was a big ceremony. Our ancestors imagined that "human life and power are in the hair". They were afraid to take the child's belly hair and our rich, old fathers, who had many children took it, and they carefully buried it under a fruit tree. It should also be noted that the removal of a baby's early belly hair is a pre-Islamic tradition and it meant symbolic transition from one world to another, that is, from the "natural" world to the human world.

It is known that the custom of giving flour soup - "Atala" a new-born woman is widespread among all Uzbeks and has survived to this day, but the method of preparation of it differs depending on the ingredients added to it. For example, in some places it is fried in oil, in other places it is prepared without oil. In Surkhandarya, milky flour pour is made, and in Tashkent, it is made with minced meat. In Jizzakh, flour pour with a buttermilk or a sheep oil is prepared for a woman who gives birth [field records 6.].

Children are raised in cradles until they are one and a half to two years old. According to the tradition of the Jizzakh oasis, when the first child is placed in the cradle for the first time, 5 or 6

close relatives gather and clap, and a long-lived, large-scale "grandmother" place child in the cradle.

In short, since the birth and upbringing of children is one of the basic behaviors of mankind, the decline in the birth rate today does not mean that people are less concerned about children. On the contrary, the current economic prosperity is increasing the attention of the population for the upbringing of the younger generation. In other words, the role and place of the community among the people is shrinking over time, but the birth of a new generation and the preservation of the nation's gene pool is considered one of the most important tasks.

This means that despite the fact that the customs and traditions of the Uzbek people are changing in line with modern requirements, the birth and upbringing of the younger generation is always in the focus of the entire population.

#### **USED LITERATURE:**

1. Aqchayev F.SH. Shrines of Jizzakh oasis. Dissertation for PhD. - Tashkent, 2020
2. Arifxonova Z.KH. Mahallas of Tashkent: traditionality and modernity – Tashkent. Yangiasravlodi, 2002.
3. АрнольдванГеннеп. Обрядыперехода. – М.: Изд. «Восточнаялитература» РАН, 1999.
4. Ashirov A. Ethnology scientific handbook. – Tashkent:Yangi nashr, 2014.
5. Field notes. Jizzakh region, GallaorolvaForish districts, 2020.
6. Field notes. Zaamin and Sh.Rashidov districts, 2020-2021.
7. Mirtursunov Z. Pedagogy of Uzbek nation.–Т.: 1973.
8. Toshboyev F. Omai mother in cultures of cattle-raisers// Proceedings of the Republican scientific-theoretical conference on the topic of “Socio-economic and cultural life in Uzbekistan: transformation processes”. -Termez, 2016.
9. Meliev, U., &Nematov, O. SUFI ALLAYAR. Zbiórartykułównaukowychrecenzowanych. 80.
10. Nazarov, A. Y. (2021, February). Classification Of Documents Of Turkestan Scientific Societies Kept In The National Archive Of Uzbekistan. In INTERNATIONAL SCIENTIFIC AND CURRENT RESEARCH CONFERENCES (pp. 9-12).
11. Yunusova, K. (2010). The Reasons of the Tragic Events in Fergana in the summerof 1989 (Based On the History of Relations between the Nations of the Former Soviet Union). Journal for the Study of Religions and Ideologies, 1(2), 194-197.

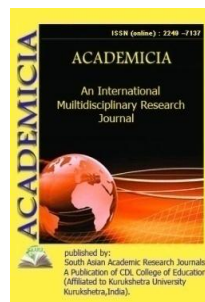

DOI: **10.5958/2249-7137.2021.01013.2**

## THE METHODOLOGICAL PROBLEMS OF THE HISTORICO- PHILOSOPHICAL INVESTIGATIONS OF BERUNI

**Gulnora Nosirkhodjaeva\***

\*Associate Professor,  
Head of the Department, Candidate of Philosophical Sciences,  
Tashkent State Law University,  
UZBEKISTAN

Email id: [g.nosirxodjayeveva@gmail.com](mailto:g.nosirxodjayeveva@gmail.com)

### ABSTRACT

*The article is devoted to the research of the historico-philosophical works of Beruni coming out as one of the important components of the rich and polyhedral heritage of Abu Raikhan Beruni and his contribution to studying history of philosophy of peoples in many regions including the Central Asia as well. In the article analyses of the little studied objective and subjective factors of developing the historico-philosophical traditions in the early medieval countries of islam region, especially, in the Central Asia, to the study of the the historico-philosophical heritage of Beruni, his conceptual-methodological bases. As shown in the article, the historico-philosophical investigations of Beruni are differed not only by its rich, concrete, factual data but by developing many conceptual problems of analysis of history of philosophy.*

**KEYWORDS:** *Beruni, spirituality, spiritual and moral formation, history of science, objectivity and truthfulness, conceptual and methodological conclusions, moral perfection, social and philosophical views, philosophical and methodological questions, geodesy, spiritual and religious needs, unity of the historical and scientific process, "Pharmacognosy", "India", "Monuments of the past generations."*

### INTRODUCTION

Spirituality is inherently a very complex and multifaceted phenomenon, and in the process of its formation and development, factors related to the whole society and the human personality have played an important role. One of them is science, natural sciences and sociology, technical knowledge. Of course, their position in this process was not somewhat simple or one-sided,

because they are a factor of development in relation to spirituality, and on the other hand, in a sense, an important component of spirituality.

### **The main results and findings**

This issue is especially relevant in modern times, as some scholars tend to interpret the results of scientific research, the consequences of their application in practice, without being related to their spiritual and moral positions. However, the development of science today has reached such a level that the great achievements of scientists have the potential to have a direct impact on nature, the environment, the spiritual world of man. This effect can be both positive and negative. Therefore, the problem of the inextricable link between the sciences and the spiritual formation and development of man has attracted the attention of thinkers not only today but also since ancient times. One of the first to pay serious attention to this issue in the early Middle Ages was our compatriot, the great encyclopedic scientist Abu Rayhan Beruni, who made a great contribution to world science. From this broad and multifaceted problem, the scholar sought to shed deep light on the importance of studying the history of science and identifying its spiritual aspects. Beruni's foresight in this direction, his scientific predictions are surprisingly close to our time, and their importance is growing.

First of all, it should be noted that the name of this great scientist, his contribution to science is already recognized in the history of world science and finds its worthy value. About Beruni the American historian of science Sarton calls the 11th century the "Beruni age". Such a high and justified assessment is explained, first of all, by the invaluable contribution of our great compatriot, the owner of encyclopedic thinking, to the development of science. It should be noted that Beruni was very objective and truthful both in scientific matters and in the assessment of historical events and contemporaries. That is why he suffered so much in life, even at the end of his life, but in spite of all the difficult circumstances, he did not give up his faith, which shows how faithful he was to his own spiritual ideals.

Uzbek scholars, who have made a significant contribution to the study of Beruni's scientific heritage and the publication of his works, have repeatedly mentioned his contribution to the history of science. Well-known Uzbek philosopher I.M Muminov wrote on this issue: "Beruni's scientific interests were very wide and varied. He studied the history of science in ancient Greece and the Arab Caliphate, the history of ancient and early medieval science in Central Asia, as well as the science of his time. P.G Bulgakov, one of the great researchers of Beruni's legacy, also noted his services in the field of history of science: has preserved valuable information. "

Continuing Beruni's above-mentioned merits in the study of the history of science, we have come to new conclusions, which, in our view, are known as a result of a special study of this aspect of the great scientist's work. First of all, it should be noted that in the study of the history of science, Beruni, while collecting accurate and valuable information in this area, tried to approach it from a theoretical and methodological point of view, and achieved very interesting and important results. Interestingly, Beruni's conceptual and methodological conclusions and generalizations about the history of science do not lose their significance over time, but again show their true value to the present day. The second important aspect of Beruni's scientific-historical heritage is that it defines the spiritual significance of the restoration of the history of science, interprets it as an important tool, factor in the formation and development of society, personality, spiritual, moral and intellectual, and should be approached from this perspective.

According to Beruni, the spiritual significance of the history of science, first of all, comes from its spiritual content. As the scholar wrote, "There is more benefit and more benefit in anything other than knowledge, and only those who know science can refrain from doing good deeds and harming them, both for religion and for the world. Without knowledge, there would be no belief that what we attract is not evil and that what we avoid is not good."

Thus, in Beruni's view, science, including its history, while providing clear and accurate information about human existence, should be defined as an important tool and moral norm for the purification of the spiritual world, moral perfection, and the separation of good and evil. This spiritual nature and significance of science is also reflected in the history of science, as these sciences are tested over time, enriched and improved scientifically and methodologically.

One of Beruni's great contributions to the study of the history of science, and history in general, is that he was one of the first to try to develop a special method for studying them. At the same time, it should be noted that this method puts before the researcher not only pure scientific-theoretical, but also spiritual-ethical requirements, and they are described as an integral part of this method. Beruni explains the spiritual side of this style as follows: "It is then known by comparing the words and beliefs they cite for proof, after purifying themselves of the bad morals that degrade the nature of most people, the factors that prevent them from seeing the truth. This is the best way to get to the real goal I mentioned and the most powerful helper to wash away the doubt that tarnishes it. No matter how hard we try, no matter how hard we try, we can't achieve the goal in any other way."

From this it is clear that before embarking on the study of the history of science, and history in general, a scientist must purify his language spiritually, get rid of all feelings of prejudice and envy, and achieve a certain spiritual maturity. Interestingly, the scholar also referred to the dirty interests associated with political struggles and to the detriment of an objective approach. Beruni's above claims are still relevant today, as some researchers in the study of the history of science ignore and discriminate the services of certain peoples in the history of science on the basis of ideological, racial, and erroneous scientific positions. This has been particularly evident in the recent past in the context of a totalitarian administrative system. For example, the socio-philosophical views of Muslim people were negatively assessed by most representatives of history, accused of mysticism, idealism. This, in turn, has led to the existence of many unexplored, generally unrecognized pages in our history.

Beruni puts these requirements before the researcher who studies the history of science not only of his own people, but also of other nations, and urges him to adhere strictly.

It is a science that, unites all people and serves as a universal value, which is reflected in the history of science, because the differences between the sciences of different peoples, whether methodological or factual, gradually lead to the development of science, the search for truth to some extent agreed and adapted to each other.

The unity or ever-increasing closeness of the sciences in different nations, based on the means of reason and experience, is the unity of mankind, and its unity is determined by reason. The difference from the animal is also in the mind. When Beruni speaks of ignorant people who do not understand the essence of some science and what is the superiority of man over animals, he concludes: "... That superiority is the absolute science itself, without which the existence of man



becomes doubtful." Man is characterized by his ability to master science as well as his spiritual approach to it.

A researcher who deals with the problems of the history of science, who focuses on philosophical and methodological issues, first of all confronts the question of the origin of the sciences. Therefore, Beruni also puts this issue in a special way and describes the reasons for their general emergence as follows: "This is the state of the sciences. They are the result of essential needs in human life, so they are divided into networks. The need for them is in their interest, but not in the silver and gold they find. " These needs can of course be material and spiritual. But Beruni specifically points out that the origin of the true sciences should not in fact be associated with greed and greed. That is, the origin of any science is based on certain spiritual values in man.

The scientist specifically examines the causes of the origin of several sciences and distinguishes between them directly aimed at improving human spirituality. From these he can show maturity, poetics, logic. For example, he describes puberty as follows: "If one is asked about its benefits, it is a virtue in itself. The Prophet (peace and blessings of Allah be upon him) said: "Indeed, there is magic in speech."

Beruni even tries to show that it is related to spiritual needs and to reveal their interrelationships when analyzing the needs that this or that science brings. A vivid example of this is geodesy. The main reason for its emergence is, on the one hand, the determination of azimuth and other dimensions, and, on the other hand, the satisfaction of religious and spiritual needs. "Since we have a strong need to determine the azimuth of the Qibla and the Qibla is the pillar and pole of Islam, let us explain what we need to know about it. Allaah says (interpretation of the meaning): "Wherever you come from, turn your face towards the Sacred Mosque, and wherever you are, turn your face to the right."

In general, whatever the need for the formation and development of the sciences is, they depend on the human desire to know. "After all, humanity," writes Beruni, "was not created with a strong desire to learn things that are hidden and unknown to it?" You can see that even children, despite their bad habits and misbehavior, rejoice in all kinds of news. "

When showing the reasons for the origin of the sciences, Beruni reveals another important aspect of the problem. It is also determined by the fact that this process is related to human needs, but also to the performance of certain duties and services before nature, society and other people. "As for the sciences, since man is by nature capable of accepting them, the questions of service during his reign in the universe have compelled him to turn to them." These services, regardless of their material and vital nature, also have spiritual qualities.

One of the most important aspects of Beruni's method of studying the history of science is to approach them from the point of view of the inseparable unity of humanity. The integrity and integrity of the historical-scientific process is determined, first of all, by the fact that mankind has a common origin.

"People," writes Beruni, "are all children of the same father and each one goes by his own appearance. " This determines the integrity and close connection of human civilization, including the history of science. But there is another reason for the unity of the sciences on a human scale, which is that the goals, methods, and means, no matter what nation they belong to, are close to

one another, and in many cases, one. For example, the goal of every science is to know a particular aspect of being. Scientific methods and tools will be developed for this purpose. Of course, the styles and tools of the sciences that are developing in different peoples and regions differ to some extent, but they will come closer to each other once it is determined in practice how successfully they can be used.

When Beruni emphasizes the global unity of science, he notes that each nation has its own characteristics of this process. Bright examples of this can be found in many of Beruni's works. In his book Pharmacognosy, he writes that each nation differs in the development of a particular science.

But the thinker does not draw this conclusion to show the incompatible differences of peoples, but rather emphasizes that they can and must learn from each other's scientific achievements and use them, and more deeply and vividly express the integrity and integrity of the history of science. This means that nations need each other in order to master the achievements of science. "When something is generalized on earth, every nation seeks to contribute to it."

Therefore, when Beruni analyzes the services of each nation in this or that science, he often compares them to the situation in other nations and serves as the main criterion in their evaluation to determine which one is more accurate. In general, the foundations and status of the sciences are determined by how effective and useful these international relations are. Summarizing the history of science from this point of view theoretically and conceptually, he concludes: "... Most knowledge is acquired simultaneously and in several places, and they are transferred from one place to another through language and gesture, which are the means of general expression. Due to the length of time and the breadth of places, the basics of science and sciences, knowledge for a person are concentrated. In addition to the general foundations of these collected and formed sciences, the development of science in each nation is determined by its special features.

Some of these may be more scientific, some socio-historical, or even spiritual. For example, in his book India, Beruni describes the sciences of the Indians and Romans, along with their general features, but also their differences in scientific content. These are primarily related to the methods and tools used in the relevant sciences. For example, in these nations, the goals of astronomy and mathematics are common, but the methods and tools used and the resulting results are somewhat different.

As mentioned above, the factors that determine the characteristics of the history of science in nations can take on a socio-historical character. These include wars, conflicts, social situations, and more. In his book India, Beruni speaks of the consequences of the marches were made to India by Mahmud Ghaznavi, first and foremost, of their negative impact on the development of science. In particular, he describes the marches of the Ghaznavid rulers to India and how much massacre they inflicted on the Indian people, which in turn led some Indians to have a misconception about Muslims and to distance themselves from them to some extent. As for the sciences, he concludes: "Perhaps these events led to the disappearance of science from the occupied countries and their flight to places we still do not have access to, such as Kashmir, Banoras and the like. At the same time, because of politics and religion, there is a lot of disconnection with foreigners. " Condemning such a policy of looting and exposing the damage it does to Islam, Beruni emphasizes that it hinders the development of science and the

establishment of mutual scientific relations. This, in turn, can cause certain damage to the scientific and spiritual development of other nations.

Beruni repeatedly notes that the characteristics of the authority established in the country for the effective development of the history of science depend on how much they sponsor scientists, and gives historical examples. At the same time, such a policy leads not only to the scientific development of society, but also to its spiritual perfection. For example, when it comes to some scholars, Beruni writes: "They exalt themselves, act foolishly, and become arrogant and ignorant. They are greedy for what they have learned and are not taught to be ignorant, even of their own gender. How can they teach others after that! Because they do not believe that there is a country other than their own, that there are peoples living in those countries, and that there is knowledge in nations other than themselves. " It is these unfortunate actions that prevent scientists from establishing scientific ties and may even cease altogether. The detrimental and negative effects of this can lead to certain material and spiritual losses not only for less developed countries, but also for people with rich traditions related to science.

In Beruni's view, the various factors and processes that are of great importance to the sciences determine their uneven development. Summarizing this idea, the scientist comes to the following conclusion: "A person who thinks seriously notes that they are in a state where the knowledge is unknowable, that is, the possibilities are not open, and in time, the knowledge is unknowable."

Therefore, ensuring the development of scientific relations will further increase and strengthen the spiritual potential of nations, as it leads to the development of science, says Beruni. This is due, firstly, to the elimination of conflicts and wars, albeit to a certain extent, and, secondly, to the growing respect and interest of peoples, scholars, in each other, regardless of nationality or religion. Beruni's great contribution to the spiritual upliftment of mankind in this regard, that is, his contribution to the study of the scientific and spiritual achievements of other peoples, their mastery and correct interpretation in terms of the history of science, is invaluable. The scholar supported and noted with satisfaction the efforts of scholars representing other nations in this direction. For example, Beruni emphasizes the words of the great Indian scholars on the need to study and respect Greek science, regardless of religion or other differences, that is, people should be "glorified because they can reveal science and rise above others." Beruni's approach to the history of science from this point of view has not only great scientific historical, but also broad spiritual and universal significance, as his understanding of the universal nature of science reinforces the idea that humanity is one of the most important universal spiritual values.

Emphasizing the need to follow the path of objectivity, truth in the study of the history or culture of other peoples, the history of science, spirituality in general, Beruni himself strictly adheres to this requirement. Commenting on his book *India*, he said: "This book is not a book of evaluation and gravity, so in this book I will not cite the proof of the enemies and I will not oppose those who deviate from the truth. It's just a narrative book. "

Enlightenment, which is inherent in Beruni's worldview in general, and the desire to spread science, finds its bright expression in the history of science. Because Beruni's approach to the above-mentioned history of science from the point of view of universal unity, the need to acquaint scientists of other nations with the achievements of science, takes on a fundamental theoretical character and has become one of the most important conditions. He writes that while translating for the Indians, he was "interested in spreading knowledge and having the knowledge

they did not have," and elsewhere he continued, "I remember all my thoughts, my heart is devoted to the propagation of knowledge, because I have enjoyed the pleasure of gaining knowledge." I consider it the greatest happiness for me".

## CONCLUSION

Summarizing the history of science, the state of sciences and their connection with the spirituality of scientists, Beruni concludes: "There is a lot of science. They are the epitome of time and multiply as different thoughts and memories join them. The fact that people are interested in science and respect the sciences and the people of knowledge is a sign of this success."

## REFERENCES:

1. Abu Rayxan Beruni. Izbrannye proizvedeniya. Tashkent, "Fan", 1963 p.21.
2. Abu Rayxan Beruni. Introduction to the treatise on the list of achievements of Abu Bakra Razi // Materials on the history of progressive society - philosophical examples in Uzbekistan. Tashkent, "Fan" 1976. p.237
3. Abu Rayhon Beruni. Monuments of ancient peoples. // Selected works. I-tom. Tashkent, "Fan", 1968. 40 pages.
4. Abu Rayxan Beruni. Sobranie svedeniy poznaniya dragotsennostey / Mineralogiya /. - Moscow, 1963. S.26
5. Abu Rayhon Beruni. Defining the boundaries of addresses to determine the distances between settlements / Geodesy // Selected works. Volume III. Tashkent, "Fan", 1982. Pages 61-62.
6. Abu Rayhon Beruni. India
7. Bulgakov P.G. Life and work Beruni. Tashkent, «Fan», 1972. p. 358
8. Muminov I.M. Beruni - historian of science // Collection dedicated to the 1000th anniversary of Beruni. - Tashkent. "Fan", 1973. Page 11.
9. Хайназаров, Б. Б. (2017). ИЗ ИСТОРИИ ФОРМИРОВАНИЯ УЙГУРСКОЙ ДИАСПОРЫ В УЗБЕКИСТАНЕ. *Theoretical & Applied Science*, (3), 51-55.
10. Хайназаров, Б. (2013). Из истории уйгуров Республики Узбекистан. *Научное обозрение: теория и практика.*, (1), 57.
11. Mirkomil, G., & Matluba, G. (2020). WAYS TO DEVELOP MODERN ECOTOURISM IN THE ZAAMIN BASIN. *International Engineering Journal For Research & Development*, 5(7), 5-5.
12. Shohistahon Mamajonovna Uljaeva, Gulnora Abdukaaxarovna Nosirkhodjaeva, Tadjibaeva Dilnovoz Ozodovna Azimov, Khakimali Imomovich. A History of Historiography and some Sources of the Period of Amir Temur and Temurids *International Journal of Engineering and Advanced Technology (IJEAT) Volume-9 Issue-1 2249 – 8958*

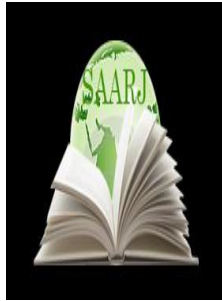

DOI: **10.5958/2249-7137.2021.01014.4**

**IN THE SOCIO-ECONOMIC LIFE OF UZBEKISTAN  
THE ROLE OF WOMEN: CHANGES AND DEVELOPMENT TRENDS**

**Khakimali Azimov\***

\* Associate Professor of "General Education",  
Candidate of historical sciences,  
Tashkent State Law University  
UZBEKISTAN

**ABSTRACT**

*Among the comprehensive reforms being carried out in Uzbekistan, measures to increase the role of women in the life of the state and society reflect the current image of a renewed Uzbekistan. As a clear proof of this, the attention paid to women confirms that one of the noble features of our people, historical work of state importance is being carried out to strengthen the role and status of women in society. After all, paying attention to women, respecting them in society is one of the noble features of the Uzbek people. There is a deep historical basis for the fact that Uzbekistan is carrying out historic work of national importance to strengthen the role and status of women in society. It is no coincidence that the stability and development of the political, socio-spiritual environment in society has always been determined in many respects by the attitude to women and the family. It should be noted that the Women's Committee of Uzbekistan, a self-governing non-profit organization, was established on a voluntary basis on December 27, 1991 at a conference of women of Uzbekistan in Termez to protect the rights and interests of women has been carrying out large-scale activities. Also, the Decree of the President of the Republic of Uzbekistan dated February 3, 2018 "On measures to radically improve the activities in the field of support of women and strengthening the institution of the family" served to fully support the role of women.*

**KEYWORDS:** *Uzbekistan, women, reform, society, spiritual environment, family, neighborhood, employment, management, entrepreneurship, tradition, national mentality, socio-political activity, youth, ideology.*

## INTRODUCTION

The Action Strategy for the five priority areas of development of the Republic of Uzbekistan for 2017-2021 identifies comprehensive measures to increase the socio-political activity of women and strengthen their role in government and society. Nowadays, when rapid socio-economic reforms are being carried out in all spheres, great attention has been paid to the further development of the primary organization of society, that is, the activities of women and the expansion of their powers. In particular, the proclamation of 1998 as the Year of the Family in Uzbekistan, 2012 as the Year of the Family, and 2014 as the Year of the Healthy Child has once again increased the prestige and prestige of women in society. Because in the national mentality of the Uzbek people, the principles of mutual cohesion, respect for the elder, respect for the younger have always prevailed in the family, family ceremonies, public events have always been held with the participation of neighbors, relatives. The role of women in it is great. It was during the years of independence that the prestige of Uzbek women increased. This plays an important role in further improving social relations between people, restoring historical traditions, forming in the minds of citizens the spiritual and moral qualities of our national mentality, such as respect and kindness to the family, parents and children.

**Methods:** The article is based on the methods of objectivity, consistency, historical-comparative analysis, study of historical and social events and phenomena in chronological order, reliance on sources and evidence and their validity. It was based on the definition of indicators for assessing the effectiveness of state policy on women's protection, the existing problems based on the development strategy of the sector and some methodological criteria for identifying priorities for their solution.

**CONCLUSIONS:** Article 18 of the Constitution of the Republic of Uzbekistan recognizes the equal rights of women with men in all spheres [1. 2019 y]. It should be noted that all legislation aimed at protecting the rights and interests of women is based on international legal norms. It is gratifying to note that the living standards of the population in Uzbekistan have significantly improved, resulting in a 2-fold decrease in maternal mortality and a 3-fold decrease in infant mortality, an average life expectancy of 67 to 73 years, including 75 years for women.

If we look at the historical figures, in the early days of Uzbekistan's independence, in 1991, women's employment in heavy labor was 47%, but by 2000 this figure had dropped to 42.5% [2. 52 b]. That is, women have moved from manual labor to services, management, entrepreneurship, farming, agriculture. That is, they have expanded their activities and increased their prestige in various fields.

Speaking about the role of women in the development of various spheres, President Shavkat Mirziyoyev noted that the heroes of Uzbekistan, such as Khalkhahon Mirzaeva, Patilakhon Ergasheva, Siyosatkhon Abdullaeva, Muyassar Temirova, Martiya Rakhmatova, set an example for all. Especially in recent years, the role of women in public administration, entrepreneurship, agriculture and manufacturing is growing. Well-known academicians Mashhura Mavloniy, Rano Ubaydullaeva, Sayyora Rashidova, Anna Glushenkova, Mukhabbat Abidova, People's Poets of Uzbekistan Aydin Hojjeva, Halima Khudoiberdieva, Enahon Siddikova, People's Artists of Uzbekistan Yayra Abdullaeva, Tuti Yusupova, Galina Melnikova, Munojat Yulchieva are known and popular [3. 2017. March 8. №19].

In recent years, the country has achieved significant growth in the activities of women in government and society, especially in terms of increasing economic and political activity. For example, today the share of women in local representative bodies is 16%, in the Legislative Chamber - 17.5%, and in the Senate - 15%. The fact that 3.4% in the executive, 22.7% in the judiciary, and production has doubled compared to previous periods [4. p. 506] alone confirms the growing role of women in the life of the state and society.

Another important aspect of the issue is that in Uzbekistan there has always been an association of self-government called "Makhalla", in which the role of women in the organization of spiritual and ideological education and the development of measures for ideological prevention among young people. has In this regard, by 2020, women's activities have entered a new stage of development. The Decree of the President of the Republic of Uzbekistan dated February 20, 2020 "On measures to improve the socio-spiritual environment in society, further support the institution of the community and bring the system of working with families and women to a new level" played an important role [5. February 20, 2020, №37]. On the basis of this decree, the President of the Republic of Uzbekistan adopted a resolution "On the organization of the Ministry of Makhalla(Neighbourhood) and Family Support of the Republic of Uzbekistan" [6. February 20, 2020, No. №37]. The resolution also sets tasks to increase the role of women in the life of the state and society.

In particular, according to the decision of the Cabinet of Ministers of the Republic of Uzbekistan, religious extremism and fanaticism, aimed at disrupting the peaceful life and socio-political stability of the country, the fight against the spread of inhuman, harmful ideas in society "[7. 5-6 b].

On the basis of this decision, "Advisers on religious enlightenment and spiritual and moral issues of the mahalla citizens' assembly" were appointed. It is planned to appoint women to this position, who will be able to work closely with the population, have a good reputation among the population, have extensive experience in national and religious traditions and customs, and can be a role model.

In other words, the purpose of the position of advisor to the chairman of the mahalla was as follows:

- Decision of a healthy lifestyle in the minds of the population of the neighborhood, especially young people;
- Preservation and development of exemplary, national, religious traditions and customs;
- The stability of the spiritual environment in society and the systematic implementation of the work of interethnic friendship and solidarity [8. Tashkent., 2005].

In Uzbekistan, as one of the noble features of our people, attention and respect for women, historical work of national importance is being carried out to strengthen the role and status of women in the community. As a proof of this, in accordance with the requirements of the new Charter, the position of adviser on religious-enlightenment and spiritual-moral issues in the mahalla is established in settlements with at least 500 families, as well as in towns, villages and auls. Women with extensive life experience, able to instill in the minds of the population the requirements of a healthy lifestyle, who can have a positive impact on the preservation and development of national and religious traditions and customs, will be appointed to this position.

According to the recommendations of the charter, the appointed women must be over 40 years of age and must reside in the same neighborhood.

The Madad Insurance Agency (June 26, 1995), the Chamber of Commodity Producers and Entrepreneurs of Uzbekistan (March 1996) and their regional branches were established in the country to promote the development of small business and private entrepreneurship, the Association of Peasants and Farmers, the Association of Craftsmen. , "Businesswoman" Business Association was established. For example, until 2018, the Business Association of Uzbekistan "Tadbirkor Ayol" had more than 24,000 women [9. "People's Word". January 7, 2017].

But in recent years, the lack of involvement of women in small business and entrepreneurship remains one of the main problems. Of course, Uzbekistan is a rapidly growing labor force. The peculiarity of the republic is that the growth of labor resources in the country averages 2.2% per year [10. 2019]. It is natural that this situation will cause serious employment problems in the field. One of the key solutions to this is to involve women in small business and entrepreneurship.

According to a survey of women conducted by women, when asked "Do you want to do business and entrepreneurship in the future?", Almost half of them, or 43.8%, answered "yes", while 15.7% said, "I am currently engaged." He replied. Among the respondents, it was confirmed that the majority of those wishing to engage in business and entrepreneurship are middle-aged women. Overall, the study found that this figure was 39.1% among men and 39.9% among women [11. 236 b].

When asked "What type of business do you want to do in the future?", 46.4% of respondents chose trade, services, 26.8% - construction, light industry, food production, 16.4% - fruit and vegetables. with the type of business in the vegetable processing industry, 7.9% responded with an intellectual business. In this regard, special attention is paid to increasing the role and prestige of women in production, business and entrepreneurship in the country, ensuring their employment.

However, in Uzbekistan, an agro-industrial country, women's participation in agriculture is still insufficient. Company farms, farmers' associations, agricultural cooperatives and agribusinesses play an important role in this. However, the role of women in them (in particular, their involvement in the management system, employment) is still not enough. After all, in the mentality of our people there is still an old view that the agricultural sector is not a specific field for women.

According to public opinion polls among graduates of vocational colleges in the country, some girls want to graduate and work in this field, that is, to become a farmer, that is, the share of those who aspire to this type of work is small. This figure is 16.9% for men and 6.4% for girls. In other words, rural youth are losing interest in the agricultural type of labor. Among the students who wanted to continue their studies, a total of 33 boys (5.4%) who wanted to become agronomists said that none of the girls had aspirations for such a profession. This is one of the problems that needs to be solved [pp. 12. 72-73].

As a result of the high attention paid to women in the society of Uzbekistan today, it is necessary not only to provide them with social protection, but also to ensure their more effective



participation in the life of the state and society, including active involvement in production, especially agriculture.

**CONCLUSION:** From the first days of independence of Uzbekistan, we have witnessed an increase in attention, respect for women in various sectors of the economy, the role of women in public administration. However, in our country there are many problems in further enhancing the role and status of women in entrepreneurship, agriculture, and life itself requires a lot of work in this direction. In general, it is important to identify measures to increase the knowledge of women in Uzbekistan in the field of management, entrepreneurship, business, agriculture, the formation of economic culture. It is important to perform the following tasks in this direction:

1. Wider involvement of women in entrepreneurship;
2. Increase the establishment of credit unions to expand women's economic opportunities;
3. Further expansion of their activities in public administration through the implementation of various national programs in cooperation with non-governmental and international organizations;
4. Strengthening labor protection of women in entrepreneurship and agriculture, creating safe working conditions for them, etc.
5. Providing women with certain benefits in the allocation of loans, microcredits in terms of further expansion of entrepreneurial activity;
6. Further expansion of research in this area to clearly define the prospects for further development of the industry;
7. To achieve the development and modernization of women's activities in the field of public administration and the wider promotion of their participation in public administration and the prospects for the development of the sector in the media;
8. New directions in the system of training for the industry, the expansion of specialties for training women in management, entrepreneurship and agriculture in the relevant higher education institutions to reform the system of training women.

#### **REFERENCES:**

1. Constitution of the Republic of Uzbekistan - T.: Uzbekistan, 2019.
2. Gonorskaya AV Ensuring the employment of labor resources of the Republic of Uzbekistan with the use of the potential of non-governmental non-profit organizations (On the first female employment). Diss. na soiskanie uchenoy stepeni kandidata ekonomicheskix nauk. T., 2002. - S 52
3. Speech by President Shavkat Mirziyoyev at a solemn meeting dedicated to the International Women's Day on March 8. Ma'rifat newspaper. T., 2017. March 8. №19
4. Said-Gazieva N. Civil service and human rights: theoretical and legal issues.// Democratization of society and human rights - the experience of Uzbekistan. Proceedings of the international scientific-practical conference. T., 2008, p. 506.
5. Decree of the President of the Republic of Uzbekistan "On measures to improve the socio-spiritual environment in society, further support the institution of the community and bring the

---

system of work with families and women to a new level." "People's Word," February 20, 2020, №37.

**6.** Resolution of the President of the Republic of Uzbekistan "On the organization of the Ministry of Mahalla and Family Support of the Republic of Uzbekistan." People's Word newspaper. February 20, 2020, №37.

**7.** Kuronov M and others. Ideological propaganda in the neighborhood. –Tashkent., 2009.-B. 5-6.

**8.** Model Regulations on the activities of the adviser of citizens' assemblies on issues of religious enlightenment and spiritual and moral education. -Tashkent., 2005

**9.** On the way to the development of women's entrepreneurship // "People's word". January 7, 2017.

**10.** Tolipov F. Some aspects of small business and private entrepreneurship in Uzbekistan.//International journal of innovative technologies in economy. Scientific edition. Poland. 2 (22), March 2019.

**11.** Kayumov U. Voprosy zanyatosti molodyoji Uzbekistana. // Strategy dalneyshego razvitiya kokrentosposobnosti natsionalnoy ekonomiki. T., 2012. S 236 ..

**12.** Ubaydullaeva R, Ata-Mirzaev O, Umarova N. Demographic processes and employment in Uzbekistan. (scientific-educational manual). T., 2006. pp. 72-73.

**13.** Mirkomil, G., Bakhtiyor, Z., & Dilfuza, I. (2020). Predicting Changes In Landscapes Around The Aydar-Arnasay Lake System. *The American Journal of Engineering and Technology*, 2(10), 6-12.

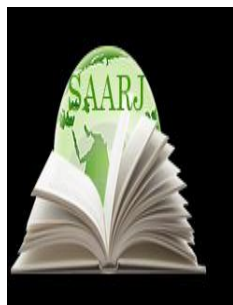

**ACADEMICIA**  
**An International  
 Multidisciplinary  
 Research Journal**  
 (Double Blind Refereed & Peer Reviewed Journal)

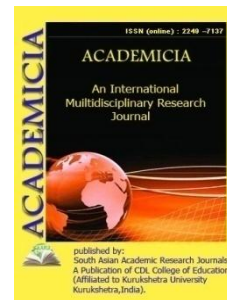

**DOI: 10.5958/2249-7137.2021.01042.9**

## THE PLACE OF DRUM INSTRUMENTS AND SONGS IN THE ART OF BAKHSHIL

**Zafar Hayitov\***

Senior Lecturer at the Institute,  
 Uzbek national music art, named after Yunus Rajabi,  
 UZBEKISTAN

### ABSTRACT

*This article discusses the role of nagma melodies in the performance of the bakhshi and the dombira, its role in the life of the bakhshi, the secrets of its making. The opinion expressed in the study of scientific sources is based on the comments and scientific conclusions on the definitions of noma and nagma.*

**KEYWORDS:** *Epic, Syncretic, Dombira, Nagma, Noma, Religious, Improvization.*

### INTRODUCTION

Today, Uzbek epic poetry is showing itself in a new form. It is no secret that the attention paid to the art of baxshi is paving the way for the further development of this rare art and the revival of its schools. Academician Tora Mirzaev devoted his life to the study of variants of the epics "Alpomish", their comparative analysis. As we study Master's research, we see that there are still many unexplored aspects of the Alpomish epic. It is no secret that the epic "Alpomish" is of interest in many areas. Alpomish provides a platform for research in all areas. As we teach students about the idea of the epic, its plot, its motives, we do not know that we are getting more and more immersed in its magical world. Whether it is a master bakhshis or a bakhshis who sings epic ideas today, we are amazed at its uniqueness and charm. Each version of the epic "Alpomish" can give us a school of science with the worldview, art, eloquence, description of the plot in its own way.

As Bakhshi sings a saga, he cannot imagine his saga without a drum. Accompaniment of the drummer. That's why we see that bakhshis have created so many terms about their drums.

My drum made of spruce,

My drum pistachio,

My drum across the rivers,  
I bought a drum for six sheep.

According to one of the legends quoted by folklorist M. Murodov, God gave a whip to the hand of Adam, whom he created, and called it a chal. But no matter how hard Adam tried, there was no sound from the drum. Then when the devil put a donkey out of the straw on the drum, he began to laugh. "That's probably why," says the scholar, "in all the legends, myths and legends about the drum, it is said that the drum was inherited from Adam, and that the devil added the donkey."

Adam's drum,

I am a drummer with a donkey added by the devil "[1.42].

A. Ergashev writes about the abundance of drum melodies in the epics of South Uzbekistan, the myriad of myths and legends about the drum. Interestingly, here each drum melody has a vital basis or mythical interpretation according to its origin. Husan Bobo from Shurchi district confirmed that some drums make a great sound during the day, others after sunset, and still others after midnight [2.80].

Now let's look at the details of how the drum is made. My teacher Safar BakhshiShaydulov, the People's Bakhshi of Uzbekistan, gives the following information about the drum.

"The drum is a key element in the performance of the bakhshi. The drum is a simple-looking word consisting of two strings. Bakhshis describe it as "chase", that is, bare wood. There are three elements that ensure the quality of the drum melody:

1. Drum bowl. The bowl is a skirt board that covers the drum, which is mainly made by cutting the hard fiber into a very skirt. The tree from which the bowl is made, i.e. the willow, grows in different areas of different quality. This causes the drummer to play the nagmaas a result of that quality of the bowl.

2. The drum string. Previously, until the eighties of the last century, the strings of the drum were made from the stalks of dried hay (mainly goat). This fact alone suggests that the intestines of goats living in different climates make different sounds. For example, in the climate of Samarkand, it is natural for a goat to grow up to be different from a goat raised on a narrow Sherabad mountain.

3. The body of the drum, i.e. the main part. This is also a big factor in how the drum beats sound. "In Surkhandarya and Kashkadarya regions, the drum is made of apricot, mulberry and walnut trees. The sound of a drum made of pears sounds good. Until the middle of the last century, more apricots were made, and later in mountainous areas the transition to walnut trees was made. After the mass planting of mulberries in Pakhtakor districts, the transition from mulberry trunks to making drums was made. The heaviness and lightness of the drum have a great influence on the bakhshi's melody. "[3.]

Now listen to the words of master NormuradShoydilov about the drum: "The drum has such a mysterious melody, it is an ancient national word of the Uzbek people. The dombra has long been made by masters in Surkhandarya, Kashkadarya and Samarkand regions. The bakhshis developed the art of bakhshi with these drums. " Normurad master Shoydilov did not take the

word for drum (Olmurid tree grows in the mountains, mainly in Sangardak in Sudkhandarya region, the fruit looks like pears), he makes apricots, walnuts and mulberries. These trees are pruned in late November or early December after 5-10 years of life.

“Every craftsman has his own style of making drums. I also have my own style of making drums. Because I created my style of making drums by asking old grandparents, shepherds who play the drums. After cutting the tree, I dig it deep for 1-1.5 years and bury the cut tree about a meter deep with water. From time to time I put water on a buried tree. Then the sap in the tree will come out as needed. I send one drum a month. I started making drums in 1989. I turned the drum to the drum of OlloyorovTaji bobo in Muzrabot district, which he turned to ShoberdibakhshiBoltaev. I consider OlloyorovToji Bobo as my absent teacher. Because I made a drum from the drum made by this man, ”said Master NormuradShoydilov.

From the above data we can see that the first and most important factor that demonstrates the unique performance skills of the art of baxshi is the drum. Through the drum, the bakhshis sing a saga through their own unique melodies. Today, there are reports that there are more than 32 epic songs by bakhshis.

Umir poet Safar oglu, one of the founders of the Sherabadschool of poetry, became a student of ShernaBakhshi of Surkhandarya, where he learned epics, terms, and drums from his teacher [4.8.]. The number of letters of the Qamayschool in the performance of the Umir poet Safar oglu is given:

“O my drummer,  
You have thirty-two names.  
All charming,  
If I play one, I have one.

that is, the number of letters is recorded. According to the son of the poet Umir, the People's Bakhshi of Uzbekistan Kara BakhshiUmirov, the number of these letters was increased by KadyrBakhshiRakhimov to sixty-four”[5.40.].

According to B. Matyokubov, in the traditions of epics it is noted that "Noma" and "Nagma" underwent alliterative changes and were generalized in content. In fact, noma (Persian) and nagma (Arabic) are both lexically and terminologically different, separate and independent concepts, differing in meaning [5.41.].

Based on these ideas, we preferred to consider the words noma and nagma lexically.

In the explanatory dictionary of the Uzbek language the word "noma" (Persian) - the meaning of official correspondence, letter, letter, "nagma" (Arabic) - melody, melody, melody; it has been shown that the sound of music signifies meanings [6.30,53.].

"Due to the predominance of words in such legends and epics, it is possible that it was called a letter, not a nagma," said B. Matyokubov. The scholar's opinion may be well-founded in its place, but we have chosen to use the drumming melodies of the drum in its proper place as a nagma, in the lexical sense.

Even among the bakhshis who play the nagma in their performances, there are unique melodies, and each of them has its own history of creation. For example, the People's Bakhshi of

Uzbekistan ShoberdiBoltaev tells the following legend about the history of the song "Ogajonim" in his repertoire. "A good young man is killed by the invaders. Seeing this, the young man's sister entered the house, grabbed the drum that her brother was playing, cried, "Uncle," and sang the same tune.

The bakhshi gives the following information about the creation of the song "Karakoz" in the epic "Yusuf and Ahmad" in the repertoire of the People's Bakhshi of Uzbekistan AbdumurodRakhimov. "While Ahmad is in prison, a maid named Karakoz carries food for him. Ahmad fell in love with this maid,

I love you Black Eyed Peas,

Who did you love, Karakoz?

- he said, creating this tune.

From the above information, it can be seen that each nagma performed by bakhshis has its own history of creation. We can say that it would be expedient not only to write epic texts performed by bakhshis, to study it scientifically, but also to study epic poems along with the history of their creation scientifically and to take them into musical notes.

The Alpomish epic (version by FozilYuldoshogli, compiler and preparer for publication: Tora Mirzaev, translation and commentary by MaqsadAbdurahimov) is published in Uzbek and Russian (1999). Features of the Epic "(in Russian) and "Note Applications" were also given. The Karakalpak version of the epic "Alpomish" - the text of the version and the note (written on paper by Suren Gabrielyan) performed by QiyasJirovKairatdinov accompanied by a kobyz, was published in 1999 by T. Mirzaev and F. Karomatli. BotirMatyokubov and SeydatTamay in Turkey The text of the epic "Temur and Boyazid" (in Turkish and Uzbek), composed and performed by the People's Bakhshi of Uzbekistan QahhorRakhimov (2019), multi-volume "Monuments of Uzbek folk art" has published 20 volumes of his book to date. It should be noted that in volumes 1-16 of the monument, along with the publication of the rarest samples of folk epics, notes were also given. It is obvious that along with the epics performed by Uzbek bakhshis, we want to continue the study of their melodies in such a syncretic way.

In conclusion, on September 2, 2020, the Resolution of the Cabinet of Ministers No. 536 "On the organization of the Uzbek National Institute of Musical Arts named after YunusRajabi" was adopted.

The resolution sets out a number of tasks for the training of qualified teachers in the education system. In addition to teaching our young creative students to perform epics, it is necessary to teach them about the history of songs, the place of performance. It takes a lot of work to preserve the melodies that come in the repertoire of bakhshis and pass them on to the next generation. This, in turn, requires studying the melodies that have come to the forefront of oblivion and taking notes. The preservation of nagmals in the notes can serve as an auxiliary function in their preservation.

## REFERENCES:

1. Муродов М. Сарчашмадантомчилар. – Тошкент: Адабиётвасанъат, 1984.
2. Эргашев А. Қашқадарё-Сурхондарёдostonчилиги. – Тошкент: Фан, 2008.

3. Чечанлар эпланди гапнинг зўрини. Сафар бахши Шайдулов билан суҳбат, “Сурхон ёшлари” газетаси, 2018 йил, 6-сон.
4. Юрагимнинг жўри бўлгин дўмбирам/ тўплаб нашрга тайёрловчи Ў.Ҳакимов. – Тошкент: Akademnashr, 2019.
5. Матёкубов Б. Достон наволари. Тошкент, 2009.
6. Ўзбек тилининг изоҳли луғати: 80000 га яқин сўз ва сўз бирикмалари. Ж. Ш. Н - Тартибли / Маъсул муҳаррир А.Мадвалиев. – Т.: “O‘zbekiston milliy ensiklopediyasi” Давлат илмий нашриёти, 2020.

Le substitute to the traditional class room learning in higher education especially under the present situations. E-Learning not only plays a major role in Indian higher education institutions but also acts as an emerging trend of education for future India. The majority of the learners believe that digital technology and flexibility are the key factors behind the development of e-learning in higher education. It has also discovered a new definition and dimension in teaching learning process and all government e-learning initiatives plays a very important role to make it available to all the students. For making e-learning more effective, it is essential to improve e-learning tools and technology and make few changes in the area of online assessment, investment in technology and faculty training and in policies and governance towards e-learning. All the educational institutions should focus on the technology and services that suit them and also security of data reliability and the personal information of teachers and learners should be secured. It can be concluded that the access to internet connectivity plays a crucial factor for growth of online education. In developing countries, e-learning raises the level of literacy and more so with the help of e-learning initiatives many opportunities can be captured and speedy development of educational sector is possible. It is also expected that if developing countries work as a joint venture on the issue of e-learning, it will be beneficial for the development of knowledge reservoirs throughout the world.

## REFERENCES

1. Gaikwad, A., & Randhir, V. S. (2015). E-Learning in India; Wheel of Change. *International Journal of e-Business, e-Management, and e-Learning*.
2. Wazalwar, A. N. (2020). Innovations in E-learning: The COVID-19 Impact. *International Journal of Grid and Distributed Computing*, 13, 113-117
3. <https://link.springer.com/article/10.1007/s11135-020-01028-z>
4. Vivekananda, M., & Ruvn, S. (2017). EMERGING TRENDS OF E-LEARNING IN INDIA. *International Journal Of Advance in Electronics and Computer Science*.
5. Ray, P. P. (2012). WEB BASED E-LEARNING IN INDIA: THE CUMULATIVE VIEWS OF. *Indian Journal of Computer Science and Engineering*, 1(4), 340-352
6. Dutta, D. A. (May 2020). Impact of Digital Social Media on Higher Education: Alternative Approaches of Online Learning during COVID-19 Pandemic Crisis . *International Journal of Scientific and Research Publications*.
7. Lone, Z. A. (2017). Impact of Online Education in Indian. *International Journal of Engineering Science and computing*.
8. Jana, P. K. (2020). Impact of COVID-19 on Higher Education in India. *International Journal of Advanced Education and Research*, 5, 77-81.

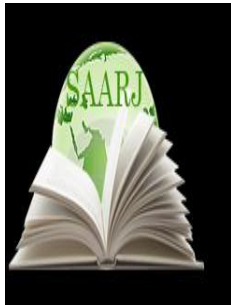

**ACADEMICIA**  
**An International**  
**Multidisciplinary**  
**Research Journal**  
 (Double Blind Refereed & Peer Reviewed Journal)

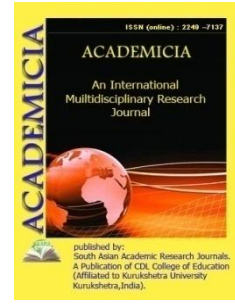

**DOI: 10.5958/2249-7137.2021.01028.4**

**A STUDY OF MEASURING THE SOCIAL DETERMINANTS OF  
 SUBJECTIVE WELL-BEING OF WORKING WOMEN (WITH SPECIAL  
 REFERENCE TO BALANGODA DIVISIONAL SECRETARIAT  
 DIVISION)**

**U.S. Thathsarani\*; N.M. Wijesekara\*\***

<sup>1,2</sup>Faculty of Social Sciences and Languages,  
 Department of Economics and Statistics,  
 Sabaragamuwa University of Sri Lanka,

Email id: Thathsarani0@gmail.com; miyunadee@gmail.com

**ABSTRACT**

*The measurement of Subjective Well-being (SWB) has advanced rapidly over the last two decades with the several segments. Subjective well being is defined as sum of three components- life satisfaction, presence of positive affect and absence of negative affect together called “happiness”. However studies based on working women’s well-being still is scarce. In this paper a attempt has made to measure the social determinants of subjective well-being for working women while identifying the variation among social determinants and subjective well-being for the selected area is the supplementary objective. Selected sample consisted with 187 married, employed women in the age group of 19-60, from 3 GN Divisions in Balangoda DS Division, through cluster sampling and convenience sampling methods, using a structured questionnaire. Weighted Principal Components Analysis (WPCA) is performed on variables for the indicators of Subjective Well-Being. Under this method, the loading from the first component of PCA are used as weights for the respective indicators. Finally the constructed social determinants of subjective well-being are classified into three categories as happy moderately happy and unhappy using cluster analysis. Indicators for community relationships, contribution of family members, social validity, organizing events and nature of the job lead to high satisfaction while working hours per week, working environment and trade union participation make less happiness among working women*

**KEYWORDS:** *Social, Subjective Well-Being, Employed Women, WPCA*



---

## INTRODUCTION AND RESEARCH PROBLEM/ISSUE

Subjective well-being (SWB) is widely considered to be an essential ingredient of the good life and represents a hedonic well-being concept with roots in the mid-seventies when Andrews and Whitey (1976) introduced a well-being structure consisting of three factors such as cognitive evaluation, negative effect and positive effect. According to Diener (1984), subjective well-being covers two main components such as one affective including negative and positive emotions and one cognitive namely life satisfaction. Negative emotions and life satisfaction are distinct measures and although positive emotions are related to life satisfaction (Diener et al, 1999). Therefore, subjective well-being can be defined in terms of high levels of positive emotion and life satisfaction and low levels of negative emotions.

When people describe what they most want out of life, happiness is almost always on the list. Scientists rely primarily on surveys to assess the happiness only for the individuals, but some important point should in to consideration that people's levels of subjective well-being are influenced by both internal factors, such as personality and outlook, and external factors, such as the society in which they live. In recent years, cultural differences in subjective well-being have been explored, with a realization that there are profound differences in what makes people happy (Diener & Suh, 2000).

A growing numbers of scholars have attempted to study the subjective well-being of women, because role of the women in the society and their contribution for the family and economy is very important and significant. A woman can be considered as a pre dominant character in any society. She plays an important role in the family by encouraging the husband, children and other family members. And also women provide a greater service to strengthen the household economic activities and make her full effort to enhance the welfare of the family members.

Main objective of this study is to measure the social determinants of subjective well-being for the selected group. Identifying the variation among social determinants and subjective well-being for the selected area is the supplementary objective.

## RESEARCH METHODOLOGY

The study is based on a sample of 187 married, employed women in the age group of 19-60, selected from 3 GN Divisions in Balangoda DS Division which represent urban (Balangoda Town), rural (Rassagala) and estate sector (Pettigala estate) through cluster sampling and convenience sampling methods, using a structured questionnaire. Weighted Principal Components Analysis (WPCA) is performed on variables for the indicators of Subjective Well-Being under three varieties as community contribution, family and working place. Under this method, the loading from the first component of PCA are used as weights for the respective indicators. Finally the constructed social determinants of subjective well-being are classified into three categories as happy moderately happy and unhappy using cluster analysis.

## RESULTS AND FINDINGS

### PCA on Community Contribution

One component solution is chosen as component in community contribution dimension. This suggested that just less than 61 per cent of the variance in the five variables is represented in the first component.

**TABLE 01: PCA ON COMMUNITY CONTRIBUTION**

	Component
	1
Spend time for social activities	0.998
Relationship with friends	0.003
Relationship with neighbors	-0.077
Organizing social activities	-0.029
Participation for recreational activities	0.603
% of total variance	60.9

Source: Sample Survey, 2015

*PCA on family*

PCA applied to the five family measures suggested one component solution with the component representing around 98 per cent of the variance in the five indicators.

**TABLE 02: PCA ON FAMILY**

	Component
	1
Contribution of family members	0.114
Attention of family members	0.164
Decision making within the family	-0.008
Time spend with family members	13.6258
Structure of the family	-0.038
% of total variance	97.7

Source: Sample Survey, 2015

*PCA on working place*

Working place categorized under one of the social relations which determine the satisfaction of the workers. Contribution to trade union, thrift societies, attaining and organizing some events and the nature of the job are identified as the variables under this section. PCA generated one component with Eigen values greater than 1.0. These components accounted for 98% of the variance in the dataset.

**TABLE 03: PCA ON WORKING PLACE**

	Component
	1
Working environment	-1.193
Working hours per week	-12.313
Social validity	0.397
Organizing events	0.15
Trade union participation	-0.35
Nature of the job	0.237
% of total variance	98.2

Source: Sample Survey, 2015

#### *Final index*

First principal component of the social dimensions of subjective well-being are the linear compound;

$$SWB = 0.107 \text{ Social} - 185.009 \text{ family} + 28.311 \text{ working}$$

And results from the first principal component for SWB is recorded as their associated Eigen value is 1.489, accounting for 61%, of the variation in the original data. Social and working variables are weighted as positively on SWB.

K-means clustering classified 187 individuals as 65 low, 80 moderate and 42 high satisfied group. Cluster 2 is the largest grouping with just half the cases while the smallest group is cluster 3.

### **CONCLUSIONS, IMPLICATIONS AND SIGNIFICANCE**

Indicators for the community relationships are especially with association and the amount is given to the society by a group in many ways have high positive weights on happiness while having neighbors association makes less happiness among women in the selected area.

Family and the family members are important social determinants of subjective well-being since family is identified as the small cluster. When the decision are making with more special occasion, it makes more complex with the group.

Working hours per week, working environment and trade union participation lead to less satisfaction while social validity, organizing events and nature of the job lead to high satisfaction.

Greater the social working environment increase subjective well-being but lack of family assistance limits well-being.

**IMPLICATIONS**

Women should encourage to participate in community societies or the volunteer works and should conduct awareness programmers to give an idea about the importance of those societies. Concerning the working status of the women, working places or the organizations should give the priority for the women and should provide needed leaves for women based on their requirements. Further, should be offered suitable duties in line with their skills and education level.

**REFERENCES (SELECTED)**

Andrews, F. M. and Withey, S. (1976). Social indicators of well-being American Perceptions of life-quality New York: Plenum Press. [Online] Available at: <http://link.springer.com/article/10.1007/BF01363887#page-1>. [Accessed on 26th September 2013]

Diener, E. (1984). Subjective Well-Being [online] Available at: [http://internal.psychology.illinois.edu/~ediener/Documents/Diener\\_1984.pdf](http://internal.psychology.illinois.edu/~ediener/Documents/Diener_1984.pdf). [Accessed on 15th March 2014]

Diener,E., Eunkook,M. S., Richard. L and Heidi,L.S. (1999). Subjective Well-Being: Three Decades of progress. [Online] Available at: [http://dipeco.economia.unimib.it/persona/stanca/ec/diener\\_suh\\_lucas\\_smith.pdf](http://dipeco.economia.unimib.it/persona/stanca/ec/diener_suh_lucas_smith.pdf). [Accessed on 11st December 2013]

Diener,E. and Suh, E.M. (2000). Subjective well-being across cultures Cambridge, MA: MIT Press. [Online] Available at:<http://scholarworks.gvsu.edu/cgi/viewcontent.cgi?article=1076&context=orpc> [Accessed on 15th March 2014]

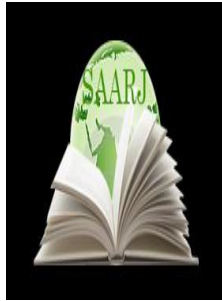

**ACADEMICIA**  
**An International**  
**Multidisciplinary**  
**Research Journal**  
 (Double Blind Refereed & Peer Reviewed Journal)



**DOI: 10.5958/2249-7137.2021.01011.9**

## SOCIO-ECONOMIC CHANGES IN UZBEK VILLAGES

**Makhmudov Makhmudbek Avazovich\***

\*Senior Lecturer,  
 Department of Social-humanitarian subjects,  
 Andijan State Medical Institute, UZBEKISTAN

### ABSTRACT

*In the context of the digitalization of a socially-oriented market economy, the main tasks of the state are to solve socio-economic problems, ensure the implementation of existing government programs, reduce poverty and improve living standards. It is known from the best practices in the world that public administration reform, raising democratic reforms to a new level does not happen by itself. This is a matter of many factors. One of them is to take into account the interests and aspirations of different segments of society, to pave the way for their realization. In this article, the socio-economic structure of villages and the socio-economic significance of changes in them in the context of a digitally oriented market economy are determined on the basis of analysis.*

**KEYWORDS:** *Socio-Economic Structure Of Villages, The Market Economy, Prosperous Rural Areas, Entrepreneurship, Poverty Reduction.*

### INTRODUCTION

The great creative work of recent years is the basis for the development of the socio-economic structure of the country's villages. New industrial enterprises, social facilities, housing, roads and bridges are being built in cities and villages. Entrepreneurship, trade and consumer services are developing rapidly, and living standards are rising [1-5].

It is known that the decrees of the head of state in 2018 adopted the programs "Obod Qishloq" and "Obod Mahalla". Within the framework of these programs, the conditions in 1,200 mahallas and villages inhabited by about 5 million people have been improved. But work on the issue was suspended last year due to a coronavirus pandemic. Today, there are 188 mahallas in 796 villages and cities with difficult conditions in the country. The electricity supply to more than 4,000 neighbourhoods is unsatisfactory. Only when the infrastructure goes to the villages, the quality of life will change, entrepreneurship will develop. Therefore, the programs "Obod

Qishloq" and "Obod Mahalla" were formed on the basis of new approaches. Along with beautification, the issues of job creation and lifting the population out of poverty are also envisaged. This year, a total of 21 trillion soums have been allocated for these programs. It was noted that from now on, local councils will determine which mahallas or villages will be included in the "Obod Qishloq" and "Obod Mahalla" programs. The deputy mayors of districts and cities on economics, construction and mahalla issues, together with the chairman of the mahalla, defend the necessary funds and the work to be done in the regional councils.

Particular attention is paid to the complex development of 325 villages and 71 mahallas with the difficult socio-economic situation. They have allocated 3 trillion 300 billion soums for the construction and repair of drinking water and electricity networks, internal roads and social facilities. Also, 2 trillion soums were allocated for the repair of more than 10,000 kilometres of internal roads in 2,721 mahallas, and 1 trillion soums for the construction of more than 4,000 kilometres of drinking water networks in 500 mahallas. Life itself shows that improving the power supply is urgent. Therefore, it is planned to upgrade 15,000 kilometres of power transmission lines and more than 4,000 transformers in 5,377 mahallas. This means 60% of the mahallas in our country. About 2 trillion 100 billion soums will be allocated for these measures. Also, together with the World Bank and the Asian Infrastructure Investment Bank, the Rural Infrastructure Development Project has launched projects worth 485 billion soums in 21 districts and 60 villages in Fergana, Andijan, Namangan, Syrdarya and Jizzakh regions [6-9]. Officials are tasked to complete all the planned work by November 1, using the funds effectively [10-12]. The government is taking comprehensive measures to provide employment and create new jobs in rural areas, including targeted sectoral and regional programs, and is introducing clusters and cooperation systems in agricultural production. Therefore, in 2019 alone, a total of 370047 new jobs were created in the country [7-9]. 64.3% of this figure is in rural areas. The goal is to link entrepreneurship and employment programs to the community, provide employment to 500,000 young people and 200,000 women, and lift 300,000 people out of poverty. For this purpose, 9 trillion soums will be allocated for Family Entrepreneurship programs this year, as well as small industrial zones will be established in 128 mahallas for 1 trillion soums.

379 schools, 171 preschools and 161 medical institutions will be built and repaired under the "Obod Qishloq" program, 57 schools, 37 kindergartens and 15 medical facilities will be built and repaired within the "Obod Mahalla" program. The Ministry of Health has been tasked to create a "medical map" of the settlements included in the "Obod Qishloq" and "Obod Mahalla" programs. Several measures are being taken to ensure the implementation of the Decree of the President of the Republic of Uzbekistan dated March 26, 2020 No PF-5975 "On measures to radically update the state policy on economic development and poverty reduction." Also, the Ministry of Economic Development and Poverty Reduction of the Republic of Uzbekistan and its affiliated organizations are effectively organizing the work in this area and fulfilling the tasks set.

## CONCLUSION

Creation of new jobs in key sectors of the rural economy, such as agriculture, processing industry, construction and building materials industry, services, based on the introduction of effective mechanisms, training of professionals and professions with the necessary demand and supply, as well as improvement of labour market infrastructure and labour migration, and the development of strategic directions for the development of organized surplus labour exports and

the forecast parameters of their achievement in the near future and their implementation will lead to the development of socio-economic structures in rural areas.

## REFERENCES

1. Абдурахмонов, Қ. (2020). Меҳнат иқтисодиёти. Назария ва амалиёт. Архив научных исследований.
2. Холмўминов, Ш., Хомитов, К., Арабов, Н., Бобаназарова, Ж., & Абдураманов, Х. (2020). Қишлоқ аҳолисини иш билан таъминлашнинг назарий ва амалий асослари. *Архив научных исследований*, (30).
3. Kholmuminov, Sh., Khomitov, K., Arabov, N., Abduramanov, X., Bobonazarova, J., & Saidov, N. (2020). Strategic directions of employment of the rural population. *Archive nauchnyx issledovaniy*, (3).
4. Kholmuminov Sh. Basics of developing complex models of digital technologies for regulation of relationships in the rural labor market (scientific article). Екатеринбург: Сборник научных статей II международной научно-практической конференции по цифровой экономике (ISCDE 2020)" – 2020.
5. Махмудов, М. (2020). Янги иқтисодий сиёсат йилларида ўзбек қишлоқларидаги ижтимоий-иқтисодий муносабатлар тарихидан (1925-1929 йиллар). *Academic research in educational sciences*, (3).
6. Махмудов, М. (2020). Махмудхон Махмудов Academic Research, Uzbekistan 664 www.ares.uz янги иқтисодий сиёсат йилларида ўзбек қишлоқларидаги ижтимоий-иқтисодий муносабатлар тарихидан (1925-1929 йиллар). *Архив исследований*, 1-9.
7. Najmiddin, T., & Saidalohonovich, K. A. (2020). About the origin and development of the universe, man, and accountability. *Journal of Critical Reviews*, 7(13), 1763-1769.
8. Atabaeva, Z. A., & Khojaev, A. S. (2020). Investment activity and analysis of investment projects. *ISJ Theoretical & Applied Science*, 5(85), 714-720.
9. Qosimov, L. M., Qosimova, S. F., & Tursunov, Q. Q. (2020). Specific aspects of using Ferghana region's pilgrims for touristic purposes. *Academic research in educational sciences*, (3).
10. Zikirov, M. C., Qosimova, S. F., & Qosimov, L. M. (2021). Direction of modern design activities. *Asian Journal of Multidimensional Research (AJMR)*, 10(2), 11-18.
11. Hakimova, S., Habijonov, S., & Hojaev, A. (2018). Statistical prognosis of the production of fruits and vegetables grown by farmers in the Fergana region. *Bulletin of Science and Practice*.
12. Khojaev, A. S., & Akramova, N. M. (2017). The ways of development and statistic analysis of farmers'activities specialized in fruit-vegetables production in the ferghana region. In *Экономика, управление и право: инновационное решение проблем* (pp. 45-47).



**ACADEMICIA**  
**An International**  
**Multidisciplinary**  
**Research Journal**  
 (Double Blind Refereed & Peer Reviewed Journal)

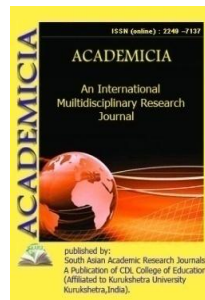

DOI: **10.5958/2249-7137.2021.01012.0**

**OBTAINING HIGH-MOLECULAR HYDROCARBONS FROM  
 SYNTHESIS GAS AND PHYSICO-CHEMICAL CHARACTERISTICS OF  
 THE CATALYST**

**Shukurov J.H\* ; Kunguratov K.A\* ; Ortiqov N.R\*\* ; Fayzullaev N.I\*\*\***

\*Academic Lyceum of Samarkand State University,  
 Samarkand, UZBEKISTAN

\*\*Karshi Engineering Economics Institute,  
 Karshi, UZBEKISTAN

\*\*\*Samarkand State University,  
 Samarkand, UZBEKISTAN

**ABSTRACT**

*The article studied the reaction of obtaining high-molecular hydrocarbons from the synthesis gas and the physicochemical characteristics of the catalyst containing Co-Fe-Ni-ZrO<sub>2</sub>/HSZ used in this process. The reason for the increase in selectivity in methane formation is, firstly, the acceleration of the hydrogenation reaction of CO in the methane formation centers with increasing synthesis temperature and secondly, the diffusion of CO and H<sub>2</sub> at different speeds through zeolite pores. In all fractions of hydrocarbons synthesized in the presence of hybrid catalysts, secondary changes: isoparaffins and olefins are formed due to cracking and isomerization. A large amount of isoparaffins is recorded for the composite catalyst - the iso/n parameter is 0.6, which indicates an increase in its activity relative to the catalysts absorbed in the hydrogenation reactions. For catalysts with low cobalt content, the concentrations of olefins will be high, which is due to their low hydrogenation ability compared to unsaturated hydrocarbons. In absorption catalysts, the hydrocarbon synthesis centers and the zeolite acid sites are in close contact with each other, which contributes to the intensification of secondary processes. However, the content of liquid hydrocarbons (C<sub>5</sub>-C<sub>18</sub>) in C<sub>5</sub>+ hydrocarbons is about 83%, which is 12% less than in the composite catalyst. No oxide-oxide interaction was found for the composite catalyst prepared by mixing the components, the pores of the zeolite are not blocked by cobalt, which allows the reagents to be efficiently delivered to the active part of the hydrocarbon synthesis.*



---

**KEYWORDS:** *Synthesis Gas, High Molecular Weight Hydrocarbons, Catalyst, IR Spectrum, Diffractogram.*

---

## INTRODUCTION

One of the most promising methods of obtaining motor fuel from carbon-containing sources, which is an alternative to oil, is GTL technology. Unlike petroleum products, synthetic fuels in practice do not contain aromatic mono and polycyclic compounds, organic sulfur and nitrogen compounds, and are environmentally friendly and high-quality consumer fuels [1-5]. In nature, the raw material base of synthetic fuels is widespread, consisting of carbon-containing materials - natural, petroleum gases, coal, biomass, etc. [6-11]. GTL technology involves the following steps: production of synthesis gas (a mixture of CO<sub>2</sub> and H<sub>2</sub>); catalytic conversion of synthesis gas to hydrocarbons by the Fisher-Tropsh method; separation of products into fractions of gasoline (C<sub>5</sub>-C<sub>10</sub>), diesel (C<sub>11</sub>-C<sub>18</sub>), wax (C<sub>19+</sub>) [12-16].

The main stage of GTL technology is the catalytic conversion of synthesis gas to hydrocarbons by the Fisher-Tropsh method (FT-synthesis). In the catalytic conversion of synthesis gas to hydrocarbons, cobalt, nickel, ruthenium, iron, etc., from group VIII metals with variable valence, exhibit catalytic activity.

Cr, Mo, W from group VI metals, Mb, Te, Re from group VII metals and Cu, Ag, Au from group IV metals increase the activity level of the catalyst to some extent [17-21]. In practice, two types of FT-synthesis are used in industry: low-temperature and high-temperature variants [22-23].

Low-temperature synthesis (LTFT) is carried out in cobalt or iron catalysts at temperatures below 300 °C. It forms mainly high-molecular-weight n-paraffins, n-olfinins and oxygen-containing components. High-temperature synthesis (NTFT) is carried out in an iron catalyst at temperatures above 300 °C. The product is mainly a mixture of hydrocarbons with a high content of olifin, which are used as the main raw material for many chemical processes. FT is characterized by a relative lack of isoparaffins for synthesis products, so the hydrocarbons being synthesized have a low octane number. The turbidity temperature and filtration norm of the diesel fraction are not very high, which makes it difficult to use these components as fuel.

Therefore, in both options it is necessary to change the composition of raw materials obtained in the production of motor fuel, which are hydrolysed by combining processes and cracking, isomerization and other processes according to the technological scheme [19-23]. It is advisable to intensify each stage of the process in order to demonstrate the workability of the GTL technologist in obtaining the motor fuel in the traditional way. One solution to this problem is to implement a single reactor by combining hydrocarbonar synthesized hydrolysis steps. This requires the development of new Effective Hybrid Catalysts. In the process of GTL technologist, blockchain-enabled mobile technology allows simple equipment to process petroleum gases and pastes pressurized gases of used gas cones in mining conditions. developed [15-22].

The aim of the work is to obtain high molecular weight hydrocarbon from synthesis-gas and to organize the physicist-chemical characteristic of catalysing.

## EXPERIMENTAL PART

In the synthesis of hydrocarbons from CO and H<sub>2</sub>, the catalytic properties of the catalysts were tested under the following optimal conditions in a flow isothermal reactor filled with 30 cm<sup>3</sup> of

quartz (catalyst layer 10 cm<sup>3</sup>): temperature range 280-300 °C, 0.5 MPa and volumetric velocity of gas flow (GHT) 1000 h<sup>-1</sup>. Balanced experiments were performed for at least 150 h, the incoming and outgoing gas composition was analyzed, and the amount of hydrocarbons and reaction water obtained was recorded. The activity of hydrocarbon synthesis catalysts was evaluated on the following indicators: CO conversion, selectivity and productivity for hydrocarbons. The calculation error did not exceed 2.5%.

CO conversion was calculated according to the following formula:

$$X_{CO} = \frac{V_{in} \cdot c(CO)_{in} - c(CO)_{out}}{V_{in} \cdot c(CO)_{in}} \cdot 100\%$$

where  $V_{in}$ ,  $V_{out}$  - gas consumption at the inlet and outlet of the reactor, dm<sup>3</sup>/h;

$c(CO)_{in}$ ,  $c(CO)_{out}$  - Co concentration at the inlet and outlet of the reactor, unit fraction. Methane selectivity was calculated according to the following formula:

$$S_{CH_4} = \frac{V(CO)_{CH_4}}{V(CO)_{np}} \cdot 100\%$$

where  $V(CO)_{CH_4}$  is the volume of CO used to produce methane, dm<sup>3</sup>;  $V(CO)_{conv}$  is the volume of CO converted to methane, dm<sup>3</sup>. Selectivity for C<sub>5</sub> + hydrocarbons was calculated using the formula:

$$S_{C_{5+}} = \frac{V(CO)_{C_{5+}}}{V(CO)_{conv}} \cdot 100\%$$

bu erda  $V(CO)_{C_{5+}}$  - C<sub>5+</sub> uglevodorodlarni hosil qilish uchun sarflangan CO hajmi, dm<sup>3</sup>.

C<sub>5+</sub> uglevodorodlari uchun unumdorlik quyidagi formula bo'yicha hisoblab chiqildi:

$$G_{C_{5+}} = \frac{m_{C_{5+}}}{V_{cat} \cdot \tau}$$

where  $m_{C_{5+}}$  - C<sub>5+</sub> - mass of hydrocarbons, kg;  $V_{cat}$  - catalyst volume, m<sup>3</sup>;  $\tau$  - time, hour.

Determination of the composition of synthesis products. The composition of gaseous synthesis products was analyzed on a chromatograph "Crystal 5000" (Chromatek, Russia) equipped with a thermal conductivity detector with gas adsorption chromatography and two columns with active Haysep R phase and NaX molecular sieves. Analysis mode The temperature can be programmed with a heating rate of 8 °C/min. The composition of C<sub>5+</sub> hydrocarbons was determined by capillary gas-liquid chroma-mass spectrometry on a gas chromatograph (Agilent, USA) equipped with a mass-selective detector MSD 5975C.

## RESULTS AND DISCUSSION

The study of the catalytic properties of the samples during the synthesis of hydrocarbons from CO and H<sub>2</sub> was carried out at a temperature of 290 °C, a pressure of 0.5 MPa, a volumetric velocity of the gas at 1000 h<sup>-1</sup> and a ratio of H<sub>2</sub>/CO=2. High-silicon zeolite derived from Navbahor bentonite was used as the catalyst holding agent [24-28].

The experimental data obtained are presented in Table 1. Analysis of the dependence of the conversion rate of CO on the synthesis temperature shows that the composite catalyst exhibits higher activity than the absorption catalysts in FT-synthesis. Despite a 3-fold decrease in cobalt

concentration, an increase in FT-synthesis temperature to 290 °C in the presence of a composite catalyst allows CO conversion rates to be increased by 74.2% and hydrocarbon C<sub>5</sub> + by 91.7 kg/m<sup>3</sup><sub>cat</sub>-hour. The FT-synthesis catalyst is comparable to similar values for Co-Fe-Ni-ZrO<sub>2</sub>/HSZ (Table 1).

**TABLE 1. CATALYST TEST RESULTS**

Catalyst	C <sub>CO</sub> , %	T, °C	X <sub>CO</sub> , %	selectivity, %				G <sub>C5+</sub> , kg/m <sup>3</sup> <sub>cat</sub> h
				CH <sub>4</sub>	C <sub>2</sub> -C <sub>4</sub>	CO <sub>2</sub>	C <sub>5+</sub>	
Co-Fe-Ni-ZrO <sub>2</sub> /HSZ	20,8	225	76,2	16,1	10,4	1,4	72,1	115,0

Note: X<sub>CO</sub> is the conversion rate of CO; Productivity for G<sub>C5+</sub> - C<sub>5+</sub> hydrocarbons.

Samples of hybrid catalysts are characterized by a decrease in the selectivity of C<sub>5+</sub> hydrocarbon formation to 58-66% relative to the Co-Fe-Ni-ZrO<sub>2</sub>/HSZ catalyst. The intensification of these intermediate processes - the formation of methane and hydrocarbons C<sub>2</sub>-C<sub>4</sub>, is associated with the reaction of water gas. The increase in selectivity in methane formation is due, on the one hand, to the acceleration of the hydrogenation reaction of CO at the methane formation centers and the diffusion of CO and H<sub>2</sub> at different rates through zeolite pores due to the increase in synthesis temperature. As mentioned above, a Co-Fe-Ni-ZrO<sub>2</sub>/HSZ catalyst of FT synthesis has been developed for the synthesis of high molecular weight hydrocarbons (C<sub>19+</sub>). Therefore, their content in C<sub>5+</sub> hydrocarbons reaches 46.7% (Table 2). The group composition of C<sub>5+</sub> hydrocarbons is characterized by paraffins of normal content, the content of isoparaffins and olefins does not exceed 3%. The molecular mass distribution of hydrocarbons is shown in Figure 1 below. In the diagram showing the distribution of the amount of hydrocarbons obtained according to the number of carbon atoms in the molecule, the main part of the obtained hydrocarbons includes up to 25 carbon atoms, a significant part - 25-35. The fractional composition of C<sub>5+</sub> hydrocarbons obtained in the presence of hybrid catalysts is mainly represented by liquid hydrocarbons (C<sub>5</sub>-C<sub>18</sub>), their content is 83% for absorbing catalysts and 95% for composite catalysts. This is mainly due to the cracking of C<sub>19+</sub> hydrocarbons in the acid center of the zeolite. Against the background of a decrease in the content of hydrocarbons C<sub>19+</sub> and partly C<sub>11</sub>-C<sub>18</sub>, an increase of C<sub>5</sub>-C<sub>10</sub> hydrocarbons by 24-34%, redistribution of products of synthesis of products obtained in the presence of FT-synthesis catalyst Co-Fe-Ni-ZrO<sub>2</sub>/HSZ compared to their content.

**TABLE 2. THE COMPOSITION OF THE OBTAINED S5 + HYDROCARBONS**

Catalyst	Hydrocarbons	Content, %			Total	iso/n
		C <sub>5</sub> -C <sub>10</sub>	C <sub>11</sub> -C <sub>18</sub>	C <sub>19+</sub>		
Co-Fe-Ni-ZrO <sub>2</sub> /HSZ	n-paraffins	17,2	34,7	45,5	97,4	0,02
	isoparaffins	0,4	0,6	0,8	1,8	
	olefins	0,1	0,3	0,4	0,8	
	Total	17,7	35,6	46,7	100	

Note: iso/n - isoparaffins: paraffin ratio

In all fractions of hydrocarbons synthesized in the presence of hybrid catalysts, a large amount of products of secondary transformations (cracking, isomerization) - isoparaffins and olefins were found. A large amount of isoparaffins is recorded for the composite catalyst - the iso/n parameter is 0.6, which indicates an increase in its activity relative to the catalysts absorbed in the hydro-

improvement reactions. High concentrations of olefins have been found for catalysts with low cobalt content, which is due to their low hydrogenation ability compared to unsaturated hydrocarbons.

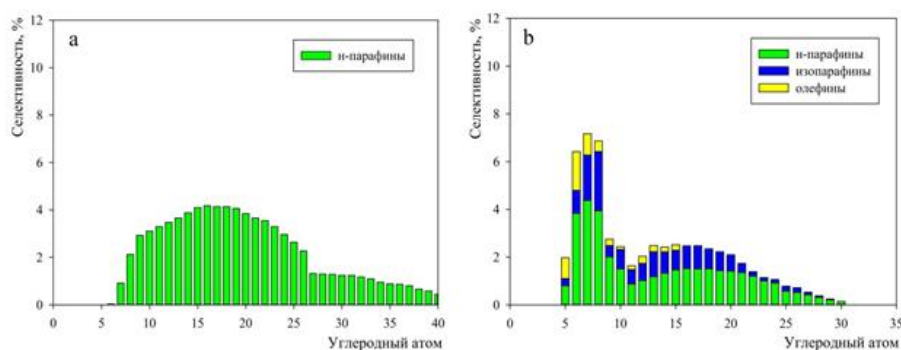

Figure 1. Molecular-mass distribution of  $C_{5+}$  hydrocarbons obtained in the presence of catalysts: a - Co-Fe-Ni-ZrO<sub>2</sub>/HSZ; b - absorbent, containing 6.5% cobalt.

The use of zeolite in hybrid catalysts allows the production of  $C_{5+}$  hydrocarbons whose molecular-mass distribution does not obey the AShF equation. Maximum MMD corresponds to  $C_5$ - $C_{10}$  hydrocarbons. The products mainly consist of liquid hydrocarbons. For selective catalysts, the selectivity in the formation of  $C_5$ - $C_{18}$  hydrocarbons is 46–49%, and for the composition, 62.6% (Fig. 1). Thus, the use of cobalt mixing and cobalt precipitation methods by absorption into the resulting carrier was found to have a significant effect on the physicochemical and catalytic properties of hybrid catalysts. The use of the absorption method to obtain hybrid catalysts creates a system that exhibits lower catalytic properties than a composite catalyst during the synthesis of hydrocarbons. This is probably due to both diffusion factors, the blockage of pores by sedimentary cobalt, and the formation of compounds of cobalt and aluminum oxides that are difficult to recover from the oxide-oxide interaction. In absorber catalysts, the hydrocarbon synthesis centers and the zeolite acid sites are in close contact with each other, which should contribute to the intensification of secondary processes.

However, the content of liquid hydrocarbons ( $C_5$ - $C_{18}$ ) in  $C_{5+}$  hydrocarbons is about 83%, which is 12% less than in the composite catalyst. No oxide-oxide interaction was found for the composite catalyst prepared by mixing the components, the pores of the zeolite are not blocked by cobalt, which allows the reagents to be efficiently delivered to the active part of the hydrocarbon synthesis. Such a catalyst has a high activity in the synthesis of hydrocarbons - the conversion rate of CO is 74.2%, the yield and selectivity for  $C_{5+}$  hydrocarbons is  $91.7 \text{ kg/m}^3_{\text{cat}} \cdot \text{h}$  and 66.5%. In a composite catalyst localized in silicon oxide, the acid center is not blocked by cobalt located above the silicon oxide in the Co-Fe-Ni-ZrO<sub>2</sub>/HSZ catalyst. There are both external and internal centers for hydrocarbons, as a result of which the composite catalyst increases the activity in hydrolysis reactions - the amount of liquid hydrocarbons reaches 95%. In this regard, the preferred method of preparation of hybrid catalysts is to mix the active components using a binder. Structure and phase composition of catalysts. The phase composition and structure of the catalysts were studied using RFA and IR spectroscopy. The radiographic image is the same for all samples (Figure 2)

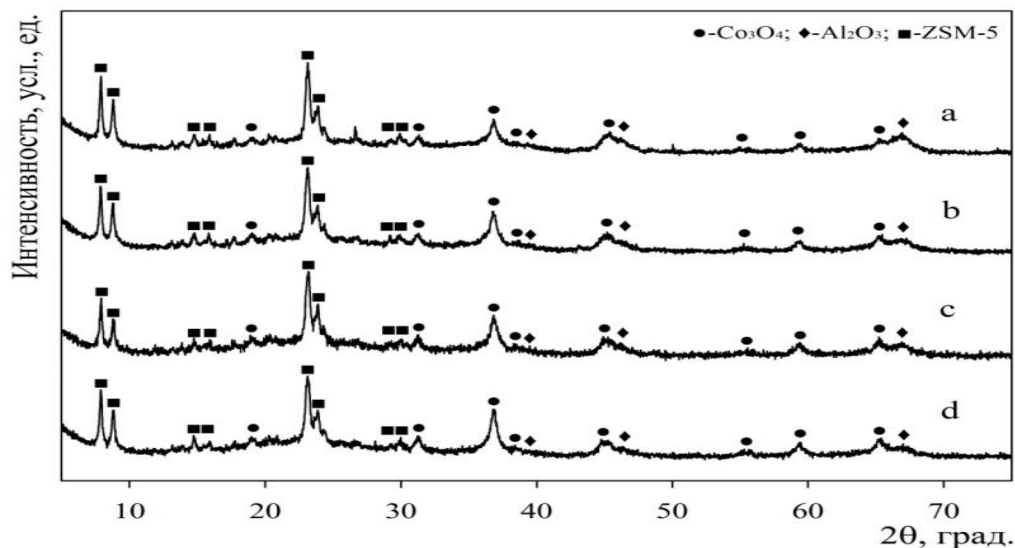

Figure 2. Diffractograms of catalysts containing different amounts of cobalt, %: a - 4.2; b - 6,3; c - 7,4; d - 8.4

The size of the  $\text{Co}_3\text{O}_4$  particles varies in the range of 10–12 nm, with no deviations recorded at the elemental cell parameter 8.088 Å in the  $\text{Co}_3\text{O}_4$  structure associated with the change in the components in the catalyst. According to IR spectroscopy data, no interaction of cobalt oxide with the catalyst components was observed (Fig. 3).

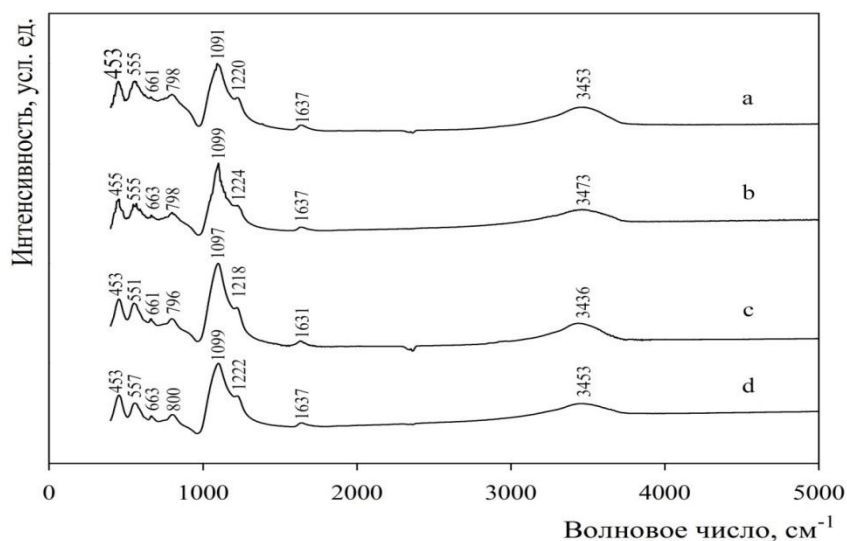

Figure 3 - IR spectra of catalysts of different cobalt content, %: a - 4.2; b - 6,3; c - 7,4; d - 8.4

By increasing the cobalt content in the catalysts, the intensity of the absorption bands corresponding to the  $\text{Co}^{2+}$  vs  $\text{Co}^{3+}$  oscillations increases. Between 3000-3700  $\text{cm}^{-1}$ , 1600-1650  $\text{cm}^{-1}$  and 750-850  $\text{cm}^{-1}$  the intensity of the absorbing bands varies with respect to the vibrations of the surface hydroxyl groups, the crystallization water and the Al-O bond, which is the aluminum content of the composite catalysts. associated with a decrease in the amount of oxide.

## CONCLUSION

Thus, the reaction of obtaining high-molecular hydrocarbons from the synthesis gas and the physicochemical characteristics of the catalyst containing Co-Fe-Ni-ZrO<sub>2</sub>/HSZ used in this process were studied. The reason for the increase in selectivity in methane formation is, firstly, the acceleration of the hydrogenation reaction of CO in the methane formation centres with increasing synthesis temperature and secondly, the diffusion of CO and H<sub>2</sub> at different speeds through zeolite pores. Secondary changes in all fractions of hydrocarbons synthesized in the presence of hybrid catalysts: isoparaffins and olefins are formed due to cracking and isomerization. A large amount of isoparaffins is recorded for the composite catalyst - the iso/n parameter is 0.6, which indicates an increase in its activity relative to the catalysts absorbed in the hydrogenation reactions. For catalysts with low cobalt content, the concentrations of olefins will be high, which is due to their low hydrogenation ability compared to unsaturated hydrocarbons. In the absorption catalysts, the hydrocarbon synthesis centres and the zeolite acid sites are in close contact with each other, which contributes to the intensification of secondary processes. However, the content of liquid hydrocarbons (C<sub>5</sub>-C<sub>18</sub>) in C<sub>5+</sub> hydrocarbons is about 83%, which is 12% less than in the composite catalyst. No oxide-oxide interaction was found for the composite catalyst prepared by mixing the components, the pores of the zeolite are not blocked by cobalt, which allows the reagents to be efficiently delivered to the active part of the hydrocarbon synthesis.

## REFERENCES

1. Алхимов, С. А., Григорьев, Д. А., & Михайлов, М. Н. (2013). Природа активных центров гибридных металл-цеолитных катализаторов синтеза Фишера-Тропша. *Известия Академии наук. Серия химическая*, (5), 1176-1176.
2. Алхимов, С. А., Григорьев, Д. А., & Михайлов, М. Н. (2014). Гибридные металл-цеолитные катализаторы синтеза Фишера-Тропша для получения фракции углеводородов C<sub>5</sub>-C<sub>18</sub>. *Катализ в промышленности*, (4), 31-41.
3. Пат. РФ 2493913 Российская Федерация, МПК В01J 37/04, В01J 37/02, В01J 35/00, В01J 37/16, В01J 23/75, С07С 1/04. Способ получения кобальтового катализатора синтеза жидких углеводородов по методу Фишера-Тропша / Протасов О.Н., Мамонов Н.А., Григорьев Д.А., Михайлов М.Н., Алхимов С.А.; заявитель и патентообладатель Общество с ограниченной ответственностью «Объединенный центр исследований и разработок». – No 2012136251/04; заявл. 24.08.2012; опубл. 27.09.2013, Бюл. No 27.
4. Ryu, J. H., Kang, S. H., Kim, J. H., Lee, Y. J., & Jun, K. W. (2015). Fischer-Tropsch synthesis on Co-Al<sub>2</sub>O<sub>3</sub>-(promoter)/ZSM5 hybrid catalysts for the production of gasoline range hydrocarbons. *Korean Journal of Chemical Engineering*, 32(10), 1993-1998.
5. Daramola, M. O., Matamela, K., & Sadare, O. O. (2017). Effect of CO<sub>2</sub> co-feeding on the conversion of syngas derived from waste to liquid fuel over a bi-functional Co/H-ZSM-5 catalyst. *Journal of environmental chemical engineering*, 5(1), 54-62.
6. Sartipi, S., Van Dijk, J. E., Gascon, J., & Kapteijn, F. (2013). Toward bifunctional catalysts for the direct conversion of syngas to gasoline range hydrocarbons: H-ZSM-5 coated Co versus H-ZSM-5 supported Co. *Applied Catalysis A: General*, 456, 11-22.

7. Chen, S., Wang, C., Li, J., Zhang, Y., Hong, J., Wen, X., & Liu, C. (2015). ZSM-5 seed-grafted SBA-15 as a high performance support for cobalt Fischer–Tropsch synthesis catalysts. *Catalysis Science & Technology*, 5(11), 4985-4990.
8. Lu, P., Sun, J., Zhu, P., Abe, T., Yang, R., Taguchi, A., ... & Tsubaki, N. (2015). Sputtered nano-cobalt on H-USY zeolite for selectively converting syngas to gasoline. *Journal of Energy Chemistry*, 24(5), 637-641.
9. Yao, M., Yao, N., Shao, Y., Han, Q., Ma, C., Yuan, C., ... & Li, X. (2014). New insight into the activity of ZSM-5 supported Co and CoRu bifunctional Fischer–Tropsch synthesis catalyst. *Chemical Engineering Journal*, 239, 408-415.
10. Jong, S. J., & Cheng, S. (1995). Reduction behavior and catalytic properties of cobalt containing ZSM-5 zeolites. *Applied Catalysis A: General*, 126(1), 51-66.
11. Hao, Q. Q., Wang, G. W., Liu, Z. T., Lu, J., & Liu, Z. W. (2010). Co/Pillared Clay Bifunctional Catalyst for Controlling the Product Distribution of Fischer–Tropsch Synthesis. *Industrial & engineering chemistry research*, 49(19), 9004-9011.
12. Espinosa, G., Domínguez, J. M., Morales-Pacheco, P., Tobon, A., Aguilar, M., & Benítez, J. (2011). Catalytic behavior of Co/(Nano $\beta$ -Zeolite) bifunctional catalysts for Fischer–Tropsch reactions. *Catalysis today*, 166(1), 47-52.
13. Sartipi, S., Alberts, M., Santos, V. P., Nasalevich, M., Gascon, J., & Kapteijn, F. (2014). Insights into the catalytic performance of mesoporous H-ZSM-5-supported cobalt in Fischer–Tropsch synthesis. *ChemCatChem*, 6(1), 142-151.
14. Ngamcharussrivichai, C., Imyim, A., Li, X., & Fujimoto, K. (2007). Active and Selective Bifunctional Catalyst for Gasoline Production through a Slurry-Phase Fischer–Tropsch Synthesis. *Industrial & engineering chemistry research*, 46(21), 6883-6890.
15. Liu, Y., Ersen, O., Meny, C., Luck, F., & Pham-Huu, C. (2014). Fischer–Tropsch reaction on a thermally conductive and reusable silicon carbide support. *ChemSusChem*, 7(5), 1218-1239.
16. Лapidус, А. Л., Крылова, А. Ю., Михайлова, Я. В., Синёва, Л. В., & Ерофеев, А. Б. (2011). Влияние природы носителя Со-катализатора на синтез углеводородов из СО, Н<sub>2</sub> и С<sub>2</sub>Н<sub>4</sub>. *Химия твердого топлива*, (2), 3-13.
17. Боресков, Г. К. (1986). Гетерогенный катализ. Из-во Наука. Москва. -304 с.
18. Крылов, О. В. (2004). Гетерогенный катализ. – 679 с.
19. Сливинский, Е. В., Клигер, Г. А., Кузьмин, А. Е., Абрамова, А. В., & Куликова, Е. А. (2003). Стратегия рационального использования природного газа и других углеродсодержащих соединений в производстве синтетического жидкого топлива и полупродуктов нефтехимии. *Рос. хим. журн. (Журн. Рос. хим. об-ва им. ДИ Менделеева)*, 47(6), 12-29.
20. Kibby, C., Jothimurugesan, K., Das, T., Lacheen, H. S., Rea, T., & Saxton, R. J. (2013). Chevron's gas conversion catalysis-hybrid catalysts for wax-free Fischer–Tropsch synthesis. *Catalysis Today*, 215, 131-141.

21. Steynberg, A. P., Dry, M. E., Davis, B. H., & Breman, B. B. (2004). Fischer-tropsch reactors. *Studies in Surface Science and Catalysis*, 152, 64-195.
22. Dry, M. E. (2002). The fischer-tropsch process: 1950–2000. *Catalysis today*, 71(3-4), 227-241.
23. Bobomurodova, S. Y., Fayzullaev, N. I., & Usmanova, K. A. (2020). Catalytic Aromatization of Oil Satellite Gases. *International Journal of Advanced Science and Technology*, 29(5), 3031-3039.
24. Fayzullaev, N. I., Bobomurodova, S. Y., Avalboev, G. A., Matchanova, M. B., & Norqulova, Z. T. (2020). Catalytic Change of C1-C4-Alkanes. *International Journal of Control and Automation*, 13(2), 827-835.
25. Mamadoliev, I. I., Fayzullaev, N. I., & Khalikov, K. M. (2020). Synthesis of High Silicon of Zeolites and Their Sorption Properties. *International Journal of Control and Automation*, 13(2), 703-709.
26. Mamadoliev, I. I., & Fayzullaev, N. I. (2020). Optimization of the Activation Conditions of High Silicon Zeolite. *International Journal of Advanced Science and Technology*, 29(03), 6807-6813.
27. Omanov, B. S., Xatamova, M. S., Fayzullaev, N. I., Musulmonov, N. K., & Asrorov, D. A. (2020). Optimization of Vinyl Acetate Synthesis Process. *International Journal of Control and Automation*, 13(1), 231-238.
28. Ibodullayevich, F. N., Yunusovna, B. S., & Anvarovna, X. D. (2020). Physico-chemical and texture characteristics of Zn-Zr/VKTS catalyst. *Journal of Critical Reviews*, 7(7), 917-920.





**ACADEMICIA**  
**An International  
 Multidisciplinary  
 Research Journal**  
 (Double Blind Refereed & Peer Reviewed Journal)

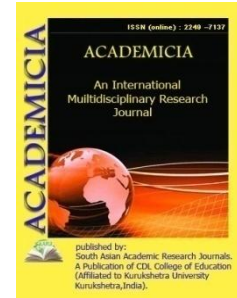

**DOI: 10.5958/2249-7137.2021.01043.0**

## ANALYSIS OF CHANGES IN FIBER PROPERTIES IN PROCESSES OPENING, CLEANING AND CARDING

**Sodikov Muhamad Rashid ogli\***; **Omonov Muhammad Turdialio'gli\*\***;  
**Tojimirzaev Sanjar Turdialievich\*\*\***; **Gofurov Adkhamjon Bahromjonogli\*\*\*\***

<sup>1,4</sup>Department Technology of Products of the Textile Industry,  
 Namangan institute of engineering and technology,  
 UZBEKISTAN

Email id: Sanjar.tojimirzaev@gmail.com

### ABSTRACT

*This article investigated and examined the change in the quality properties of cotton fiber and degree of purification. In the technological process of blowing, cleaning and carding. The basic purpose of this study determine the optimizing the technological parameters of blowing, cleaning and carding process for normal yarns by using fiber which is estimated as the average quality by the USTER®. Short fiber cotton was used to produce normal counts, i.e Ne 30 OE yarn spun on Autoconer 9 spinning frame. Yarn produced by spinning process from semi-finished products collected at different type technological parameters of spinning process shows variable yarn properties. The study of all these parameters plays important role to achieve better quality output of the spinning process.*

**KEYWORDS:** *Fiber Properties, Blowing, Cleaning, Carding, Neps, Optimization*

### I. INTRODUCTION

Cotton-spinning production has a number of features, which include the continuity of processes; a large number of interrelated and interdependent factors that determine the process; the presence of external and internal uncontrolled disturbing influences affecting the quality of raw materials, produced semi-finished products and yarn.

Depending on the degree of influence of each of these factors on the quality of raw materials, semi-finished products and yarn, and their interactions, deviations of the parameters of technological processes occur in time, which leads to fluctuations in their quality indicators.

Modern blowing and cleaning units blown cotton more finely, mix the components of the mixture better, more completely clean cotton from minor pollution, and create continuity of the production flow from a bale of cotton to the formation of a sliver on a carding machine.

Blowing and cleaning of fibrous material from trash impurities should be considered as two continuously connected and influencing processes, including several successive stages. A prerequisite for effective cleaning of raw materials with minimal damage to fibers is to ensure a high degree of blowing before entering the cleaners, since the latter can effectively remove only those minor pollutions and hard impurities that are on the surface of cotton shreds.

Blowing and cleaning of fibrous material is carried out on all machines of the production line, from the bale ripper directly to the carding machine. Many engineering firms in various versions produce modern blowing units. In the process of spinning, the technological systems for blowing, cleaning and carding of fibers are very diverse and the correct choice of maintaining the properties of the fiber in technological processes and maintaining the specified properties of the yarn is of great importance. In order to produce an even, clean yarn, the fibers must be completely separated from each other, sufficiently cleaned and evenly spaced in the product. In the production of textiles, the carding process is considered the most optimal and only technology for preparing fibers in the above form.

The carding process is carried out as a result of the interaction of a set of carding machines that cover the surfaces of the working parts.

The card clothing separates the fiber bundles into individual fibers, combing out small and tenacious impurities, as well as short fibers to waste, and in partial fiber orientation.

Therefore, the carding process plays an important role in determining the characteristics and properties of cotton yarns.

As a result of the fact that the rotational speed of the current carding machines has increased more than three times than that of the previous carding machines, that is, the main drum from  $200 \text{ min}^{-1}$  to  $900 \text{ min}^{-1}$ , the liker-in drum from  $700 \text{ min}^{-1}$  to  $2700 \text{ min}^{-1}$ , the speed of movement of the flats increased from  $0.1 \text{ m / min}$  to  $0.4 \text{ m / min}$ , respectively, in the technological transitions of the spinning process, changes in the qualitative properties of the fiber occur and, accordingly, the structure of the yarn also changes.

Therefore, the effective use of raw materials in the production of yarn and a thorough study of the effect of changes in the structural indicators of fibers on the structural indicators of the yarn during technological transitions has become an urgent problem.

In addition, optimization of technological processes based on the study of factors that affect the structure and properties of the yarn is essential in improving the spinning efficiency.

Despite the fact that the performance of spinning mills significantly grow, some key problems still await solution in the process of yarn production, including:

Identifying the cause of defects (IPI) on the yarn and ways to eliminate them;

An increase in the yield of yarn from fiber with an increase in production productivity;

In achieving, in terms of the quality of cotton yarn, a state of competitive high quality, corresponding to the demand of the world market.

As a solution to these problems, the need to identify the optimal parameters of the working parts of machines in the technological process of spinning is mentioned.

To date, there are no universal methods and recommendations for improving the quality of products manufactured by enterprises operating on modern equipment.

To accomplish these tasks, it will be necessary to determine the optimal parameters of the working parts of technological machines.

To ensure the rational use of raw materials, to ensure quality products and semi-finished products, it is necessary to conduct more and more scientific research, based on which to optimize the technological parameters of refueling equipment, to design new solutions that will effectively solve the tasks set for the cotton spinning industry. Today, the issues of studying the dependence of yarn properties on the raw materials used and technological parameters of machines are very relevant and in demand.

The study of changes in the properties of fibers and semi-finished products during production passing through the sequence of technological processes is the main direction of increasing the efficiency of not only spinning production, but also the production of finished textile products. Because the performance of subsequent transitions depends on the preservation of the natural properties of the fibers and the unevenness of semi-finished products, from blowing the bale to the production of finished fabric.

Cotton fiber, from the process of its collection to the production of finished products, passes through many processes, where it is constantly exposed to humidity, temperature, working parts of machines, which leads to damage to the cotton fiber [1].

Mechanical and biological damage to fibers ultimately leads to a decrease in the natural properties of the fiber, such as fiber length, strength, elongation index, elongation at break, an increase in the content of trash impurities, short fibers, which directly affects the quality of the yarn produced. A change in the structure of a fiber under biological action leads to a decrease in its strength characteristics, and under the action of the working parts of machines installed in the technological process; it increases the damage to the fibers. If we take into account that the fiber passes through several technological processes, where it is subjected to mechanical stress, then by the end of these processes it loses its original properties. Based on this, it can be concluded that in order to preserve the natural properties of the fiber, it is necessary to reduce the processes of exposure of the working parts to it in each technological process, and also the processes must be carried out in the optimal technological mode [2], [3].

The analysis of the research work carried out showed that with mechanical damage to the fiber, fine fractures appear on its surface the formation of these fractures on their surface leads to a decrease in the quality indicators of the fiber, such as strength and elongation at break.

As a result of our research, it was found that endless mechanical stress on the fiber leads to its damage. To determine the level of influence of the mechanical action of the working parts of machines on the properties of the fiber, we carried out experiments, as a result of which the degree of mechanical damage was determined by the transitions of the spinning industry.

## II. MATERIAL AND METHOD:

During the experiment, we used medium-staple cotton of type 4, grade I, selection C 6524, which was processed in a Blowroom for blowing and cleaning and subsequent feeding for carding. The experiments were carried out using technological equipment from TRUTZSCHLER® (Blowroom line and Card TC-19i) [4].

## III. TECHNOLOGICAL PART:

During the experiments, fiber samples were taken from each transition machine by random sampling. Cotton samples were tested on laboratory equipment AFIS [5]. The investigated properties of a cotton fiber sample are shown in Table 1.

**TABLE 1 FIBER PROPERTIES BY TRANSITIONS, TESTING IN AFIS EQUIPMENT**

ITEM of process	Tot Nep Cnt [cnt/g]	SC Nep Cnt [cnt/g]	SFC(w) % < 12,7 mm	Maturity [mat1]	Fineness [mteks]	UQL(w) [mm]	Trash Cnt [Cnt/g]
Blendomat BO-A	211	35	6,9	0,91	169,0	30,5	39
SP-MF	203	21	7,4	0,90	164,0	30,4	45
CL-P	213	27	5,5	0,91	163,0	30,8	59
MX-I	689	15	5,5	0,90	161,0	30,9	29
CL-C3	298	31	5,5	0,89	158,0	31,2	51
SP-DX	307	27	4,9	0,89	160,0	30,6	32
Feed shute	337	33	5,8	0,89	157,0	30,8	26
CNUFT	293	19	5,1	0,89	159,0	30,8	33
CARDCHUTE-08L2	380	23	6,6	0,87	159,0	28,6	31
Liker-in	423	76	10,6	0,88	162,0	27,1	284
TwinToprear	1 095	202	37,8	0,79	149,0	22,6	467
Top flat	703	343	8,3	0,91	177,0	27,7	277
Twin top	549	60	46,0	0,79	156,0	20,8	63
TC -19i CARD sliver	103	12	5,7	0,95	176,0	29,4	1

Table 1 shows the results of changes in the properties of fibers obtained in the process of opening, cleaning and carding. Qualitative indicators such as the number of Neps in the initial stages of processing increase, the content of short fibers varies unevenly after each transition of cotton fiber processing. This can be explained by the influence of the dynamic and mechanical effects of the working parts of the machines in the process of blowing, cleaning and carding the fibers.

An increase in Neps can lead to problems in the finished yarn, and affects an increase in the IPI value [5].

Which directly requires even more attention to research in these transitions of the spinning process.

To facilitate the analysis of the results obtained, histograms were drawn up on the change in the properties of the processed fiber in each transition.

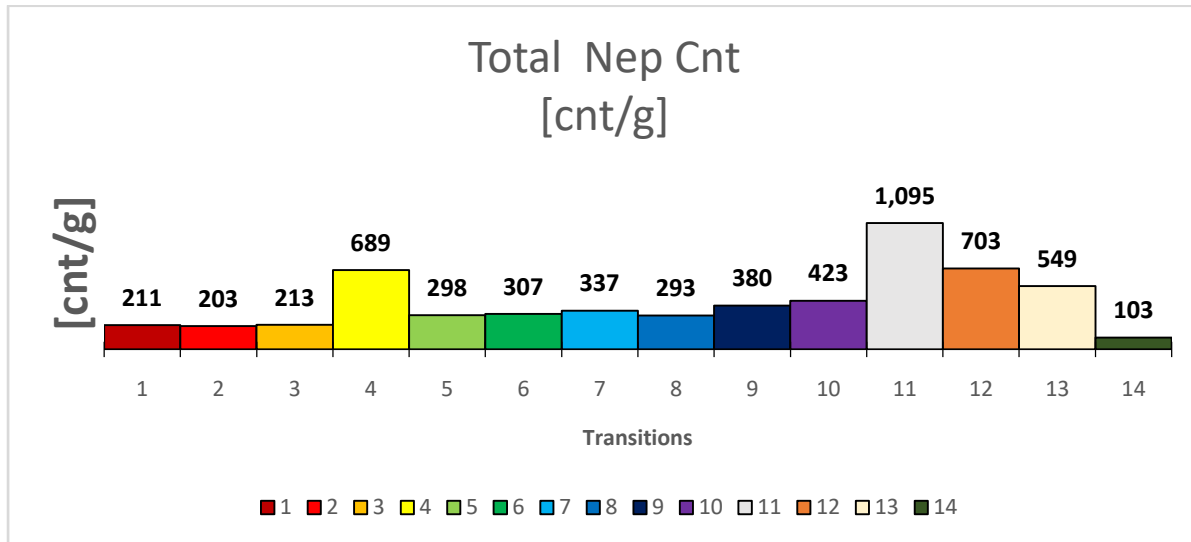

**Fig-1.** Change the q of Neps by transitions

Where is,

- 1- neps count after BLENDOMAT BO-A
- 2- neps count after the SP-MF separator
- 3- neps count after pre-cleaner CL-P
- 4- neps count after the MX-I mixer
- 5- neps count after the CL-C3 cleaner
- 6- neps count after the SP-PX separator
- 7- neps count to the receiving hopper of the carding machine
- 8- neps count after CNUFT
- 9- neps count after CARD CHUTE receiving hopper
- 10- neps count after the liker-in drum of the carding machine
- 11- neps count after the back segment of the card
- 12- neps count after the carding machine
- 13- neps count after the front segment of the carding machine
- 14- neps count in the carding sliver

**TABLE 2 TECHNOLOGICAL PARAMETERS OF TC 19I CARDING MACHINES**

Item of parameter	Parameters
Feed speed	500-600
Taker-in speed	1250
Cylinder speed	520
Flat speed	320
Delivery speed	200
Total number of flats in rotation	99
Cylinder to flat distance (in five different positions from back to front)	Position 1: 0,250 position 2: 0,250 position 3: 0,220 position 4: 0,220 position 5: 0,200

From the Pic 1. on histogram, you can determine what, the number of neps after cleaning processes on the CL-P machines. CL-C3, the take-up drum of the carding machine, where the serrated sets act on the fiber sharply, increases. Towards the end of the carding process, the number of neps decreases under the influence of fixed flat segments and a flat blade. From the constructed histograms, one can come to the following understandings: during the process of blowing, cleaning and carding, it is necessary to optimize the operating parameters of the working parts of the machines, such as distribution and speed, as well as the pressure of the air suction [6].

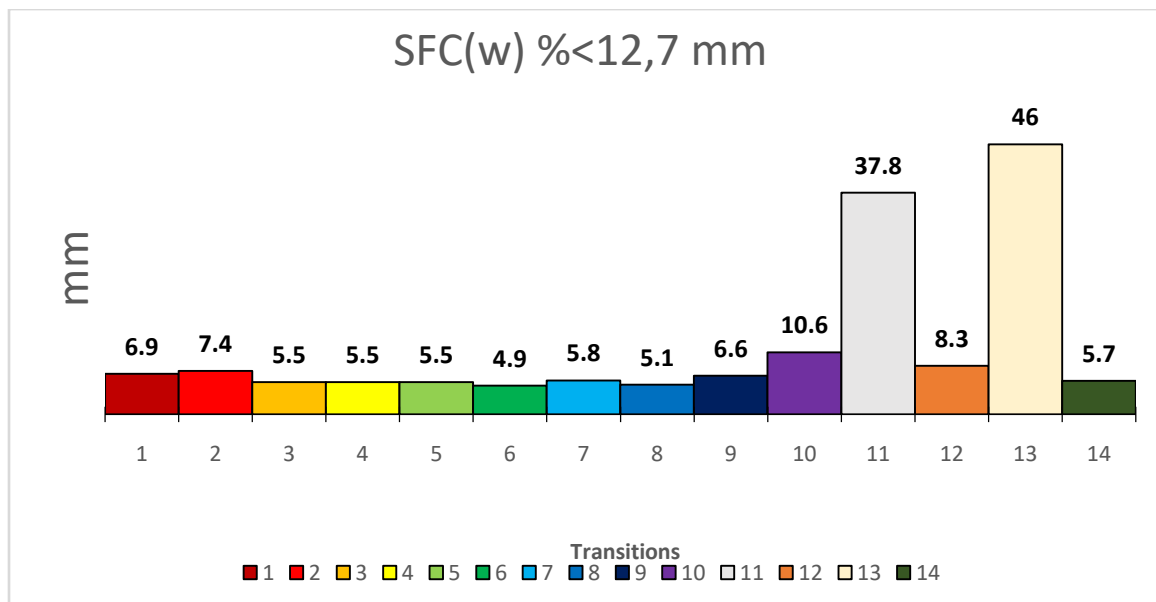
**Fig-2.** Change in the number of short fibers by transition.

As can be seen from the histogram in Fig-2, the number of short fibers increases in the process of carding the fibers on the back and front carding segments, since after the carding segments the proportion of short fibers should have decreased, but in our version the opposite happened, which leads to the idea that the fibers have places of mechanical damage and the card itself can become an object of improvement or decrease in the quality characteristics of fibers. That requires special attention to the establishment of the operating parameters of technological machines.

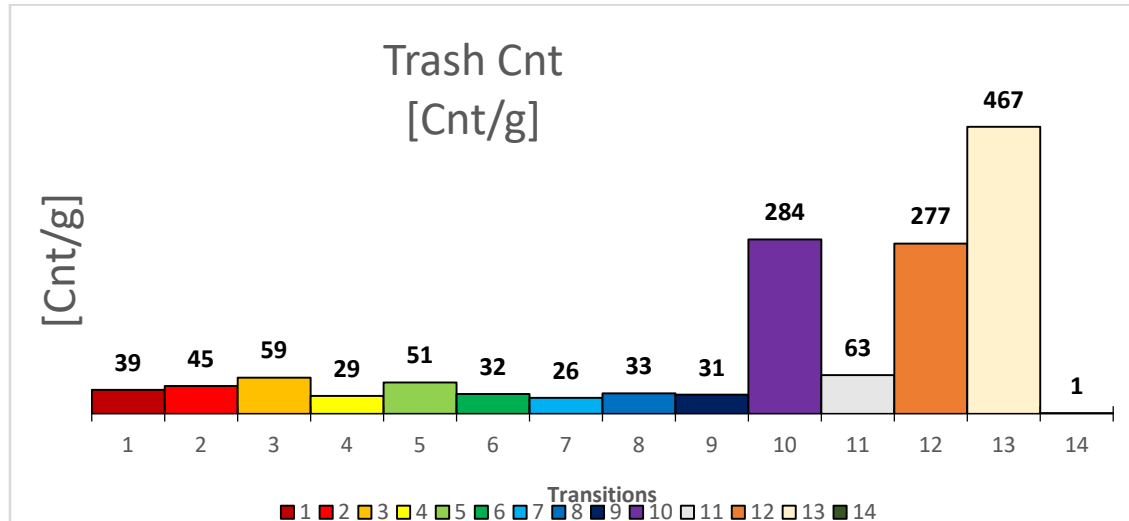

**Fig-3.** Change in the count of trash by passages

The results obtained show that each machine, depending on the type of set of working parts, affects the degree of cleaning of the processed material. It can be seen from the histograms in Fig-3 that the Blowing - cleaning unit has the greatest cleaning effect, while on these units, defects, neps, cotton waste, dust and fiber fluff, cotton leaves and non-spinning fibers are removed.

The final in-depth cleaning of the fiber is applied by carding machines. It was found that an increase in the speed of preliminary carding with the receiving drum leads to intensive separation of fibers and the impact of the teeth of the card clothing leading to grinding (in micron sizes) trash impurities. As our analyzes show, after the receiving drum (liker-in), the proportion of trash impurities increased. There is also an increase in fiber breakage and neps removal efficiency. The result is an increase in the IPI and hairiness of the yarn and also a decrease in the strength in a single yarn.

#### IV. CONCOLUTION:

1. In the course of the study, the influence of the settings of technological machines in Blow room and carding machines on the change in the main quality properties of cotton fiber, improving the indicators of neps and uneven quality indicators of the carding sliver was studied.
2. It has been determined that the carding process has a significant effect on the quality properties of cotton fibers and plays an important role in improving them.

3. The optimal technological parameters for the production of ribbons for yarn produced for weaving and knitting purposes have been developed, which allows increasing the productivity of carding machines up to 80-100 kg / hour.
4. The results of theoretical and experimental studies on increasing the efficiency of carding machines, improving the quality of combed fibers and optimizing the technological parameters of the fiber processing process are considered.

## V. ACKNOWLEDGMENT

The authors is also highly grateful to staff of Tashkent institute of light and textile industry to prof. K. Gofurov for their support and guidance.

## VI. DECLARATION OF CONFLICTING INTERESTS

The author(s) declared no potential conflicts of interest with respect to the research, authorship, and/or publication of this article.

## REFERENCES:

1. Д.Э. Казакова, К.Ж. Жуманиязов. Влияние различного смесового состава на механическую поврежденность и длину волокна по переходам прядильного производства.
2. Karch N.V., Malakane P.B., Cadole P.V. Studies on Fiber Migration in the Spinning Process // *Artificial Textiles in India*. – 46 (4), 2018. P. 123...126.
3. Gunaydin G.K., Soydan A.S., Palamutsu S. Evaluation of the properties of cotton fiber in spinning processes of compact yarn and the study of the properties of fiber and yarn // *Fibers and Textiles in Eastern Europe*. – 26 (3), 2018. P. 23...34.
4. Card TC 15-Brochure, Trutzschler Spinning, Trützschler GmbH & Co. KG Textilmaschinenfabrik, Mönchengladbach, Germany [Электронныйресурс]. – <https://www.truetzschler-spinning.de/en/products/card/technical-highlights/>
5. Sanjar, Tojimirzayev et al. "Influence of short fibers on the quality characteristics of the product, yield of yarn and waste of cotton fiber." *International journal of innovation and scientific research* 6 (2014): 44-49.  
<https://www.semanticscholar.org/paper/Influence-of-short-fibers-on-the-quality-of-the-of-Sanjar-Baxramovna/47df6e1e142c0da0a219345aefe02f1b7b7a1e19>
6. TojimirzaevSanjarTurdialiyevich; ParpievKhabibulla. "The Influence Of Top Flat Speed Of Carding Mashine On The Sliver And Yarn Quality". *European Journal of Molecular & Clinical Medicine*, 7, 7, 2020, 789-797. [https://ejmcm.com/article\\_3287.html](https://ejmcm.com/article_3287.html)
7. СТ Тожимирзаев, УХ Мелибоев, Х Парпиев -Исследование влияния скорости выпуска чесания на качественные свойства пряжи // *EuropeanJournalofTechnicalandNaturalSciences*, Volume 4, 2020 pp 7-14. <https://www.elibrary.ru/item.asp?id=44206345>
8. Парпиев Х. и др. Влияние микронейра хлопкового волокна на качество пряжи // *Физика волокнистых материалов: структура, свойства, наукоемкие технологии и материалы (SMARTEX)*. – 2017. – №. 1. – С. 358-362. <https://smartex2.ivgpu.com/wp-content/uploads/2019/08/358-362.pdf>



**9.** Korabayev Sh.A; Mardonov B.M; Matismailov S.L; Meliboyev U.X “Determination of the Law of Motion of the Yarn in the Spin Intensifier”, Engineering, 2019, 11, 300-306.

<https://www.scirp.org/journal/paperinformation.aspx?paperid=92784>

**10.** Korabayev Sh.A; Matismailov S.L; Yuldashev A.T., Atanbayev D.D. (2020) “Study Of Fiber Movement Outside The Crater Of Pnevnomechanical Spinning Machine”, Solid State Technology. Vol. 63 : Iss. 6. Pages 3460-3466.

<http://www.solidstatetechnology.us/index.php/JSST/article/view/3473>

**11.** RuiyangLu .YucongYu .GafurovAdkhamjon .Wenli Gong. Xiaoqing Sun . Lin Liu. (2020) Bio-inspired cotton fabric with superhydrophobicity for high-efficiency self-cleaning and oil/water separation. Cellulose (2020) 27:7283–7296.

<https://doi.org/10.1007/s10570-020-03281-9>

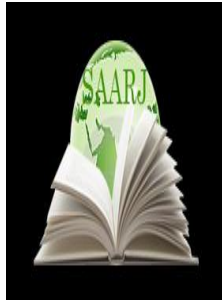

**ACADEMICIA**  
**An International  
 Multidisciplinary  
 Research Journal**  
 (Double Blind Refereed & Peer Reviewed Journal)



**DOI: 10.5958/2249-7137.2021.01021.1**

## THE CONFLICT OF WORDS AND SPIRIT IN ALISHER NAZAR'S POETRY

**Kurbanbayev Ilhombek Aminbayevich\***

\* Docent,

Head of the Department "Uzbek language and literature",  
 Candidate of Philological Sciences,  
 Karakalpak State University name of Berdakh,  
 UZBEKISTAN  
 Email id: [ilxombek.1974@mail.ru](mailto:ilxombek.1974@mail.ru)

### ABSTRACT

*The article analyzes the originality of literary interpretation in poetry, the contradiction of words and spirit in the formation of poetic perception, the combination of expression and description in methodological research on the example of AlisherNazar, one of the representatives of modern Uzbek lyric poetry. It examines the status of form and content in the evolution of the poet's narrative technique, the use of metaphors and semantic shifts, the ways in which emotional perception and philosophical observation intertwine, and the degree to which artistic speech and interpretation skills are appropriate. The human psyche is, in fact, inherent in the creative skill of grasping the mysteries of the subtleties and feeling the delicate image of the situation and reviving the feeling in a vivid imagination. The concentration of tone, music, and analysis in a poem that combines concept-symbol-image-idea determines aesthetic value.*

**KEYWORDS:** *Poetry, Literary interpretation, Creative worldview, analytical skills, artistic speech, image bubble, depth of expression, aesthetic ideal, situation, formal conciseness, philosophical generalization, evaluation criteria, methodological research, psychological analysis, artistic skills, emotional perception.*

### INTRODUCTION

Poetic speech, figurative thinking and creative inclination always strive for a level of originality. It is natural that the creative nature of the poem is detached from the spirit of the nation, which is colored by the unique potential of art! The metaphor used by the poet and the symbol he created actually summarize certain aspects of the character. In writing, the natural flow of image bubbles

and expression independence is welded to artistic mastery. It is the technique of narration to direct the disturbed mood to the depths of philosophical observation, to connect the vital need with the poetic passion. In this sense, given that the logical development of each poet's artistic concept tends to originality, it becomes clear that there are scientific gaps in science. At the same time, each creative worldview is markedly differentiated by aesthetic choice, perception, and renewal of imagination. An analysis of the extent of the conflict of words and spirit in poetry on the example of AlisherNazar's poetry determines the relevance of the topic.

Poetic speech, figurative thinking and creative inclination always strive for a level of originality. It is natural that the creative nature of the poem is detached from the spirit of the nation, which is colored by the unique potential of art! The metaphor used by the poet and the symbol he created actually summarize certain aspects of the character. In writing, the natural flow of image bubbles and expression independence is welded to artistic mastery. It is the technique of narration to direct the disturbed mood to the depths of philosophical observation, to connect the vital need with the poetic passion. In this sense, given that the logical development of each poet's artistic concept tends to originality, it becomes clear that there are scientific gaps in science. At the same time, each creative worldview is markedly differentiated by aesthetic choice, perception, and renewal of imagination. An analysis of the extent of the conflict of words and spirit in poetry on the example of AlisherNazar's poetry determines the relevance of the topic.

### LITERATURE REVIEW

Usually, in the poet's poetry, the conflict of words and spirit creates an artistic unity. More precisely, the synthesis of consciousness and worldview is a key factor in determining the separation of artistic speech, in which emotion complements observation, in which the power of expression in observation is determined. At the level of lyric theory, there is some experience in analyzing the creative worldview in terms of the integrity of words, imagination, and images. In particular, B. Nazarov's "Life is a benign criterion" (Tashkent, 1985), I. Gafurov's "Heart of lyrics" (Tashkent, 1982), K. Yuldashev's "Burning word" (Tashkent, 2006), N. Rakhimjanov's "Period and Uzbek lyrics" (Tashkent, 1979), N. Jabborov's "Time, criteria, poetry" (Tashkent, 2015), A. Sabirdinov's "Words and images in Oybek's poetry" (Tashkent, 1993), B. Akramov's "Problem of poetic image in modern Uzbek lyric" (Tashkent, 1991), J. Jumaboyeva's "Psychological image skills in XX century Uzbek poetry" (Tashkent, 1999), B. Norbaev's "Poetic life Principles of Interpretation and Problems of Mastery" (Tashkent, 1996). The study of a certain stage of period poetry in historical terms, the study of the laws of literary development in relation to the creative worldview, reveals the poet's individual skills. In fact, the subject of the lyrical image differs from the emotional perception in the style of expression that creates the philosophical observation. The mix of aesthetic choice and creative worldview individualizes artistic speech. The current situation is welded by the use of metaphors, the effective use of the image calendar, the determination of the poetic harmony of words and moods. The breadth of natural imagination depends on the concept of artistic mastery! The sense of meaning that combines constant change and continuous action is nourished by the creative nature. AlisherNazar's work, although creating a unique artistic discourse, has not yet been analyzed as a holistic problem as an object of special research.

## RESEARCH METHODOLOGY

The analysis of the creative worldview of each artist as a whole poetic structure provides a basis for evaluating the word-image-idea relationship at the level of the historical principle. In the present case, the sequence of life logic is replaced by artistic conditionality. Perception, formed by the influence of real reality, centralizes the situation. There are three main centers that define AlisherNazar's lyrics: word shift, artistic speech development, and text poetic system! The possibility of interpretation and analysis organizes the trinity in the system. In subtle observation and vivid observation, the poet's style of expression is characterized by a deepening of the imaginative perception of the way of the image, in which the state of the scene governs the emotional thinking, in which the narrative technique describes the creative nature. In the author's writings, an attractive temperature, inner harmony and aesthetic energy define the expression. The path of the image, moving from the perceived reality to the unexplained essence, formalizes the reality of the senses in a way that transfers meaning. The poet's tendency to form a solid psychedelic analysis of the reality of a changing being adorns his methodological pursuits, in which a high and intense observation, an attractive and impressive emotional upheaval, a gentle and elegant tone predominate. The transition from emotional to emotional states requires a sense of urgency. At the heart of the integrity of sign-concept-imagination-word-idea is the gradual evolution of the spiritual experience of the creative nature.

## ANALYSIS AND RESULTS

Poetic discourse, a mixture of words and ideas, always seeks to renew the literary essence. In the perception restored in the sense of perception, the philosophical perfection manifests itself in the uniqueness of the expression. In fact, the combination of subtle observation and live observation is a leading factor in shaping the philosophy of poetry, and the narrative technique puts the creative worldview into a specific system. In a poetic way that confronts the synthesis of imagination and imagination in relation to each other, relationship management plays a crucial role. A metaphor from nature, an analysis of the psyche, and a sense of emotion are the subtle qualities of true talent, the scale of the imagination in the line of the state that emerges from the emotions. The collection of form and content in expression depends on a particular poetic talent, in which the perception of melody and music integrates the delicate landscape. The desire to penetrate the deepest layers of the human senses and the desire to materialize the image define the nature of magical art. It includes the right to spiritual inviolability, the product of spiritual need, and the logical change of meaning:

U tunnisiqorar – qismatmayini,

Ko'zlaridabedormunglixotira.

Osmoneshiklarinochadiasta,

Quyoshchiqibkellar...

Tongotmassira [2, 29].

AlisherNazar's work has a significant place in the history of Uzbek poetry during the period of national independence. In magical art, which strangely combines the harmony of emotion and observation, the depiction of the state of mind evokes a sense of poetic perception. The unique style of expression created by the poet, the level of specificity of artistic speech deepens the

imagination, brightens the image, and most importantly, the natural flow of thoughts rapidly occupies the human mind. The ability to analyze the situation in the mood, which is formed with the help of artistic expression, is polished. The regular exchange of emotions and observations is a key factor in determining the philosophy of poetry, in which the power of meaning and the power of form complement each other, in which the psyche of image and the independence of expression are combined, in which the paradoxical relationship serves to distinguish the lyrical image. . In the author's writings there is a tendency to organize mood-action-mood during imagination. The bubble image and the dark rhythm of expression are vividly reflected in the poet's collections of poems "Mornings for Us" (1999) and "Vola" (2014). The desire to portray the human psyche in a philosophical tone defines the creative nature. "Alisher's poems can be said to consist of confessions about him. He is a creator who believes that the way to the world and humanity passes only through himself, his heart and deeds. In many poems, either emotion or thought predominates. A. Nazar's lyrics are the result of the combination of thoughts with feelings and emotions with thoughts. Nor does he want y to be left behind by emotions" [3, 401]. The balance between emotion and observation is, in fact, the discipline of poetic logic. The artistic goal achieves aesthetic power in the sense of perception, the rhythm in the perfection of thought. The natural tone of the word is rounded to the brim. Every impression in a person's emotional thinking reflects a creative essence. The practice of perception, perception, and comprehension creates in the poetic worldview the originality of expression — the uniqueness of the image — the spiritual experience.

The poet enlivens the image of suffering in elegant lines. The "trembling of the night to the heart" is a heavy pain, sealed with "a sad memory in his eyes"! "Stars in the sky," "crazy winds," and "moon's sickle" - comparisons from nature - are specialized in expressing mood. The bright expression (the evening slowly pours into the heart, the stone begins to shoot, the stars in the sky) and the bubble image (the night shakes, fills, waves) provide an aesthetic impression of the thought. Philosophical emphasis (when the sun rises) strengthens the student's confidence in the future. The phrase "never wake up" embodies the weight of the riot in the heart of the lyrical hero. The state of a person, which is roasted in the embrace of anxiety and imagination, is strained by attractive metaphors. "Suffering" is a general term that focuses on confession and hope, hope and desire, confidence and opportunity, imagination and impression:

Shu so'zgao'xshaydiaslitiriklik,  
Aslsaodat ham shundanboshlanar.  
Bu so'znishunchakiaytako'rmagil,  
Ortidanqontuflayolmasang, agar [2, 36].

In the five-line poem "Liberty", the author focuses on the analysis of "the feeling of the blood of the ancestors." The poet's relational speech lays the groundwork for the maintenance of mental tension in the artistic cells of the whole text. In the feeling of rising to the level of "the greatest joy, the greatest cry" in the life of the nation, "there is a spirit of evil heroes!" In the eyes of the Creator, freedom has the status of "the root word of faith", freedom "the word that awakened so many martyrs", spiritual inviolability "the great word that leads to the truth"! It contains the essence of the "real life", in which "the real happiness begins", in which the ancient history is "aware of the distant past!" The blessing of Allah is not easily achieved, it is as dear and dear to the Uzbeks as the "holy word"! It is as if the "sound of swords" is a sign of great tragedy ... The

more difficult it is to achieve freedom, the more difficult it is to protect it, based on the lyrical hero's appeal "Carefully embrace him, hide him in the depths of your heart forever." There is a reference to "The art of the artist is that he strives to capture every word, the meaning of the situation, in a bus-whole, to penetrate into the essence of the word" [4, 149]. The weight of the word depends on the strength of the poetic idea, which is equated to it, and the logical emphasis of meaning harmonizes the tone and rhythm. The truthfulness of the feeling and the perfection of the observation are in fact derived from the grasp of the vital beliefs:

Yarimkecha.

Yarim dil...

Shamollarboshlarxonish.

Orzugatilaboqyo'l,

Mudrabyotaditashvish [2, 61].

In a poetic scene, nature comes to life: a subtle life analogy (midnight-half-tongue) controls the movement of emotions. The poem is dedicated to the "mystery of existence" - the beginning and end of life. In a strange way, "a white path to a dream, a drowsy anxiety", in the world of "forty years of mourning, the head of dreams is bowed". The hardships of the "white horse - life" do not allow dreams to be "filled" all the time. And yet, "The blue thermals giryon, wrinkle the world!" In the author's literary interpretation, reality serves as a determinant of state and mood. "Singing the heads of the winds" - a symbol of hope and confidence, the white horse - describes the symbol of happiness. In the present case, the reality of perception takes precedence over the reality of life. The "coming of the white horse" in the dream contrasts desire and opportunity. An alternative image allows the poet to brighten the image. Indeed, "there is a proper understanding of the ingenuity of inspiration in the senses, the greatness of the art of speech, and those who can feel it are very subtle. I do not experience the whims of meaning and logic without a clear definition of purpose. It is impossible to achieve the right result without striving for pleasant eloquence and innovation" [5, 45]. The quote draws attention to several aspects: first, the creative potential of word art is reflected in the sense of perception, secondly, the poetic structure of the poem is determined by purposeful clarity, thirdly, the conflict of meaning and logic determines the philosophy of creation, fourth, the choice of aesthetic taste and the combination of methodological research is a key factor in ensuring the uniqueness of the narrative technique.

## CONCLUSIONS AND RECOMMENDATIONS

In AlisherNazar's poetry, the word art seeks to become a deep analysis of the human psyche and an examination of the mysteries. As the author paints a picture of the situation in emotional perception, he subtly connects subtle observation and vivid observation. The poet usually derives the logic of life from the expression of mood. While magical works of art born of a creative worldview sometimes feature creative independence of visual aids such as pitching, cutting, and satire, some literary interpretations tend to materialize emotion and depict the flow of emotion. "NasrullaErgah" - the poet's talent for analyzing the growth and transformation of spiritual landscapes is a testament to his talent. In it, research and experience complement each other, in which the lyrical subject and the object of the poetic image are combined. In the author's writings, which stabilize the burden of meaning on the poetic idea, the temperature of feeling, the power of content is reflected. The allegories used in the poet's poems are full of vividness, vivid

imagination, and a desire to deepen philosophical observation. The desire to expand the scope of the imagination, the meticulousness in the analysis and examination of the psyche, the desire to keep the scale of life's contradictions tense characterize the effectiveness of the poetic possibilities achieved by the creator. There is a tremendous potential in the creative nature that directs the capacity of words to the understanding of poetic meaning!

#### REFERENCES

1. Mirziyoyev Sh.M. Critical analysis, strict discipline and personal responsibility should be the daily rule of every leader. –Tashkent: Uzbekistan, 2017.
2. Alisher Nazar. Vola. - Tashkent: Akademnashr, 2014.
3. Kazakhboy Yuldosh. An open word. -Tashkent: Tafakkur, 2019.
4. Literature of the independence period. - Tashkent: Literature and Art, 2006.
5. Shermurodov T. Looking for an attractive expression. - Tashkent: National Library of Uzbekistan, 2009.
6. Umurov H. Rules of literature. -Tashkent: New Century Generation, 2006.
7. <http://www.ziyouz.com/>.

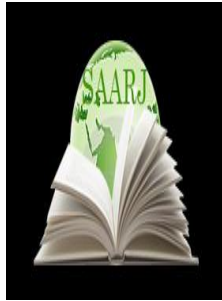

**ACADEMICIA**  
**An International  
 Multidisciplinary  
 Research Journal**  
 (Double Blind Refereed & Peer Reviewed Journal)

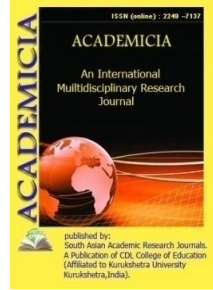

**DOI: 10.5958/2249-7137.2021.01022.3**

**INDIVIDUAL LEARNER DIFFERENCES: THE ROLE OF MOTIVATION  
 IN TEACHING FOREIGN LANGUAGE**

**Soibova Gulchiroy Bakhtiyorjonqizi\*;  
 Qurbonova Mushtariy Abdujabborqizi\*\*; Alimova Iroda Khayritdinovna\*\*\*;  
 Mengniyozova Zebo Ahmadovna\*\*\*\***

\*Teacher at the Foreign Philology faculty,  
 National University of Uzbekistan,  
 Named after Mirzo Ulugbek, UZBEKISTAN  
 Email id: gulisoibova@gmail.com

\*\*Teacher at the Foreign Philology faculty,  
 National University of Uzbekistan,  
 Named after Mirzo Ulugbek, UZBEKISTAN  
 Email id: charlotta0103@gmail.com

\*\*\*Teacher at the Foreign Philology faculty,  
 National University of Uzbekistan,  
 Named after Mirzo Ulugbek, UZBEKISTAN  
 Email id: alimova-iroda@inbox.ru

\*\*\*\*Teacher at the Foreign Philology faculty,  
 National University of Uzbekistan  
 Named after Mirzo Ulugbek, UZBEKISTAN  
 Email id: zmengniyozova@bk.ru

**ABSTRACT**

*The article examines role of motivation in teaching foreign language. Having effective methods are not enough to increase learners' acquisition. Different factors influenced by nature and formed by nurture. The following paper studies how motivation has impact on learners' foreign language acquisition, the relationship of motivation, cognition, and emotion, and analyzes the role of motivation in teaching foreign language.*

**KEYWORDS:** *Motivation, Integrative motivation, Instrumental motivation, Cognition.*



---

## INTRODUCTION

Teaching second language entails not only good methodological skills but also touches the factor individual differences of FL learners. Proficient teacher knows that FL learners vary regarding their learning styles. Some learners regardless of their age possess skills that help them acquire a language. For example, some learners are kinesthetic and show better results when they touch or see. Others are visual and remember a language when they see it. Nevertheless, the most important factor that pushes them to learn a language is Motivation.

Motivation in a second language acquisition is a tough object. Dornyei (1998) marked that there is a connection between motivation and success in second language learning. In fact, "... without sufficient motivation, even individuals with the most remarkable abilities cannot accomplish long-term goals, and neither are appropriate curricula and good teaching enough on their own to ensure student achievement" (Dornyei, 1998, p. 117).

What Is Motivation? Motivation Is Willingness Of Action Specifically In Behavior. These Days, The Word Motivation Is Widely Used Among Teachers And Learners. Foreign Language Teachers Struggle To Find Various Ways On How To Awake Or Increase Learners Motivation.

Gardner And Lambert (1972) Divided Motivation Into Two Types: Integrative And Instrumental.

Integrative Motivation Pushes Learners To Acquire Foreign Language In Order To Become A Part Of A Target Culture Or Community. In This Type Of Motivation, Learners Have Great Willingness To Behave And Resemble Like The Aimed Community.

In Case Of Instrumental Motivation, Individuals Find Incentive In Learning Foreign Language In Order To Get Benefits, Such As Working, Travelling, Or Studying Abroad. Not Regarding Its Type Both Can Lead To Success. However, The Domination Of One Of These Types Is Influenced By Social Factors. That Is, Individuals That Belong To Well-Off Society In Common Cases Have Integrative Motivation. Yet, Individuals That Belong To Subordinate Group Of Society Can Possess Instrumental Motivation.

Dornyei (1994) Noted That Instructors Should "Develop Learners' Instrumental Motivation By Discussing The Role L2 Plays In The World And Its Potential Both For Themselves And Their Community" (P.281).

The Complex Relationship Of Motivation, Cognition, And Emotion.

Cultivating Motivation Is Essential To A Language Learners And Their Success In Study. As It Was Mentioned Above, Motivation Is Something That Learners Form In Their Mind. Still, According To Dornyei (1998) There Is A Fundamental Issue With Conceptualizing Of Motivation As The Foundation Of Human Behavior. Motivation Is Abstract Term, It Is Untouchable, But Its Results Are Visible. Individuals Who Pushed By Integrative Motivation Commonly Feel Happiness And Emotionally Stable. They Have A Tendency Not To Give Up When Face With Problems. In Terms Of Teaching Integrative Motivated Learners, Teachers Do Not Have Difficulties And At The Same Time Feel Joy While Conducting The Lesson. Such Learners Do Not Hurry Language Acquisition Time, Instead They Fully Into Learning Society With Its Customs, Traditions, Culture, And So On. Individuals Who Pushed By Instrumental Motivation Are More Practical And Need Quick Results.

## Motivation And Teaching

Both For Teachers And Students Will Be Big Issues If The Last Have Neither Integrative Nor Instrumental Motivation. Such Cases Appear At Schools, When Children Do Have Any Idea Why They Are Learning Foreign Language. Usually, Elementary School Teachers Do Not Know How To Teach Demotivated Pupils And Become Strict If A Particular Pupil Is Not Ready To The Lesson Or Distract Others. Schoolchildren Are Not Interested In Target Language Community Or Culture; They Do Not Have Particular Contacts With Job Prospects, Neither With Educational Institutions. According To Noel's Theory On Adaptation Of Self-Determination Theory Of Language Learning Theory

For Elementary School Children The Great Motivation Is Their Marks. If They Get An Excellent Mark From Language Lesson, They Are Happy, If Not They Are Sad. It Is Too Simple. However, Apprising Only With Marks Are Not An Effective Teaching Method. The Possible Solution In Such Situation Is Well Picked Coursebook. The Course-Book Should Contain Authentic Dialogues By Using Language In Elementary Level. Situational Dialogues Induce Young Learners To Them In Their Daily Life And Become Interested In A Language. Syllabus Should Be Developed Accordingly. The Course-Book Published By Cook (1983) Living With People Described England, Specifically Oxford And Showed Real Supermarkets, Hospitals, Trade Centers, Cafes, And So On. For Children It Is Good Chance To Practice Their Language Not Only In The Classroom But Out Of It, As Well. The Feeling Of Motivation Appear In Middle School Or In Higher Classes, When Pupils Have Already Set Their Goal Or Trying To Find Their Place In Society.

Dornyei And Otto (1998) Suggested A Framework For Motivational Strategies, Which Is Presented In The Form Of Process (See Figure 1). The Key Points In This Process-Oriented Structure Consist Of The Following:

Creating The Basic Motivational Conditions, That Is Developing A Good Scenario For The Effective Utilization Of Motivational Strategies;

Generating Student Motivation, Developing Students' Goal-Orientedness; Preactional Phase

Maintaining And Protecting Motivation, Creating Motivational Atmosphere And Maintaining It; Actional Phase

Encouraging Positive Self-Evaluation, Providing Motivative-Cosntructive Feedback; Postactional Phase

Creating Basic Motivational Conditions Are Fundamentals Of Successful Lesson. In This Phase, It Is Crucial For Teachers To Behave Appropriately And Consider Learner's Individual Characters. Classroom Environment Should Be Supportive And Positive. This Is Very Important Level; The Result Of The Lesson Will Be Depend On This Condition.

Generating Student Motivation If The Above-Mentioned Condition Directly Influenced By External Features, The Following Is Closely Related To Lesson Process. In A Perfect World, Leaners Are Eager To Learner A Language And Are Always Hurry To The Lesson, Regardless Their Age And Incentive. In Reality, It Is Far From That. School Administration Pays More Attention On Students' Attendance And "Lesson Papers".

**In Conclusion,** To Promote Motivation In The Foreign Language Classroom, Teachers Should Face With Some Motivational Strategies. To Carry Out The Classroom Participation, The First Thing The Teacher Should Do Is To Take Into Account The Students Attitudes And Interests. Moreover, Teacher Should Have A Good Relationship With The Students. It Is Obvious That Having A Good Relationship With The Students Is Also Essential To Keep Them Motivated For That Reason During Teaching Period Having A Positive Attitude And Positive Relationship With The Students Not Only Academically But Also Personally Providing Students Useful And Real Materials Dynamic Tasks And Suitable Learning Atmosphere Are Aspects That Can Be Used To Maximize Students Motivation In The Classroom.

#### **LIST OF USED LITERATURE**

1. Deci, E. and Ryan, R. (1985) intrinsic motivation and self-determination in human behavior. New York: Plenum
2. Dornyei, z. (1998) motivation in second and foreign language learning: language teaching. Language teaching, vol. 31, no 03, pp. 117-135.
3. Gardner, r. (2004) Attitude-motivation test battery: International AMTB research project. The University of Western Ontario, Canada
4. Knowles, M. (1972) Innovation in teaching styles and approaches based upon adult learning. Journal of education for social work. Vol. 08, no. 02, pp32-39
5. Witkin, H. (1973). The role of cognitive style in academic performance and in teacher-student relations. Paper presented at a symposium on cognitive styles, creativity and higher education. Sponsored by the graduate record examination board, Montreal, Canada. Princeton, N.J.: Educational testing service, research bulletin. Vol. 73, no. 11

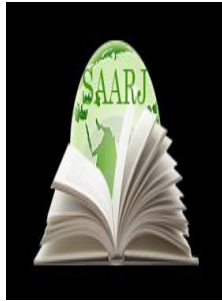

**ACADEMICIA**  
**An International  
 Multidisciplinary  
 Research Journal**  
 (Double Blind Refereed & Peer Reviewed Journal)



**DOI: 10.5958/2249-7137.2021.01023.5**

**THEORETICAL AND METHODOLOGICAL ASPECTS OF THE  
 DEVELOPMENT OF CHILDREN'S INTELLECTUAL AND CREATIVE  
 ABILITIES ON THE BASIS OF MEDIA EDUCATION TECHNOLOGIES**

**Shermanova Feruza Djumaboevna\***

\*2nd year Doctoral Student,  
 Qori Niyazi Research Institute,  
 UZBEKISTAN

Email id: feruza.shermanova@inbox.ru

**ABSTRACT**

*The article deals with the theoretical and methodological aspects of the development of intellectual and creative abilities of children based on media education technologies. The main approaches that have developed in the world of science to this issue are studied, and the differences between them are outlined. Media literacy is, in general, a set of skills and abilities that enable people to analyze, evaluate, and generate information in different forms, genres, and types of different media. It is based on a model that encourages a person to ask questions about what they see, read, and hear. Through media literacy, a person acquires the ability to analyze media texts and distinguish the true from the false, the important from the insignificant, the narrow approach from the broad approach*

**KEYWORDS:** *Media, media education, media literacy, media laws.*

**INTRODUCTION**

The concept of media and its impact on society has been of interest to researchers since the 1950s and 1960s. Issues related to the impact of the media on the individual and society, the role of the individual in communication processes G.Lassuel, U.Shramm, G.Gerbner, G. Innis was widely covered in the works of Anglo-Saxon scholars such as M. McLuhan. It was in the Anglo-Saxon school that extensive, comprehensive research on the phenomenon of "media" was conducted. In the 60s of the twentieth century, a new scientific direction was opened on the basis of the University of Toronto, which was devoted to the impact of new technologies on human consciousness and activity. The first group, led by Professor G. Innis, studied communication technologies, while Professor M. McLuhan studied the phenomena of mass communication,

media education. This field of study was later renamed the Toronto School of Communication Theory.

Professor M. McLuhan is the scientist who introduced the concept of "media" to the world of science. Originally in Latin, the word "media", which is a plural form of the word "medium", meaning "in the middle", was accepted in scientific consumption as a means of communication, a method of receiving information.

In his monograph "Media Laws", McLuhan outlined four basic principles of media activity: [1]

1. Any technology enhances the capabilities of a particular organ or user's specific abilities.
2. As one area of sensation intensifies or intensifies, the other weakens or becomes under pressure.
3. Any being brought to the limit of its possibilities changes its properties.
4. Under any new media lies the old.

As a result of his research, M. McLuhan developed the thesis "Medium is the Message". According to him, the media has a huge impact on both its content and its perception. Therefore, the transmission of the same information through different communication channels (e.g. radio and television) leads to an absolutely different solution. Based on this view, the Canadian scientist concludes that the means of transmitting information is more important than the information itself. Based on this, the researcher develops a "Marshall Plan" to introduce students to the world of media. The plan is as follows:

*"Not analyzing. Do not explain. The classroom should be filled with movies, TV, plates, flashing lights, and the student should be able to move. "* [2]

*Continuing the scientific legacy of M. McLuhan, H. Pros and H. Bonfadelli analyzed the content and typology of the concept of "media" in their works. The impact of the media on the individual has also been reflected in the work of scholars such as D. Baake, D. Winter, M. Castels, V. Kolomiets, L. Mikos, U. Sander, R. Hoffman, R. Folbrecht.*

Since the 1960s, the United Nations Educational, Scientific and Cultural Organization (UNESCO) has supported and promoted the concept of "media education" around the world. In the modern world, media education is defined as the development of a person in the materials of the media and with their help, the purpose of which is to form a culture of communication with the media, critical thinking, creative, communicative skills, full acceptance, interpretation and analysis of media texts. is the introduction of various forms of revelation through. [3] The end result of this process is media literacy, which allows a person to actively and fully use the opportunities of the information space - television, radio, cinema, the press, the Internet.

In 1978, under the auspices of UNESCO, the General Curricular Model for Mass Media Education was developed. To date, UNESCO has hosted major international conferences in Grunwald (1982), Toulouse (1990), Paris (1997), Vienna (1999), Seville (2002) and other cities. In particular, the final document of the international conference held in Vienna in 1999 states that "Media education is inextricably linked with the types of media (print, graphics, audio, screen, etc.) and various technologies.

It allows people to understand how mass communication is used in societies and to learn to use the media. Through media education, a person acquires the following knowledge:

- Analyze, critically understand and create [their own media texts];
- Identify the sources of media texts, their political, social, commercial and / or cultural interests and content;
- Interpretation of media texts and values disseminated by the media;
- To create and distribute their own media texts, to select the appropriate media in order to find an audience interested in them
- Access to and production of media through free access. [4]

The term "media literacy" also has a strong place in the international scientific community. Scholars such as Walter Benjamin, Lorentz Engel (Germany), Nicholas Negroponte, Noam Chomsky (USA), Alexander Fedorov (Russia), Stuart Hall (UK) have reflected on this concept in their works.

Media literacy is, in general, a set of skills and abilities that enable people to analyze, evaluate, and generate information in different forms, genres, and types of different media. It is based on a model that encourages a person to ask questions about what they see, read, and hear. Through media literacy, a person acquires the ability to analyze media texts and distinguish the true from the false, the important from the insignificant, the narrow approach from the broad approach. The main mission of media literacy is to transform media consumption into an active and critical process.

By the end of the twentieth century, the concept of "media competence" entered Western pedagogy. In this regard, German scientists in particular have made great strides. In particular, D.Bake, S.Blumek, I.Pottinger widely used the concept of "media competence" in German in their works. [5] G. Tulojeski suggested that "media competence" means "the ability to act competently, independently, creatively and socially responsibly in relation to the media." [6] For his part, Rutgers University Professor R. Cuby (USA) summarized the concepts of media competence and media literacy, describing it as "the ability to use, analyze, evaluate, and convey information in various forms." gave. [7]

The concept of "media educated" is also common in a number of scientific works. The Russian scientist N. Zmanovskaya defines this term as "a systematized media knowledge, a set of skills, a valuable approach to media education, the degree of implementation of media education in practice in the pedagogical process." [8]

According to American scientist J. Potter, media education based on three components:

- Experience - The greater a person's experience in communicating with the media and the real world, the higher their media competence.
- Ability to apply knowledge in the field of media in practice.
- Readiness for independent study. [9]

In turn, media educator S.Beeren highlights the following important skills in improving a person's knowledge and skills through the media:

- Willingness and ability to understand the content of the media without being distracted by excessive "noise".
- Understand and respect the impact of the power of media texts.
- To be able to distinguish between emotional and reasoned reaction in the reception of the delivered information by the audience and to act accordingly.
- Development of competent assumptions about the content of media texts.
- Understand the diversity of genres, go to their differences.
- Critical thinking about media texts, regardless of their source.
- To understand the "language" of different media, to study their influence. [10]

The German educator W. Weber developed a structure of knowledge in the field of media consisting of five main skills:

In terms of form:

- Selection and use of opportunities that the media can provide.
- Create your own media product.
- Knowledge and analytical skills required in terms of content:
- Use a variety of media-based creative opportunities.
- Creating conditions for effective use of the media.
- Economic, social, technical, political conditions related to the production and distribution of media products. [11]

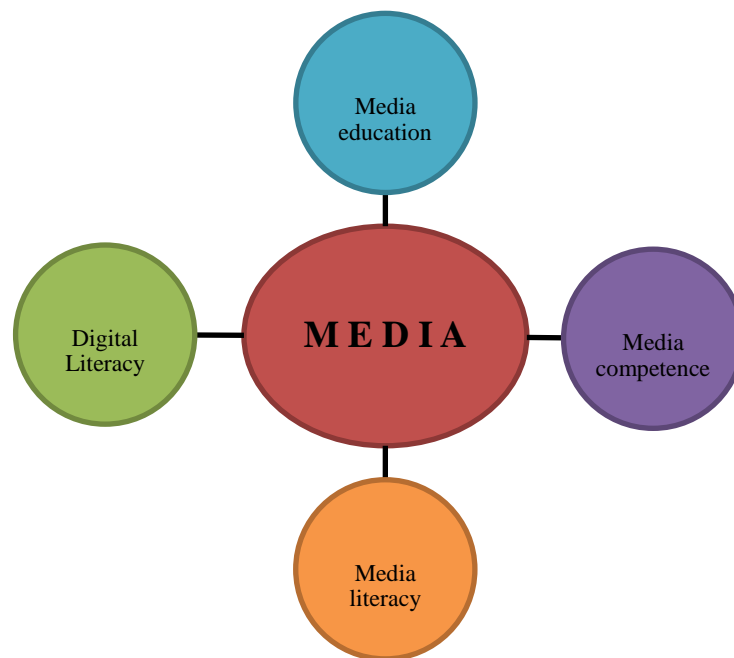

**PICTURE 1. The structure of the media in modern practice.**

According to Russian scientists O.Davidova [12], L.Ivanova [13], V.Protopopova [14], O.Surova [15], E.Ushakova [16], the following knowledge for modern pedagogical students (children) and must have the skills:

- use of information and communication technologies directly related to their specialization in their professional activities;
- to have an idea about educational resources in the media and the Internet, to know how to use them;
- be able to assess the pedagogical aspects of e-learning resources;
- access to telecommunications;
- Ability to work in the form of forums, conferences, video conferencing;
- use of ready-made multimedia objects, development of such objects;
- Knowledge of the basic means of information protection.

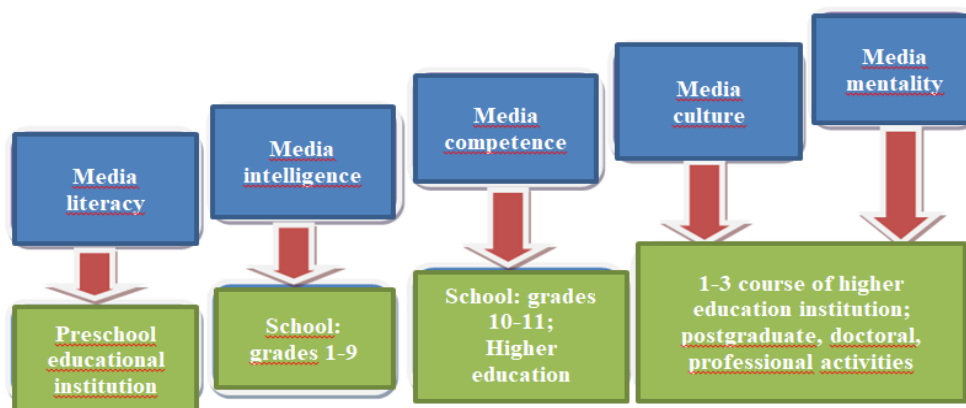

**PICTURE 2. The generally accepted step-by-step scheme of media education.**

According to I. Donina and A. Gopkina, in order to educate and bring up older children through the media, comprehensive preparation is required, and this process consists of three stages [17]:

**Technical stage** - the formation of basic computer skills;

**Methodical stage** - the study of the didactic features of e-learning resources, training teachers to use new technologies in the learning process;

**The philosophical-worldview stage** is a change in the educator's attitude towards media information technology, overcoming existing fears and feelings of rejection of news.

In general, in order to teach students or pupils using modern media, teachers and educators need to formulate the following factors:

№	Indicator	Basic criteria
1.	Motivation	Striving to improve their knowledge and skills in the field of media education



2.	Information	The level of information that the educator has about media education and media
3.	Methodology	Methodical ability of the teacher, pedagogical skills
4.	Practice	Quality of education in different forms of learning processes
5.	Creativity	The educator's creative approach to his work and the learning process

Thus, the analysis shows that the current work on the theoretical research on the development of children's intellectual and creative abilities on the basis of media education technologies is scarce and unsystematic, and at the same time relevant.

Research of theoretical and scientific sources aimed at studying the development of intellectual and creative abilities of preschool children on the basis of media education technologies as a pedagogical problem. allows for more detailed observations on the development of creative, creative abilities. This opportunity contributes to the revitalization of the work of purposeful formation of creative resources and potentials in children.

Foreign research has scientifically substantiated the possibility of developing creative skills such as creativity, critical thinking, interpretation and analysis, evaluation, inference, decision making, judgment in preschool older children on the basis of media education. Media education allows children to analyze, evaluate and create such information on the basis of different forms and genres. In doing so, the child acquires the ability to analyze the media texts and distinguish the true from the false, the important from the insignificant, the narrow approach from the broad approach.

## REFERENCES

1. McLuhan, M. (1988). *Laws of Media: The New Science with Eric McLuhan* / University of Toronto Press, 268 p.
2. McLuhan M. (2001). *War and peace in global village*. Gingko Press: New Ed edition, 192 p.
3. [3. Media/Education//http://portal.unesco.org/ci/en/ev.phpURL\\_ID=1653&URL\\_DO=DO\\_TO PIC&URL\\_SECTION=201.htm](http://portal.unesco.org/ci/en/ev.phpURL_ID=1653&URL_DO=DO_TO PIC&URL_SECTION=201.htm)
4. *Educating for the Media and the Digital Age: International Conference, Vienna, 18-20 April, 1999*, p.428
5. Pottinger, I. (1997). *LernzielMediaenkompetenz*. Munchen: KoPad-Verlag, 272 p., Baake, D. and all (Eds.) (1999). *Hanbuch Mediaen: Medienkompetenz. Modelle und Projecte*. Bonn: Budeszentrale fur Politische Bildung, 308 p., Blumeke, S. (2000). *Mediaenpadagogische Kompetenz*. Munchen: KoPad-Verlag, 400 p.
6. Tulodziecki, G. (1997): *Medien in Erziehung und Bildung. Grundlagen und Beispiele einer handlungs und entwicklungsorientierten Medienpädagogik*. Bad Heilbrunn, p.120.
7. Buckingham D., Sefton-Green, J. (1997). *Multimedia Education: Media Literacy in the Age of Digital Culture*. In: Kubey, R. (Ed.). *Media Literacy in the Information Age*. New Brunswick and London: Transaction Publishers, p.290.

8. Zmanovskaya N.V. Formation of media-communicative education of future teachers. Autoref. dis. on step. kand. ped. science. Krasnoyarsk, 2004. 24 p.
9. Potter, W.J. (2001). Media Literacy. Thousand Oaks — London: Sage Publication, 423 p.
10. Baran, J (2014). Introduction to Mass Communication: Media Literacy and Culture Updated Edition. McGraw-Hill Education, pp. 57-58
11. Weber V. Media portfolio portfolio // Informatics and education. 2002. № 1
12. Davidova, O.I. Mediakompetentnostvospitatelya DOU prisozdaniielektronnyxprezentatsiy / O.I. Davydova, L.G. Bogoslavets // Upravlenie DOU –№ 1. - 2012. - C.99-104
13. Ivanova, L.A. Mediakompetentnostpedagogadoshkolnogoobrazovatelnogouchrejdeniya: voprosyteorii / L.A. Ivanova // Detskiy sad ot A do Ya. - № 6. — 2009. - S. 35-43.
14. Protopopova, V.V. Mediakompetentnostsovremennogopedagoga / V.V. Protopopova // Vissheegumanitarnoeobrazovanie XXI veka: problemyiperspektivi: V 2-x t. T. 1. Pedagogy. Psychology. - Samara: PGSGA, 2009. - C.285–288.
15. Surova, O.A. Upravleniedoshkolnimobrazovaniem s ispolzovaniemprogrammnixproduktovspetsialnogonaznacheniya / O.A. Surova // DOU management. - № 9. - 2011. - p. 54- 57.
16. Ushakova, E.V. Organization of edinogoinformatsionno-obrazovatelnogoprostranstva / E.V.Ushakova, N.V. Gagarina, S.E. Paxomova // Management of DOU. - № 9. - 2011. - p. 10-24.
17. Donina I.A., Gopkina A.N. Model formirovaniyagotovnostipedagogvdoshkolnoyobrazovatelnoyorganizatsii k prodvijeniyuobrazovatelnixuslug // Sankt-Peterburgskiyobrazovatelniyvestnik. 2018. №4-5 (20-21)

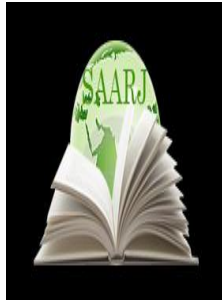

**ACADEMICIA**  
**An International**  
**Multidisciplinary**  
**Research Journal**  
 (Double Blind Refereed & Peer Reviewed Journal)



**DOI: 10.5958/2249-7137.2021.01024.7**

## LOCAL PHYTOTHERAPY OF CHRONIC GENERALIZED PERIODONTITIS (REVIEW)

**Shukurova U.A\*; Azizova Sh. Sh\*\*; Yakhoyeva M\*\*\*; Musashaikhova Sh.K\*\*\*\***

<sup>1,4</sup>Tashkent State Dental Institute  
 Tashkent, Republic of UZBEKISTAN  
 Email id: Shukurova U.A.,shua1981@mail.ru

### ABSTRACT

*Chronic generalized periodontitis is a serious medical, social and economic problem, and its complex therapy should affect all pathogenetic mechanisms of the development of this disease. In this regard, the local use of the therapeutic properties of the active components of herbal preparations as an alternative is relevant and affordable from an economic point of view.*

**KEYWORDS:** *Periodontal diseases, Phytopreparations, chronic generalized periodontitis, Chlorhexidine, Metronidazole, Aloe vera, Gum inflammation.*

### INTRODUCTION

Today in the structure of dental diseases one of the leading places is occupied by inflammatory periodontal diseases. This is due to their high prevalence among the population, an increase in the severity and intensity of the process, the formation of a chronic odontogenic focus of infection, and its adverse effect on the body [4, 12, 22]. According to the WHO, more than 95% of the population over 45 years old suffers from inflammatory periodontal tissue diseases.

Research conducted by Y. G. Tarasova et al. (2010) in the epidemiological study has shown that the prevalence of symptoms of periodontal tissue lesions CPITN index is high and ranges on average from 54.04% to 99.33%. With increasing age of those surveyed regularly increases the percentage of patients with inflammatory periodontal diseases. At a young age (15-34 years) is mainly dominated by the initial signs of periodontal tissue inflammation in the form of bleeding gums (32.06%) and tartar (21.15%). A periodontal pocket is detected in 5.58% of cases. With age, the number of persons with identified periodontal pockets increases: at 35-44 years - up to 28.37%; at 45-64 years old - up to 44.28%; at 65-74 years - up to 73.68%. The percentage of people in need of periodontal care, according to the CPITN index, averages 69.43%.

Among the inflammatory periodontal disease is given a special place of chronic generalized periodontitis (CGP), which is a serious medical, social, and economic problem and its complex therapy should affect all the pathogenetic mechanisms of the disease. Complex therapy of CGP should contribute to the elimination of clinical manifestations, which implies, among other things, the use of various medications and their combinations to achieve a positive result and increase the duration of remission [1, 14, and 25].

It is well known that the most effective methods of preventing periodontal disease are individual. The most effective program is to conduct professional oral hygiene, including the removal of dental plaque, if necessary, the use of local therapeutic agents, training in individual oral hygiene, and monitoring the quality of its implementation [1, 8, and 19]. In addition to this, local and systemic medications are also used in treatment: antiseptic drugs, antibiotics [12], non-steroidal and antimicrobial drugs, and others [5, 9].

Orthopedic and surgical interventions are performed after the removal of acute inflammation. Speaking about the complexity of the treatment of the disease, we also mean a multidisciplinary approach with the inclusion in the treatment plan of therapeutic, orthodontic, surgical, orthopedic interventions, if necessary, treatment of patients by specialists of related specialties.

The main and most numerous group of topical agents is the group of antiseptics. The number of representatives is quite large, however, the most often noted use of representatives of the groups of cationic detergents, halogens, phenols, herbal preparations [6, 16].

One of them is Chlorhexidine, the so-called "gold standard" among other medications used to eradicate periodontal infection. Chlorhexidine has a broad spectrum of action against gram-positive and gram-negative bacteria, yeast, dermatophytes, and lipophilic viruses, and is considered a stable and effective agent for reducing plaque and inflammation. [2, 6, 7, 24].

Some antibacterial agents such as triclosan, essential oils are used in commercial products for oral care to control plaque formation and halitosis [3, 6, and 18].

Today, all the more common methods antimicrobial effects that can reduce the side effects of the drug on the body, minimize the occurrence of side effects from the organs and systems can create and maintain the desired local concentration without increasing the content of pharmacological agents to the general circulation. One of these methods is the use of a method of local delivery of the drug with prolonged release, which will allow maintaining higher concentrations of the active substance at the injection site. [13, 23].

However, some inherent parodontopatogeny with high virulence and the ability to form biofilm is capable of exhibiting drug resistance to chemotherapeutic agents used in their uncontrolled and prolonged use. The development of drug resistance in periodontopathogens creates additional difficulties in the implementation of a full complex therapy CGP, reducing the effectiveness of both local and general therapeutic measures.

Due to the fact that antimicrobial therapy using drugs of synthetic origin can lead to a number of such adverse consequences as: disruption of the normal symbiosis of microorganisms, an increase in the development of allergic reactions, the ability to have hepatotoxic and immunosuppressive effects, suppression of the immunobiological resistance of the body, a possible inhibitory effect on tissues periodontal disease and defense mechanisms, the risk of developing oral dysbiosis, impaired taste sensitivity [1,10,15,23].

Based on the foregoing, today widely used phytopreparation have a great demand at the local and general treatment of CGP. When creating an effective herbal remedy, it is necessary to take into account the experience of using medicinal plants in dentistry; analysis of the structure and structure of medicinal plants; chemical, physical properties, and biological effects of natural healing substances; knowledge and use of the latest methods and technologies of extraction, allowing to isolate biologically active substances from plants while maintaining their high natural activity in small doses.

The concept of "phytopreparations" has long been somewhat arbitrary, since plants were the main, if not the only, remedy. Since the 19th century, phytopreparations based on the analysis of the chemical composition of plants have been used in dental practice. This took into account not only the qualitative (vitamins, flavonoids, alkaloids, glycosides, etc.) but also the quantitative composition [15, 17, 20].

In the 20th century, an integrated approach to the study of medicinal plants began to be used, taking into account not only the content of biologically active substances in them but also the optimal methods for their extraction.

The literature has accumulated extensive material on the effects of plants and their preparations on the clinical course, local and general immunity, microflora, metabolism, and function of periodontal tissues.

At this time, herbal medicine is widely used in dentistry, both in our country and abroad in connection with the identification of its positive properties. Namely: the presence of a whole set of therapeutic properties, minimally toxic and side effects, no restrictions on the intake of other medications, the minimum likelihood of developing resistant strains, the availability, and ease of use of drugs [2,19,21].

Herbal preparations are characterized by complex chemical composition and, accordingly, the spectrum of biological action will be quite wide [5, 11, 17]. No wonder the same plant-based remedy can have a pathogenetic, immunomodulatory effect, and phytotherapy can also be considered as an adaptive therapy [4, 17, and 20].

Especially worth mentioning is phytopreparations property as recovery and normalization of tissue metabolism along with increased efficiency of treatment of underlying disease, which is particularly valuable in the treatment of pathologies periodontal tissues [4,16].

The homeopathic method is recognized as one of the areas of herbal medicine. The drugs of this group do not serve to destroy microorganisms, are not used for substitution therapy or to stop a certain pathological process, they help to restore the body's self-regulation. The homeopathic preparation consists of dozens of components of plant and mineral origin is widely used in the treatment of inflammatory phenomena in periodontal tissues in the form of ointments, tablets, or injections. It is noted that it has an analgesic, anti-inflammatory effect with the ability to improve microcirculation in the focus of irritation and stimulate healing processes [8, 14, 20, and 22].

The results of domestic and foreign scientific works prove the advisability of using herbal antioxidant drugs in the complex therapy of dental diseases. The range of complex preparations from medicinal herbal raw materials, which is used in the treatment of diseases of the oral cavity, is small, therefore, the expansion of the arsenal of medicinal preparations based on herbal raw materials and their standardization is an urgent task. As the object of study to use ready raw

aerial parts of the four species of medicinal plants: rough hypericum, chamomile flowers, leaves, sage, and calendula flowers drug. To investigate the antioxidant activity (AOA) of water-soluble substances prepared aqueous plant extracts of plants. 1 g of milled plant raw material was placed into a flask filled with 100 ml of distilled water at room temperature and a boiling water bath with occasional stirring for 15 min [3, 14, and 23].

AOA preparation "Parodontfit", which is a liquid extract of medicinal plants: rough hypericum, chamomile flowers, leaves, and flowers of *Salvia officinalis* calendula dosage in a ratio of 1: 1: 1: 1 and the ethanol to 60.0% (obtained by extraction and percolation 70.0% ethyl alcohol) was studied in dilutions of 1:10; 1:20 and 1:40 [3,19,21].

Green tea is a popular nutraceutical and has strong antioxidant properties. It contains polyphenols, which include flavonols, flavonoids, and phenolic acids. Antioxidants protect body cells from the destructive effects of reactive oxygen species such as singlet oxygen, superoxide, and peroxy radicals. An imbalance between antioxidants and reactive oxygen species leads to oxidative stress, which ultimately leads to cell damage [5, 22].

Several studies have proven the efficacy of turmeric extract as a gel and as part of a periodontal chip for application to periodontal pockets.

A study conducted by foreign authors included a comparative clinical and microbiological assessment of the effectiveness of using the Neem chip in conjunction with basic conservative therapy in comparison with conservative therapy without the use of any additional drugs in the treatment of periodontitis and found that long-term drug release systems prevent recolonization pathogens over a long period; determined a significant improvement in all clinical parameters in the study group compared with the control group, the quantitative presence of *P. gingivalis* significantly decreased in response to local drug delivery. It was revealed that Neem extract has a powerful immunostimulating activity, as evidenced by the state of both humoral and cellular immunity [10, 22].

Proven effectiveness in the prevention and treatment of inflammatory processes in the periodontium - dental adhesive based horsetail(*equisetum*), which has drainage properties and pronounced antimicrobial activity against strains of the four test cultures staphylococci [12,23].

To reduce the degree of inflammation of the periodontal tissues, oils of rosemary, eucalyptus, clove, mint have proven themselves well, used both in isolation and included in the composition of various combined drugs [2, 17].

The researchers found that the alkaloids present in barberry were more effective against bacteria such as *A. Actinomycetemcomitans* and *P. gingivalis* than against lactobacilli and streptococci. Berberine has also been shown to inhibit collagenase of these two species [3, 9, and 19].

Ahuja S. et al. (2011) used chamomile and pomegranate extracts in mouthwash in patients with periodontal tissue inflammation. It has been proven that this medicine has a pronounced anti-inflammatory and antimicrobial effect, and can be used as an additional therapeutic agent for the restoration and maintenance of periodontal health.

An experimental study using the method of automatic cultivation made it possible to reveal that phytopreparations "Tonsinal" and modified plate "CM-1" characterized sided impact on the key stages in the development of bacterial populations. The average optical density of samples with

the addition of phytopreparations of various concentrations is lower than in control samples - during the cultivation of *A.actinomycetemcomitans* and *P.intermedia* by 83% and 60%, respectively, during the cultivation of *F.nucleatum* - by 35%, *S. constellatus* - by 23%, *C. Albicans* - by 22%. The optimal concentration of active substances of phytopreparations for providing antimicrobial action on *A. actinomycetemcomitans*, *P. gingivalis*, *P. intermedia*, *F. nucleatum*, *S. constellatus*, *C. Albicans* is: for Phytopreparation "Tonsinal" - 0, 125 mg/ml, for plates "CM-1" - 5 times higher than the concentration in the original sample. Clinical evaluation of the effectiveness of the treatment in the comparison groups revealed a significant improvement in the state of periodontal tissues based on the values of hygienic and periodontal indexes. Evaluating the level of hygiene of patients, the degree of bleeding of the gingival sulcus, significantly lower values were obtained in patients of the group for whom phytopreparations "Tonsinal" [9, 18, 20].

In the last 10 years, scientific research in periodontology has revealed the positive properties of Aloe vera, which have a direct effect on the links in the pathogenesis of inflammatory phenomena in the periodontium. This is the ability to provide anti-inflammatory, analgesic, antibacterial action when included in the composition of kinds of toothpaste, elixirs for rinsing in the complex treatment of CGP. As a local delivery system, Aloe vera gel was used in combination with SRP (scaling and root planning), which ultimately led to a decrease in clinical parameters such as plaque index, probing depth, and an increase in the level of clinical attachment. The anti-inflammatory effect of Aloe vera is associated with inhibition of cyclooxygenase and a decrease in the production of prostaglandin E2 [5, 15, and 24].

Based on all the above can be argued that the main etiological factor in the onset and development of periodontal diseases is subgingival microbial biofilm. The widespread prevalence of this pathology, its rejuvenation in recent years, the insufficient effectiveness of the preventive measures carried out justify the need to study the etiopathogenesis of this pathology and the search for new effective means and their combinations to achieve a positive therapeutic result. Despite the desire for comparison of means and methods to the established conventional standards and creating new combined means which have in their composition, as a plant component and a chemical antimicrobial agent of antiseptics groups and other pharmacological groups.

The search for alternative means to increase the effectiveness of treatment of periodontal diseases of inflammatory genesis is still an urgent task. In this regard, the local use of the therapeutic properties of the active components of herbal preparations as an alternative is relevant and affordable from an economic point of view.

#### LIST OF REFERENCES

1. Abdurakhmanova S.A., Runova G.S., Podporin M.S., Tsareva E.V., Ippolitov E.V., Tsarev V.N. Microbiological substantiation of the use of phytopreparations for the treatment of inflammatory periodontal diseases. *Periodontics*. 2019; 24 (3): 196-202.
2. Averyanov S.V. Modern aspects of therapeutic and prophylactic therapy of inflammatory periodontal disease / S. V. Averyanov, E. F. Galiullina, D. F. Shakirov // *Successes of modern science and education*. -2017. - T. 4, №. 3. - P. 71-76.

3. Amkhadova MA The effectiveness of the use of photodynamic therapy in the complex treatment of patients with chronic generalized periodontitis. Amkhadova, I.S. Kopecky, V.V. Prokoviev // Russian Dental Journal. - 2016. - T. 20, №1. - P. 12-15.
4. Berezina, N.V. The use of modern means in the treatment of inflammatory periodontal disease / NV Berezina, E.N. Silantyeva, S.M. Krivonos. // Dentistry for everyone. - 2017. - № 2 (79). - P. 26-30.
5. Vasilevskaya E.M., Blashkova S.L. Pathogenetic aspects of the formation of periodontal diseases in patients with coronary heart disease // Practical Medicine. - 2013.7 (76). P. 154-156.
6. Galizina O.A., Morozova S.I., Ryazanova E.A. Changes in the mineral composition of the oral fluid after the use of a phytopreparation // Institute of Dentistry. - 2013. - № 3.- P.68-69
7. Galiullina, E.F. New approaches to the etiology of periodontal diseases in the light of the modern concept of their pathogenesis. / E.F. Galiullina. // Periodontology. - 2017. - № 2 (83). - P. 21-24.
8. Zelenova A.V. Microcirculation in patients with rapidly progressive periodontitis before and after treatment / AV Zelenova, N.Bulkina, VF Kirichuk [et al.] // Modern problems of science and education. - 2015. - № 5. - P. 68.
9. KamilovKh.P., Takhirova K.A. Modern approach to the diagnosis of periodontitis: polymerization chain reaction in real- time // Stomatologiya. S. -2017. -№3. P. 80-81.
10. Kardanova L.V. Modern approaches in the conservative treatment of chronic generalized periodontitis / L. V. Kardanova, A. O. Balkarov, K. A. Shkhagapsoeva, S. M. Barazbieva // Successes of modern science. - 2017. - № 11. - P. 147-154.
11. Oleinik O.I. Modern approaches to conservative treatment of periodontal diseases (review) / O.I. Oleinik, O.P. Krasnikova, E.A. Alferova [and others] // New tasks of modern medicine: materials of the IV International scientific conference. (St. Petersburg, December 2016) - St. Petersburg: Own publishing house. - 2016. -- P. 47-51.
12. Rizaev E.A., Bekjanova O.E. Modern approaches to the organization of treatment of periodontal diseases // Stomatologiya. -2019. - № 3 (76). - P. 70-76.
13. Rumanova A.I. Microbiological evaluation of the effectiveness of treatment of chronic generalized periodontitis using a new pharmacological composition / A.I. Rumanova, T. Kh. Timokhina, Ya. I. Paromova [et al.] // Medical science and education of the Urals. - 2017. - № 4 (92). - P. 69-72.
14. Khaibullina R.R. Hemodynamic parameters of periodontal vessels in patients with chronic generalized periodontitis. Khaibullina, L. P. Gerasimova, A. R. Khaibullina // Journal of scientific articles "Health and education in the XXI century". - 2017. - T. 19, № 9. - P. 62-64.
15. Yanushevich O.O. Periodontal disease / O.O. Yanushevich, I.N. Kuzmina // Russian dental journal. - 2009. - № 1. - P. 43-45.
16. Aspalli, S. Evaluation of antiplaque and antigingivitis effect of herbal mouthwash in treatment of plaque induced gingivitis: A randomized, clinical trial. / S. Aspalli, V.S. Shetty,



- M.V. Devarathnamma, G. Nagappa, D. Archana, P. Parab. // J Indian SocPeriodontol. – 2014. – №18 (1). – P. 48-52.
17. Bartold, P.M. An appraisal of the role of specific bacteria in the initial pathogenesis of periodontitis. / P.M. Bartold, T.E. Van Dyke. // J ClinPeriodontol. – 2019. – №46. – P. 6-11.
  18. Bunes, D.F. The effect of smoking on inflammatory and bone remodeling markers in gingival crevicular fluid and subgingival microbiota following periodontal therapy. / D.F. Bunes, M. Mustafa, H.G. Mohamed, S.A. Lie, K.N. Leknes. // J Periodont Res. – 2017. – №52. – P. 713-724.
  19. Iqbal P.S. Assessment of systemic inflammatory markers in patients with aggressive periodontitis / P. S. Iqbal, S. N. Khan, M. Haris [et al.] // J Oral Health. - 2015. - № 7. - P. 48-51.
  20. Kirst, M.E. Dysbiosis and alterations in predicted functions of the subgingival microbiome in chronic periodontitis. / M.E. Kirst, E.C. Li, B. Alfant, Y.Y. Chi, C. Walker, I. Magnusson et al. // Appl Environ Microbiol. – 2015. – №81. – P. 783-793.
  21. Lee, J., Nho, Y.H., Yun, S.K. et al. Use of ethanol extracts of Terminalia chebula to prevent periodontal disease induced by dental plaque bacteria. / J. Lee, Y.H. Nho, S.K. Yun, et al. // BMC Complement Altern Med. – 2017. – №113. – P. 1-10.
  22. Luke R. Estimation of specific salivary enzymatic biomarkers in individuals with gingivitis and chronic periodontitis: a clinical and biochemical study / R. Luke [et al.] // J Int Oral Health. - 2015. - № 7 (9). - P.54-57.
  23. Monteiro Mde F. Periodontal clinical and microbiological characteristics in healthy versus generalized aggressive periodontitis families / F. Mde Monteiro, M. Z. Casati, T. Taiete [et al.] // J ClinPeriodontol. - 2015. - №42 (10). - P. 914-921.
  24. Pradeep, A.R. Adjunctive local delivery of aloe vera gel in patients with type 2 diabetes and chronic periodontitis: a randomized, controlled clinical trial. / A.R. Pradeep, V. Garg, A. Raju, P. Singh. // J Periodontol. – 2016. – №87 (3). – P. 268-274.
  25. Singh, A. Evaluation of turmeric chip compared with chlorhexidine chip as a local drug delivery agent in the treatment of chronic periodontitis: a split mouth randomized controlled clinical trial. / A. Singh, R. Sridhar, R. Shrihatti, A. Mandloy. // J Altern Complement Med. – 2018. – №24 (1). – P. 76-84.

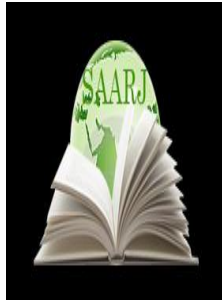

**ACADEMICIA**  
**An International  
 Multidisciplinary  
 Research Journal**  
 (Double Blind Refereed & Peer Reviewed Journal)



**DOI: 10.5958/2249-7137.2021.01025.9**

**PRIVILEGES AND PREFERENCES GIVEN TO ENTREPRENEURS  
 ENGAGED IN EXPORT ACTIVITIES AND FURTHER DEVELOPMENT  
 OF THE ELECTRICAL INDUSTRY**

**U.X.Normurzaev\***

\*Doctor of Philosophy (PhD),  
 Interregional State Tax Inspection for Large taxpayers,  
 UZBEKISTAN

**ABSTRACT**

*The article is designed to create favorable conditions and opportunities for businesses by improving tax administration without taking measures to mitigate the negative impact on the economy of Uzbekistan and the implementation of fiscal policy to support taxpayers. Improving the tax administration of the country is mainly aimed at improving the efficiency and quality of tax relations between taxpayers and the state, which is one of the main directions of our tax policy.*

**KEYWORDS:** *Budget policy, Crisis, budget, Tax benefits, Tax administration, Business entities, Tax reporting, Tax revenues, Tax benefits, Taxes, Tax rates, Taxes.*

**INTRODUCTION**

Today, a number of laws at the government level are being adopted to support business entities. At the same time, the tax authorities are working to ensure the implementation of these laws and provide tax legislation and business entities with practical assistance in the export of manufactured goods and the further development of the electrical industry.

Improving the tax administration of the country is mainly aimed at improving the efficiency and quality of tax relations between taxpayers and the state, which is one of the main directions of our tax policy.

For this reason, the President considers the increase in the level of tax administration as an important direction of tax policy by reducing the tax burden, ensuring equal competition between honest taxpayers and reducing the costs associated with the operation of the tax system.

The Tax Code of the Republic of Uzbekistan provides benefits to exporting businesses:

- 1) in Article 284, the sale of excisable goods for export (under customs procedures for export) is not subject to taxation;
- 2) in Article 260, the value-added tax with a zero rate shall be applied to the sale of goods exported from the territory of the Republic of Uzbekistan under the export customs procedure;
- 3) in Article 337, the income tax from the sale of goods (works) for export is applied at "0" percent;
- 4) In Article 464, income from the export of goods (services) is not included in the tax base for turnover tax.

First, from 2020, not only exporting enterprises but also all business entities that have a negative difference in the calculation of the amount of VAT will have the right to a refund (refund) of value added tax. This exemption was established by the new Tax Code and came into force on July 1 this year.

In particular, 9,014.6 billion soums of taxes were returned in 5,847 cases this year, which is 5 times more than in 2019 (1,697.7 billion soums were returned to exporters in 739 cases).

Due to these funds, opportunities have been created for the development of entrepreneurial activity and expansion of the production base.

Second, in order to improve the system of taxpayer services, the task of VAT reimbursement was transferred to each regional state tax administration, and VAT administration departments were established in the tax system.

Third, an accelerated procedure for VAT reimbursement (7 days) was introduced, and in August-December this year, a total of 2,788.0 billion soums were reimbursed in 1,168 cases.

Also, by the Resolution of the President of the Republic of Uzbekistan dated March 2, 2021 "On additional measures to further develop the electrical industry and increase the competitiveness of domestic products" PR-5011, the development of the electrical industry and the creation of new types of modern electrical and household appliances, was adopted in order to increase export potential.

Paragraph 4 of this resolution provides for the introduction of the following measures to support the enterprises of the electrical industry by the Export Promotion Agency. Until January 1, 2024, the export of electrical and electrical products to all countries, including neighboring countries, will not exceed 50% of the cost of transportation by road, rail and air, but not more than 15% of the export value (excluding transportation costs) by road and 20% by rail. as collateral for providing subsidies for reimbursement and making advance payments (refunds) in the framework of tenders, regardless of the source of funding, compliance with the terms of the contract in foreign currency and guarantees from local commercial banks for goods (works, services) up to 50 percent of the guarantee amount, but not more than \$ 3 million.

In addition, paragraph 5 of the resolution provides tax benefits to enterprises of the electrical industry for the period from April 1, 2021 to January 1, 2024 at a rate of not less than 80% of total revenue from sales of electrical products at the end of the reporting period in the form of income tax and property tax rates funds released in connection with the granting of tax benefits provided for in this paragraph:

not distributed by enterprises in the form of dividends;

the creation of new production facilities and the modernization of existing facilities.

Also, in paragraph 6, when placing a copper cathode produced by JSC "Almalyk MMC" on the exchange, its starting price is reduced by 8% from April 1, 2021, 6% in 2022 and 4% in 2023 from the price of the London Metal Exchange without VAT. , From January 1, 2024 at the London Metal Exchange price (export price), and from April 1, 2021, 25% of the payment will be made in advance and the remaining 75% will be paid by industry enterprises that have introduced high-tech production processes in the purchase of copper raw materials through exchange trading. introduced the procedure of implementation in equal shares every month within 90 working days after the receipt of copper raw materials.

### **CONCLUSIONS AND SUGGESTIONS**

The level of utilization of its potential and resources in the development of industry, including its processing industries, remains low, the tax burden on the economy remains relatively high, which reduces the competitiveness of industrial products sold in domestic and foreign markets.

It is necessary to improve the existing mechanisms in the form of tax reductions and exemptions, depending on the priorities of socio-economic development of the country, the acceptability of the results of the assessment of their direct and indirect impact on the economy, social sphere.

### **REFERENCES**

1. Tax Code of the Republic of Uzbekistan - G. Gulom 2020 y.- 640 p.
2. Resolution of the President of the Republic of Uzbekistan dated March 2, 2021 No PR-5011 "On additional measures to further develop the electrical industry and increase the competitiveness of domestic products."

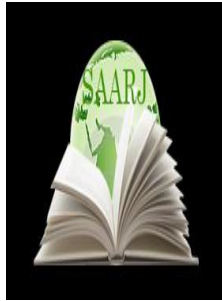

**ACADEMICIA**  
**An International**  
**Multidisciplinary**  
**Research Journal**  
 (Double Blind Refereed & Peer Reviewed Journal)



DOI: **10.5958/2249-7137.2021.01026.0**

## **SOME PROBLEMS IN TEACHING ENGLISH AND NEW EDUCATIONAL TECHNOLOGIES**

**Kurbaniyazova Sarbinaz Ametovna\***; **Esbergenova Gumshagul Bekbergenovna\*\***;  
**Utepbergenova Damegul Najimatdinovna\*\*\***

\*Senior Teacher,  
 Department of Foreign Languages,  
 Nukus State Pedagogical Institute, UZBEKISTAN  
 Email id: sarbinaz5959@mail.ru

\*\*Assistant Teacher  
 Department of foreign languages,  
 Nukus state pedagogical institute, UZBEKISTAN  
 Email id: esbergenovagumsha@gmail.com

\*\*\*Assistant Teacher  
 Department of Foreign languages,  
 Nukus state pedagogical institute, UZBEKISTAN  
 Email id: udamegul@mail.ru

### **ABSTRACT**

*This article discusses some of the challenges in teaching English and new learning technologies. For effective teaching of English in other language groups, it is expedient to organize new pedagogical technologies in students, the organization of education with graphic organizers. The organization of education on the basis of language technology in specialties other than English creates difficulties for students to learn a foreign language other than their native language. The goal of the new lesson topic is for the learner to adapt to the artificial reception when the English phrase is repeated.*

**KEYWORDS:** *English, Teaching techniques, Problem, New education, Technology, Education, specialist, Teacher, Case study.*

---

## INTRODUCTION

Education today is based on the active transfer of knowledge, the modernization of the national school system, the humanization of education, literacy, initiative, the development of creativity.

The most pressing problem in the education system of Karakalpakstan is the proper organization of education, the introduction of inclusive education based on state educational standards, the organization of English language teaching in secondary and higher education in other specialties.

As a solution to this problem, new pedagogical technologies of teaching English in other specialties, along with information technologies, are being implemented. Thus, programmatic learning is a type of education that provides reproductive acceptance of knowledge. In program education, the educator states the purpose of the new topic, resources, the purpose of the topic, and the interest of the learners is lower. This is especially noticeable when teaching is limited to lingophone technology.

The organization of education on the basis of language technology in specialties other than English creates difficulties for students to learn a foreign language other than their native language. The goal of the new lesson topic is for the learner to adapt to the artificial reception when the English phrase is repeated.

The modern educator should not only teach the educator, but also stimulate the learners, motivate them to a new topic, direct them to independent learning.

In order to teach English in other specialties and achieve effective results, it is good that we use adoption-oriented technologies of education. For example, a learning technology based on a non-adaptive lingophone. In order to avoid inconsistency with G.Palmer's established table idea, in the organization of education on the basis of new pedagogical technologies, first unfamiliar phrases are introduced into the presentation to be read aloud, then new terms and word and phrase structures are introduced in sequence. It can be seen that the vowel is read at the beginning of an unfamiliar phrase in a foreign language, and then, based on G.Palmer's table, new words and word structures are shown in sequence [1, 3, 5, and 6]. When organizing such training, the learner develops exoic memory along with audio-visual perception, i.e. short-term auditory memory [1, 3, 5, and 6].

When teaching English in other specialties, you will witness a text that is initially unfamiliar to learners, when you read the text over audio, and then when learners read the text themselves, you become interested in learning new phrases. You will also witness the development of long-term memory in learners when the meaning of new words in their native language, the text is relevant to their specialization, and then the grammar rules are briefly given.

The technology of development of figurative-associative thinking in students is an integral part of the integration of foreign languages in the genres of literature, drama, music in their native language in the teaching of English in other specialties [2,4].

In order to put this technology into practice, we must first adapt the topic identified in the curriculum to the ethnic language. For example, to teach English in the field of psychology, taking into account the ethnic aspects of this given group, the English meaning of national phrases associated with the brain, or the representation of mental processes on an intellectual map, and so on. As you know, the main idea at the center of the intellectual map is, for example,

the brain (the English translation of the brain is the brain), then the four large horns clockwise, for example the brain-connected brain, spinal cord, midbrain, cerebellum in English and so on. ideas are given in sequence. It is clear that teaching English in the field of psychology with the help of such a card will be highly effective.

Also, when we use this technology in teaching English in the field of music, you will witness a great interest of students in learning a foreign language when a plate from the works of famous Karakalpak poets is performed in English or a text from a famous work in the national language is given.

The use of case study technology in English teaching is also important. "Case-stage" is an English word ("case" - a specific situation, event, "stage" - learning, analysis) is a method of learning based on the study, analysis of specific situations. In a case, open information or a specific event can be used for analysis as a situation. Keys actions include: Who (Who), When (When), Where (Where), Why (Why), How (How), What result (What). In order to teach English in other language groups and specialties using case technology, the English text and solutions of real situations that adapt to the national environment are created first. Education organized using such technology will certainly achieve its goal [1,2,4].

One of the most effective pedagogical technologies for teaching English in other language groups and specialties is project technology.

Project technology is the individual or learning of learners to collect information, conduct research, and carry out research on a given topic for a specified period of time in groups. Using this technology, learners are involved in the planning, decision-making, implementation, verification and inference and evaluation of results of independent work in English. Project development can be individual or group, but each project is a coordinated result of the collaborative work of the study group.

The project should be able to serve learning, apply theoretical knowledge in practice, and enable learners to independently plan, organize, and implement [4].

Undoubtedly, the use of Venn diagrams - graphic organizers for teaching English in other specialties is also effective. Venn diagram - a graphic organizer in the organization of education. used in making and learning.

The diagram is formed from the intersection of two or more circles will be. In this case, a graphic image is a form of organization of teaching, which is represented by the image of two intersecting circles. Using a Venn diagram, it is possible to consider different concepts, principles, analysis and synthesis of ideas on a given topic in English through two aspects, to identify and compare their commonalities and differences.

In short, in order to effectively teach English in other language groups, we must not forget about the use of new pedagogical technologies in students, the organization of education with graphic organizers, as well as logarithmics, rhythm therapy, folk art therapy to relieve nervous and emotional stress.

**REFERENCES:**

1. Quinn D. J. The lab sheet: Making the lab teach // Foreign Language Annals. 1975. V. 8. N 2.
2. Ganieva M.A., Fayzullaeva D.M. A set of project-based learning technologies. Methodical manual / Series "Innovative technologies in the system of secondary special, vocational education." - T.: TDIU, 2013. - 83 pages
3. Lyaxovitskiy M. V., Koshman I. M. Technical means for training in foreign languages. M., 1981.
4. R.Ishmuhamedov., M.Yuldashev. Innovative in education and upbringing pedagogical technologies.-T.: "Nihol Publishing House, 2013 278 pages.
5. Chrestomathy on the method of teaching English. M., 1983.
6. Shenshev L. V. Adaptive arrangement for training yazykam. Avtorskoe svidetelstvo na izobretenie 1441445. M., 1989.





**ACADEMICIA**  
**An International**  
**Multidisciplinary**  
**Research Journal**  
(Double Blind Refereed & Peer Reviewed Journal)

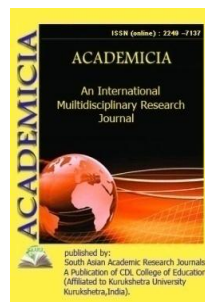

DOI: **10.5958/2249-7137.2021.01031.4**

**LEGAL BASIS OF IMPROVING THE SOCIAL PROTECTION SYSTEM**

**Kadirov Umidjon Abdimuratovich\***

\*Associate Professor,  
Head of the Research Coordination,  
Department of the Academy of the Ministry of Internal,  
Affairs of the Republic of Uzbekistan, Candidate of Legal Sciences,  
UZBEKISTAN

**ABSTRACT**

*The article deals with the social protection of the population. The article describes the specifics of social protection, which is relevant today. There is also a systematic analysis of the legal framework for improving the social protection system. The law pays special attention to the areas of social partnership, including social protection, support and social activism, employment, development of small business and private entrepreneurship, farming, protection of the environment, public health and healthy lifestyles. Today, our views on issues in the social sphere are gradually changing, and previous concepts and approaches are gaining new meaning.*

**KEYWORDS:** *Social Protection, Social Policy, Social Partnership, Social Mechanism, Legal Framework.*

**INTRODUCTION**

At the present time, the Republic of Uzbekistan is on the path of new socio-economic development. Because of independence, our people have the opportunity to live freely in their country, and most importantly, to build their future, their lives in accordance with national interests and eternal values, universally recognized democratic principles. At the initial stage of the transition to market relations, effective measures were taken to develop social protection mechanisms, social support and protection of the population.

Of course, the essence of the fact that social issues and their solution is a priority set by our state is human it is manifested in the fact that the principle of the supreme value of human rights and freedoms and interests is aimed at the realization.

At the same time, the work on social protection of the population in need of social protection, the state programs that reflect the comprehensive measures being taken are particularly noteworthy.

In this regard, President Sh.M.Mirziyoev In the Action Strategy for the five priority areas of development of the Republic of Uzbekistan for 2017-2021, paying special attention to the priorities of the social sphere, in which he puts forward such issues as "... consistent increase in employment and real incomes, improvement of social protection and health care, increase of women's social and political activity, implementation of targeted programs for the construction of affordable housing, development and modernization of road transport, engineering and communications and social infrastructure to improve the living conditions of the population, development of education and science, improvement of state youth policy"<sup>1</sup>

The Constitution of the Republic of Uzbekistan is our main encyclopedia, which embodies a completely new material, legal and methodological approach to the definition and guarantee of socio-economic rights of the individual in the social sphere. In particular, Article 2 of the Constitution stipulates that "the state represents the will of the people and serves their interests." and Article 7 states that the people are the sole source of state power, and that the interests of the people take precedence over everything else in the norms. In particular, the Constitution of the Republic of Uzbekistan stipulates that "Everyone has the right to social protection in old age, loss of ability to work, as well as in the event of loss of a breadwinner and in other cases provided by law."<sup>2</sup>

Indeed, from the first days of its independence, the Republic of Uzbekistan has been operating in accordance with international rules and universal principles in the social sphere. Examples are the Universal Declaration of Human Rights, the International Covenant on Economic, Social and Cultural Rights, and the International Covenant on Civil and Political Rights<sup>3</sup>.

Social protection, as one of the human rights, is based on international legal norms and standards, and therefore its main principles are derived from universal values. First of all, the Universal Declaration of Human Rights, which is one of the international legal instruments, states that everyone has the right to adequate social security in order to live independently in difficult financial circumstances.

In particular, according to the Declaration, a person is included in the list of social risks that are the basis for obtaining social assistance in any case where he is in need of assistance for objective reasons beyond his control.

Today, a number of reforms have been carried out in the country on the social issues of the rule of law, its relationship with the rule of law, social protection and theoretical and legal issues of its implementation, modern requirements for social protection, improving legislation in the field of social protection. In particular, the Law of the Republic of Uzbekistan "On Social Partnership"<sup>4</sup>, adopted by the Oliy Majlis of the Republic of Uzbekistan on September 25, 2014, is a continuation of these reforms.

The law pays special attention to the areas of social partnership, including social protection, support and social activism, employment, development of small business and private entrepreneurship, farming, protection of the environment, public health and healthy lifestyles. formation of a comprehensively developed and healthy young generation, education of young people, their spiritual and moral upbringing and vocational guidance, protection of motherhood

and childhood, as well as women's rights, their full participation in the socio-political, socio-economic and cultural life of the country Ensuring the development of science, education, information, culture and sports, raising legal awareness, legal awareness and legal culture of the population, strengthening the foundations of civil society and democratic rule of law, strengthening the ideas of interethnic, intercultural harmony and civil harmony issues such as the restoration and preservation of centuries-old, traditional spiritual-moral and historical-cultural values, protection of consumer rights.

Today, our views on issues in the social sphere are gradually changing, and previous concepts and approaches are gaining new meaning. Concepts such as "social policy", "social protection", "social partnership" differ from the previous ones and more and more reflect the changes taking place in our lives. Therefore, social policy is not only an activity aimed at solving the material problems of citizens, especially young people, but also a major part of the domestic policy of the state. The social protection policy includes not only the provision of material assistance to the needy, but also the maintenance of the normal functioning of the country's social infrastructure, the implementation of effective state and social governance in this area, providing all-round favorable conditions for citizens.

In the past, social protection consisted only of helping the needy, but today this concept includes increasing the level of employment of citizens, payment of wages according to the quantity and quality of work, social security, realization of the right to education, high quality medical care and covers all aspects of ensuring a decent life for a person.

Social protection of the population in need of social assistance has been carried out in different ways, at the expense of different sources, by different entities. In particular, it recognizes that the expansion of non-governmental forms of social protection is a priority in the process of building the rule of law and civil society. This is due to the fact that socialization, which is carried out by the state, remains a priority, as the state has assumed the main responsibility for reform during the transition period, and strong social protection of the population is one of the main tasks.

The goal of social policy is achieved by the state through the provision of social guarantees, tax regulation of lifestyle, encouragement of charitable and entrepreneurial initiatives. Social policy should focus on solving priority problems, developing social mechanisms, coordinating government commitments with real funding opportunities. In turn, the problem of supporting vulnerable groups of the population is directly related to the state's participation in the management of the country's economy. The truth is that the modern state is a market state. The essence of a market economy is the free exchange of goods, the inviolability of private property and the recognition of the legitimate interests of the owner, the freedom of labor and private enterprise.

Despite the fact that our country has adopted many normative documents aimed at establishing the legal framework for social protection of citizens, we can not say that the basic laws defining the main principles of regulation of relations in this area have not yet been fully developed. The study of the experience of many developed countries shows that they have adopted laws that define the basic principles of social protection, on the basis of which the right of citizens to social protection is ensured.

In this regard, the role of the state in social protection of the population in the process of building civil society and the rule of law requires addressing the problems of the role of its bodies, the

---

improvement of government agencies in the implementation of social protection, with the transition to civil society, this function of the state will evolve, gradually becoming the responsibility of society, cooperation with public associations, NGOs, citizens' self-government.

#### LITERATURE

1. Message from the President of the Republic of Uzbekistan Shavkat Mirziyoyev to the Oliy Majlis on December 22, 2017
2. Law of the Republic of Uzbekistan «On Informatization» dated December 11, 2003
3. *Shavkat Mirziyoyev*. «Uzbekistan will fight crime according to a new system: its name is» The Truth about Crime and Justice «following a video conference on crime prevention» on July 27, 2018
4. Kharitonov I.K. Legal problems of protecting the right to information \ \ Materials of the All-Russian initial practical conference dedicated to the memory of V.D. Sorokin. Krasnodar 2017., p. 178
5. Law of the Republic of Uzbekistan «On Personal Data» dated July 2, 2019 No.

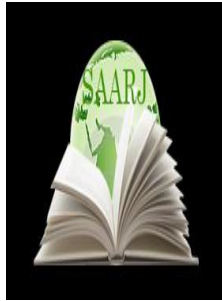

**ACADEMICIA**  
**An International**  
**Multidisciplinary**  
**Research Journal**  
 (Double Blind Refereed & Peer Reviewed Journal)



**DOI: 10.5958/2249-7137.2021.01032.6**

## INTERPRETATIONS ON THE THEORY OF SUFISM (VIEWS ON THE TERM SUFISM, PLACE AND TIME OF ITS EMERGENCE)

**Ismoilov Kahramonjon Abdumuminovich\***

\*Senior Teacher,  
 A Researcher of Kokand State Pedagogical Institute,  
 UZBEKISTAN  
 Email id: ismoilovqahramon9@gmail.com

### ABSTRACT

*In the article, the interpretations of the theory of Sufism, the terminology of Sufism, the views on the place and time of its origin are interpreted in comparison with the opinions of Eastern and Western scholars. If there was science, it would be learned through education. Sufism is morality with the qualities of divine morality<sup>9</sup>. Here the Sufi observes Sufism in a comparative way, because even if a Sufi is knowledgeable and feels a lack of morality, he cannot be a true Sufi. The term of Sufism was debated with different opinions about the place and time of its emergence. Some opinions of foreign scholars on this subject were found to be relevant.*

**KEYWORDS:** *Hard Wool Fabric, "Suf", Sufism, Sufi, Interpretations, Asceticism, Quran, Hadith, Messenger (PBUH), Terminology Of Sufism, Eastern And Western Scholars, Different Views And Theories, Christian Mysticism.*

### INTRODUCTION

The teachings of Sufism are among the scientific problems that have attracted the attention of many scholars not only in the countries of the East, but also in the world. Therefore, there are different views about it, and the concept of Sufism is also given different definitions. In particular, the research of well-known foreign scientists R.Nicholson, A.Arberry, L.Massignon, J.Trimingham, A.Shimmel and F.Mayer, aimed at shedding light on the concept of Sufism, is known to scientists. A.Arberry, who lived and worked on the threshold of the last century, left a number of great works on the teachings of Sufism. Explaining the meaning of the word mysticism, A.Arberry says that it is derived from "hard wool cloth", ie "suf", and that those who wear it are among those who voluntarily renounce this world<sup>1</sup>. At this point, A.Arberry calls them "Sufis" and points out that this dress was made in competition with Christianity. It can be

seen here that the scholar is referring to Islamic Sufis as imitators of some secular Christians. However, in the East, they knew very well that mysticism was gaining attention as the Sunnah of the Prophet (s.a.v.). J. Trimmingham also explains the meaning of the word mysticism in a way closer to A. Arberry's interpretation, and says that the clothes worn by Muslim ascetics in the early Islamic period were mainly "suf" and therefore they were called "Sufis". According to the scholar, the word "suf" gave rise to the mystical doctrine of Sufism<sup>2</sup>.

## MATERIALS AND METHODS

A. Arberry's "Mysticism" also deals with Islamic mysticism and expresses its attitude to mysticism through the views of several Western scholars<sup>3</sup>. The first page of the article begins with an idea from U. Inge's "Christian Mysticism". This idea is about the existence of the Creator and his eternity, determined by religious mysticism, and A. Arberry shows that the following opinion of Professor R. Zeiner is precisely related to Islamic mysticism. According to R. Zeiner, Islamic mysticism is a doctrine that is difficult to imagine. A. Arberry points out that some of the definitions of mysticism have been revised and clarified through R. Zeiner's "Mysticism is sacred and secular." A. Arberry supports the opinion of R. Zeiner and informs about the work of Professor R. A. Nicholson on the doctrine of mysticism<sup>4</sup>.

Hence, the teachings of mysticism and the definitions given to it have been sufficiently studied by foreign scholars since the beginning of the last century.

It can be seen that A. Arberry and J. Trimmingham's views and descriptions of mysticism and Sufism are limited to a single, apparent meaning. That is, the purpose of the Sufis from wearing that "suf" is described in a very superficial way. However, mysticism is a very broad concept, and the goals and ideas of those who hold these teachings are large enough.

Sheikh Ali ibn Sheikh Uthman al-Jullabi al-Hujwiri, in his book *Kashfu-l-mahjub* (The Opening of the Barrier), states that in addition to the ideas of A. Arberry and J. Trimmingham, mysticism also has inner meanings and "purity is clarity, clarity, transparency." He explains that it is derived from the word "suf" - "sof" (pure). This proves that the word can also mean purity, open volunteering<sup>5</sup>.

Some scholars in the West and the East say that mysticism is derived from the word "suffa," meaning that the "companions of the suffa" are pious people who have passed away during the lifetime of the Prophet (saas), and Sufis come close to them. Abu Rayhan al-Biruni, in his *Osar-u-l-Baqiya*, states that the word is derived from the Greek word "suf," meaning doctrine<sup>6</sup>. It is clear from the above definitions that different definitions are used in defining the concept of mysticism. In A. Arberry's article "Mysticism" and in J. Trimmingham's "Sects of Islamic Sufism" only the most proven and correct is that "suf" means "hard woolen cloth". It is possible that these two scholars were aware of other meanings of mysticism, but this fact is not reflected in the works known to us. We can say that the descriptions given by Sufis, especially in the early days, are important for mysticism. Many scholars can be attributed to the Sufis who lived and worked in the first period. But only a few of them are limited to describing mysticism in their works. It is expedient to include in the scientific circulation the works of Abu Nasr Sarraj "Al-Lum'a" ("Shu'la"), Khujviri's "Kashfu-l-mahjub", Abulkarim Qushayri's "Risolai Qushayri", Suhrawardi's "Avorifu-l-ma'arif". The following are the descriptions of mysticism in these works. Ma'rufi Karhi: "Sufism embraces the truth and turns away from the hands of the creatures."<sup>7</sup>

Abu Hafs al-Haddad said: “Sufism consists of manners. Each time has its own literature. There is literature in every case. They have the rank of a perfect man who pays attention to the manners of the time ...”<sup>8</sup>

While the first definition is seen as a concept (science) that calls for distance from greed, the second states how important the issue of time is to mysticism. The description in Gal gives it clarity.

Abu Husayn al-Nuri said, “Sufism is neither a tradition nor knowledge, but morality. If Sufism was a ritual, it would be achieved with difficulty. If there was science, it would be learned through education. Sufism is morality with the qualities of divine morality”<sup>9</sup>. Here the Sufi observes Sufism in a comparative way, because even if a Sufi is knowledgeable and feels a lack of morality, he cannot be a true Sufi. Of course, morality should not be equated with simple, worldly morality. Scholars who have studied the teachings of Sufism seriously for many years abroad have succeeded in presenting this teaching - the great works of Sufism that we have not yet studied properly.

Turkey is one of the most studied regions in the West on Sufism. There are special "Theology" faculties in the existing scientific institutions. From this it can be understood that the views on Sufism, its terminology, essence, place, spread and time of origin are being studied in all aspects, in-depth research is being conducted. The fact that large-scale research has been done in this regard is recognized by today's scholars on Sufism. Scientific, popular, religious and moral works containing scientific, philosophical, socio-political views on Sufism and its history are being translated into Uzbek with great skill by scholars and translators on Sufism in our country<sup>10</sup>. Although the descriptions of Sufism in the works of this translation take different forms, the content, the sequence of views, the complementarity of ideas, in a sense, make one aware of what the essence of Sufism is. Of course, we are far from saying that we have found the perfect answer to Sufism with the opinions of Turkish scholars. Therefore, if Sufism is an ocean, those who describe it have not yet discovered the meanings that lie at the bottom of that ocean. However, we will focus on the definitions given in some translated works.

Professor Mahmoud A'sad Joshan, a theologian who had been active in spreading the teachings of Naqshbandi in Australia and had risen to the rank of Murshid (Master), describes Sufism in his works as follows: “Sufism is a way of life in religion. Sufism is a doctrine based on the Qur'an, the Hadiths, the words and deeds of the Prophet (PBUH) and the source of his main idea.”<sup>11</sup>

Professor Usman Turar gives a general definition of Sufism as a branch of science and states the following: “Sufism teaches how to get rid of bad qualities in the human heart, shows the good qualities in the heart and ways to achieve them, and is the highest “perfect person”. It is the science that teaches the rules of attaining status and, finally, explains the secrets of monotheism (*Tavhid*).”<sup>12</sup>

Muhammad Nurullah Sayido Jazari, a well-known Sufi and an active follower of the Naqshbandi sect in Turkey, also describes Sufism as follows: “Sufism deals with man and humanity. It conveys the essence of Islam by teaching a person the most important information about his self (*nafs*), the most important social etiquette in his relations with other people, and the things that benefit and harm him in the relationship between a slave and his God.” Shaykh 'Umar Faruq Sayyid al-Jazari continued this definition: “Sufism is the religion of Islam, the command of

Allah, the dignity of the Messenger of Allah (PBUH), and the priceless *sunnah*. He teaches us true love, sincerity, respect and dignity.”<sup>13</sup>

It is not fair to ignore the opinions of Shari'ah scholars when describing Sufism. Because the Sufism and the attitude towards the followers of Islam, which originated from Islam, must be carried out through the science of *Shari'ah*, we have found it possible to cite some of the definitions in the book "The Imagination of Sufism"<sup>14</sup> by late Sheikh Muhammad Sadiq Muhammad Yusuf. Although the same work of the Sheikh is not seen as a source that can give a perfect description of Sufism, it is given brief, succinct ideas from the Islamic point of view, citing examples from the Qur'an and Hadiths. It briefly dwells on the issue of *Murshid*(Master) and *Murid* (disciple)and some of the representatives of the sect.

The scholar scientifically substantiates the ideas of Sufism related to the words"suffa", "saf", "safa" and "suf", and also notes that there are opinions related to the name of that person because he attributed many worshipers in ancient times to SufaibnUddibnTlobiha. However, denying anything other than their word "suf", many say that the word "Sufi" is derived from the Arabic word suf-jun. First of all,in terms of vocabulary, this name is very accurate. In addition, those who weredeveloped to many prayers also wore very simple clothes. They usually wear onlywool, they say.”<sup>15</sup>

According to ShahidaBilqies<sup>16</sup> the etymology of the Word Sufi has been analyzed with 7 meanings of the word “*suf*”.

1. Safaa-which means cleanliness, particularly the purity of heart, soul and actions of a man.
2. AhleSuffa-During the life time of Holy Prophet (saw) there were certain ascetics (Zahids and Abids) whose sole occupation in life was nothing but continuous study and recitation of the Holy Qur'an, meditation, prayers and absolute devotion to God in the Prophet's historical mosque at Medina.
3. Suff-means row [Those Muslims who always tried to offer their Namaz (prayers) in the coveted first row of the 'five daily' congregations during the Prophet's (saw) time].
4. Soofa-It is the name of an old Arab tribe who were dedicated to the service of Kaaba (Mecca).
5. Safoot-ul-Qafa-The hair that grows at the back of the neck.
6. SiyuSoofia-It is a Greek word which means Divine knowledge.
7. Sufana-A kind of Plant.
8. Soof-means Wool.

Sufism is deep and wide in terms of time and space, and has been gaining status for centuries. It is therefore not possible to describe Sufism in a complete sense based on its appearance in certain regions. In our opinion, it should be studied in regions by separating them into territories. Because the views of Sufism in North Africa are different from the views of Sufism in Central Asia, the views in Turkey are different from the definitions of Sufism in Iraq and Egypt, and the views in America and Europe are completely different.

Various, truthful and correct views on the history of mysticism have been expressed by many Western and Eastern scholars. A.E.Krimski in his "Development of Sufism until the end of the third century AH" sees two factors in the emergence and formation of mysticism: one is the



traces of Christianity in the West, which spread to Christian countries before the conversion to Islam, and the other to Buddhist-oriented countries in the East."<sup>17</sup>

P.Tsvetkov's "Islamism", A.Kazanski's "Islamic mysticism" and I.Goldtsier's "Lectures on Islam" are seen as superstitious approach to Sufism.

F.A.Toluk writes that Sufism originated from the "generation of priests". He later rejected this unproven hypothesis and became convinced that Sufism was an Islamic teaching<sup>18</sup>. Foreign scholars supporting this view are A. Nicholson, L.Massignon, A. Arberry, J.Trimingham, A.Simmel, and others.

According to Ed.Brown, O.V.Macdonald, A.Venzink, Sufism originated from asceticism in Eastern Christianity and was developed by Syrian monks belonging to the Neo-Platonism form of Christianity. R. Dozi, referring to Iranian sources, writes that Sufism is a doctrine contrary to the Arabs and Islam<sup>19</sup>. Sufi scholars Richard Hartman, Max Horten, and others say that this doctrine originated from or was influenced by Hinduism, Buddhism, and the early Vedantas<sup>20</sup>.

## RESULT AND DISCUSSION

Apparently, these ideas are primitive views, and attitudes to them are new today. That is, Sufism is being studied as a science based on Islam, the Qur'an, and the Hadith, and this, of course, has come at the cost of a great deal of evidence.

As a result of our thinking, we can cite the attitude of Western scholars Louis Massignon and Reynold Nicholson to Sufism, who were engaged in this doctrine in the first half of the twentieth century. They set aside various alien ideas and tried to prove that Sufism is based on Islam<sup>21</sup>. When we study J. Trimmingham's "Progress of Islamic Sufism", we realize that the scholar saw the basis of Sufism in Islam in his description: "Sufism derives its experience from asceticism and Eastern Christian philosophy, the basis of which depends on the Qur'an."<sup>22</sup> Here it is difficult to agree with the scholar's phrase "Eastern Christianity."

To understand the origin of Sufism, which is considered to be very complex in the Muslim world, we must first have a clear idea of the state of the Islamic society in which it arose. It is not enough to state the existence of elements of knowledge, Neo-Platonism, monism and other similarities in Sufism, it is necessary to try to explain what conditions allowed these elements to flourish. Only then can we correctly understand the historical role of Sufism and its future destiny<sup>23</sup>.

J.Trimingham emphasizes that the attainment of enlightenment (*ma'rifa-gnosis*) through a sense of pleasure is a feeling of Sufism and an open doctrine<sup>24</sup>. It is known that Sufism consists of four statuses, and enlightenment (*ma'rifa*) is one of its statuses. They are concepts that are inextricably linked to the Islamic law (*Shari'a*), the Divine Way (*Tariqa*), the enlightenment (*Ma'rifa*), and the higher status of The Truth (*Haqiqat*). Whether enlightenment is left out of the view of some scholars or for some other reason, it falls within these four statuses, i.e., it is recorded as *Shari'ah*, *Tariqah*, and *Haqiqat*. A similar idea can be found in an article by Western orientalist J.A.Gross<sup>25</sup>. In it, J.A.Gross identifies the state of Sufism during the Soviet Period and expresses it through the thoughts of the Russian scholar O.Sukhareva. According to the article, O.Sukhareva describes Sufism as a syncretic aspect of Islam and an easily adaptable "divine inclination." At the same time, he gives a brief commentary on the three statutes, interpreting the *Shari'ah* as the means by which a Murid (disciple) must follow the "official" rules of Islam,

understand the essence of all things, and finally achieve the Truth through divine knowledge and ecstasy<sup>26</sup>. But according to ancient Sufi scholars, enlightenment is recognized as one of the statuses.

## CONCLUSION

The term of Sufism was debated with different opinions about the place and time of its emergence. Some opinions of foreign scholars on this subject were found to be relevant. The essence of Sufism has been explained by many examples, but finding a perfect answer that provides complete content remains a challenge. However, in view of the above, we have come to the conclusion that Sufism can be defined as follows: Sufism is the religion of Islam, that is, the teachings based on the Qur'an and Hadith, and the Sunnah of the Prophet (saas) is followed by the Sufis. It is basically an inner science, and the person who enters it is called a Sufi. It is derived from the Arabic word "suvf-jun". The scientific proof of the other definitions given to it is scarce or questionable. We remain of the same opinion.

## USED LITERATURE:

1. Arberry A.J. *Mysticism. The Cambridge History of Islam. Vol-2B.* Edited by P.M.Holt...pp.604-605
2. A.J.Arberry, *Sufism* London, 1950
3. L.Massignon. *Essai sur les origines du lexique technique de la mystique musulmane*, Paris, 1922, p.131.
4. Fritz Meier. *Meister und Schuler im Orden der Naqsbandiyya.* Universitätsverlag C. Winter: Heidelberg. 1995. || See Russian version: *Учитель и ученик в ордене Накшбандийя. Суфизм в Центральной Азии (зарубежные исследования)* - Санкт-Петербург: 2001. – Б. 97.
5. Trimmingham J.S. *The Sufi Orders in Islam.* London. Oxford. N.Y., 1973. (Тримингэм Дж.С. Суфийские ордены в Исламе / Перевод с англ. А.А.Ставиской, под редак. и с предисл. О.Ф.Акимушкина. М., 1989. с. 1
6. Nicholson R.A., "A Historical Enquiry concerning the Origin and Development of Sufism", in *JRAS*, 1906
7. Nicholson R.A. *Studies in Islamic mysticism* (Cambridge, 1921).
8. Хужвирий Шайх Али ибн ал-Жуллаби ал-Ғазнавий. *Кашфу-л-махжуб*, 36–б. (Из истории суфизма: источники и социальная практика. Ташкент. "Фан". с.5).
9. Комилов Н. "Тасаввуф" 1-китоб, 1996, 7-б.
10. Ҳаққул И. *Тасаввуф сабоқлари.* Бух.ДУ. 2000 йил. 26-бет.
11. Маҳмуд Аъсад Жўшон. *Тасаввуф ва нафс тарбияси.*-Т.: Чўлпон, 1998.
12. Усмон Турар. *Тасаввуф тарихи. Таржимон ва нашрга тайёрловчи Н.Ҳасанов.*-Т.: Маънавият. 1999.
13. Маҳмуд Аъсад Жўшон. *Ислом, тасаввуф ва ахлоқ. Таржимон ва сўнгсўз муаллифи С.Сайфуллоҳ.*-Т.: Истиқлол, 2000.

14. Муҳаммад Нуруллоҳ Сайдо ал-Жазарий. Тасаввуф сирлари. 1-қисм.-Т.: Мовароуннаҳр, 2000.
15. УмарФоруқСайдо ал-Жазарий. Тасаввуфсирлари. 2-қисм.-Т.: Мовароуннаҳр, 2001-2004.
16. Муҳаммад Содик Муҳаммад Юсуф. Тасаввуф ҳақида тасаввур.-Т.: Мовароуннаҳр. 2004 йил.
17. Tholuck F.A. Sufismus sive Theosophia Persarum pantheistica Berolini, 1821.
18. Browne E.Q. Leterary history of Persia. V.1-4.Cambridge, 1951-1956.
19. Macdonald D.B. Derwishes.E.I.V.1; Wensinck A.L. The Muslim creed. Cambridge,1932;
20. Dozy K. Essai sur L’histoire de L’islamisme. Zeyde, 1879.
21. Hartman R. Zur Frage nach der Herkunft und den Anfanden des Sufismus. Der Islam. Bd. VI, 1916;
22. Horten Max. Yndische. Stromunden in der islamischen Mistick. Bd. 2.1-2. Heidelberg, 1927-1928.
23. Бертельс Е.Э, Суфизм и суфийская литература. – М: Наука, 1965. с.77-421.
24. Gross, Jo-Ann. The Polemic of “official” and “unofficial” Islam: Sufism in Soviet Central Asia. P.531
25. Кримский А.Е. Очерк развития суфизма до конца III века гиджри. – М: 1895. – с.42-76.

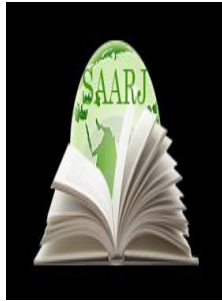

**ACADEMICIA**  
**An International**  
**Multidisciplinary**  
**Research Journal**  
 (Double Blind Refereed & Peer Reviewed Journal)



**DOI: 10.5958/2249-7137.2021.01033.8**

## BASES FOR RELEASING JUVENILES FROM CRIMINAL LIABILITY

**Akramova Muazzam\***

\*Doctoral student (PhD) of Tashkent State University of Law,  
 UZBEKISTAN

Email id: muazzamxon93@gmail.com

### ABSTRACT

*This article examines the aspects of exemption from liability juveniles in the theory of criminal law of the Republic of Uzbekistan and other countries. Explains the concept of exemption from criminal liability of juveniles. In this article, the author recommends a clear definition of his mental and physical development in juvenile delinquency and the influence of adults on him. She argued that the release of juveniles was a right, not a duty, of the courts and law enforcement agencies. Exemption of juveniles from liability is divided into general and special types. In the Republic of Kazakhstan, the Russian Federation, the Republic of Moldova and the Republic of Belarus, the grounds for the imposition of coercive measures on juveniles are different. It offers new coercive measures on the experience of other countries. She concludes, based on this, social organizations (institutions) and families of juveniles who have committed crimes should help to monitor, correct their mistakes, promote healthy development and become a full member of society. The concept of the basis for the release of juveniles from liability highlights the problems and provides new suggestions for its solution.*

**KEYWORDS:** *Exemption From Criminal Liability Of Juveniles, Humanism, Bailiff, Criminal Repression, Social Danger, Criminal Repression, Prosecution, Parent's Substitute, The Interagency Commission On Juvenile Affairs.*

### I. INTRODUCTION

Approved by the Decree of the President of the Republic of Uzbekistan dated February 7, 2017 "On the Strategy for further development of the Republic of Uzbekistan", strategy of actions on five priority directions of development of the Republic of Uzbekistan for 2017-2021 Priority II is called "Ensuring the rule of law and reforming the judiciary", Paragraph 2.3 sets out the priorities for "Improving administrative, criminal, civil and economic legislation".[1]

Section 6 of the Criminal Code of the Republic of Uzbekistan is called the Features of juvenile liability, and chapter XVI is entitled "Exemption from Liability or Punishment". Under paragraph 1 of the decision which adopted September 15, 2000 year, Plenum of the Supreme Court of the Republic of Uzbekistan on Juvenile Delinquency in the case of juvenile delinquency, carefully examine the facts to be proved, thorough and objective examination, a correct assessment of the set of facts and evidence, taking into account the degree of social danger of the act and the identity of the defendant to make full use of the features and privileges provided by law in accordance with the principles of justice and humanity.

Article 9 of the law of the Republic of Uzbekistan which adopted on 29<sup>th</sup> September 2010 year "On prevention of juvenile lack of control and offenses" information on interdepartmental commissions on juvenile affairs. Interdepartmental commissions on juvenile affairs within their competence: implements measures to prevent juvenile delinquency and offenses, ensures the protection of their rights, freedoms and legitimate interests.[2];

## II.METHODOLOGY

As components of the methodology, the author used general scientific methods, which involve the study of all phenomena and processes in their development, interconnection and interdependence, as well as special methods. In particular, the methods of dialectical materialism, system analysis, analysis and synthesis, logical, historical, comparative-legal, formal-legal used.

## III.DISCUSSION

A juvenile is a person who has reached the age of 14 but has not reached the age of 18 at the time of the commission of a socially dangerous act.[3]

Personality traits of juvenile offenders, characteristics of their criminal behavior taking into account the specifics of the legal status of juveniles, the current criminal law stems from the possibility of achieving the objectives of criminal liability primarily through the use of special services. The institute of exemption from criminal liability provides for less severe criminal measures, which have a special place for juveniles. Exemption of juveniles from criminal liability embodies the principles of humanity, justice, reduction of criminal repression.

Use of the institute of release from criminal liability for juveniles, in particular, to influence them without the use of criminal investigations. (not to drastically change the living conditions of juveniles when there is a possibility of while maintaining a positive family, study, work, and environment that has a positive impact on the juvenile).[4]The commission of a crime by a juvenile indicates shortcomings in his upbringing, moral and legal development. This crime can negatively affect the future of the juvenile and determine the nature of his relationship with the criminal law. Juvenile delinquency is greatly influenced by negative social processes and events in society. Juveniles are more susceptible to external factors than adults.

According to Y.N. Ermolovich, the features of criminal liability of juveniles can be distinguished as follows:

- 1) juvenile delinquency is recognized as a mitigating circumstance;

2) in sentencing juveniles, in addition to general circumstances, life and upbringing, level of mental development, other characteristics, as well as the influence of adults are taken into account;

3) The possibility of applying special grounds for exemption from criminal liability for juveniles who have committed low-risk and less serious crimes;

In determining the age of a juvenile, the last day of the year in which the crime was committed is considered. When determining the age, it is necessary to choose the minimum age given by the experts. According to I. Mukhacheva, "In determining the age of onset of criminal liability, the legislature should take into account all juveniles between the ages of 14 and 18, the importance of their actions (inaction), their ability to understand and manage social risks. However, juveniles of the same age in the document often have different physical and mental development. At the same time, physical and psychological indicators, legal consciousness (understanding and think of the prohibitions in criminal law) may not correspond to the generally accepted characteristics of juveniles. At the same age, the development of brain structures, the formation of functional systems, the formation of ethical guidelines and the system of legal consciousness may be different in different juveniles.[5]

The Criminal Code provides for coercive measures. The Criminal Code stipulates that a juvenile who has committed less serious crime may be released from criminal liability if it is recognized that its correction may be carried out through coercive measures.

The issue of the possibility of exemption of a juvenile from criminal liability with the use of coercive measures shall be considered only if there are no grounds for exemption from criminal liability under Articles 64, 65, 66, 66<sup>1</sup>, 67 of the Criminal Code of the Republic of Uzbekistan is used. In fact, when deciding whether to release a juvenile from criminal liability on general or special grounds, general grounds are given priority.

In general, this rule is consistent with the principles of differentiation and individualization of criminal liability and this rule applies to juveniles who, for the first time after the commission of a crime, have committed a low-risk or less serious crime and have shown themselves to be positive.(Articles 64, 65, 66, 66<sup>1</sup>, 67, 68 of the Criminal Code).[6]

The main differences between the general and specific grounds for the release of juveniles from criminal liability are as follows. First, the general grounds for exemption from criminal liability are unconditional, exemption from criminal liability with the use of coercive measures is conditional. Current criminal law and criminal procedural law clearly defines the status and binding nature of the measures under consideration.

However, the exemption of juveniles from criminal liability or punishment through the use of coercive measures in the literature, even if all the necessary conditions are in place, is not an obligation for law enforcement, but a right of law enforcement agencies. The conclusion that coercive measures can be used to rehabilitate a juvenile is prognostic, but based on factual data. Determining this possibility depends on assessing the juvenile's subsequent behavior. It is important to legally release juveniles from criminal liability.

First, the release of a juvenile who has committed a crime from criminal liability, expresses his condemnation of his criminal conduct by the state and the state's humanitarian policy in the fight against juvenile delinquency.

Second, exemption applies to juveniles (criminal coercion, punishment, and sentencing).Based on this, the social organizations (institutions) that committed the crime and the families of the juveniles were involved in the monitoring, to help her correct her mistakes, grow up healthy, and become a full member of society.[7]

Wider protection of the rights of juveniles, their age, their specific physiological and intellectual development, their ability to understand the nature of their behavior, their age, their specific physiological and intellectual development, their ability to understand the nature of their behavior the ability to understand the nature of one's actions, to re-educate young people who have committed crimes in light of their place in society, wider application of the principle of humanity to them, increase the effectiveness of sanctions, prosecution of adults and consideration of the reduction of criminal liability and impunity in connection with the expiration of the term of imprisonment, it is worthwhile to study foreign experience in this area, including the criminal law of the Commonwealth of Independent States.[8]

Article 87 of the Criminal Code of the Republic of Uzbekistan is called exemption from liability or punishment "It's the first time a juvenile has committed a low-risk crime, if the characteristics of the act committed taking into account the identity of the perpetrator and other circumstances of the case, and concluding that it can be corrected without penalty may be released from liability and the case may be referred to the Interdepartmental Commission on Juvenile Affairs".

On this basis, only the coexistence of each of these conditions can release a juvenile from criminal liability.

The provisions of Article 87 of the Criminal Code apply only in such cases, not at the time of the crime but may be applied even if the person under the age of 18 at the time the relevant decision is made or the decision (ruling) on release from liability is issued. In the same case, Article 87 of the Criminal Code when there are grounds for exemption from liability specified in Part 1 but if the defendant turns 18 at the time of the decision (ruling), the issue of release of such person from liability shall be resolved on general grounds in accordance with Articles 64-68 of the Criminal Code. Submitting the materials to the Interagency Commission on Juvenile Affairs for consideration exemption from liability for a crime committed only on one condition that is, the act is committed for the first time by a juvenile and is allowed only if it does not pose a threat to society.

If a person's previous conviction for a previous crime has been completed or removed in the prescribed manner or if the person has been released from criminal liability or punishment in accordance with Articles 64, 65, 66, 66<sup>1</sup>, 68, 69, 70, 71, 76, 87 of the Criminal Code the crime is found to have been committed for the first time. The issue of the expediency of releasing a juvenile who has committed a crime of low social risk can be resolved on the basis of a comprehensive study of the circumstances of the case and the identity of the accused. When referring to the features of the act committed in the content of part 1 of Article 87 of the Criminal Code characteristics of socially dangerous acts, aimed at harming this or that public relationship protected by criminal law and an understanding of how to obtain criminal intent (with or without the use of force).However, there are other types of coercive measures in the criminal codes of some Commonwealth of Independent States: placement in an educational institution with a special regime of detention, an obligation to apologize to the victim(Article 84 of the Criminal Code of Kazakhstan); install test control(Article 84 of the Criminal Code of Kazakhstan), referral

to special education and enlightenment programs (Article 105 of the Criminal Code of Ukraine) or medical and educational institution, forcing a juvenile to undergo a course of medical and psychological rehabilitation (Article 104 of the Moldovan Criminal Code). Belarusian criminal law is a general measure of educational impact on juveniles provides for the transfer of custody of the parents or their surrogates at their request, subject to the payment of a deposit in exchange for funds.(Article 118 of the Criminal Code of Belarus).

In accordance with the provisions of the Criminal Procedure Code of Moldova (Article 344-1) in respect of a person accused of committing a juvenile or less serious crime and a felony, prior to the appointment of a court hearing in respect of a juvenile; decides on the appointment of mediation or reconciliation of the parties sets a reasonable time to implement it. If reconciliation has taken place, hence, a mediation agreement is signed and the criminal investigation is terminated, otherwise the mediator draws a reasonable conclusion and submits it to the court.[9]

Terms and conditions of stay of juveniles in special educational institutions are determined by the legislation of the Republic of Uzbekistan. Terms and conditions of stay of juveniles in special educational institutions are determined by the legislation of the Republic of Uzbekistan. Compensation in the form of monetary compensation should be used with extreme caution to avoid committing a new property crime as a result of the juvenile's financial difficulties. Compensation for damages is made voluntarily through a bailiff.[10]

Article 83 of the Criminal Code of the Republic of Kazakhstan, adopted on July 3, 2014, is entitled "Exemption from liability and punishment." According to him, a juvenile who has committed a criminal offense or a less serious crime, or who has committed a moderate crime for the first time, can be prosecuted by a court if it is determined that it cannot be corrected without criminal prosecution, can be released. However, he may be subject to coercive measures.[11]

Article 89 of the Criminal Code of the Republic of Tajikistan, adopted on May 21, 1998, provides for exemption from liability through coercive measures. According to him, a juvenile who has committed a juvenile or moderate crime for the first time can be released from criminal liability if it is recognized that its correction can be carried out through the use of coercive measures.[12]

According to Article 118 of the Criminal Code of the Republic of Belarus of July 9, 1999 "A person under the age of eighteen who has committed a crime for the first time that does not pose a serious threat to the community or is less serious with the transfer of criminal liability under the supervision of parents or persons, their substitutes, at their request, if, on the specific nature of the crime committed, personal data and other circumstances of the case, the juvenile may be prosecuted may be released from liability if correction is possible without prosecution. A juvenile who has committed a crime may be placed under the supervision of his or her parents or guardians, subject to bail. The amount of the deposit is determined in the amount of ten to fifty times the basic amount, taking into account the financial situation of the parents. For crimes of low social risk and less serious, bail for crimes ranging from fifty to one hundred times the base value is set on the day of announcement. If the the person under surveillance has committed a new intentional crime within a year, the amount of the bail shall be transferred to the state.



**IV. CONCLUSION:**

The bases of exemption from criminal liability is now important in law enforcement practice. This is because the exemption is in line with the principle of humanity, which, through its application, frees the judiciary and the investigative bodies from excessive processes and excessive expenditures of the state budget. Prevents individuals from hiding from the courts and law enforcement for the rest of their lives. Based on the above, I would like to suggest the following. First, based on the experience of many CIS countries, Part 1 of Article 87 of the Criminal Code of the Republic of Uzbekistan should be amended as follows: A juvenile who has committed a crime of low social risk for the first time shall be released from liability if, taking into account the nature of the act committed, the identity of the perpetrator and other circumstances of the case, it can be corrected without penalty. However, coercive measures may be applied to him.

Article 88 of the Criminal Code of the Republic of Uzbekistan should be worded as follows. The following coercive measures are applied to juveniles:

- (a) an obligation to apologize to the victim in the form prescribed by the court
- (b) the obligation of a person who has reached the age of sixteen to pay or compensate for the damage caused at his own expense or by his own labor. This measure is applied if the damage does not exceed ten times the established basic calculation amount. In other cases, the damage is recovered in civil law
- (c) Placement of a juvenile in a special educational institution
- (g) Placement in an educational institution with a special regime of detention
- (d) Installation of test control
- (j) Medical and educational institution, forcing a juvenile to undergo a course of medical and psychological rehabilitation
- (f) The transfer of a single measure of educational effect to juveniles - the supervision of parents or guardians at their request, subject to the payment of a cash deposit.

**REFERENCES:**

1. <https://www.lex.uz/docs/-1449720>
2. <https://lex.uz/acts/-1685726>
3. Yu.V. Zagainova, I.A. Kutelev. Some features of the release from criminal responsibility of juveniles in the criminal legislation of Russia. Bulletin of the East Siberian Institute of the Ministry of Internal Affairs of Russia. 2 (53) 2010.-C.21
4. O.S. Kapinus. Textbook for undergraduate, specialist and graduate programs / ed. O.S.Kapinus; under scientific ed. K.V. Obrazhiva, N.I. Pikurova. - 2nd ed. - M.: Yurayt Publishing House, 2019. - P.627.
5. M.G. Jalilov. Release of juveniles from criminal liability and punishment. The scientific heritage No 41 (2019). P.51

6. S.A. Burlaka Features of criminal responsibility and punishment of juveniles: textbook. - 2nd ed. - Belgorod: Ministry of Internal Affairs of Russia, 2013. - C.32
7. Chan Thi Tu An. The concept of the release of juveniles from criminal liability under the laws of the Russian Federation and the Socialist Republic of Vietnam. Eurasian Union of Scientists (ESU) # 10 (19), 2015 | Legal sciences. –S.93
8. Anvar Kadirov. Legal basis for criminal prosecution of juveniles.// Article. 2016.<https://andijon.adliya.uz>
9. Ya.M. Matveeva. “The Institute of Exemption from Criminal Liability in Russian Criminal Law: Modernization and the Search for Alternative Ways to Settle a Criminal Law Conflict”. Diss ... can. Of jur. Sciences. St. Petersburg.: 2016.-P.67
10. Criminal law of Russia. General part: textbook for bachelors / otv. ed. A.I. Plotnikov. - Orenburg: LLC IPK "University", 2016. - P. 418
11. [online.zakon.kz](http://online.zakon.kz)
12. <http://continent-online.com>

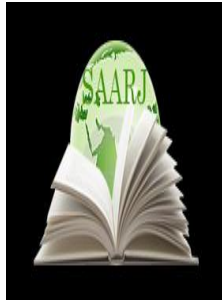

**ACADEMICIA**  
**An International**  
**Multidisciplinary**  
**Research Journal**  
 (Double Blind Refereed & Peer Reviewed Journal)



**DOI: 10.5958/2249-7137.2021.01030.2**

## EFFECT OF CLINICAL AND PHYSIOLOGICAL INDICATORS OF RABBITS IN FERULA ASSAFOETIDA

**Eshmatov Gairat\*<sup>1</sup>; Khudoikulov Islomjon\*\*<sup>2</sup>; Hakimov Akbar\*\*\*<sup>3</sup>**

<sup>1,3</sup>(PhD), Samarkand Institute of Veterinary Medicine,  
 UZBEKISTAN

### ABSTRACT

*In the second experimental group, rabbits reported a worsening of their general condition from the 27th day of the experiment, as well as changes in their attitude to food and water, changes in the condition of the mucous membranes and skin, and an increase in the size of the pupil.*

**KEYWORDS:** *Ferula-Assafoetida, Coumarin, Terpenes, Pulse, Respiratory Rate, Body Temperature, Body Weight.*

### INTRODUCTION

The new edition of the Law of the Republic of Uzbekistan "On Veterinary Medicine" in the normative legal acts of the President of the Republic of Uzbekistan dated March 20, 2018 No PP-3617 "On measures to establish the Republican kovrak plantations and increase the volume of processing and export of their raw materials" this research serves to a certain extent in the performance of the assigned tasks.

Galban (galban, Iraniangalbani) from *Ferula L.* family is a part of heating, greases (plasters). Abu AlibnSino [1]. In the book "Laws of Medicine" it is noted that their sins of the genus *Ferula L.* are used for joint pain, to strengthen the digestive process, to drive worms, to abort the fetus.

In Turkmenistan, young branches of the *Ferula L.* genus are used in the treatment of colds, lung and intestinal diseases, to strengthen immunity [6]. There sin obtained from the plant is used in the treatment of asthma, nervous diseases, superficial wounds, various wounds and tumors in the form of tinctures, emulsions, plasters, as well as in the prevention of miscarriage. It is also used in the preparation of canned food as a flavoring agent.

The use of Tajik ferulain Tajik folkmedicine has a long history. *F. tadshikorumis* used as analgesic in arthritis, the plant-based substances have expectorant properties and are used in the treatment of pulmonary tuberculosis, otitis and lymphadenitis. Many sources say that mixing this plant with milk is so effective in treating some dangerous allergies [2].

Subsequent pharmacological and biological studies of scientists have information that these plant substances have antioxidant, antiviral, anti-diabetic, anti-influenza properties, they can be used as anti-tumormolluscids, hypotensive agents [3,4,5].

### **The relevance of the topic**

The new version of the Law of the Republic of Uzbekistan "On Veterinary Medicine", the Law of the Republic of Uzbekistan dated March 20, 2018 "On measures to increase the volume of processing and export of raw materials and their export" This research to some extent serves in the implementation of the assigned tasks. Galula (galban, Iranian galbani) obtained from *Ferula L.* species is a component of heating and lubricants (plasters). Abu Ali ibn Sina [1]. In the book "Laws of Medicine" *Ferula L.* states that the resins of the genus are used in joint pain, to enhance the process of digestion, to expel worms, to abort the fetus. In Turkmenistan, young shoots of *Ferula L.* are used to treat pneumonia, lung and intestinal diseases, and to strengthen the immune system. The plant-derived resin is used in the treatment of tinctures, emulsions, plasters, asthma, neurological diseases, external wounds, various wounds and tumors, as well as in the prevention of miscarriage. The series is also used as a flavoring agent in the preparation of canned food. The use of Tajik ferula in folk medicine in Tajikistan has a long history. *F. tadshikorum* is used as a painkiller in arthritis, the plant-derived substances have expectorant properties and are used in the treatment of pulmonary tuberculosis, otitis and lymphadenitis. Many sources say that mixing this plant with milk is effective in the treatment of some dangerous diseases [2]. Subsequent pharmacological and biological studies have shown that these plant substances have antioxidant, anti-viral, anti-diabetic, anti-influenza properties, can be used as anti-tumor molluscids, antihypertensive agents [3,4,5].

### **Research methodology**

Considering the fact that alcohol extract from the juice extracted from the ferula-assafoetida plant has estrogenic properties when ingested to ovarioectomy rats, taking into account the consumption of coumarin, terpenes and other biologically active substances in ferula assafoetida grains by sheep and other animals, Scientific laboratory experiments were conducted to study the effect of the grain of the plant *Ferula-assafoetida* on the clinical and physiological parameters of rabbits in rabbits of individual entrepreneurs living. A total of 15 female rabbits with an average live weight of 3-3.5 kg and a total of 9 male rabbits with an average live weight of 3.5-4 kg were used for the experiments based on the principle of similar pairs.

Rabbits of the first experimental group were given 5% of the seeds of the plant in *Ferula assafoetida* daily to the mixed feed, and rabbits of the second experimental group were added 10%. The third group of rabbits served as a control group and they were fed only the mixed feed itself. The experiments lasted 30 days. During this period, each of the rabbits in the control group received a total of 4.5 kg of mixed feed. The first experimental group of rabbits consumed 4,275 kg of mixed feed and 7.5 grams per head, a total of 225 grams of 3% coumarin, terpene and other biologically active substances containing *Ferula assafoetida* plant seeds, ie 64 mg / kg per rabbit body per day. a total of 6.75 grams of coumarin, terpene and other biologically active substances were recorded. The second experimental group of rabbits consumed 4.05 kg of mixed feed and a total of 450 grams of 15 grams per person, 3% coumarin, terpene and other biologically active substances containing *Ferula assafoetida* plant seeds, ie 128 mg / kg per rabbit body per day. A

total of 13.5 grams of coumarin, terpene and other biologically active substances were recorded from

Research results and their analysis. Prior to and during the experiment, daily experimental rabbits were monitored through clinical examinations, their general condition, response to food intake and external environmental influences, pulse, respiratory rate, body temperature.

Clinical manifestations and changes in body weight of the mother rabbits in the experiment The first experimental group in which 5% of the plant grain *Ferula-assafoetida* was added to the mixture, showed the general condition of the animal, body temperature, pulse, respiration, attitude to food and water, weight, mucous membranes and skin. the condition indicators of the coating did not differ from those of the control group rabbits.

In the second experimental group of rabbits, in which *Ferula-assafoetida* was added 10% of the plant grain to the mixture, in the first days of the experiment, their general condition, body temperature, pulse, respiration, food and water, weight, mucous membranes, and skin condition did not differ from those in the control group. , from the 27th day of the experiment, they reported a worsening of their general condition, as well as changes in their attitude to food and water, changes in the condition of mucous membranes and skin, enlarged pupils, increased heart rate and respiration.

Analysis of live weight and daily growth of rabbits in the experiment showed that the average daily growth in mother rabbits in the first experimental group was 24 grams at the end of the experiment and the total growth was 720 grams, in the second experimental group the daily growth was 19 grams and the total growth was 570 grams. in the mother rabbits in the control group, the daily gain was 21 grams and the total gain was 620 grams.

The daily growth in male rabbits in the first experimental group was 28 grams and the total increase was 840 grams at the end of the experiment, in male rabbits in the second experimental group the daily growth was 20 grams and the total increase was 600 grams at the end of the experiment. 24 grams and 710 grams, respectively.

Thus, in experiments, 5% of *Ferula-assafoetida* plant grains were added to the compound feed, ie 4,275 kg of compound feed and 225 grams of 3% coumarin, terpene and other biologically active substances were fed to *Ferula assafoetida* plant grains. in rabbits, which increased by 3 and 100 grams, respectively, and in the second experimental group by 5 and 150 grams, respectively, in male rabbits consuming 5% *Ferula-assafoetida* plant seeds in compound feeds, compared with those in the daily and total growth control groups, respectively. and 130 grams, compared with 8 and 240 grams, respectively, for the second experimental group of male rabbits.

Analysis of the results showed that each head of rabbits in the experiment fed *Ferula-assafoetida* 5% of the plant grain, ie

He consumed 4,275 kg of mixed feed and 7.5 grams per head of animal, a total of 225 grams of 3% coumarin, terpene and other biologically active substances containing *Ferula-assafoetida* plant seeds, which contained 6.75 grams per rabbit (64 mg / day). kg) The general condition of rabbits exposed to coumarin, terpene and other biologically active substances, body temperature, pulse and respiration rate, attitude to food and water, weight, condition of mucous membranes and skin, as well as indicators and productivity did not change negatively for 30 days. However, in the experimental rabbit diet, the mixed feed was supplemented with *Ferula assafoetida*

containing 10% of plant seeds, ie 4.05 kg of mixed feed, and *Ferula-assafoetida* containing 3% coumarin, terpene, and other biologically active substances at a total of 450 grams per 15 head. When consuming *assafoetida* plant seeds, rabbits receiving 13.5 grams (128 mg / kg per day) of coumarin, terpene, and other biologically active substances per animal did not show signs of poisoning for a long time, ie 30 days, but lost live weight and total a decrease in growth was observed.

## CONCLUSION

The second experimental group of rabbits reported a worsening of their general condition from day 27 of the experiment, as well as changes in their response to food and water, changes in the condition of mucous membranes and skin, enlarged pupils, and increased heart rate and respiration.

*Ferula-assafoetida* is explained by the ferulin alkaloid in the plant, especially ethyl ether - acetic acid 4-oxycoumarin, and the cumulative effect of umbeliferons on organs and tissues.

## REFERENCES

1. Abu Ali ibn Sino. Laws of Medicine. Tashkent, People's Heritage Publishing House named after A.Qodiriy. 1992. Book. 2. 304b. 1992. Book. 3. 320 b.
2. Toxiri M. *Ferula cures opuxoli and omolajivaet body*. Izdanie 5-e s dopoln. and izm. / M. Toxiri, V.F. Korsun, K.V. Yaremenko. - Dushanbe: Tib, 2012. –32p.
3. Dehpour, A.A., Ebrahimzadeh, M.A., Fazel, N.S., Mohammad, N.S., 2009. Antioxidant activity of the methanol extract of *Ferula-assafoetida* and its essential oil composition. *Grasas and Aceites* 60, -P. 405-412.
4. Fatehi, M., Farifteh, F., Fatehi-Hassanabad, Z., 2004. Antispasmodic and hypotensive effects of *Ferula-assafoetida* gum exstract. *Journal of Ethnopharmacology* 91, -P. 321-324.
5. Saleem, M., Alam, A., Sultana, S., 2001. *Asafoetida* inhibits early events of carcinogenesis: a chemopreventive study. *Life Sciences* 68, -P. 1913-1921.
6. Rahmonqulov U., Avalboyev O.N. *Kovraklari O'zbekiston (monograph) // "Science and Technology" Publishing House, - Tashkent. 2016. 240-b.*

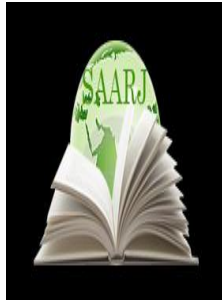

**ACADEMICIA**  
**An International**  
**Multidisciplinary**  
**Research Journal**  
 (Double Blind Refereed & Peer Reviewed Journal)



**DOI: 10.5958/2249-7137.2021.01034.X**

## THE ROLE OF SUBJECTS IN TEACHING FUTURE ENGINEERS TO SOLVE PROBLEMS RELATED TO PRODUCTION PRACTICE

**Movlonov Maruf Qalandarovich\***

\*Higher Mathematics Department,  
 Karshi Engineering-Economics Institute,  
 UZBEKISTAN

Email id: mavlonov.maruf@mail.ru

### ABSTRACT

*In this article, it is argued that at all stages of educational development, teaching should be linked to production practices. At present, the need for training in the field of science, mathematics, general and special disciplines in connection with the practice of production is defined in the qualification requirements for graduates of higher education institutions.*

**KEYWORDS:** *Engineer, Professional, Methodology, Referral, System, Production, Practice, Training.*

### INTRODUCTION

In recent years, great attention has been paid in the field of science and technology in our country. This attention requires qualified specialists in modern techniques and technologies. The training of such a specialist is the responsibility of higher education. Therefore, graduates of higher education must have serious training in natural sciences, mathematics, general and special sciences in order to master and manage modern techniques and technologies. Therefore, in this article we present the methods, forms and tools for the training of engineers in higher education in the natural sciences, mathematics, general and special disciplines.

### Main part

The presence of the oretical knowledge of students studying in higher education institutions does not mean that they have knowledge focused on industrial practice. Only when students are able to apply the knowledge they have acquired in a variety of situations does it indicate that they have some knowledge, skill, and competence. This focused ability can only be formed in the learning process, which provides a broad understanding of the relationships of all subject blocks in the curriculum. The possibility of these connections dependson:

- In the use of technology is widely used many methods mastered in the disciplines taught in higher education;
- At present, it is impossible to conduct the educational process without relying on the knowledge acquired in higher education;
- Modern techniques require users to have a deep theoretical knowledge, as well as an understanding of the theoretical laws and principles of action that form the basis of the creation and operation of this technique.

One of the means of applying the acquired knowledge to production practice is to teach students to solve practical problems related to production practice. At present, the theoretical basis of the methodology of using practical issues in the teaching of special subjects has become relevant.

We will consider the solution of practical problems as a basis for the implementation of practical training of the engineer, as well as the connection with the production practice. If we focus on the implementation of didactic functions, it is to prepare students for the acquisition of new knowledge, to strengthen the subject, to develop skills and abilities to use the subject, to describe the practical application of the subject. This, in turn, indicates the need to clarify the classification of issues according to their didactic functions. After a clear study of problem-based teaching methods, we identified two types of preparation tasks, with the help of which different methods of preparing students to learn a new topic were implemented. The first method is based on activating students' knowledge (traditional in higher education methodology), the second involves the use of problem-based research methods and requires problem identification and formulation. In the learning process, great attention will be paid to the independence of students, and it will be necessary to differentiate tasks related to research and creative approach.

Thus, to summarize the views expressed, the clear classification of problem groups is as follows:

1. Preparatory issues - preparing students to study a new topic.
2. Reinforcement issues are issues that combine the materials studied, i.e. definitions, concepts, formulas, proof methods, and so on.
3. Trainings - issues aimed at the formation of skills and competencies. In solving these types of problems, students must use a specific algorithm, a common method, and a traditional solution.
4. Research-related issues are issues that contribute to the consolidation and in-depth study of a topic, requiring students to use non-standard solutions, a combination of several traditional methods, and the use of certain algorithms in non-standard situations.
5. Creative issues - issues that contribute to the formation and development of research skills. In these types of issues, the goal may be defined. Identifying them is done in the process of solving the problem. The set of conditions, methods and tools required to achieve this goal should be determined independently by the students.
6. Supervision tasks are issues needed to determine the level of mastery of the material studied by students. These types of issues are provided for control, independent work.

At present, in the process of training future engineers, it is observed that science and mathematics courses are separated from technical sciences. This separation is so profound that learners cannot see objects known to them in a real situation, so they cannot use the mastered



natural-scientific and mathematical knowledge to describe the situation. Issues related to internships are rarely addressed in practical training, so graduates do not develop the skills to address such issues. Here are a few that hinder the active use of issues related to manufacturing practices:

- Insufficient space for them in textbooks and manuals;
- lack of time to address them in the learning process;
- Insufficient preparation of students for the school mathematics course;
- We can point out the reasons why the current stereotype of teaching mathematics does not always allow teachers to adapt to changing requirements and to include practical issues in the learning process.

## CONCLUSION

Summarizing all of the above, we can draw the following conclusions:

1. The analysis of the main stages of the development of education has shown that the purpose of education is a category of social significance, because it depends on social conditions. The history of higher education testifies to the fact that at different stages of development, educational goals have changed and supplemented in accordance with the prevailing social goals and worldview.
2. Many researchers have raised the issue of the need to use the most advanced ideas at all stages of the development of education, including the practice of teaching mathematics. At present, the problem of linking mathematical training with production practice has reached a high level, which is defined in the State Education Standards in the qualification requirements for graduates of higher education institutions.
3. Based on the principle of directing education to production practice, the main ways to implement the transfer of mathematical training of an engineer to production practice have been identified.
4. It has been found that a combination of methods, forms, and tools at different stages of teaching mathematics contribute to the practical orientation of an engineer's mathematical training.
5. One of the means of linking mathematical training with the practice of production in higher education is the use of interdisciplinary links of mathematics with general and special disciplines.
6. The use of practical issues related to all types of production practices in the context of mathematical training of an engineer helps to apply them systematically and purposefully in the learning process.

We consider it important to create a system of applied issues related to production practice and justify its use in various audiences and extracurricular activities.

## REFERENCES:

1. Movlonov, M.Q. "Professionally-oriented tasks in teaching mathematics using visual modeling technology". *European Journal of Research and Reflection in Educational Sciences*, 8 (5), 107-

109. (2020).

2. M.Q. Movlonov

“Matematikaning fanlararo aloqalaridakasbgamo ‘ljallangan vazifalarni yechishning metodik ta’minoti [Methodological support for solving professional tasks in the interdisciplinary relations of mathematics]”. Ta’lim, fan va innovatsiya jurnali, 2019/4-son, 105-108b

3. Shalkina T.N. Pedagogicheskie usloviya podgotovki budushix inzhenerov-programmistov [Pedagogical conditions of training of future engineers-programmers]. Sbornik statey IX “Mejdunarodno nauchno metodicheskoy konferensii”. Vypusk 7. Tom 1, 2003, s 262-270.

4. Shodiev R.D. Methods and Forms to Ensure Understanding in Educational Process. Eastern European Scientific Journal. DOI 10.12851/EESJ201805.

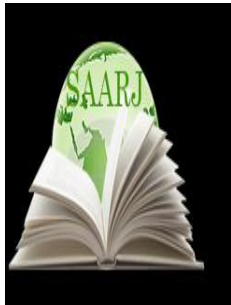

**ACADEMICIA**  
**An International  
Multidisciplinary  
Research Journal**  
**(Double Blind Refereed & Peer Reviewed Journal)**



**DOI: 10.5958/2249-7137.2021.01029.6**

**LEADERSHIP STYLE AND ITS IMPACT ON EMPLOYEE'S JOB RELATED STRESS  
A STUDY BASED ON JAFFNA DISTRICT SECRETARIAT IN JAFFNA DISTRICT,  
SRI LANKA**

**Miss. Sorubini Murugiah\***

Tutor Mentor, BBM Online Degree Programme,  
University of Jaffna, Sri Lanka  
E-mail- Sorubini06@gmail.com

**ABSTRACT**

*This research is carried out to find out whether there is a relationship between leadership style and its impact on employees job related stress. Researcher considered Transformational leadership style & Transactional leadership style. This study was conducted at Jaffna District Secretariat office where 100 employees were selected through random sampling method out of two hundred. The data were collected from selected sample. Then these data were presented and analyzed by using statistical techniques (SPSS). These analysis was used to find out (a) Transformational leadership has negative impact on employees job related stress (b) Transactional leadership has positive impact on employees job related stress.*

*Analysis showed negative correlation between transformational leadership & employees job related stress. The positive correlation between transactional leadership & employees job related stress. Further F test, ensured that there is a relationship between two variables. This result is true with 95%. Therefore, it was identified that job related stress of employees has negative impact on their transformational leadership style. That is job related stress; transformational leadership and transactional leadership lead to enhancement of employees' job related stress. T test proved that there is negative relationship between transformational leadership and employees' job related stress at 5% significant.*

**KEYWORDS:** *Transformational Leadership Style, Transactional Leadership, Job Related Stress.*

## **BACKGROUND OF THE STUDY**

Leadership is a social influence process in which the leader seeks the voluntary participation of subordinates in an effort to reach organization goals (Omolayo, 2000), a process whereby one person exerts social influence over other members of the group (Bamigboye, 2000). Leadership style is the manner and approach of providing direction, implementing plans & Motivating people. As seen by the employees, it includes the total pattern of explicit and implicit action of their leaders (Newstrom, Davis, 1993). Work stress is the harmful physical and emotional responses that occur when the requirements of a job do not match the capabilities, resources or needs of the work (United States National Institute for Occupational Safety and Health, 1999). Stress has its impact on the general & work life of the employees. It had often been said “A happy employee is a productive employee”.

People in Jaffna experience high level of stress due to prevailing political, economic & cultural problems. I have been heard many times people saying “Very difficult to work in Government offices because in most time have to work more than one boss namely Head of the Department, Political Party & the Government Circular”. Actually the leadership is the issue. An effective leader must make sure the employee to whom he/she is responsible, he never allows for role conflict which leads to job stress. Effective leader leads to several benefits such as, reducing moral stress; create new thinking and innovation which lead them to high level, fresh mind, good relationship, with co-workers, supervisor and employees etc. Leaders have an impact on the stress levels and work life balance of those they lead and, depending on the style of leadership, that impact can be either positive or negative.

This study attempts to identify whether leadership style of the leader affects their employee’s stress. Findings of this study could enable, leaders lead their employees well. Through the findings of leadership style and the reduced employee’s stress can improve both employees’ job satisfaction and performance. This study will attempt to analyze the relationship between leader’s leadership style and job related stress. Effective employee depends on many factors. The main factor is favorable leadership style. So the leaders first understand that, their behavior towards employee will have an impact not only their performance but also mental health

## **OBJECTIVES OF THE STUDY**

This study aims to achieve the following objectives.

1. To examine job stress of the employees in District Secretariat of Jaffna.
2. To examine the stress level of employees.
3. To recommend alternatives to reduce the job stress of the employees.
4. To identify relationship between Leadership style and Job stress of employees.

## **LITERATURE REVIEW**

Umer, P *et al* (2012) conducted study to examine the impact of leadership style (Transformational & Transactional) on employee performance & mediating rate of job satisfaction . Result shows transactional leadership was more significant than transformational in creating job satisfaction & Performance.

Amarjit, G *et al* (2010) conducted a study to examine the impact of Transformational leadership & employee empowerment on employee stress. The results found that the improvement in the level of perceived transformational leadership used by managers and employee empowerment mitigate the job stress of customer contact service employees in the Indian hospital industry.

Jens, R and Wolff S, (2009) tested relationships between transformational, transactional and non leadership styles and facets of chronic stress (i.e., excessive work and social demands, dissatisfaction with work and social recognition, performance pressure, and social conflicts), while controlling for subordinates' demographics and hierarchical level. It was found that one of the transformational leadership scales (i.e., individualized consideration) was negatively related to dissatisfaction. In contrast, the transactional subscale of management by- exception passive was positively related to four indicators of chronic stress, while controlling for all other transformational and transactional leadership styles. Future research should include objective indicators of stress. They recommend Managers in governmental organizations should avoid utilizing the transactional leadership style of management-by-exception passive in order to foster employees' health. The results allow for a more thorough and detailed understanding of leadership behavior, stress prevention, and occupational health.

Work stress is the feeling of tension, discomfort, uncertainty, indecisiveness and distress that a worker experiences as a result of the social and physical circumstances of the work setting. Leaders can reduce these stressors by providing direction and support for their employees (Kreitner & Kinicki, 1998), and this makes style of leadership very important in organizations.

Sosik and Godshalk (2000) reported negative associations between transformational leadership and job related stress, while contingent reward showed no associations.

Work stress is the feeling of tension, discomfort, uncertainty, indecisiveness and distress that a worker experiences as a result of the social and physical circumstances of the work setting. Leaders can reduce these stressors by providing direction and support for their employees (Kreitner & Kinicki, 1998), and this makes style of leadership very important in organizations.

Transformational leadership behaviors are highly active and influence subordinates in a positive way (Bass, 1985). The focus on long term vision, the communication of a sense of purpose and value-based leadership of transformational leaders helps subordinates to reframe stress-related events, i.e. to understand the underlying reasons for stress-related incidents.

Transactional leadership style (Avolio, 2002). We propose that this leadership style helps followers to internalize the expectations of their leader. Thus, contingent reward reduces uncertainty in a complex and potentially stressful work environment. Therefore, contingent reward should be negatively associated with chronic stress.

Transformational Leadership, as one such strategy, has been found to encourage open communication with followers, which in turn, reduces employee job stress. Gill *et al.* and Dhaliwal found a negative relationship between transformational leadership and job stress; that is, transformational leadership reduces employee job stress in the hospitality services industry.

## **METHODOLOGY**

This study based on primary data. Questionnaire is used as a tool for data collection. For the purpose of measuring leadership style the questionnaire developed by Bernard, M. Bass & Brupe

& A. Volio is used. This has two variables, such as Transactional leadership & Transformational leadership. For the purpose of measuring stress level the questionnaire developed by Parker & Decotiis (1993) is used. The questionnaire was translated in to Tamil to make the respondent understand well.

For the purpose of data collection, the researcher travelled to the respondent's location (Jaffna District secretariat office) and under the authorization of the administrators the questionnaire was handed out by the researcher to staff administrators (Administrative officer) at each unit. This method allowed the researcher to meet directly with staff administrators and staff to clarify any questions regarding the study and give explanations. 200 questionnaires were issued. Returned is 130. 100 Questionnaires were taken as sample.

### **HYPOTHESES OF THE RESEARCH**

The following hypotheses are formed by the researcher.

H1: Transformational leadership has negative impact on employee's job related stress.

H2: Transactional leadership has positive impact on employee's job related stress.

### **CONCEPTUALIZATION**

The pattern of relationship between the key concepts or variables is shown in a conceptual model

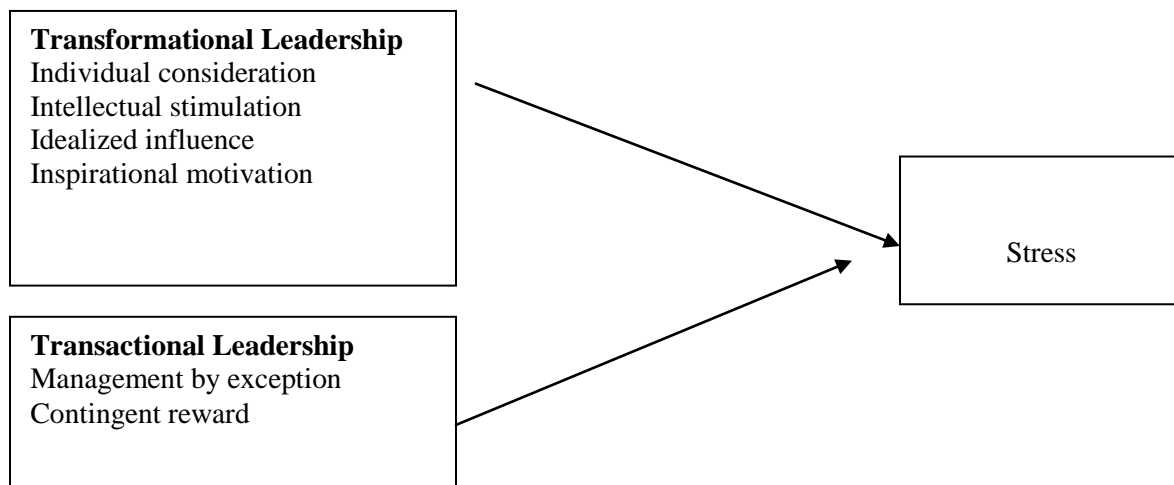

## METHOD OF ANALYSIS

### Correlations of Transformational leadership and Transactional Leadership factor and Job

When the employees' stress is correlated with transformational leadership, correlation is -

		Transformational leader	Transactional leader	Stress
Transformational leader	Pearson Correlation	1	.119	-.233(*)
	Sig. (2-tailed)		.291	.038
Transactional leader	Pearson Correlation	.119	1	.028
	Sig. (2-tailed)	.291		.803
Stress	Pearson Correlation	-.233(*)	.028	1
	Sig. (2-tailed)	.038	.803	

0.233. As correlation is negative, it can be said that there is a negative relationship between two variables. Therefore, hypotheses ( $H_1$ ) is accepted, that is handling high level of good transformational leadership will lead to lower level of stress to employees.

The relationship between transactional leadership and employee's job related stress correlation is 0.028. So there is not any significant relationship between transactional leadership and employee's job related stress. Therefore hypothesis ( $H_2$ ) is rejected.

## CORRELATIONS OF TRANSACTIONAL LEADERSHIP FACTOR AND JOB STRESS

Transactional Leadership factor	Pearson Correlation	Sig. (2-tailed)
Contingent reward	- 0.063	0.579
Management by expectation (active)	0.158	0.160
Management by expectation (passive)	0.132	0.244
Laissez faire leader ship	- 0.018	0.872

The relationship between Contingent reward and employee's job related stress correlation is - 0.063. So there is not any significant between Contingent reward and employee's job related stress. The relationship between Management by expectation (active) and employee's job related stress correlation is 0.158. So there is significant between Management by expectation (active) and employee's job related stress. The relationship Management by expectation (passive) between and employee's job related stress correlation is 0.132. So there is significant between Management by expectation (passive) and employee's job related stress. The relationship between Laissez faire leader ship and employee's job related stress correlation is - 0.018. So there is not any significant between Laissez faire leader ship and employee's job related stress.

### CORRELATIONS OF TRANSFORMATIONAL LEADERSHIP FACTOR AND JOB STRESS

Transformational Leadership factor	Pearson Correlation	Sig
Idealized influence attributes	- 0.034	0.728
Idealized influence behavior	- 0.189	0.682
charisma	- 0.219	0.110
Inspirational motivation	- 0.059	0.140
Intellectual stimulation	- 0.435(**)	0.000

The relationship Idealized influence attributes between and employee's job related stress correlation is  $- 0.034$ . So there is not any significant between Idealized influence attributes and employee's job related stress. The relationship between Idealized influence behavior and employee's job related stress correlation is  $- 0.189$ . So there is not any significant between Idealized influence behavior and employee's job related stress. The relationship between charisma and employee's job related stress correlation is  $- 0.219$ . So there is significant between charisma and employee's job related stress. The relationship between Inspirational motivation and employee's job related stress correlation is  $- 0.059$ . So there is significant between Inspirational motivation and employee's job related stress. The relationship between Intellectual stimulation and employee's job related stress correlation is  $- 0.435$ . So there is significant relationship between Intellectual stimulation and employee's job related stress.

### REGRESSION ANALYSIS

Transformational Leadership and Transactional Leadership are denoted by "X". The dependent variable employees' job related stress is denoted by "Y". It is also used to estimate value of y while x is increased by one.

### RELATIONSHIPS BETWEEN TRANSACTIONAL LEADERSHIP, TRANSFORMATIONAL LEADERSHIP & STRESS

model	Un standardized Coefficients(B)	t	Sig.
(Constant)	43.828	6.743	.000
Transformational leader	-.210	-2.171	.033
Transactional leader	.064	.589	.557

#### Coefficients (a)

The regression equation  $y = -0.210x + 43.828$  exhibits that the relationship between Transformational Leadership style & job related stress of employees. If the Transformational Leadership style is  $x=0$ , the average employees' job related stress is to be 43.828. Further, Transformational Leadership is increased by one; the employees' job related stress will be



decreased by 0.210. Therefore it can be said that there is a negative relationship between two variables.

Transformational leadership significance value is higher than significance level of 0.05(significance value 0.033), so **H1** hypothesis is accepted.

The regression equation  $y=0.064x+43.828$  exhibits that the relationship between Transactional Leadership style & job related stress of employees. If the Transactional Leadership style is  $x=0$ , the average employees' job related stress is to be 43.828. Further, Transactional Leadership is increased by one; the employees' job related stress will be increased by 0.064. Therefore it can be said that there is a positive relationship between two variables.

Transactional leadership significance value is higher than significance level of 0.05(significance value 0.557), so **H2** hypothesis is rejected.

Job related stress of employees is correlated with

Independent variable	Correlation	R - Square
Transformational leadership and Transactional Leadership	0.242	0.058

R- Square ( $R^2$ ) 0.058 explains that only 5.8% variable of stress is accounted for by transformational leadership and transactional leadership. In other words, 94.2% variable of employees' stress is accounted by other variable.

### RELATIONSHIPS BETWEEN TRANSACTIONAL LEADERSHIP STYLE & STRESS

Model	Un standardized Coefficients B	Sig.
Constant	33.766	.000
contingent reward	-.300	.621
Management by expectation (active)	.520	.177
Management by expectation (passive)	.620	.295
Laissez faire leader ship	-.215	.633

The contingent reward regression equation  $y= -0.300x+33.766$  exhibits that the relationship between contingent reward & job related stress of employees. If the contingent reward is  $x=0$ , the average employees' job related stress is to be 33.766. Further, contingent reward is increased by one; the employees' job related stress will be decreased by 0.300. Therefore it can be said that there is a negative relationship between two variables.

Contingent reward significance value is 0.621.

The Management by expectation (active) regression equation  $y = 0.520x + 33.766$  exhibits that the relationship between management by expectation (active) & job related stress of employees. If the management by expectation (active) is  $x=0$ , the average employees' job related stress is to be 33.766. Further, management by expectation (active) is increased by one; the employees' job related stress will be increased by 0.520. Therefore it can be said that there is a positive relationship between two variables. Management by expectation (active) significance value is 0.177.

The Management by expectation (passive) regression equation  $y = 0.620x + 33.766$  exhibits that the relationship between management by expectation (passive) & job related stress of employees. If the management by expectation (passive) is  $x=0$ , the average employees' job related stress is to be 33.766. Further, management by expectation (passive) is increased by one; the employees' job related stress will be increased by 0.620. Therefore it can be said that there is a positive relationship between two variables. Management by expectation (passive) significance value is 0.295.

The Laissez faire leader ship regression equation  $y = -0.215x + 33.766$  exhibits that the relationship between Laissez faire leader ship & job related stress of employees. If the Laissez faire leader ship is  $x=0$ , the average employees' job related stress is to be 33.766. Further, Laissez faire leader ship is increased by one; the employees' job related stress will be decreased by 0.215. Therefore it can be said that there is a negative relationship between two variables. Laissez faire leader ship significance value is 0.633.

### RELATIONSHIPS BETWEEN TRANSFORMATIONAL LEADERSHIP STYLE & STRESS

Model	Un standardized Coefficients B	Sig.
(Constant)	51.630	.000
Idealized influence Attributes	.523	.405
Idealized influence behavior	-.527	.377
Charisma	-.524	.497
Inspirational motivation	.660	.348
Intellectual stimulation	-2.380	.001

The Idealized influence attributes regression equation  $y = 0.523x + 51.630$  exhibits that the relationship between Idealized influence attributes & job related stress of employees. If the Idealized influence attributes is  $x=0$ , the average employees' job related stress is to be 51.630. Further, Idealized influence attributes is increased by one; the employees' job related stress will be increased by 0.523. Therefore it can be said that there is a positive relationship between two variables. Idealized influence attributes significance value is 0.405.

The Idealized influence behavior regression equation  $y = -0.527x + 51.630$  exhibits that the relationship between Idealized influence behavior & job related stress of employees. If the Idealized influence behavior is  $x=0$ , the average employees' job related stress is to be 51.630. Further, Idealized influence behavior is increased by one; the employees' job related stress will be decreased by 0.527. Therefore it can be said that there is a negative relationship between two variables. Idealized influence behavior significance value is 0.377.

The Charisma regression equation  $y = -0.523x + 51.630$  exhibits that the relationship between Charisma & job related stress of employees. If the Charisma is  $x=0$ , the average employees' job related stress is to be 51.630. Further, charisma is increased by one; the employees' job related stress will be decreased by 0.523. Therefore it can be said that there is a negative relationship between two variables. Charisma significance value is 0.497.

The Inspirational motivation regression equation  $y = 0.660x + 51.630$  exhibits that the relationship between Inspirational motivation & job related stress of employees. If the Inspirational motivation is  $x=0$ , the average employees' job related stress is to be 51.630. Further, Inspirational motivation is increased by one; the employees' job related stress will be increased by 0.660. Therefore it can be said that there is a positive relationship between two variables. Inspirational motivation significance value is 0.348.

The Intellectual stimulation regression equation  $y = -2.380x + 51.630$  exhibits that the relationship between Intellectual stimulation & job related stress of employees. If the Intellectual stimulation is  $x=0$ , the average employees' job related stress is to be 51.630. Further, Intellectual stimulation is increased by one; the employees' job related stress will be decreased by 2.380. Therefore it can be said that there is a negative relationship between two variables. Intellectual stimulation significance value is 0.001.

## CONCLUSION

In this research it is found that there is a negative relationship between transformational leadership style and employees job related stress. While, there is a positive relationship between transactional leadership style and employees job related stress. Fair leadership style, promotion, reasonable pay system appropriate work itself and good working condition leads to low level of employees' job related stress. In other words, reducing employee's job related stress has positive impact on their performance

## SUGGESTIONS AND RECOMMENDATION

Even Though there are several factor affecting employees' job related stress, this research only consider two variables: Transformational leadership and Transactional leadership. Therefore in future conducting a research including all the leadership styles will be valuable. This research is bound to 100 samples only. More samples from different parts of Sri Lanka should be gained to attribute the results to whole population.

## BIBLIOGRAPHY

Amarjit .G, Alan B.F, Smith.B, The Impact of Transformational Leadership and Empowerment on employee job stress, *Business & Economic Journal, Volume 2010: BEJ-3*

Karina.N, Raymond.R, Joanna.Y, & Sten – Olof B, The effects of Transformational leadership on followers' perceived work characteristics & psychological well being, *International Journal of*

*work, Health & Organizations Volume 22, No1 January –March 2008,16 -32*

Umer.P, Adnan.Q,Anam.M,Inam-ul-H.,Hamid.W (2012), *Global Journal of Mangement & Business Research volume XII issue IV version.*

Alban-Metcalf, R. J. & Alimo-Metcalf, B. (2007), Development of a private sector version of the (Engaging) Transformational Leadership & *Organization Development Journal*, 28, 104-121

Antonakis, J., Avolio, B. J., & Sivasubramaniam, N. (2003) Context and leadership: An examination of the nine-factor full-range leadership theory using the Multifactor Leadership Questionnaire. *Leadership Quarterly*, 14, 261-295.

Avolio, B. J., Bass, B. M., & Jung, D. I. (1999) Re-examining the components of

Transformational and transactional leadership using the Multifactor Leadership Questionnaire *Journal of Occupational & Organizational Psychology*, 72, 441-462

Avolio, B. J., Zhu, W., Koh, W. L., & Bhatia, P. (2004), Transformational leadership moderating role of structural distance. *Journal of Organizational Behavior*, 25, 951-968.

Avolio, B. J., & Gardner, W. L. (2005), Authentic leadership development: Getting to the root  
Bass, B. M. (1981). *Stodgill's handbook of leadership: A survey of theory and research*. New York: Free Press  
t of positive forms of leadership

Bass, B. M. (1985). *Leadership and performance beyond expectations*, New York: Free Press &

Bass, B. M., & Avolio, B. J. (1990). Developing transformational leadership: 1992 and beyond. *Journal of European Industrial Training*, 14, 21-27.

Bass, B. M., & Avolio, B. J. (1994), Improving organizational effectiveness through transformational leadership, Thousand Oaks, CA: Sage & Bass, B. M. (1998). *Transformational leadership: Industrial, military and educational impact*. Mahway, NJ: Lawrence Erlbaum Associates.

Bass, B.M & Steidlmeier, P. (1999), Ethics, character and authentic transformational leadership behaviour. *Leadership Quarterly*, 10, 181-217.

Bass, B. M. & Avolio, B. J. (2000). *MLQ Multifactor Leadership Questionnaire*.

Bower, D. G.. 1969. *Predicting organizational effectiveness with a four - factor theory of leadership*, In Gibb C. A., *Leadership: Selected Readings*, Baltimore, Maryland: Penguin.

Chen, Su-Zhang. 1981, An empirical case study on employees job stress, Department of Management Science,National Chiao Tung University & Chen, G., Goddard, T. G., & Casper, W. J. (2004). Examination of the relationships among general and work-specific self-evaluations, work-related job control beliefs, and attitudes. *Applied Psychology: An International Review*, 53, 349-370.

Cheng, [Li-Fang. 2004.](#) The effect of leadership style and job satisfaction on affective commitment.Department of Information Management. National Central University.

Chung, Y. Y., & Ding, C. G. (2002). Development of the Sales locus control Scale. *Journal of Occupational and Organizational Psychology*, 75, 233-245.

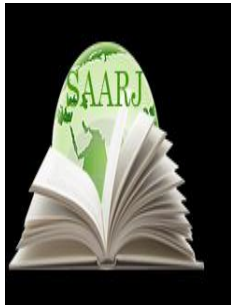

**ACADEMICIA**  
**An International  
 Multidisciplinary  
 Research Journal**  
 (Double Blind Refereed & Peer Reviewed Journal)

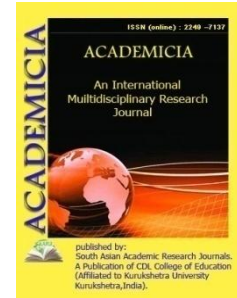

**DOI: 10.5958/2249-7137.2021.01044.2**

## SIGNIFICANCE OF MULTIMEDIA TUTORIAL ON LEARNING IN DISTANCE EDUCATION

**Raximova Gulchexra Obidjonovna\***

\*English teacher,  
 Uzbekistan state World Languages University,  
 Tashkent city, UZBEKISTAN

### ABSTRACT

*The purpose of the article is to learn the advantages of multimedia tutorial on learning in distance education programs. As we know, distance education is related to self-study and self-confidence on improving language skills. Also, in order to analyze the basic importance of multimedia tutorial, fifty graduate students were chosen as a sample for the research work. The researcher separated this sample into two groups, experimental group and control group. Both groups' students utilized traditional printed learning material of the university during their study. Despite this, the experimental group, along with print material, helped from multimedia tutorial of psychology in education. Results illustrated that students in the experimental group presented better than the students in the control group. The researcher knew that multimedia tutorial rose learning. This study suggested that multimedia tutorial techniques may be utilized face- to- face tutorial meeting between distance learners and teachers in distance learning programs to improve learning of students.*

**KEYWORDS:** *Multimedia Tutorial, Distance Education, Information And Communication Technologies, Synchronous And Asynchronous Delivery Methods, Conventional And Technical Devices*

### I. INTRODUCTION

Distance education is a teaching method that is based on informing students off-campus, at a distance and with a special, standard time-table. The distance education is an extremely wide learning period and covers all the conventional and technical devices to give more information about education to the masses. Distance education systems utilize correspondence, audio or

videotapes, or both, telecommunication and compressed video and audio systems for instructional goals [3].

The early distance education (DE) systems used print material for requirements and correspondence courses was the most ordinary delivery method of course material to learner that is interested in distance learning. Actually, at the present time, the DE systems utilize information and communication technologies (ICT) along with the above given method for instructional aim. The ICT consists of web based instruction, online (chat) communication, offline (e-mail) communication, video conferencing, and computer assisted instruction. The multimedia software available on CD-ROM has a great importance in labs, lectures, tutorial, and project works [15].

Koehler and Blair [8] have divided methods of distance education into two groups: Synchronous and Asynchronous delivery methods. In synchronous method, instructor and learners interact with each other in same time. A traditional classroom, two way closed circuit TV, and video conferencing are examples of synchronous methods of learning. Secondly, in Asynchronous method creation and delivery of instruction and the consumption of instruction occur at different times and usually at different places. Correspondence courses, audio video tapes, and courseware packages placed on CD-ROM or offered through a website are examples of asynchronous method of giving information on delivery. There are many popular universities in the world. Now, one of the most famous universities is the World languages university which is the largest one in Tashkent that challenges a diversity of distance learning degree programs at undergraduate and graduate levels. The university utilizes various devices to bring the gap between its teachers and students and to develop learning of. In AllamaIqbal Open University case, usually, method of instruction is print material which is sent to the learners through mail. Learning is also supported by TV/Radio programs and optional face to face meetings with the instructor. Besides these methods, OLIVE (open learning institute of virtual education) has been established since 2000. It has three models for delivery of instructions. In model A online assignment submission/checking, online special/guest lecture, and multimedia course streaming are provided. The second delivery model (model B) focuses on the students who have access to the internet. Internet based live sessions with teacher through OLIVE LMS is the main feature of this model. While in model C, students are provided self-learning multimedia courseware and reference material on CDs. Students can study material at home, office or any place of their choice. Moreover model B and model C can be combined to make a hybrid model for instruction delivery [15].

“Multimedia is defined as an interactive, computer mediated presentation that includes at least two of these elements Text, sound, still graphics images, motion graphics images and animation.” These tutorials consist of a user-friendly interface which provides control of navigation to learners [22]. Kruse and Kiel [9] has defined multimedia slightly different from that of Tannenbaum. They defined multimedia as CD-ROM. They say “CD-ROM provide a more engaging learning experience with text, audio, video, and animations all used to give information the set of multiple media means that learning is optimized.”

The generation of twenty first century has some distinct characteristics that set them apart from the previous generation. Technology has changed the lives of people of this generation. Most of the people of this generation have access to computers, video games, digital music players, video cams, cell phones, and all the other toys and tools of this digital age. This technology rich culture

has influenced the skills and interests of the people of the digital age. The students of this age are dependent on communication technologies for accessing information and for interacting with others [2].

Personal computers and laptops and other digital devices have changed today's learning style. Personal computers, laptops, cell phones, and other digital devices could be networked together. They are getting cheaper and are becoming smaller and more portable [4]. The use of this technology has created a new term of Ubiquitous Learning. Use of computer and internet in education is very common. It has generated many new terms like e-learning, online learning, Ubiquitous learning etc. Now it is possible to deliver computer based tutorial to a large number of students through systems distance learning [5]. Computer can be used to access information on CD- ROM, can be used to prepare material for teaching. It provides access to large amount of resources for teachers.

## II. METHODOLOGY

There are basic different learning methods in educational spheres by dividing into four groups. Each of them has got its own power, importance and limitations.

### a) VOICE

In this method the gap between the learner and teacher is formed by simple telephone calls, audio conferencing, audio tapes and audio CD-ROM

### b) VIDEO

Video tools with instructions include slides, films, video tape, and interactive video,

### c) DATA OR COMPUTER-BASED SYSTEMS.

Computer is a dynamic device which has more abilities of storing, processing, and communication of data, so the learner can use computer for chatting, blog, e-mail, or for watching video clips. The basic programs of Multimedia have a lot of good sides over traditional book version materials. Teaching with the help of computers results in active learning by interaction with computer based material, self-paced and individualized instruction, and presentation of multiple real time simulations [16].

Majority of teachers or scientists have been conducted research to determine effective sides of multimedia tutorials. One such research was conducted by Asan in Karadeniz Technical University, in Turkey in 2000-2001 [1]. In this research two groups of teachers were separately taught with traditional lecture method and multimedia. The results of the research work illustrated that the appropriate score in multimedia group was higher in terms of depth of comprehension, accuracy, rich supporting detail, organization, scope and reflection [1].

Advantages of the multimedia tutorials are concluded in the following points.

1. Allow self-paced instruction.
2. May incorporate text, graphics, video, and audio.
3. Allow high level of interactivity
4. Provide written record of discussion and instruction

5. Are cost effective
6. flexible in format and distribution
7. World wide access

The first and mostly utilized distance learning methods is print in. It is the cheapest source of communication used for correspondence courses. Print formats contain textbooks, study guides, workbooks.

Interactive multimedia learning is a new paradigm of learning. Multi-media tutorials deliver requirements to learners in a combination of several forms like, text, audio, video, animations and simulations. Multimedia express a computer based instruction which includes text, audio, moving pictures, and still pictures.

### **III. ANALYSIS AND RESULTS**

The computer mediated instruction is emerging as new way to add interactivity to the distance education. A lot of text as well as audio and video data can be stored on a CD-ROM. Students may utilize it in learning anywhere, any time. The multimedia software available and possible on CD-ROM has a great a role in labs, lectures, tutorial, and project works [13].

In this digital era teaching learning activities are now not limited to a class room. Technology has changed the lives of people of this generation. The people of this generation have access to computers, video games, digital music players, video cams, cell phones, and all the other toys and tools of this digital age. This technology rich culture has influenced the skills and interests of the people of the digital age. The students of this age most of the time use communication technologies for accessing information and for interacting with others. Desktop computers, laptops and other digital devices have changed today's learning style. Personal computers, laptops, cell phones, and other digital

Multimedia based instruction provides significant opportunities to improve the quality of teaching profoundly and cost effectively. There is 50% increase in the retention, a significant improvement in the learning rate, an increase in course completion, and a decrease in the overall cost of education [6]. Multimedia based education requires transformation of paper based contents to digital format. This new paradigm provides new learning environment. The conventional paper based contents may not fit to this environment. In the development of multimedia tutorial efforts are made to design and develop such contents for the new learning environment. For this paradigm shift transformation of education, especially distance education is necessary. The distance educational institutions (open universities) prepare interactive multimedia programs to overcome the shortcomings of the print material. Bork [2] suggested that natural way, to deliver multimedia tutorial, is through distance education. The tutorial can be used by distance learner anywhere and at any time. These tutorials motivate learners which is essential for successful distance teaching. In CD ROM a distant teacher can pack all the learning material (text, graphs, sound, videos, models and pictures), he wants to present learners for learning.

In AllamaIqbal Open University case, the usual method of instruction is print material which is sent to the learners through mail. Learning is also supported by TV/Radio programs and face to face meetings. Besides these methods, OLIVE (Open Learning Institute of Virtual Education)



has been established since 2001. It has three models for delivery of instructions. In model A - online assignment submission/checking, online special/guest lecture, and multimedia course streaming are provided. The second delivery model (model B) focuses on the students who have access to the internet. Internet based live sessions with teacher through OLIVE LMS is the main feature of this model. While in model C students are provided self-learning multimedia courseware and reference material on CDs. Students may study material at home. Moreover, model B and model C can be combined to make a hybrid model for instruction delivery [13].

It was an experimental research in which difference between two methods of instruction was studied. As  $n=60$   $n > 30$  ( $n$  is the size of experimental or control group) therefore for testing of hypothesis t-test was used. It has been stated in the proceeding section that the final examination held by the university was used as base. Therefore, grades in the examination were used as data which were collected from the controller of examinations AIOU and analyzed using Student's t-distribution.

#### IV.DISCUSSION

The role of ICT in education has been investigated by some organizations. According to a report of UNESCO [21] "A various computer-based technologies have been utilized including the distribution of sample lesson plans on CD-ROMS, setting up exchanges by computer conference between teachers' colleges, supporting the interactive usage of computer-based learning materials, encouraging the use of web-based materials, and using computer conferencing to encourage discussion among learners". Computer based instruction provide high-interest drill and practice programs to support learning, especially for students demanding skill remediation. Student evaluation is related that the new media of conferencing, e-mail, Web sites and electronic resources via library databases and the Internet are helpful in effective learning. An annual survey (conducted by UNECO) of different courses shows that Open University (OU) students in different faculties use these media in their courses. According to the survey findings [18]: over 40 per cent of their students rated such materials as very helpful. Science students, however, gave very low helpfulness ratings to audio CD, 60 per cent of language students rated audio CD as very useful, 40 per cent in health and social care, arts and education rated audio CD as very fruitful.

Computer based instruction supports crucial opportunities to enhance the teaching quality profoundly and cost efficiently. There is 50% increase in the retention, a significant improvement in the learning rate, an increase in course completion, and a decrease in the overall cost of education [7]. Some authors use the term e-learning which covers all forms of leaning in which computer is an essential component. Bandon Hall defines e-learning as instruction delivered electronically wholly by a web browser, through internet or intranet, or through CD-ROM or DVD multimedia platforms. When contents are delivered via CD-ROM or DVD it is referred to as computer based training. The use of WWW, CD-ROM, and computer based learning resources in the process of learning, anywhere, are various forms of e-learning.

The following beneficial ways of e-learning were defined by Choy in 2007:

1. Enhances learning
2. Improves engagement

3. Extends experiences in empowers the learner to take responsibility for scheduling and managing learning journey.

What is the role of multimedia tutorial in education and especially in distance education? Is its role effective? Before moving forward let's find answers to these questions. Multimedia tutorials have many advantages. While learning through multimedia students actively interact with learning material. It enables students to learn at their own pace. Individualized instructions and presentation of multiple real time simulations are the main features of these tutorials [10].

Multimedia programs have a great importance and efficacy in the process of learning. Teachers conducted a research to compare two methods of instructions, multimedia and lecture. The findings of the research related that average score in multimedia group was higher. They were better than the lecture group in depth of understanding, accuracy, rich supporting detail, organization, scope, and reflection.

Every Learning theory dictates some new changes in teaching/learning styles, situations, media, and methods. Developmental psychologists argue that important learning happens only in purposeful context and through active learning. Such type of learning is called situated learning. It is creation of an environment where students are actively participating in the exploration and analysis. Multimedia tutorial provide such environment where situated learning takes place [1].

Multimedia based instructions, like other teaching learning methods need support of a theory. Cognitive theory of multimedia learning supports and explains multimedia learning. According to this theory human information system consists of two separate channels, auditory channel and visual channel. Auditory channel is for the processing of auditory input and verbal representations. Visual channel is for the processing of visual input and pictorial representations. The theory further explains that the meaningful learning occurs after a cognitive process in auditory and visual channels. The cognitive process contains drawing attention to the presented material, organizing the presented material into a coherent structure, and integrating the presented material with existing knowledge [10]. After discussing the multimedia tutorial and its providing learning theory now let's discuss role of multimedia tutorial in distance education. Multimedia tutorial enhances effectiveness of distance education. It has the ability to be delivered to the distance students over a CD-ROM or a DVD, or through internet.

This study has used a post-test only control group design. Two groups (control group and experimental group) were formed. For an experimental study 30 numbers of subjects in each group is considered enough. However, in distance education usually the dropout rate is high and also by increasing size of a sample generalizability of a research can be increased.

## **V. CONCLUSION**

Computer based instruction (multimedia tutorial) techniques are more helpful than face to face tutorial. Performance of the students in the experimental group was better than the control group. The study recommended that the tutorial should be used as a supplement to the printed material in distance education. Multimedia tutorial techniques may be used along with face to face tutorial. To sum up, the main purposes of the article is to assess effectiveness of multimedia tutorial in learning and to explore the role of multimedia tutorial in distance education. The term distance education indicates that there is a distance between learner and teacher. In distance education a significant proportion of the teaching is conducted by someone removed in space

and/or time from the learner [20]. Distance education is a deliberate process and it consists of all types of formal instruction that are conducted when teachers and learners are not located at the same place [6]. Unlike learner of formal education distance learners use some means to overcome the distance between them and distant teacher. The face-to face meetings are used to overcome many of the flaws of print material. It provides a two-way real time interaction. But increase in face-to-face tutorial meetings may decrease the benefits of distance education. It also violates the principle of flexibility of distance education.

#### REFERENCES:

- [1] Asan, A., (2003). ‘School experience course with multimedia in teacher education’ Journal of Computer Assisted Learning (2003) 19, 21-34.
- [2] Bennett, S., Maton, K. & Kervin, L. (forthcoming, 2008). The ‘digital natives’ debate: A critical review of the evidence, British Journal of Educational Technology.
- [3] Boling, N. C., & Robinson, D. H. (1999). Individual study, interactive multimedia, or cooperative learning: Which activity best supplements lecture-based distance education?. Journal of Educational Psychology, 91(1), 169.
- [4] Cope, B., Kalantzis, M. (Ed). (2009). Ubiquitous Learning. University of Illinois: USA ISBN: 978-0-252-07680-0
- [5] Gene, T.S., & Judith, V.B., (1997). Distance Learning: The Shift to Interactivity.
- [6] Gilbert, S.W. (1995). Why distance education? A special bulletin. American Association for Higher Education. P. 48.
- [7] Iskander, M.F., Catten, J.C., Jones, A., Jameson, R., and Balcells, A. (1995 “Interactive Multimedia Lessons for Education,” Proceedings, IEEE Microwave and Optoelectronics Conference, Vol. 2, 1995, pp. 693–700
- [8] Koehler, W., & Blair, V. (2003). Distance education in library and information science discipline: the Valdosta State University Case. Informing science in SITE-Where Parallels Intersect, 294-300.
- [9] Kruse, K., Keil, J. (2000). Technology-based Training. San Francisco: Jossey-Bass/Pfeiffer.
- [10] Mayer, R. E. & Moreno, R. (2003). Nine Ways to Reduce Cognitive Load in Multimedia Learning, Educational Psychologists 38(1), 43-52.
- [11] Mayer, R. E. (2001). Multimedia Learning. New York: Cambridge University Press.
- [12] Meier S. (1988) An exploratory study of a computer-assisted alcohol education program. Computers in Human Services. 1988;3:111–121.
- [13] Natarajan, M. (2005). Innovative teaching techniques for distance education, Communication of the IIMA 2005 volume 5 issue 4.
- [14] Randy, G. (2000). ‘Theoretical Challenges for Distance Education in the 21st Century: A Shift from Structural to Transactional Issues’ International Review of Research in Open and Distance Learning c ISSN: 1492-3831, Vol. 1, No. 1 (June 2000).

[15] Sangi, A.N. (2005). Engineering Quality Learning through ICT an AIOU Model for Online Education and Research, ICDE International Conference on Open Learning and Distance Education, New Delhi, November 2005.

[16] Sangi, N. (2009). Access Strategy for Blended E-learning: An AIOU Case Study. Journal of the Research Center for Educational Technology (RCET), volume 5 N.2.

[17] Tannenbaum, R. S. (1998) Theoretical foundations of multimedia. New York: Computer Science Press.

[18] Thorpe, M., (2005). The impact of ICT on lifelong learning. In C. McIntosh & Z. Varoglu (Eds.) Perspectives on distance education: Life-long learning in distance higher education. Vancouver: Commonwealth of Learning/ UNESCO.

[19] Types of Tutorials, retrieve from website <http://www.mccoyin.com> accessed on March 14, 2008.

[20] UNESCO, (2002). Open and Distance learning: Trend, Policy and Strategy Considerations, Division of Higher Education, Paris UNESCO. International Journal for Infonomics (IJI), Volume 7, Issues 3/4, September/December 2014 Copyright © 2014, Infonomics Society p. 940

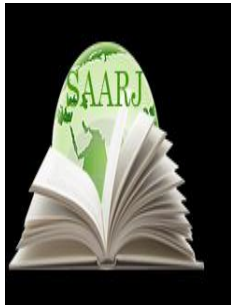

**ACADEMICIA**  
**An International  
 Multidisciplinary  
 Research Journal**  
 (Double Blind Refereed & Peer Reviewed Journal)



**DOI: 10.5958/2249-7137.2021.01045.4**

## DEVELOPING ENGLISH SPEAKING SKILL THROUGH ONLINE INTERACTIVE AND COMMUNICATIVE LESSONS

**Rasulova Dilnoza Boiskhanovna\***

\*English teacher,  
 Uzbekistan state World Languages University,  
 Tashkent city, UZBEKISTAN

### ABSTRACT

*The basic aim of this article is to enhance communicative English skill of secondary students that have difficulties on speaking. It is intended to address these questions: a) Are the employment of online communicative lessons helpful to develop learners' conversation skills compared to face-to-face classroom that is offline class with English speakers; b) Do we have any differences in the performance enhancements contributed with the help of the two learning approaches?; c) What learning approach improves the learners' communicative performance very well?; and d) What are the advantages and disadvantages of each learning approach in improving oral speech? There are 50 participants in this paper. They were basically sampled and classified into two groups: on learning through online conversation lessons and the other by classroom interaction with an English speaker. They were individually interviewed to evaluate and check their spoken English performance before the attitudes and after finishing the lessons. Video-recorded was done by students with their interviews and conversations practices for close analysis following Conversation Analysis (CA) principles and rated in the following peculiarities: accuracy, complexity, fluency, vocabulary, appropriacy, pronunciation, and grammar. The main tools of research employed in this work were spoken communication tasks for pre- and post-tests. The research findings based on statistical and CA analysis indicates that the students' oral English speaking remarkably enhanced by the usage of online lessons and interactive classroom with. The learners engaged in classroom interaction, however, became basically more fluent and had a broader variety of vocabulary than those learning through online conversations, even though their performance in pronunciation were similar. Thus, it was recommended that teachers utilize online lessons not as the sole language learning activity but as an addition to classroom interaction to focus on main speech features.*

---

**KEYWORDS:** *Online Communicative Lessons, Interactive Classroom, Speech Features, Oral English Performance, Conversation Skills*

---

## I. INTRODUCTION

This article is to compare the communication enhancement of learners using online communicative classes and those learning by offline interactive lessons, to make whether there are communication differences between learners learning speaking with the help of online lessons and those by face-to-face interaction with English speakers, and to discover how each learning approach can differently benefit learners' development of their conversation skills. The research questions are:

- 1) Are the employment of online communicative lessons helpful to develop learners' conversation skills compared to face-to-face classroom that is offline class with English speakers;
- 2) Do we have any differences in the performance enhancements contributed with the help of the two learning approaches? What learning approach improves the learners' communicative performance very well?;
- 3) Which aspect of the learners' communicative skill can be more useful strengthened by each approach?

English has long been utilized as a world language for global communication. Its importance as a global language has been even focused greatly particularly in the educational system. The Basic Education Core Curriculum B.E. 2551 (A.D. 2008) as a prominent for primary and secondary levels, which challenges learning English as a foreign language from Grades 1-11. The intention has been conducted on improving learners' good approaches and attitudes to learning the language and capability to effectively speak in English and use it as a medium for life-long autonomous learning (Ministry of Education, 2008).

Paying no attention of the level of learners, the purpose is to make them to share opinions, ideas, involve in English speaking on different themes, and find information significant for the choices of higher studies and future career. According to the current curriculum, young learners especially at the lower secondary level are expected to be aware and know 2,100 to 2,250 words and can speak about daily topics such as oneself and family, environment, food and drink, health, weather and climate (Ministry of Education, 2008). Nevertheless, according to Prapphal (2003), even though Thai students learn English from primary or even kindergarten level, many still fail to utilize the language with confidence in real-world speech events or when required to talk about everyday topics. Regardless of the established curriculum, it is apparently insufficient for second language learners to spend only a few hours a week learning English in classes that basically intention very little on conversation (Brooks, 2009; Wei & Zhou, 2002). Outside the classroom they also have no chances to interact in English and failure to persist the speech act (SalmaniNodoushan, 2014). Actually, these hindrances can be overcome if we as teachers attempt hard not only to create classroom environments which attract them in more intense English communicative activities, but also to motivate them to use in autonomous learning afterwards. Fujii (2012) noted that as teachers permit students to express their ideas with one another and possibly generate some new vocabulary words, the adaptation to features of natural

conversation will follow and can be strengthened addition as the learners are inspired to take duty for their language learning by attracting in after-class tasks of their choice (Nunan, 1996).

Apart from developing classroom spoken interaction, learners are therefore inspired to get positive features of bountiful computer-mediated language learning (CMLL) materials. Through the Internet learners of different groups can access a wide range of target web-based English learning materials with much ease. The availability of online resources has made language practice even more comfortable basically for EFL learners, most of whom have stopped chance to take exposed to English outside the classroom. Nowadays, a lot of websites give online English conversation lessons, giving the learners the chance to enhance their speaking skills in appropriate way, at their fingertips. Factually, there are many various websites supporting English speaking classes for EFL learners' self-study free of charge.

According to Barrs (2012), computer-mediated language lessons can actually complement offline classroom-based learning. While face-to-face learning of EFL learners remains mostly in the classroom setting and relies much on teachers' instruction, online learning can be done particularly from inside and outside the classroom through available technology applications and language training websites with little reliance on teachers. Mayer (2003) suggests that CMLL can in fact facilitate learners in developing vocabulary skills better than face-to-face learning. Audiovisual texts supported online would allow for recurring practice and assist accurate learners' misconception of the target language whereas in face-to-face teaching the learners are often deprived of such opportunity and have to draw attention to teachers.

As the goals of interaction in second language classrooms have been shifted from solely improving students' correct production of linguistic forms to containing the active production of meaningful speech with the goal of improving their L2 fluency, it becomes especially significant for teachers to comprehend the organization of the learners' speech and learning experiences in the classroom. Conversation analysis (CA), as theorized and practiced by Harvey Sacks and Emanuel Schegloff, has particularly started to have a great significance in an L2 classroom as it challenges useful devices for recording and transcribing the nature of talk in interaction (Seedhouse, 2004). CA is the study of recorded, naturally occurring talk-in-interaction to discover how participants understand and respond to one another in their turns at talk, with a central emphasize on how sequences of action are generated. Thus, CA popular focuses enabling teachers to recognize the patterns of communication that develop and maintain second language classroom interactions and provide learners to complete their conversation in the interactions. The language teaching material design of CA in particular shows dialogues in audio or video clips together with transcription permitting learners to experience their authenticity while learning linguistic expressions (Wong 2002 cited in Seedhouse 2004: 228). With the application of CA, teachers can also select authentic online speaking classes to suite learners' needs in an appropriate and make the best usage of bountiful online resources as additional learning materials for learners' autonomous learning. Given the many of online language learning resources at present, there has however been a dearth of studies particularly evaluating their efficiency, specifically in facilitating learners' improvement of conversation skills, compared to traditional face-to-face classroom-based teaching. Therefore, this study is intended to determine whether the employment of online conversation lessons can really be helpful to improve learners' speaking skills compared to face-to-face classroom interactions with English speakers, and in

what ways, if it can. It also tries to unveil how each learning approach can lend itself to the improvement in different aspects of the learners' communicative skills.

## II. METHODS

The participants of this study were fifty class 8 students from Rajchaprachanukroh 43 Songkhla province school under the Bureau of Special Education, Office of the Basic Education Commission. They were taking English as a core course of a foreign language demanded for secondary level students. The ages of students ranged from 13-15. They were selected by the purposive sampling method for the quasi-experimental treatment. The students were divided into two groups of twenty-five. One group was assigned to learn speaking through face-to-face interaction with English speakers and the other via online conversation lessons.

In educational process, instruments have a great role to conduct the class with interactive methods, techniques and approaches that are really important for students. The instruments utilized in this paper were lesson plans and oral speaking tasks. There were 6 lesson plan prepared by the researcher. Each lesson plan had duration of 150 minutes including the topic of introducing oneself and others, interview, food and family. The oral speaking exercises and tasks were pre-test and post-test. In the pre-test conversation, the participants were asked about their personal information and the conversations were recorded for subsequent assessment. After the treatment students were involved in post-test to see individual improvement.

The data was collected from the fifty student samples. In the beginning, the pre-test was conducted as all of the students were asked to converse with an English speaker to determine their conversation performance. The performance was assessed by the English speaker and videotaped for subsequent scoring by the researcher in the following features: frequency (speech flow), vocabulary (use of words and accuracy), appropriacy (turn responding), pronunciation (segmental sounds), grammar (range of structures used). The scoring rubric had been adapted from Barraja-Rohan (2011), O'Loughlin (2001), Luoma (2004), and Tsang & Wong (2002) (See Appendix). After the pre-test conversation, the students were engaged in weekly conversation lessons on the following topics: introduction and leave taking, likes and dislikes, family, and community. The training was take place three hours a week over the course of four consecutive weeks. One group of students was practice English conversation online in a computer lab with guide books containing specific instructions, conversation scripts, and exercises prepared by the researcher. At the beginning of the first session, the researcher as teacher was oriented them towards the training goal. The teacher was available during their practice only to help them with technical problems, allowing them to maneuver freely through the lesson until they master the target conversation. The students in the other group learnt conversation on the same topics through classroom face-to-face interaction with an English speaker and they were provided only with the scripts and exercises.

There were 6 lessons prepared by the researcher for both groups. In week 5, after the students complete their training, they were engaged in a post-test conversation with the same English speaker as in the pre-test. The test was measured by the English speaker and videotaped by the researcher. The score was analyzed by the two raters through the use of the same rubric, as in the pre-test. The videotaped conversations from both, the pre- and the post-test interviews were recorded and transcribed for subsequent comparative analysis. The comparative analysis threw



light on the strong and weak areas of the students and difficulties they faced during these sessions.

### III. ANALYSIS AND RESULTS

Learners' performance improvement via online conversation lessons and classroom interaction with English speakers. The videotaped oral interactive activities and the pre- and post-tests scores obtained from face-to-face interactions between participants later showed that classroom interaction learners have developed the participants' oral speaking over participants who had engaged in online lessons. However, both groups of learners have improved their oral performance.

As shown in Table 1, regarding the first research question which compared the enhancement of classroom interaction with English speaker and online communicative classes, the results analyzed by the t-test showed that both groups have same score from the pre-test which showed that the students have the same proficiency of English speaking skills.

**TABLE1 COMPARISON BETWEEN THE PRE-TEST OF GROUP 1 LEARNERS WHO PARTICIPATED IN CLASSROOM INTERACTION AND GROUP 2 PARTICIPANTS IN ONLINE CONVERSATION LESSONS**

Features	GROUP				t	df	Sig. (2-tailed)
	1 (n=25)		2 (n=25)				
	Mean	SD.	Mean	SD.			
Fluency	1.20	0.41	1.16	0.37	0.36	48	0.72
Vocabulary	1.16	0.37	1.24	0.44	-0.70	48	0.49
Appropriacy	1.24	0.44	1.24	0.44	0.00	48	1.00
Pronunciation	1.56	0.58	1.52	0.71	0.22	48	0.83
Grammar	1.08	0.28	1.16	0.37	-0.86	48	0.39
Total 25	6.24	1.64	6.32	2.15	-0.15	48	0.88
Total 100	24.96	6.56	25.28	8.62	-0.15	48	0.88

After the treatment the students who were assigned classroom interaction performed better in all speech features except in pronunciation where both groups were equal (2.32 for Group1 and 2.36 for Group2). However, there was only frequency that sig. at 0.05 (0.02) which indicated the differences in the classroom interaction, which has developed more than the learners who attained online conversation lessons.

However, indicated by the pre- and post-test score differences, the degree of improvement varied among the features; fluency appeared to be the most improved, whereas pronunciation appropriacy of turn responding, grammar and vocabulary were readily developed through face-to-face interaction with English speakers. Segalowitz & Freed (2004) suggested that for young learners, the fluency or speech flow is easier to improve and the more frequently learners occupied in meaningful conversation practice, the better their language performance and interaction will become.

#### **IV. DISCUSSION**

As we know, there are basic ways of improving speaking skill through online classes. However, online lessons can enhance self-education skill of students at the same time. Also, students can learn all types of competences by online classes. The most used and significant competence is Communicative one. The term “Communicative Competence” has been developed for many years. Hymes, (1972) stated that communicative competence is the ability to use language or interpreted language correctly in the process of interaction with the social environment such as the use of language in the proper regulation of social practices.

Moreover, Canale and Swain, (1980) and Celce-Murcia, (2007) also support Hymes’ idea that communicative competence is the ability to use language correctly, appropriate to situations and express suitable behavior in cultural context of communication. Therefore, communicative competence in this present study refer to the ability to use English language and interpreted language correctly and appropriate to situations and express suitable behavior in cultural context of communication. After reviewing many researches about component of communicative competence, it can conclude component of communicative competence as this following table.

#### **V. CONCLUSION**

This article is based on the enhancement of classroom interaction with English speaker and online communicative lessons to improve oral communication by the assessment of rubric, including five distinct features; namely, fluency, vocabulary, appropriacy, pronunciation, and grammar. The result of this work concludes that the online conversation lessons and classroom interaction with English speakers were flexible and practical styles to use, for the aim of improving good speaking skill. A teacher and learners can better use it by the application and sharing of real life experiences and situations within a healthy learning atmosphere. Thus, the roles of a teacher is a facilitator and a lider, inspiring learners with the help of linguistic interaction with others and using technology as an aid of educational and language learning activities as it permits for a lot of of chances and good environment to speakin the target language. Additional studies examining the online speaking classes and classroom interaction, should consider learners with various levels of proficiency and close-supervised training may be necessary for specific group of students. The rubric utilized for assessment in student’s communication should be made more suitable to naturally occurring conversations.

#### **REFERENCES:**

1. Barr, K. (2012). Fostering computer media. *L2interactionbeyondthe classroom. Language Learning & Technology*, 16(1), 10-25
2. Barraja-Rohan, A. -M. (2011). Using conversational analysis in the second language classroom to teach interactional competence. *Language Teaching Research* 15(4) 479-507
3. Blake, R. (2000). Computer mediated communication: A window on L2 Spanish interlanguage. *Language learning & Technology*, 4(1), 120-136. Retrieved February 20, 2012, from <http://lt.msu.edu/vol4num1/blake/default.html>
4. Brooks, L. (2009). Interacting in pairs in a test of oral proficiency: Co-constructing a better performance. *Language Testing*, 26(3), 341-366.

5. Luoma, S. (2004). *Assessing speaking*. Cambridge University Press. & Sinwongsawat, K. (2013).
6. Mayer R. (2003). Elements of science of e-learning. *Journal of Educational Computing Research* 29, 297-313
7. Ministry of Education, (2008). *The Basic Education Core Curriculum B.E. 2551*
8. Nunan, D. (1996). *Towards autonomous learning: some theoretical empirical and practical issues*. Thinking control: Autonomy in language learning. Hong Kong University Press.
9. O'Loughlin, K. (2001). *Studies in language Testing. The equivalence of direct and semi-direct speaking test*. Cambridge University Press.
10. Prapphal, K (2003). "English proficiency of Thai and directions of English teaching in Thailand". *Journal of English Studies*, 1(1), 6-12
11. Seedhouse P. (2004) *The interactional Architecture of the Language Classroom: A Conversation Analysis Perspective*. Blackwell, MA, USA
12. SalmaniNodoushan, M.A. (2007). Are task type and text familiarity predictors of performance on tests of English for specific purposes? *Asian ESP Journal*, p 67-96.
13. SalmaniNodoushan, M.A. (2014). Speech acts or language micro- and macro-games? *International Journal of Language Studies*, 8(4), 1-28
14. Tsang, W. K., & Wong, M. (2002). *Conversational English: An Interactive, Collaborative, and Reflective Approach*. In *Methodology in Language Teaching*. Cambridge University Press. Retrieved from <http://dx.doi.org/10.1017/CBO9780511667190.029>

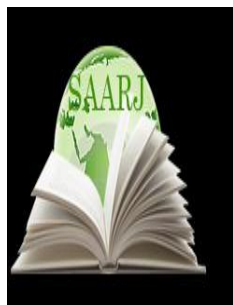

**ACADEMICIA**  
**An International  
 Multidisciplinary  
 Research Journal**  
 (Double Blind Refereed & Peer Reviewed Journal)

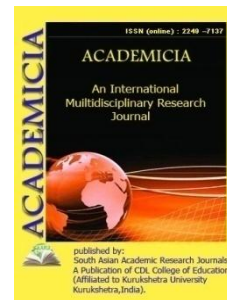

**DOI: 10.5958/2249-7137.2021.01046.6**

## DEVELOPING STUDENTS' UNDERSTANDING ON THE USAGE OF BLOG IN LINGUISTICS COURSE

**Aliyeva Dilorom Kholmatovna\***

\*English Teacher,  
 Uzbekistan state World Languages University,  
 Tashkent city, UZBEKISTAN

### ABSTRACT

*The basic aim of this article is to analyze the notion of students' blog use in a Linguistics course that is extremely important in an English Language Teaching program at universities. A lot of students participated in this course. The students were asked to answer to different blog questions on the linguistics lectures over the course of a term. They were also involved to share their answers and opinions with one another. The lectures related topics such as language acquisition, bilingualism and sociolinguistics. In the end of the term, the researcher regulated several tasks consisting of several questions about the usage of the blog and its contribution to their learning. The results of the study showed that the usage of the blog helped the students with their self-learning process and learning others' ideas, notions, helped them express themselves better than in class as well as understand the linguistic topics better.*

**KEYWORDS:** *Blog; Evaluation, Linguistics, Teaching And Learning, Self-Learning Process, Technologies, Cooperative Learning, Linguistic Course*

### I. INTRODUCTION

At present, the usage of Web 2.0 technologies, such as wiki, blog, podcast, instant messenger, online social communities (eg., Facebook), online video sharing (eg., YouTube), and online video and audio conferencing tools and their effect on teaching and learning have become one of the most investigated topics. This work checks the effective sides of using blogs on the learning of a different of topics in a college level Linguistics course. Blogs are defined as "personal or organizational web pages organized by dated entries, with newer items posted to the top of the site, usually consisting of links, media, ideas, perceptions, commentaries, personal thoughts, essays, papers and ongoing discussions" (Blood 2003, p.12). The efficiency of utilizing blogs for educational aims has been investigated and used by many researchers from various perspectives

(Armstrong et al., 2004; Boling, et al., 2008; Chan & Ridgway, 2003; Downes, 2004; Edbauer et al., 2005; Glass & Spiegelman, 2008; Glogoff, 2005; Haramiak, Boulton, & Irwin, 2009; Kajder & Bull, 2004; Martindale & Wiley, 2005; Quible, 2005; Ray, 2006; Wassell & Crouch, 2008). The studies presented that instructors who used blogs in their courses could support students with different kinds of activities that engaged students in discussions and give feedback to students regarding their comments. Through the usage of blogs, instructors also helped students expand their knowledge of a variety of topics, inspired them to focus deeply on the information that they acquired and write on their peers' blogs.

In addition, the studies also found that blogs enhanced literacy and motivated social and peer interaction. What makes blogs different from traditional classrooms is that blog users have more chances to present on each other's opinions and engage in discussions. One of the reasons that this study was conducted was to determine whether blogging would have a positive effect on the students' participation in discussions. Students in the present study, due to their low English proficiency levels, usually feel embarrassed or intimidated when they have to speak up in the classroom and this prevents them from expressing themselves. In addition, the fact that Linguistics involves many unfamiliar terms and concepts adds a new difficulty. It was hoped that blogging would motivate students to express themselves more frequently about the problems raised in class. In addition, a significant factor related to students' participation in the blog has to do with time. Since the students in the present study are not very fluent English speakers, they cannot express themselves in the classroom discussions and share their opinions with their classmates in a very short time. However, blogging can give students the opportunity to take sufficient time to reflect on others' opinions as much as they need to and also respond to them. Further, blogging is also perceived as an activity that can play an important role in improving writing. Through expressing themselves by the use of blogs, students can improve their writing skills. Some courses do not demand students to do much writing in the classroom and therefore, blogging can be an effective tool for students to express their views and thoughts in writing.

The main aim of the authors is to check the hypothesis that using a course blog develops and improves the quality of learning. It is expected that students will communicate with each other to discuss certain topics raised in class. The following section presents a brief review of the literature followed by the methodology used for the present study. Then the data analysis and results are reported and finally a general discussion is provided.

Cooperative learning (Slavin, 1996) suggests that motivation is maintained by social ties formed in collaborative or individual works, but shared works and blogs are also ideal for publishing material for critical feedback and seeing examples of others' work. Blogs offer a chance for students to reflect, rewrite, comment and perfect their work which do not exist or take too much time in class. Further, the chance to learn individually via blogs gives students an online personality where they can criticize others' work and communicate with other online communities for the advancement of their writing skills. Most tacit knowledge is gained through participation in such communities and emancipation of learners in this kind of media forms the basis of learning. Moreover, blogs do not restrict curricula. When the process of blogging is considered, most of the content of the blogs are prepared by students and thus it is the learner's choice to seek and find what to learn either through reading or writing. However, in order for blogs to be effective like any other self/collaborative learning environment, they must be built with guidance and structure, otherwise they will be nothing more than archives. For example,

excessive time spent on blogging activities caused lack of motivation among language learners to use and challenge in blogging activities. Thus, it is really significant that instructors train learners regarding writing critical feedback and give information them that blogs are more about substantiality, fluency and expression rather than accuracy.

The advantages of blogs on the teaching and learning process was examined from different perspectives. In Fessakis et al. (2008), when learners were asked to form an artefact together by using a blog, they stated that the online zone gave them chances that they could not otherwise utilize in class environment in such depth. The authors also focused the significance of communication and controlling but saw the absence of a notification system in blog as a bad side since some posted questions were left unanswered. The authors thought a study with higher number of participants and developed time for analyzing the usage of blogs because they thought that it would increase participation, especially if there is a larger body of material and different ideas. In another study, Park et al. (2011) found that blogging can be used to gather knowledge and information, express opinions, views and become more active in certain areas of interest. In the study, learners perceived blogging mostly as an acquisition and reflection oriented process. The majority of them also thought that blogging changed their personal ways of thinking and social relationships and helped them increase themselves. Further, they also gave information that blogs helped them deal with information differently. In Fessakis et al. (2008) participants reported that they could spend less time on tasks, monitor the work of others and directly communicate with one another by the help of blogs. They also expressed satisfactory learning outcomes, feelings of collaboration, and responsibility. Avcı and Aşkar (2011) compared factors that affect blogs and wikis as constructive tools in computer courses. The results presented that perceived useless was the highest determinant factor in using blogs in the teaching-learning process. In addition, blogs made it easier to access and reflect on information, inspired peer and social interaction and ensured feedback and equal access to information. Similar results were obtained from Yang (2009).

## II. METHODOLOGY

The aim of the study was to investigate the perceptions of the learners about the usage of the blog, more specifically, whether blogs would help them comprehend content better and as well as express themselves better than they do in class sessions. Participants were 2nd year students enrolled in three sections of a Linguistics course. Linguistics course is a required course which is taught over two semesters. The curriculum emphasized on core areas such as syntax, semantics, and phonetics in the Fall term and first and second language acquisition, bilingualism and sociolinguistics in the second term. The study was conducted over the Spring term. All three sections were taught by the same instructor. The sections met once a week for three hours. There were approximately 50 students in each section and students were predominantly female. Students were between the ages of 18 and 20. Convenience sampling was used in the study. Seventy-one second-year students (52 females, 16 males, 3 students did not report their gender) volunteered to participate in the study.

First, the researchers created a blog for use as a discussion forum for students. Then during the semester, they asked the students to answer to several blog questions about the linguistics lectures. The lectures used topics such as language acquisition, bilingualism and sociolinguistics. The course was conducted over a 10-week period. Students were required to focus upon the issues each week and post their views on the questions; as well as post comments on their

---

friends' answers. They were also motivated to debate their responses with each other. Students were given a choice on whether to be anonymous or identified when blogging. In addition, the participation in the study was voluntary. The effect for this is that students using blogs as part of the fulfillment of their courses did not necessarily present enthusiasm in personalizing or maintaining their blogs (Williams & Jacobs 2004). In addition, according to Instone (2005), Kuzu (2007), and Salen (2007), students saw blogging as a waste of time activity and they used it because it was required to pass the course.

At the end of the term, the researchers administered a questionnaire including of 16 statements about the usage of the blog and its contribution to students' learning. The questionnaire was adapted from Yoo and Huang (2011) and used a 5-point Likert scale in terms of 1 (strongly disagree), 2 (disagree), 3 (neutral), 4 (agree), and 5 (strongly agree). While the questionnaire items used themes such as collaborative learning, self-directed learning, online identity, writing skills and treatment to technology usage, the main aim was to investigate the benefits of using the blog in learning. It was expected that the students would write more critically and carefully since the blog was public and they would be evaluated by their friends and others as compared to writing in the classroom. Since the study is limited to the students taking the Linguistics course, it is a case study in a quantitative paradigm.

### III. ANALYSIS AND RESULTS

Several researchers compared formal learning in classrooms and informal learning through the use of blogs to determine the effectiveness of blogging. Heo et al. (2012) investigated the effects of blogging on informal learning. According to the authors, blogs have the potential for informal learning because of the flexibility that allow people to learn with encouragement from their instructors. The authors defined learning in three dimensions (see figure below) which also apply to learning with blogs. For example, through the use of blogs learners can make self-reflection and meaning-making through writing and reading one another's comments. In addition, there is social interaction that does not often happen in a traditional class.

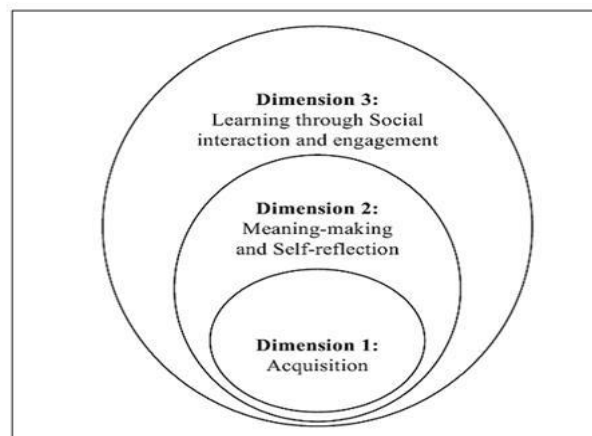

Figure taken from Heo et al. (2013, p.142)

Novakovic et al. (2013) conducted a study to determine the differences between traditional writing methods and using social media in terms of learning benefits. The authors found that feedback played a crucial role on developed engagement and time spent on tasks. In another

study, Park et al. (2011) analyzed the differences between informal learning with blogs and formal learning in school. As it can be seen from the table below, learning through blogs cannot be limited or restricted. While it may not be useful to give learners such freedom, learning in schools can be formed to have more independence or interdependence on other learners. The authors think that it is best to keep a concrete degree of freedom through projects while offering proper topics for homework and such. At least some parts of the lessons should be voluntarily based or there should be more choices for assessment. The idea of self-regulation and self-determination in learning should be the ultimate goal of education so that learners can make their own decisions and become autonomous in their learning, which can take the boredom out of learning.

Table 6. Difference of characteristics between informal learning through blogging and formal education at schools

Themes	Learning through blogging	Learning in school
Learner's role	Self-directed Self-meaning making Self-motivated Active Voluntary	Passive Non voluntary
Characteristics of learning contents	Practical and tacit knowledge Social and everyday life Situating Subjective Unlimited Multiple directions	Theoretical knowledge Structured and organized Curriculum-based Disciplinary Non-practical Fixed
Learning process	Self-regulated Open Flexible Process-oriented	Guided Structured and organized Fixed Outcome-oriented

Figure taken from Park et al (2011, p.158)

Researchers also paid attention to the role of anonymity in the usage of blogs and found that students present themselves better when they are anonymous. In a study conducted by Lu and Bol (2007), the effect of identifiable and anonymous comments given by 92 undergraduate students in general English writing classes in college are compared in an e-mode. Students were randomly classified into identifiable and anonymous groups and met for regular classes in separate way. The results showed that the students in the anonymity group was better than the identifiable group with respect to their writing and giving more critical peer feedback. In addition, anonymity in a writing course increased student participation (Miyazoe et al., 2011) as well as made it possible for students to make critical reflections with the guidance of teachers (Yang, 2009). However, instructors and students have to get more information about the fact that anonymity may lead to irresponsibility (Miyazoe & Anderson, 2011).

#### IV. DISCUSSION

This paper is intended to give basic information on the learning advantages of utilizing blogs in a Linguistics course. Although the study is conducted in the context of a special course with students only, the findings, nevertheless, let us to support different tentative insights of students' notions of the learning incomes of blogging. In examining the useful sides of blogging, the most of participants gave the main information and positive opinions about their own experiences as bloggers, and reported that using a blog made it easier for them to learn about the Linguistics



subjects, enhance their internet skills, finish their assignments quickly, and learn on their own. They also considered that blogging developed their motivation to learn about the Linguistics subjects. It is crucial to acknowledge that students of today are equipped with the essential skills to search for and exchange information on various platforms and already have motivation to do so. That is why, the result that students showed positive thoughts to utilizing the blog is expected. It can also be said that 'time' may have played a great importance on the good ideas and suggestions of the students to using the blog. Since the students in the present study are not very good, experienced English speakers, they cannot show themselves in the classroom discussions and share their opinions with their classmates in a very short time. However, blogging can give students the chance to take enough time to reflect on others' thoughts as much as they have to and also answer to them.

More significantly, 45 % of the participants agreed with the fact that they showed themselves better when blogging than they presented themselves in the classroom. As given in section 1, participants in the present study feel very anxious when they have to participate in the discussions that take place in the classroom. Most of the time they do not speak up for fear of being embarrassed due to their limited English language proficiency and their unfamiliarity with the Linguistic terms. For this reason, students agreed with the fact that blogging was an activity for them to express their thoughts and opinions freely without any fear or embarrassment. In addition, as mentioned in section 1, blogging is also perceived as an activity that can play an important role in improving writing. Through expressing themselves by the use of blogs, students can enhance their writing skills. The Linguistics course does not require students to do much writing in the classroom and therefore, blogging can be a useful device for students to give their view points and understandings in writing. In addition, the quality of students' entries gets better as they utilize blogs. According to Fernheimer and Nelson (2005) when students use blogs, they make their blogs their own and thus are more likely to write entries that are good opinion and idea.

The findings of this study shows that using blogs as part of a course assisted students learn the subject-matter more efficiently and played an important role in encouraging students to learn from one another as well as from other resources. In addition, the students acknowledged that blogging changed their learning process in a positive way. Therefore, it is important that instructors understand the potential effects of blogging and efficiently integrate it in their own courses. Glogoff (2005) suggests a number of ways in which blogging can be used in classrooms. Blogging, for instance, can be used in a knowledge-centered instructional environment where the instructor involves students in research activities and engages them in discussions to help them learn the necessary knowledge that the subject-matter requires. Learner-centered blogging is another efficient way which emphasizes the importance of giving positive feedback to students and making comments about their work. Moreover, blogging can be used as a receptive learning tool through which students can acquire, reflect and assess information. They can also be used as a directive learning tool by which students can have equal access to information, and other additional materials which can widen their knowledge about a certain subject.

Finally, blogs can be helpful devices to motivate guided discovery and knowledge construction. For example, after students do research about a given subject, they can connect with other students to form knowledge and prepare a common report together. Given the fact that there can

be different methods concerning the ways blogs can be used in the classrooms, students' learning styles should also be taken into consideration (Lin, et al., 2013). Given the fact that students of today are highly dependent on the Internet and getting sophisticated each day at searching for and exchanging information, educators should acknowledge the good sides of blogging in learning and inspiring students to utilize blogs in their classrooms to increase learning.

## V. CONCLUSION

To sum up, the findings of the study reveal that using a course blog can have a positive effect on the learning outcomes and suggest that instructors incorporate blogs into their classes to give opportunities for students to learn the subject matter. When the appropriate pedagogical approach is used, blogs can enhance the quality of learning. The results indicated that students' notion of blogging is consistent with those discussed in existing literature (Novakovich and Long, 2013; Avcı and Askar 2012; Park, MiHeo and Lee 2011; Yang, 2009; Huang, Jeng and Huang, 2009). The present study is not without its limitations. Future research can address a few areas.

First of all, this work contains learners. Additional studies should focus on various cultural groups of students and their learning experiences with blogs as cultural differences may go with various understandings and ideas about the usage of blogs. For instance, Yoo and Wen-hao (2011) compared the use and acceptance of Web 2.0 applications between American and Korean college students. The authors found that although Korean students indicated good relations and attitudes towards using blogs, they had high anxiety levels. American students, on the other hand, were more likely to participate in online social communities such as Facebook than using Web 2.0 applications, such as social virtual environment tools.

Second, a further study could also encourage students to continue their communication using blogs with the same group students and investigate their learning experiences; thus continuing the 'community of learners' (Park, Gyeong, & Romee, 2011). "Blogging is a significant factor in making informal learning more enriching and completing for adults. Adults learn more significantly if learning can be self-directed, practical, and reflection-oriented" (Park, Gyeong, & Romee, 2011, p.159).

## REFERENCES:

1. Armstrong, L., Berry, M., & Lamshed, R. (2004) Reflective learning and blogs. Paper presented at the Proceedings of International Conference on Computers in Education Asia-Pacific Society for Computers in Education (APSCE), Melbourne, Australia. Avcı, U., & Askar, P. (2012).
2. The Comparison of the Opinions of the University Students on the Usage of Blog and Wiki for Their Courses. *Educational Technology & Society*, 15(2), 194–205.
3. Blood, R. (2003). Blog definition and uses, retrieved December 16, 2006, from [http://www.osu.edu/webinterestgroup/12\\_16\\_2003.php](http://www.osu.edu/webinterestgroup/12_16_2003.php).
4. Boling, E., Castek, J., Zawilinski, L., Barton, K., & Nierlich, T. (2008).
5. Collaborative literacy: Blogs and Internet projects. *The Reading Teacher*, 61(6), 504-506. Didem Koban Koç, Serdar Engin Koç / *Journal of Language and Linguistic Studies*, 12(1) (2016) 9–19 17

6. Chan, K. K., & Ridway J. (2005). Blog: A tool for reflective practice in teacher education? Retrieved on March 29, 2010 from <http://www.dur.ac.uk/resources/smart.centre/Publications/BlogsFloridaeista2005.pdf>;
7. Downes, S. (2004). Educational blogging. *Educase*, September/October, 14-26.
8. Edbauer, J., Hogan, K., Hynes, C., & Rumbarger, L. (2005). Issues in Teaching Series – White Paper Series: No.050504-2. University of Texas at Austin, Computer Writing and Research Lab.
9. Fernheimer, J. W., & Nelson, T. J. (2005). Bridging the composition divide: blog pedagogy and Potential for agnostic classrooms. *Currents in Electronic Literacy*. Retrieved on March 29, 2010 from <http://www.cwrl.utexas.edu/currents/fall05/fernheimernelson.html>.
10. Fessakis, G., Tatsis, K., & Dimitracopoulou, A. (2008). Supporting “Learning by Design” Activities Using Group Blogs. *Educational Technology & Society*, 11 (4), 199–212.
11. Glass, R., & Spiegelman, M. (2008). Incorporating blogs into the syllabus: Making their space a learning space. *Journal of Educational Technology Systems*, 36(2), 145-155.
12. Glogoff, S. (2005). Instructional blogging: Promoting interactivity, student-centered learning, and peer input. *Journal of Online Education*. Retrieved on March 29, 2010 from <http://www.elearn.arizona.edu/stuartg/resume/article.pdf>.
13. Heo, G. M., & Lee, R. (2013). Blogs and Social Network Sites as Activity Systems: Exploring Adult Informal Learning Process through Activity Theory Framework. *Educational Technology & Society*, 16(4), 133-145.
14. Haramiak, A., Boulton, H., & Irwin, B. (2009). Trainee teachers' use of blogs as private reflections for professional development. *Learning, Media and Technology*, 34(3), 259-269.
15. Huang, Y.-M., Jeng, Y.-L., & Huang, T.-C. (2009). An Educational Mobile Blogging System for Supporting Collaborative Learning. *Educational Technology & Society*, 12 (2), 163–175.
16. Instone, L. (2005). Conversations beyond the classroom: Blogging in a professional development course. Retrieved on March 29, 2010 from [http://www.ascilite.org.au/conferences/brisbane05/blogs/proceedings/34\\_Instone.pdf](http://www.ascilite.org.au/conferences/brisbane05/blogs/proceedings/34_Instone.pdf).
17. Kajder, S. B., & Bull, G.. (2004). A space for "writing without writing." *Learning & Leading with Technology*, 31(6), 32-35.
18. Kuzu, A. (2007). Views of pre-service teachers on blog use for instruction and social interaction. *Turkish Online Journal of Distance Education*, 8(3). Retrieved on March 29, 2010 from [http://tojde.anadolu.edu.tr/tojde27/articles/article\\_2.htm](http://tojde.anadolu.edu.tr/tojde27/articles/article_2.htm). and
19. Lin, M. H., Groom, N., & Lin, C.-Y. (2013). Blog-Assisted Learning in the ESL Writing Classroom: A Phenomenological Analysis. *Educational Technology & Society*, 16(3), 130–139.
20. Lu, R., & Bol, L. (2007). A comparison of anonymous versus identifiable e-peer review on 18 Didem Koban Koç ,SerdarEnginKoç / *Journal of Language and Linguistic Studies*, 12(1) (2016) 9–19 college student writing performance and the extent of critical feedback. *Journal of Interactive Online Learning*, 6, Retrieved March 10, 2011, from, <http://www.ncolr.org/jiol/issues/PDF/6.2.2.pdf>.

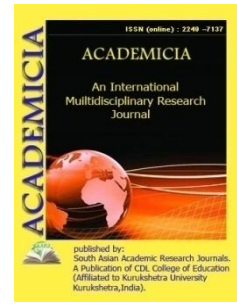
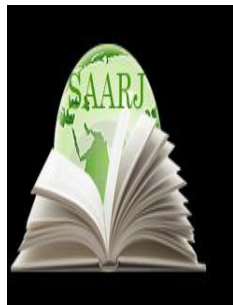

DOI: **10.5958/2249-7137.2021.01054.5**

## LEGAL EDUCATION IN THE PROCESS OF BUILDING A CIVIL SOCIETY

Djurayev Anvar Mukhammadiyevich\*; Makhmudov B.Kh\*\*

\*PhD, Associate Professor,  
Tashkent Pediatric Medical Institute  
Tashkent, UZBEKISTAN

\*\*PhD, Associate Professor,  
Tashkent State Polytechnic University  
Tashkent, UZBEKISTAN

### ABSTRACT

*One of the pressing issues of modern social and political life and social and humanitarian sciences are the problems of building a civil society. Today, in the Republic of Uzbekistan, interest in this problem and issues of political education has significantly increased. Uzbekistan pays special attention to political education issues, based on the ultimate goal of creative development - building a civil society.*

**KEYWORDS:** *Legal Education, Civil Society, Rule Of Law, Legal Consciousness, Law, Democracy, Legal Entity.*

### INTRODUCTION

As you know, most of the emerging states are set by the strategic goal of building a civil society. Since the rule of law as a legal form of organization and functioning of public political power is an institution of civil society, this goal is not feasible without an appropriate legal culture and legal education.

### MATERIAL AND METHODS

In connection with the research, the article used methods such as historical and methods of comparative analysis.

## Results

What should be understood by legal education? This issue, it seems, requires a special and multi-stage study, since the approach to the management of the educational process depends on its solution.

Preliminary legal upbringing can be defined as the state in which a person is at every given moment, and therefore at the time of making a decision about how to act in certain circumstances. This, of course, is the state of his legal consciousness, and the level of legal culture, and, consequently, his readiness for lawful or illegal behavior. "A person's life is determined by objective economic and social factors, but one should not forget about subjective circumstances, about socio-psychological factors, because both positive and unfavorable social conditions do not fatally affect a person. Their impact goes through their minds. Previous social experience and behavioral skills affect his subsequent actions and are manifested in other life conditions. Purely personal traits are also of great importance" [1.63]

In the sociological aspect, a person is a set of social relations. These relations, although they are stable in type, but at the same time are absolutely changeable, they are in a constant process, like the individual himself. Therefore, the subject of law is the totality of all relations that influenced his consciousness, character, habits, aspiration, and will. And what is he and his actions: legitimate or illegal (under certain conditions). At the same time, the actions of the subject of law form him - such is the dialectic.

The question may arise whether the state of legal education does not coincide with the legal attitude of the individual, if the attitude is an integral state of the subject preceding the manifestation of his activity; attitude is the synthesizing principle of many personality traits, including relationships. It seems that the legal attitude is a kind of result of legal education, concentrated in the form of a specific program of behavior in certain conditions, a program formed from all the legal (and illegal) knowledge, assessments, opinions, attitudes, habits, habits, aspirations, attitudes towards which - or something that passes into interests and aspirations. Interests can merge or compete, which inevitably affects the state of readiness for lawful or illegal behavior.

In our opinion, the level of legal education is not only knowledge and understanding of the need to comply with legal regulations. It is determined by the degree of formation of the attitude towards the law as a value that is beyond competition in a democratic society.

One of the sources of internal struggle is the interpretation, mastering by the subject of external circumstances that are significant for him, and sometimes are of a certain value. What value the subject of law prefers, what interest will be the "winner", whether the legal mechanism for suppressing the unlawful motivation will work - all this will be a manifestation of the legal education of the subject. In this regard, we can say that legal education is the soil from which the grain of the attitude grows into an act. That is, we can say with conviction that legal education is directly related to the spiritual world and social environment.

Thus, legal education can be defined as the state of any subject of law, which is constantly changing, so it cannot be characterized exactly the same way twice, "just as you cannot enter the same river twice." Undesirable stages in the development of a subject can be a low level of legal education and even legal bad manners, which also has a different degree. The problem of legal

education is complex and multifaceted. For this reason, legal science pays a lot of attention to finding ways and preventing and overcoming such conditions of subjects of law.

An irrefutable fact is that the surrounding social environment directly affects the formation of a person. Oftentimes, many relationships develop unexpectedly and can be unfavorable.

Legal education, deliberately organized by society, is obliged to prevent the harm that in some cases is caused by accident or deliberately. In the social system of upbringing, disregard for humanistic principles and violation of the relevant requirements of the law under the guidance of an educator, entails the acquisition of the skills of selfishness and delinquency. Human energy through regulation can be directed both to creation and to violation of the law.

The subject of law, who has a sense of justice, measures his own dissatisfaction with his dignity and self-sacrifice. At the same time, he finds an acceptable way for others to achieve the desired - often high - result or get something that is of value to him. Desires and aspirations to take possession of the value by means of aggression, slander and injustice certainly pose a danger to society.

In the context of social transformations, a necessary requirement is to change not only the rational attitude, but also the mood, building feelings. Accordingly, in the process of legal education, it is advisable to focus efforts not only and not so much on increasing the legal awareness of the subjects of law, but on trying to penetrate into the inner world of a person, to try to understand the merits and mistakes introduced by education and manifested in illegal behavior. Of course, this will allow us to analyze the flaws that are allowed in social practice and scientifically approach these solutions.

In our opinion, legal education cannot be perceived in a narrow understanding, limited to legal education. It is necessary to understand that legal education is a multifaceted phenomenon, taking into account the influence on the subject of law of the entire complex of social conditions, the entire objective basis of legal education. Only by recognizing and realizing the importance of the influence of objectively existing factors, can one consider effective and purposeful activity on legal education.

The delimitation of the educational process - be it political, moral, aesthetic, labor, etc. - has a conditional meaning. All areas of the educational process are interconnected. Not taking into account this universal interconnection means leaving uncontrollable elements, sometimes dark ones, of behavior, relationships, actions interwoven into the social environment surrounding each subject. The inner world of a person is to a certain extent a reflection of the surrounding spiritual atmosphere, which also needs purity and care. Accordingly, this social environment should have a certain level of spiritual culture.

The upbringing of the inner spiritual sphere is carried out to a greater extent by means of influence from the outside: providing a favorable atmosphere with the help of a different level of communication, purposeful adjustment in finding ways to overcome internal obstacles, to cause the desired and necessary self-movement - self-restructuring of the personality, without which the legal educational efforts from the outside will perish, without reaching the goal.

## DISCUSSION

An important point in the legal educational process is taking into account the needs, which is characteristic of both the subject and the human society as a whole.

The questions of needs are studied by many sciences. The theory of legal education is interested in the problem of needs from the point of view of sociology and psychology, since among the carriers of needs, legal educational activity selects only subjects of law, from social groups to an individual. Based on the need for humanization and practical goals, it is important to note that the needs of social actors must be taken into account and cannot be ignored, since legal education is designed to provide behavior consistent with the needs, interests and values of a humane society, which must be embodied in the legal system. At the same time, in order to ensure an expedient legal regulation that creates the true prerequisites for orderly social relations, it is necessary to take into account many phenomena associated with the life of society.

It should be noted that the very attitude of a person to legal institutions can be moral or nihilistic. "Law is weak without morals" so they said in ancient Rome. In our opinion, for re-education it is necessary to develop the ability to penetrate into the inner world of a person, to influence his feelings, moods, and his spiritual world as a whole. This will enable the development of the legal sense, deliberately organizing a cumulative process, which will help to strengthen the legal sense. Legal education requires special attention to the development of legal feelings, and this is possible only on the basis of and in conjunction with other high social feelings.

## CONCLUSION

So, in order to get a real result, it takes a lot. It must be recognized that legal education is a comprehensive, long-term social process. And of course, all citizens participate in this process in various capacities, both as educators and as educated. The state of legal education should be planned as a strategy, revitalization, attraction of the positive from all spheres of social reality.

## Acknowledgement

We would especially like to express my gratitude to my friend, Candidate of Philosophical Sciences, Associate Professor Djurayev Avaz Akhmedjanovich for valuable advice in planning the research and recommendations for the design of the article. I would also like to express my gratitude to the translator Djurayeva Nigora Avazovna, who assisted in preparing the manuscript before sending it to the editorial office. The authors are grateful to their families and colleagues for friendly support and to all those who made their work easier and helped them to achieve success!

## REFERENCES

1. Dubinin N.P., Karpets I.I., Kudryavtsev V.N. Genetics, behavior, responsibility. M., 1982
2. Markova G.D. Scientific foundations and organization of legal education of youth. Kiev, 1979.
3. Khalilov E.Kh., Legal awareness in the structure of public life. Tashkent: "Uzbekistan": 1997.
4. Djurayev A.A., Zakirov Sh.M. Civil society: basic principles and conditions of functioning.// European science, 2019, 6 (48).

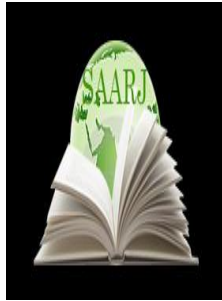

**ACADEMICIA**  
**An International  
 Multidisciplinary  
 Research Journal**  
 (Double Blind Refereed & Peer Reviewed Journal)



**DOI: 10.5958/2249-7137.2021.01035.1**

## SOCIAL CONTRADICTIONS AND THEIR FORMS OF MANIFESTATIONS

**Hasanov Sharofiddin Shamshurovich\***

\*Lecturer,

Department of Theory and Practice of Human Rights of the Ministry of Internal Affairs,  
 UZBEKISTAN

### ABSTRACT

*The article examines the causes and factors of the emergence of contradictions, the wide spread of contradictions in society, contradiction-conflict-collision, views on the main and minor conflicts. Moreover, if there are no conflicts in the family, at work or in the state, it means that this is where the growth and development of a peaceful life stops. Therefore, it is necessary to study these contradictions and try to eliminate them when they occur, and to try not to have a negative impact on the development of our lives.*

**KEYWORDS:** *Opposites, Spiritual Opposites, Social Contradictions, Struggle, Relations, Internal And External Contradictionsp*

### INTRODUCTION

It is clear that any social conflict in the world will affect the fate of millions of people. This shows that social conflict plays an important role in the life of the individual, society and humanity in general. The present period shows the need to look at the problem of social conflict from the point of view of social philosophy. The practice of resolving non-violent social conflicts, which is one of the important factors of social life, is gaining urgency today.

The socio-historical changes taking place in the world are radically different from all stages of historical development in the past, as they are very intense, complex and contradictory in nature. Research by the World Bank and the United Nations has shown that timely prevention of social conflict can save lives and save an average of \$ 70 billion a year in social protection. Research institutes (USA, Canada, France, England, Japan, Russia) dealing with the analysis of social conflicts and their solutions are focusing on the scientific study of the causes of violence and social conflicts, as well as their prevention based on a scientific analysis of the issues of social equality, gender equality, equality of political relations.



Therefore, the problem of creating a scientifically sound concept of studying and resolving social conflicts remains. The aim of the research is to study the history of the origin of social conflicts and to find ways to solve them.

The word "ziddiyat" (contradiction) is originally Arabic and means contradiction, intellectual contradiction, contradiction, "irreconcilable contradiction, hostility, enmity," in discussion, in the text, in theory and in the subject in general, "the existence of two contradictory considerations in events and the relationship between them".<sup>1</sup> It is possible to live without using the word contradiction, but it is impossible to live without entering into conflict. Perhaps it is not surprising that the word is used in order to generalize all of the words disagreement, conflict, struggle. There can be no one among us who has not been in conflict at least once. That's why the phrase "check your pulse if there's no conflict in your life" is used. The bottom line is that conflict is as simple as an event in our lives. Moreover, if there are no conflicts in the family, at work or in the state, it means that this is where the growth and development of a peaceful life stops. Therefore, it is necessary to study these contradictions and try to eliminate them when they occur, and to try not to have a negative impact on the development of our lives. Determining the nature of the conflict is a matter of scientific research. Because conflict is complex in its forms and levels. For example, a conflict between specific individuals. In defining the concept of conflict, we are forced to consider its content in the context of interpersonal relationships. But in this way it does not reflect the whole essence of the concept of 'contradiction' that we are exploring. Because conflict is complex in its forms and levels. For example, a conflict between specific individuals. In defining the concept of conflict, we are forced to consider its content in the context of interpersonal relationships. But in this way it does not reflect the whole essence of the concept of 'contradiction' that we are exploring.

Analysis of conflicts in the fields of psychology, sociology, law, art, history, mathematics, pedagogy, political science, sociology, philosophy, military and other disciplines shows that on the basis of any contradiction, the conflict plays a decisive role.

It is also impossible to ignore the general theory of conflict that underlies contradiction when studying the problems of social conflict. Conflicts are due to differences in the needs, interests, and values of subjects in different mental states; among people of the same or different mental states; social spheres (industry, economy), social organizations (family, school, transport), social organizations (state, political parties, trade unions), nations, countries, etc.

The object of social contradictions is social contradictions and social conflicts of various forms in all spheres of society. Its subject is the study of the nature, causes, mechanisms of social conflicts in society and the development of technologies to prevent, detect, monitor and resolve them.

If we look at the science of modern conflict studies, there is no single definition for the concepts of 'conflict' and 'social conflict'. This is explained by the lack of consensus among scholars on the nature of the issue. We can also see cases in the literature where the terms 'conflict' and 'social conflict' are often used as synonyms. Below we review the most common definitions in this regard:

"Conflict is any connection of elements represented by objective (hidden) and subjective (explicit) contradictions;<sup>2</sup> "Conflicts are a form of interaction between people in society, a specific cell of social existence, a potential or active subject of social action. Their motivation is

related to conflicting values, interests and needs ”;<sup>3</sup> "Conflict is a sharp emotion, an experience-related conflict that is difficult to resolve." In these definitions, conflict is expressed as a concept that represents contradiction. "Conflict is a drastic way of resolving conflicts that arise in the course of a relationship, and usually includes the negative feelings of the parties to the conflict";<sup>4</sup>

"Social conflict is a struggle between contenders for status, power, or limited resources, in which the conflicting parties seek not only to achieve the intended goal, but also to neutralize, harm, or destroy the opponent";<sup>5</sup> "Social conflict is an extreme situation, which is manifested in the conflict between different social groups, social institutions due to the contradiction or significant difference in social interests, goals, development trends";<sup>6</sup> "A social conflict is a confrontation in which the parties seek to seize territory or resources, in which opposition members or groups, their property or culture are threatened, and the struggle takes the form of an attack or defense."<sup>7</sup> Thus, conflict is often seen as an active and reciprocal action, enriched with strong emotional experiences to achieve their goals. But a social conflict is an open conflict between the incompatible needs, interests, and values of two or more subjects and other participants in social life.

The process of realizing the need to take certain steps towards resolving conflicts is a complex phenomenon, and often the problematic situation that is perceived as subjective, i.e., one-sided, unbiased. The reason for the subjective perception of reality is related not only to the nature of the psyche, but also to the social differences between the participants. These differences are reflected in social values, goals, ideas, and interests. The reason for the individuality in the perception of reality is also due to differences in the level of knowledge, needs and other characteristics of the participants in the process. The more complex the situation, the faster it develops, the more likely it is that spontaneous opponents will misinterpret the reality, unnaturally. The assessment of the pre-conflict process as a threat to the interests of the parties is reflected in their "conflict behavior". Behavior of the opponent, excessive fear of his actions will bring the situation to the level of conflict. It is this situation that confuses the situation and leads to the onset of conflict behavior.

The manifestation of the contradiction is the readiness of both sides to start an active struggle against each other, recognizing the conflict situation. The incident, the escalation of the conflict, the balanced confrontation, the end of the conflict - all these are processes specific to the conflict.

Balanced confrontation is a characteristic of the contradiction in which the parties continue to fight each other, but now the enthusiasm and intensity of this struggle is not so noticeable. The parties realize that the continuation of the conflict by force will not yield results, but the struggle will continue because no agreement on reconciliation has been reached yet. If the negative emotions in the period of conflict are not completely eliminated, the process of partial normalization of the relationship takes place. Painful experiences, rethinking one's point of view are characteristic of this period. Attitudes towards the opponent, claims and requirements against him, the process of correction in self-assessment - are among the above features. Feelings of guilt for one's own actions in times of conflict increase. But the old memories that have been preserved in relation to each other's evaluation do not allow the relationship to be normalized immediately. As soon as the parties realize the need to establish a healthy, constructive relationship, the full normalization of relations will begin. The establishment of mutual trust in the middle also provides an opportunity for this. It should also be borne in mind that there are

certain differences in the dynamics of conflict in normal everyday conditions and in extreme situations. In extreme conditions, conflict develops rapidly. For example, 70% of conflict processes in extreme conditions are completed within a week, and 55% within the first three days.

The scientist R. Darendorf, who deals with the issue of contradiction, has mentioned one of the broadest classifications of contradiction.<sup>7</sup>

If we look at the classifications proposed by A.V. Dmitrov<sup>8</sup> on the manifestation of conflict, he cited the areas of conflict by economic, political, labor, social security, education, and so on. It can be seen that the types of conflicts with respect to a particular subject can be internal (personal conflicts) and external (interpersonal<sup>9</sup>, between individual and group, intergroup).<sup>10</sup>

In the field of psychology, one can see the types of contradictions such as orientation, cognition, role-playing. K. Levin introduces internal contradictions in many ways into the directional contradictions (lack of satisfaction with their work, many do not believe in themselves, experience stress, spend too much time at work).<sup>11</sup> L.Berkovits, M.Doych, D.Maers consider the reference contradictions to belong to the group.<sup>12</sup> Cognitive contradictions are described in the literature in terms of both internal and intergroup conflicts.

Based on his observations, F. Lutens also identifies three types of internal contradictions, such as the contradiction in the division of tasks, the contradiction caused by despair, and the contradiction caused by the inconsistency of goals, and their occurrence.<sup>13</sup>

When English sociologist E. Giddens says “contradiction,” I mean a clear struggle, regardless of the source, means, and methods of struggle used by the parties. Unlike contradiction, the concept of contradiction is specific to a particular structure. These two concepts are close to each other, because the contradiction represents a weak link in the social system,”he said.<sup>14</sup>

Internal conflicts arise because of the opposite sides of the same event, while external conflicts arise because of the opposite sides of different event-processes. Internal conflicts are decisive in the course of events, while external conflicts are random. Usually, external conflicts arise as a result of internal conflicts and lead to the development or destruction of a living organism, country, culture, and so on.

Major or significant contradictions determine the status and development of an event, and the longer the event lasts, the longer it will last. Insignificant or non-essential contradictions represent the state and development of some insignificant aspects of a particular event and are present at a certain period of the event’s existence. For example, assimilation and dissimilation in the animal kingdom, and the class struggle in an antagonistic society that are among the main contradictions. Examples of insignificant conflicts include proteins and carbohydrates in the digestive system of a living organism, conflicts between non-basic classes of society, such as urban and rural populations.

non-antagonistic conflicts are conflicts between social units, social institutions, and social organizations in which the interests of the subjects coincide. Conflicts between parents and children, teachers and students are also considered antagonistic.

On the sides of social contradictions we see the following social subjects. Social units, social institutions, social organizations, nation, society, civilization.

Any social entity on one side of a particular conflict has its own interests and ways of working. Owners of conflicting interests sometimes show kindness to each other, sometimes reject each other. Mutual conciliation proves that a society cannot exist without the unity of social subjects with conflicting interests. That is, if a society consists only of the rich, the unconditional obeyers of the law, the educated, the kind, and the like, only the “good,” or only the poor, the bully, the marginal, the ruthless, and all sorts of other “bad,” such a society cannot survive. Thus every event, process in nature, society, and consciousness involves many contradictions.

The spread of conflicts in society is manifested in the process of ideological, economic, political struggles, the intensification of hostilities. Its character depends on the type and subjects of the contradictions. Class struggle, wars, is the highest form of social conflict in which the parties commit various forms of social violence against each other.

Social contradictions serve as a source of social processes. For example, according to E. Giddens, the transformation of contradictions into conflicts is necessary in order to understand the conflict of interests and the motivation of the subjects to act accordingly. In his view, the conflict will not start until the parties realize their conflicting interests.<sup>15</sup> From this point of view, social contradictions can be considered as the basis, the precondition of conflicts.

Depending on the nature of the conflicts, there are the following types. Objective related to real problems and shortcomings, subjective due to different assessments of certain events and actions, types of conflicts according to their consequences, constructive, proposing rational change, destructive, destructive to the organization, and so on. The following are necessary for effective conflict management. Identify the type of conflict, its causes, its characteristics and select and resolve the appropriate solution to the conflict. There are many ways to resolve internal conflicts. Compromise, retreat, sublimation, idealization, squeezing, redirection, correction, and so on. But the whole complexity is that it is very difficult for a person to identify, properly evaluate, and manage these internal conflicts. They are very well described in the scientific literature, and in practice they are very difficult to solve independently.

Interpersonal conflicts cover almost all aspects of human relationships. In managing interpersonal conflicts, we consider two aspects of it - internal and external. The inner aspect has to do with certain qualities of the individual and the ability to rationally behave in conflict.

The external aspect reflects the manager’s managerial performance in relation to a particular conflict. The two-dimensional method of personality behavior developed by K. Thomas and R. Killman is widely used in the development of the module of social conflict. At the heart of this model is the question of whether the parties to the conflict should focus on their own interests and those of the opposing parties. Conflict participants analyze their own and their opponent’s interests and choose five behavioral strategies (struggle, retreat, privilege, compromise, cooperation). The conflict between “individual and group” is resolved in two ways. A person entering into a conflict admits his or her mistakes and corrects them, while a person who is a participant in the conflict who cannot bring his or her interests into line with the interests of the group leaves the group. It is best to follow the tips below to build and maintain a positive relationship without getting into conflict. Get off the hook, analyze the situation, explain the cause of the problem to the other person, give the opportunity to “get out” of the conflict. With a full understanding of these criteria, it will be possible to assess social conflict and determine its resolution.

**REFERENCES:**

1. Annotated dictionary of the Uzbek language: more than 80,000 words and phrases. The letter «Z» / A. Edited by Madvaliev. - T.: State Scientific Publishing House "National Encyclopedia of Uzbekistan", P.146–147. - URL: [https://n.ziyouz.com/books/uzbek\\_tilining\\_izohli\\_lugati/O'zbek%20tilining%20izohli%20lug'ati%20-%20Z.pdf](https://n.ziyouz.com/books/uzbek_tilining_izohli_lugati/O'zbek%20tilining%20izohli%20lug'ati%20-%20Z.pdf)
2. Dahrendorf R. Elements of the theory of social conflict (Russian) // Sociological research. - 1994. - No. 5. - P.142-147.
3. A.G. Zdravomyslov Sociology of conflict. - Moscow: Aspect Press, 1996. - P.261.
4. Mikadze Yu.V. and other Psychological Dictionary / Ed. VV Davydov, AV Zaporozhets, BF Lomova and others - Pedagogy Research Institute of General and Pedagogical Psychology Acad. ped. Sciences of the USSR. - Moscow, 1983. -- P.448.
5. Antsupov A.Ya., Shipilov A.I. A74. Conflictology: Textbook for universities. - Moscow.: UNITI, 2000. -- p. 551.
6. L.A. Koser Functions of social conflict / Per. from English O. Nazarova; Under total. ed. L. G. Ionina. - Moscow: House of intellectual books: Idea-press, 2000. - P.295.
7. Sociological Dictionary / Comp. A. N. Elsukov, K. V. Shulga. - 2nd ed., Rev. and add. - Minsk: Universitetskoe, 1991. - P.528.
8. Dmitriev A.V. Conflictology. Tutorial. - Moscow.: Gardariki, 2000. -- p. 320
9. Dahrendorf R. "Modern social conflict. Essay on the Politics of Freedom" / Per. with him. L.Yu. Pantina. - Moscow.: Rosspen, 2002. -- p. 123.
10. Vorozheikin I.E., Kibanov A.Ya., Zakharov D.K. Conflictology: Textbook for universities. - Moscow.: INFRA-M, 2012. -- p. 98.
11. Levin K. Types of conflicts // Psychology of personality: texts ed. Yu.B. Gippenreiter, A.A. Bubbles. - Moscow: Moscow University Publishing House, 1982. - P.93-96.
12. Volkov B.S. Conflictology: Textbook. manual for university students / B.S. Volkov, N.V. R.I. Mokshantsev. - Rostov on Don: Phoenix, 2008. -- p. 314.
13. Lutens F. Organizational behavior. - Moscow.: Infra, 1999. - p. 102.
14. Guldens A. The constitution of society. – Cambridge: Polity Press, 1989. – P.198-199.
15. Spirkin A.G. Fundamentals of philosophy / A.G.Spirkin. - Moscow.: Politizdat, 1988. - P.592.

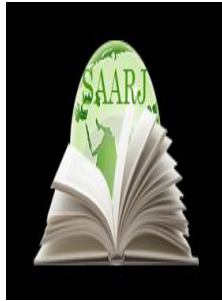

**ACADEMICIA**  
**An International**  
**Multidisciplinary**  
**Research Journal**  
 (Double Blind Refereed & Peer Reviewed Journal)



**DOI: 10.5958/2249-7137.2021.01036.3**

**TEACHING STUDENTS TO THINK INDEPENDENTLY AND  
 CREATIVELY THROUGH THE ORGANIZATION OF TRAINING'S AS A  
 TOPICAL ISSUE**

**Atkham Nisolmuhamedovich Ziyayev\***

\*Senior Lecturer,  
 Department of Interfaculty Pedagogy and Psychology,  
 Kokand state pedagogical institute, Kokand,  
 UZBEKISTAN  
 Email id: adxamjon2021@gmail.com

**ABSTRACT**

*This article describes the problem of increasing the self – activity of the assimilation of knowledge independent thinking by organizing self – education in higher educational institutions.*

**KEYWORDS:** *Education, Development Activities, Practical Lessons, Self – Education, Thinking, Free Thinking, Activities, Self – Study, To Exchange Opinions, Training, Tree Thinking, Discussing, Education Activates, Self – Thinking.*

**INTRODUCTION**

Organization of independent work of students on the basis of the Regulation approved by the order of the Ministry of Higher and Secondary Special Education of the Republic of Uzbekistan dated August 14, 2009 No 286 "On the organization of independent work of students" is one of the problems.

To this end, the main task of teachers is to provide students with independent education and independent work, in turn, to be able to apply the knowledge and skills acquired in the classroom, to strengthen their skills, to master them consciously. divided into groups according to the specific characteristics of the bird, and the outcome of teaching them independently should be taken into account separately. [1]

Identifying problem signs in independent learning allows you to separate important information from secondary information and look for factors and additions.

Subjective of the educational process to strengthen the knowledge of students studying in secondary schools, self-education, independent work, development of knowledge, the formation of understanding, skills, abilities is to organize regular independent education in accordance with the purpose [2].

Independent education - when successfully completed, students' independence is nurtured.

Usually, independent learning is brought to the attention of students in the form of a problem that can be solved immediately. In the process of offering students independent learning in the form of problems, in the process of finding or expressing conditions in specific problem situations, the activities organized by the subjects seem to be performed by the teacher instead of the students.

In independent study, the conditions are not known in advance. If in the process of independent educational work provided by the teacher, the student can not find a solution, then in the face of a specific situation, he can not turn this independent work into a situation that allows him to seek a solution.

Independent learning requires strict adherence to certain didactic tasks.

When the conditions of independent study are set in advance by the developer, the student is not required to demonstrate the ability to change.

In independent learning, you have to complete tasks that do not have more conditions. On the basis of independent learning, the subject becomes acquainted with the laws of changing conditions, uses existing skills and abilities to analyze a specific problem and perform independent work [3].

Forming concepts using independent learning allows subjects to independently identify problem signs, separate important information from secondary information, and search for additions.

Independent learning, which allows for independent work, involves the creation of favorable conditions for students with low levels and dissatisfaction with the development of concepts, motives and values.

Independent education is the organization of regular independent activity in accordance with the subjective purpose of the educational process on the formation of self-education, independent learning, the development of imagination and the formation of cognitive skills.

One of the first principles of the independent learning factor is the intellectual mastery of scientific ways and advanced pedagogical practices. Scientific knowledge is a true reflection of reality.

Only knowledge that reflects the laws of the world around us, the intrinsic properties of objects and events, and their interrelationships is scientific.

The scientific principle of independent education is necessary in order to create the right conditions for the teacher to reflect, understand, master the laws of the teaching material.

Understanding of theoretical rules is an important feature of interpreting material on a scientific basis, which determines the characteristics of the student's thinking activity. Scientific knowledge can reflect the realities inherent in science to varying degrees. Scientific interpretation one of the tasks of the rules of science in each group at all stages of independent

learning is to know the structure of theoretical data, in terms of how deeply it reflects the world around them. [4]

In the process of acquiring scientific knowledge, students acquire a scientific outlook and beliefs. Thinking develops.

The principle of the scientific nature of independent education is aimed at equipping students with future scientific knowledge in accordance with the current level of education in order to acquaint young people with the methods of scientific research.

Therefore, in the education system, the role of the teacher is great in the free, creative, independent thinking of students in the educational process and independent work. It is expedient to use independent work in the structure of education and two principles in its organization - the principle of systematic and consistent work of independent work.

The historical experience of the institute in each period of social development shows that the task of education cannot be accomplished without a certain system.

The system of explaining the learning material depends on the ideas that are clearly stated in the learning material, which of these ideas the teacher wants to explain, how old the students are to allow them to acquire knowledge, whether the student knows well or not and the nature of students' thinking activities at this level depends on how the process of learning in the classroom is usually explained.

Independent work is about being systematic, consistent. A characteristic feature of consistency is that it is aimed at deepening, expanding and strengthening new knowledge, skills and abilities on the basis of previously acquired knowledge and skills of students [5].

Independent work is also important in showing that each academic discipline is inextricably linked to each other through the principle of structure and consistency.

The principle of independence of independent education is to strengthen the stated teaching materials and serve to supplement the previously taught materials, to ensure that students work independently and continuously and systematically, to ensure that the knowledge and skills acquired by students. The acquired skills also include taking into account their skills.

The three principles of organizing independent work are to link it with the practical activities of independent work.

The most basic and guiding rule is to link independent work with life and production practices. As students' independent, creative activities are served and linked to life, it helps them not only to master the content, but also to apply their knowledge in practice.

In the organization of independent work, it is effective if the tasks between the members of the group are clearly approved, and cooperation is established. The following elements should be taken into account in the organization of independent work of students.

1. Preparing students to work in groups, clearly adding learning tasks, giving an idea of group work, setting rules.
2. Develop and discuss a plan for completing the assignments. Identify solutions and share responsibilities.



3. Be able to organize work on the completion of educational tasks.
4. Monitor the work process and the workplaces of the members in the organization of group work and provide assistance if necessary.
5. Provide information on the results of the tasks in groups, group discussions, additions and corrections to the work process. The teacher draws conclusions and summarizes the results of the work.
6. Establish peer review and monitoring of group assignments.
7. Analytical assessment of the results of each group's work, group work.

The success of group work depends on the teacher's ability to organize learning activities.

That is, the ability of the teacher to organize the individual activities of each student in the group, the ability of each student to receive the support of the teacher, the success of the work depends on the ability to show the end result. There are a number of shortcomings in the organization of group work. One of the challenges is to be able to form groups with the right goals and organize work in them.

When working in groups, students find it difficult to solve some difficult tasks independently. Therefore, in the organization of work in groups, it is necessary to organize individual work at the same time as the organization of general work. In these cases, good results can often be achieved. In general, depending on the level of difficulty of the assignments in the subjects, a creative environment is created in the group. When working in groups, the work of groups gives the expected results, if there is an atmosphere of mutual cooperation and mutual assistance between the student and the student. Independent work is given to develop work skills in interactive methods. In independent work, students think creatively, develop skills and competencies to use in their learning activities. The work gives the expected results. Independent work is given to develop work skills in interactive methods. In independent work, students think creatively, develop skills and competencies to use in their learning activities.

In the organization of the educational process, the teacher must first pay attention to the content of education, scientific, modern, compliance with the SES (state education standard).

Training is one of the main forms of additional education, the peculiarity of which is that students learn to use time efficiently, independently, to work, to make decisions.

There are so many types it's hard to say. For example, group discussions, game-based methods, situation modulation, human sensory development techniques, mediation techniques, and more.

Group - discussion - this method requires theoretical and practical, creative participants in the joint discussion of problematic issues. Such methods are designed to look at the solution of the problem from different angles, each participant has a different opinion on the solution of the problem, and on this basis a solution is reached. The facilitator leads the discussion by asking a variety of questions and leading them to a solution. If team members ask a question, they can find a solution on their own without a leader.

The training can begin with a discussion of the rules of organization, and end with a discussion of questions such as what is a group, the formation of a group, and the criteria by which it is

formed. Effective training leads to the acquisition of new skills, the development of creative, independent activities.

The trainings have their own peculiarities of organizing independent work in groups.

- In this form, students are divided into groups, and each group is given specific, individual tasks.
- Each group works on separate (ie the same or differentiated) tasks.
- The task is based on interaction or is organized under the guidance of a leader.
- In groups, the task is carried out in such a way that at the end of the session, the contribution of each participant or group member is taken into account.

The composition of the group may not be permanent, they create an environment in which a member of the group can contribute to the maximum.

Groups can be formed in different sizes. Usually groups consist of 4-6 members.

It may change depending on the content and nature of the assignment.

The group should be formed in such a way that the presence of students in each group with the skills of independent work gives the expected results.

Some students felt the need for individual help in organizing group work. In such cases, it is advisable for the teacher to help students who are not well prepared.

Group learning - educational activities, laboratory work, practical training, practice in the natural sciences, speech practice in the natural sciences, speech development (dialogue), mastering texts, studying historical materials and pedagogy very helpful in their lessons. In these cases, group communication and independent work give good results.

Practical classes are organized on the basis of scientificity, conformity to the nature of the student, consistency, structure, comprehensibility, robustness, comprehension and activity, the relevance of the exhibition to practice, the ability to apply in practice and develop independent thinking and achieve the following .

- When using active methods, he uses all his strength and skills to organize practical training, tries to explain well with the help of visual aids, didactic handouts. The teacher discusses the topic with the students. Solves exercises by giving creative work. Performs development through independent work, repetition. They will be able to master the content of education. The organization of practical classes on the basis of new technologies creates a favorable environment for students to master the learning process, allows students to exchange ideas. Conditions will be created for mutual receipt and transmission of information. They discuss and resolve issues that need to be resolved. They find a solution together to get out of the situation. They demonstrate their knowledge to each other based on the information they receive. Inspired by each other, they are satisfied and do not know that time has passed. Each participant feels the content of education as an author. Achieve full mastery of the content of education.

The practical training is focused on everyone by the teacher, that is, there is a bit of abstraction.

Curiosity motivates everyone, regardless of their abilities, to search, think and work towards the same goal.

Due to the fact that students have the same level of development and preparation, the acquisition of knowledge and skills does not guarantee the same results.

Therefore, in practice, questions and answers, laboratory work, exercises should be as focused on the student as possible.

In conclusion, it should be noted that practical training should be organized on the basis of interaction, interaction, debate, debate, thinking, joint solution of an activity or problem.

#### **REFERENCES**

1. Law of the Republic of Uzbekistan "On Education" of September 20, 2020.
2. Tolipov O.K, Usmonkhodjaeva M. "Application bases of pedagogical technologies" T-"FAN" 2006.
3. J.G. Yuldashev, F. Yuldasheva, G. Yuldasheva "Interactive education - quality assurance" Tashkent-2008.
4. Journal of Primary Education "Using interactive methods in education" 2012. № 2.
5. Independent education is a factor in increasing the effectiveness of education. Journal of Public Education

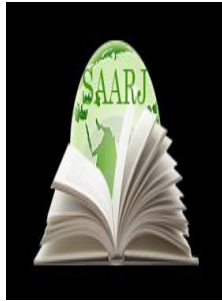

DOI: **10.5958/2249-7137.2021.01037.5**

## ORGANIZATION OF THE REPORTING OF THE CRIME PREVENTION INSPECTOR TO THE POPULATION AS A CONTROL SYSTEM

**Kolmakov Ivan Konstantinovich\***

\*Cadet of the Academy of the Ministry of Internal Affairs,  
Republic of UZBEKISTAN  
Email id: Kolmakov@inbox.uz

### ABSTRACT

*Based on the study of the norms of national legislation, the activities of prevention inspectors for the prevention of offenses, as well as their interaction with the self-government bodies of citizens in the field of crime prevention, are considered. Discussions are being held on the prospects for the development of crime prevention activities in the mahallas, as well as on the importance of organizing the reporting of crime prevention inspectors to the population.*

**KEYWORDS:** *Prevention Of Offenses, Chairman Of The Mahalla, Citizens ' Self-Government Bodies, Reporting, Control.*

### INTRODUCTION

One of the main directions of the policy of any democratic state is crime prevention activities, which consists in the implementation of a set of interrelated measures carried out by bodies and institutions that directly carry out crime prevention in order to preserve and strengthen law and order, identify, suppress offenses, as well as identify, eliminate the reasons for committing offenses and conditions conducive to them.

In accordance with the Decree of the President of the Republic of Uzbekistan «On measures to raise the activity of internal affairs bodies in the field of ensuring public safety and combating crime to a qualitatively new level», the internal affairs bodies have developed a qualitatively new system «Smart mahala» the process of their consideration, conduct a mutual operational dialogue with the population, evaluate the activities of prevention inspectors and sector leaders.

The practice of «preventive and preventive treatment» of the heads of the internal affairs bodies of regions, districts and cities to the population about the state of the crime situation in the relevant territory at the end of each month through information resources of the Internet is being introduced[1].

In accordance with the State Program for the Implementation of the Strategy of Action in Five Priority Areas of Development of the Republic of Uzbekistan in 2017-2021, in the «Year of Development of Science, Education and the Digital Economy», a completely new procedure for hearing reports from ambassadors of Uzbekistan in foreign countries has been introduced in the Senate of the Oliy Majlis of the Republic of Uzbekistan, as well as holding meetings of the Kengash and Senate committees on the issues studied directly with visits to the field with the participation of heads of ministries and departments in order to promptly resolve problems of concern to the population[2].

Thus, the analysis of the Law of the Republic of Uzbekistan «On the Prevention of Offenses» showed that the main idea of the normative legal act is to consolidate at the legislative level the priority tasks, principles and types of prevention of offenses, the system of bodies and institutions directly involved in the prevention of offenses, as well as their powers[3].

In particular, in accordance with chapter two of the Law of the Republic of Uzbekistan «On the Prevention of Offenses», the internal affairs bodies, prosecutors, the National Security Service, the National Guard, Justice, the State Customs Service, the State Tax Service, have entered the system of bodies and institutions directly involved in the prevention of offenses. bodies for labor and social protection of the population, public administration bodies for education and educational institutions, governing bodies of the state health care system and health care institutions and bodies of the State Committee of the Republic of Uzbekistan on ecology and environmental protection in the field of crime prevention, etc.[3].

In turn, the prevention of offenses carried out by the internal affairs bodies, as one of the authorized subjects of prevention, is understood as a set of special measures for recording and preventing the criminogenic consequences of human activity, as well as for identifying, studying and influencing criminogenic factors, conditions and circumstances, various negative phenomena and processes that affect crime.

The modern approach to crime prevention presupposes the creation of a system capable of influencing the causes and conditions of crime, objectively corresponding to the state of public relations and the established scientific approaches in this area, the main principle of which is a partial rejection of the dominance of control and preventive practice (which does not mean, of course, complete rejection of it) in favor of the security and protective orientation of the entire prevention system.

In accordance with the Action Strategy for five priority areas of development of the Republic of Uzbekistan in 2017-2021, one of the important areas is the reform of the system of public administration and civil service through decentralization of public administration, increasing the level of professional training, material and social security of civil servants, as well as a phased reduction state regulation of the economy[5].

The control and preventive function should be activated as a social legal system for the protection and protection of the rights of citizens and other persons, the state and society. The formation of an effective system for the prevention of offenses should be based on clear legal regulation of the activities of all subjects of prevention.

In accordance with the Decree of the President of the Republic of Uzbekistan «On measures to radically improve the activities of crime prevention units of the internal affairs bodies», a

procedure was introduced on October 1, 2017 for citizens' self-government bodies to hear monthly reports of preventive inspectors. It was determined that, based on the results of hearing the reports of preventive inspectors, the measures taken and the results of work to fulfill the assigned tasks are critically discussed, a personal assessment of the effectiveness of their activities is given, and recommendations are made on the suitability or inadequacy of the position held.[6].

In accordance with the Decree of the President of the Republic of Uzbekistan «On measures to improve the social and spiritual atmosphere in society, further support the institution of makhalla, as well as raising the system of working with families and women to a new level» cooperation in identifying and solving problems of the population on the basis of the principle of «mahalla - sector - People's reception – mahalla» ensuring the real formation of the mahalla as a reliable «bridge» between the people and the state, support for families and women»[7].

Analysis of the order of the Minister of Internal Affairs of the Republic of Uzbekistan «On approval of the Regulations on the procedure for hearing reports of inspectors on the prevention of strong points of internal affairs bodies in citizens' gatherings» establishes the procedure for organizing and conducting prevention inspectors and showed to the population that the report of the prevention inspector is his in-person speech in the prescribed manner before the chairman of the makhalin committee and other interested persons, the population once a month. The inspector's report on prevention is part of the mandatory activities of the territorial body of internal affairs. The report of the prevention inspector is carried out in order to: create conditions for the implementation of the rights of citizens of the Republic of Uzbekistan, public associations and organizations, state bodies, established by the Constitution of the Republic of Uzbekistan, laws, to receive reliable information on the activities of the internal affairs body; ensuring openness and publicity in the activities of the internal affairs body; increasing the level of citizens' confidence in employees of internal affairs bodies, as well as early prevention of offenses and crimes in the territory.

The tasks of conducting reports of crime prevention inspectors are: informing public authorities of the Republic of Uzbekistan, citizens about the state of law and order in the served territory; development, within the framework of the current legislation, of a system of public control over the activities of internal affairs bodies; ensuring the interaction of the internal affairs bodies with state bodies, public organizations, and citizens for the prevention and disclosure of crimes and offenses; legal education of citizens.

The hearing of the report of the prevention inspector is carried out in the presence of the chairman (oxakal) of the gathering of citizens, his advisers, representatives of educational institutions, family clinics, rural medical centers, the population living in apartments, apartment buildings, the head of the law enforcement agency. The date of hearing the report of the preventive inspector is established by the council of the citizens' gathering in agreement with the head of the law enforcement agency assigned to the given territory. Three days before the meeting, an announcement will be posted in a prominent place at the meeting of citizens and measures will be taken to inform the public. The meeting to hear the report of the prevention inspector is conducted by the chairman (oxakal) of the citizens' gathering. The minutes of the meeting are signed by the chairman (oxakal) of the meeting of citizens, the executive secretary of the meeting of citizens, the head of the internal affairs body of territorial subordination.

Representatives of bodies and institutions directly involved in the prevention of offenses and participating in it are invited by citizens to gather at a meeting to hear reports from prevention inspectors. Hearing reports from prevention inspectors at citizen meetings.

Prevention inspectors report on the following main areas: organizing the prevention of offenses, especially among minors and young people, identifying, studying and eliminating the causes of offenses, the conditions that allow them; conducting direct work with minors and young people aimed at educating them in the spirit of love for the Motherland, patriotism, respect for national and universal values, protecting the younger generation from the ideas of terrorism, religious extremism, violence and cruelty; interaction with other bodies of internal affairs, state bodies, organizations, self-government bodies of citizens on the prevention of offenses, improving the legal culture of citizens; implementation of special preventive measures to identify and suppress offenses, eliminate the causes of offenses and the conditions that allow them, as well as preventive work with persons prone to offenses; monitoring the attendance of students in educational institutions, to carry out preventive work with minors and young people who are in a socially dangerous situation and do not attend educational institutions, as well as with parents of this category of persons.

During the reporting period, prevention inspectors must ensure state and official secrets protected in accordance with the law, as well as ensure the inviolability of personal and family secrets of people.

In cases where the prevention inspector cannot speak at public meetings (when the prevention inspector is temporarily incapacitated, transferred to another position, resigned), the head of the internal affairs body assigned to this area, in agreement with the chairman of the citizens' meeting, sets another date for the performance.

In cases where the prevention inspector cannot speak at public meetings (when the prevention inspector is temporarily incapacitated, transferred to another position, resigned), the head of the internal affairs body assigned to this area, in agreement with the chairman of the citizens' meeting, sets another date for the performance.

The prevention inspector reports to the gathering of citizens on the work done from the date of appointment. In order to ensure a fair assessment by the population of the activities of preventive inspectors, the chairman of the gathering of citizens ensures the participation of the population (their representatives) in yards, houses, streets and neighborhoods on the territory. It is not allowed to prohibit citizens from attending a meeting for various reasons. Based on the results of the hearings of prevention inspectors, the measures taken and the results of their work are critically discussed, their effectiveness is assessed, recommendations are made on the suitability or unsuitability of their position and presented to the head of the internal affairs bodies. The assessment of the performance of the prevention inspector is determined by the decision of the meeting. A meeting of citizens is permitted if more than half of the total population eligible to participate is present. If it is impossible to convene a meeting of citizens, a meeting of representatives of citizens is held. A meeting of citizens' representatives is competent if at least two thirds of citizens' representatives are present in yards, houses, streets and districts. At a meeting of citizens (meeting of citizens' representatives), a decision is made by a majority vote of those present. In case of equality of votes, the vote of the persons responsible for holding the meeting is decisive.

Thus, the organization of the reporting of the crime prevention inspector to the population is carried out in order to implement the principles of openness and publicity, to create conditions for ensuring the rights and freedoms of citizens, public associations and civil institutions to receive reliable information about the activities of the internal affairs bodies. The report of the subjects of prevention is his face-to-face presentation in the prescribed manner before a competent meeting of the legislative (representative) body of state power or a meeting of citizens. The report of the subject of prevention is part of the mandatory activity of the territorial body of internal affairs to inform state bodies and citizens about the activities of the internal affairs bodies.

#### **LITERATURE:**

1. Decree of the President of the Republic of Uzbekistan "On measures to raise the activities of the internal affairs bodies in the field of ensuring public safety and combating crime to a qualitatively new level" dated March 26, 2021 No. UP-6196
2. Decree of the President of the Republic of Uzbekistan "On the State Program for the Implementation of the Strategy of Action in Five Priority Areas of Development of the Republic of Uzbekistan in 2017-2021 in the Year of Development of Science, Education and the Digital Economy" dated March 2, 2020, No. UP-5953 \ National basedata of legislation, 03.03.2020, No. 06/20/5953/0246
3. Law of the Republic of Uzbekistan "On Prevention of Offenses" dated May 14, 2014 \ Collected Legislation of the Republic of Uzbekistan, 2014, No. 20, art.221;2015, no. 32, art.425;2016, no. 52, art.597;2017, no. 37, art.978;National database of legislation, 05.01.2018, No. 03/18/456/0512, 16.01.2019, No. 03/19/516/2484, 2019, No. 2, art.47, 24.05.2019, No. 03/19/542/317, 05.09.2019, No. 03/19/564/3690, 11.09.2019, No. 03/19/566/3734, 30.10.2019g., No. 03/19/575/3972
4. Decree of the President of the Republic of Uzbekistan "On the Strategy of Actions for the Further Development of the Republic of Uzbekistan" dated February 7, 2017 No. 4947
5. Resolution of the President of the Republic of Uzbekistan "On measures to radically improve the activities of crime prevention units of the internal affairs bodies" April 18, 2017, No.PP-2896
6. Decree of the President of the Republic of Uzbekistan "On measures to improve the social and spiritual atmosphere in society, further support the institution of the mahalla, as well as raising the system of working with families and women to a new level" February 18, 2020, No. UP-5938
7. Decree of the President of the Republic of Uzbekistan "On measures to improve the social and spiritual atmosphere in society, further support the institution of the mahalla, as well as raising the system of working with families and women to a new level" February 18, 2020, No. UP-5938
8. Order of the Minister of Internal Affairs of the Republic of Uzbekistan "On Approval of the Regulations on the Procedure for Hearing Reports of Inspectors on the Prevention of Support Points of Internal Affairs Bodies in Citizens' Assemblies" September 6, 2017, No. 193 \



Registered by the Ministry of Justice of the Republic of Uzbekistan September 13, 2017  
Registration No. 2930

9. Collected Legislation of the Republic of Uzbekistan, 2017, N 37, Article 1021.

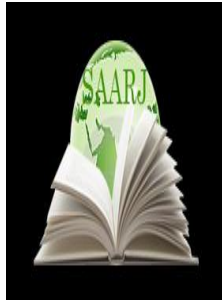

**ACADEMICIA**  
**An International**  
**Multidisciplinary**  
**Research Journal**  
 (Double Blind Refereed & Peer Reviewed Journal)

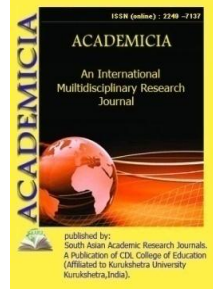

DOI: **10.5958/2249-7137.2021.01038.7**

## THEORY OF POLITICAL COMMUNICATION

**Ravshanjon Omonov\***

\*Researcher,

Named after Mirzo Ulugbek National University of UZBEKISTAN

Email id: nuuzteacher@mail.ru

### ABSTRACT

*The article discusses theories of political communication based on theoretical and methodological views developed by scientists of the world. In particular, theories of minimal effects; theory of usefulness and satisfaction of needs; cultivation theory; setting the agenda, etc. are investigated. The author also examined the characteristics and functions of theories of political communication, the means of struggle for political power in the process of communicative impact on the political consciousness of society. During the article, the nature and content of informational relationships between the subjects of political communication and objects of political communication are studied. The author believes that the considered theories are developed primarily within the general framework of the positivist trend of modern political science and the study of political communication should be focused on the elements of perception. For instance, instead of analyzing the text of the message, it is necessary to find out how this text is perceived by the audience.*

**KEYWORDS:** *Communication, Political Communication, Theory, Micro Level, Agenda-Setting, Elections, Media, Audience, Theory Of Minimal Effects, Theory Of Uses And Gratifications, Theory Of Cultivation.*

### INTRODUCTION

The large-scale changes taking place in all spheres of social life in recent years, in particular in politics, economics, culture, communication, including the rapid development of information technology, the formation of a single information space, the spread of the Internet and technical means. contributes to the growing importance of information, communication, and especially political communication in the world. The purpose of the study is to study the role of communications in the political space, the degree of empirical validation of micro-level theories, the relationship between subject and object.

---

## RESEARCH METHODOLOGY

Since the article is mainly of a theoretical nature, it analyzes the theoretical views of world researchers. The following approaches were used throughout the study: historical, behavioral (to determine audience behavior), and comparative (comparative). In preparing the article, the rules on the nature and structure of political communication, micro-level theories developed by researchers in political science, sociology, philology, journalism, psychology and other fields of knowledge were used. The study is based on the views of the founders of political communication theories G. Lasswell, L. Festinger, E. Katz, J. Gerbner and other scholars. The use of a systematic approach has played an important role in solving research tasks.

### Theoretical analysis and results

The study of political communication is initially based on the first conceptual notions of mass-communication processes known as the "miracle bullet theory" and the "theory of theorists". These concepts stem from the assumption that information propaganda has a huge, unlimited impact on the public audience. This audience behaves inactively in gathering information and essentially reminds the patient that his condition will change after receiving the required amount of the drug in the form of injections. One of the founders of these theoretical models was G. Lasswell, who in his work on the analysis of propaganda mechanisms for the masses during the First World War gave a classical definition of public propaganda as a "hammer and sickle of collective solidarity." This definition unites millions of atomized individuals into a single "mass of hatred, hope, and trust". In the political context, such a question about the information "miracle bullet", which on the one hand can always find its target, on the other hand, can be seen as a single system of stimuli that creates a holistic system of reactions, and as a result completely subjugates the whole collective body. arouses interest. However, a study of the popular electoral process in the late 1930s and 1950s, led by P. Lazarsfeld, B. Berelson, and E. Campbell, shows that these theoretical views have not found empirical confirmation.

On the eve of the 1940 election, based on an analysis of the results of social data obtained through a series of parallel voter surveys in Erie County, Ohio, P. Lazarsfeld, B.C. Berelson and H. Gode propose a two-tier classical model of communication, which eventually becomes one of the first generally accepted theoretical constructions in political communication [11]. According to this model, the impact of mass communication on the individual is largely mediated by small groups, where individuals who actively read the newspaper, listen to the radio, then discuss what they read or hear from others, and give personal interpretations of facts and events. that is, specific "opinion leaders". In other words, interpersonal and intra-group communication mediates mass communication according to the following scheme: ideas are transmitted to public opinion leaders through radio and newspapers, and from them to the less active segments of the population.

According to the "minimal effect theories" of mass communication, the influence of information through the media during election campaigns tends to favor other factors that determine the specificity of the electoral system, such as belonging to a particular social group or political party. Until recently, other concepts were put forward in the mid-1950s, as opposed to the "minimal effect theories" of researchers' interest in the problems of political communication. According to the concept proposed by L. Festinger, views, ideas, and thoughts that force people to doubt their personal ideals or touch their feelings and tastes are forced to assimilate and

experience psychological discomfort and fall into a state of “conscious (cognitive) dissonance”. In order to avoid discomfort, a person selects only information that is consistent with his or her views and opinions, and ignores conflicting messages. Although research on mass communication effects during the election campaigns created by W. Weiss in the 1960s did not confirm or partially refute this theory, the idea of selecting information for a specific purpose has continued recently in the works of a number of well-known authors, particularly D. Graber. P. Lazarsfeld's reader and follower, E. Katz's popular theory called "theory of uses and gratifications" originally developed in his work, actively ignored the message, which did not meet the interests of individuals, and in an unattractive way sorts by. The benefits and satisfaction that come from incoming messages can be both emotional and intellectual in nature. For example, during an election campaign, a person may focus only on a message that is not only useful in voting in the upcoming election, but also evokes a sense of personal political competence. In the mid-80s, K.S. Rozenzweig, L. Wenner and F. The materials of the collective monograph, which saw the world under the editorship of Palmgrin, testify. The influence of the media on election campaigns and the study of election results became more active in the late 1960s and early 1970s. A number of studies have suggested that this phenomenon was largely due to the public appearances and intuition of current politicians. Rather than finding some universal effects, these studies focus on determining the conditions necessary to achieve this or that desired result. The party's influence in the election of a candidate allowed television, which was widespread and very popular at the time, to become a powerful force.

The results of research in the 1970s and 1990s strongly argue in favor of the conclusion that the media and television can influence election campaigns in different ways. The study focuses on the analysis of specific print and electronic “media reality” communication strategies used in election campaigns at the national, regional and local levels, as well as directly working with the individual. This line of political-communicative research first showed in the early 20s that there was a pseudo-environment in the media that replaced the real environment of the average member of society. He was born in Lippmann's works. Of these conditions, in particular Dj. Gerbner's "cultivation theory" (cultivation) stems from [6], according to which the media creates a symbolic world that television viewers tend to perceive as real in the first place. Contrary to the classical theory of rational election, L. Bartels' famous study [3] shows that the electoral campaign is a dynamic (growing) process in which individual desires change frequently, bringing collective decision to an unpredictable level. T. Gitlin, D. Graber, K. Johnson-Karti and G. Koplend, K. and G. Leng, E. Austin and B. Pinklton, R. Hart, Dj. Edwards and S. Wayne's [8] published work in recent years has focused the public audience on the personal qualities of candidates: strength of nature, self-confidence, leadership skills, empathy, and so on, rather than the position of candidates on specific political issues. more interesting, but also says that the financial situation of the candidates for the elected positions is also of great interest. E. Dennis and Dj. Merrill, K. Djemison, D. Kellner, S. Kraus, L. Keyd, M. McKinney and Dj. Tedesco, E. Mikevich, Ch. Firestone and L. Rosell's research [4] has shown that in the context of candidates' superficial thinking about current issues, these areas attract the attention of many citizens who are hesitant in their choice, rather than thinking superficially about current issues.

Mass media companies can have not only a direct but also an indirect impact on the emotions and mood of voters. Thus, P. Abramson, Dj. Oldrich and D. Roud said [2] that if media outlets caused a wave of protests, which in turn affected the political environment and the election

results, these results could be partly explained by the impact of mass communication. One of the leading theoretical approaches to the study of the influence of the media on political ethics is the concept of "agenda-setting". From the point of view of this concept, the influence of the media on the audience has a specific structural nature: the more the press, radio or television pays more attention to the coverage of this or that event or problem, the more the event or problem is perceived by the audience. The concept of "agenda-setting" was first introduced in 1972 by D. Shaw and M. Associated with McCombs names. Thus, in the late 50s, N. Long notes that newspapers "play an important role in identifying events that, as a result of the establishment of a larger public agenda, can be talked about by most people, are listed as factual facts, and are assessed as major problems" [12].

On the development of G. Lasswell's proposals, the "Handbook of Political Communication", 1981, edited by D. Nimmo and K. Sanders, D. Judging by Svenson and D. Nimmo's 1990 New Directions in Political Communication and the 2004 L. Cade's Handbook of Political Communication Research, political scientists need to fill in some gaps in sociology and psychology. experts helped. Instead of an example of such research, in particular, the widely popular A.D. Benidger's monograph, as well as U.R. Neyman, L. McNight and R. Dj. Solomon's work can be cited [13].

## CONCLUSIONS AND SUGGESTIONS

Thus, the following theories were considered during the study: "minimal effect theories" (according to which information influence through the media during election campaigns by its effectiveness favors other factors that determine the specificity of the electoral system, such as belonging to a particular social group or political party); "Theories of utility and satisfaction" (in which the information is actively sorted, ignoring the message, which is manifested in a way that does not meet the interests of individuals, as well as unattractive); "Cultivation theory" (according to which the media, primarily television, creates a symbolic world that viewers tend to perceive as real); "Setting the agenda."

The theories we have considered are mainly developing within the positivist direction of modern political science. In turn, the study of political communication should focus on the elements of perception. For example, instead of analyzing the text of a message, it is necessary to learn how that text is received.

The study of the "critical" direction will focus primarily on the analysis of the social consequences of political communication. Thus, M. Edelman's influence [5] seeks to define the "structure" of messages that leads to the inertia and submissiveness of the oppressed masses due to their bias towards dominant groups. B. It is noteworthy that Ginsberg and M. Schefter did not see elections as a true expression of the desires and interests of society [7], the authors of this study came from certain assumptions about what OKV (not what it actually should be) should look like. These perceptions are adapted to the ideal of an absolutely free, independent OKV that represents the public interest and at the same time enlightens these masses. In fact, the fact that the press, radio, and television are almost inconsistent with this ideal is not uncommon. Baudrillard allows us to write in the spirit of a "requiem on the media" and to think about the "death of importance" that results from their activities. At the same time, most researchers in the "critical" field believe that scientists should take an active political position and take all possible measures to promote the transformation of society based on the principles of equality and justice

and change the structure of political and communication processes. This activity is in many respects S. According to Hall's descriptive description [9], at first glance it takes on the nature of a "discursive war" against the already established socio-political order, which is reflected in the revelation of the hidden ideological essence of innocent messages. As a result, the concept of political communication in "critical research" expands until any communicative activity has a political nature.

#### REFERENCES:

1. Липшман У. Общественное мнение. – М.: Институт Фонда "Общественное мнение", 2004. – С. 38.
2. Abramson P.R., Aldrich J.H., Rohde D.W. Change and Continuity in the 2000 Elections. – Washington, D.C.: CQ Press, 2002. – P. 33.
3. Bartels L.M. Presidential Primaries and the Dynamics of Public Choice. – Princeton, N.J.: Princeton University Press, 1988. – P. 37.
4. Dennis E.E., Merrill J.C. Media Debates: Great Issues for the Digital Age. – Belmont, CA : Wadsworth/Thomson Learning, 2002. – P. 21.
5. Edelman M. Constructing the Political Spectacle. – Chicago: University of Chicago Press, 1988. – P. 17.
6. Gerbner G. Institutional Pressures on Mass Communicators // The Sociology of Mass Media Communicators: Sociological Review Monograph. – Vol. 13. / Ed.: Halmos P. – University of Keels, 1969.- P. 205.
7. Ginsberg B., Shefter M. Politics by other means: politicians, prosecutors, and the press from Watergate to Whitewater. – 3rd ed. – New York: Norton, 2002. – P. 26.
8. Gitlin T. Media Unlimited: How the Torrent of Images and Sounds Overwhelms our Lives. – New York: Metropolitan Books, 2002. – P. 26.
9. Hall S. Encoding / Decoding // Media and Cultural Studies: Keywords / Eds.: M.G. Durham and D.M. Kellner. – Malden, Mass.: Blackwell Publishers, 2001. – P. 166.
10. Lasswell H. Propaganda, Communication, and Public Opinion: A Comprehensive Reference Guide. – Princeton, Princeton University Press, 1946. – P. 43.
11. Lazarsfeld P., Berelson B., Gaudet H. The People's Choice. – New York: Free Press, 1944. – P. 18.
12. Long N. The Local Community as an Ecology of Games. // American Journal of Sociology. – 1958. – Vol. 64. – P. 246.
13. Neuman W.R., McKnight L., Solomon R.J. The Gordian Knot: Political Gridlock on the Information Highway. – Cambridge, Mass.: MIT Press, 1997. – P. 32.



**ACADEMICIA**  
**An International**  
**Multidisciplinary**  
**Research Journal**  
 (Double Blind Refereed & Peer Reviewed Journal)

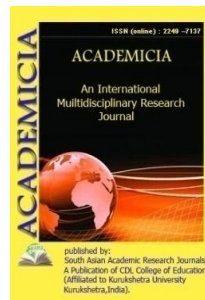

DOI: **10.5958/2249-7137.2021.01039.9**

**THE EFFECT OF SOWING TIME, SOWING RATES AND  
 FERTILIZATION RATES TO FIELD GERMINATION OF WINTER  
 BREAD WHEAT VARIETIES**

**Azimova Mukhayyo Egamberdievna\* ; Jononov Berdinazar Xudoynazarovich\*\* ;  
 Dilmurodov Sherzod Dilmurodovich\*\*\***

\*Doctor of philosophy on agricultural science, Docent,  
 The technology of storage and primary processing of agricultural products,  
 Karshi engineering-economics Institute,  
 Karshi city, Kashkadarya region, UZBEKISTAN  
 Email id: azimova.m2010@gmail.com

\*\*Candidate of agricultural science, Docent,  
 The technology of storage and primary processing of agricultural products,  
 Karshi Engineering-Economics Institute,  
 Karshi city, Kashkadarya region, UZBEKISTAN  
 Email id: b.jananov66@gmail.com

\*\*\*Senior scientific researcher,  
 Doctor of philosophy on agricultural science,  
 Grain breeding and seed production Laboratory,  
 Kashkadarya Branch of the Research Institute for Grain and Leguminous Crops,  
 Karshi city, Kashkadarya region, UZBEKISTAN  
 Email id: s.dilmurodov@mail.ru

**ABSTRACT**

*In recent years, global weather and climate change in the world may lead to a decline in higher and higher quality grain yields from agricultural crops, including winter soft wheat. Taking into account the different soil and climatic conditions of the country, it is necessary to further improve the technology of cultivation of high-quality varieties of cereals, suitable for the conditions of each region, high-yielding, early ripening, resistant to various diseases, salinity, drought and heat. This article evaluates the effect of sowing time, sowing rate and fertilization norms on field fertility of winter wheat varieties, selects and recommends the most optimal options that have a significant positive effect on field germination.*

---

**KEYWORDS:** Bread Wheat, Variety, Sowing Time, Sowing Rate, Fertilizer Rate, Field Germination.

---

## INTRODUCTION

In the largest wheat-growing countries in the world, the increase in grain yield and quality is achieved through the use of soil conditions, varietal characteristics and advanced methods of cultivation. It is important to increase the yield and grain quality of winter bread wheat varieties, to select promising winter wheat varieties that are high yields, resistant to diseases and pests. Depending on the soil and climatic conditions, the development and implementation of the timing of sowing, norms, fertilizer rates of winter wheat is one of the urgent tasks of the grain industry.

According to scientific sources, the yield increased by 15-20% when sowing first-class seeds from the first and second reproduction crops in the field, while sowing time and norms also have a significant impact on the field germination of winter bread wheat seeds [15].

A number of scientists have shown experimentally that the field germination of winter bread wheat seeds sown very early or late was much lower than that sown at optimal times [6, 7, 18].

According to H. Keldiyorova, U. Karshieva, when winter wheat varieties are sown late (November 30), compared to those sown in grain harvest (October 15), 44.4% in Sanzar-8, 33.7 in Skifyanka, 32.0 in Intensive and 32.0 in wheat it decreased by -41.4% [13].

In experiments carried out in the conditions of typical gray soils of Kashkadarya region, Krasnodarskaya-99 variety of winter bread wheat was sown early (October 1), field germination was 88.6%, medium-term (October 10) -89.6% and late sowing (November 10) -80, 7% [2, 3, 4].

It is considered that the area of grain can be assessed as “satisfactory” when sowing is carried out in optimal terms and norms for high and high-quality winter bread wheat varieties with an average of 4.5-5.0 million seedlings per hectare or 450-500 seedlings per 1 m<sup>2</sup> [5, 10, 17,].

When J.Saidov, K.Muminov studied sowing time, norms and fertilization norms (N<sub>200</sub>P<sub>140</sub>K<sub>100</sub> Ba N<sub>240</sub>P<sub>160</sub>K<sub>120</sub> kg / ha) of Nota, Jasmina, Yaksart varieties of winter bread wheat in Surkhandarya region, field seed germination control (88.3 without fertilizers) was used. from 84.8% to 3mln. when seeds were sown, 89.6% and in 6 million -86.6% of seeds germinated [16].

According to a number of researchers, the field germination of seeds of winter bread wheat varieties is always lower than laboratory germination. The difference between seed germination in field and laboratory conditions can be caused by a number of factors: lack of moisture in the soil, changes in soil and air temperature, past crops, pests and microorganisms, incorrect choice of planting dates, etc. [11, 14].

The optimum temperature for full, flat and sloping germination of seeds of winter bread wheat varieties is 12-20 °C, usually the average daily temperature sum required for germination of plants on the soil surface is 120-140 °C [1, 8, 9, 12].

This means that only when the bread winter wheat varieties are sown at the optimal time and norms for the region will the seeds germinate evenly, the plant will grow strong, accumulate well, prepare well for winter and be resistant to severe winter frosts.



## MATERIALS AND METHODS

Feeding of winter bread wheat varieties in the experimental field was carried out in accordance with the experimental structure. The entire annual rate of phosphorus and potassium fertilizers was applied under plowing, 40% of the nitrogen fertilizer rate was given during the period of tillering and shooting, and the remaining 20% was during the heading phase (Table 1).

**TABLE 1 STANDARDS AND TIMING OF APPLICATION OF MINERAL FERTILIZERS TO WINTER WHEAT.**

№	Annual norms of mineral fertilizers, kg/ha	Before planting, kg/ha		Feeding with nitrogen fertilizers during the growing season, kg/ha		
		P <sub>2</sub> O <sub>5</sub>	K <sub>2</sub> O	Tillering	Shooting	Heading
1	N <sub>180</sub> P <sub>108</sub> K <sub>54</sub>	108	54	72 (40%)	72 (40%)	36 (20%)
2	N <sub>210</sub> P <sub>147</sub> K <sub>105</sub>	147	105	84 (40%)	84 (40%)	42 (20%)

Field experiments were conducted in 2014-2016 in light gray soils of the experimental fields of the Kashkaryana branch of the Scientific Research Institute of Cereals and Legumes. The level of groundwater is located at a depth of 2.5-3.0 m, not saline with harmful salts, the granulometric composition of the soil is average, the previous crop is cotton. The following options were explored in the field experiment.

The area of each option is 100 m<sup>2</sup> (length 41.7 m, width 2.4 m), of which 50 m<sup>2</sup> is taken into account. The number of variants was 36, the experiment was placed in 3 replications, the variants were placed in 3 tiers. Our research was conducted in accordance with generally accepted recommendations and guidelines.

**Results.** In our experiments in 2014-2016, it was observed that when sowing the seeds of winter bread wheat varieties (Krasnodarskaya-99, Yaksart, Bunyodkor, Gozgan) earlier or later, the field germination of seeds decreased. In the control (fertilizer-free) variant of the experimental field, winter bread wheat varieties were 4.0; 5.0 and 6.0 million seeds were sown at normal rates. Sowing periods were carried out in the early time (October 1), medium time (October 20) and late time (November 10) periods. In the sown variants, it was studied that the field germination of seeds depends on the sowing time and norms. According to the results, the field germination of Krasnodarskaya-99 variety is 76.0-73.6%; 83.3-81.7; 68.5-66.9%, Yaksart variety 77.9-76.0; 84.5-81.6; 71.0-69.2%, in Bunyodkor 79.1-74.0; 84.1-82.0; 72.3-68.7% and in the Gozgan variety ranged from 77.9-75.0 83.1–81.2 and 71.5–69.5% (Table 2).

In the study, when Krasnodarskaya-99, Yaksart, Bunyodkor, Gozgan varieties of winter soft wheat were sown in the early (October 1) period against the background of N<sub>180</sub>P<sub>108</sub>K<sub>54</sub> kg / ha with 5.0 million seeds, the field germination of seeds was 76.9; 78.4; 80.6; and 78.2%. When planted in the medium sowing period (October 20) and late sowing period (November 10) field germinations found to be 8.0; 6.7; 5.9; 6.0% higher and 5.8; 6.9; 7.0; 4.9% lower. It was found that the field germination of seeds in the early (October 1) period was 78.3, 79.3, 80.8, 78.9% when sown wheat varieties on the background of mineral fertilizers (N<sub>210</sub>P<sub>147</sub>K<sub>105</sub> kg / ha) in the above period and norms. In the medium-term planted variant (October 20) was found to be 6.3,

7.3, 6.6, 6.8% less. In the late sown variant (November 10), it was noted that the field germination of seeds was higher by 5.9, 5.3, 6.6, 5.3%.

In the experimental field, high field germination rates of seeds were observed in winter bread wheat varieties sown in the medium (October 20) period. Field germination of seeds at different sowing rates (4.0; 5.0; 6.0 million seeds / ha) compared to early sowing (October 1) was found to be as high as Krasnodarskaya-99, Yaksart, Bunyodkor, Gozgan, respectively, from 7.0 to 7.5%, from 7.4 to 6.8%, from 5.2 to 5.7%, from 3.7 to 7.3%.

With the delay in sowing the seeds of winter soft wheat varieties, a decrease in seed germination was taken into account in all sowing norms as well.

According to a number of studies in cereals, sowing rates also have a significant effect on seed germination. There are conflicting opinions among researchers on this issue.

In our experiments, sowing norms had a significant effect on the field germination of seeds of autumn bread wheat varieties sown at different times.

**TABLE 2 INFLUENCE OF SOWING TIMING, NORMS AND FERTILIZERS ON FIELD GERMINATION OF WINTER BREAD WHEAT VARIETIES (AVERAGE 2014-2016).**

Variants			Early time (October 1)		Medium time (October 20)		Late time (November 10)	
			Germination plants in 1m <sup>2</sup>					
			piece	%	piece	%	piece	%
Krasnodar-99	Control	4 mln.	304	76	334	83.3	275	68.5
		5 mln.	375	75.1	413	82.7	337	67.4
		6 mln.	442	73.6	490	81.7	404	66.9
	N <sub>180</sub> P <sub>108</sub> K <sub>54</sub>	4 mln.	313	78.3	341	85.3	294	72.8
		5 mln.	385	76.9	420	84	358	71.1
		6 mln.	456	75.8	500	83.3	415	69.2
	N <sub>210</sub> P <sub>147</sub> K <sub>105</sub>	4 mln.	316	79	343	85.8	304	73.6
		5 mln.	392	78.3	423	84.6	365	72.4
		6 mln.	468	77.9	501	83.6	432	71.4
Yaksart	Control	4 mln.	311	77.9	338	84.5	284	71
		5 mln.	386	77.2	415	83.1	352	70.4
		6 mln.	456	76	490	81.6	415	69
	N <sub>180</sub> P <sub>108</sub> K <sub>54</sub>	4 mln.	318	79.5	346	86.6	293	73
		5 mln.	393	78.7	427	85.4	357	71
		6 mln.	466	77.6	505	84.1	420	70
	N <sub>210</sub> P <sub>147</sub> K <sub>105</sub>	4 mln.	320	80	349	87.4	299	74.0
		5 mln.	396	79.3	433	86.6	370	73
		6 mln.	471	78.4	511	85.2	431	71.8
Bunyodkor	Control	4 mln.	316	79.1	336	84.1	290	72.3
		5 mln.	377	75.5	413	82.7	351	70.2
		6 mln.	444	74	492	82	413	68.7
	N <sub>180</sub> P <sub>108</sub> K <sub>54</sub>	4 mln.	328	82.1	351	87.7	296	74.0

<b>Gozgan</b>	<b>N<sub>210</sub>P<sub>147</sub>K<sub>105</sub></b>	<b>5 mln.</b>	376	80.6	432	86.5	367	73.6	
		<b>6 mln.</b>	470	78.3	505	84.2	428	71	
		<b>4 mln.</b>	332	83.1	353	88.3	300	75	
		<b>5 mln.</b>	404	80.8	437	87.4	371	74.2	
		<b>6 mln.</b>	475	79.2	510	84.9	435	72.4	
		<b>4 mln.</b>	311	77.9	332	83.1	287	71.5	
	<b>Control</b>	<b>5 mln.</b>	383	76.7	409	81.8	351	70	
		<b>6 mln.</b>	450	75	487	81.2	417	69	
		<b>N<sub>180</sub>P<sub>108</sub>K<sub>54</sub></b>	<b>4 mln.</b>	325	81.2	343	85.7	292	73.0
			<b>5 mln.</b>	390	78.1	420	84.1	365	73.2
			<b>6 mln.</b>	459	76.4	498	83	426	71
		<b>N<sub>210</sub>P<sub>147</sub>K<sub>105</sub></b>	<b>4 mln.</b>	331	82.7	345	86.4	297	74
<b>5 mln.</b>	394		78.9	423	84.7	367	73.6		
<b>6 mln.</b>	461		76.9	505	84.2	435	72.3		

Fertility of seeds in field conditions varied depending on sowing norms, duration and varieties. For example, winter wheat varieties have an acceptable (October 20) When sown in fertilizer-free plots at the rate of germinated seeds of 4.0; 5.0; 6.0 million / ha, seed germination in accordance with sowing norms ranged from 83.1 to 81.7% in Krasnodarskaya-99 variety, from 84.5 to 81.6 in Yaksart variety; The Bunyodkor variety ranged from 84.1 to 82.0% and the Gozgan variety from 83.1 to 81.2% (Table 2).

At the above sowing rate and duration, seed germination when fertilizers are applied N<sub>180</sub>P<sub>105</sub>K<sub>54</sub> kg / ha is 85.3-83.3, depending on the variety; 86.6-84.1; 87.7-84.2 and 85.7-83.0%, respectively. In fertilizers applied N<sub>210</sub>P<sub>147</sub>K<sub>105</sub> kg / ha, these values are 85.8-83.6, respectively; 87.4-85.2; Ranged from 88.3-84.9 and 86.4-84.2%. Fertility of seeds of winter soft wheat varieties in field conditions was the highest (87.4-85.7%) in Bunyodkor and Gozgan varieties when sown at an acceptable level (5.0 million seeds / ha) and on time (October 20). When seeds of winter bread wheat varieties were sown below the acceptable norm (4.0 million units / ha) or more (6.0 million units / ha) in the early (October 1) or late (November 10) periods, a decrease in seed germination under field conditions was observed.

In our experiments, Bunyodkor and Gozgan varieties of winter bread wheat were sown early (October 1) from 7% to 82.7%, the increase in the sowing rate during this period to 6.0 million germinated seeds reduced the germination of varieties in field conditions by 4.8 and 5.8%, respectively. A similar pattern was observed in the medium (October 20) and late (November 10) planting periods. When sowing of seeds of winter bread wheat varieties were carried out later than the optimal time (November 10), the field germination of seeds decreased in all sowing norms. However, in the late sowing period (November 10), the difference in sowing rate from 4.0 million germinating seeds per hectare to 6.0 million germinating seeds was only 2.5 and 1.9%, respectively.

Thus, in our experiment, as the sowing rate increases throughout the sowing period, the germination of seeds of winter bread wheat varieties decreases in the field. This decrease is explained by the fact that most researchers release a lot of harmful (toxic) substances during seed germination and germination. .

## CONCLUSION

In the conditions of light gray soils of Kashkadarya region to sow the seeds of winter bread wheat varieties for full and short-term sowing in optimal terms (October 20) and sowing rates (5 million seeds / ha) on the background of mineral fertilizers  $N_{210}P_{147}K_{105}$  kg / ha, seeds of Bunyodkor and Gozgon varieties provided the highest (87.4 and 85.7%) field germinations.

It was found that when field seeds of winter wheat were sown earlier (October 1) or late (November 10) than the optimal sowing period, less than the sowing norm (4 million seeds) or more (6 million seeds), the field germination of seeds decreased.

## REFERENCES

1. Amonov O., Juraev D., Dilmurodov Sh., Jabborov F., Meyliev A., The effect of high temperature on productivity during the period of grain filling. *Agro ilm. Tashkent*. 2015. No. 6 (38). pp. 24-25.
2. Bobomirzaev P.X. Influence of sowing dates on wheat growth and development in the south of the republic. *Agro ilm. Tashkent*. 2017. No. 2 (46). pp. 38
3. Dilmurodov, S. D., Toshmetova, F. N., & Fayzullayeva, D. (2020). Selection of high-quality donor varieties of bread wheat for hybridization. In *Young Scientists of Russia* (pp. 55-58).
4. Dilmurodov S. Some valuable properties in evaluating the productivity of bread wheat lines. *International scientific and technical journal "Innovation Technical and Technology"*. 2020. Vol. 1. No. 1. pp. 60-62.
5. Dilmurodovich D. S. et al. Analysis of yield and yield components traits in the advanced yield trial of winter bread wheat. *International journal of Discourse on Innovation. Integration and Education*. 2021. Vol. 2. No. 1. pp. 64-68.
6. Dilmurodovich D. S. et al. Productivity, quality and technological characteristics of bread wheat (*Triticum aestivum* L.) variety and lines for the southern regions of the Republic of Uzbekistan. *Plant cell biotechnology and molecular biology*. 2021. pp. 63-74.
7. Dilmurodovich D. S. et al. Study of morpho-biological properties and resistance to yellow rust disease of new lines of winter bread wheat. *Inter Conf*. 2021.
8. Dilmurodovich D. S., Bekmurodovich B. N., Shakirjonovich K. N. Winter bread wheat grain quality depends on different soil-climate conditions. *International journal of Discourse on Innovation. Integration and Education*. 2020. Vol. 1. No. 5. pp. 377-380.
9. Dilmurodovich D. S., Shakirjanovich K. N. Analysis of yield and grain quality traits in the advanced yield trial of winter bread wheat. *Euro-Asia Conferences*. 2021. Vol. 1. No. 1. pp. 550-555.
10. Fayzullayev A. Z. et al. Selection of high-yielding and high-quality lines of bread wheat. *International scientific and Technical journal "Innovation technical and Technology"*. 2020. Vol. 1. No. 3. pp. 10-14.
11. Gubanov Ya. V., Ivanov N.N. *Ozimoya pshenitsa*. Moscow. Colossus. 1998. S-303.

12. Juraev D. T. et al. To study the heat resistance features of bread wheat varieties and species for the southern regions of the Republic of Uzbekistan. *European Journal of Molecular & Clinical Medicine*. 2020. Vol. 7. No. 2. pp. 2254-2270.
13. Keldiyorova X.X., Qarshieva U. Vliyanie srokov poseva na urojaynost i kachestva zerno sortov pshenitsy usloviyax Samarkandskoy oblasti. *Agro ilm. Tashkent*. 2017. No. 2 (46). pp. 40-41.
14. Maxammatova M.U. Influence of physiological maturation of wheat varieties on flour and seed quality, sowing rate, growth period and yield. 1st National Conference on wheat selection, seed production and cultivation technology in Uzbekistan. Tashkent. 2004. pp. 80-82.
15. Qurbonov G., Umarova M., Berdieva B. Grain growing in the world and in Uzbekistan. *Bulletin of agrarian science of Uzbekistan*. Tashkent. 2003. No. 2. pp. 22-24.
16. Saidov J., Muminov K.M. Influence of norms of sowing, growth, development and sowing norms of winter wheat on grain yield. *Respub. ilm. - amal. konf. material. Samarkand*. 2016. pp. 46-47. 101.
17. Siddiqov R., Adashev I. The fields are blue. *Agriculture of Uzbekistan*. Tashkent. 2017. No. 11. pp. 10.
18. Siddiqov R., Egamov I., Mansurov A. March is the month of adding grain to the harvest of autumn cereals. *Agro ilm. Tashkent*. 2015. No. 4 (48). pp. 49.

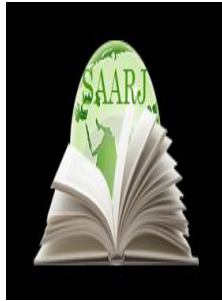

**ACADEMICIA**  
**An International  
Multidisciplinary  
Research Journal**  
(Double Blind Refereed & Peer Reviewed Journal)



DOI: **10.5958/2249-7137.2021.01040.5**

## **THE ROLE OF CROWDFUNDING IN INVESTMENT PROCESS AND INTERACTION OF CROWDFUNDING PLATFORMS**

**Ruzibaeva Nargiza Khakimovna\***; **Khotamkulova Madina Sanjar kizi\*\***

\*Senior Lecturer,  
Samarkand Institute of Economics and Service,  
UZBEKISTAN

\*\*Student,  
Samarkand Institute of Economics and Service,  
UZBEKISTAN

### **ABSTRACT**

*The emanation and essence of crowd funding in investment process is analyzed in this manuscript and several researches have been conducted for revealing deeply the significance of crowd funding in businesses. A successful project mandates that the several months' worth of meticulous networking be set aside even before the campaign is launched. A poorly prepared campaign is a recipe for disaster. A campaign is never just a day's work – owners of the company will need to be constantly*

**KEYWORDS:** *Crowd Funding, Investment, Economy, Innovation, Start-Up, Equity, Reward, Dividend, Entrepreneurship*

### **INTRODUCTION**

As technology and business environment has been facing to the great shifts, growing number of young and emerging businesses are requiring obtain financial resources through open calls over the internet. As a result special platforms have been introduced and such campaigns are often hosted on specialized platforms that serve as intermediaries between founders and potential funders. In recent years, crowd funding platforms in particular have had extraordinarily high success rates in these published campaigns and they have already become a central role player in the overall investment.

## MATERIALS AND METHODS

Although, the origination of crowd funding has deep roots during the centuries, the first recorded use of term “crowd funding” was in August 2006, by entrepreneur Michael Sullivan[1]. He used it in the launch of his company fundavlog, which was an attempt to create an incubator for video blog projects.

According to the scientists[2-3], crowd funding is a way of raising money to finance projects and businesses. It enables fundraisers to collect money from a large number of people via online platforms. Crowd funding is most often used by startup companies or growing businesses as a way of accessing alternative funds. It is an innovative way of sourcing funding for new projects, businesses or ideas and it can also be a way of cultivating a community around the offered projects. By using the power of the online community, the owners of the projects can also gain useful market insights and access to new customers.

Additionally, Agraval[4] and others refer that crowdfunding platforms are websites that enable interaction between fundraisers and the crowd. Financial pledges can be made and collected through the crowdfunding platform. Fundraisers are usually charged a fee by crowdfunding platforms if the fundraising campaign has been successful. In return, crowdfunding platforms are expected to provide a secure and easy to use service. Many platforms operate an all-or-nothing funding model. This means that if you reach your target you get the money and if you don't, everybody gets their money back – no hard feelings and no financial loss.

Scientists of economics stress[5-6-7] that there are a number of crowd funding types which are explained below but three most common types of crowd funding are used by profit-making SMEs and startups: peer-to-peer, equity and rewards crowd funding.

Main types of crowd funding are followings:

**Peer-to-peer lending.** The crowd lends money to a company with the understanding that the money will be repaid with interest. It is very similar to traditional borrowing from a bank, except that you borrow from lots of investors.

**Equity crowd funding** - sales of a stake in a business to a number of investors in return for investment. The idea is similar to how common stock is bought or sold on a stock exchange, or to a venture capital.

**Rewards-based crowd funding.** In this type of crowd funding individuals donate to a project or business with expectations of receiving in return a non-financial reward, such as goods or services, at a later stage in exchange of their contribution.

**Donation-based crowd funding:** individuals donate small amounts to meet the larger funding aim of a specific charitable project while receiving no financial or material return.

**Profit-sharing / revenue-sharing.** Businesses can share future profits or revenues with the crowd in return for funding now.

### **Debt-securities crowd funding**

Individuals invest in a debt security issued by the company, such as a bond.

Last but not least, **Hybrid models** offer businesses the opportunity to combine elements of more than one crowd funding type []

Cassar refers[8] that related findings provide capital-seeking entrepreneurs with a preliminary orientation from which they can increase their probability of receiving funding, once they obtain access to multiple investors. In general, for innovative start-ups seeking external financing, reducing the comparably high information asymmetries with potential investors is always a major challenge. This problem is even more pronounced in crowd funding, which often entails considerable regional distances between the project initiators and potential funders. Therefore, Rasmussen and Sørheim[9] note that, it seems to be essential that entrepreneurs present and communicate their investment case in a manner that corresponds with the investment process of a particular funding source.

According to Tomczak and Brem[10], in recent years, the emergence of crowdfunding has enabled the funding and realization of countless entrepreneurial projects via open calls over the internet. The vast majority of the initiated campaigns are conducted on web-based platforms serve as intermediaries between project initiators and potential funders.

### Methodology of the research

The methodology of the research includes mathematic-statistic analyzes, historical analyzes and modeling methods. Statistics of the research have been made by the authors based on the official statistics of the world.

### Results

Conducted researches revealed that entrepreneurs and innovators have faced to pressing issue which is access to finance, and over the years it was issue for small and medium-sized enterprises (SMEs) as well as start-ups. Thus, crowd funding was investigated how to address financing as a barrier to ICT-enabled innovation. In fact, crowd fundings are sources of financing beyond the traditional form of financing. Clearly, traditional methods of financing usually come from funds from friends and family, bank loans, business angel and venture investments. Exactly, crowd funding is identified as a potential way to go beyond the traditional methods of financing businesses and innovation and as a potential way to address this barrier to innovation. Several researches have been conducted offering an overview of crowd funding using the current literature on the topic. Conducted researches explain how crowd funding campaigns and platforms function. Crowd funding is the raising of small funds from a large number of individuals. In its current form, crowd funding involves intermediaries, which are called funding portals. These funding portals are usually web-based. Analysis identified that crowd funding has already become one of the main sources of funding in investment processes.

Studies showed that following four platforms are top crowd funding platforms currently available and the fees and sustainability are provided below:

**TABLE1 TOP 4 CROWDFUNDING PLATFORMS OF THE WORLD[11]**

No	Platforms	Fee	Sustainable for:
1	Kickstarter	5% of the total funds raised	Startups, video game developers, designers, musicians, artists, e.t.c.
2	Indiegogo	5% of the total funds raised	Small scale businesses, start-ups, non-profit organizations, e.t.c.



3	GoFundMe	2.9% plus 30 cents for donation	Non-profits, Charities, designers, artists, e.t.c.
4	Patreon	Subscription-based, varies between creators	Artists, musicians, Streamers, online Models, e.t.c.

It is important that platforms should be chosen based on the several criteria in order to minimize the risk and not to be in a crisis status. When it comes to the specific project, there are many variables to take into account and they could be followings:

- Reason for raising fund
- How much would like to raise
- Resources for marketing
- The level of control over the project

Statistics showed[12] that the global crowd funding market size was \$84 billion as of 2018 and is expected to reach \$114 billion by 2021. Additionally, it is identified that fewer than a quarter (22.9%) of all crowd funding operations end up being successful and a research has been conducted for revealing the reasons of fail of those companies and they can be seen below:

#### 1) Campaign is not unique

One of the main reasons for the failure of a campaign is the lack of a competitive edge. Competition arises when the product or service offered is not unique. It is a very difficult proposition to sell an idea that isn't idiosyncratic, and convince investors to invest their hard-earned money in a product that is unable to justify its advantages over its competitors.

#### 2) Campaign is poorly prepared and organized

A lot of preparation is essential for a successful campaign. A lot of time and effort needs to be invested in the campaign. A successful project mandates that the several months' worth of meticulous networking be set aside even before the campaign is launched. A poorly prepared campaign is a recipe for disaster. A campaign is never just a day's work – owners of the company will need to be constantly in touch with their campaign and always they should be available to tweak it to their advantage whenever the necessity or opportunity comes. A campaign fails when:

**Not enough time is invested:** Time is of great essence to any successful campaign. When one prepares a project, one would need to dedicate enough time for its planning and its promotion. Without a meticulous plan that looks ahead, the project is doomed for failure.

**The message of the campaign is not consistent:** Unless the core idea is well-defined, it would not be possible to have all the people involved on the board. Without clear goals and clear-cut strategies to achieve them, investors will be in the dark about what the target is. Without proper communication, investors may bank upon unrealistic objectives that will lead to conflicts later on.

**No video is included:** In a successful campaign, the prerequisite of having a video is a given. Without a meaningful video that clearly illustrates the vision of the entrepreneur(s), a campaign

cannot hope to succeed. A well-made video not only describes how aim to go about your project, but also exemplifies why owner is going for that project at all. The video has to be persuasive and should lend itself to being shared on multiple platforms. It should be long enough to include all core messages, however short enough to retain interest. It should have clear audio and should include on-screen captions wherever necessary to aid in understanding.

Campaign is too complicated: When it comes to an advertising campaign, it is the best bet to have things simple and sweet. Too many complications in the campaign will result in drastic narrowing down of the target audience, and you will end up losing many prospective investors just because your campaign was too tricky for them to comprehend.

Campaign is targeting the wrong crowd: It is essential for you as an entrepreneur to have the backing of the right audience. Targeting one and all, irrespective of the domain of interest is a futile attempt at advertising – this will never bring the right people in the loop.

### 3) Campaign is not emotional

To be successful, it is obligatory for the campaign to strike a chord with the investors and the general public. It is not possible for owner to connect on an emotional scale with investors when investor is not emotional about project. Lack of passion and self-motivation will invariably result in a poor image of the campaign. Failing to get investors excited will literally translate into a poor prospect of investment in the campaign.

### 4) Campaign has unrealistic funding goals

One of the main reasons for the failure of a crowdfunding campaign is the setting of unrealistic goals as far as funding is concerned. Many times, a project is under-financed due to faulty predictions about capital requirements. Many campaigns have failed because entrepreneurs overlooked vital areas of funding while preparing plans. Only a comprehensive plan – one that takes care of all possible situations and scenarios, however, miniscule or trivial, will be successful in attracting the right amount of funding.

### 5) Campaign has low exposure and popularity

Low exposure is one of the foremost reasons for the failure of a crowdfunding venture. Also, too few PR contacts will have an adverse effect on campaign. It is vital to know that owners will need to make as many PR contacts as possible before starting campaigning project. For example if you are planning on manufacturing a fluoride-free herbal toothpaste, it is important to create and distribute a PR article about the ill-effects of fluoride-based toothpastes and the benefits of herbal toothpastes on all possible platforms at least a fortnight before the actual launch of the product.

### 6) Campaign perks do not add enough value

The main motivation behind campaign should be to deliver certain perquisites to stakeholders. Without a distinct set of perks, it would be impossible to grab the attention of any investor. An investor will only invest when he feels assured about certain returns that add value to his cause.

It is best to assume that investor is going to be very selfish in demanding that he gets his fair share of returns from his investment.

### 7) Campaign owner does not have sufficient experience

Many projects meet with failure when the project owner or the entrepreneur does not have any or sufficient experience in the field. It is not uncommon for an entrepreneur to pursue a project outside the domain of his primary experience. However, it is mandatory for such an entrepreneur to associate himself/herself with people who possess the relevant expertise and experience.

#### 8) Campaign has faulty timing

Campaign may have everything going its way in campaign, but just the one factor of wrong timing is enough to foul up all future scope of project. It is essential to hit off the project at the right time of the day, given, of course, the geographical location of the target audience. For example, if you are located in the United States and your target audience is in Japan, you will need to work out a suitable time slot in Japan (and not in the United States) to kick off the campaign.

Let's get the ball rolling with some of the key stats on crowdfunding worldwide. It's difficult to accurately assess the overall size of the crowdfunding market. There are all sorts of factors to consider: the global volume of transactions with all of the associated costs, equities earned and their fluctuating value on the market, donations, indirect contributions of the industry to the global economy...

For this reason, many online crowdfunding statistics tend to throw around wildly different numbers, ranging from tens to hundreds of billions of US dollars. For the sake of simplicity, when we refer to the global market, we're talking about everything related to crowdfunding, and when we mention transaction value, it's purely the monetary value of crowdfunding transactions themselves.

One trend these stats clearly show is that North America is still the leading region driving the crowdfunding industry globally. The top crowdfunded[11] projects are still those organized in business and entrepreneurship ventures, while social causes account for about a fifth of the total crowdfunding budget.

Finally, regulation crowdfunding – a popular method of avoiding registration requirements for securities-based crowdfunding projects – is gaining serious traction in the US.

The core of every good crowdfunding effort is a well-thought-out and realized campaign. Proper crowdfund marketing can make all the difference: more than three-quarters of all campaigns fail to obtain the necessary funding. Most of those that do, however, end up exceeding it greatly.

With well over six million campaigns in 2019 alone[13], managing to both attract and retain crowdfunding donors is a key challenge for both crowdfunding companies and individuals.

The most successful crowdfunding campaigns tend to be ones organized for nonprofit causes. They generate almost twice as many funds compared to the industry average. Diversifying your crowdfunding sources and having a cause that people can believe in are the keys to success.

Starting a crowdfunding campaign off on the right foot is the key to its success. Most successful crowdfunded projects tend to capture the attention of the majority of their potential backers with a good initial pitch. People tend to have short attention spans though, and it's important to keep your backers regularly updated and engaged.

Most crowdfunding backers are younger people, so making engaging and personal content that employs plenty of personal video and image material is a surefire way of getting and retaining the interest of your target audience.

Crowdfunding success rates often depend on having loyal repeat backers, as well as making large last-minute pushes as the funding deadlines start approaching. Many backers tend to generally like an idea but hold off from investing until they can see how the project develops.

They often end up forgetting about it in the process. Giving them something to go back to can make the difference between failing a campaign goal miserably and achieving it with flying colors.

Although the rate of growth has somewhat slowed down in the last few years, crowdfunding is still showing signs of constant improvement, as the industry grows ever larger.

Of particular note is how things are changing in terms of the overall structure and distribution of crowdfunding funds. Back in 2016[13], the lending market accounted for 70% of the entire industry. Equity crowdfunding statistics from the past four years, however, show that things are slowly changing.

To be clear, the industry still primarily revolves around its lending segment. However, equity crowdfunding is currently growing more than three times as quickly, so it will be interesting to see where we are 10 years from now.

Real estate is one of the most consistent segments of the global crowdfunding market when it comes to growth. With average investment returns being no smaller than 10%, it's little wonder that the industry has a solid future ahead of it.

With almost two-thirds of the crowdfunded real estate market investments in 2018, the Americas are driving the majority of the industry, with the US and Canada being the largest markets. In terms of growth, however, crowdfunding stats show the EU and other European countries as the fastest-growing players.

Although residential property investment still dominates the market, experts predict lucrative future gains for investors ready to support the growing commercial sector.

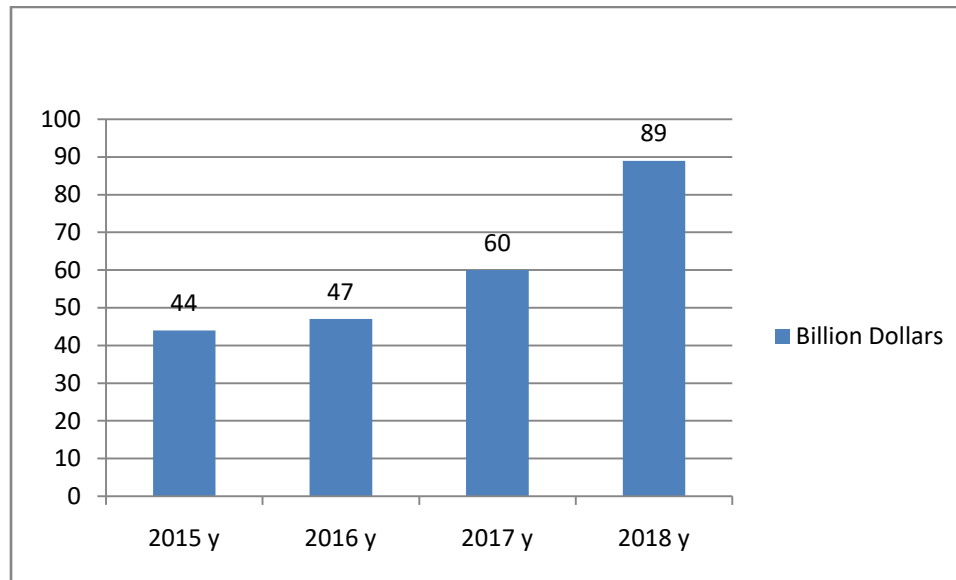

**Diagram1 Total Worldwide Crowd funding Volumes except China from 2015 to 2018[14]**

It can be seen from the above given diagram that the volume of crowd funding is raising year by year around the world. Exactly, if the total volume of crowd funding was 44 billion dollars in 2015 year, it indicated 60 billion dollars in 2017, after a year it showed sharp increase and the volume was 89 billion dollars.

**TABLE 2 GLOBAL TOP 10 CROWD FUNDING BY COUNTRY IN 2019[15]**

Country	Rank	Volume(\$)	Market Share	Yearly Growth Rate
China	1	215,396,387,848	70,73%	-39,88%
United States	2	61,134,356,480	20,07%	42,93%
United Kingdom	3	10,367,889,408	3,40%	32,04%
Netherlands	4	1,806,298,624	0,59%	480,72%
Indonesia	5	1,451,228,928	0,48%	1711,43%
Germany	6	1,276,201,472	0,42%	92,90%
Australia	7	1,166,546,048	0,38%	1,57%
Japan	8	1,074,756,864	0,35%	208,26%
France	9	933,132,928	0,31%	26,98%
Canada	10	909,255,296	0,30%	4,80%

Above given table illustrates the Global top 10 crowdfunding by country. It is clear from the table that market share of crowdfunding is relatively high in China and it is equal to 70,73 % in numbers, 215,396,387,848 dollars. However, the growth rate of crowdfunding decreased to 39,88% in 2019 compared to the last year. Additionally, America is also one of the top countries which has great crowdfunding rate. Clearly, the amount of crowdfunding was 61,134,356,480

dollars and its market share was 20,07% in 2019 and indicated 42,93% yearly growth in that year.

## CONCLUSION

In conclusion, it can be said that innovators or entrepreneurs can use a crowdfunding platform, i.e. a web -based funding portal, to campaign and raise funds from a broad crowd including their social networks and the network of the portal. Entrepreneurs enjoy the obvious benefits of being able to access new funds that might not be otherwise available but they also enjoy non-pecuniary benefits such as feedback about their idea from the crowd and access to the skill set of contributors, who are often willing to lend a hand. The crowd enjoys access to products before they become widely available and become engaged and involved in the production process.

## REFERENCES

1. Based on the data of [www.crowdfunding.de](http://www.crowdfunding.de)
2. Teten, David, and Chris Farmer. 2010. "Where Are the Deals? Private Equity and Venture Capital Funds' Best Practices in Sourcing New Investments." *Journal of Private Equity* 14 (1): 32–52. doi:10.3905/jpe.2010.14.1.032.
3. Tyebjee, T. Tyzoon, and Albert V. Bruno. 1984. "A Model of Venture Capitalist Investment Activity." *Management Science* 30 (9): 1051–1066. doi:10.1287/mnsc.30.9.1051.
4. Agrawal, Ajay, Christian Catalini, and Avi Goldfarb. 2015. "Crowdfunding: Geography, Social Networks, and the Timing of Investment Decisions." *Journal of Economics & Management Strategy* 24 (2): 253–274. doi:10.1111/jems.12093.
5. Wong, Andrew, Mihir Bhatia, and Zachary Freeman. 2009. "Angel Finance: The Other Venture Capital." *Strategic Change* 18 (7-8): 221–230. doi:10.1002/jsc.849.
6. Schwienbacher, Armin. 2014. "Financing the Business." In *The Routledge Companion to Entrepreneurship*, edited by Ted Baker, 193–206. London: Routledge
7. Hornuf, Lars, and Armin Schwienbacher. 2014a. "Crowdinvesting–Angel Investing for the Masses?" In *Handbook of Research on Venture Capital*. Vol. 3: Business Angels. [http://papers.ssrn.com/sol3/Papers.cfm?abstract\\_id=2401515/](http://papers.ssrn.com/sol3/Papers.cfm?abstract_id=2401515/).
8. Cassar, Gavin. 2004. "The Financing of Business Start-Ups." *Journal of Business Venturing* 19 (2): 261–283. doi:10.1016/S0883-9026(03)00029-6
9. Rasmussen, Einar, and Roger Sørheim. 2012. "Obtaining Early-Stage Financing for Technology Entrepreneurship: Reassessing the Demand-Side Perspective." *Venture Capital* 14 (2–3): 77–89. doi:10.1080/13691066.2012.667908
10. Tomczak, Alan, and Alexander Brem. 2013. "A Conceptualized Investment Model of Crowdfunding." *Venture Capital* 15 (4): 335–359. doi:10.1080/13691066.2013.847614.
11. Based on the data of [https://ec.europa.eu/growth/tools-databases/crowdfundingguide/what-is/explained\\_en/](https://ec.europa.eu/growth/tools-databases/crowdfundingguide/what-is/explained_en/)
12. [www.p2pmarketdata.com](http://www.p2pmarketdata.com)
13. Based on the data of <https://www.crowdcru.com/crowdfunding-statistics-in-2020/>

**14.** Based on the data of [www.startups.com](http://www.startups.com)

**15.** Based on the data of <https://www.smallbizgenius.net/by-the-numbers/crowdfunding-stats/#gref/>



**ACADEMICIA**  
**An International**  
**Multidisciplinary**  
**Research Journal**  
 (Double Blind Refereed & Peer Reviewed Journal)

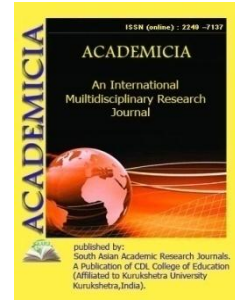

**DOI: 10.5958/2249-7137.2021.01041.7**

## FACTORS OF MORAL EDUCATION OF THE CHILD IN THE FAMILY

**Sheralievna Munavvar Abdullaevna\*; Babakeldieva Aziza Abdusamatovna\*\***

<sup>1,2</sup>Teachers of Termez State University,  
 UZBEKISTAN

Email id: sheraliyevamunavvar1984@gmail.com; bobokeldiyevaaziza@mail.ru

### ABSTRACT

*This article identifies preschoolers the role and influence of not only upbringing and heredity but also the social environment and the family in the development of the child's personality is highlighted. The environment of upbringing in the family depends, first of all, on the culture of family relations. , is a subtle aspect of family relationships, such as a deep sense of responsibility for one's duty. The family is the basis of human rights. Because in the first world the child sees, there is a relationship between parents and siblings, neighbors, cousins, and the child observes and studies them, during which he sees who is in what position.*

**KEYWORDS:** *Environment, Upbringing, Family, Child, Preschool Child, Behavior, Personality, Factors, Development, Psyche, Education, Age, Characteristics, Factors Influencing The Development Of A Preschool Child.*

### INTRODUCTION

The environment of upbringing in the family depends, first of all, on the culture of family relations. , is a subtle aspect of family relationships, such as a deep sense of responsibility for one's duty. The family is the basis of human rights. Because in the first world the child sees, there is a relationship between parents and siblings, neighbors, cousins, and the child observes and studies them, during which he sees who is in what position,

Raising children in the family in the spirit of devotion to their duty is closely linked with such qualities as responsibility, awareness, conscience. This is the basis for a sincere relationship between parents, close and friendly relations with their children, understanding of their future dreams and goals, the healthy development of children. A person has good behavior, habits and intelligence in the process of upbringing. if he has, he understands life lessons so well and does



good deeds, and conversely, the less educated he is, the less life skills he has, the more he sometimes commits bad deeds, knowingly or unknowingly.

After the independence of our country, radical reforms are being carried out in all spheres. In particular, in Uzbekistan, positive work is being done to strengthen families, provide them with social protection, bring up a harmoniously developed person, spiritually mature and physically healthy generation. In this regard, in accordance with the Resolution of the President of the Republic of Uzbekistan "On additional measures to increase the effectiveness of spiritual and educational work" No. PP-4307 dated May 3, 2019, guaranteed preparation of young people for independent living is based on gradual and uninterrupted education. In order to develop and implement the methodology, to guide young people to self-development as individuals, to educate them as broad-minded, active citizens, the "Concept of continuous spiritual education" was approved. The difference of this Concept from the previous one is that it is aimed at providing Human Capital capable of implementing the Action Strategy in citizens. This gives a clear purpose to the upbringing that has been common so far. The specific goal is to cultivate in young people clear, basic competencies and qualities. [1]

Accordingly, in our country, great attention is paid to the centuries-old national pedagogical traditions, the broad and rational use of universal values in the upbringing of children. Every parent is well aware of the need to raise their child diligently, every day, to be happy. However, they do not pay attention to the timely, continuous, continuous upbringing of their children from an early age. The main task of the family is to raise a healthy generation. After all, the priceless treasure of every nation and society is a healthy, spiritually harmonious family. [1].

In the current situation, the spiritual and moral relations in families, based on universal and national values, reflecting the Eastern moral features, are being established, and the legal, moral and spiritual foundations in families are improving. If a healthy moral environment, a culture of interaction, and a moral principle are not deeply rooted in the home, there will be a gap in the family, and negative situations will inevitably be resolved.

The importance of the family in the spiritual upbringing of the child is emphasized. Only when the parents' relationship with each other in the family on material, organizational, educational and personal issues is built on a pure, sincere, mutual respect and chastity towards the husband's wife, the wife will have a pure spiritual environment and harmony in the family. In the parental relationship, their kindness to each other, the same treatment of their children, therefore, the mistakes made in upbringing do not appear all at once.

Complications of improper upbringing appear many years later in the social problems caused by the human factor in society. The child is one of the highest blessings bestowed on man by Allah and is the successor of the parental life. Every blessing has its own gratitude, and the gratitude of a child's blessing is to give him a beautiful upbringing. It is scientifically based in one way or another in the sources of the blessed religion of Islam, in the works of all thinkers. The Prophet (peace and blessings of Allaah be upon him) said: "Parents cannot give their children anything better than good manners."

The word upbringing should not be narrowed down to the fact that the Prophet (peace and blessings of Allaah be upon him) said: "Every child is born in nature. His parents make him either a Jew, or a Christian, or a pagan." From this hadith, we know that the child will go the way he was guided.[3]. This means that the duty of a parent is not only to teach the child good

manners, but also to protect him from various ideologies and inhuman ideas. Because a child with a healthy faith and a correct ideology will grow up to be a kind and selfless person who is kind to his parents and loyal to his country. It is the duty of parents to bring up their children in a physically healthy and strong way. be faithful to religious traditions. It is well known that raising our children on the basis of good manners and good education is a topical issue at the national level.[1]

Children should be taught science from an early age. After all, a person who is interested in any field of science and creates information through reading and studying, will definitely be among the people who will benefit himself, his family, his people and his homeland. Not only they, but also the society is interested in making their child such a person.

The civic duty of parents requires the same. Therefore, every parent must first of all remember that he is educating the future life of the country, the future citizen - the parent himself plays an important role in the upbringing of the child. None of their wise teachings can replace their personal example. In the formation of the qualities of harmony in children, mutual harmony, honesty and truthfulness in the family, the existence of mutual trust, in general, a healthy environment are important. [2] In the family, it is important to love children, respect their identity, and never touch their self-esteem.

It is advisable that any care is carried out with insistence. Each family has its own traditions, which have a strong impact on the child's mind and behavior. arouses the feeling. [1]. Therefore, every parent should look for answers to such questions as how we bring up our children today, what is the family environment, in which the virtues of their ancestors flow. After all, the family is a place where the human qualities, noble desires, values and traditions develop from the youth of each person. All human qualities such as humanity, kindness, honesty, truthfulness, honor, modesty, diligence are formed first in the family. Thus, family upbringing has its own characteristics and influencing factors. Without taking these into account, it is impossible to put the upbringing of a child in a family in a good way. To do this, first of all, the parents themselves must be educated. The whole life of parents, their civic image, their spiritual world is the basis of a child's upbringing. Parents are already dear and holy to their children. [7]

Therefore, they imitate them and strive to be like them. Based on our national mentality, in the spiritual and moral upbringing of a child in the family, the formation of high moral qualities in them, positive actions, This means that education, environment and family are important for a person's development. At the moment we are looking for people like Alisher Navoi, Beruni, Farobi, Imam Bukhari and Khorezmi who lived and worked in the past, but we can't find them? Have we ever wondered why? The reason is that they are great and hereditary, their parents had a strong spirituality, science, enlightenment and progress reached their peak during their lifetime, that is, the environment was good and, most importantly, the parents and teachers responsible for the upbringing of our ancestors they performed their duties to the best of their ability and had no shortcomings in their upbringing. If we eliminate the shortcomings in these factors that affect the development of our children, we will surely emerge from the next generation of brilliant scholars like Imam Bukhari.[7]

According to the research of scientists, children who have been brought up by their mothers, who feel their care and compassion at every step, are completely devoted to public work differs from

the kids who are separated from their mothers and grow up to be healthier, smarter, more educated, and more cheerful.

A study in the United States found that more than half of those incarcerated were young people who were not fed up with motherly love. Indeed, the role of the mother in the family is of particular importance in the upbringing of children. No one can give a greater feeling of love to a child than a mother [6.]

In short, the role of parents and teachers is invaluable in the development of our youth in all respects, well-behaved, independent thinking and worldview, free from various negative habits, vices and influences. Demakit must be acknowledged from the above considerations that the social environment plays an important role in the development of any society and in the building of civil society. One of the main functions of the social environment is the behavior of the individual, a set of external objective factors that affect his development and a certain system, which in itself forms the capabilities of the individual, brings them to life. As a result, everyone represents a clear area of social activity and communication that is directly related to the life of society.

#### **REFERENCES**

1. "The concept of continuous spiritual education" Tashkent-2019.
2. Inomova K.M. "Spiritual and moral education of children in the family"- Tashkent: Fan, 1999
3. "Examples of Hadith on Morality." - Tashkent: Science, 1990
4. F.Kadirova, Sh.Tashpulatova, M.Azamova Preschool pedagogy, Tashkent-2019
5. O.Hasanboeva, D.Kholiqov. Family pedagogy-Tashkent, "Aloqachi" 2007, 32-35p
6. Usmonkhon Alimov, -Child upbringing in the family-Tashkent-2014, 32 pages
7. Internet information.

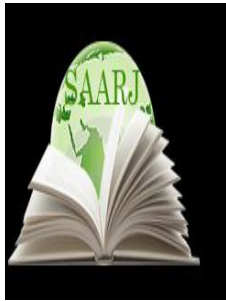

**ACADEMICIA**  
**An International**  
**Multidisciplinary**  
**Research Journal**  
 (Double Blind Refereed & Peer Reviewed Journal)

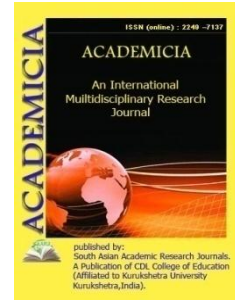

**DOI: 10.5958/2249-7137.2021.01047.8**

## MODERN WATER EQUIPMENT: DESIGN FOUNTAINS

**Rakhmatova Mekhriniso Murodovna\***

Teacher of "Landscape Design and Interior"  
 Department of Samarkand State Architectural and,  
 Sivil Engineering Institute, Samarkand, UZBEKISTAN  
 Email id: mexriniso.raxmatova@gmail.com

### ABSTRACT

*This report provides general information on world-famous water devices, including fountains, their various parameters and designs. Specific examples are the features of fountains and the latest modern technologies. For example, the idea for the Julie Penrou (Colorado Springs) fountain belongs to architects David Barber and Bill Burgess. The fountain consists of 366 water pipes that rotate once every fifteen minutes. Today, many architectural designers are creating new projects using world practice. And in the future these projects will be continued and more positive projects will be created.*

**KEYWORDS:** *Springs, Streams, Waterfalls, Pools, Ponds, Rivers, Lakes*

### I. INTRODUCTION

Water is an integral part of the natural landscape and plays an important role in the formation of the garden and park environment. Water in nature can take many different forms and situations. Colorful types of water devices can be used in gardens, parks, large areas, recreation areas and in front of various public buildings. Water plays a particularly important role in shaping the park environment. This is due to the fact that water lowers the air temperature, increases its humidity and has a significant effect on the microclimate in general. The aesthetic value of water and its physical properties are also very important here.

When using water as part of landscape design, you must try to fully and with a high aesthetic taste show all its natural properties. The natural properties of water are associated with its fluidity and colorlessness, its ability to take any shape and color, its ability to reflect images of surrounding objects and its sound. In landscaping gardens and parks, such forms of water as springs, streams, waterfalls, pools, ponds, fountains, waterfalls, rivers, lakes, and pools are used [1].

## II. MAIN PART

Landscape and park design, the use of water devices in public open spaces, the improvement of their scenic solutions have become topical issues of our time. At present, it is necessary to know and apply modern typology and technology of water facilities in the organization of greenery in hot and dry climates of the Republic.

Today in the world there are unique water devices related to the topography, which are not repeated, and they are created on the basis of scientific and technical achievements. Waterworks built in several cities of the United States, Japan, Korea, UAE, Austria, Sweden, Peru, Canada, Italy, Singapore, China, Spain are distinguished by their originality.

The water system in the United States was developed long ago. For example, the idea for the Julie Penrou (Colorado Springs) fountain belongs to architects David Barber and Bill Burgess. The fountain consists of 366 water pipes that rotate once every fifteen minutes. Although the facility is located far from the city center, it has always attracted people with its perfection and charm. Examples include the Keller in New York, the 71 Fountain in Ohio, the Corona in Chicago, and the Vaillancourt Fountain in San Francisco.

The Buckingham Fountain in Chicago is considered by many to be one of the most beautiful fountains in the world. It is a monument built in honor of Clarence Buckingham. The diameter of this fountain pool is about 85 meters, and the composition in the center of the pool, which rises 7.5 meters above the water level, is made of 3 layers of pink marble. 65,000 liters of water are pumped every minute from 134 pipes. In the evening, the fountain is illuminated with 840 lamps. This view is enjoyed by visitors to the Grand Park from April to October each year.

In Irving, Texas, the sculptural composition "Las Colinas Mustangs" (1981) is made of bronze, with a statue of 8 horses moving along the water. Water gushes from the horse's hooves when it hits the water, which helps the horses look like they are moving. In the evening the underside of the hooves is illuminated. This fountain is one of the largest sculptural compositions in the world.

Modern fountain devices are based on completely innovative technologies. In Charlotte, the 7.6-meter, 14-ton Metamorphoses fountain by Czech sculptor David Cherny consists of a constantly rotating, stainless steel plate with a male head. The speed of movement of the plates is controlled by the program. The fountain is a product of innovative technologies and reflects the image of a strong, ambitious human being [3].

The Bellagio Music Fountain is located in front of the Bellagio Hotel and is one of the most visited places in Las Vegas. The fountain was designed by Mark Fuller, an engineer at WET, California. His pipes move based on the sounds of classical music and pop ballads. The height of the fountain is 80 m, consisting of 1,175 pipes and 4,500 lamps[4].



Figure 1. Bellagio Music Fountain Figure 2. Floating Fountains (Osaka)

A similar musical fountain is located on an artificial lake of more than 12 hectares near the Burj Khalifa skyscraper in central Dubai. The fountain has a width of 275 m, a shooting height of 152 m, 6600 lamps and 25 projectors. The United Arab Emirates is one of the most developed countries in the world. The Volcano Fountain in Abu Dhabi is also impressive. Water flows like lava from a volcano-like tower. To enhance the effect, yellow light was used.

The tallest fountain is the King Fahd Fountain, built in Saudi Arabia. Its height is 312 m, 18 tons of water is thrown into the air per minute, water comes to the fountain from the Red Sea. Its base is designed in the form of a crown.

A number of modernized waterworks have also been built in Japan. In Osaka, Japanese architects discovered a new artificial waterfall called the Clock at the railway station. The waterfall not only lifts a person's mood, but also gives him pleasure, showing watery patterns in different looks and showing the time every minute. The waterfall flows through a large window. "Floating fountains" are widespread in Osaka. Such fountains were designed by Isamu Noguchi. A cube-shaped geometric body moving under strong water pressure in a recreational water basin is mounted on steel pylons. The light that illuminates the fountain device in the evening makes it look special.

We can see an antique pool in the XII Century Art Museum in Japan. This pool was created on the idea of the talented artist Leonardo Irlich. The secret of the pool is that it consists of 2 parts, which are separated by a mirror. The window is mounted above the pool, parallel to the water level. The height of the water above the window is 10 cm, and the bottom of the window is painted with aquamarine, the lower part of the pool is entered through a special path, where vacationers can easily walk, walk.

The world's longest fountain-bridge "Moonlight" (2009), which is included in the Guinness Book of Records, was built in Seoul, South Korea. The bridge consists of two floors, with water flowing from both sides of the upper floor. At night, they are illuminated by 10,000 LED lamps reminiscent of a rainbow of different colors. The length of the bridge is 1140 m, the water for the fountain is taken from the Hangang River and consumes 190 tons of water per minute. The fountain is equipped with 38 Grundfos pumps, the maximum water consumption for each pump is 420 m<sup>3</sup> / s. The water pressure is 810 m / s.

At the entrance to the Crystal Words Swarovski Museum in Wattens, Austria, a giant fountain in the direction of phytoplastics on a high hill depicts a treasurer with a green giant's head. His eyes are made of Swarovski crystals. When the fountain lights are turned on in the evening, the giant's eyes appear in a green crystal state. The museum is located under this hill.

Vortex fountain “Charybdis”, sunderlandThis original fountain was created in 2000 by sculptor William Pye for the luxury Seaham Hotel in England. According to Homer’s Odyssey, Charybdis was a mermaid who was hit by Zeus’ thunderbolt and transformed into a whirlpool as harsh punishment for stealing Hercules’ herd. Pye later carried on this concept building similar sculptures in Oman and Brazil[8].

The boat "Fountain" on the beach Malvarosa in Valencia, Spain, was built on the basis of skillful engineering ideas. Built of 6 metal constructions, this fountain shows the shape of a full boat when the water is thrown. In the evening the fountain is illuminated with a reddish light. A similar fountain is also available in Israel and Portugal. There is a red Crane Fountain in El Puerto de Santa Maria, Spain. A large amount of water flows out of a large water tap in the air and hides the pipe. In fact it moves water inside the pipe. The design of the fountain, though simple, does not fail to amaze. Similar fountains have been built in a number of cities in Spain, Belgium, the United States and other countries.

Another Guinness Book of World Records fountain is the Property Fountain in Santek, Singapore. The fountain was completed in 1998. The fountain device is made of bronze and the 4 supporting curved columns hold a ring-shaped structure, which symbolizes the unity, solidarity and equality of all races and religions in the country.

The Red Fountain in the UK is like a stepped garden. Once a year, that is, at the David Festival in March, it will have a special look. During the festival, the water of the fountain is given a red color as a symbol of the blood of the righteous.

Dacien Si is a 15,000-square-meter musical fountain in Dayanta Square, Xi'an, China. In the fountain area, 1024 pipe holes are installed in a regular sequence, allowing you to walk and walk freely through the vertical corridors. Foshan Falls in China consists of 10,000 old toilets[5].

The Fountain Park in Lima, Peru, is the largest fountain park in the Guinness Book of Records. The creation of the park was designed almost a hundred years ago. However, the construction of the park was completed in 2007 with the discovery of a new project on its territory. As a result of the project, the park has created the largest complex of fountains in the world, among which there are 13 different fountains, most of which are interactive. All the fountains are lit at night, some of them constantly changing colors. The largest fountain in the park is called the “Magic Spring” and is capable of lifting water over 80 meters. There is a “Tunnel Fountain” that connects the part of the park with other facilities for regular exhibitions.

The park has a "Fantasy Fountain", a musical fountain, a pyramid-shaped fountain, a children's fountain, phytoplasic fountains[6].

The Peterhof Grand Cascade in St. Petersburg is also the largest and most beautiful collection of fountains in the world. It was built in the 18th century and has 3 cascading staircases, 17 fountains, 29 bas-reliefs and 255 bronze statues[7].

In addition, thousands of beautiful and unique waterworks around the world have been built with high design skills. It takes a long time to describe them one by one.

### III. CONCLUSIONS AND RECOMMENDATIONS

In conclusion, we can say that the world's waterworks serve as a great practical example for our state. Today, many architectural designers are creating new projects using world practice. And in

the future these projects will be continued and more positive projects will be created. At our institute, a project of aqua parks and fountains has been created, and construction work is underway, studying the unusual fountains of the world.

#### **ACKNOWLEDGMENT**

The author wants to acknowledge and expand his sincerity (1) participants in this study; and (2) SamSASEI thanks to the professors and teachers.

#### **REFERENCES:**

1. Uralov A.S., Adilova L.A., Landshaftarxitekturasi. – Tashkent. 2014.
2. [www.openarium.ru](http://www.openarium.ru)
3. [travel.rambler.ru/guide/north america](http://travel.rambler.ru/guide/north-america)
4. [www.ew-fountains.com/bellagio](http://www.ew-fountains.com/bellagio)
5. [www.wonderfulnature.ru](http://www.wonderfulnature.ru)
6. [dosoaftor.ru/ghesafuentes/lima](http://dosoaftor.ru/ghesafuentes/lima)
7. [uznayvse.ru](http://uznayvse.ru)
8. <https://archibat.com/blog/en/10-most-amazing-fountains-in-the-world>



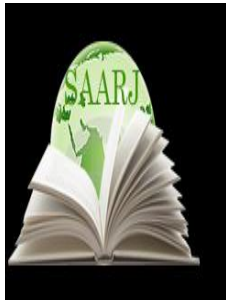

**ACADEMICIA**  
**An International  
 Multidisciplinary  
 Research Journal**  
 (Double Blind Refereed & Peer Reviewed Journal)

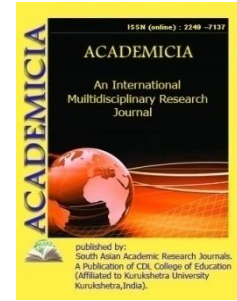

**DOI: 10.5958/2249-7137.2021.01048.X**

## IMPROVING THE STATUS, MOVEMENT AND OBSOLESCENCE ACCOUNT OF CONSTRUCTION MACHINERY

**O. Kh. Kholikulov\***

\*Basic doctoral student of Samarkand Institute of Economics and Service,  
 UZBEKISTAN

Email id: xox\_774@bk.ru

---

### ABSTRACT

*This article describes condition of existing construction machinery of construction companies operating in our country and ways to improve traffic accounting. It is important that any business entities operating in the country, including construction companies, accurately reflect the accounting and positively establish the control function. The direct revaluation method should be used to determine the current value of the equipment. In cases where the initial (replacement) value of fixed assets is revalued in accordance with paragraph 26 of NAS No. 5, their cumulative depreciation on the revaluation date is adjusted to the relevant change indices in the initial (replacement) value of fixed assets.*

**KEYWORDS:** *Construction Organizations, Accounting, Construction Works, Construction Machinery, Construction Machinery Movement, Accounts Chart, Construction Machinery Condition.*

---

### INTRODUCTION

The large-scale reforms implemented within the state program framework "Action Strategy" on the five main priorities of the country's development in 2017-2021 are also giving result in the construction companies' activities. In particular, it was adopted a radical reform of the construction industry, the widespread introduction of modern foreign experience in construction practice on the basis of national and international standards, and most importantly to ensure the accuracy, reliability and information transparency on the status, movement and accounting of construction machinery, a number of normative and legal documents. In particular, the following tasks play a key role in the state program, i.e.:

- ✚ removal of obsolete and not used in practice technologies and machines in the estimate documents preparation, revision in the introduction of market mechanisms. [1]

As noted in Presidential address of the Republic of Uzbekistan Sh.M.Mirziyoev to the Oliy Majlis on December 29, 2020, "Over the past 4 years, serious steps have been taken to introduce market mechanisms in all our economy sectors. The task now is to lay the foundation for long-term sustainable growth through deep structural reforms". [2]

**Literature analysis.** Accounting plays an important role in the construction companies activities in the Republic of Uzbekistan, taking into account the condition and movement of construction machinery. It is important that any business entities operating in the country, including construction companies, accurately reflect the accounting and positively establish the control function. According to the Law of the Republic of Uzbekistan "On Accounting", accounting consists of a regulated system of collection, registration and generalization of accounting information through a complete, continuous, documentary accounting of all business transactions, as well as the preparation of financial and other reports. [3]

It is known that many economists and researchers of our country have conducted direct research in the construction machinery, i.e. in the scientific research in the fixed assets structure in the activities of construction companies.

Economists of our country N.A. Makhmudova [4] have developed theoretical and practical skills on the operation of direct lifting machines and equipment in a cyclic mode, and the mutual kinematic scheme and the position and movement of structural cranes and loaders, features of construction machinery i.e. their description of road construction machines in quality use have scientifically substantiated by T.I. Askarhojaev, Kh.N. Dimitov, R.O. Shukurov, A.O. Ikramov, S.I. Ibrokhimov, Z.O. Maksudov, M.T. Umirov [5], K.B. Urazov [6] contributed to the vast practical and theoretical knowledge and skills harmonization in the basic accounting basis substantiation in all accounting operations substantiation in construction organizations operating throughout the country. Today, many international and national procedural principles are being studied in theoretical and practical aspects of accounting for machinery and equipment in construction companies and improving their condition, movement accounting<sup>1</sup>.

**Research methodology.** As a result of this research, systematic analysis, accounting methods were used to study the construction machinery state and movement in construction organizations on the basis of international standards.

**Analysis and results.** The status and movement of existing construction machinery in the construction companies operating in the country, as well as their receipt and sale is an important treatment for the construction company. Therefore, it is expedient to pay special attention to the construction companies operations on the income and expenditure of construction machinery.

"SUFAT I D" LLC construction company purchased a crane XCMG QY25K5-C (EURO-5) from "NAVOI PROM GRAND" LLC at 1,612,210,000 soums cost (as of the date of registration of the customs cargo declaration). The amount of the accumulated exchange rate difference is 10,000,000 soums. It is advisable to record these transactions in the following accounting records.

**TABLE 1<sup>2</sup> REFLECTION OF OPERATIONS RELATED TO THE IMPORT OF FIXED ASSETS (CONSTRUCTION MACHINERY) IN THE ACCOUNTING RECORDS**

№	The content of the business transaction	Amount, (thousand	Correspondence*		The basis document
			debit	credit	

		soums)			
1.	Construction machinery was purchased for a fee	1 612 210,0	0820	6010	contract, invoice
2.	Construction machinery was introduced	1 612 210,0	0100	0820	act
3.	According to the additional agreement, the construction machinery will be provided free of charge	1 612 210,0	6010	8530	contract, act
4.	The exchange rate difference was reflected as income	10 000,0	6010	9390	contract, calculation

When fixed assets (construction machinery) are put into operation, their value is reflected in the correspondence with the account 0820 on the account debit 0130 "Machinery and equipment". When concluding an additional agreement on the transfer of equipment free of charge, its initial value must be reflected in the account 8530 - "Property received free of charge." When closing the account 6010 "Accounts payable to suppliers and contractors" on the date of the additional transaction, the balance of the accumulated exchange rate difference in the account 9390 - "Other operating income" should be reflected as income.

In the existing construction organizations operating in the country, the use of specific methods based on the accounting functions in the construction machinery sale is important. In construction organizations, fixed assets (construction machinery) can be reduced due to their sale, liquidation, free transfer, included in the cost of the facility and other costs. These transactions are reflected in the account with the following accounting transfers.

**TABLE 2<sup>3</sup> ACCOUNTING FOR TRANSACTIONS ON THE EXPENDITURE OF FIXED ASSETS (CONSTRUCTION MACHINERY) IN CONSTRUCTION ORGANIZATIONS**

№	The operation content	Amount	Correspondence* [7]		The basis document
			Debit	Credit	
<b>Sale of fixed assets (construction machinery)</b>					
1.	Sale value of fixed assets (construction machinery) (without VAT)	600 000,0	4010	9210	Contract, invoice
2.	To the amount of VAT (if the enterprise is a VAT payer and subject to taxation). VAT rate is 15% <sup>4</sup> . (600 000,0*15/115)	78 260,9	4010	6410	Contract, invoice
3.	To the initial value of the main engine (construction machinery)	500 000,0	9210	0130	Contract, invoice
4.	Write-off of accumulated depreciation of fixed assets (construction machinery)	120 000,0	0230	9210	Contract, invoice

5.	Write-off of revaluation reserve	80 000,0	8510	9210	Accounting
6.	Profit from sales	300 000,0	9210	9310	Form 2
7.	Damage from sales	-	9430	9210	Form 2

Based on the data in the table above, it is advisable to implement fixed assets (construction machinery) in any business entities activities, including construction companies. It should be noted that on the basis of the data in Tables 1-2, the fixed assets expression features (construction machinery) in the accounts of profit (9310) or loss (9430) as a result of income and expenditure are highlighted.

“SUFAT I D” LLC has technological equipment for the liquid concrete production with a recovery cost of 1,393,702,013 soums. Its obsolescence is 100%, the residual value is zero. The equipment is in good condition and is used in the production of liquid concrete products. The equipment was evaluated by an independent appraiser to adjust its value to market prices and to make a realistic calculation of the produced liquid concrete product cost. According to the appraisal act, the market residual value of this equipment on the appraisal date is 1,200,047,119 soums. It is important for the construction organization to reflect the change in this equipment value in accordance with NAS 21. In this regard, it is necessary to pay special attention to the fact that this change is the organization income and the tax consequences.

According to paragraph 45 of NAS № 5 "Fixed assets"<sup>5</sup> which is one of the existing by-laws in the country, the useful life of fixed assets can be revised by the enterprise, taking into account the costs that improve the condition of fixed assets and, consequently, prolong service life. “SUFAT I D” LLC should extend the useful life of the equipment and make appropriate changes to the technical documentation. The direct revaluation method should be used to determine the current value of the equipment. In cases where the initial (replacement) value of fixed assets is revalued in accordance with paragraph 26 of NAS No. 5, their cumulative depreciation on the revaluation date is adjusted to the relevant change indices in the initial (replacement) value of fixed assets. Depreciation is then calculated from the revalued amount. Since only the residual equipment value (the difference between the initial value and the obsolescence amount) is specified in the appraisal act, determine the initial value of the equipment and the amount of obsolescence on January 1, 2020 by calculation for revaluation according to NAS № 5 and NAS № 21 should.

Since “SUFAT I D” LLC does not provide information on the "old" and "new" service life of the equipment, we offer the **following method** of calculating its initial cost and the amount of depreciation.

**1. On the revaluation date**, the construction machinery obsolescence degree is determined as a percentage. It is equal to the sum of the service periods divided by the newly defined service life and multiplied by 100% until the full depreciation of the equipment and then the revaluation date.

**The obsolescence rate of the construction machinery at the revaluation date<sup>6</sup>** is calculated using the following formula, i.e.:

$$QMM_{bed} = \frac{X_m + O'd}{U_m} \times 100\% \quad [1]$$

Here,

$X_m$  - service life;

$O'd$  - depreciation period;

$U_m$  – extended term.

**1-Case.** The service life of depreciated equipment has been extended from 20 to 35 years. 2 years and 3 months have elapsed since its full depreciation until January 1, 2020. Equipment obsolescence rate on 1.01.2020:

This is calculated as follows.

$$(20 + 2,25) / 35 \times 100 \% = 63,6 \%$$

**2. The initial value of the construction machinery** is equal to its residual value according to the appraisal act divided by 100 on the revaluation date and 100 times the difference in the equipment obsolescence level.

The initial value of the construction machine<sup>7</sup> is calculated by the following formula, i.e.:

$$QMM_{qb} = \frac{Qq}{100 - Ed} \times 100\% \quad [2]$$

Here,

$Qq$  – residual value;

$Ed$  – obsolescence rate.

**2-Case.** According to the appraiser, the residual value of the equipment is 1,200,047,119 soums. Its depreciation rate is 63.6% in 1.01.2020. We calculate the initial value of the equipment on the same date:

$$1\ 200\ 047\ 119 / (100 - 63,6) \times 100 = 3\ 296\ 832\ 745 \text{ soums.}$$

**3. The amount of obsolescence revaluation date** is multiplied by its depreciation level, divided by 100, equal to the initial value of the equipment on the revaluation date.

The amount of depreciation of a construction machine<sup>8</sup> is calculated using the following formula, i.e.:

$$QMM_{es} = \frac{Bq \times Ed}{100} \quad [3]$$

Here,

$Qq$  – residual value;

**Ed** – obsolescence rate.

**3-Case.** On January 1, 2020, the initial cost of the equipment is 3,296,832,745 soums, its obsolescence rate is 63.6%. Determine the amount of obsolescence:  $3\,296\,832\,745 \times 63,6 / 100 = 2\,096\,785\,626$  soums.

After determining the initial value and the amount of construction machinery obsolescence revaluation account № 21 NAS and on January 1, the annual revaluation of fixed assets is carried out on the basis of standard accounting entries in accordance with the Regulations<sup>9</sup> on the procedure for conducting revaluations. The difference between the amount of additional equipment assessment of "SUFAT I D" LLC between the starting price on January 1, 2020 and 1 393 702 013 soums, the amount of additional obsolescence assessment of the equipment will be the difference between the amount of obsolescence on January 1, 2020 and 1,393,702,013 soums.

The result of the equipment revaluation is reflected in the accounting with the following entries:

Debit 0130 – to the sum of the additional valuation of the initial value of the equipment;

Credit 0230 – to the amount of additional assessment of equipment obsolescence;

Credit 8510 - to the amount of the difference between the amount of the additional assessment of the initial value and the amount of equipment depreciation.

According to Article 355 of the tax code, equipment value revaluation is not considered the enterprise income and is not taxed.

## CONCLUSIONS AND SUGGESTIONS

In addition, on the basis of the above operations in the construction organizations and construction products production, we would like to note the following as suggestions and recommendations:

- clarification of management and financial accounting data on the construction machinery description and classification;
- assistance in determining the real state of construction machinery;
- ensuring timely and accurate operations reflection on the condition and movement of construction machinery in the accounting and reporting;
- to be the basis for providing accurate information to internal and external users on the condition, movement and obsolescence of construction machinery;
- to create a basis for timely calculation and payment of tax on the condition, movement and obsolescence of construction machinery.

In conclusion, based on the above information, accounting serves as a key factor in ensuring the continuous implementation of the control function.

## REFERENCES

1. Presidential Decree of the Republic of Uzbekistan PD-4947 on February 7, 2017 "On the Action Strategy for the further development of the Republic of Uzbekistan". Issue 28 (6722) on the newspaper "People's Word" on February 8, 2017.

2. Presidential Address of the Republic of Uzbekistan Shavkat Mirziyoev to Oliy Majlis. 29.12.2020.
3. Law of the Republic of Uzbekistan "On Accounting" (new edition). Article 4. 2016, April 13, Approved by DRU-404. <https://lex.uz/docs/2931253>.
4. N.A. Makhmudova "Repair of construction machinery and equipment." Curriculum for Vocational Colleges. T.: "New edition".2007.11-p.
5. T.I. Askarhojaev, H.N. Dimitov, R.O. Shukurov, A.O. Ikramov, S.I. Ibrokhimov, Z.O. Maksudov, M.T. Umirov "Use of road construction machines".Textbook.-T.: "Publisher".2011.6-p.
6. Urazov K.B. "Features of accounting in other industries.", Textbook.-T.:2019.
7. \*№21 NAS "Plan of accounting of financial and economic activities of business entities and the Instruction on its application" on 31.05.2017 (revised new edition).



**ACADEMICIA**  
**An International  
Multidisciplinary  
Research Journal**  
**(Double Blind Refereed & Peer Reviewed Journal)**

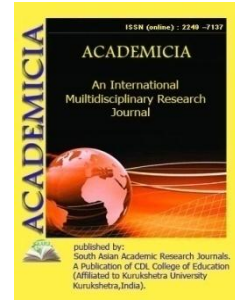

**DOI: 10.5958/2249-7137.2021.01049.1**

## **ROADS, ROAD LINES AND THERMOPLASTIC PRODUCTS USED IN THEIR DRAWING**

**Shukurov M.M\*; Nurdinov M.A\*\*; Hudoyazarov N.B\*\*\*; Ismoilov R.I\*\*\*\***

\*Senior Lecturer,  
Andijan Machine Building institute,  
Andijan, UZBEKISTAN

\*\*Assistent,  
Andijan Machine Building institute,  
Andijan, UZBEKISTAN

\*\*\*Student,  
Andijan Machine Building institute,  
Andijan, UZBEKISTAN

\*\*\*\*Student,  
Andijan Machine Building institute,  
Andijan, UZBEKISTAN

### **ABSTRACT**

*The development of transport communications and the improvement of their use is one of the most pressing tasks in the development of the economy. In fact, the share of domestic goods in the transport of goods in the country is the share of roads shows that roads are one of the key factors in the development of the economy of the republic. The use of lanes determines certain modes and procedures for the movement of vehicles and pedestrians. Road lanes are a means of visual guidance for drivers and play an important role in increasing the speed and through put of vehicles and ensuring road safety.*

**KEYWORDS:** *Economic Development, Transport Communications, State Road Policy, Highways, Highway Users, Road Lines, Alkyd Or Acrylic Paints, Thermoplastics.*



---

## INTRODUCTION

### Main part

The priorities of the state road policy are the creation of international transport corridors that ensure the conditions of economic development of the country, ensuring reliable transit and inter-regional transport links, the formation of a single integrated transport environment of the republic, the restoration of the Great Silk Road and access to world markets. marked as The practical solution of these tasks requires improving the quality of transport and operation of the existing road network, adapting the technical and operational conditions of roads to the needs of road users, ensuring the comfort and safety of traffic, effective organization of road maintenance [1].

Speaking of "Motor Roads", the purpose of the Law of the Republic of Uzbekistan "On Motor Roads" dated 29.07.2007 is to regulate relations in the field of design, construction, reconstruction, repair, maintenance and operation of highways.

Highway - a set of engineering structures designed for the movement of vehicles, ensuring their continuous and safe movement at a specified speed, weight, size, as well as the land allotted for the placement of this complex and the space within the specified range above the complex [2].

The classification of the appendix to the Resolution of the Cabinet of Ministers of the Republic of Uzbekistan "On improving the organization and quality control of construction and operation of roads" dated 29.07.2007, public roads, inter-farm rural roads, cities, urban settlements, villages and defines the types and structure of repair and maintenance of aul streets (hereinafter referred to as "highways") and the basis for substantiating the use of funds, forecasting the cost of repair and maintenance of roads and road structures and the organization of road works is calculated.

Road diagnostics is a key element in the system of collecting information on the condition of roads and includes determining the technical condition of roads in the period under review, forecasting the technical condition of the road after a certain period, identifying the primary causes of defects on roads.

Roads in the Republic of Uzbekistan are classified as follows:

Public highways;

Streets of cities and other settlements;

Farm highways [3].

The constant proliferation of vehicles and the operation of asphalt pavements in aggressive conditions of external factors lead to the appearance of various defects and, as a result, premature deformation and deterioration of roads. Most of the defects are primarily due to the specific physical, mechanical and rheological properties of the organic binder used. The use of modified additives that affect its structure and properties and, consequently, improve the quality of road-building compositions, allows to regulate the properties of bitumen.

Along with highways, lanes also play an important role in ensuring road safety.

Edward N. Hines (Edward N. Hines, 1870-1938), a member of the Wayne County Road Commission in Michigan (USA), is the inventor of road lines. In 1911, Woodward Avenue in

Detroit proposed the use of the world's first road line to split the flow of traffic in the middle of a concrete road. [4].

Ten years later (in 1921) the first British road markings appeared in the English town of Sutton Coldfield (on the outskirts of Birmingham). This experience in improving road safety has been very successful, and later white road lines became the standard in the UK and many other countries. [5].

For some time, different options have been used for road signs in different countries. In Germany, for example, black marks were used in the 1930s, which were later rejected as ineffective. Nowadays, black is used in conjunction with white when vertical symbols are used.

In the 1930s, the British Percy Shaw invented cataphats ("cat's eyes"), a device that reflected light even in the dark, and these catapults were widely used by drivers in the UK during the dark hours of the day during World War II.

In the 1950s, Elbert Daysart Botts, an expert in paint chemistry at Caltrans (California Department of Transportation), used paint containing glass beads to improve the appearance of road lines. At the same time, the light-reflecting elements in the line began to rise to a quarter of the way (about 6 mm) so that the water layer covering the road line would not worsen the view. At the same time, if the driver did not notice the lanes, he felt the shocks as the car wheel crossed the raised lanes, in this way the "lanes" begin to warn drivers that they are crossing the lane.

Botts was invented by former student Herb Rooney in the 1950s as a durable adhesive epoxy resin on the road with a special nail with the addition of ceramic or plastic markers. Since 1966, markers called Botts-Dots have been used on U.S. roads and later in other parts of the world. [6].

In 1955, the first peripheral noisy (road lane) lanes appeared in New Jersey. Today, they are widely used in many countries, including the United States, Canada, Finland, Norway, Sweden and others. [7].

With the increase in traffic on highways, vertical lines have also been used to block dangerous sections of roads, to identify sudden obstacles.

At the same time, road lines are widely used in gas stations, underground and above-ground parking lots, as well as in the territory of airports in neighboring areas outside the roads.

Road lanes can be permanent or temporary. In all countries, white paint is used for permanent road lines. Yellow paint is used for temporary road lines, and such colors mainly indicate parking lots for vehicles and taxis on the route, as well as places where parking or parking is prohibited.

It can be applied with yellow (Germany, Estonia), orange or red (Austria, Switzerland) paints when drawing permanent road lines and is used in traffic repair and reorganization.

Permanent and temporary road lines can be drawn at the same time, when using temporary road lines, it is usually applied with a paint with a short shelf life, when the repair work is completed, the road line itself is erased or removed by road service personnel.

Noisy road lanes (noise lanes) are used to draw attention, especially at emergency pedestrian crossings, to show the edges and subdivisions of federal roads. This marking method allows the tired driver to "Trigger" and also reminds them to slow down the car. [8].

Relevance of the case. The use of lanes determines certain modes and procedures for the movement of vehicles and pedestrians. Road lanes are a means of visually guiding drivers and play an important role in ensuring road safety, increasing the speed and throughput of vehicles, and in conditions that are not sufficiently visible.

Currently, the marking of roads is carried out using paints, cold and hot plastics, polymer tapes, materials using traditional and new technologies. Studies show that the design and performance efficiency of horizontal road signs depends on the drying time (thermoplastic) of the paint, its recovery, adhesion coefficient and abrasion resistance. To ensure traffic safety, horizontal lanes should be visible at any time of the day and easily recognizable (understandable) to drivers of vehicles.

The most budget and most common option for marking with road lines are acrylic and alkyd paints, in other words, these are acrylic or alkyd resin-based paints containing organic solvents with the addition of coloring pigments and targeted additives.

Acrylic and alkyd paints are used for marking concrete, asphalt and petroleum bitumen coatings. They provide the coating with a separate coating. Other advantages of this type of marking material include:

- good meteorological stability, including abrupt changes in temperature and high humidity;
- resistance to chemicals, abrasives and mechanical damage.

Alkyd or acrylic marking paints are applied without a compressor (using a sprayer) or in a pneumatic manner. For road lines, it is advisable if the air temperature is above 20 degrees Celsius, and the paint dries in 5 minutes.

Road thermoplastic is a granular mixture of thermoplastic resins, plasticizers, pigments and various target additives. It is designed for drawing road lines on asphalt and concrete pavements. To draw road lines on roads, thermoplastics are placed on the pavement using a special machine in the form of a solution. The melting temperature of thermoplastics requires a temperature of 170-200 degrees. Excessive heat should be avoided, as this can cause the thermoplastic to crack or turn yellow. In order for the paint to solidify in a short time (10 minutes), it is advisable that the air temperature is above 10 degrees and the air humidity is at least 80%.

For better adhesion of thermoplastics to concrete, the road surface should be cleaned before applying thermoplastics. Paint for this type of road sign is applied only to dry surfaces. In areas with large temperature differences, cracks may appear after the application of thermoplastics.

To increase the visibility of the marking line, light-reflecting particles reflecting the appearance of microscopic balls are added to the thermoplastic for marking. It is recommended to apply a layer of quartz sand to the markings before coating with thermoplastic to enhance the grip of the car tires on the road.

Thermoplastic road signs have clear advantages over alkyd and acrylic paints. First, it's a long-lasting coating. Second, thermoplastics do not contain solvents and volatiles, which means that the negative impact on the environment is minimized.

Thermoplastics are a mixture of a hard resin plasticizer (30 2%) and an inorganic pigment fraction (70 3%). Petroleum polymer paint and varnish resin is used as a binder, POD oil

(oxidation and dehydration products, waste from caprolactam production) is used as a plasticizer. becomes a mass.

Thermoplastic is used in the molten state for marking road markings (drawing a safety line), which is done using road marking machines. The cost of drawing a safety line is 8-10 kilograms of thermoplastic granules per 1 square meter of asphalt-concrete road with a thickness of 3-5 millimeters of coating.

Cold plastic, unlike thermoplastic, all components of the mixture are in a liquid state and the solvent is added separately before drawing.

Cold plastic is the most modern and reliable, and the advantages of this type of material over thermoplastics for road signs include:

- high resistance to friction of car tires with spikes;
- good adhesion to asphalt, as well as concrete after its initial cleaning;
- Installation (drawing) of thermoplastics on the road does not require the use of separate techniques, cold thermoplastics can also be done by hand.

Cold plastic, as well as the thickness of the line after laying the thermoplastic is 1.5-3 mm, and even in summer the material has excellent weather resistance. A hot air temperature of 0 to 40 degrees is suitable for cold plastic laying.

This material does not contain thermoplastics as well as solvents or other volatile substances, making it environmentally friendly for the workers and the environment in which it is installed. It is only applied to a dry surface at a temperature not lower than 0 degrees.

## CONCLUSION

Road strips made of thermoplastic and cold plastics are modern methods of marking on the road surface, they are used more economically, have a high level of environmental friendliness and ensure almost perfect teething of car tires on the road. These advantages allow these two types of lanes to be used on any highway. As a result, it plays an important role in ensuring road safety and preventing road traffic accidents.

## REFERENCES:

- 1 Resolution of the President of the Republic of Uzbekistan No. 535-PQ of December 20, 2006 "On measures to develop the construction of public roads in 2007-2010";
2. Law of the Republic of Uzbekistan "On Motor Roads" No. 117-ZRU, dated October 2, 2007;
3. Resolution of the Cabinet of Ministers of the Republic of Uzbekistan No. 226-K "On improving the organization and quality control of construction and operation of roads", 01.11.2006;
4. Edward N. Hines (1870—1938);
5. Douglas V. Jones: The Royal Town of Sutton Coldfield — A Commemorative History, Westwood Press 1994, ISBN 0-9502636-7-2;
6. Точки жизни: Дорожная разметка // Популярная механика : Журнал. — 2010. — Ноябрь (№ 97);

7. Yushkov VS European, Western and Russian experience of using noise strips [Text / VS Yushkov, VI Kychkin] // Young scientist: journal. - 2014. - No. 21. - S. 253-255;
8. Osipov V.A. World experience in the use of milled noise strips on the road surface and the prospects for its application in Ukraine (Russian) // rusnauka.com: archive of scientific publications.

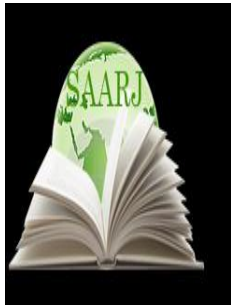

**ACADEMICIA**  
**An International  
 Multidisciplinary  
 Research Journal**  
 (Double Blind Refereed & Peer Reviewed Journal)



**DOI: 10.5958/2249-7137.2021.01055.7**

## NATIVITY VS FACTORS TOWARDS EMPOWERMENT- T TEST

**Dr. S. Valli Devasena\***

\*Assistant Professor,  
 Department of Commerce, Mother Teresa Women's University,  
 Kodaikanal, INDIA  
 Email id: devasena69@gmail.com

### ABSTRACT

*Empowerment is a multi-dimensional social process that helps people gain control over their own lives communities and in their society, by acting on issues that they define as important. Empowerment occurs within sociological, psychological economic spheres and at various levels, such as individual, group and community. Empowering women puts the spotlight on education and employment which are an essential element to sustainable development. One of the powerful approaches to women empowerment and entrepreneurship is the formation of Self Help Groups (SHGs) especially among women's SHG is conceived as a sustainable people's institution that provides the poor women with space and support necessary for them to take effective steps towards achieving greater control of their lives. Women played various managerial and non-managerial roles in the decision making process. Women constitute one- half of the segments of population in India and women are vital and productive workers in Indi's national economy. Hence an attempt is made to analyse whether there is any significant difference between Nativity and Factors towards empowerment.*

**KEYWORDS:** *Empowerment, Women, Nativity, Factors Of Empowerment*

### 1. INTRODUCTION

Micro Finance is emerging as a powerful instrument for poverty alleviation in the new economy. In India, micro finance scene is dominated by Self Help Groups (SHGs) – Bank Linkage Programme, aimed at providing a cost effective mechanism for providing financial services to the “unreached poor”. Based on the philosophy of peer pressure and group savings as collateral substitute , the SHG programme has been successful in not only in meeting peculiar needs of the

rural poor, but also in strengthening collective self-help capacities of the poor at the local level, leading to their empowerment.

Micro Finance for the poor and women has received extensive recognition as a strategy for poverty reduction and for economic empowerment. Increasingly in the last five years, there is questioning of whether micro credit is most effective approach to economic empowerment of poorest and, among them, women in particular. Development practitioners in India and developing countries often argue that the exaggerated focus on micro finance as a solution for the poor has led to neglect by the state and public institutions in addressing employment and livelihood needs of the poor.

## 2. REVIEWS OF LITERATURE

**Kabeer (1991)<sup>1</sup>** Empowerment signifies increased participation in decision-making and it is this process through which people feel themselves to be capable of making decisions and the right to do so.

According to **Emma Zapata (1991)<sup>2</sup>** empowerment is power within and can be expressed in different ways, such as a chance to negotiate as a group, to share power, to get the support of other organisations, to look for outside support, all building up power in positive way.

According to **Sankar Chatter Jee (1993)<sup>3</sup>** empowerment through group strategy is multi faced process which encompasses many aspects enhancing awareness increasing the access to resources economic and social. An equally component is the mobilization and organization of women into groups. The group strategy provides the required basis for solidarity strengths and collective action among the women. Empowerment is also linked to issues of social justice and equality.

**Sakunthala Narashimhan<sup>4</sup>**, The author focuses on the positive aspects of the empowerment such as economic, social, political and psychological empowerment and the author concludes that to empower women with hope and enthusiasm in the inner layers of their psyche (mind) and thousands of women, irrespective of the educational achievements or economic status, women show their determination as useful and productive citizens who are eager to contribute their mite to the national effort.

**Mayoux, (1993)<sup>5</sup>** has identified three ‘paradigms’ on micro-finance and gender. The ‘financial self-sustainability paradigm’, currently dominant within most donor agencies and USAID, World Bank, UNDP, etc. assumes that increasing women’s access to micro-finance services will lead to individual economic empowerment, well-being and social and political empowerment.

**Punithavathy Pandian and Eswaran (2005)<sup>6</sup>** argued that the economic empowerment of poor women is the only way for poverty eradication. Because increased access to financial resources enables poor women to increase their employment and income in the petty business that has local demand and also based on local resources.

Microfinance, according to **Otero (1997)<sup>7</sup>** is the provision of financial services to low-income poor and very poor self-employed people. These financial services, according to **Ledgerwood (1997)** generally include savings and credit but also include other financial services such as insurance and payment services.

**K.K.Kundu, K.S.Suhag, U.K.Pandy and Kusum Jain (2001)**<sup>8</sup> in their article, “sustainable Micro Financing through SHGs in Gurgaon district (Haryana)”, pointed out that through SHGs the poor had developed courage and confidence and served as decision makers SHGs inculcated the habit of savings among women.

### 3. Statement of the Problem

In India, 93 per cent of all workers are self employed. Women constitute more than half of this workforce. More than 96 per cent of women workers are self employed. Self employed workers are those who earn a living through their own small business or through their own labour. Unlike workers in the organised sector, they do not obtain a regular salary. These workers are characterised by insecure employment, low incomes, lack of capital assets, lack of access to institutional support and social security benefits, leading to an extreme level of poverty. The women generally vendors, home based workers such weavers, garment makers, food processors and craft people, manual labour and service providers such as agricultural labourers, construction workers, rag pickers domestic workers and cart-pullers.

One of the powerful approaches to women empowerment and entrepreneurship is the formation of Self Help Groups (SHGs) especially among women's SHG is conceived as a sustainable people's institution that provides the poor women with space and support necessary for them to take effective steps towards achieving greater control of their lives. Also create awareness about health and hygiene, sanitation and cleanliness, environmental protection, importance of education and better response to development schemes. Through SHGs they are provided credit and extension support for various production oriented and income generating activities. Also Micro finance for the poor and women has received extensive recognition as a strategy for poverty reduction and for economic empowerment.

The impact of microfinance in Kodikanal is a subject worthy of serious examination for a number of reasons. In kodaikanal there are ample opportunities for entrepreneurial development. Most of the women here are poor and earn for livelihood through self employed activities. If they are supported financially by affordable schemes like Micro Finance to sustain their life, they can concentrate more on their employment activities and slowly they could become an better entrepreneur.

Against this backdrop, the present study has been carried out to assess the impact of micro-finance on socio-economic status of women.

### 4. Objectives

- To analyse whether there is any significant difference between Nativity with respect to empowerment

### 5. METHODOLOGY

The present study depends on both Primary and Secondary data. Primary data is based on the survey method. To facilitate the survey, Interview schedule was constructed as optional type as well as in Likert's five point scale. The optional type is aimed at information search and other details of the respondents. The likerts five point scale is applied to seek the opinion of the respondents regarding opinion, satisfaction and expectations. Interview schedule was used to



know the perceptions of the respondents regarding their socio economic details, empowerment factors, micro finance provision.

Survey is conducted among the Self Help Group Members in Kodaikanal. The Stratified Random sampling technique adopted. The selection process is given below

This study was intended to analyse the role of SHGs in the promotion and development of the women members. For the purpose of analysis, the study was designed with a comprehensive profile.

Kodaikannal is divided into

- Kodaikannal Municipality and
- Kodaikannal Union

In Kodaikannal Municipality, we have

➤ Wards : 24

In Kodaikannal Union we have,

- Panchayat Union : 01
- Town Panchayats : 01
- Panchayats : 15
- Firrkas : 03
- Villages : 16
- Hamlets : 81

Table 1 shows the details relating to total no. of SHGs in Kodaikannal Municipality

**TABLE 1 TOTAL NO. OF SHGS IN KODAIKANNAL MUNICIPALITY**

TOTAL NO. OF SHGS IN KODAIKANNAL MUNICIPALITY									
S.NO	WARD NO	D MI	G.TRU ST	MM S	SMIL E	CHANA RD	KODAI KURU NJI	MUNICIPAL ITY	TOT AL
1	1	5	5	5	1	2		8	26
2	2		6		5	5		8	24
3	3	8	2		5	7		4	26
4	4	10	6	2	6	8	1	5	38
5	5	5		1	3	5	4	2	20
6	6		1	4	1	6		2	14
7	7	1		1	2	7		1	12
8	8	1	1	2	2	5		3	14
9	9	2	15	1	2	12	4	4	40

10	10	18	16	1	2	18			<b>55</b>
11	11	5	2	1	1	3			<b>12</b>
12	12	6	1	2	2	10			<b>21</b>
13	13	5	1	1	4	9		1	<b>21</b>
14	14	3	2	7	5	5		6	<b>28</b>
15	15	6	1	8	2	14		6	<b>37</b>
16	16	7	5			1		5	<b>18</b>
17	17		16	4	1	1		2	<b>24</b>
18	18	5	18	2	3	4		6	<b>38</b>
19	19	8	17	2	2	1		2	<b>32</b>
20	20	2	2	2		1		1	<b>8</b>
21	21	8	6	2	3	2			<b>21</b>
22	22	3	11	7	1				<b>22</b>
23	23	14	1	8	3	4		1	<b>31</b>
24	24	2		13	1	18			<b>34</b>
	<b>TOTAL</b>	<b>124</b>	<b>135</b>	<b>76</b>	<b>57</b>	<b>148</b>	<b>9</b>	<b>67</b>	<b>616</b>

**Selection of panchayat-**The Union-wise and panchayat-wise details of the Self Help Groups are maintained systematically by the taluk administration. The details regarding thrift, loans, and the number of NHGs, which are updated monthly was collected. As the number of SHGs is definite, the population can be known. Hence, the researcher resorted to Random Sampling Technique. In Kodaikanal, more than 1200 self help groups are functioning. These self help groups were stratified and on basis of stratification sample, respondent groups were selected.

There are 24 wards in Kodaikannal Municipality and 132 wards in Kodaikannal Union. In these wards, there are approximately 1200 SHGs. Each ward is given equal weightage. Out of these SHGs, 1 SHG from each ward is selected as sample. So, totally 120 SHGs were selected. (i.e. 10% of the total population). The researcher contacted the sample SHGs and requested the SHGs to conduct a survey with the required number of members. On the recommendation of the animator, the survey was conducted with the members. Thus, sampling was done scientifically and survey was carried out according to the research norms without prejudice and bias.

## 6. Tools used for Analysis

To analyse, the objectives framed, percentage, Mean Standard deviation and t test are used.

## 7. Analysis of the study

The analysis consists of two parts I Profile of the sample respondents and II their empowerment level before and after access of micro credit.

## i) Profile of the Respondents

TABLE 3

Sl.No	Particulars	Classification	No of Respondents	Percentage
1	Age	Below 30	61	14
		30-40	266	59
		Above 40	123	27
		<b>Total</b>	<b>450</b>	<b>100</b>
2	Marital Status	Married	370	82
		Divorce	48	11
		Widow	32	7
		<b>Total</b>	<b>450</b>	<b>100</b>
3	Educational qualification	Illiterate	175	39
		Literate	275	61
		<b>Total</b>	<b>450</b>	<b>100</b>
4	Nativity	Rural	307	68
		Urban	143	32
		<b>Total</b>	<b>450</b>	<b>100</b>

## II Analysis of the Study

*Null Hypothesis*

There is no significant difference between Education with respect to empowerment

TABLE 4.3.6 T TEST FOR SIGNIFICANT DIFFERENCE BETWEEN EDUCATION WITH RESPECT TO EMPOWERMENT

Empowerment of women		Education				t value	P value
		Illiterate		Literate			
		Mean	SD	Mean	SD		
Economic Empowerment	Before	23.23	4.78	24.20	4.70	2.109	0.035*
	After	37.13	4.89	36.77	4.73	0.786	0.432
Social Empowerment	Before	15.38	5.41	17.43	6.04	3.647	< 0.001**
	After	39.66	5.12	39.32	5.05	0.706	0.481
Decision making Empowerment	Before	21.10	4.36	21.73	3.77	1.631	0.104
	After	31.41	3.76	30.87	4.16	1.373	0.170
Familial /Interpersonal Empowerment	Before	25.83	3.61	27.36	3.12	4.754	< 0.001**
	After	36.05	3.95	35.44	3.73	1.656	0.098
Psychological Empowerment	Before	20.15	4.47	22.47	4.08	5.639	< 0.001**
	After	35.06	4.20	35.21	4.47	0.359	0.720
Overall Empowerment	Before	105.71	15.67	113.19	13.31	5.419	< 0.001**
	After	179.31	17.60	177.61	17.70	0.997	0.319

Note: \*\* Denotes significant at 1per cent level

\* Denotes significant at 5per cent level

Since P value is less than 0.01, the null hypothesis is rejected at 1 percent level of significance with regard to Social empowerment, Familial empowerment, Psychological empowerment, overall empowerment before joining SHGs. Hence there is significant difference between Illiterate and Literate with respect to Social empowerment, Familial empowerment, Psychological empowerment and overall empowerment before joining SHGs. Based on mean score, the Illiterates have better overall empowerment after joining SHGs than literate. Since P value is less than 0.05, the null hypothesis is rejected at 5 percent level of significance with regard to Economic empowerment before joining SHGs. Hence there is significant difference between Illiterate and literate with respect to Economic empowerment before joining SHGs. Based on mean score, the Illiterates have better Economic empowerment after joining SHGs than literate.

There is no significant difference between Illiterate and literate with regard to Economic empowerment, Social empowerment, Familial empowerment, Psychological empowerment, overall empowerment after joining SHGs, and with regard to Decision making empowerment before and after joining SHGs, since P value is greater than 0.05. Hence null hypothesis is accepted at 5per cent level with respect to after joining SHGs of Economic empowerment, Social empowerment, Familial empowerment, Decision making empowerment, Psychological empowerment and overall empowerment.

#### *Null Hypothesis*

There is no significant difference between Education with respect to other factors towards empowerment

**TABLE 4.3.7 T TEST FOR SIGNIFICANT DIFFERENCE BETWEEN EDUCATION WITH RESPECT TO OTHER FACTORS TOWARDS EMPOWERMENT**

Factors towards Empowerment of women	Education				t value	P value
	Illiterate		Literate			
	Mean	SD	Mean	SD		
Benefits of Education	52.65	5.16	51.31	5.61	2.534	0.012*
Satisfaction with training programme	25.76	3.35	25.46	3.33	0.832	0.406
Satisfaction towards the Empowerment	32.39	4.56	31.28	4.52	2.535	0.012*
Problems at work place	13.84	1.79	13.71	1.90	0.749	0.454
Problems at homes	15.87	3.33	15.18	3.28	2.182	0.030*
Problems at marketing	29.51	3.33	29.25	3.19	0.839	0.402
Overall Problems of Micro Finance	59.23	6.14	58.13	6.23	1.827	0.068

Note: \* Denotes significant at 5per cent level

Since P value is less than 0.05, the null hypothesis is rejected at 5 percent level of significance with regard to Benefits of Education, Satisfaction towards empowerment and Problems at homes. Hence there is significant difference between Illiterate and literate with respect to Benefits of Education, Satisfaction towards empowerment and Problems at homes. Based on mean score, the Illiterates of various factors towards empowerment are better than literate. There is no significant difference between Illiterate and literate with regard to Satisfaction with training programme,

Problems at work place, Problems at marketing and overall problems of micro finance, since P value is greater than 0.05. Hence null hypothesis is accepted at 5per cent level with respect to various factors of Satisfaction with training programme, Problems at work place, Problems at marketing and overall problems of micro finance.

### SUGGESTIONS AND CONCLUSIONS

A process in which women challenge the existing norms and culture, to effectively promote their well being is known as women empowerment. The participation of women in Self Help Groups (SHGs) made a significant impact on their empowerment both in social and economic aspects. This study examines Women Empowerment in Self Help Group through micro finance.

As we know that women in our country have a respectable place in the society. But after six decades of independence, the situation of women is very severe in the rural and backward areas. Women constitute around fifty percent of the total human resources in our economy. Yet women are the more poor and under privileged than men as they are subject to many socio-economic and cultural constraints. Women development activities must be given importance to eradicate poverty, increase the economic growth and for better standard of living. Self Help Group (SHGs) is small credit cooperatives, usually all poor and all women.

Empowerment results in a change in the balance of power, in the living conditions and in the relationships. To achieve this, women must be free to decide about their income and should gain self-confidence.

### REFERENCES

1. Ganapathi R., *“Consumers attitude and preferences towards self help group products”*, Asian pacific Research Review, Vol:4, Issue No:2,2008.
2. Kalaiselvi., *“A Study of a Micro Credit Programme run by Self-Help Groups in Tamilnadu State, India”*, Journal of Finance and Management in Public Services, Vol: 9, Issue No: 2, 2012.
3. Krishnaveni and Haridas ., *“SHGS and its Marketing Problems”*, Global Journal of Human Social Science Economics, Vol:13, Issue No:4,2013.
4. Mehta Slil and Dinkar Rao, (1987), Studies on *“Self Help Groups of the Rural Poor from Maharashtra and Gujarat, Pune”*, NIBM.
5. Anand S.Jaya (1990) *“Micro finance in Kerala”* Kurushetra August, Vol.40 (11); pp. 10-21.
6. Agarwal Deepti (1991), *“Empowerment of Rural women in India”*, Social welfare vol. 48(4) P.10.
7. Suliman.M and Multanyatta.J.N.S, *“Women in development, the case of Botswana”* Research Report of Institute for African Alternatives, London, 1991, pp.164-168.
8. Emma Zapata Martelo (1991), *Modernization, Adjustment & Peasant Production- A Gender Analysis*.
9. Ajai Nair, Paper on *Sustainability of Microfinance Self Help Groups in India: Would Federating Help?*

10. Kabeer N (1991), “**Conflicts Over Credit: Re-evaluation the Empowerment Potential of Loans to Women in Rural Bangladesh**”: World Development, Vol.29, No.1.
11. Rajammal P.Devadoss, (1991), “**Globalization and an Introductory Note**” Quarterly Journal of Social Sciences Vol. xxiv (1-4), December, P.11.
12. Mayoux, L. 1993. **From vicious to virtuous circles? Gender and micro-enterprise development**. Occasional Paper No. 3, UN Fourth World Conference on Women UNRISD, Geneva.
13. Chatterjee Sankar (1993) “**Networking SGSY Banks and SHGs Initiatives in Uttarpradesh**” Kurushetra, February, Vol No 51(4), PP 27-29.
14. Raja Sekar. D, “**Savings and credit system for the poor-some NGO Experiences**” Netherlands organization for international development co-operation (NOVIB) and Humanistic Institute for co-operation with developing countries (HIVDS) Bangalore.
15. Sri Latha, B. (1994), **the meaning of womens Empowerment. New concepts from action in Health Empowerment and Rights, Harward School of Public Health Boston.**
16. Puhazhendi. V, (1994); “**Transaction cost of lending to the Rural poor NGOs and SHGs of the poor as Intermediaries for Banks in India**” The foundation for development corporation, Australia. Brisbane.
17. Rajasekar.D. (2000), **Micro finance programmer and Women’s Empowerment; A study on Two NGOs from journal of Social and Economic development vol No.1 Jan-June pp 76-94.**
18. Yaron, Jacob, “**What Makes Rural Finance Institutions Successful**”. The World – 1994.



**ACADEMICIA**  
**An International**  
**Multidisciplinary**  
**Research Journal**  
 (Double Blind Refereed & Peer Reviewed Journal)



**DOI: 10.5958/2249-7137.2021.01050.8**

## INVESTMENTS AND PROMOTION IN THE TRANSPORT SECTOR

**Masharipov Masudjon Numonjonovich\***; **Allamuratova Munira Saidmurotqizi\*\***;  
**Nazirov Nozimjon Nodirjonogli\*\*\***

\*PhD, Dean of the Faculty of Economics,  
 Tashkent State Transport University,  
 UZBEKISTAN  
 Email id: masudcha@mail.ru

\*\*Student of the Faculty of Economics,  
 Tashkent State Transport University,  
 UZBEKISTAN  
 Email id: amunira2211@gmail.com

\*\*\*Student,  
 Tashkent State Transport University,  
 UZBEKISTAN  
 Email id: nozimjon.nazirov.99@mail.ru

### ABSTRACT

*The article examines the large-scale reforms carried out in the transport sector of our country, the provision of logistics and transport services in high-quality and competitive conditions to all sectors of the economy and all segments of the population, in the near future, the effectiveness of the implementation of investment and innovation programs, as well as a significant contribution to sharpening the economic potential countries.*

**KEYWORDS:** *Investment, Trend, Communication, Innovative Development.*

### INTRODUCTION

Transport is a critical area where all digitalization indicators must drive growth. In particular, the issues of electronic control and regulation of transport, increasing the speed of transport and logistics work, reducing the level of environmental pollution by transport, ensuring road safety are considered. The formation of a system of "intelligent transport" on the basis of the widespread introduction of ICT in the transport sector should become the most important direction of the strategy of medium and long-term development of our country. Modern trends in

economic development and ongoing reforms indicate that, taking into account the geographical location of the Republic, the formation and implementation of a unified transport policy aimed at ensuring the quality and popularity of transport services, is of particular importance in the implementation of modern technologies and management systems in this area. In recent years, our country has been implementing a wide range of measures aimed at developing transport and transport communications, ensuring a high level of transport safety, improving the management system in the transport industry, and training qualified specialists for this industry.

In order to radically improve the public administration system in the field of transport, increase the investment attractiveness and export potential of the Republic, ensure the strategic development and sustainable operation of transport communications, as well as, in accordance with the tasks set out in the action strategy for five priority areas of development of the Republic of Uzbekistan for 2017- 2021, on the basis of the Uzbek Agency for Road Transport, by the decree of the President of the Republic of Uzbekistan No. PF-5647 "On measures for the development of road transport in the Republic of Uzbekistan", the Ministry of Transport of the Republic of Uzbekistan was created. This is the first strategic document in the history of independent Uzbekistan, which sets out the main directions of the country's long-term transport policy.

One of the most important reforms in the transport sector is the liberalization of the transport services market, the gradual reduction of state monopolies and restrictions, the provision of large facilities based on the principles of public-private partnership with foreign investors on favorable terms.

In particular, the introduction of the "Open Skies" regime, which provides for "Airspace" of the fifth level in the regions and international airports of the Republic of Karakalpakstan, as well as "Airspace" at the international airports of Navoi and Termez from August 1, 2020 for foreign airlines, creates the basis for the entry of potential investors into the air transportation market in our country. Despite serious obstacles and risks for the implementation of investment projects in the context of a pandemic in the transport system, systematic work is underway on projects planned for January-June of this year. In particular, in 2020, the second stage of the Yunusabad line of the Tashkent metro (2.9 km.), The first stage of the land ring of the metropolis in the city of Tashkent (11.4 km.) Was completed, railway station Andijan-Savay-Khanabad (65 km.), construction and installation works on modernization projects have been completed. In addition, as a result of research carried out in the field of the transport system, the results of the implementation of projects identified in the investment programs amounted to 131 percent of the state budget funds for roads and 99 percent of the work performed in connection with the plan for investment projects, within the framework of 5 investment projects financed by at the expense of the federal budget., Two projects are being implemented under the system of JSC "Airports of Uzbekistan". Projects "Construction of the Samarkand International Airport". Samarkand airport receives \$ 62 million. As a result of research carried out in the field of the transport system, the results of the implementation of projects identified in the investment programs amounted to 131 percent of the state budget funds for roads and 99 percent of the work carried out in connection with the plan for investment projects, within the framework of 5 investment projects financed from funds federal budget., Two projects are being implemented under the system of JSC "Airports of Uzbekistan". Projects "Construction of the Samarkand International Airport". Samarkand airport receives \$ 62 million. As a result of research carried



out in the field of the transport system, the results of the implementation of projects identified in the investment programs amounted to 131 percent of the state budget funds for roads and 99 percent of the work carried out in connection with the plan for investment projects, within the framework of 5 investment projects financed from funds federal budget., Two projects are being implemented under the system of JSC "Airports of Uzbekistan". Projects "Construction of the Samarkand International Airport". Samarkand airport receives \$ 62 million. within the framework of 5 investment projects financed from the federal budget., Two projects are being implemented under the system of JSC "Airports of Uzbekistan". Projects "Construction of the Samarkand International Airport". Samarkand airport receives \$ 62 million. within the framework of 5 investment projects financed from the federal budget., Two projects are being implemented under the system of JSC "Airports of Uzbekistan". Projects "Construction of the Samarkand International Airport". Samarkand airport receives \$ 62 million.

To date, several projects have been implemented to introduce universal transport systems (ITS) in the transport sector, in particular, this year, from January 1, in the state office of the city of Tashkent (bus and metro), an automated electronic payment system has been introduced, a mobile application "atto" has been launched for making payments through the "QR code", an automated online system for the distribution of foreign multilateral forms of permits was launched in order to create an automated information system based on the "Atto" system. In order to create more comfortable conditions for passengers, a unique Uztrans portal has been created, which allows online purchase of tickets for buses, rail and air transportation,

According to the "Action Plan for the Development of Digitalization Technologies in the Sphere of Transport and Road Facilities" of the Republic of Uzbekistan, a total of 61 projects are planned to be implemented, of which 38 projects are planned to be implemented in 2020, 13 projects in 2021 and 26 projects in 2022.

### Information on disbursed investment funds for 2020<sup>1</sup>

№	Инициатор номи	Лойиҳа сони	Умумий қиймат	01.01.2020й. ҳолатига қолдиқ	2020 йил ўзлаштириш прогнози		шу жумладан 1-чорак	
					млн. долл.	млрд. сўм	млн. долл.	млрд. сўм
	<b>ЖАМИ, шу жумладан:</b>	<b>135</b>	<b>6 447,7</b>	<b>3 236,8</b>	<b>997,5</b>	<b>10 054,6</b>	<b>259,0</b>	<b>2 610,8</b>
	Давлат бюджети	106	1 619,8	901,0	201,4	2 029,7	22,2	224,3
	Давлат қаролати остидаги хорижий инвестициялар		2 085,4	808,9	354,7	3 575,4	122,7	1 236,9
	Тикланиш ва тараққиёт фонди		723,5	128,8	94,9	956,3	44,9	452,3
	Тўғридан-тўғри хорижий инвестициялар		197,5	121,6	56,7	571,3	11,2	112,9
	Ўз маблағлари		1 659,8	1 185,4	198,8	2 004,1	32,9	331,2
	Тижорат банклари кредитлари		160,6	91,1	91,1	917,8	25,1	253,4
<b>1</b>	<b>«Ўзбекистон темир йўллари» АЖ</b>	<b>24</b>	<b>4 240,0</b>	<b>1 999,0</b>	<b>496,6</b>	<b>5 005,3</b>	<b>79,8</b>	<b>804,1</b>
	Давлат бюджети	4	671,8	233,3	42,7	430,0	8,0	80,2
	Давлат қаролати остидаги хорижий инвестициялар		1 145,2	344,5	118,1	1 190,2	13,6	136,9
	Тикланиш ва тараққиёт фонди		490,3	94,9	61,0	614,9	11,0	110,9
	Тўғридан-тўғри хорижий инвестициялар		197,5	121,6	56,7	571,3	11,2	112,9
	Ўз маблағлари		1 655,4	1 184,7	198,1	1 997,3	31,7	319,5
	Тижорат банклари кредитлари		79,7	20,0	20,0	201,6	4,3	43,7
<b>2</b>	<b>«Кўприқурилиш таъмирлаш дирекцияси» УК</b>	<b>3</b>	<b>8,4</b>	<b>8,4</b>	<b>8,4</b>	<b>85,0</b>	<b>1,0</b>	<b>10,0</b>
	Давлат бюджети	3	8,4	8,4	8,4	85,0	1,0	10,0
<b>3</b>	<b>Автомобиль йўллари қўмитаси</b>	<b>105</b>	<b>1 570,5</b>	<b>1 016,6</b>	<b>279,8</b>	<b>2 820,1</b>	<b>15,3</b>	<b>154,2</b>
	Давлат бюджети	99	939,6	659,3	150,3	1 514,7	13,3	134,1
	Давлат қаролати остидаги хорижий инвестициялар	6	630,9	357,3	129,5	1 305,4	2,0	20,2
<b>4</b>	<b>«Uzbekistan airways» АЖ</b>	<b>1</b>	<b>545,7</b>	<b>141,7</b>	<b>141,7</b>	<b>1 428,0</b>	<b>141,7</b>	<b>1 428,0</b>
	Давлат қаролати остидаги хорижий инвестициялар		309,3	107,1	107,1	1 079,8	107,1	1 079,8
	Тикланиш ва тараққиёт фонди		233,2	33,9	33,9	341,4	33,9	341,4
	Ўз маблағлари		2,2	0,7	0,7	6,8	0,7	6,8
<b>5</b>	<b>«Uzbekistan airports» АЖ</b>	<b>2</b>	<b>83,1</b>	<b>71,1</b>	<b>71,1</b>	<b>716,2</b>	<b>21,3</b>	<b>214,7</b>
	Тижорат банклари кредитлари		80,9	68,9	68,9	694,0	20,8	209,7
	Ўз маблағлари		2,2	2,2	2,2	22,2	0,5	5,0

The introduction of advanced information technologies for the digitization of the entire transport system, the development and implementation of strategies for the further development of a single interconnected system of the transport system of the Republic of Uzbekistan

Increasing the level of innovative development of the transport system, the development of digitalization processes for all types of transport, the policy of stimulating the innovative development of the transport system and its individual components is the most important component of the state transport policy. It dresses up to solve most of the tasks facing the transport system and all its components, without increasing the level of innovation and without introducing modern digital technologies. In the proposal, the formation of large statistical databases (Big Data), an increase in the volume and quality of transport services, the formation of a modern market for passenger, freight, transport and logistics services, improvement of the planning and forecasting system of traffic based on access to the World Wide Web, ensuring the safety of space, transport and other types of transport. At the same time, the transport sector is not only a consumer of software services, new information and communication technologies and equipment, but also serves as a locomotive of demand for the development of these services and can be one of the driving factors in the development of the national ICT sector.

The main directions of increasing the innovative development of the transport industry are:

- a) introduction of a system of support for innovative technologies and training of research personnel by the Ministry of Transport of a unified and wide scope of scientific and technical policy of the transport industry;
- b) develop and promote the production of transport and logistics technologies, rolling stock, technical means and systems that ensure an increase in the throughput and quality of transportation of goods and passengers;
- c) creation and implementation of modern transport systems to improve the quality of passenger and freight traffic, as well as the introduction of modern information and telecommunication technologies and highly efficient brand and logistics technologies using global navigation systems GPS and GLONASS, vehicles and flow control technologies;
- d) Form a legislative and regulatory framework that will facilitate the introduction and digitalization of innovative technologies for the entire network of passenger and freight traffic.

In recent years, systemic reforms have been carried out in targeted areas, such as reducing the state monopoly on transport, introducing modern principles of corporate governance in industries and enterprises, implementing new initiatives in public-private partners, digitalization, Foreign Trade Management, membership in international transport and logistics systems. Also, certain work is being carried out to increase the investment attractiveness of the transport industry, expand the circle of investors, and implement mutually beneficial cooperation with foreign partners. Specifically, Uzbekistan ranked 99th in the Logistics Performance Index maintained by the World Bank, which includes the Logistics Performance Index (LPI). The report covers 168 countries measuring supply chain performance, providing access for local companies to national and international markets. LPI will also focus on emerging issues such as supply chain stability, environmental impact and the need for skilled workers.

**If we consider the index by its components, then Uzbekistan occupies:**

Customs procedure	140th place
Infrastructure	77th place
International transportation	120th place
Item tracking	90th place
Delivery period	91st place

Active and decisive measures are also being taken to remove obstacles to integration into the world community. Enhancing the country's image in the international arena is one of the topical issues of developing models of trade, economic, investment and social development, strengthening ties with leading international analytical and research institutions, as well as business associations around the world.

**Promising projects included in the 2020 investment program<sup>2</sup>**



№	Таъбиқаси ном	Ўқувчи қилини	Ўқувчи	Ўқувчи
<b>Ўқувчи</b>				
43	Ўқувчи			5 773,3
10	"Ўзбекистон темир йуллари"			2 320,1
1	Ўқувчи	30,5 км	2022-2023 й.	104,8
2	Ўқувчи	450 км	2022-2024 й.	50,0
3	Ўқувчи	33,5 км	2022-2024 й.	154,6
4	Ўқувчи	4 км	2020-2023 й.	175,7
5	Ўқувчи		2022-2024 й.	Ўқувчи
6	Ўқувчи		2022-2024 й.	Ўқувчи
7	Ўқувчи		2022-2024 й.	Ўқувчи
8	Ўқувчи	196,1 км	2022-2027 й.	175,5
9	Ўқувчи	103,7 км	2022-2027 й.	180,0
10	Ўқувчи		Ўқувчи	1 520,0
<b>AO "Uzbekistan airports"</b>				
1	Ўқувчи		2021-2022 й.	Ўқувчи
2	Ўқувчи		2021-2023 й.	470,0
<b>Ўқувчи</b>				
29	Ўқувчи			2 983,4
1	Ўқувчи	92 км	Ўқувчи	184,0
2	Ўқувчи	23 км	Ўқувчи	50,0
3	Ўқувчи	37 км	Ўқувчи	104,0
4	Ўқувчи	25 км	Ўқувчи	50,0
5	Ўқувчи	41 км	Ўқувчи	85,3
6	Ўқувчи	40 км	Ўқувчи	80,3
7	Ўқувчи	43 км	Ўқувчи	86,3
8	Ўқувчи	52 км	Ўқувчи	114,4
9	Ўқувчи	54 км	Ўқувчи	109,0

**REFERENCES:**

- Gromova E.I., Voronkova E.K. Deoffshorization as a way to counteract shadow financial flows // Economics and Entrepreneurship. 2016. No. 12-3 (77). S. 145-149.
- Finogenoea Yu. Yu. Financial management of banking and insurance companies // Financial management. 2005. No. 2. P. 54.
- <http://invest.gov.uz/ru/investor-taxonomy/transportnyj-sektor/>
- Kosoe M.E. Formation of sustainable economic development of countries through the sphere of innovation // Education. Thescience. Scientific personnel. 2016. No. 4. P. 116-120.

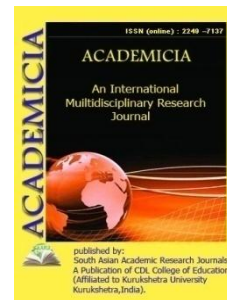

DOI: **10.5958/2249-7137.2021.01051.X**

## INTERPRETATION OF HISTORICAL EVENTS IN THE WORK OF MUKIMI

**Kuldosh Pardaev\***

\*Associate Professor,  
Doctor of Philological Sciences,  
State University of Uzbek Language and Literature,  
Tashkent, UZBEKISTAN  
Email id: kuldashparda@mail.ru

### ABSTRACT

*Much work has been done in the years of independence to study the literary heritage of educated authors who lived and worked in the Kokand literary environment during the late XIX and early XX centuries, but still, the fact that there are much work waiting for researchers to be explored, is also true. One of such authors, Muhammad Aminhoja Mirzakhoja's son Mukimi's life and creative legacy, has not ever been studied in a monographic way in the years of independence as it has not been objectively and thoroughly explored in the context of communist ideology. Therefore, there is a need for a comparative-textual study of the manuscripts of Mukimi and to re-examine the works of the poet and poems that are gathered based on modern achievements in textual and literary sources. Various lyrical and comic books in different sizes of Mukimi have been interpreted differently. It is also important to note that these interpretations are often far from the real nature of the text and are based on certain narrow templates. Therefore, there is a great need to study poet's poetry as an example within the issues of the textual interpretation. In the late XIX and early XX centuries, the commentary on the work of Kokand literary circles was also invaluable in explaining the historical events of the period. In this respect, the interpretations of Mukimi's literary heritage are of particular importance in the study of the literary-aesthetic world of the poet.*

**KEYWORDS:** *Histories, Poet, Interpretation, Line, Gazelle, Stophe, Editing, Literary Environment, Edition, Manuscript, Poems, Style, Turkistan.*

## INTRODUCTION

Although the study of Mukhimi's work began in his lifetime, the literary heritage of the poet has not been studied in terms of the history and editing of the text. Oriental studies began mainly with the publication and popularization of the works of the poet Mukimi. For instance, his lyrical poetry and satirical poems were published in the Turkestan Gazette (annual editions in the years 1891-1903-1907).

N. Ostroumov gave examples of the regular comic works of Mukimi in the IX collection of «Notes of the Eastern Branch of the Imperial Russian Archaeological Society» published in St. Petersburg in 1894. After that, N. Ostroumov sorted Mukimi's works, and in 1907 he wrote «Devoni Muqimiy», Muhammad Qasim Doda Muhammad's son «Devoni Muqimiy ma hajwiyyat» (1910-1912) for two times, and ordered Abdulqadir Khodandi to publish the collections by the pressing printing method «Bayoz ma hajwiyyat Mawlano Muqimiy ma Mawlano Furkat». It is known that the literary heritage of the poet attracted the attention of researchers in the XX of the last century. A serious study of the poet's work began in the 30s of past century. The poet Gafur Ghulam stood at the origins of this work. At his initiative, the «Muqimiy bayozi» was created and published in 1938. Several scientific articles, collections<sup>1</sup> and monographs devoted to Mukimi's life and his creative heritage have been published. The doctoral dissertation of Professor G. Karimov, entitled «The Uzbek democrat poet Mukimi and the literature of his time», occupies a special place in the field of contemporary studies of Mukimi.

## MATERIALS:

Mukimi's «Collection of Works» and «Selected Works», as well as the manuscripts and other sources, including materials of the Central State Archives of the Republic of Uzbekistan and poetic works in the manuscript funds. manuscripts 7521, 1325, 7688, 9309, 49.4100, copied by the poet, kept at the Abu Rayhan Beruni Institute of Oriental Studies and the Gafur Gulom Museum of Ferghana Literature, have been proven to be an important source.

## DISCUSSION:

At the end of the 19th and the beginning of the 20th century, the history of the representatives' works of Kokand literary environment is valuable as it clarifies the historical events at that time. Particularly, one of the well-known authors in Kokand's literary heritage, the history of Muhammad Aminhodja Mukimiy's works is important. The poems written by the poet on various events can be grouped as follows:

- 1) Signs written on people's death;
- 2) Histories on the construction of buildings and structures;
- 3) Writings on historical events.

Signs written on the people's deaths. In poet's five distichous elegy written in Tajik named "The Favtites of the Fate of the Nation", Inomkhodja Umarchodjaev's fate and death who was Tashkent's noble and participated in a popular uprising in Tashkent in 1892, is mentioned.

Sar zi hayrat barkashidu guft aql

Khojai In`om, sad afsus, murd

*Translation:*

He began to shudder,

Unfortunately, Ho'ja Ab'yom died.

Muqimiy's love to Inomkhodja Umarhodjaev who opposed to the policy of Russian monarch, was explicitly expressed in the historical elegy. "Though he wailed in the prison, he was killed. On the day of his death, all the people of Kokand, olds and young, were mourning," - says in elegy. [1].

According to Hijri count, 1322 appears from the second line of the distich. According to the gesture of the distich, the first letter of the word "admiration" in the first line is the value of "h", so as if the number 8 is taken away from 1322, distinction is 1314. This is the year in when Inomhodja died with the account of Hijri. If we convert it into modern year, the year 1897 will be appear. So, Inomho'ja Umarhojaev died in 1897 [2]. Professor G. Karimov tried to find out evolution of Mukumiy's creative works and said his opinions about the poem beginning like this:

Bahri fazoil ichra ichra erdi chu durri maknun

Ohir falak, darigo, tufroqqa kildi madfun

"... in the problem the Hijri count of the words which show the history is 1287 Hijri, 1870-1871. Thus, Mukumiy was interested in the genre of "Muammo" and in the late 1970s he continued his own experiments in this genre," - he says. It should be noted that this poem does not appear in the publications of Mukumiy's works. In the manuscript 7521, written with the Mukumiy's handwriting, it comes in the

form of 6 distiches:

Bahri fazoil ichra chu durri maknun,

Oxir falak, darig'o, tufroqqa qildi madfun.

Ul kun musibatidin aylandi subh shoma,

Guyo bo'lub qiyomat, oqillar o'ldi majnun.

To Besharig' mardum ko'zdin oqizdi selob,

Xosu avom yig'lab chun lola diyda purxun.

Farqi saridin ajrab, taslim aylayub jon,

Bo'ldi topib shahodat, Haq rahmatig'a maqrun.

Piri xirad, Muqimiy, favtining ta'rixichun,

Yetti karomatidin ko'nlig'a ushbu mazmun:

Ot shatta soldi nogah, doril fanodin, afsus,

Ketti "shifo" topolmay "Eshon xoja Tursun". [4]

Prof. G. Karimov considers the history in this poem as Hijri 1287, the year 1870-1871 which consists of the sum of the letters in the utterance "От шатта солди ногаҳ". In essence, the history is "Eshon Hoja Tursun", denomination of 1693. According to the indication at beginning of the line, the sum of the letters "keti", "shif", is equal to 381.

When it descended from the number 1693, the year 1312 Hijri occurs. When we turn it into modern-year-count, it's equal to 1894. Thus, Mukumiy's friend from Beshariq, Eshon Hoja Tursun died in 1894.

#### ANALYSIS:

Mukumiy's seven-distich poem dedicated to the death of Abdurahman Margilaniy has not published his collection of works. The text of poem is found in the manuscript bayaz, which is kept in A.Madaminov's personal library. The 5th, 6th, 7th distiches of the poem.

Men ham ayyomi vafoti bor edim,

Boshlarimg'a tushdi guyo kulfati.

Solini so'rdim, Muqimiy, g'aybdin,

Guftigo' bo'lganda nogah rihlati.

Gap chiqib ta'rixidin azro'yi nom,

Dedi: "Mirzo Abdurahmon rahmati". [5]

In the last verse of the poem, the expression "Mercy of Abdurrahman Mirza" is a denominator, in which the letters in the Arabic alphabet amount to 1241 AH. According to the first line of the last distich, the initial letter of the word "nom" will be 1291, adding 50 to the number 1241, it will be 1291. It's 1873, when we convert it into modern-year-count. Thus, it is known from this theory that Mirzo Abdurahmon Margilaniy died in 1873. Histories on buildings and structures. Mosque construction:

Xusho! Bar himmati Mirzo bino shud masjid xishtin,

Maboda lahza, Yo rab, az namozi mo'minon xoliy.

Muqimiy, justam az piri xirad ta'rix ta'mirash,

Ba ro'yi aqlu donish guft: "Ibodatxonai oliy".

"This poem was first published by A. Madaminov in the book "Yangi bayoz". The poem – the copy of the Mukumiy handwriting, is stored at the G. Gulam Museum of Literature in Kokand today under number 86. According to the note written in the Nasta'liq letter of the Nation's poet of Uzbekistan, Charik, a resident of the Darhon neighborhood of Tashkent, Mirzo Ubaydullai had built a mosque and asked Mukumiy to write a poem. In the fourth verse of the poem, the phrase "Supreme Mosque" is a historical sign as 1318 Hijri derived from that phrase. If it is converted into modern-year-count, it will be in 1900. [7] Another poem of Mukumiy appears in the manuscript No. 7521 (page 50b):

Ko'rib ushbu farax afzo binoni,

Muqimiy so'rdi aqlidin nihoni.

Dedi az ro'yi lutf ohista nogah,  
Xirad tarixina “ta'miri soniy”.

It seems that the poem is about the restoration of a beautiful building. In the fourth verse, the phrase "Second restoration" is sign of history. According to Hijri account, it is in 1281. If it is turned into a modern-year-count, it dates back to 1863. Thus, it is known that the building was reconstructed in 1863.

Writings Historical events. It is well known that the representatives of Kokand literary environment wrote poems in many different genres dedicated to the Andijan earthquake. 27 distichal poem titled "The history of an earthquake in Andijan by Mevlana Mukumiy" was published in "Turkistan Region Newspaper", in April 22, 1903 by the Mukumiy. Unfortunately, the text of the poem was published in the 19 distiches in the collection of Mukumiy works in the Soviet era, 8 distiches were dropped. There are valuable comments in the article of the literary critic R.Tojiboev, titled "The full version of the poem of the history of Andijan earthquake" which was published in scientific collection "Literature mirror" in 2004. The full version of the poem is included in the collection of Muqimiy Poems named "Around the Garden" was published with the help of A. Turdaliev in 2010. The last distich of poem is as follows:

Jon boshina zilzila qasd aylagach,  
Tarixin aql aydi: “darig' Andijon”.

Apparently, the word "narrow Andijan" is a sign of history and according to Hijri it is equal to 1323. According to the first verse of the distich, the first letter of the word "soul" is “jim”. The letter express the number of three. If the number of three is removed, 1320 Hijri will appear. And in the modern year count, it is the year of 1902. Hence, in Andijan the earthquake happened in 1902. [9]

The poem of the Mukumiy written in political theme, election, in the genre of “ghazal” is known to experts. It has also been discovered that there are two poems written in the genre of “muhammas” in the same subject. One of them is a muhammas that is close to the ghazal of Zavkiy. The last paragraph is as follows:

Xalq tavriga qil, Muqimiy, nazar,  
Amali oriyatga karro far,  
Ko'rmadi sud juz ziyonu zarar,  
Jon chiqib, axchasi bo'lub besar,  
Qozi Isfandiyor o'ldi, deng.

"This “muhammas” was published for the first time in 1997 by Madaminov in the book "New Bayez". In the last verse of the poem, the expression "Qadi Isfandiyar" is a sign of history, the compound of the number of letters in the Arabic alphabet is equal to 1313. Hence, this election took place in Hijri 1313. By turning 1313 years into modern-year-count, it dates back to 1895. [10]



**CONCLUSION**

In conclusion, the Muqimiy's poems, which dedicated to history clarify historical events, social and political life in the late 19th and early 20th centuries, as well as prove that the poet wrote efficiently in the genre of "Ta'rix" which literally means "history".

In general, the study of the history, editing and interpretation of Muhammad Aminhoja Mukimi's poetry complements some of the theoretical considerations of the text, secondly, demonstrates the groundlessness of the scientific conclusions made on the basis of primary sources, and, thirdly, the critical review of existing works, important conclusions. Experience shows that only scientifically sound conclusions can be made to the development of textual and literary studies, based on originality.

**REFERENCES:**

1. Qosimov B., Yusupov Sh., Dolimov U., Jabborov N, and others. The National Renaissance Period in Uzbek Literature. T.: Ma'naviyat, 2004, p.
2. A.Turdialiev. The garden. T.: ACADEMY, 2010, p. 298.
3. Karimov G. Muqimiy. Selected Works. - T.: Academy of Sciences of the Republic of Uzbekistan, 1958, p. 13.
4. The text of this poem is also included in the "Yangi Bayoz" collection published by A.Madaminov. T.: 1997, P. 54.
5. Madaminov A., Kushmakov M. The revolution led to a true path. // Gulistan, 1980, 12th, p.22.
6. Turdialiev A. Bog` aro. T. Academicians publishing, 2010, p. 216.
7. Turdialiev A. Bog` aro. T.: ACADEMIA, 2010, p. 278.
8. G.Karimov also informed about it. (Muqimiy, Selected Works - T: Publishing House of the Academy of Sciences of Uzbekistan, 1958, p. 12.
9. Look A. Turdialiev. The garden. T.: ACADEMY, 2010, p. 298.
10. Turdialiev The garden. T.: ACADEMY, 2010, p. 297.

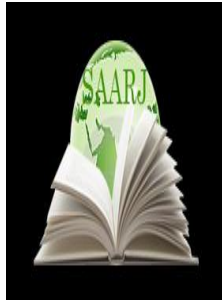

**ACADEMICIA**  
**An International**  
**Multidisciplinary**  
**Research Journal**  
 (Double Blind Refereed & Peer Reviewed Journal)

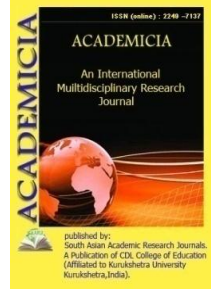

**DOI: 10.5958/2249-7137.2021.01056.9**

## VALUE OF HEMOSTASIS SYSTEM INDICES IN RESPIRATORY RECURRENT PAPILLOMATOSIS

**Nozima Shamsutdinovna Najimutdinova\***; **Abdugafur Akhatovich Hadzhimetov\*\***

\*PhD Candidate of Medical Sciences,  
 Republican Specialized Scientific and Practical Medical Center of Pediatrics,  
 UZBEKISTAN  
 Email id: Nnaz1@yandex.ru

\*\*Professor of the Department,  
 Professor, Doctor of Biological Sciences,  
 Tashkent State Dental Institute,  
 UZBEKISTAN

### ABSTRACT

*For the solution of objectives there were studied patients aged from 2 years up to 45 years with benign formation of a throat respiratory recurrent papillomatosis – 59 patients. The 1st group - 38 patients with a recurrent respiratory papillomatosis of children's age, the 2nd group - 21 patients with a recurrent respiratory papillomatosis of adult age, the 3rd group made 12 almost healthy people. Study of hemostasis system indicators; activated partially thromboplastin time (APTT), thrombin time, antithrombin-III, fibrinogen was tested by the conventional method using sets from HUMAN. As it can be seen from the presented results of the studies, the number of platelets in blood plasma in patients of group 1 has a decrease dynamic, in particular, when compared with healthy persons, the concentration of platelets in blood plasma decreases by an average of 30%, while in group 2 the platelet content tends to decrease by an average of 43%. The detected disorders in the hemostasis system can serve as a marker of endothelial dysfunction that contributes to the constant maintenance of inflammation, increased neoplastic effects, which can lead to frequent recurrence of RRP of the infant contingent and stunning of RRP - an adult, and require appropriate targeted correction of the detected disorders.*

**KEYWORDS:** *Respiratory Recurrent Papillomatosis, Study, Hemostasis System Indicators, Dysfunction Of Vascular Endothelial Cells*

## INTRODUCTION

Benign tumors and tumor-like changes are found in the larynx much more often than malignancies. According to various authors, benign laryngeal neoplasms are found in 55-70% of cases among productive processes of the upper respiratory tract [1,2,6].

Tumor pathology is characterized by involvement in the pathogenesis processes of integral homeostasis regulation systems, including endocrine, immune, and hemostatic ones. At the same time, tumor cells can directly produce various procoagulants and anticoagulants. It is known that tumor cells activate the procoagulant link of the hemostasis system due to the formation of the factor V receptor. This receptor is located on the surface of the membranes of tumor cells and accelerates the formation of the prothrombinase complex (factor V + factor X + calcium + platelets). Proinflammatory cytokines secreted by tumor cells significantly increase the expression of tissue factor monocytes. Pro-inflammatory cytokines released by the tumor and blood cells also disrupt the regulation of thrombomodulin in endothelial cells, as well as increase the expression of tissue factor and fibrinolysis inhibitors - a plasminogen-1 activator inhibitor (PAI-1) in endothelium. Impaired control function of the endothelium reduces the synthesis of antithrombin III and protein C by the liver. This leads to increased procoagulant and decreased anticoagulant and fibrinolytic activity of the vascular wall, which is essential in the formation of vascular blood clots [8]. Tumor cells and circulating particles of tumor cell membranes affect the platelet link of the hemostasis system, increasing platelet adhesion and aggregation [3,4,5,7].

Thus, activation of a system of a hemostasis as a result of influence of tumoral pro-coagulants, inflammatory cytokines, a fabric factor of monocytes, fabric macrophages and endothelial cells and also leads to increases in functional activity of platelets to emergence of thrombin and deposition of fibrin in and around tumoral fabric. Modern researches showed that local accumulation of fibrin forms a matrix for growth of a tumor and angiogenesis. Tumor cells are capable to express all proteins necessary for regulation of a fibrinolysis on the surface. The constant fibrinolytic activity, i.e. formation of plasmin, promotes a tumor invasion.

On the basis of the above presented the purpose of this research was to reveal a contribution of system disorders in the haemocoagulation of blood to pathogenesis of benign tumors and throat cancer and also to define their predictive and diagnostic importance.

### Material and methods of a research

For the solution of objectives from 2016 for 2018 on the basis of the Republican scientific and practical medical center of pediatrics there were studied patients aged from 2 years up to 45 years with benign formation of a throat respiratory recurrent papillomatosis – 59 patients. From them 34 children (aged from 2 years up to 6 years) with a frequent recurring form, and 28 adults from 18 to 45 years.

The 1st group - 38 patients with a recurrent respiratory papillomatosis of children's age, the 2nd group - 21 patients with a recurrent respiratory papillomatosis of adult age, the 3rd group made 12 almost healthy people.

The developed clinical diagnosis was established on the basis of the nature of complaints, of the anamnesis, results of clinical examinations, investigations of ENT organs: otoscopy, pharyngoscopy, front and back rhinoscopy, indirect laryngoscopy. Specialized methods of inspection: a videolaryngoscopy by means of a rigid pharyngo-laryngotelescope with a point of

view 70 ° or 90 ° (diameter of trunk is 10 mm, useful length is 15 cm), “KarlStorz” with removal of the image on the monitor and an opportunity photo, and video documenting for the subsequent analysis; an indirect microlaryngoscopy at increase 6x8x12 with an operational microscope of Zeiss; a fibrolaryngoscopy, a laryngostroboscopy with photo and video documenting of the image output to the monitor for the further analysis of time-lapse reproduction of a video; Neck MSCT; a research of acoustic indicators of a voice (in Hz, before operation); a direct microlaryngoscopy for a research and sounding of pathologically changed departments of a throat under control of big increase in a microscope (6x 8x12) and also rigid endoscopes viewing angles 0 °, 30 °, 70 °, sufficient operating length, for the final decision about the of surgical intervention and a possibility of its rying out. Additional tool methods: measurement of pH in the lower and middle third of a throat, and the top third of a gullet (according to indications).

The mandatory plan for the examination of patients included generally accepted clinical-laboratory and instrumental diagnostic methods. Study of hemostasis system indicators; activated partially thromboplastin time (APTT), thrombin time, antithrombin-III, fibrinogen was tested by the conventional method using sets from HUMAN.

Statistical processing of the obtained results was carried out using the application package "STATISTICA" (version 6.0, StatSoft Inc, 2001). Differences and correlation coefficients were considered significant at  $p < 0.05$ .

## RESEARCH RESULTS AND DISCUSSION

We used global (screening) methods for assessing of hemostasis: determining APTT, TV and fibrinase concentration, as well as a refinement test - determining antithrombin AT III. The patients we examined had an increase in the level of fibrinase, a shortening of APTT and an increase in TV with a decrease in the level of antithrombin AT III, which appeared to be the signs of the hypercoagulation syndrome.

As it can be seen from the presented results of the studies, Table 1, the number of platelets in blood plasma in patients of group 1 has a decrease dynamics, in particular, when compared with healthy persons, the concentration of platelets in blood plasma decreases by an average of 30%, while in group 2 the platelet content tends to decrease by an average of 43%.

Therefore, in patients with RPP, a state of thrombocytopenia is observed in blood plasma.

As it can be seen from the results obtained (Table 1), the activated recalcification time in patients with RRP decreased by 35% on average ( $P < 0.05$ ). ABP contraction indicates an acceleration of chronometric hypercoagulation due to the state of the external pathway of the hemostasis system, i.e. activation of the vascular-platelet link of the hemostasis system by tissue factors.

Activated partial thromboplastin time (APTT) is used as a screening test to evaluate the internal plasma clotting cascade, which uses reagents containing contact activation phospholipids rather than tissue factors. In our study, APTT in 28 children with recurrent respiratory papillomatosis was  $25.9 \pm 1.07$  sec, and in 10 of them less than 25 s. This is 19% ( $P < 0.05$ ) lower than in the comparison group. This coagulogram index is closely related to the structure of the thrombus formed and is due to the state factors of the blood coagulation system. Activation of the vascular-platelet unit of the hemostasis system along the cascade chain activates its plasma unit and leads to chronometric and structural hypercoagulation. When analyzing the results in children with RRP, the often recurrent form of the disease is on average 1.2 times lower when compared with

the indicators of a group of healthy patients. As is known, APTT is directly dependent on the level of endogenous anticoagulants. Therefore, the elongation in time of the APTT index in patients with RRP indicates disorders in the plasma unit of the hemostasis system, which may be one of the causes of frequent recurrence as a result of maintaining inflammation. As it is known, one of the factors disrupting the procoagulant link of the hemostasis system is enhanced thrombin synthesis, which plays a dual role in the hemostasis system. It can activate the process of thrombosis and fibrinolysis, worsening the local rheology leading to dystrophic mucosal changes supporting inflammation, which increases the possibility of relapse.

To prevent this situation, vascular endothelial cells synthesize antithrombin-III, which, when endogenous heparin is involved, binds thrombin. In our studies, the observed increase in thrombin levels is accompanied by a significant decrease in plasma antithrombin-III. So, in patients of group 1, there was a decrease in the level of antithrombin-III by an average of 33% when compared with the control group. As is known, the dynamics of thrombin time may indicate the risk of developing thrombohemorrhagia in a given contingent of patients. Analysis of the obtained research results showed the risk of thrombohemorrhagia in patients of both groups, while in the second group the risk is higher than in the first. It is worth noting that hemorrhages in the postoperative period lead to the development of microthrombus and damage of mucosal trophies, deterioration of local blood flow. Endothelin serves as a compromising factor. Under the action of factors that activate or damage the endothelium (viral endotoxins, CEC, cytokines, inflammatory mediators), a sharp change in the para- and autocrine activity of the endothelium occurs with the loss of its inherent property of thromboreactivity and the enhancement of procoagulant and proaggregant effects: increased formation of Willebrand factor, type 1 plasminogen activator inhibitor (IAP-1), tissue thromboplastin, fibronectin, decreased synthesis of tissue-type plasminogen activator, thrombomodulin, antithrombin, prostacycline, nitric oxide, endothelium included in synthesis of prooxidants, vasoconstrictors to enhanced thrombosis, disorder local homeostasis and endothelial dysfunction, which increases the risk of papilla staining of adults with RRP.

The state of hypercoagulation that we observe in patients of group 1 can lead to compensatory activation of the fibrinolytic unit of the hemostasis system, expressed by an increase in fibrinolytic activity of blood plasma, due to an increase in thrombin levels. The increased consumption of thrombin and fibrinogen against the background of the depletion of antithrombin II is reflected in the properties of the resulting clot. This is expressed by an increase in the activity of factor XIII - fibrinase, in which additional crosslinking is formed in the fibrin clot, partially dehydrates it, and the clot becomes more dense. That is, in patients of group 2, the level of fibrinase increases by 27.0% ( $P < 0.05$ ). Thrombin formed in the cascade chain binds to antithrombin III. The mediator and activator of this complex is endogenous heparin. Plasma tolerance to heparin indirectly indicates the content of endogenous heparin, an increase in the level of which indicates the depletion of antithrombin II.

Thus, in patients with RRP, the fibrinolytic link of the hemostasis system is activated against the background of disruption of the plasma link of the hemostasis system and dysfunction of vascular endothelial cells. The detected disorders in the hemostasis system can serve as a marker of endothelial dysfunction that contributes to the constant maintenance of inflammation, increased neoplastic effects, which can lead to frequent recurrence of RRP of the infant

contingent and stunning of RRP - an adult, and require appropriate targeted correction of the detected disorders.

**TABLE 1 DYNAMICS OF THE CHARACTERISTICS OF THE HEMOSTASIS SYSTEM IN THE PATIENTS OF THE RECURRENT RESPIRATORY PAPILOMATOSIS**

Characteristics	Healthy patients n=12	Patients with recurrent respiratory papillomatosis, children n=38	Patients with recurrent respiratory papillomatosis, Adults n=21
Thrombocytes (x10 <sup>9</sup> /l)	228,14±9,34	158,46±7,89	131,15±8,56*
Activated partially thromboplastin time APTT (cec)	31,78±2,57	25,90±1,07*	38,69±2,94*
Prothrombin time PT(cec)	16,43±1,22	20,41±2,65	33,86±3,72*
Antithrombin AT III (%)	101,12±7,84	70,86±5,12*	62,84±7,05*
Activated recalcification ART(cec)	58,21±3,44	41,42±3,12*	37,64±2,38*
Fibrinolytic activity, (cec)	0,91±0,05	1,28±0,03*	1,45±0,04*
Fibrinasa, %	64,21±4,33	70,30±5,01	85,30±6,01*
Tolerability of plasma to heparin, %	7,6±0,48	6,9±0,56	18,2±1,48*

Notes : \*- differences reliability at P< 0,05

## REFERENCES

1. Alferov V.S. Morphological and biological features of the squamous cell laryngeal cancer /V.S.Alferov A.A.Akhundov., A.E.Pavlocskaya et al., //Vestn.Otorhinolaryngology. - 1995. - N 6.- P. 27.
2. Antonov V.G. Pathogenesis of the oncological diseases: immune and biochemical phenomena. Extracellular and cellular mechanisms of the total depression and immune resistance / V.G.Antonov., V.K.Kozlov // Cytokini I vospalenie. – 2004.-Vol.3, N 1.-P. 8-19.
3. Barinov E.F. Molecular mechanisms of thrombogenesis /E.F.Barinov., O.N.Sulaeva // Kardiologiya..- 2012.- №12. - C. 45-56.
4. Bokarev I.N. How to make diagnosis of DVS – syndrome. Thrombosis, Hemorrhagic diathesis, DVS-syndrome / I.N.Bokarev., L.V. Popova.- Moscow.-2009.-34p.
5. Dzyack G.V. Molecular bases of the blood coagulation and thrombogenesis. /G.V.Dzyack, T.A.Pertsceva, A.M.Vasilenko. – Dnepropetrovsk: IMA-pres, 2010Г. . – 314p.
6. Kovalev A.A. Circulating tumor cells / A.A.Kovalev // Zdorov'ya Ukraini, 2012. – June. – P.36-37.
7. Novick A.A. Introduction into the molecular biology of the cancerogenesis / A.A.Novick, T.A.Klimova, V.P.Tcigan. – Moscow:GEOTAR-Media, 2004. – 234 p.
8. Levine M.N., Lee A.Y., Kakkar A.K. Thrombosis and cancer. //Proc. Am. Soc. Clin. Oncol. — 2005. — P. 748—747.

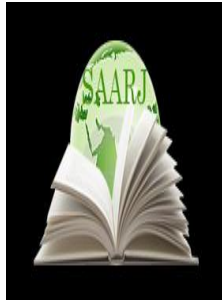

**ACADEMICIA**  
**An International**  
**Multidisciplinary**  
**Research Journal**  
 (Double Blind Refereed & Peer Reviewed Journal)



DOI: **10.5958/2249-7137.2021.01057.0**

**THE RECENT PAST AND PRESENT OF THE PROTECTION OF  
 HISTORICAL AND CULTURAL MONUMENTS IN UZBEKISTAN**

**Oybek Alikulovich Ostonov\***; **Khamdam Alikulovich Akhmedov\*\***;  
**Khusan Ochilboyevich Khushvaktov\*\*\***; **Khidirov Kholmurod Norimovich\*\*\*\***

\*Associate Professor,  
 Candidate of Historical Sciences,  
 Tashkent State Agrarian University,  
 UZBEKISTAN  
 Email id: ostonovo@rambler.ru

\*\*Candidate of Philosophical Sciences,  
 Tashkent State Agrarian University,  
 UZBEKISTAN  
 Email id: axmedov.xamdam@bk.ru

\*\*\*Candidate of Historical Sciences,  
 Tashkent State Agrarian University,  
 UZBEKISTAN

\*\*\*\*Candidate of Political Sciences,  
 Tashkent State Agrarian University,  
 UZBEKISTAN  
 Email id: khidirov.kh@bk.ru

**ABSTRACT**

*This article focuses on the protection of historical and architectural monuments in the recent past and present. As a result of comprehensive reforms in Uzbekistan, the attitude to national values and cultural heritage, the restoration of unique architectural monuments, historical monuments of religious and enlightenment significance, as well as , the analysis of the existing problems in the repair of historical monuments, the concepts created by the repairmen, the study of the concepts created by the repairmen, the great creative work carried out on the basis of modern urban planning principles and the architectural culture serves to raise the spiritual maturity of society. After gaining independence, attention is paid to the deep study of the history*

---

*of our country, our people, its scientific study, restoration of ancient sources with impartiality, revealing the roots of the history of statehood, which has become one of the main issues of cultural and spiritual life.*

**KEYWORDS:** *Cultural Heritage, Historical And Architectural Monuments, Restoration And Conservation, Cultural Ties, Architecture, Protection Of Monuments, Repair Profession.*

---

## INTRODUCTION

The ancient architectural monuments of the world are a universal value. At the same time, they bear witness to the culture, history and contribution of these peoples to world civilization. Preservation of historical architectural monuments is now considered a universal problem. It is recognized that the identification of traditional methods used in the construction of historical and architectural monuments, on this basis, the improvement of architectural and compositional criteria of monuments, their repair and restoration is an effective way to preserve and pass on to future generations.

Preservation of our unique historical monuments is a sacred duty of every citizen living in the territory of Uzbekistan. After all, it is impossible to build a rule of law and civil society in our country without the development of spirituality and enlightenment. In this regard, changing the spiritual world, the system of ideas, the psyche of man requires many years of tireless research and hard work. While the well-being of the citizens of our independent land is partly the responsibility of the architects, the restoration and preservation of the architectural heritage built in the past is the highest duty of the people, so that the foundations of a prosperous future are strong. Therefore, one of the most pressing issues today is the study of repair theories, problems and their use in future practical work by many of our scientists who have worked on the repair of monuments in their lives.

## 2. Methods, analysis of relevant literature and sources

The article uses methods of scientific abstraction, analysis and expert evaluation. Several literature, articles and researches are devoted to the study and repair of architectural monuments of Uzbekistan. G.Pugachenkova, L.Rempel, B.Zasytkin, L.Voronin, V.Nilsen, K.Kryukov, M.Bulatov, P.Zohidov, L.Mankovskaya, I.Notkin, M.Ahmedov, D.Nozirov, A. The scientific works of Urolov, I.Azimov, M.Yusupova, H.Pulatov, A.Ziyaev and other scientists are an example of this.

One of the scientists who contributed to the development of architectural science in the republic. Zohidov [1] and T.F. Kadyrova [2] can also be mentioned. For example, while P. Zohidov often focused on the history of architectural monuments and their condition, T.F. Kadyrova's monograph provides a comprehensive analysis of practical experience in the field of modern architecture and urban planning in Uzbekistan in the XX and early XXI centuries.

French archaeologist Adolf Napoleon Didron believed that the rights of the repairman should be restricted. He wrote that "no poet should attempt to complete the poems in the Aeneid epic, no painter should attempt to finish a work that Raphael did not finish, no sculptor should attempt to finish a statue of Michelangelo that no sane architect should attempt to finish an unfinished building." Dideron also condemns the method of "cleaning the monument from subsequent



additions and achieving stylistic integrity." He found that the only way to avoid many mistakes was to carefully study medieval architecture.

### 3. Results of research

In Uzbekistan, in 1919-1924, more than 15 decrees laid the foundations of the system of protection of monuments of the former Soviet state. In 1926, the main archeological organization was renamed the State Academy of History of Material Culture. His tasks were: to develop a framework for the protection of monuments; conducting searches, systematic excavations and collecting artifacts related to the preservation and study of antiquities, arts and folk lifestyles; to supervise the development of monuments, scientific guidance of excavations and the promotion of monuments [4]. The formation of protection and repair of existing historical and architectural monuments in Uzbekistan began relatively late. Given the importance of the vast cultural heritage of our ancestors, the preserved monumental architectural monuments began to be transferred to the special state body for the protection of monuments in the early twentieth century, ie from 1920. This body was originally performed by a special committee for the protection of historical and artistic monuments under the Central Archives of the Republic of Turkestan, which began its work on January 30, 1920. By a special decree of the leadership of the Republic of Turkestan dated May 23, 1921, the Committee was transformed into an independent state body - the Turkestan Committee for Museums and Monuments, Arts and Nature Protection (Turkomstaris) by the Decree of the Council of People's Commissars of the Republic of Turkestan. The consequences of the policy of the former Soviet government on the administrative-territorial issue had an impact on the organizational and structural activities of this committee. As a result, this organization was renamed the Central Asian Committee for Monuments and Nature Protection (Sredazkomstaris) in 1925 after the national demarcation of the Central Asian republics. The Committee was responsible for the protection, use and restoration of monuments in the newly formed Central Asian republics and Kazakhstan. In 1929, by Resolution No. 501 of the Central Executive Committee and the Council of People's Commissars of the Uzbek SSR, the Uzbek Committee for the Protection of Ancient Monuments was reorganized and transformed into Uzkomstaris instead of Sredazkomstaris. In the early days of its activity, the scope of tasks of this body was not wide, it was to take into account the archaeological monuments of the country. Due to the severity of the economic situation and their unpreparedness for restoration work, the protection authorities of the monuments were limited to carrying out the necessary repairs aimed at preventing the complete destruction of the architectural monuments. During this period, the issue of creating a scientific basis for production related to the restoration and conservation of monuments had only just begun to arise. Nevertheless, in those complex political and economic conditions, the theoretical basis of the scientific methodology of restoration and conservation began to be created.

In general, the basic concepts of the architectural-archaeological method of studying cultural monuments were formed in the late 1920s, and it was published in the collection of restoration issues published in 1928 [5]. However, the initial scientific research and the mass organization of the protection and repair of architectural monuments were hampered by the policy of the Communist Party, which aimed at achieving general equality. The revolutionary spirit that envisioned socialist change led to the destruction and equalization of the distinction between the new and the old city, as well as the distortion and humiliation of many ancient forms of urban planning as a result of ideas against religion and values, especially in the first decades of Soviet

rule. These radical ideas have caused irreparable damage to Tashkent, Samarkand, Bukhara, Shakhrisabz and other historical cities of Uzbekistan. Therefore, an investigation into the activities of Uzkomstaris in April-May 1939 on the basis of a special instruction of the government of the republic showed that the monuments given to him were used for other purposes. In particular, the only inspection in Bukhara revealed that the Madari Abdullah Khan Madrassah was located for housing, another monument to Abdullah is a warehouse for the Sakharsbit organization, the Kalon Mosque and the Chor Minor are a warehouse for Gortorg, and the Devonbegi Madrasa is a Bukhara Bukkomstaris was found to have been used for the office and for residential purposes. At the same time, many historical monuments in the city were destroyed as a result of the expansion and beautification of the city. In particular, as a result of the reconstruction of the city of Bukhara and the increase in traffic, using the powers given to the Bukhara city council, in 1939, 6 ancient city gates were demolished along with the walls. However, despite the above-mentioned tragedies, the experience of scientific restoration and practice gradually increased, and as a result it became possible to solve a number of complex engineering-constructive and architectural tasks related to the preservation of architectural monuments. By this time, a new generation of talented professionals began to form in the republic. They organized early expeditions, identified and began to take into account historical, archaeological and architectural monuments. The compilation and systematization of accounting documents began in 1920-1930. In addition, the development of the first science-based projects for the restoration and conservation of architectural monuments in different districts of Uzbekistan coincided with this period. The creation of building materials and cladding materials similar to the old patterns has been one of the problems in the restoration of architectural monuments for many years.

Thanks to the efforts of experts and folk masters, the issue began to be resolved and significant progress was made in the restoration of the monuments. From simple conservation, which consists of fixing the coating with an alabaster mixture, to the restoration of mosaics, mosaics and carved majolica. An important factor should be the introduction of the method of strengthening architectural monuments with the help of engineering, the use of modern building materials. In this process, the role of the school-workshop, which began to operate in Samarkand in 1937, specializing in the teaching of ancient construction methods, was great. Architect from Bukhara, master plasterer Master Shirin Murodov was one of the leading architects of his time. Together with Zasytkin, they prepared a textbook for this school that teaches the mystery industry of ancient construction techniques and geometric ornament methods. Drawings of 238 pages were also attached to the manuscript. At the same time, well-known master restorers such as master Usmon Umarov, master Shamsiddin Gafforov, master Abdulla Boltaev, Nasim Gafurov, master Muhiddin Rakhimov took an active part in the educational process. Later, the graduates of the school, such as master Ibrahim Shermuhamedov, master Abdugaffor Hakulov, Anvar Quliev, master Mirumar Azizov, Tashmukum Kurbanov, reached the level of mature master restorers. During the Second World War, a new stage of organizational and structural changes began for the state body for the protection of architectural monuments in Uzbekistan. In 1943, the Uzkomstaris organization was abolished and the Department of Architecture was established under the Council of People's Commissars of the USSR, and a department for the protection of architectural monuments was established under the department. Subsequent practice has shown that this structural change has led to the disappearance of many historical monuments. This is due to the fact that the Committee for Architectural Affairs, based on its

main area of activity, focuses on the construction of housing and other objects of economic and social significance in the cities and villages of the country. In particular, the main projects of the committee developed by the leading organizations of the center in 1950-60, including the construction of new buildings in historic cities. However, this operation was intended to be carried out in the traditional residences of the population. Given the fact that in the historical cities of the republic, such as Samarkand, Bukhara, Khiva, the houses of the population are located close to the monuments, it was natural that this operation would damage the old buildings.

In particular, as a result of large-scale work carried out according to the plan, educational institutions, palaces of culture, cinemas or multi-storey boxes around the architectural monuments of Samarkand, which spoil their original appearance, were filled. In Bukhara, at the same time, the historical walls of the city were almost demolished and served as a raw material for bricks, the 16th-century Yor Muhammad Ataliq room in the city center and the 18th-century Ernazar Elchi madrasah were demolished. This list could go on and on with similar tragic events. In general, if at that time the economic and financial capabilities of the state were not limited, the work envisaged in the master projects of cities would be fully implemented. This would have further limited the list of historical and architectural monuments that have survived to the present day. The financial capacity of the organizations protecting the monuments, as well as the level of staffing, had fallen into disrepair. The situation required a change in the activities of the organization related to the preservation of cultural monuments in the republic. On the initiative of a number of zealous, progressive intellectuals of the republic, on August 30, 1957 by the Government Resolution of the Republic of Uzbekistan №557 - "Committee for the Protection of Monuments of Material Culture" was established. A council was set up under this Committee, which included such leading scientists as Ya. Gulomov, M. Masson, T. Koriniyozov, G. Pugachenkova. Despite the fact that the Council was active for a short period of time (1957-1961), it helped to preserve a significant part of the existing cultural and historical monuments in Uzbekistan, to develop repair work in some of them, to study them, to revive the school of restorers in the country. Extensive work has been done on. Importantly, the efforts of the country's leading scientists working in this organization were not in vain, but had a positive impact on the future work on the preservation of cultural and historical heritage in the republic. 1968 was an important event for the work being done in the field of protection of our cultural heritage. The law on the protection of cultural monuments was adopted. It should be noted that this was done 8 years (1976) before such a law was adopted at the level of the Union. In accordance with this law, the government has approved guidelines for its application, regulations on the protection of material and cultural monuments and the construction of buildings around them, the right to conduct archeological excavations and prospecting in Uzbekistan.

#### REFERENCES:

- [1] Зоҳидов П. Темур даврининг меъморий қаҳқашони.– Тошкент, 1996; Зоҳидов П.Ш. Меъмор олами. – Тошкент, 2004.
- [2] Кадырова Т.Ф. Пути архитектурного возрождения Узбекистана за XX – начало XXI в. (традиции и современность). – Ташкент, 2007.
- [3] Беккер, А. Ю. Современная городская среда и архитектурное наследие / А. Ю. Беккер, А. С. Щенков. – М.: Стройиздат, 1986.

- [4] Пескарева К.М. К истории создания Российской академии истории материальной культуры. // КСИА АН –1980 – Вып. 163. - С.26-32.
- [5] Крюков К.С. Организационные формы охраны и реставрации памятников архитектуры Узбекистана (1920— 1990 гг.) // Строительство и архитектура Узбекистана. – 1990. – № 8.
- [6] <https://www.lex.uz/acts/25461>
- [7] [http://lex.uz/pages/GetAct.aspx?lact\\_id=25461](http://lex.uz/pages/GetAct.aspx?lact_id=25461). (20.02.2018).
- [8] [http://www.lex.uz/pages/getpage.aspx?lact\\_id=230521](http://www.lex.uz/pages/getpage.aspx?lact_id=230521) (14.01.2018).
- [9] Ostonov O.A. Khayitov Z.U Junaev Z.B. Some features of historical and cultural tourism in Uzbekistan//Journal of Critical Reviews. Vol 7, Issue 6, 2020. P.1257.
- [10] Аҳмедов М.К., Рафиқов С.А. Ўзбекистонда меъморий ёдгорликларни таъмирлаш муаммолари // О'zbekiston arxitekturasi va qurilishi. 2005-yil 1-son.18-bet.
- [11] Arxitektura yodgorliklarini ta'mirlash.-Toshkent, 2009. 116-бет.
- [12] Пугаченкова Г. А. Архитектурные руины – реставрация или консервация? // Архитектура и строительство Узбекистана. 1995. № 12. С.37.
- [13] Ostonov, O. A., Khayitov, Z. U., & Junaev, Z. B. (2020). SOME FEATURES OF HISTORICAL AND CULTURAL TOURISM IN UZBEKISTAN. *Journal of Critical Reviews*, 7(6), 1256-1262.
- [14] Остонов, О. (2018). РЕМЕСЛЕННИЧЕСТВО УЗБЕКИСТАНА В СОВЕТСКОМ ВРЕМЕНИ. *Theoretical & Applied Science*, (6), 162-165.

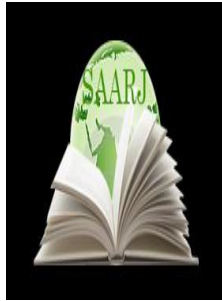

**ACADEMICIA**  
**An International**  
**Multidisciplinary**  
**Research Journal**  
 (Double Blind Refereed & Peer Reviewed Journal)



**DOI: 10.5958/2249-7137.2021.01058.2**

## BASIC CONCEPTS RELATED TO TERMS IN WORLD LINGUISTICS

**Munavvar Sanakulovna Kayumova\***; **Zamira Sharifovna Rozmetova\*\***;  
**Nozima Kuchkarovna Muxtarova\*\*\***

\*Associate Professor,  
 Navoi Pedagogical Institute,  
 UZBEKISTAN

\*\*The second-year student of Master's degree,  
 National University of Uzbekistan named after Mirzo Ulugbek,  
 UZBEKISTAN  
 Email id: zamira85r@gmail.com

\*\*\*The second-year student of Master's degree,  
 National University of Uzbekistan named after Mirzo Ulugbek,  
 UZBEKISTAN  
 Email id: noziamuxtarova@gmail.com

---

### ABSTRACT

*The article depicts the problem of the concept of term from different viewpoints of linguists and approaches to the word term in English, Russian and Uzbek languages and analyzes the specific features of term in different languages.*

**KEYWORDS:** *Term, Terminology, Brevity, Concept, Definitivity, Denomination, Nominativity, Scientific Term, Systematicity.*

---

### INTRODUCTION

The quality problem of a scientific term is solved in terminology from the position of the theory of *term* as a special type of nomination. The definition of *term* itself contains information about its specificity. It should be said that most researchers define *term* as a word denoting something specific: a specific object, a specific concept. In the search for the concept of *term*, it is extremely difficult to identify its most essential features not only in terms of content, but also in terms of expression.

### The main results and findings

According to Rondeau, *term* is basically a linguistic sign in the Saussurian sense; it has a signifiant and a signifie. He gives the name *denomination* to the label, and the name *notion* to the concept. Unlike Wuster, who used the word *term* to refer exclusively to the *label*, Rondeau uses the word *term* to describe the combination of *denomination and notion*, i.e. the combination of *label* and *concept*. Sager offers the following definition of *terms*: the items which are characterized by special reference within a discipline are the 'terms' of that discipline, and collectively they form its 'terminology' [2].

H. Felber defines *term* as a linguistic symbol assigned to one or more concepts (defined meanings). The meaning of *term* which is a concept, is dependent on the position of this concept in the system of concepts concerned.

M. Teresa Cabre states that a *term* is a unit referring to a reality that is expressed by means of a form and used for intercommunication [1].

Russian linguists also made a significant contribution to history terminological schools and terminology as a science. The Russian founders of modern terminology studies are considered A.A. Reformatsky, D.S. Lotte and V.P. Danilenko. They examined issues that are still in the focus of linguistic analysis, namely, questions about the linguistic essence of the term, nature and the formation of terminologies.

*Term* as the basic unit of interprofessional communication has different interpretations. According to A. A. Reformatsky, *terms* are words limited by their special purpose; words striving to be unambiguous as an exact expression of concepts and the name of things [8]. In the definitions of *term*, it can be revealed the maximum or minimum of the signs recognized as mandatory for this type of sign. According to V.V. Vinogradov a word performs a nominative or definitive function, i.e. it is a means of clear designation, then it is a simple sign, or a means of logical determination, then it is a scientific term [4].

In the definitions of *term* it can be found maximum or minimum features acknowledged obligatory for this type of sign. In particular, N.V. Vasileva defines *term* as a linguistic unit of a special sphere of use possessing a nominative-definitive function. This definition characterizes *term* according to such essential features as belonging to a special sphere of use and a nominative-definitive function. We can note that one of the leading theorists of terminology V.P. Danilenko in his monograph cited 19 definitions of the notion '*term*' from various scientific sources and analyzed various points of view of famous researchers: O.S. Akhmanova, R.A. Budagov, V.V. Vinogradov, G.O. Vinokur, B.N. Golovin, A.A. Reformatsky and others. V.P. Danilenko gives the following definition for the concept of *term*: *term* is a word (or word combination) of a special sphere of use, which is the name of a special concept and requires a definition. It is easy to see that this definition coincides in content with the definition by N.V. Vasileva in which *term* is considered a nomination of a special sphere of use. The sign of relevance to a special concept is also found in the definition given by V.A. Tatarinov that *term* can be defined as a language sign (word or word combinations) correlated with a special concept, phenomenon or subject. The same feature is contained in the definition of *term* given by V.D. Tabanakova, in which besides this, a sign 'scientific' appears and *term* is considered as a sign that is very significant, it is about the expression of a special concept and the reflection of the

place of this concept in the system of concepts: a scientific term is a sign expressing a special concept and reflecting the position of this concept in an appropriate system of concepts.

In the definition of *term*, which is formulated by A.S. Gerd, there is also a sign 'scientific' and *term* is considered as a conditional sign, which brings this definition closer to the definition of *term* given by V.D. Tabanakova, namely, a scientific term is a sign to which one or another meaning is attributed conditionally, by a collective agreement.

According to V. M. Leychik *term* is a lexical unit of a certain language for special purposes, denoting a common-specific or abstract concept of the theory of a specific special field knowledge or activities [6].

From O.S. Akhmanova's point of view *term* is a word or a phrase of special (scientific, technical and etc.) language created (accepted, borrowed, etc.) for the exact expression of special concepts and designation of special objects [3].

There is a well-known point of view according to which *term* has special formal and semantic properties. Such a definition of *term* is formulated by B.A. Plotnikov, who supposes that *term* is a word with special formal and semantic properties. He attributes two main points to the formal features of the term. Firstly, the fact that terms express scientific and technical concepts not only by individual lexical units, but also by their combinations (compound terms). Secondly, in the language of science and technology, as a rule, nouns are considered to be terms, but terms belonging to the other parts of speech can be also formed from them. According to B.A. Plotnikov, the semantic feature of terms is that the meaning of terms has a manifest denotative nature. In other words, this aspect of the meaning of *term* is always in the foreground. B.A. Plotnikov's opinions about special formal and semantic features of *term* seem to us convincing.

As it can be seen while defining the word *term* the notion *scientific* is often mentioned among a lot of other features of *term*.

The language of science is nominated as an independent functional variety of the general literary language a great number of researchers. The vocabulary of the language of science, like all other varieties of the general literary language, is not the same type. Three relatively independent types are distinguished in it:

- 1) Non-terminological vocabulary (significant and official words of the general literary language);
- 2) General scientific vocabulary (special words of a scientific sphere of communication in general);
- 3) Terminological vocabulary (special words of specific branches of knowledge).

The general position of all studies of terms of science is as follows:

- a) Terminological vocabulary is a totality of special denominations combined in terminological systems.
- b) Each term system reflects the categorial apparatus, the system of concepts of a specific science, scientific direction, school and concept.
- c) Terms, undoubtedly, constitute the main distinguishing feature of the vocabulary of the language of science. This is the most informative part of this language.

From V.P. Danilenko's point of view, there are five specific features of *term*. They differ as follows:

- 1) Semantic: terms refer only to special concepts;
- 2) Functional: terms have not only a nominative, but also a definitive function;
- 3) In accordance with the sphere of distribution: terms serve only as a means of professional communication in its direct function;
- 4) According to the sources, methods and means of creation: scientific terms, in addition to general literary sources, methods and means of their creation, have their own specialized resources that do not find application in other varieties of the general literary language;
- 5) In terms of the semiotic composition of denomination units: in terminology, symbols going beyond the scope of verbal means of expression are used widely [5].

Linguistics takes a special position in the system of the humanities. According to N.B. Gvishiani, it is due to the specifics of the subject of study, since linguistics is characterized by three main stages of scientific research including the study of linguistic facts, the creation of concepts, the development of metalanguage. This is the difference of linguistics from the abstract sciences logic and philosophy, in which research begins from the second stage, from the consideration of generalizations considered the direct object of study. First of all, linguistics is a discipline that studies the phenomena of human speech.

In theoretical terminology there is a postulate of an ideal term, according to which the term must have the whole range of qualities in contrast to vocabulary units of a common language: brevity, systematicity, unambiguity, lack of emotional coloring and independence of context, and only under such a condition it can fulfill the main function to express a special concept exactly.

In addition, among the properties that distinguish a term from a non-term, according to D.S. Lotte is that terminological vocabulary is unaffected to the process of polysemy and synonymy that are characteristic for a general literary language and all cases of their demonstration in terminological systems are considered as shortcomings to be eliminated [7].

Another list of ideal requirements for the term is given by V.D. Tabanakova. Based on the sign of the term, it is attributed the following properties: accuracy; unambiguity within one terminological system; lack of ideographic synonyms; a lack of emotionality (that distinguishes it from professionalism); motivation, which is determined by the fact that the terms are secondary denomination; nominativity - the function of designation of a special concept that is implemented independently of context; definitivity - when the meaning of a term is formulated as a logical definition; consistency - the feature to occupy a certain place in a system of terms which, in turn, is determined by a certain place of a special concept denoted by a term in a system of special concepts; systematicity - the property of reflection systematicity at morphological level.

The terminologists, who develop a complex of ideal requirements for *term*, notice that there are more or less deviations from an ideal in the practice of creation and use the term. Therefore, we can state that in general, both the properties of the term and the requirements for it represent certain trends that are realized to a greater or lesser degree.



A significant contribution to the activity of the national terminology in Uzbek linguistics was made by research of N. Mamatov, S.F. Akobirov, A. Hojiev and R. Doniyorov.

According to A. Madvaliev *term* is a word or phrase that is a clear and stable expression of a specific concept specialized in the field of science, technology or profession [9].

A. Hojiev's states that *term* is a word or phrase that is clear to an understanding of something related to science, technology or another field whose field of activity is limited to these areas. Terms differ from ordinary words according to what they mean and do not have emotionality [10].

In the process of studying the definitions thoroughly, it can be concluded that the whole list of ideal characteristics of *term* deserves an attention. In some definitions of *term*, the authors identify two or even more essential features which all of them are considered to be the most specific for the *term*.

Having analyzed basic concepts related to the *term*, we have come to the following conclusions:

1. The term can be a word, phrase or symbol of non-verbal nature;
2. It has a sign of belonging to a special concept;
3. The term requires a definition;
4. It possesses the sign 'scientific';
5. The term is involved in a system of terms;
6. It has got a conventional character.

We formulate our own, definition of *term*: A scientific term is a language sign (word or phrase) that has got a specific nominative and definitive functions and reflects the position denoting concepts in the system of concepts of science according to its denotative and significative content and in an appropriate terminological system.

## CONCLUSION

Thus, it can be confirmed that terms are formed both on the basis of the natural national literary language and on the basis of an inventory of specific means of expression of special concepts, which is created by researchers on the basis of existing and new material in each branch of knowledge, primarily universal - international. To understand and explore the peculiarity of terminological systems of specific directions, terminology comes from the specifics of a particular scientific field, in our case, linguistics.

## REFERENCES

1. Cabre M. Teresa Terminology: Theory, methods and applications - Amsterdam: John Benjamins, 1990. – 247 p.
2. Pearson J. Terms in Context – Amsterdam / Philadelphia: John Benjamins, 1998. — 258 p.
3. Ахманова О.С. Словарь лингвистических терминов – М.: Советская энциклопедия, 1966. – 608 с.

4. Виноградов В.В. Русский язык: учебное пособие. — 2-е изд. — М.: Высшая школа, 1972. — 601 с.
5. Даниленко В.П. Русская терминология: Опыт лингвистического описания – М., Наука, 1977. – 246 с.
6. Лейчик В.М. Терминоведение: Предмет, методы, структура. Изд. 4-е. — М.: Книжный дом «ЛИБРОКОМ», 2009. — 256 с.
7. Лотте Д.С. Основы построения научно-технической терминологии. М.: Изд-во АН СССР, 1961. – 157 с.
8. Реформатский А.А. О реальности модели // Проблемы лингвистической типологии и структуры языка, – Л., 1977. – 200 с.
9. Мадвалиев А. Ўзбек тилининг изоҳли луғати – Т.: Ўзбекистон миллий энциклопедияси, 2006-2008.
10. Ҳожиев А. Тилшунослик терминларининг изоҳли луғати – Т.: Ўзбекистон миллий энциклопедияси, 1985. – 164 б.

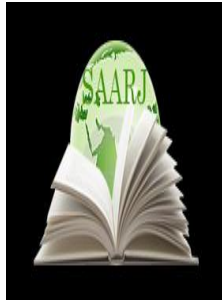

**ACADEMICIA**  
**An International  
 Multidisciplinary  
 Research Journal**  
 (Double Blind Refereed & Peer Reviewed Journal)



**DOI: 10.5958/2249-7137.2021.01070.3**

## NEWS MEDIA TEXTS IN CONTEMPORARY ENGLISH: COGNITIVE SEMANTIC AND LINGUOCULTURAL CHARACTERISTICS

**Khilola Otakhonova\***

\*Master's Student,  
 Uzbekistan State University of World Languages,  
 Tashkent, UZBEKISTAN

### ABSTRACT

*This article discusses the cognitive semantic and linguocultural features of media texts for modern English news. The article also gives examples of cognitive semantic and linguocultural features and discusses this topic. A unique type of human speech activity is fiction. Linguocultural analysis plays an important role in the study of his language. Linguocultural can be understood as a branch of philology that studies the aesthetic features of an artistic context. The subject of Linguocultural is the set of language tools used by the author in a work of art to achieve his ideological and artistic goal. The aesthetic effect of a work depends not on what the text is about, but on how it is narrated. The purpose of Linguocultural analysis is to determine how the author uses this or that linguistic unit in the process of artistic creation, and how this or that phrase creates an aesthetic effect.*

**KEYWORDS:** *Linguocultural, Information Technology, Communication Technologies, Media Linguistics, Traditional Media - Print, Radio, Television, Baltic Countries, Central Asia And Eastern Europe.*

### INTRODUCTION

The formation and development of media linguistics as an independent direction in modern linguistics is due to a number of factors, both linguistic and 4 related to information technology and socio-cultural spheres of public life. Among the most significant prerequisites for the emergence of media linguistics are the following:

- The rapid growth of information and communication technologies (ICT), expressed in particular in the creation of a global network of media communication;

- Formation and development of a single information space as a new virtual environment for text communication;
- The formation and scientific understanding of the concept of “language of the media”, the definition of its functional and stylistic features and internal structure;
- Awareness of the need to apply an integrated approach to the study of media speech, based on combining the efforts of representatives of different humanitarian disciplines;
- Consideration of studies of the language of the media in the framework of media studies (media studies) - a new independent discipline, the subject of which is a comprehensive analysis of the historical development, current state and features of the functioning of the entire complex of mass media.

### **The role of the media in the dynamics of language processes.**

The second half of the XX - beginning of the XXI century is characterized by the rapid growth of mass communication and new information technologies. The dynamic development of traditional media - print, radio, television, the emergence and spread of the World Wide Web - the Internet have led to the creation of a single information space, a special virtual environment formed by the aggregate of many media streams. All this could not but affect the processes of production and distribution of the word, on the features of speech use and the nature of linguistic changes. The main volume of speech use today falls on the sphere of mass communication. Mass media texts, or media texts, are one of the most common forms of modern language use, and their total length far exceeds the total volume of speech in other spheres of human activity. At the same time, the corpus of texts produced and transmitted daily through the media continues to grow steadily. This, in particular, can be judged by quantitative indicators: the number of television channels is growing (in the United States it reaches seventy-five, including cable television), their further specialization is taking place - there are mainly news channels (for example, CNN - Cable News Network), entertainment (MTV), sports (Eurosport), educational (Discovery Channel), music, etc. New radio stations appear, new newspapers and magazines appear, designed both for a wide audience and for satisfying the interests of a wide variety of age, professional and social groups. Communication on the World Wide Web makes a huge contribution to the constant growth of the mass of media speech. The proliferation of online versions of printed publications, the emergence of online publications - all this contributes to an increase in the total number of texts functioning in the world information space, which is considered by researchers as a special sphere of speech use, which has its own characteristics and characteristics. The concept of a single information space is of key importance for understanding the dynamics of linguistic changes, since it allows us to present the multifaceted activities of the world and national mass media in the form of a single, integral system, the functioning of which has a significant impact on the course of linguocultural processes. In modern science, to designate this new virtual territory without state borders and tangible barriers, a whole set of terms and concepts are used that relate to one semantic series, but emphasize one or another side of mass communication processes, such as: information space, information environment, information field, media environment, media landscape, infosphere. The concept of a single information space allows you to better understand the laws of movement of information flows, as well as to present a holistic information picture of the world in dynamics. The most important component of the world information space is its linguocultural component, the importance of

which is difficult to overestimate, since any verbally expressed information is the embodiment of a certain language and culture. Understood as the area of distribution of a particular language and culture in the global media landscape, the concept of a linguocultural space allows us to demonstrate the actual discrepancy between the boundaries of territorial, state and the boundaries of information spheres of influence. Thus, the real contours of the Anglo-American linguocultural space go far beyond the territories of the respective states due to the huge coverage of English-language media broadcasting and the spread of the Internet.

### **The Main Findings and Results**

Linguocultural can be defined as a branch of philological science that studies the aesthetic properties that form language units in an artistic context. As long as the researcher works with non-artistic, non-verbal discourse, his perception can be generally described as a direct understanding of language units as a whole in terms of content and expression. If we are meant to read a literary text, then our perception moves from one side of linguistic perception to another, shifts, rises to a new level. Once the various elements of language are incorporated into the realm of word art, they change in the course of demonstrating the possibility of the aesthetic task entrusted to them. Both of these words become the subject of Linguocultural analysis when they undergo aesthetic changes in the text under study in accordance with the author's idea.

At the semantic level, language units in their own right imply a study in the correct sense; it is a linguistic analysis of the word in the language in which the text is created. At the metasemiotic level, we move on to the study of the process of their activation in speech (in which the main focus is on the additional content, connotations, which they form directly in speech). In this scientific article we will consider how the word demonstrates its aesthetic position in practice, how it becomes a tool of figurative thinking, on the example of the romantic poems of the Great Russian poet A.S. Pushkin and their translations into Uzbek. Scholars point out that the ability to study the perception of the scope of the aesthetic influence of this or that text during its translation into several languages gives an effective result. The study of a text within two or even three languages makes it possible to identify its properties that are not expressed in one language. It is possible that the translation of the text does not provide new information about its properties and essence, but with the help of translation it is possible to get a deeper impression of the text. Indeed, the translated text, enriched by several generations of translators, is undoubtedly important, in which, along with the best translations, unsuccessful experiments also play an important role. L.N. Tolstoy gives an example in this sense: he realizes the perfection of the text only after reading Pushkin's poem "Gypsies" in French: the comparison reveals to the great writer the unexpected, new aesthetic features of the poem. The result of the collapse of the USSR was not only changes in the state and socio-political nature, but also noticeable changes in the existing culture and information space, which, in particular, resulted in a significant reduction in the presence of the Russian language and culture in the Baltic countries, Central Asia and Eastern Europe.

Thus, speaking about the role of the media in the dynamics of linguistic processes, it must be emphasized that we mean not only and not so much the changes caused by the introduction of new information technologies, but qualitative transformations in the general linguocultural situation. In turn, assessing the impact of modern mass media on the course of linguistic processes, it is possible to distinguish between the following three levels of analysis: 1) geolinguistic, 2) interlinguistic. ***The geolinguistic level***, as the name implies, involves an analysis

of how the media influence the state and development of the general linguocultural situation in the world and in the regions. Here, attention is focused on such important quantitative and areal indicators as a change in the number of speakers in a particular language, a redistribution of linguistic spheres of influence, an increase in the role of some and a decrease in the role of other languages in the world information space. At the interlinguistic or interlanguage level, researchers are interested in the issues of interaction and mutual influence of languages, mechanisms and methods of borrowing are studied, as well as functional styles and spheres of speech that are most susceptible to foreign language influence. *Intralinguistic level*, or intralingual, allows you to focus on media-conditioned linguistic processes within one linguistic-cultural area. These include: a tendency to blur clear style boundaries, the spread of colloquial style norms in the basic corpus of media speech (news, information analytics, commentary), the replication of erroneous speech use (for example, wrong stress, grammatical errors and incorrect collocation), a decrease in the speech norm due to the use of in the media with reduced and profanity, etc. Let's dwell on each of the listed levels in more detail. One of the main features of the modern geolinguistic picture of the world is the indisputable dominance of the English language, which manifests itself, among other things, in the field of mass communication. The total volume of English-language media texts, due to a number of economic, political and socio-cultural reasons, significantly exceeds the volume of mass media texts in other languages of the world. So, instant reaction to events anywhere in the world, their objective coverage helped the American world news channel (CNN) to gain popularity among viewers around the world. This channel broadcasts in English. BBC World enjoys a reputation as one of the most objective news channels, which is why it is watched in Western Europe, the United States and other countries around the world. Since the beginning of the 90s in connection with significant socio-economic changes, English-language media are becoming more widespread in Russia. In the mid-90s, foreign journalists working in Moscow created the Independent Media company, which publishes the popular publications The Moscow Times, The Moscow Tribune, The St. Petersburg Times, Capital, and also oversees the release of Russian-language analogs of well-known magazines: "Cosmopolitan", "Good Housekeeping" and others. All this testifies to the further integration and globalization of international information systems and is reflected in the course of language processes, the qualitative aspect of speech use, the movement of language norms, as well as the interaction of languages and cultures. The globalization of the world information space has contributed not only to a significant expansion of the sphere of influence of the English language, but also to its transformation into a generally recognized language of international communication - the lingua franca. Currently, English has become the language of international business and trade, politics and diplomacy, science and information technology, media, popular music, show business, sports and education. Today it is hardly possible to find an area of human activity in which the English language would not have a dominant meaning. The global role of the English language in the modern world is perfectly described by the famous English linguist David Crystal in his book "English as a Global Language", noting the role of the media in promoting and spreading the English language and mass culture in national media landscapes. Indeed, the total number of media texts in English, distributed daily through media channels, significantly exceeds the number of texts in other languages, and in the national mass media of almost all countries of the world, there is an expansion of samples of English-language mass culture. The Beatles, Madonna, Backstreet Boys, Spice Girls, etc. - a constantly updated list of popular songs in English is well known to a mass audience both in the West and in Russia. In

this regard, the concept of linguistic imperialism, which arose within the framework of the Western European academic tradition in the early 90s of the XX century, as a reaction to a completely positive assessment of the global role of English in the modern world, is of certain interest. The concept of linguistic imperialism, formulated by the English researcher Robert Phillipson in his book "Linguistic Imperialism," considers the dominant role of the English language in the modern world as an expansion in relation to other languages and cultures. The author notes that the rapid increase in the share of the English language in the world linguocultural space is influenced by a number of political and economic factors: from the colonial domination of the British Empire and the transformation of the United States into a world superpower to the information technology revolution and the rapid development of transport networks. Explaining the "world domination" of the English language mainly for socio-economic and political reasons, as well as the advancement of the national interests of the most powerful English-speaking countries - the United States and Great Britain, Robert Phillipson emphasizes that the expansion of the English language causes irreparable damage to other national languages and cultures.

So, for example, from the point of view of the general typology of speech for mass media texts, in addition to the stable opposition of oral text - written text, monologue text - dialogical, the dichotomy of the author's text and the non-author's, corporate text turns out to be extremely important. In general, in the field of mass media, the category of authorship takes on special significance, since most informational texts are distributed here not on behalf of a specific person who created the text, the author, but on behalf of a corporate one, on behalf of a certain media structure that distributes this text to a mass audience. The main feature of corporate texts is that, regardless of whether they are compiled by one specific author or a group of people, they are always distributed to a mass audience on behalf of a whole team or organization, be it a newspaper editorial office, a radio station, a TV program, a news agency, etc. P.A typical example of such non-author's collegiate text is the messages of news agencies, which are an integral part of the daily information flow. On the pages of any newspaper you can find corporate texts like:

**1) London. Reuters.**

*According to a public opinion poll, most residents in the English capital believe that the monarchy should be "modernized and that members of the royal family should not receive funds from public funds.*

**2) London. The Associated Press.**

Two more bombs exploded in London early Monday, causing no injuries but prompting fears that the Irish Republican Army was stepping up an offensive against the capital's tourist areas.

The explosions followed a series of similar small bomb attacks in the past 10 days carried out by the IRA as part of its campaign to end British rule in Northern Ireland. The first explosion in the early hours on Monday occurred near the Novotel hotel in Hammersmith, West London. The second explosion came about an hour later. Police said it appeared to have been caused by a device planted near Leicester Square.

Texts of this kind are extremely common in all media - in print, radio, on television, as they represent a "finished information product" - the result of the activities of the largest news

agencies that control the world information market, such as Reuters, The Associated Press, Agence France Press, Itar - TASS, etc. They fill the news pages of newspapers, in particular the news in brief columns, from which radio news and television news programs are made. Corporate texts can vary in length: from extremely short 15-20 words to fairly detailed messages of 100-150 words with a more complex internal structure, involving the use of direct quotation and indirect speech, for example:

***Fire Damages British Art Academy***

***The Associated Press, London.***

A fire Saturday damaged part of the Royal Academy of Arts, one of Britain's major art institutions although gallery officials said no art was believed to be damaged. Fire swept through two galleries on the first and second floors of the academy's historic building, Burlington House, in Piccadilly, central London. "The fire was brought under control fairly quickly but the walls are blackened", said David Gordon, secretary of the academy. "There were about 30 to 40 paintings stacked up in the gallery that were removed by firemen and staff", Gordon Added. "The art work has not been damaged," said Bruno Bruniges, assistant divisional fire officer. Gordon said the two galleries damaged were to house the academy's summer exhibition.

The content of corporate texts naturally reflects the entire palette of the information flow and covers all the thematic blocks (topics) presented in the media: politics, business, finance, sports, culture, scandals, incidents, as well as events, which in English-language journalistic practice are usually called "human interest stories", Such as the following message about the tricks of the cat belonging to the Prime Minister of Great Britain.

Advertising texts are located closest to the "impact" pole on the conditional message-impact scale. Possessing clearly marked features at all levels - at the level of language, format and content - advertising texts easily stand out against the background of the general text flow of mass media. The specific features of advertising texts are due to their explicit focus on impact. To influence the mass audience through the media in order to convince them to purchase certain goods and services - this is the main goal of advertising texts. From a functional point of view, advertising texts seem to combine the implementation of two functions of influence: the function of influence as a function of the language, realized with the help of the entire arsenal of linguistic means of expression, and the function of influence as a function of mass communication, denoted in the English-speaking tradition by the stable term "persuasion" or "persuasive function"(function of persuasion or influence with the purpose of persuasion) and implemented with the use of all the latest technologies of influence available to a particular media.

**Linguistic features of advertising texts.** As already noted, the effectiveness of an advertising text depends on the successful combination of all its constituent components: image, sound, image, verbal fabric. At the same time, the researchers note the paramount importance of the verbal component of the advertising of the verbal text. "The verbal part of an advertisement is sometimes more significant than its visual aspect," writes English author Gillian Dyer. Indeed, the importance of verbal language for advertising is extremely important: after all, it is only thanks to the verbal text that the key advertising idea gets its real embodiment, in other words, it starts to "work". For example, the meaning of the trick with a cow running away from a picnic in a TV ad for Heinz ketchup becomes clear only when the inscription "80% of all cows in the world are eaten with Heinz ketchup" appears. Of course, ad images grab the consumer's attention



and convey some of the key points AD. But it is thanks to verbal signs that these key points are conjectured strictly according to those advertising communicative intentions that the advertiser had in mind and that were developed by the advertising agency. The verbal part of the advertising text has an internal structure: as a rule, it is the headline, the main advertising text and the echo phrase. The purpose of an advertising headline is to grab the audience's attention and generate interest in the advertised product or service. An advertising headline contains an advertising message and a main advertising argument, which subsequently develops in the main advertising text, for example:

*Carlsberg. Probably the best beer in the world., Philip Morris.*

*The Universal Taste of Lightness, EFG Private Bank: ... in tune with our clients. Business knows no boundaries.*

*Neither do We. The Economist, an investment bank of global intelligence,*

*Warburg Dillon Bank. Some of the most valuable things in life are virtually invisible. Mitsubishi Electronics.*

Based on the selection of facts, the range of linguistic media technologies for creating images is unusually wide. It includes the whole range of ways to form an image, using both the capabilities of various media and the means of language. The combination of linguistic means with media significantly enhances the overall effect of the impact, contributing to the creation of vivid memorable images. So, in television programs, the choice of video sequence not only illustrates the content of the verbal part of the text, but also helps to form a certain image. For example, the BBC correspondent's report on the new Russia in the program "From Our Own Correspondent" is accompanied by footage in which the viewer sees the Government House through a massive grid; The Kremlin, ominously covered by the palm of the figure of the monument to Minin and Pozharsky; a sculpture of a Worker and a Collective Farm Woman against the backdrop of a huge Nescafe billboard and a demonstration with red flags.

## CONCLUSION

In conclusion, it should be said that the study of mass media texts using the methods and techniques discussed in this article makes it possible not only to identify the national and cultural specifics of the text, but also to consistently describe it from the point of view of the interaction of cultures, manifested at all structural levels - language, format, content.

## REFERENCES

1. Shamsitdinova, M. G. (2020). Intercultural Communication And Problems Of Teaching English To The Students-Nonlinguists. *Theoretical & Applied Science*, (4), 1024-1026.
2. Shamsitdinova, M. (2021). Difficulties In Teaching Law Students Listening Comprehension In English Language Teaching. *The American Journal of Political Science Law and Criminology*, 3(01), 1-8.
3. Shamsitdinova, M. (2021). Difficulties In Teaching Law Students Listening Comprehension In English Language Teaching. *The American Journal of Political Science Law and Criminology*, 3(01), 1-8.

4. Nig'monov, A., Rustamiy, S., Nasirova, M., & Djafarov, B. (2020). Lexical Parallels Used In The Quatrains In The Dīwān Lughāt Al-Turk. *European Journal of Molecular & Clinical Medicine*, 7(3), 5301-5305.
5. Sabirova, M., & Saparniyazova, M. (2021). Naming Of Newspaper Text: Pragmatic Properties Of The Title. *The American Journal of Social Science and Education Innovations*, 3(02), 18-22.
6. Esanovna, D. L., & Saparniyazova, M. (2019). Naming: The Technology of Creating a Name in the.
7. Лутфуллаева, Д. Э., & Сапарниязова, М. (2020). Проблема ассоциативного подхода к языку на современном этапе узбекского языкознания. *Вопросы когнитивной лингвистики*, (2), 139-146.
8. Давлатова, Р. Х. (2020). ПРОСТРАНСТВЕННЫЙ ДЕЙКСИС И ЕДИНИЦЫ ЕГО ВЫРАЖЕНИЯ В УЗБЕКСКОМ ЯЗЫКЕ. In *Colloquium-journal* (No. 6-5, pp. 37-39). Голопристанський міськрайонний центр зайнятості= Голопристанский районный центр занятости.
9. Лутфуллаева, Д., Давлатова, Р., & Тожибоев, Б. (2019). Ассоциативный словарь узбекского языка. *Ташкент: «NAVOIY UNIVERSITETI*.
10. SAIDAZIMOVA, U. T. (2021). The issue of two women in the korean art world. *Journal of Contemporary Issues in Business and Government*, 27(3), 303-308.
11. Turakhanovna, S. U. (2020). The Issue of Literary Heroism in Korean Literature. *Solid State Technology*, 63(6), 1779-1785.
12. Saydazimova, U., & Murodova, D. (2021). In Lee Bom Son's Story "Stray Bullet", the Issue of the Negative Consequences of the Civil War is Highlighted. *Psychology and Education Journal*, 58(1), 1138-1144.

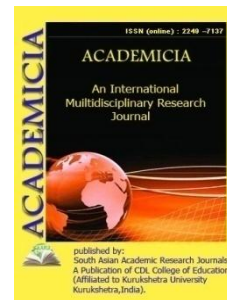
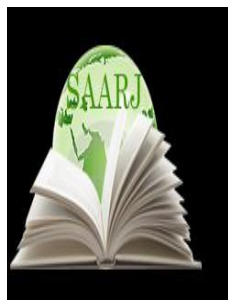

DOI: **10.5958/2249-7137.2021.01059.4**

## THE PECULIARITIES OF USING DISTANCE LEARNING AND INDEPENDENT WORK IN TEACHING PROCESS

**Yusupova Shakhnoza Abdukhafizovna\***

\*Senior Teacher,  
Head of the Chair of “Methodology of teaching foreign languages”,  
Samarkand State Institute of Foreign Languages, Samarkand,  
UZBEKISTAN

### ABSTRACT

*The present article is devoted to embedment of distance education which is a kind of self-study and self-regulating learning process. The author pays attention to the advantages and peculiarities of using distance learning format in the system of education. The article has got an important actuality in the conditions of recent pandemy. The specifics of each model of the distance learning process determine the selection and structuring of the content of training, methods, organizational forms and means of training. Currently, all of these models of distance learning are observed in the practice of education both abroad and in our country.*

**KEYWORDS:** *Distance Learning, Educational Process, Self-Study, Independent Work, Module, Network Database.*

### INTRODUCTION

**Actuality of the theme of the research.** Modern educational paradigms are based on scientific and theoretical concepts that reflect the main features of reality. These include personality-oriented learning, individualization and differentiation of learning activities, formation of learning motivation, self-development of students, etc. These conceptual ideas of education are successfully implemented in the modern information and educational environment, which provides the organization of the educational process with the help of information and communication technologies.

**The aim of the research** is to investigate the advantages of the distance learning in teaching foreign languages and peculiarities of self-study in learning foreign languages.

Modern paradigms of teaching foreign languages reflect the main features of the modern education system [1, p. 926]. Training highly qualified specialists is one of the urgent tasks today. Let's consider distance learning as one of the most relevant areas of modernization of education, as well as the features of distance learning in foreign languages.

**The object of the research** is the process of distance learning, its advantages and lacks.

Distance learning is a way of independent study or self-study which is a form of learning aimed at strengthening the acquired knowledge, skills and abilities, learning of additional information or material [2].

**The task of the research:** to define the role of distance learning and independent work in modern methodology of teaching foreign languages; to study the advantages of distance learning process in teaching foreign languages; to work out methodical and didactic recommendations in using distance teaching of foreign languages.

Independent activity serves to form the knowledge, skills and competencies that are defined in the curriculum of a particular subject and should be mastered by the student, performed in the classroom or outside the classroom on the advice and recommendations of the teacher. Depending on the nature of the science, assignments are developed for independent work.

Self-directed learning serves to form the knowledge, skills and competencies that are defined in the curriculum of a particular subject and should be mastered by the student, performed in the classroom or outside the classroom on the advice and recommendations of the teacher. Depending on the nature of the science, assignments are developed for independent work.

## RESULTS AND DISCUSSION

The specifics of the subject "Foreign language" correlates with the specifics of distance learning, the main features of which are network interaction of all participants in the educational process and a relatively large amount of independent work carried out in the "Just in time" mode, interactivity, selection and structuring of educational material (authentic texts), pedagogical technologies, etc. Working with information based on reading texts and watching videos in a foreign language allows you to use Internet resources, expanding the content of the textbook with authentic and up-to-date information (the latest events in the world (sports, cultural, political, etc.), texts of native speakers (speeches of political figures at conferences, seminars, information from leading TV shows, films, videos, electronic libraries, etc.).

Up-to-date information helps to increase motivation to learn a foreign language. The potential number of individual educational trajectories in this case is significantly greater than in traditional education. However, at present, not every text from Internet resources can be used in the educational process, since not all texts are suitable directly for educational purposes [3, p.72]. It is possible to increase the volume of speech communication or the density of communication in a foreign language both orally and in writing by means of Internet technologies (blog, forum, chat, Skype, etc.), multimedia means within the framework of integration of full-time and distance learning; within the framework of a single information and educational environment of general and additional education, as well as in specialized training (elective course, network model of distance learning).

One of the requirements for the content of a modern foreign language textbook is the availability of tasks related to project activities. On the one hand, such tasks contribute to the development of creative, research activities, on the other hand, to the formation of information and communication competence of schoolchildren, since in the course of project research, as a rule, educational resources of the Internet are involved, which, in turn, require the ability to work with information. Communication with native speakers plays a significant role in the mastery of a foreign language by schoolchildren and students. It is participation in international educational projects that allows you to communicate in a foreign language with peers of foreign countries, native speakers [6, p.562].

Computer technologies, Internet resources, digital devices, Web 2.0 technologies, and distance learning are increasingly used in the education system. However, the unsystematic, unregulated use of modern information technologies in the educational process reveals a pedagogical problem: the lack of teachers' clear understanding of what didactic, psychological and pedagogical tasks can be solved with the help of new technologies. The process of implementing distance learning in the education system in different countries has its own characteristics. This depends on the state policy of the country: either distance learning is recognized as a form of education along with other forms of education, or distance learning technologies are used in the education system as a means of learning.

Distance learning is a form of learning in which the interaction of teachers and students and students with each other is carried out at a distance and reflects all the components inherent in the educational process (goals, content, methods, organizational forms, learning tools), implemented by specific means of Internet technologies or other means that provide for interactivity [5, p. 201].

Distance learning technologies are understood as educational technologies (Moodle, Zoom, etc.) implemented mainly with the use of information and telecommunications networks in the indirect (at a distance) interaction of students and teaching staff. E-learning is understood as the organization of educational activities with the use of information contained in databases and used in the implementation of educational programs and providing its processing of information technologies, technical means, as well as information and telecommunications networks that ensure the transmission of this information over communication lines, interaction between students and teaching staff.

The choice of the model depends on the objectives of the training and on the conditions under which it is possible to carry out distance learning. Depending on the training model used, the activity of the teacher changes. The specifics of each model of the distance learning process determine the selection and structuring of the content of training, methods, organizational forms and means of training. Currently, all of these models of distance learning are observed in the practice of education both abroad and in our country. Let's turn to teaching foreign languages in the modern information and educational environment. It has its own characteristics, which are due to the specifics of the subject "Foreign language". The specificity of the subject "Foreign language" is primarily related to the fact that the leading component of the content of teaching a foreign language is not the basics of science, but the methods of activity – teaching various types of speech activity: speaking, listening, reading and writing.

Academician L.V. Shcherba points out that teaching a foreign language is teaching a certain activity and the specificity of the subject consists in mastering speech, communication, and the formation of speech-thinking activity [7, p. 89].

The authors of the issue "Methodology of teaching foreign languages", edited by A.A. Mirolubov [4], also highlight the volume of educational activities necessary for successful communication in a foreign language as the specifics of the subject "Foreign language". It is obvious that a high density of communication, maintained for a long time, provides a large amount of communication. These features are interrelated.

Distance learning of foreign languages, based on the use of information and communication technologies, is increasingly included in the practice of various educational institutions. The main feature of distance learning is the mediated nature of teacher - student telecommunications communication and the associated limited opportunities for their interpersonal interaction. This form of training allows you to maximize the independent work of students, which is especially important in the conditions of university training, since the future specialist must be able to independently organize their cognitive activities.

Currently, in the remote form of teaching foreign languages, such remote technologies as: modular technology, which is based on the organization of independent cognitive activity of students, the development of training modules of a particular course, are widely used.

Web-quest technology is focused on the maximum practical activity of students and is a role-playing game, for which information resources of the Internet are used. A special place among innovative educational technologies is occupied by the modular technology of professional training.

Modular training is characterized by advanced study of the material in enlarged blocks-modules, algorithmization of educational activities, completeness and consistency of activity cycles. The modular program consists of blocks that are formed from a set of modules, and the modules in turn consist of topics of educational material united by one topic and intended for study by students with different levels of knowledge:

The training module consists of the following components:

- 1) The name of the module;
- 2) The integrating didactic goal;
- 3) The target plan of students' actions;
- 4) The information basis (the actual educational material in the form of a training program);
- 5) Methodological guidelines for achieving goals;
- 6) Practical exercises for the formation of the necessary skills;
- 7) Output control (control work that strictly corresponds to the goals set in this module).

The process of modular training is focused on the formation of ways of educational work through training in the skills of rational implementation of practical actions through a specially organized system of exercises. The modules of each stage should be introduced gradually, according to the degree of increasing difficulties and as students study the core disciplines.

In view of the logical sequence and continuity of all stages of language training, the modular nature of training contributes to the systematic mastery of linguistic material, the expansion of

the background (linguistic and cultural studies, professional, cultural studies, etc.) knowledge of students, and the improvement of skills in the main types of speech activity. Teaching a foreign language using modular technology allows you to comprehensively solve such urgent pedagogical tasks as ensuring an individual pace of learning, taking into account the capabilities, inclinations and needs of the student, teaching the skills of independent work with different sources of information, independent development of the material and, consequently, the acquisition of high-quality knowledge and skills. Currently, the task of the teacher is not only to equip students with modern knowledge, but also to teach students to extract this knowledge independently, to be able to assimilate it, based on what they have already learned.

To achieve these goals, the Web Quest technology is used, which is used in both school and university teaching practices. The rating system for assessing students' knowledge includes regular monitoring of the knowledge and skills of each student, with the assignment of a rating depending on the quality of training as the discipline is studied during the academic period. It is the main part of the complex of continuous multi-level education and is designed to organize the educational process based on learning technologies that activate the independent work of students. Employees of higher education institutions can now develop web-based quests for correspondence and distance learning students, which are included in the list of tasks for self-completion. They can also be used for extracurricular work in the full-time department. Students complete the completed tasks in the form of a foreign language test for a certain semester. Then the test papers are checked and evaluated by the teacher.

In addition to the above programs, the following distance learning technologies for foreign languages are widely used:

case-technology, which is a close analogue of the technology of distance learning (when a student receives a special set of teaching materials (case) for self-study and periodically consults with teachers in regional training centers created for this purpose;

TV-a technology that uses television lectures and consultations with teachers.

A network technology based on the use of the Internet for consulting students and transmitting educational and methodological materials to them. Thus, it should be emphasized that pedagogical education today needs pedagogical technologies that provide effective training of specialists who are competitive in the market. The success and quality of distance learning in foreign languages largely depend on the effectiveness of the organization and the methodological quality of the materials used, as well as the skill of the teachers involved in this process. Distance language learning emphasizes the importance of developing the ability of learners, where language is the ideal basis for practical communication, an important principle of which should be the principle of ethical duty.

Students' self-study plays an important role in cultivating a conscious attitude of students' execution mechanisms to the acquisition of theoretical and practical knowledge, strengthening the habit of mental work focused on them. It is very important that students not only learn, but also master the ways to get it.

Independent work always poses a number of challenges to students, especially freshmen and sophomores.

The main difficulty is related to the need to organize their work independently. Most students face difficulties related to the individual characteristics of their mental activity and physiological capabilities, almost complete lack of psychological readiness for independent work, ignorance of the general rules of its organization, work with key sources, ability to express themselves clearly and concisely, lack of analytical skills is coming.

Therefore, one of the main responsibilities of a teacher is to help students organize their independent work. This is especially important in the modern context of the development of society, in which the specialist engages in self-education after graduation - increasing his level of knowledge through self-study.

Students' self-learning is carried out for the following purposes:

- systematize and consolidate the acquired theoretical knowledge and practical skills;
- deepening and expanding theoretical knowledge;
- formation of skills in the use of normative, reference documents and special literature;
- developing students' cognitive abilities and activism: creative initiative, independence, responsibility and organization;
- formation of independent thinking, self-development, self-improvement and self-awareness skills;
- developing research skills.

There are two types of independent work in the learning process, such as in-class and out-of-class. Independent work in the classroom is carried out under the direct supervision of the teacher and on his assignment. At the same time, students are provided by the teacher with the necessary textbooks, didactic materials, including manuals and methodological developments. Independent work outside the classroom is carried out by the student on the instructions of the teacher, but without his direct participation.

Independent work includes: preparation for classroom lessons (lectures, practical, laboratory, seminar classes) and performance of relevant tasks; independent work on specific topics of academic disciplines in accordance with future thematic plans; preparation for practice and performance of tasks provided in practice; execution of written control and term papers, electronic presentations; preparation for all types of tests, exams and tests; preparation for final state certification; work in topic circles; participation in optional classes, seminars and conferences, etc.

### **CONCLUSION:**

1. Distance learning is a motivating factor in the study of foreign languages, contributes to the achievement of personal, meta-subject, subject learning results and, ultimately, the achievement of the goal of teaching foreign languages: the formation of foreign language communicative competence.
2. Distance learning contributes to the implementation of modern educational paradigms such as individualization and differentiation of educational activities, self-education and self-development of students.
3. The introduction of information and communication technologies in teaching foreign languages reveals a pedagogical problem. Pedagogical science is faced with the task of



methodological development of existing modern teaching tools, the study of new technical means that are promising in teaching a foreign language.

4. In short, the independent work of students requires the development of a conscious attitude of students to the acquisition of theoretical and practical knowledge, the strengthening of the habit of mental work focused on them.

Instructions to the teacher on the organization of independent work of students are as follows:

Independent work should be organized at all stages of the educational process, including in the process of learning new material.

Students should be placed in an active position, making them direct participants in the learning process.

The organization of independent work should help to develop students' learning motivation.

Independent work should be purposeful and clearly formulated.

The content of independent work should define complete and in-depth tasks for students.

It is necessary to ensure the combination of reproductive and productive learning activities of students in the process of independent work.

Adequate consideration should be given to the organization of independent work, i.e. the control system should be properly organized.

#### **LITERATURE:**

1. Burkin V. A. On some priorities of modular training in higher education // Young scientist, 2014. - №4. – P. 925-927.
2. Gutareva N.Yu. Distance learning of foreign languages in a non-linguistic university [Electronic resource Internet]. URL: <http://psibook.com/linguistics/distantsionnoeobuchenie-inostrannym-yazykam-v-neyazykovom-vuze.html>
3. Konysheva A.V. Organization of independent work of students in a foreign language. – St. Petersburg: KARO, Minsk: Four Quarters, 2005. – 208 p.
4. Methods of teaching foreign languages: traditions and modernity / Ed. by A. A. Mirolubov. – Obninsk: Titul, 2010 – 464 p.
5. Polat E.S. Theory and practice of distance learning: Textbook for students of higher pedagogical institutions – Moscow: Publishing Center "Academy", 2004 – 416 p.
6. Suvorova A.V. On the issue of modular teaching of a foreign language in higher education // Young scientist, 2014. - № 7. – P. 561-563.
7. Shcherba L.V. General questions of the methodology: Textbook. – St. Petersburg: Faculty of Philology of St. Petersburg State University, 2003 – 160 p.

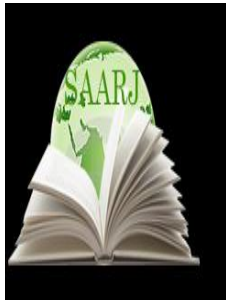

**ACADEMICIA**  
**An International**  
**Multidisciplinary**  
**Research Journal**  
 (Double Blind Refereed & Peer Reviewed Journal)

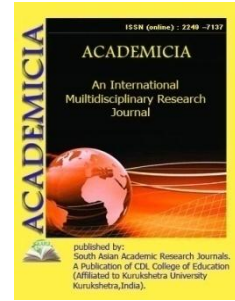

**DOI: 10.5958/2249-7137.2021.01060.0**

## LEGAL FRAMEWORK FOR THE ACTIVITIES OF POLITICAL PARTIES

**Usmonova Nigora Aktamovna\*; E.A. Qadirov\*\***

\* Master's student at Tashkent State University of Law,  
 UZBEKISTAN

Email id: usmonovanigora314@gmail.com

\*\*PhD Scientific supervisor (consultant),  
 Professor of the Department of constitutional law,  
 UZBEKISTAN

### ABSTRACT

*The article examines the process of formation and development of the organizational and legal framework of political parties in developed countries, i.e. institutionalization and constitutionalization processes. It is argued that political parties in developed countries rely on a solid legal basis in their activities. It was also noted that over the years of independence in the Republic of Uzbekistan, a solid legal basis has been created for the activities of political parties, which contributed to the formation and development of civil society institutions, including the institutions of people's representation in our country.*

**KEYWORDS:** *Political Party, Organizational And Legal Basis, Constitution, Law, Legal Basis, «Institutionalization», Legal Norm, «Constitutionalization», Normative Act, Popular Representation.*

### INTRODUCTION

Throughout the modern history of mankind, political parties have always played a prominent role in the representation of the people. It was they who largely contributed to the consolidation of electoral procedures in the mass consciousness. However, without sufficient and legally established institutional opportunities to influence the bodies of popular representation, the parties for a long time could not rely on the effective constitutional and legal instruments of legal regulation of their organization and activities, which are characteristic of most countries of Western democracy. World experience shows that the level of development of constitutionalism, the degree of formation of civil society depends on how institutionalized political pluralism has

become. There is no denying the fact that in recent years, political parties have become an important component of public relations: they have factions in the parliaments of different countries, legislative (representative) bodies of the subjects of these countries, and influence the process of making and implementing important public decisions. However, the constitutional regulation of ensuring the participation of political parties in the system of popular representation largely does not meet the requirements of modern society and needs further improvement.

Political parties in the modern sense of the term first appeared in Europe in direct connection with the revolutions, during which the people's representation was created – a system of power of the people, carried out through elected representatives [1, p.159-160].

Initially, the party united, on the one hand, the supporters of the monarch and the feudal lords, and on the other – the defenders of equality and political freedom. Subsequently, parties began to appear that defend the interests of individual social and regional groups of society. With the strengthening of class differentiation, the deepening of social contradictions, and the involvement of more and more broad strata of society in politics, the role of parties increased, and they became the main subject of politics and a necessary element of democratic statehood.

Parties differ from other public associations operating in the political arena (pressure groups, professional and business unions, etc.) in that they openly compete for seats in parliament and the government, which make it possible to govern the state and, through it, the entire society.

Political parties play a crucial role in public, political and state life, being one of the central components of the political system. The struggle between them is connected with the solution of the question of political power – its ownership, use, methods and forms of implementation. Parties actively participate in political life at all stages of the political process: in elections, the formation of state bodies, the adoption of political and state decisions, and their implementation.

The supporters of the party who vote for the candidates nominated by it in the elections to state bodies form its electorate (from the English "elector", French "electeur" – "voter"). The social strata or regional communities to which the majority of the electorate belongs constitute the social base of the party. In countries with stable social relations (for example, in Switzerland, the Netherlands), the electorate of individual parties is based not so much on the specificity of their programs and ways of activity, but on local and family traditions: the current generation votes for a particular party, following the example of their fathers and grandfathers.

A political party is an active and organized part of society, united by common interests, goals, or ideals, and striving to seize State power or to influence its exercise in a decisive way. A political party is a specific type of public association whose purpose is to participate in the political life of the state. The party as an independent political force, has an organizational structure, develops its own program of national development, and is characterized by a long period of existence [2, p.3-4].

Political parties represent a legal and political institution that acts as an intermediary between the State and the structure of civil society.

The place of political parties is determined by their position in the system of power and civil society. Having originated in it, they gradually won their place first in the system of legislative power, then in the executive. Finally, the totality of the parties of society formed a party system, which became a separate political institution. The party system, or the totality of the parties of

society, is located between civil society and the state, at the junction of public and state structures.

At present, the political and legal system of modern states has various legal forms of state regulation of party activities.

Among the forms of regulation of party activities by the state, the following can be noted::

- Development of special regulations (laws, decrees, resolutions) on political parties;
- Adoption of normative acts concerning state-legal institutions and mentioning political parties (electoral laws, regulations of parliaments, codes of municipal administration, etc.);
- The use of judicial precedents related to the activities of political parties [3, p. 39].

At the present stage, the processes of constitutionalization have been implemented in the political and legal sphere of political parties. The constitutionalization of political parties is understood as the consolidation of their role and place in the constitutions, or at least their mention, recognition by the basic law of the country as a public-state institution [4, p. 187-212]. The general direction of the process of constitutionalization of political parties is already clear: having begun in developed countries, it has now taken on a global character: most new constitutions contain references to parties, and special laws are being adopted about them in an increasing number of countries around the world. In addition, parties, as political institutions, appear in other laws. This process is due, on the one hand, to the increasing role of political parties in modern societies, on the other – to the financial and legal difficulties that they constantly face, and the need to control the manifestations of corruption and dirty electoral technologies.

The constitutionalization of parties allows State bodies to exercise control over certain aspects of their activities. On the one hand, to help them with financial resources, on the other - to reduce corruption to control their income and expenses.

The process of constitutionalization of political parties began with the adoption in 1947 of the new Constitution of Italy, in article 49 of which it was noted that "all citizens have the right to freely unite in parties in order to democratically contribute to the determination of national policy" [5, Article 49]. Then a similar article was written in the constitutions of Germany (1949) [6, Article 21], France (1958) [7, Article 4] and many other states of the world. The Russian Constitution of 1993 also contains an article on parties, which recognizes their ideological and political diversity, multiparty membership; It declares the equality of all parties before the law (as a guarantee against the return of the totalitarian past) and prohibits the creation of parties whose activities are anti-systemic or extremist in nature.

In connection with the expansion of the process of constitutionalization, German political scientists put forward the concept of a party state. G. Leibholz, in particular, argues that the parties were previously free associations, but thanks to constitutionalization they rose to the rank of constitutional bodies, i.e., from a legal point of view, they became the same as, for example, the federal government and the Bundestag. At the same time, the functionality of parties in modern society stems from their place as public-state structures and the link between society and the state. Therefore, they can be equated with state institutions only from a legal, formal, but not from a political point of view. This question was raised in practical and legal terms in Germany

in 1966, when the Federal Constitutional Court decided the problem of financing political parties.

On the basis of the legal provisions of the state institutions enshrined in the constitution, the parties of the Federal Republic of Germany began to apply for funding for their activities, which, in their opinion, should be proportional to the number of mandates received by each party in the Bundestag. The Constitutional Court established a distinction between the formation of the will of the people, carried out by parties in the sphere of society free from the influence of the state, and the formation of the will of the state, which is implemented through its constitutional bodies [8, p.114]. Since it is the parties that perform such a function as the selection and nomination of candidates for state posts, the will of the state, according to the Constitutional Court of the Federal Republic of Germany, cannot be formed without the participation of parties. Thus, from a legal point of view, elections to state bodies are a means of transforming the political will of the people into the state will. It follows that it is permissible to reimburse parties from the state budget for the costs of electoral struggle.

In the Republic of Uzbekistan, a solid foundation has been established, i.e., the legal and regulatory framework for the activities of political parties. The Constitution of the Republic of Uzbekistan sets out the norms concerning political parties. A number of laws have been adopted that regulate the activities of political parties.

Based on the provisions of the Constitution, the laws "On Public Associations" (1991), "On Political Parties" (1996), "On Non-governmental non-profit organizations" (1999), "On the financing of Political parties" (2004), "The Electoral Code of the Republic of Uzbekistan" (2019) and a number of other legislative acts were adopted. Of particular note is the Constitutional Law "On Strengthening the Role of Political Parties in the Renewal and Further Democratization of Public Administration and Modernization of the country" (2007), which clearly formulated the legal status of party factions that adhere to different political orientations, including the opposition party. The law expanded the field for political parties to participate in the formation of executive bodies by directly participating in the formation of the government, in the selection of candidates for certain positions in executive bodies at various levels.

After making some changes to the law "On Political Parties", the activities of political parties in our country have acquired a completely new legal framework. This has led to significant changes in the legal status of political parties, and especially in the formation of State authorities. Political parties in the Republic of Uzbekistan have gained real opportunities to participate in the formation of state authorities, to influence the internal and foreign policy of the country, so their role in the relations between the state and society has increased immeasurably.

In general, the current laws have strengthened the role of political parties in the democratization of state and social construction and contributed to the implementation of the following tasks:

1. Increasing the initiative, role, effectiveness and responsibility of political parties in implementing the country's reform, ensuring effective public control over the implementation of domestic and foreign policy by the state authorities.
2. Creation of organizational and legal conditions for the active participation of political parties in the formation of representative and executive branches of government. Important practical and mobilizing importance is attached to the fact that political parties that have won seats in

legislative and representative bodies of power can directly participate in the formation of executive bodies in the center and in the field and implement their program goals through them.

3. Creation of effective legal mechanisms that establish and ensure the accountability of the Government and state authorities to political parties represented in the Parliament and local representative bodies.

In addition, these and other legislative innovations made it possible, in our opinion, to achieve the following:

- strengthening the political responsibility of the parties for the implementation of their program objectives and election promises, and, ultimately, for the success and effectiveness of the country's modernization;
- The emergence of a strong real inter-party competition and struggle-both in parliament and in representative bodies;
- strengthening public control over the activities of state bodies and increasing the responsibility of their officials;
- Adequate representation in the parliament and other representative bodies of the legal political forces existing in the society, the whole diversity of opinions and interests;
- stimulating social and political activity of citizens, increasing their political culture and consciousness;
- Overall positive impact on the processes of democratization and modernization of the country.

Thus, the reform of the party legislation of the Republic of Uzbekistan allowed:

- \* create institutional prerequisites for the formation of strong and effective political parties, encouraging the strengthening of the parties' positions in the legislative and representative bodies;
- \* overcome the underdevelopment of the party system, strengthen the legal status of political parties;
- \* encourage political parties to participate in elections and the work of representative bodies of state power and the formation of executive bodies, as the most important task of their statutory activities.

As a result, the parties began to aim at gaining their political representation in the state authorities through elections and influence on the process of appointing the heads of executive bodies, and, thereby, participation in the government.

#### **REFERENCES:**

1. Constitutional (state law) of foreign countries: In 4 volumes. Volumes 1-2. Part of the general: Textbook / Ed. prof. B. A. Strashun-3rd ed., updated and dorab. - M.: Publishing House BECK, 2000. - p. 159-160.
2. Political Parties and Democracy / edited by Larry Diamond and Richard Gunther. – Baltimore: The Johns Hopkins University Press, 2001. - p. 3-4.

3. Shashkova A.V. Course of lectures on the constitutional law of foreign countries. - Moscow: "Battleship", 2008. - P. 39.
4. Van Biezen, I. Constitutionalizing party democracy: The constitutional codification of political parties in post-war Europe / British Journal of Political Science, January 2012. No. 42 (1). – p. 187-212. DOI: 10.1017/S0007123411000263.
5. Constitution of the Italian Republic. 1947. Article 49. SenatodellaRepubblica. URL: [https://www.senato.it/documenti/repository/istituzione/costituzione\\_inglese.pdf](https://www.senato.it/documenti/repository/istituzione/costituzione_inglese.pdf)
6. Basic Law for the Federal Republic of Germany (Grundgesetz). 1949. Article 21. URL: <https://www.btg-bestellservice.de/pdf/80201000.pdf>
7. Texteintégréal de la Constitution du 4 octobre 1958 en vigueur. Article 4. URL: <https://www.conseil-constitutionnel.fr/le-bloc-de-constitutionnalite/texte-integral-de-la-constitution-du-4-octobre-1958-en-vigueur>
8. Isaev B. A. Theory of parties and party systems: Textbook for university students / B. A. Isaev. - Moscow: Aspect Press, 2008. - P. 114.



**ACADEMICIA**  
**An International**  
**Multidisciplinary**  
**Research Journal**  
 (Double Blind Refereed & Peer Reviewed Journal)

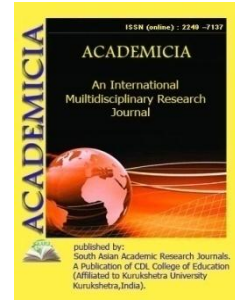

**DOI: 10.5958/2249-7137.2021.01061.2**

## MODELING THE PROCESS OF DEFORMATION OF VISCOELASTIC TEXTILE MATERIALS

**Gulara Abdieva\*; Aziza Adizova\*\*; Tulkin Mavlanov\*\*\*; Dilfuza Rakhimova\*\*\*\***

\*Department of Applied Sciences and Methodology of Additional Education,  
 Regional center for retraining and advanced,  
 Training of Public Education workers of the Tashkent Region,  
 UZBEKISTAN

Email: gulim.120969@gmail.com

\*\*Bukhara Engineering-Technological Institute,  
 UZBEKISTAN

\*\*\*Tashkent Institute of Engineers of Irrigation and Agricultural Mechanization,  
 UZBEKISTAN

\*\*\*\*Department of Applied Sciences and Methodology of Additional Education,  
 Regional center for retraining and advanced,  
 Training of Public Education workers of the Tashkent Region,  
 UZBEKISTAN

### ABSTRACT

*The article covers the analysis of deformed state of textile threads with regard for their relaxation characteristics. As a model, The Boltzmann-Volterre integral relation has been used. For a specific calculation, a kernel with four parameters has been used.*

**KEYWORDS:** *Mechanical Properties, Tension, Deformation, Materials, Viscoelastic Properties, Relaxation Processes, Elastic Modulus, Various Materials, Mechanical Properties, Curve, Kernel, Distribution, Experimental*

### 1. INTRODUCTION

As we know, to describe relaxation processes the model of the thread considered should be used. The model view is based on fact that textile materials are modeled by a set of interconnected elements that symbolize elasticity and viscosity in pure form. Under the mechanical model is understood not only a set of springs and dampers, but also a system of closed equations that



determine the stressed-deformed state of the material. This model approach allows obtaining mathematical description of any new model built of elastic and viscous elements.

It should be noted that correctly chosen model allows more deeply studying the patterns of textile threads and predicting its behavior under certain operating conditions. If the model method of studying relaxation processes in polymer materials can be considered developed, then for textile threads and clothes it is still deficient [1].

A number of models to describe the mechanical properties of textile materials with different deformation times have been proposed.

1. Maxwell model. The model consists of two successively connected elastic and viscous elements. Along with the positive effects, there is a drawback composed of not sufficiently taking into account the tension behavior of the material.
2. Kelvin-Voith model. The model consists of two parallel-connected elastic and viscous elements. However, this model presents only one mechanism of high-elastic deformation.
3. Eyring, Dogadkin, Bartnev, Reznikovsky model. The model is a parallel-connected Maxwell element spring and piston. This model is often used in research of relaxation phenomena in polymer materials, as well as in fibers and threads.
4. Generalized Kelvin-Voith models. The model consists of three components generalized by Kelvin-Voith model.
5. Mathematical models. It is possible to build complex models, which consists of four or more elastic and viscous elements. However, the use of multi-element models leads to lengthy mathematical expressions and does not allow to satisfactorily describing the deformation of real textile materials [2].

## 2. MATERIALS AND METHODS

Relaxation processes that occur in textile threads can be described by the modeling method. Herewith, it should be observed that the correct selection of the model allows really the laws of deformation of materials in real conditions. Mechanical models are widely used when describing the mechanical properties of various materials, including textiles. They allows simulating the relation between tension and deformation of the materials under study [3].

We use the hereditary Boltzmann-Volterr theory of viscoelasticity to describe the processes of threads deformation taking into account the viscoelastic properties. The mathematical record of the dependence of tension on deformations is as follow [4]:

$$\varepsilon(t) = \frac{\sigma(t)}{E} + \frac{1}{E_0} \int_0^t K(t-s) \sigma(s) ds, \quad \sigma(t) = E \varepsilon(t) - E \int_0^t G(t-s) \varepsilon(s) ds \quad (1)$$

Where  $\sigma$  – is tension;  $\varepsilon$  – is relative deformation; E – is elastic modulus;  $K(t-s)$  and  $G(t-s)$  – are dependence functions; t – is time of observation;  $\tau$  – is time prior to time of observation.

In (1), formulas for calculating the parameters of viscoelasticity were proposed [5].

$$E = \frac{\sigma_1 \alpha (\alpha + 1)}{\varepsilon (\alpha (\alpha + 1) - A t_1)} \quad t_1^\alpha (\sigma_2 - \sigma_3) - t_2^\alpha (\sigma_1 - \sigma_3) + t_3^\alpha (\sigma_1 - \sigma_2),$$

$$A = \frac{((\sigma_1 - \sigma_2) \alpha (\alpha + 1))}{\sigma_1 (\alpha + 1) (t_2^\alpha - t_1^\alpha) + (\sigma_1 - \sigma_2) t_1^{\alpha+1}}, \quad \beta = \frac{(\sigma_4 - \sigma_1) (\alpha + 1) \alpha + E \varepsilon A (t_4^\alpha - t_1^\alpha) (\alpha + 1)}{E \varepsilon A (t_4^{\alpha+1} - t_1^{\alpha+1})}$$

Knowing the nature of the distribution of tension and deformation of the thread allows predicting the tension-deformation state of the thread [6].

At  $\sigma = const$ , from relation (1) we obtain the creep equation

$$\varepsilon(t) = \frac{\sigma(t)}{E} \left[ 1 + \int_0^t K(s) ds \right] \quad (2)$$

If the influence function is known, then equation (2) can be used to construct a constant curve of tension creep. The latter is determined from the known creep curve. In particular, if the influence function  $K(t)$  has the form of an exponent, then we obtain the Kelvin model. If the kernel of the integral equation is in the form of a sum of damped exponential functions, then the integral equation (1) is equivalent to a linear differential equation of the  $n$ -order.

There are different types of kernels. For example, the kernels of Rabotnov, Slonimskiy, Ilyushin, etc. In computational practice have found great application the kernels proposed by Yu.N. Rabotnov, A.R. Rjanitsyn, M.A.Koltunov [7]. For example, the relaxation kernel proposed by A.R. Rjanitsyn has the form

$$R(t-s) = \frac{A e^{-\beta(t-s)}}{(t-s)^{1-\alpha}}, \quad (3)$$

Where  $A, \alpha, \beta$  are material parameters. The resolvent of this kernel is obtained by M.A.Koltunov in a form [8]

$$K(t-s) = \frac{\exp(-\beta(t-s))}{(t-s)} \sum_{n=0}^{\infty} \frac{[A - \Gamma(\alpha)]^n (t-s)^{n\alpha}}{\Gamma(n\alpha)} \quad (4)$$

For materials with a finite long-term modulus of elasticity, a four-parametric kernel is used, which has a form

$$K(t-s) = \frac{A \exp(-\beta(t-s))}{T^q (t-s)^p}, \quad 0 < p < 1; q = 1 - p \quad (5)$$

Where  $A, T, p, q, \beta$  are - material parameters determined by graphical method [8].

Corresponding relaxation kernel has the form

$$R(t-s) = \frac{\exp(-\beta(t-s))}{(t-s)} \sum_{n=0}^{\infty} (-1)^{n+1} \frac{[A \Gamma(q)]^j}{\Gamma(jq)} \left( \frac{t-s}{T} \right)^{qj} \quad (6)$$

For a constant load applied at time  $t=0$ , according to expressions (5) and (1), we have

$$\varepsilon(t) = \frac{\sigma(t)}{E} \left[ 1 + \frac{A}{T^q} \int_0^t \frac{e^{-\beta(t-s)}}{(t-s)^p} ds \right] = \frac{\sigma}{E} \left[ 1 + \frac{A}{(T\beta)^q} \gamma(\beta t, p) \right], \quad \gamma(\beta t, p) = \int_0^{\beta t} e^{-s} / s^p ds$$

Where  $\gamma(\beta t, p)$ – is incomplete gamma function, whose values are tabulated [9]. When  $t \rightarrow \infty$  then deformation is equal to

$$\varepsilon(\infty) = \frac{\sigma}{E} \left[ 1 + \frac{A}{(T\beta)^q} \Gamma(q) \right]$$

An algorithm to determine the parameters based on experimental creep curves has been developed, and practical techniques based on graphical constructions has been developed for approximate engineering estimates [10].

### 3. RESULTS AND DISCUSSION

Let us show the efficiency of using a kernel of the form (3) in comparison with other types.

Fig. 1 shows the graphs of tension relaxation changes according to three theories in comparison with the experimental curve. Hence, we clearly see that for the deformation of textile materials, the best description is given by the weakly singular kernel (3) and Rjanitsyn-Koltunov function-resolvent. As an example, we consider the process of deformation of a cotton thread with a linear density of 28 tack.

Instantaneous modulus of elasticity  $E$ , breaking load and breaking deformation are determined before the creep test. The tests are carried out at constant temperatures and relative humidity of the material. Wherein, machines, equipment and stands designed for long-term static tests are used. Therefore, for example, one end of a thread or fabric is fixed motionless, and a load is suspended from the other end. In this case, tensile deformation relaxes in the thread or fabric at constant tension. In this position, the sample is kept in an unloaded state at a given test temperature for 30-60 minutes. After that, the sample is loaded at loads up to 5% of the short-term strength limit. In this case, the possibility of sliding of the sample in the clamps during the test should be excluded.

The loading rate is taken constant for the entire series of tests. The loading time should not exceed five seconds. The moment of full load of the test sample is taken as the reference point for creep. Moreover, deformations are recorded in 0.5;1;2;3;5;10;30;60 min after loading, followed by approximate doubling of period between indications.

After the creep tests have been performed, the samples are unloaded and the unloading creep is observed. All tests are repeated on samples at least three times, and processed by the method of complex analysis. The values of the averaged deformations for each tension level and time are recorded in a table and presented in the form of graphs indicating the experimental confidence intervals.

Figure 1 shows the deformation curves at different load levels

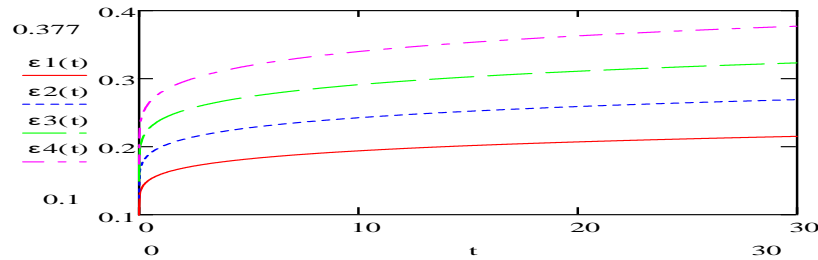

Fig. 1. Deformation curves of 28 tack cotton thread at different load levels

The mentioned curves show that the deformation is linear with respect to the tension. The determination of the modulus of elasticity and the parameters of the kernel is carried out by combining the experimental curves of flexibility and theoretical curves [11]. Having this experimental theoretical curve (Fig. 1), determined by the parameters  $\alpha_t$ ,  $\beta_t$ ,  $A_t$ , we can easily determine the parameters of experimental curve  $\alpha_e$ ,  $\beta_e$ ,  $A_e$  for a given material, and its instantaneous modulus of elasticity  $E$  is found by the formula

$$E = \frac{1 + \int_0^t K dt}{\varepsilon_x(t) \sigma_k} \quad (7)$$

Thus, the found parameters  $\alpha_e$ ,  $\beta_e$ ,  $A_e$  can be introduced into the relaxation equation and into the constraint equation  $\sigma \sim \varepsilon \sim t$ .

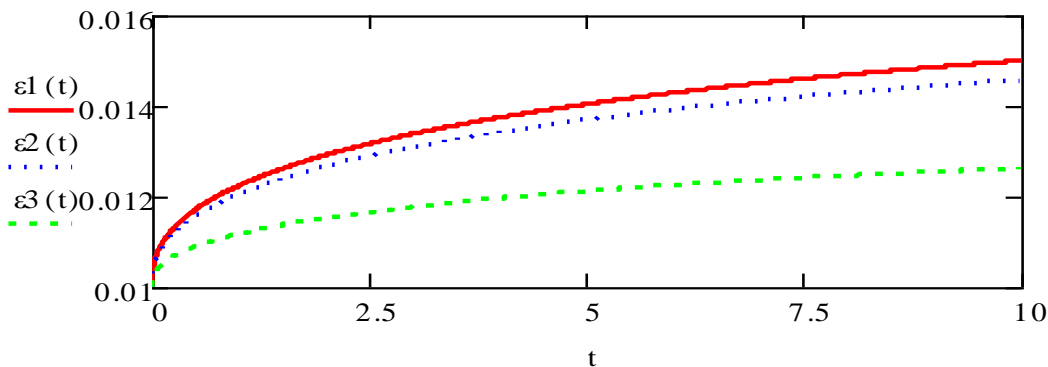

Fig. 2. Creep curves for different kernels ( $\varepsilon_1(t)$  is experimental curve;  $\varepsilon_3(t)$  is Rjanitsyn kernel;  $\varepsilon_2(t)$  is four-parameter kernel)

#### 4. CONCLUSION

Analysis of the studies carried out allows concluding that it is necessary to use a model method to calculate the values of deformation of textile materials in the process of relaxation. It was determined that Boltzmann-Volterra model, generalizing other known models for textile materials, is the most acceptable. To describe the behavior of textile materials with viscoelastic properties, it is necessary to use weakly singular heredity kernels, for example, the Rjanitsyn-Koltunov kernel (3), which very satisfactorily reflects the quasi-static and dynamic behavior of viscoelastic material, and is most convenient for carrying out quasi-static and dynamic

calculations and determining mechanical constants. However, as numerical experiments show, a kernel of the form (5) is the most acceptable for a number of materials (Fig. 2). In the case of kernel with four parameters, the creep curve is closer to the experimental one than the kernel with three parameters.

## REFERENCES

- 1) T M Mavlanov, G B Abdieva, M Abduvaxidov 2011 Mechanics of thread and clothes, Tashkent p 187
- 2) Dremova N V , Alimboev E Sh , Mavlanov T M 2004 To the estimation of reed stiffness of shuttle and shuttleless looming machines “*Problems of textile industry*” No 2, p 33-35
- 3) Karimjanova R S, Mirusmanov B, Mavlanov T M, Mukimov M M 2004, Research of deformation properties of cotton-silk hosiery based on theory of viscoelasticity “*Problems of textile industry*” No 2, p 37-39
- 4) Migushov I I 1980, Mechanics of textile thread and cloth, Moscow: Light industry, p 160
- 5) Koltunov M A 1976, Creeping and relaxation, M: Higher school, p 278
- 6) Nasretdinov S S, Abdieva G B, Mavlanov T M 2004, Experimental determination of the linearity limit of viscoelastic deformations of textile threads *Problems of mechanics and seismodynamics of buildings Materials of the International conference*, Tashkent, p 552-554
- 7) Mavlanov T M, Abdurakhimova F A 2004, Research of the deformation of hosiery yarn taking into account inelastic properties “*Problems of textile industry*” No 1, p 61-63
- 8) Mavlanov T M 2004, “Problems of textile industry” *To the 70<sup>th</sup> anniversary of Academician T.R. Rashidov* No 1, p 94-95
- 9) Akhmedov M Sh, Aslonov B, Orripov Z, Adizova A 2018, On the action of mobile loads on an uninterrupted cylindrical tunnel “Discovery publication” *Indian Journal of Engineering*, July, Vol 15 pp 209-218  
[https://discoveryjournals.org/engineering/current\\_issue/2018/A21.pdf](https://discoveryjournals.org/engineering/current_issue/2018/A21.pdf)
- 10) Zokirova D A , Adizova A J 2019, Torch vibrations of a viscoelastic shell with a viscous liquid *Indian Journal of Engineering*, 16, pp 197-203



**ACADEMICIA**  
**An International**  
**Multidisciplinary**  
**Research Journal**  
 (Double Blind Refereed & Peer Reviewed Journal)

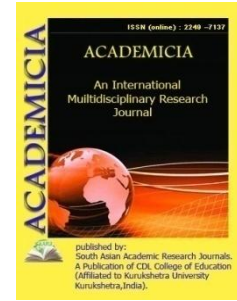

**DOI: 10.5958/2249-7137.2021.01062.4**

## INTERNATIONAL FINANCIAL ACCOUNTING STANDARDS IN UZBEKISTAN

**Qudbiyev Nodir Tohirovich\***

\*Master,  
 Fergana Polytechnic Institute,  
 Specialty in Accounting (by industry and industry),  
 UZBEKISTAN  
 Email id: nodirbek\_3305@mail.ru

### ABSTRACT

*The organization of financial accounting and reporting through the principles of IFRS, which is not carried out within the framework of special government programs, is not supported by the state, will not allow to solve the main tasks of the transition in the coming years.*

**KEYWORDS:** *According To The Resolution.IFRS. Digitization Of The Economy.Acquiring And Mastering.New Uzbekistan.Our Main Goal Is To Please The People.*

### INTRODUCTION

In today's global economy, our country pursues global accounting policies and adopts standards. Because the accounting policy and transparency are clear to any user of information and allow a potential investor to make qualified financial decisions.

Resolution of the President of the Republic of Uzbekistan "On additional measures for the transition to international financial reporting standards" PQ-4611 dated February 24, 2020 oopened a new page in the accounting policy in our country. (1)

According to the resolution, from January 1, 2021, accounting will be conducted on the basis of IFRS:

- joint stock companies
- commercial banks
- insurance organizations
- legal entities included in the category of large taxpayers.

In particular, this decision is another step for our Republic, which has a new look at the world, to abandon the closed economy as much as possible and create an open, transparent and new economy.

In our opinion, the need to conduct financial reporting in accordance with international standards is based on:

**First**, the countries of the world should be able to formulate on the basis of national requirements for financial accounting and reporting, not to fail to provide an opportunity to determine, compare and contrast the financial condition of the object of study;

**Second**, the use of IFRS requirements as a benchmark for accounts and reports serves to increase the country's investment attractiveness and meet the information needs of domestic owners;

**Third**, the national securities market will be able to sell on world stock exchanges and increase foreign exchange inflows:

**Fourth**, it serves to increase the number and expand the activities of international companies in the national economy;

**Fifth**, the preparation of a single, recognized financial statement in accordance with IFRS requirements increases its efficiency and reduces the cost of preparation;

Well, the transition to IFRS gives so many opportunities, and there are several reasons why this process has dragged until this day:

- Before the beginning of the new history of Uzbekistan, the authorities of the republic were interested in the fact that the economy of our country was closed for the world economy.
- the state becomes a provider of financial information and at the same time a user of financial information. This, in turn, has led to a one-sided view of the value and formation of financial information.
- The low level of digitization of the economy in our country and the fact that it is not technically well established.
- lack of qualified specialists and lack of textbooks, as well as low level of knowledge of foreign languages.
- the high share of our country in the shadow economy.

The success and timing of the transition to a full financial reporting system in accordance with IFRS requirements can be predetermined by the fact that the idea of transition is directly understood by companies and organizations as the basis for effective management.

The organization of financial accounting and reporting through the principles of IFRS, which is not carried out within the framework of special government programs, is not supported by the state, will not allow to solve the main tasks of the transition in the coming years.

One of the most pressing issues is the misinterpretation of certain actions and the task of translating the content of international standards into Uzbek in a correct, competent and readable manner. Therefore, it is necessary to translate the existing IFRS standards into Uzbek, to republish and adopt new ones, as well as to provide free access to these materials, taking into

account the structure of the IFRS Board and the changes, comments and standards made through it.

The president's decision requires this new economic knowledge. For this reason, dissatisfaction and grievances can be expressed by accountants in a number of Internet networks. Acquiring and mastering new knowledge, learning a new way of working takes effort and hard work. But the real situation in the world economy today is that the basis of the activity of an accountant is the interests of the user of financial information, that is, investors and decision-makers, no different. Unfortunately, many businesses and organizations do not understand that the role of accountants is to ensure that tax returns are accurate and timely, or that they are accountable for control and audit.

It can be observed that accountants accustomed to thinking and working in the old way accuse IFRS principles of ambiguity and over-abstraction. One of the main reasons for this is that the new rules force the chief accountant to understand the business of the organization in which he works as an economist and financier.

At the same time, there is no doubt that the introduction of international reporting standards will enter a new stage in the development of the country's economy. The IFRS report reflects the real processes in the activities of Uzbek enterprises, organizations and companies. If the assets are measured at market value, and the reserves are calculated correctly, it will be understandable to external users in most countries of the world. As a result, the introduction of IFRS will not only help Uzbek enterprises, companies and banks to reach the international level, but also attract investment.

With this in mind, the President's decision is aimed at creating conditions for the formation of an investment climate in the country and accelerating its work.

Thus, the established legal framework creates favorable conditions for a wide range of investment activities of foreign partners, serves to meet their information needs and protects their investments.

For example, the dynamics of the volume of investments in fixed assets in 2015-2020 can be seen in the fact that further intensification of the work on the transition to IFRS from 2016 will have a significant impact on the economy of the country. (3)

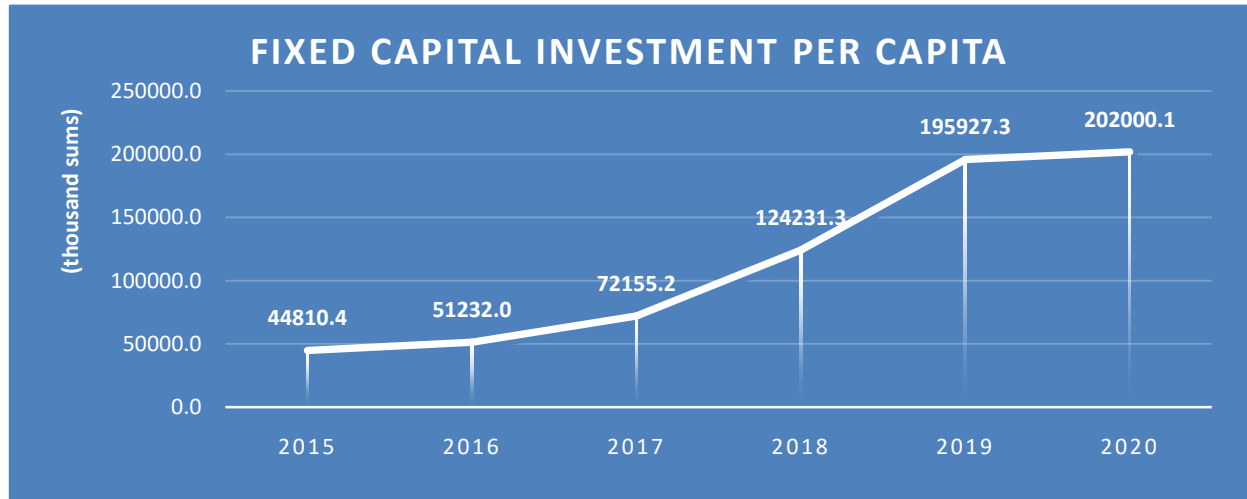

**Table 1**

Foreign investment is the investment of capital-exporting countries in the real and financial assets of economic entities of importing countries and joint ventures. (2)

Investment means the flow of capital from one economy to another, allocating resources on more favorable terms.

This, in turn, allows an investor with a foreign capital to stay in a certain area for a longer period of time and resources, which is easier for the investor to understand.

For Uzbekistan, the dynamics of change in investment in fixed assets, except for 2020, which is very difficult for the world economy, continues to show growth. Table 2. (3)

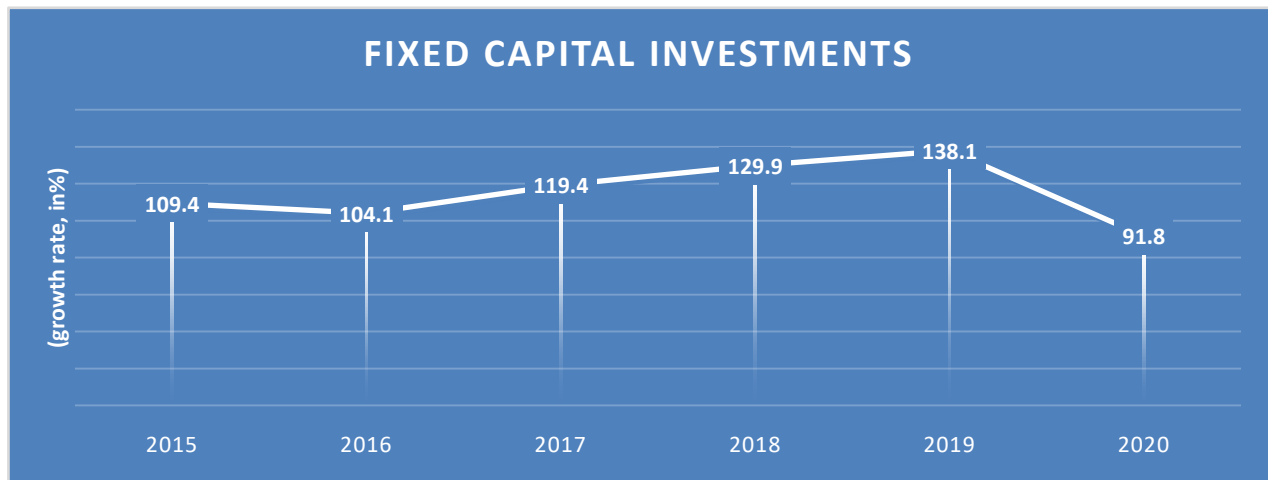
**Table 2**

In recent years, Uzbekistan has undergone a radical change in the state's economic policy and rapid reforms.

Under the motto "New Uzbekistan" the state began radical changes, twists and turns in public policy and the economy.

A new, democratic image of our country is being created in Uzbekistan on the basis of modernization of our economy, ensuring that every decision and reform is based on human rights and freedoms, the rule of law.

Due to the fact that the basis of our reforms, dialogue with the people, the satisfaction of the people has risen to the level of public policy, the atmosphere of openness and freedom in our society is growing. The President's decision can be seen by comparing the per capita investment in fixed assets over the years. Table 3. (3)

**TABLE 3**

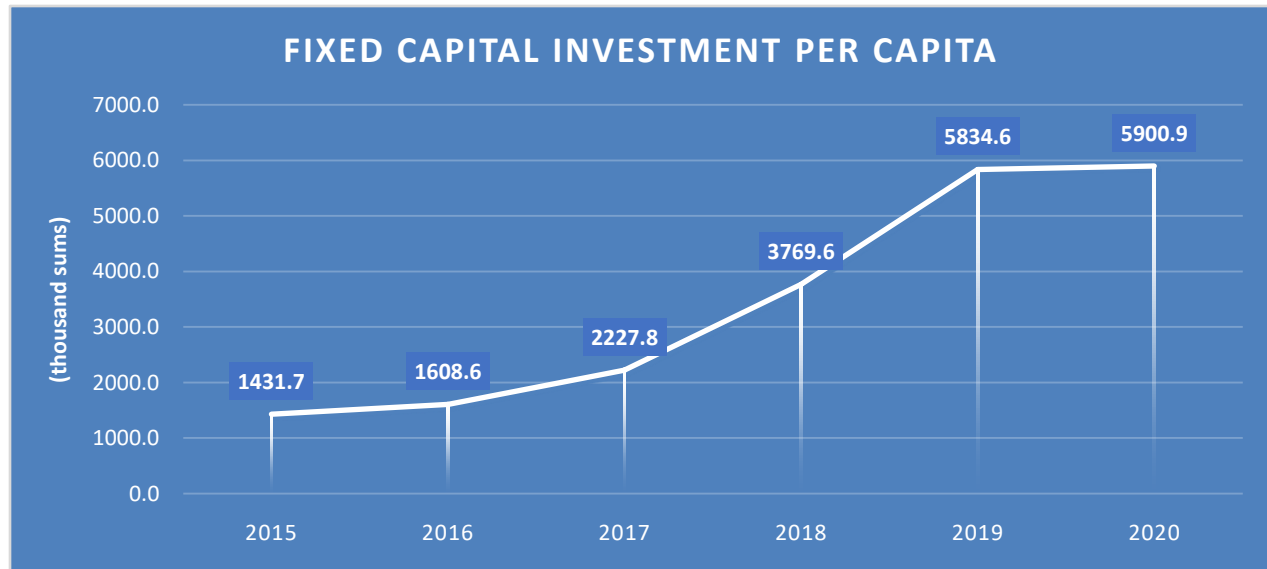

In the Republic of Uzbekistan, the transition to IFRS has chosen a unique and appropriate way for our national economy. This was a way to develop and implement national accounting standards that meet international standards.

In this regard, the President's decision has become a key document defining today's requirements and the economic future of our country. The most important issues now are how the system works, whose interests come first, and the potential of economic information and transport documents.

In conclusion, the ultimate goal of the IFRS in our country is to increase the welfare of the people, as our President said, "Our main goal is to please the people."

#### **LIST OF USED LITERATURE**

1. <https://uza.uz/oz/posts/moliyaviy-hisobotning-xalqaro-standartlariga-o-tish-bo-yicha-25-02-2020>
2. G.G.Nazarova, H.Halilov, A.A.Eshtaev, N.Z.Xakimov, N.M.Salikhova, B.R.Bobojonov "World Economy and International Economic Relations". Textbook 86 pages. Tashkent-2008
3. <https://www.stat.uz/uz/rasmiy-statistika/investments>

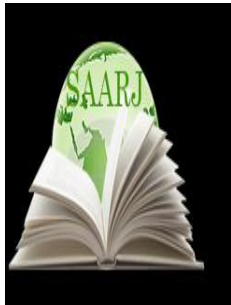

**ACADEMICIA**  
**An International**  
**Multidisciplinary**  
**Research Journal**  
 (Double Blind Refereed & Peer Reviewed Journal)



**DOI: 10.5958/2249-7137.2021.01071.5**

## “TECHNOLOGY OF USING A NEW DEVICE THAT SOFTENS THE CRUST”

**Juraev Azamat Jalil ugli\***; **Farmonov Nozimjon Qosimovich\*\***;  
**Ibodov Islom Nizamiy ugli\*\*\***; **Najimov Dilshodbek Kuvonch ugli\*\*\*\***

\*A student of agricultural mechanization,  
 Bukhara branch of the Tashkent Institute of Irrigation and,  
 Agricultural Mechanization Engineers, UZBEKISTAN

\*\*A student of agricultural mechanization,  
 Bukhara branch of the Tashkent Institute of Irrigation and,  
 Agricultural Mechanization Engineers, UZBEKISTAN

\*\*\*A student of agricultural mechanization,  
 Bukhara branch of the Tashkent Institute of Irrigation and,  
 Agricultural Mechanization Engineers, UZBEKISTAN

\*\*\*\*A student of agricultural mechanization,  
 Bukhara branch of the Tashkent Institute of Irrigation and,  
 Agricultural Mechanization Engineers, UZBEKISTAN

### ABSTRACT

*This article focuses on the use of equipment used in the field of agricultural mechanization, especially in the initial processing between rows. The tanch (3) wheel provides balance by protecting the frame from the vibrations that give rise to the resistance forces generated by the working bodies. We use a trail (4) traction so that the quality of processing is high during the next growing season without losing the row.*

**KEYWORDS:** *Device frame, base wheels, rail, working grilles and 2 series-mounted customized rollers for tillage.*

## INTRODUCTION

The onset of heavy rains of the year turns the soil into a muddy chaff, making it difficult for the seeds to germinate, making replanting possible. In order to overcome this difficulty, ration motigo (ROR) is used. [M.Shoumarova, T.Abdillaev.IIbob.176 page]

The main disadvantage of this ration motigo is that it does not produce complete crushing when processing between rows. As a result, not being able to achieve full seedlings reduces yields.

Given that the seeds are sown at a depth of 5–7 cm, the required heat, humidity, germination in the air environment is ensured, the successive rains and high sunlight spoil this environment. In the conditions of Bukhara region, the optimal time for sowing seeds is the first 15 days of April. It is at this time that there is a lot of rainfall, and the effect of sunlight on the ground is the same, ie heating to 30-35 degrees, which causes problems in agriculture.

The purpose of the utility model is to solve the above problems. To do this, we take the existing seeder SChX-4 compacting wheels (rollers) and use it as a working body. We put 2 different shaped teeth on the wheels and install them on the grills in series. The compacting wheels now loosen the soil, which has been turned into cotton, one by one, creating an environment for the seeds to germinate.

The problem is solved by mounting 2 adapted wheels on 4 grids mounted on the main frame of the device and moving it along the rows on a mowing tractor.

Getting the desired harvest will lead to comprehensive economic growth.

In an effort to find a solution to this problem, we embarked on an honorable task, such as creating a device to protect the cotton field from rot.

The working body of the rotary motor is broken by the fact that its star-shaped blade is combined with disks consisting of sharp-toothed teeth and the formed cosettes move into the ground.

In the proposed device, the purpose is to break the fold. The roller in the first row breaks the crust, the roller in the second row serves to grind the lumps and compact the soil. As a result of the softening of the lumps that fall into the roller, the mud crumbles and a fine soil is formed.

The function of the proposed utility model is that the conversion of soil prepared for planting in the rainy season of the year into muddy cotton not only causes problems with seed germination, but also causes seed rot.

In this case, the task of creating a favorable environment for the germination of seeds, the formation of betalofot full seedling area is assigned to the proposed device.

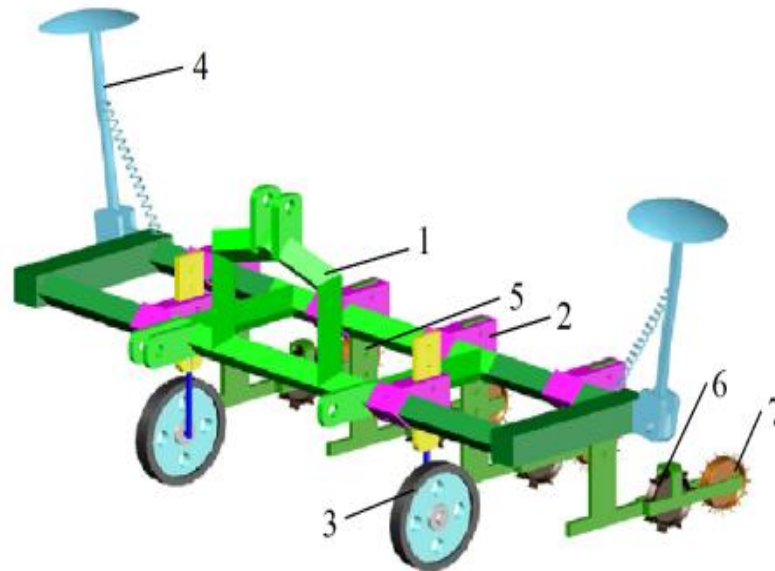

The device, which protects the cotton field from hardening, is aggregated to the mowing tractor. The main (1) frame is mounted on it by means of a fastener (2) of all details made by integral welding. The tanch (3) wheel provides balance by protecting the frame from the vibrations that give rise to the resistance forces generated by the working bodies. We use a trail (4) traction so that the quality of processing is high during the next growing season without losing the row. The tillage working bodies (5) are attached to the pole. The sharp-toothed roller (6) and the spring-loaded (7) plate welded roller do the main job, ie they grind the soil and create a favorable environment for seed germination.

The device, which protects the cotton field from hardening, is aggregated on a mowing tractor, such as TTZ-80, MTZ-80. The tractor power that pulls the device should not be less than 80-100 horsepower. The main (1) frame is made by integral welding, all details are mounted on it by means of fasteners (2). The support (3) wheel provides balance by protecting the working forces from the vibrations transmitted to the frame by the resistance forces generated. In order not to lose the row, we use the cultivator (4) to ensure high quality of processing in the next growing season. The tillage working bodies (5) are attached to the pole.

The sharp-toothed roller (6) and the spring-loaded (7) plate welded roller do the main job, ie they grind the soil and create a favorable environment for seed germination. When assembling the device, it is advisable to adjust the parallelism of the working rollers in the horizontal plane.

The device, which protects the cotton from the husk, is equipped with a main frame, support wheels, a column, a harrow and a series of mounted tillage working bodies, which is distinguished by a flat plate roller that crushes the husk.



## CONCLUSION

Following the above recommendations, we should follow the following.

1. It is necessary to determine the number of hectares of cotton fields in the region and to determine how many devices are needed for processing during the cultivation period.
2. We need to put into practice that this device, which is created when we organize planting on the basis of agro-technical requirements, is effective in cotton growing, the first prototypes of the device are used in advanced farms of our region.
3. Introduction of this device in the existing clusters and farms in the region in this way we use advanced technology in agriculture.

Our task now is to get a certificate from the Intellectual Property Agency, to develop a lot with the support of the Ministry of Innovation Development and to contribute to the well-being of our people, easing the burden on farmers.

## REFERENCES:

1. Decree of the President of the Republic of Uzbekistan "ON MEASURES TO IMPROVE THE SYSTEM OF PUBLIC ADMINISTRATION IN THE AGRICULTURE." 2019.17.04.
2. Murodov M.M., Baymetov R.I., Bibutov N.S. Mehaniko-tehnologicheskie osnovy i parametry orudiy dlya razuplotneniya pochvy. Tashkent, "Fan", 1988, -100b.
3. GOST 20915-2011 Ispytaniya selskoxozyaystvennoy technical. Methods of determining the conditions of examination - M .: Standartinform, 2013. 34 p.

4. Z.A.Artukmetov, H.Sh. Sheraliev. Basics of crop irrigation. MilliyNational Society of Philosophers of Uzbekistan. T. 2007 y. Textbook for university students. 312 b.
5. Dospexov B.A. Methodology of field opyta. - Moscow: Kolos, 1979. - 416 p.

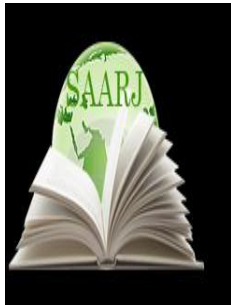

**ACADEMICIA**  
**An International  
 Multidisciplinary  
 Research Journal**  
 (Double Blind Refereed & Peer Reviewed Journal)

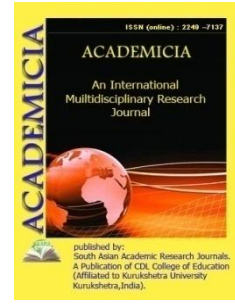

**DOI: 10.5958/2249-7137.2021.01072.7**

**ABOUT METHODOLOGICAL COMPONENTS OF THE TEXTBOOK  
 "BIOLOGY" FOR STUDENTS OF 11TH GRADE OF SECONDARY  
 EDUCATIONAL INSTITUTIONS AND SECONDARY SPECIAL,  
 VOCATIONAL EDUCATIONAL INSTITUTIONS**

**Ahmedova Odinoxon Hatamovna\*; Zokirov Kozimjon\*\***

\*Assistent Teacher,  
 Andijan State University,  
 University, Andijan city, Andijan, UZBEKISTAN  
 Email id: agsu\_info@edu.uz

\*\*Associate Professor,  
 Andijan State University, Candidate of biological sciences.  
 University, Andijan city, Andijan, UZBEKISTAN

---

**ABSTRACT**

*The article highlights the methodological components of the 11th-grade biology textbook in secondary schools, the importance of developing students' independence in the study of topics. In particular, the textbook shows that the methodological components of the textbook are in demand, such as "Apply your knowledge", "Write down the meaning of terms", "Express your opinion", instructions for 5 laboratory classes, 74 color pictures to make the content easier to understand.*

**KEYWORDS:** *A New Generation Of Textbooks, Information System, And Model, "Ecology And Life", The Phylogeny Of The Organic Universe, Hierarchical Structure, Biogeocenosis, Ecosystem, Artificial Ecosystem, Autotroph, Heterotroph.*

---

**INTRODUCTION**

Great work is being done in our country to create a new generation of textbooks based on the requirements of state educational standards. According to the theory of modern education, the textbook is a multifaceted information system and a tool for organizing the learning process. Now textbooks are required not only to educate students but also to perform tasks such as educating, informing, developing, consolidating knowledge, testing, and evaluating their own knowledge. In addition, there is a growing emphasis on the fact that the textbook should be a tool



for students to learn the basics of science independently, which will serve to develop their practical work skills on the textbook.

### **MATERIAL AND METHODS**

There are different views in the literature on textbooks and their structure and functions. Including, D.Zuev [7] describes it as "a textbook that describes the knowledge of various fields of science, its achievements in modern science and production in a certain volume and logical sequence." V.P. Bepalko [6] shows that independence means that people do one task without the help of another, including the teacher's assignments aimed at doing a series of practical tasks so that students can master the newly learned topic more thoroughly.

S. G.Antonova and L.G. Tyurina [4] emphasizes the need to use the positive methodological components of the textbooks published in previous years in the development of methodological components of textbooks. O.Akhmedova and K.Zokirov [5] comment on the successes and some shortcomings of the methodological components given in the 10th-grade biology textbook. Z.A. Mendubaeva [9] shows that the logical connection of topics in the development of methodological components of textbooks, the correct choice of their means of study, taking into account the types and content of lessons are important tasks. E.S. While Tsikalo [10] shows that the content of textbooks consists of main, supplementary, and explanatory texts and non-textual components, T.N. Glubsheva and S.D. The Chernyaevskys [6] comment on the role of textbooks in the educational process.

Most of the textbooks published in previous years did not pay enough attention to the methodological components that serve to improve the content of the lesson, such as independent study, thinking, creative research, with the aim of providing students with ready-made knowledge and narration of their topics. Therefore, the students of the time called for the creation of a new generation of textbooks. Resolution of the Cabinet of Ministers of the Republic of Uzbekistan No. PQ-4805 of August 12, 2020 [1] and the Resolution of the Cabinet of Ministers of the Republic of Uzbekistan dated April 5, 2019, № Resolution No. 281 [2] made it one of the urgent tasks to create new generations of textbooks that fully meet the modern requirements.

In education, "A bad teacher explains a topic. A good teacher directs the student to search for the content of the topic on his or her own." One can see the importance of students' independent work in education. One of the protagonists of the novel by the French writer Anatole Franz: - The idea that "to digest knowledge, you need to eat it with appetite" is another example of the importance of independence in education. For this reason, there is a growing focus on improving the methodological components of textbooks that allow students to use them independently and effectively.

### **The results obtained.**

In the literature, the textbook is described as an information system and model of the educational process. According to the theory of modern education, the textbook is a multifaceted information system and a tool for organizing the learning process. Therefore, textbooks should serve not only the task of educating students in accordance with modern requirements but also to educate, inform, develop, strengthen the knowledge base, the student to check their knowledge, assessment and so on.

In biology education, as in other disciplines, textbooks are the most important teaching tool from which students learn scientific knowledge in certain disciplines. From this point of view, the biology textbook is an example of a systematic reflection of knowledge about the distribution, structure, life processes, diversity, the importance of different representatives of living organisms. The textbook describes the system, content, scope of knowledge, and skills in the field of biology, some plants, animals, humans, cytology, and genetics, which should be mastered in the study of biological sciences. The textbook is intended for students of a certain age and training and consists of information obtained by modern science on specific groups of living organisms selected materials from innovations in production.

It is known that the content of textbooks consists of text, non-textual components. The text is also divided into main and additional texts, respectively. While the main text of the textbook consists of groups of basic concepts relevant to the age characteristics of students, covering the modern achievements of various disciplines in accordance with the requirements of state educational standards and curricula, the additional text is given for students interested in biology. Examples of additional materials include the history of the discovery of some discoveries in science, some scientists, their lives, and work.

The non-textual-methodical components of textbooks play an important role in the development of students' independence in the study of topics in education. The methodological components of the textbooks consist of methodological guidelines such as rules of work with the textbook, symbols, pictures, tables, table of contents, laboratory work, independent work, instructions for homework. Extracurricular components allow students to independently and practically study the topics covered in the textbook, to develop skills in working with the textbook. Therefore, in creating new generations of textbooks, the authors are trying to radically improve the methodological components that will help students to easily master the theoretical material.

As evidence of the above, we present a textbook of biology for students of 11th grades of secondary schools, academic lyceums, and vocational colleges (Biology: Textbook for 11th grade of general secondary schools: 1st edition / Authors: A. G 'afurov, A. Abdugarimov, J. Tolipova, O. Ishankulov, M. Umaraliyeva, I. Abdurahmanova. - T.: «Sharq», 2018. - 240p.).

The textbook consists of four chapters and 42 paragraphs on 240 pages: "Ecology and Life", "General biological laws of the ecosystem level of life", "General biological laws of the biosphere level of life", "Phylogeny of the organic world".

Due to the systematic selection of topics, the whole chapter, the training materials given in the paragraphs formed a logical whole with each other.

The authors paid serious attention to the issue of methodological elements of the textbook. First of all, at the beginning of each chapter of the textbook, they show the students what scientific knowledge they will have when studying the materials of this chapter. For example, at the beginning of the first chapter, students are told: "After reading the content of Chapter 1, you should:

- be able to describe the structural structure, basic features and importance of living organisms;
- be able to explain the hierarchical structure and general properties of biological systems;
- be able to analyze the tasks of ecology;

It is said that you need to be able to compare the peculiarities of the structural levels of living organisms. This encourages students to master this system of knowledge as they begin to study the chapter material, knowing what the most important scientific material in it consists of.

Another methodological component of the textbook is the "Apply Your Knowledge" guide to students at the beginning of each topic. For example, the second paragraph of the textbook is entitled "Development, sections and methods of ecology." In it to the students: Why do you think man needs knowledge about the way of life of the surrounding organisms?

*Where is this knowledge used?*

- *What environmental issues do you know?*
- *Instructions are given as to why every member of society should have environmental knowledge.*

Each subject consists of a common set of concepts arranged in a certain order. These concepts are slowly evolving, repeating and evolving from topic to topic, from chapter to chapter, from subject to subject, and acquiring a certain amount of knowledge. For example, topics such as the distribution and habitat of different animals in 7th grade zoology, "About biological systems" in 10th grade biology, and "General biological laws of life at the organism level" require use in 11th grade "Components of Ecosystems". Therefore, remembering the knowledge acquired by students from other disciplines in the study of a new topic, and linking this knowledge with the new subject, serves to implement such important requirements as the implementation of the systematic principle of didactics in the acquisition of knowledge, developing biological concepts in education. ! We consider the instruction "Apply your basic knowledge" to be one of the achievements of the authors and the textbook.

The textbook "Record the meaning of terms" is also reflected in the fact that the authors have developed questions aimed at further improving the quality of the methodological components of the textbook and the development of students' knowledge and skills on the studied topic. For example, after studying the topic "Components of Ecosystems" to students

1. Compare the concepts of "biogeocenosis" and "ecosystem". Identify the similarities and differences between them.
2. Explain the importance of producers in the ecosystem? Give examples of phototrophic and chemotrophic organisms.
3. Explain the role of reductants in the ecosystem based on examples.
4. Explain the nature of indicators such as self-recovery and sustainability of biogeocenoses.
5. What do you mean by self-regulation of biogeocenoses?

In finding answers to such tasks as

We believe that the task in the textbook, "Express your opinion", which allows students to explore the topic in more depth and fill in the tables for personal feedback, will also allow students to master the same topics independently and thoroughly.

It is well known that a person's cognitive ability is initially realized through his senses. Therefore, as important as the texts are in explaining the topics in the textbooks, the attached

pictures, diagrams, tables are equally valuable in terms of their functions and meanings, they can visually prove the content of the textbook, easily master the basic concepts of the subject, it is a fact that learning serves to perform important educational tasks such as understanding the morphological, anatomical, structural features of plants and animals in the subject under study. Since texts play an important role in the role of the source of knowledge in textbooks, the pictures attached to them will have the same value in terms of their function. For this reason, we will focus on some comments on the pictures attached to the study of the main text in this textbook

The textbook provides 74 color illustrations to explain and interpret the main text. The authors have worked hard to decorate the textbook with pictures, and it seems that the selected pictures correspond to the content of the topics studied. The authors have selected images that serve as a visual explanation of the topic materials and the most basic concepts in it. The color pictures in the textbook are intended to give students an initial idea of the topic being studied (table).

**TABLE THE NUMBER OF PICTURES ATTACHED TO THE PARAGRAPHS IN THE TEXTBOOK**

№	Chapters in the 11th grade textbook	Number of paragraphs in chapters	The number of images in the paragraphs	
			colored	colorless
1	I CHAPTER. Ecology and life	2	1	-
2	CHAPTER II. General biological laws of life at the ecosystem level	21	33	1
3	III. CHAPTER. General biological laws of the biosphere level of life	11	22	
4	VI. CHAPTER. Phylogeny of the organic world	10	17	

As can be seen from the table, four chapters in the textbook, 74 colors, one colorless picture were added to enrich the content of 34 paragraphs. All the pictures will undoubtedly serve to make it easier for the students to understand the content of the topic being studied. In particular, for the 21 paragraphs in the chapter on the general biological laws of life at the ecosystem level, Figure 3 allows students to clearly distinguish between autotrophic and heterotrophic organisms, Figure 5 allows students to visualize materials on aquatic animals, Figure 6 shows students living on land and air. allows them to master the material on the example of various animals distributed in this environment. In addition, we believe that Figures 44, 45, 49, and 63-67, selected for the study of the structure of the skin of animals, attached to the topic "Metabolism and Energy in the Biosphere" will serve to further improve the essence of the topics.

The textbook contains 5 topics of laboratory classes. Carrying out of these laboratory classes allows students to solidly study the subject materials through practical work, to further develop intellectual, qualification, potential.

A glossary of key terms is provided at the end of the textbook. The fact that the 4 chapters included in the topic are given in blue makes it easier for students to find the chapter they need.

However, we have seen that there are some more vague assignments in the methodological elements of the textbook. In particular, the sixth paragraph is given in the independent work on "Land, air, soil, living organisms as habitats." It is tasked to identify and tabulate the habitats of animals such as manta, redstart, golden ergazar, rishta, lobster, aurelia nereida. However, the text on this topic does not provide materials on the above-mentioned animals and does not specify how to perform an independent work assignment. We wanted the authors to indicate whether the animals given in this assignment could indicate which literature was given.

Similar vague assignments were encountered in the textbook's instructions for laboratory work 1. The guideline states, "Observe the growth and development of plants. Record the results of the observations in a weekly chart." However, there are no instructions on how to organize the growth and development of plants, the methodology of transfer. For example, paragraph 21 of the methodological components of the topic "Artificial ecosystems" in the section "Express your opinion" describes the main features of urban flora and fauna. How did the adaptations in them come about? Isn't the so-called task more difficult for students? In our opinion, it would be expedient to give this task to students in a simpler and clearer way and to show them what materials and tools to use in finding the answer.

## CONCLUSION

In our opinion, the above ideas in the textbook do not affect the quality and value of the methodological components of the textbook. We hope that our comments will be taken into account in the next edition of the textbook if the authors like them. Indeed, the above-mentioned Resolutions of the President of the Republic of Uzbekistan dated August 12, 2020 PQ-4805, the Cabinet of Ministers of the Republic of Uzbekistan dated 05.04.2019 No 281 also encourage authors to fulfill new tasks, such as creating new generations of textbooks that fully meet modern students.

Based on the above considerations, we believe that the authors of the biology textbook published for 11th-grade students of secondary schools have made a significant contribution to the creation and improvement of new generations of textbooks.

## REFERENCES

1. Sh.Mirziyoev Resolution of the President of the Republic of Uzbekistan dated August 12, 2020 No PP-4805 "On measures to improve the quality of continuing education and scientific efficiency in the field of chemistry and biology"
2. Resolution of the Cabinet of Ministers of the Republic of Uzbekistan "On measures to introduce a mechanism for the gradual transition to the system of creation and use of alternative textbooks for secondary schools" dated 05.04.2019 No 281
3. A. Abdukarimov, J. Tolipova, O Ishonqulova, M. Umaralieva, I. Abdurahmonova. Biology Textbook for students of 11th grade and secondary special, vocational education institutions of secondary education. Editor-in-Chief of Sharq Publishing and Printing Joint-Stock Company, Tashkent-2018
4. Antonova S.G., Tyurina L.G. Sovremennaya uchebnaya kniga. Creation of uchebnoy literatury novogo pokoleniya. M., 2001

5. O.Ahmedova, K.Zokirov. Collection of Scientific Works WARSAW, POLAND Wydawnictwo Naukowe "Science", pages 2021.114-119 for students of 10th grade and secondary special, vocational education institutions of secondary education
6. Bepalko, V.P. Quality and effectiveness of the textbook. Narodnoe obrazovanie. 2007. - № 8.
7. D. D. Zuev. Some problems of the structure of the school textbook. M., Prosveshchenie, 1975
8. T.N. Glubsheva, S.D. Chernyaevskix. «Laboratory work on the methodology of biology. Methodical recommendations Belgorod, NIU BelGu »2016
9. Mendubaeva, Z. A. The structure of the educational-methodical complex Actual tasks of pedagogy: materials I Mejdunar. nauch. konf. Read: Izdatelstvo Molodoy uchenyy, 2011
10. E.S. Tsikalo. Practicum on methods of teaching biology. Vladimir- 2013

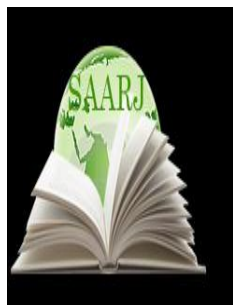

**ACADEMICIA**  
**An International  
 Multidisciplinary  
 Research Journal**  
 (Double Blind Refereed & Peer Reviewed Journal)

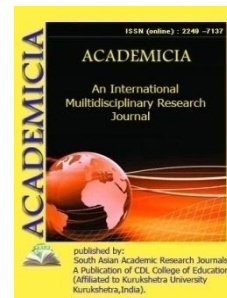

**DOI: 10.5958/2249-7137.2021.01073.9**

## MEDICAL LINGUISTICS, LINGUISTIC ANALYSIS OF DISEASES

**Shohida Olmasovna Ergashova\***

\*Assistant teacher of Department of Languages,  
 Medicine and Education Faculty,  
 Samarkand State Medical Institute,  
 UZBEKISTAN

### ABSTRACT

*Analysis of the linguistic features of diseases, the application of psycholinguistics in medicine, the causes of diseases in the human body, the contribution of scientists to the development of science, the study of the characteristics of the human response to the environment. Environmental factors play a leading role in the development of the disease, as they can directly affect the body and change its internal characteristics, which can be passed from generation to generation and cause the disease. On the contrary, any influence that only injures a particular place will, of course, lead to general events. For example; It is known that if a rash appears on any part of the body, a person becomes feverish, lazy, loses appetite, and so on. The process of verbal information, that is, the process by which people communicate and receive information from each other through speech, is the subject of study in many disciplines.*

**KEYWORDS:** *Genealogical Method, Quarantine-Quarantine, Psycholinguistics, Analyzer, Severe Pain, Leprosy.*

### INTRODUCTION

By the end of the 1990s, the inheritance of normal and pathological symptoms in more than four thousand people had been studied. 4.5-5.0% of newborns are currently born with genes that cause hereditary diseases. The genealogical method is also used to diagnose hereditary poor health. The essence of this method is that the causes of hereditary illness in humans are identified and studied by collecting and analyzing information about the genealogy of generations. Using the genealogical method, the science of genetics has shown that human abilities, talents, intelligence are passed from generation to generation, and this, in turn, depends on genetic factors.

Illness, sickness, disease is a pathological process that occurs when the body is exposed to harmful factors of the external or internal environment. The concept of disease has changed in the history of medicine. Environmental factors play a leading role in the development of the disease, as they can directly affect the body and change its internal characteristics, which can be passed from generation to generation and cause the disease. The disease is often caused by over-exposure to various microorganisms and toxins. This reduces the body's ability to adapt to the external environment and disturbs its balance with the environment. Developmental defects or hereditary defects can also cause the disease. For example, certain diseases, especially allergies, are sometimes congenital (Allergy). The causative agent affects and harms the organism, while activating the body's defenses and adaptive responses. Hence, the disease is usually characterized by the combination of two interrelated processes – the process of damage and protection against it.

Each disease disrupts the vital functions of the whole organism, but in many diseases the location of the pain in the body, as well as the signs of greater damage to a particular organ or system, are clearly visible. For example; Gastric or peptic ulcer: It is a common disease of the whole organism. It is a local symptom of ulcerative colitis. On the contrary, any influence that only injures a particular place will, of course, lead to general events. For example; It is known that if a rash appears on any part of the body, a person becomes feverish, lazy, loses appetite, and so on. In the culture of every nation there is a set of views that represent the names of diseases. They embody the worldview, religion, customs, way of life and history of this people. In particular, in the practical speech of the Uzbek people, the names of dangerous diseases such as cancer, tuberculosis, plague have long appeared. There are historical reasons for this. Although their cure has been found today, our people are satisfied with the use of such compounds as “bad disease”, “severe disease”, “bad disease”, “severe pain”. Our great thinker Abu Ali ibn Sina in his work “Laws of Medicine” cited many terms that form the basis of medical science. In particular, leprosy is described in the Laws of Medicine by the terms “lion's disease” and “Do ul-Assad.” It is clear that the patient is like a “lion” (animal), taking into account the symptoms of the disease.

The term quarantine, which is now rapidly entering our lives, is also interpreted by our great scientist. Ibn Sina worked on the treatment of diseases transmitted by microorganisms, bacteria, viruses, and to prevent it, the patient introduced into medicine a method of self-isolation for 40 days, self-isolation from humans. Ibn Sina called this method Al-Arba'in iyya. The word means “forty days.” The method he introduced spread to Italy and all of Europe with the help of Venetian merchants. And the method of self-isolation was called “quarantine-quarantine”, which means “forty” in Italian and “quarantine” in English.

Moreover, computer linguistics, which is rapidly developing in our lives, has not left the field of medicine indifferent, among all fields today. In social networks and forums on websites that are an integral part of modern society, we can find discussions on the topic of almost any debate and editing requirement that we cannot imagine. Of course, various diseases, problems with treatment, medical topics related to a healthy lifestyle are no exception. Due to the pandemic, the number of people who publish any information about their health on the Internet is growing every day, so every day a lot of information is received. The list goes on and on. The creation of projects, platforms, mobile applications, scientific research on medical terms used in the Uzbek language is important as a solution to the problem. In particular, the introduction of automated methods of information processing in the field of medical linguistics, lexicography requires



working on the basis of special optimal technologies based on the capabilities of mobile applications, the active use of modern information lexicographic software in lexicography. The creation of mobile applications in the field of medical lexicography shows that only electronic dictionaries allow you to quickly convey the whole essence of the lexeme to the reader. Automation of data processing, creation of new active lexicographic systems, as a result of which requires the acceleration of the transition from traditional dictionaries to automated (electronic) dictionaries. After all, the introduction to the field of linguistics is practically connected with the development of society. Because the health of society depends on the mental, physical and spiritual health of the individual. This means that research in this area requires medical professionals working with different categories and strata of the population to have high cultural speech skills in their work and to use every word in the language carefully. Requires a responsible approach to linguistic tools, which is a necessary condition of professionalism.

In Uzbek linguistics, medical linguistics has not been specifically studied as an object of monographic research. The existence of monographs on medical terminology in Russian, Turkish and English – a comprehensive analysis of the linguistic means of speech softening – shows the seriousness of this issue in world linguistics and its level of importance. Therefore, it is necessary to conduct a comprehensive study of medical linguistics in Uzbek linguistics and to study this issue. Because such research is of practical importance not only in speech linguistics, medical deontology, in particular, it serves to develop the culture of speech and enrich the content of medical education for medical professionals and to use it as a teaching material in education.

Psycholinguistics is the study of the formation of speech, as well as the processes of speech perception and formation in the context of their interaction with the language system; arose from the synthesis of psychology and linguistics. Psycholinguistics Develops a model of human speech activity and psychophysiological speech formation and examines them through psychological experiments. Psycholinguistics, which is close to linguistics in terms of its source of research, is close to psychology in its methods of research. It uses interrelated experiments, such as “semantic differential” and other experimental methods. A number of psycholinguistic practical issues include the teaching of the mother tongue, especially a foreign language; issues of speech education and speech therapy for preschool children; clinic of diseases of speech centers in the brain; problems of speech influence, especially in the activities of the media and propaganda; forensic psychology and criminology are responsible for identifying people based on the nature of their speech; It arose in the 1960s due to problems with machine translation and computer input of speech information and the need for theoretical explanations.

The concepts of language and speech are not interchangeable in physiology, psychology, pedagogy and medicine. Physiologists and psychologists are always engaged in speech, and in pedagogy they talk about the formation, development and enrichment of children’s speech. In medicine, speech disorders are closely related to the neurology department of linguistics. Recently, a new branch of science called Neurolinguistics has emerged between the disciplines of psychology, neurology and linguistics. This science studies the fact that speech activity is a product of the brain, the impact of brain disease on speech activity. Simply put, the object of study of neurolinguistics is aphasia. Damage to the speech area of the brain and the consequent impairment of speech activity were mentioned in the works of our ancestors Ibn Sina, Beruni, and although they focused on the treatment of this patient, but it could not be formed as a

separate branch of science. The problem of the effects of brain damage on speech has been studied consistently since the second half of the 19th century. Neuropsychology and related neurolinguistics as a special science was formed only recently – in the seventies of our century. In the Origin of this Science, A.A. The services of such scientists as Leontev, A.R. Luria, E.S. Bain, R.M. Boskis, Y.N. Venarskaya, O.S. Vinogradova, N.A. Eisler are great.

The first comprehensive book on neurolinguistics was written by A.R. Luria. The process of verbal information, that is, the process by which people communicate and receive information from each other through speech, is the subject of study in many disciplines. In particular, this process has been studied in depth by linguistics and psychology. Linguistics distinguishes between language, which is the main means of human communication, and the speech that occurs in the process of its direct communication, the internal structure, structural units, the different occurrence of these structural units in the speech process, the transition from “internal structure” to “external structure”. A number of issues have been studied in detail, such as the main stages and the relationship between the two structures. Man reflects being in his mind. Reflection is done using the sensory organs. The sensory organs, on the other hand, transmit certain information about the external world to the brain. The brain, on the other hand, generalizes this information. Apparently, the process of reflecting the objective world occurs through the central nervous system, the brain. The nervous system usually includes two groups of nervous systems: 1) the central nervous system and 2) the borderline nervous system. Speech that provides information about existence and its understanding is carried out through the direction of the borderline nervous systems towards the center. Boundary nervous systems provide the central nervous system with information about specific signs of objects and events in an objective being. That is why the organs involved in the borderline nervous system are called analyzers. They are the organs of sight, hearing, and taste. In each analyzer, two types of nerve structures are distinguished.

The structure that carries information from this sensory organ to the cerebral cortex;

The structure that directs the objects of existence (the cognitive zone of the brain);

The third level is the zone of the lingual membrane with a complex anatomical structure.

In this zone, a complex of signs from different analyzers of the brain is combined, resulting in the transition from sensory perception to language generalization. Speech formation occurs when language behavior is reversed: from the center to the border. The speech program formed in the zone where the brain analyzers are collected is concretized in the zone of speech practice and occurs using a projection motion system involving the speech organs (as well as the system that generates written speech). In contrast to the practical system of the brain (sensory or motor), the gnostic-practical curtain and the zone of closure of the curtain analyzers are characterized by functional asymmetry: the language system and thinking expressed through speech are connected with its hemisphere. The human brain is a complex biological network made up of hundreds of billions of nerve fibers – neurons. As a result of the interconnectedness of the neurons, the brain functions normally. Modern artificial neural networks are based on a model of neurons in the human brain. Today, neural networks are widely used to solve a number of practical problems. In particular, it is used in weather forecasting, image recognition (especially in the detection of oral and written speech), and in medical diagnosis.

**REFERENCES:**

1. M.N.Boliyev. Latin language and medical terminology – 2010
2. Nurmonov A., Yuldashev B. Linguistics and natural sciences. –Tashkent: 2005.
3. National Encyclopedia 2000-2005
4. Leontiev, A. A. Fundamentals of psycholinguistics / A. A. Leontiev. – M .: Cm, 1997 .—287 p.
5. Sedov, K.F. Neuropsycholinguistics / K.F. Sedov. – M .: Labyrinth, 2007 .—274 p.
6. Linguistic Encyclopedic Dictionary. – M .: “Great Russian Encyclopedia”, 2002. – 709 p.
7. Abduvahob Madvaliyev --- Linguistic analysis.
8. Sh. T. Iskandarova - - - Handbook of medical history. Tashkent – 2012

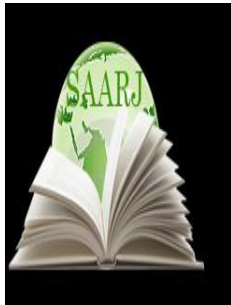

**ACADEMICIA**  
**An International  
 Multidisciplinary  
 Research Journal**  
 (Double Blind Refereed & Peer Reviewed Journal)



**DOI: 10.5958/2249-7137.2021.01074.0**

## THE ESSENCE OF ECOLOGICAL AND RECREATIONAL TOURISM IN OUR COUNTRY, AND THE IMPORTANCE OF DEVELOPING IT

**Gapparov Azim Kayumovich\***

\*Teacher of Department of Economic Analysis and Statistics,  
 Samarkand Institute of Economics and Service,  
 UZBEKISTAN

### ABSTRACT

*The article describes the conceptual directions of improving the quality of services in tourism and scientific-theoretical and methodological issues of its evaluation. It shows the factors affecting the quality of tourism services, the specifics of hotel services, the system of indicators that reflect the quality of service in hotels, the content and ways to determine them.*

**KEYWORDS:** *Tourism, Ecological Tourism, Hotel, Service, Service, Quality, Service Quality, Service Quality In Hotels, System Of Indicators Representing The Quality Of Service In Hotels, Recreational Tourism.*

### INTRODUCTION

In the current pandemic, the tourism industry is developing very slowly. The pandemic caused an economic crisis in 185 countries around the world<sup>1</sup>. The main focus on the formation and development of tourism in Uzbekistan began after gaining independence. To date, tourism in our country is considered a priority of economic development, and attention to the development of this sector has risen to the level of public policy. Necessary organizational, legal and economic mechanisms for the development of tourism have been created, relevant legal documents have been adopted by our government, and work in this direction is still ongoing. In this regard, decrees, resolutions of the President of the Republic of Uzbekistan, resolutions of the Cabinet of Ministers of the Republic of Uzbekistan have been adopted and are being implemented.

Implement comprehensive measures to fully utilize the potential of tourism, accelerate the development of foreign and domestic tourism, ensure economic growth and improve the quality of services in accordance with international standards and increase the share of tourism in economic growth. In order to ensure the implementation of Resolution PD-4058 "On measures to support enterprises, ensure their sustainable operation and increase export potential", the Cabinet

of Ministers of the Republic of Uzbekistan on January 30, 2009 approved the resolution of the Ministry of Foreign Economic Relations and Trade. Approved the proposal to establish an Interdepartmental Coordination Council for Support and Development of Tourism<sup>2</sup>.

This decision of the Cabinet of Ministers of the Republic of Uzbekistan marked a new stage in the development of sustainable and equitable development of tourism in the country. In fact, it was recognized that tourism in Uzbekistan is developing mainly in central, industrialized cities.

According to the data, 76.2% of the total tourist flow in Uzbekistan falls on the cities of Samarkand, Bukhara, Tashkent and Khiva, 24.6% of foreign tourists are interested in the Fergana oasis. 40% of the tourist potential is in Tashkent city and Tashkent region, 37% in Samarkand, Bukhara and Khorezm regions, 16% in Fergana oasis and Surkhandarya region. The remaining provinces, which occupy 50% of the territory, account for only 7% of tourism potential<sup>3</sup>.

Therefore, the Cabinet of Ministers of the Republic of Uzbekistan has established a working group on the development of tourism in the regions under the leadership of each regional administration. Because the tourism potential of the regions has not been studied yet, the development of tourism in the regions is very slow, the existing tourist resources in the regions are not fully explored, and the development of tourism in the regions is unsatisfactory. The main reason for the serious problems in the smooth and sustainable development of tourism in Uzbekistan in all regions is the uneven use of tourism potential and tourist resources in the regions. The decision of the Cabinet of Ministers is an important step in solving these problems. Second, from the point of view of transforming tourism into the main sectors of our economy, we can distinguish its four main regional links or stages:

1. Development of international tourism in Uzbekistan;
2. Development of national tourism in Uzbekistan;
3. Development of local tourism in Uzbekistan;
4. Development of regional tourism in Uzbekistan.

It is known that today Uzbekistan pays more attention to the development of international tourism. However, in the development of tourism in the country, all the regional geographical links will have to work in one system.

Scientific and methodological issues of zoning of tourism geography in Uzbekistan have not yet been fully studied. The fact that this serious problem has not been resolved indicates that the tourism industry is in the formative stage. In particular, theoretical issues such as factors of tourist zoning, classification and topology of tourist areas, their economic relations with regional tourist complexes or systems require serious research in the future.

One of the key issues in the development of tourism in our country is the development of ecological and recreational tourism in the context of modernization of the economy. The fact that this problem is considered in the case of Jizzakh region shows its even greater importance. Because it is at this level that there is an organizational and legal basis for the organization and development of tourism. Another aspect of the topicality of the topic is that in order to increase national tourism in Uzbekistan, it is necessary to effectively use the tourist opportunities in the regions. Tourist resources in the districts of the regions, the study of opportunities, scientific

evaluation of existing tourist facilities, their protection, development of promising tourist routes, the organization of various directions of tourism in the regions are of great practical importance.

Since the development of any sector of the macroeconomy is primarily based on improving the material and spiritual well-being of people, the development of national tourism in Uzbekistan and the development of ways to effectively use the tourist potential of the regions to determine the future is one of the most pressing issues in tourism in Uzbekistan.

The topic we have chosen is also aimed at addressing the current issues and the development of promising areas for the development of regional tourism.

In this regard, the President of the Republic of Uzbekistan I.A. It is appropriate to quote Karimov: "When I say tourism business, I mean not just the development of tourism, but a broader concept. It is about the development of services and services directly related to tourism. The development of this sector will inevitably make a huge contribution to the economic and social development of our country by attracting many foreign tourists to our country and, most importantly, by providing large foreign exchange earnings."<sup>4</sup>. In this regard, the development of tourism in Jizzakh region, the main part of which is religious and recreational tourism, is one of the most pressing issues. The origin of ecotourism has led to an increase in the anthropogenic (human activity) burden on natural and social resources, cultural and historical tourist resources as a result of the growing popularity of international tourism. The World Tourism Organization's 21st Century Tourism Forecasts pose serious and global challenges to tourism demand, needs, and the use of natural resources. This is because European ecologists and economists proved in the 70s of the last century that the growing popularity of tourism around the world has a negative impact on the environment and nature.

Today, anthropogenic pressure in the form of tourism affects almost all sectors of the tourism industry. The German Council for Global Change was one of the first to develop the following models. The models are called syndromes (a set of symptoms characteristic of a disease) and are referred to the WTO.

Land Crisis Syndrome. The fact that lands (fertile) lands are becoming unusable in agriculture and are being taken out of use altogether is a serious obstacle to the development of recreation in nature. Developmental syndrome. The complete crisis of natural landscapes and the natural catastrophe in these places, the ecological crisis (Aral Sea), the eternal extinction of major biological species (Turan tiger).

Waste syndrome. The fact that the global ecological crisis is threatening the survival of mankind as a result of the controlled and uncontrolled development of toxic waste (land) and burial (world oceans) in the world.

After the publication of this international document with all its calculations and proofs, more than 400 articles will be published abroad on the use of natural and historical-cultural tourist resources in tourism and the negative impact of tourism on these resources..

In 1996, the World Tourism Organization (WTO) and the World Tourism and Travel Council (WTC), the World Green Movement, and the World Green Movement launched the concept of sustainable tourism development in the 21st century. "(Adenda 21 for travel and tourism industry). The 21st Century Agenda and Comprehensive Action Plan for the Tourism Industry

and Travel was signed by 182 heads of state at the 1992 UN International Conference on Environment and Development.

In 2002, to mark the 10th anniversary of the 21st Century Agenda, the UN General Assembly in Rio de Janeiro declared 2002 the International Year of Ecotourism. According to P. Shackelford, a WTO expert on Europe, the word ecotourism was used before the "21st Century Agenda". There are also sources that A. Mueller first used the word "ecotourism" in 1978<sup>4</sup>.

In Russia, the term "eco-tourism" began to appear in the press in the 1980s. The Bureau of International Youth Tourism of the former Soviet Union, Irkutsk region Specialists of the Sputnik Youth Center of the Leninist Communist Youth Union of the All-Union for the first time developed Ecotour routes, and these ecotour routes are officially called "Ecological Tourism" routes. Then in 1997, Gujin G.S. and M.Yu. Belikov and E.V. Klimenok was one of the first in Russia to define "the basis of eco-tourism is environmental protection and conservation." For that time as well as now, it has been concluded that this definition is the most convenient and represents the true essence of ecotourism<sup>5</sup>.

For the first time in Uzbekistan, the concept of prospects for the development of the essence, goals and objectives of ecotourism was developed by the State Committee for Nature Protection of Uzbekistan<sup>6</sup>.

In the development of tourism in any country, it is necessary to have tourism resources and development factors, which are inextricably linked. Tourism resources are understood by tourism professionals in different ways. In fact, it means a single economic sector in terms of tourism resources and the content of tourist resources. Only the availability of tourist resources will be the basis for the formation of tourism. That is, tourist resources are the basis of tourism development.

Many experts divide tourism resources into levels and assess these levels as a priority or downside in tourism. For example, in order to develop tourism in certain countries, the first parties prioritize international tourism in this country and the diversity and attractiveness of tourism facilities and resources in this country. This is a very correct conclusion.

On the other hand, for the development of tourism in a country, well-known accommodation resources (hotels, restaurants), transport system, tourist routes and services on these tourist routes, excursion services on the routes meet the requirements of the perfect world. Without denying the above, the third party believes that the development of tourism is the provision of excellent services in the field of tourism in a particular country. Also, those who put the idea that good tourism management in the country will create a basis for the development of tourism in this country, and the rest can be developed, are right.

As tourism is a complex socio-economic sector, it is possible to prioritize each direction in tourism. It really should be that way. However, the development of tourism in a particular country depends primarily on the fact that the first tourist resources in tourism combine diversity and antiquity, mystery, splendor, miracle, history and other similar features.

If the tourist resources of the countries are of international importance, if this resource is known in the countries of the planet, the international tourist flow will start to flow into this country and vice versa. Therefore, when the above-mentioned tourism resources function perfectly for the same purpose, tourism in a particular country will develop at the expected level. Therefore, the

use of tourism resources in the development of tourism or the development of tourism resources should be placed in the following order:

Tourist resources are all anthropogenic (man-made) and natural objects (natural geographical area, flora, fauna, biodiversity, unique natural landscapes, climatic features, recreation areas, etc.) that attract and attract tourists.

Tourist accommodation resources - tourist accommodation or houses, hotels, tourist camps, rental houses, etc. Tourist catering resources - kitchens, bars, restaurants, teahouses, cafes.

Resources that provide transport services to tourists - all vehicles, local modes of transport.

The main reason for our brief focus on tourism resources in this chapter is to identify and identify opportunities for tourism development based on the study of the availability (scarcity, abundance, international or local significance) of tourism resources in research areas or administrative territories of the state. Second, the use of tourism resources mentioned in the formation of the dissertation or the possibility of creating these resources, the priorities of use in planning tourism are developed.

When we analyze the number and activity of tourist flows around the world, so far the number of tourists visiting ancient, historical and miraculous monuments is in the first place, recreational tourism is in the second place and shrine tourism is in the third place. It is also known from the periodicals and international media that eco-tourism has been gaining the status of secular tourism in the last five years.

Therefore, before studying the possibilities of developing ecological and recreational types in our country, it is important to know the essence of these types of tourism, to analyze the current state of development of these types of tourism in our country.

#### **REFERENCES:**

1. <https://usajournalshub.com/index.php/tajir/article/view/746/700>
2. Minutes of the meeting of the Cabinet of Ministers of the Republic of Uzbekistan, 07–1–5. January 30, 2009 - 63
3. Komilova N.A., Usmanova L.I. Development of tourism in Uzbekistan: problems and realities. SamISI, Uzbekistan: tourism, economy and ecology, Samarkand, 2009, pp. 26-30.
4. Karimov IA, Prosperity and free homeland, free and prosperous life is our ultimate goal. Tashkent, Uzbekistan, 2000. – 232 p.
5. Xrabovchenko V.V. Ecological tourism. Moscow, “Academy”, 2004. pp.3-6.
6. The concept of development of ecotourism in Uzbekistan. J. Ecology Bulletin, № 6 Tashkent: 2007, 17-26.p.



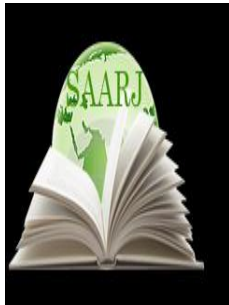

**ACADEMICIA**  
**An International  
Multidisciplinary  
Research Journal**  
**(Double Blind Refereed & Peer Reviewed Journal)**



**DOI: 10.5958/2249-7137.2021.01086.7**

## **ACCEPTABILITY AND CHALLENGES OF ONLINE ASSESSMENT AT ZCAS UNIVERSITY DURING THE COVID-19 ERA**

**Kelvin Mukolo Kayombo\*; Brian Mwiinga\*\***

School of Business,  
ZCAS University, Dedan Kimathi, P.O,  
Lusaka, ZAMBIA  
Email id: [kkayombo@zcas.edu.zm](mailto:kkayombo@zcas.edu.zm),

Zambia Centre for Accountancy Studies,  
Dedan Kimathi, P.O, Lusaka, ZAMBIA  
Email id: [brian.mwiinga@zcas.edu.zm](mailto:brian.mwiinga@zcas.edu.zm),

### **ABSTRACT**

*The aim of this study was to evaluate the acceptability of online examinations to students at ZCAS University. The emergence of coronavirus disease 2019 (COVID-19) forced the education system world-wide to adopt online education immediately. An online survey was conducted amongst the students at ZCAS University in Lusaka, Zambia after the June 2020 online examination session. A random sample of 218 students participated in the online survey. Firstly, a descriptive statistical analysis of the responses was conducted in which frequencies were tabulated to give details of age, sex, programme level and mode of study of the respondents. Thereafter, cross tabulations which produced chi-square value testing for significance were run. The main findings of the study were that mode of study and programme level had significant influence on acceptability of online assessments. Students who were on the distance study mode and those that were doing postgraduate programmes had better experience of online assessment than the others. Gender and age had no significant influence on acceptability of online assessment. With respect to the challenges associated with online assessment, the study found that candidates' typing speed, electricity load shedding, internet speed and the cost of data bundles had adverse impact on acceptability of online assessment. The respondents also indicated that unavailability of the platform and internet access rarely affected their experience of online assessment, while bad electronic gadget was never a factor. The majority of the respondents were however satisfied with their experience of online assessment.*

---

**KEYWORDS:** *COVID-19, Higher education, Lockdown, Online assessment, ZCAS University.*

---

## 1. INTRODUCTION

The aim of this study was to evaluate the acceptability of examinations delivered through online platforms to students at ZCAS University. Accordingly, we conducted an online survey of students at ZCAS University after the June 2020 examinations.

In order to enhance integrity of assessments in online education, universities need to understand challenges students face and tailor their offerings accordingly. Therefore, the overarching question we set ourselves to guide this study was: *To what extent do gender, mode of study, age, and level of study affect acceptability of online assessment in higher education?* For example, do female students respond the same way to online assessment as their male counterparts? How about students studying on different modes of study such as full time, part time and distance education? Is online assessment equally acceptable to students from different age groups? Similarly, to what extent is online assessment attractive to undergraduate students compared to their postgraduate counterparts?

On 18<sup>th</sup> March 2020 the Government of the Republic of Zambia announced the closure of all schools, colleges and universities in the country to mitigate against the spread of the coronavirus disease 2019 (COVID-19). Higher learning institutions were encouraged to switch teaching and learning to online platforms. Accordingly, ZCAS University switched all full time, part time and distance education teaching and learning to online platforms.

At the end of the semester i.e. in early June 2020, the university had to decide how the final examinations would be conducted since the country was still on lockdown and in-person contact with students was still suspended. Following deliberations of the University Senate, it was decided to conduct examinations via the virtual learning environment used by the university i.e. MOODLE platform. Accordingly, question papers were uploaded on the platform for students to download. Students were then required to answer the questions offline and upload their answer scripts on the platform within specified time limits.

In order to mitigate against poor internet speed, slow typing speed, electricity load shedding and other factors that might have affected students' ability to deal with this novel method of examination, students were given an additional 30 minutes to the hitherto three hours examination duration in which to answer the questions. Additionally, the number of questions was reduced by one. Since the examination was effectively a non-proctored open-book exam taken in real time, examiners were required to set problem-based questions so that students could not easily find answers by searching their reading materials and internet sources.

In order to assess students' experiences with online examinations at ZCAS University during the COVID-19 pandemic, we conducted an online survey after the June 2020 examination session. Our findings indicate that the mode of study and programme level had significant influence on acceptability of online assessment, while gender and age did not have such effect.

With respect to mode of study, only 33.8% of full-time students were willing to take all or most of their future assessments online, while a larger proportion, i.e. 39%, indicated that they would not prefer to take any future assessments via online platforms. On the other hand, 58.1% of part-time and 54.5% of ODeL students indicated that they would prefer to take all or most of their future assessments online. The Pearson chi-square value of 0.021 which is less than 0.05

confirms that there is a significant relationship between mode of study and desire to take future assessments via online platforms.

With regards to level of study, majority of the undergraduate students (53%) did not have enough time to attempt the final examinations. On the other hand, 59% of the postgraduate students had enough time to attempt the examinations at least most of the time. This indicates that postgraduate students had better experiences with the online assessment compared to their undergraduate counterparts. The Pearson chi-square value of 0.006, which is less than 0.05, buttresses this conclusion.

With respect to challenges faced by students, our study found that most of the respondents always had an issue with typing speed, electricity load shedding, internet speed and cost of data bundles during their online assessments. Unavailability of the platform/link and access to internet rarely affected the students during online assessments; while the state of their electronic gadgets such as laptops was never an issue.

Lastly, the respondents were asked to rate their overall satisfaction/dissatisfaction with online assessment. The majority of students, i.e. 60%, were either satisfied or highly satisfied with the online assessments. Most of the respondents also indicated that they were willing to take some (25%), most (15%) or all (33) their assessments online in future. These findings suggest that ZCAS University students were generally satisfied with online assessments.

We organise the remainder of the paper as follows. Section 2 provides a brief review of the prior literature, while a description of the methodology and dataset is provided in Section 3. We discuss our empirical results in Section 4, and offer concluding remarks in Section 5.

## **2. LITERATURE SURVEY**

Abdullah and Ward (2016) designed a General Extended Technology Acceptance Model for E-Learning (GETAMEL) which suggests external factors that affect students' adoption of e-learning. We believe that these factors can be used to assess effectiveness of examinations that are delivered through online platforms. The five factors they identified as having a significant effect on students' perceived ease of use (PEOU) and perceived usefulness (PU) of e-learning are Self-Efficacy, Subjective Norm, Perceived Enjoyment, Computer Anxiety and Experience. PEOU and PU of online assessments affect students' attitude towards online examinations, and subsequently their intention to participate and actual participation in online examinations. We have used the GETAMEL model in our review of the literature to identify challenges of adopting online examinations in higher education.

### **2.1 CHALLENGES IN ONLINE ASSESSMENTS**

Kearns (2012) categorised online assessments into five groups, namely written assignments, online discussions, fieldwork, quizzes and exams, and presentations. In the absence of in-person assessment during the COVID-19 lockdown, online assessments were the only option available for universities that switched to online learning mode. However, online assessments have unique challenges in addition to those found in in-person assessments. Due to distance between the student and the university, and technology deficiencies, e-proctoring and in-person supervision of students during the assessment may not be feasible. Accordingly, students' commitment to submit their work wanes (Kearns, 2012; Guangul *et al.*, 2020). Other challenges faced in

administering assessments online include slow internet speed, lack of electronic gadgets, poor time management and delayed feedback from tutors.

The issue of academic integrity or cheating by students in online assessments is particularly thorny. Although some researchers have raised concerns about the possibility of students cheating in online assessments (Kearns, 2012; Guangul *et al.*, 2020), the majority of studies have concluded to the contrary. For example, in her review of the academic integrity literature, Eaton (2020) found that there was actually more academic misconduct in face-to-face environments compared to online assessments. In the case of postgraduate students, Ladyshevsky (2015) concluded that there was no statistically significant difference in the mean test scores when multiple choice questions for postgraduate students were administered in person compared to unsupervised online arrangements.

However, in the COVID-19 era, the immediate switch to emergency remote learning has different implications for academic integrity compared to ordinary online learning. For example, the stress levels students experience as a result of a sudden switch to emergency remote learning are much higher (Eaton, 2020; White, 2020b). At the same time, commercial contract cheating and academic file-sharing companies have increased in number and become more aggressive in their marketing practices (White, 2020a). Consequently, students face greater temptation to engage in academic misconduct during the COVID-19 era compared to ordinary online learning circumstances (Eaton, 2020).

## 2.2 SATISFACTION WITH ONLINE ASSESSMENT

In a study in India involving 431 students, Bisht, Jasola and Bisht (2020) discovered that online examinations were more acceptable than traditional face-to-face ones. This was particularly the case with female students compared to their male counterparts. Another study carried out by Elzainy, El Sadik and Al Abdulmonem (2020) noted that students' performance in online assessments was better than in previous face-to-face assessments for the same group of students, particularly in the case of female students. This study found that majority of the students and staff, i.e. 58.82%, were satisfied with online assessment.

Other researchers have affirmed this position by demonstrating that students' performance in online examinations was better than in in-person assessments (Gonzalez *et al.*, 2020; Prigoff, Hunter and Nowygrad, 2020; Abdollahi *et al.*, 2021; García-Peñalvo *et al.*, 2021). The enhanced student performance during the COVID-19 lockdown has been attributed to students having more study time and also due to lack of security of the examinations.

However, some researchers concluded to the contrary. For example, Slamet, Amrullah and Sutiah (2021) found that online dissertation supervision was not effective, while online assessments were less effective compared to in-person assessments. Similarly, for examinations that require student-patient contact, such as in dentistry, online assessment is not feasible (Wu *et al.*, 2020).

## 3. DATA AND METHODOLOGY

We collected data for this study from a Google Docs online questionnaire that was availed to all students at ZCAS University through the virtual learning environment (VLE). A message was sent to all students through the VLE urging them to provide feedback about their experiences with online examinations since the COVID-19 induced lockdown that prevented in-person

examinations. 272 students out of a population of 2,015 who sat for the June 2020 final examinations completed the online questionnaire.

The main research question we set out to answer in this study was: *To what extent do gender, mode of study, age, and level of study affect acceptability of online assessment in higher education?* To answer this question, we used SPSS's cross tabulations, chi-square tests and analysis of variance (ANOVA) to process and analyse the data.

#### 4. EMPIRICAL RESULTS

We imported the questionnaire responses from Google Docs into an Excel spreadsheet for data cleaning. After data cleaning, we remained with 218 usable questionnaire responses.

##### 4.1 DESCRIPTIVE STATISTICS

In order to determine internal consistency of the survey questionnaire, we generated the Cronbach's alpha coefficient after importing the data into SPSS. The Cronbach's alpha coefficient obtained for the data was 0.73 as can be seen from Table 1 below. The coefficient is higher than the recommended minimum of 0.7, suggesting that our data collection instrument was reliable.

**Table 1 Cronbach results from SPSS**

Reliability Statistics		
Cronbach's Alpha	Cronbach's Alpha Based on Standardized Items	N of Items
.732	.737	8

We present descriptive statistics in Tables 2 to 3 and Figures 1 to 2 below. As can be seen from Table 2 below, majority of the respondents were male (57.8%), while female student comprised 42.2%. There were slightly more male than female students in the sample compared to the student population which has a proportion of about 50:50 (Edurole, 2021).

**Table 2 Gender of Respondents**

		Gender			
		Frequency	Percent	Valid Percent	Cumulative Percent
Valid	Female	92	42.2	42.2	42.2
	Male	126	57.8	57.8	100.0
Total		218	100.0	100.0	

In terms of age, Figure 1 below shows that most of the respondents were in the lower age groups of between 16 to 44 years. This reflects the country's population distribution by age as 65.7% are aged 24 or younger, while only 5.2% are over 55 years (IndexMundi, 2021).

**Figure 1 Age of Respondents**

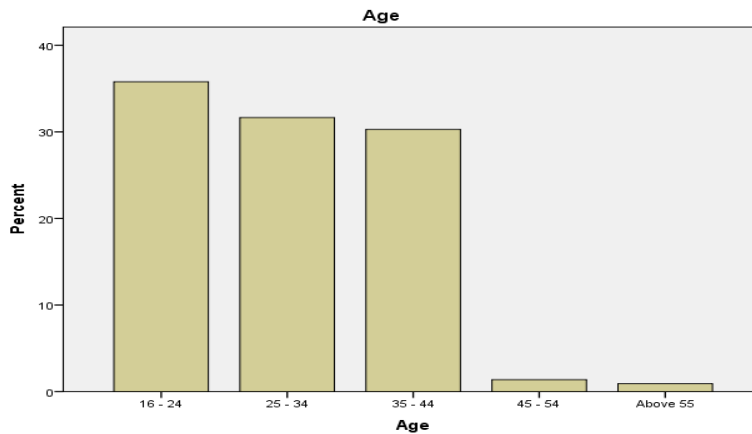

With regard to mode of study, the University offers its learning programmes on three modes. Some students study on a full-time basis, which means they engage with their lecturers during normal working hours from 08:00 hrs to 17:00 hrs. Part time or evening students have classes from 17:30 hrs to 20:00 hrs. The third mode of study is referred to as open, distance and e-learning (ODEL). Most of the teaching and learning on ODeL takes place through the VLE, while in-person classes were conducted for two weeks within the semester.

As shown in Figure 2 below, majority of the respondents were ODeL students (50%), followed by full time students (36%) and part time students (14%).

**Figure 2 Mode of Study of Respondents**

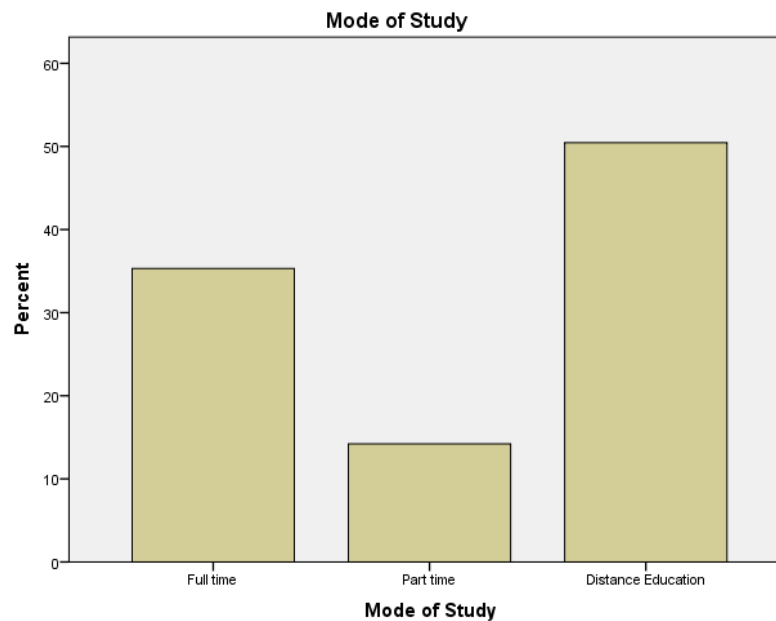

In terms of the level of study, the University offers undergraduate and postgraduate learning programmes. As shown in Table 3 below, the majority of the respondents were undergraduate students (82%), while postgraduate students comprised (18%). This reflects the overall student population composition in the University.

**Table 3 Programme level**

### Programme Level

		Frequency	Percent	Valid Percent	Cumulative Percent
Valid	Undergraduate	179	82.1	82.1	82.1
	Postgraduate	39	17.9	17.9	100.0
	Total	218	100.0	100.0	

## 4.2 GENDER AND ONLINE ASSESSMENT

To establish whether there was any significant relationship between gender and acceptability of online assessment, we ran a cross tabulation between gender and the perceived effect on grades/results as a result of the switch from face-to-face to online assessment. The results are given in Table 4 below.

**Table 4 cross tabulation between gender and effect on results/grades**

**Gender \* Change to online exam negatively affect grades/results Crosstabulation**

			Change to online exam negatively affect grades/results					Total
			Significantly	Highly	Moderately	Minimally	None	
Gender	Female	Count	12	14	23	22	21	92
		Expected Count	12.7	21.1	23.6	18.1	16.5	92.0
		% within Gender	13.0%	15.2%	25.0%	23.9%	22.8%	100.0%
	Male	Count	18	36	33	21	18	126
		Expected Count	17.3	28.9	32.4	24.9	22.5	126.0
		% within Gender	14.3%	28.6%	26.2%	16.7%	14.3%	100.0%
Total	Count	30	50	56	43	39	218	
	Expected Count	30.0	50.0	56.0	43.0	39.0	218.0	
	% within Gender	13.8%	22.9%	25.7%	19.7%	17.9%	100.0%	

### Chi-Square Tests

	Value	df	Asymp. Sig. (2-sided)
Pearson Chi-Square	7.807 <sup>a</sup>	4	.099
Likelihood Ratio	7.953	4	.093
Linear-by-Linear Association	5.052	1	.025
N of Valid Cases	218		

a. 0 cells (0.0%) have expected count less than 5. The minimum expected count is 12.66.

We noted similarities in the perception of both male and female students as regards the effect of the switch in the assesment model on grades. Although a larger proportion of female students were more positive about the switch to online assessment, majority of both male (57.1%) and female (71.8%) students thought that the switch to online assessment would not affect their grades highly or significantly. We could not find any significant relationship between gender and

the perceived effect on grades/results as a result of switching from face-to-face to online assessment. This is also confirmed by the Pearson chi-square value of 0.099 which is above 0.05.

To buttress the conclusion above, we ran another cross tabulation between gender and the proportion of future online assessments the respondents were willing to take. We present the results of this cross tabulation in Table 5 below.

**Table 5 cross tabulation between gender and future online assesment**

**Gender \* Proportion of future online exams Crosstabulation**

			Proportion of future online exams				Total
			All	Most	Some	None	
Gender	Female	Count	28	10	21	33	92
		Expected Count	30.4	13.5	23.2	24.9	92.0
		% within Gender	30.4%	10.9%	22.8%	35.9%	100.0%
	Male	Count	44	22	34	26	126
		Expected Count	41.6	18.5	31.8	34.1	126.0
		% within Gender	34.9%	17.5%	27.0%	20.6%	100.0%
Total	Count	72	32	55	59	218	
	Expected Count	72.0	32.0	55.0	59.0	218.0	
	% within Gender	33.0%	14.7%	25.2%	27.1%	100.0%	

#### Chi-Square Tests

	Value	df	Asymp. Sig. (2-sided)
Pearson Chi-Square	6.822 <sup>a</sup>	3	.078
Likelihood Ratio	6.807	3	.078
Linear-by-Linear Association	3.461	1	.063
N of Valid Cases	218		

a. 0 cells (0.0%) have expected count less than 5. The minimum expected count is 13.50.

As can be seen, there is no significant relationship between gender and the proportion of future online assessments the respondents were willing to take. This is supported by the Pearson chi-value of 0.078 which is above 0.05. We can therefore, conclude that there is no significant relationship between gender and acceptability of online assessment at ZCAS University.

Our findings are contrary to what some researchers have found elsewhere. Bisht, Jasola and Bisht (2020) and Elzainy, El Sadik and Al Abdulmonem (2020), for example, concluded that online examinations were more acceptable than traditional face-to-face ones particularly for female students compared to their male counterparts.

#### 4.3 MODE OF STUDY AND ONLINE ASSESSMENT

We were also interested in establishing whether candidates studying on different modes had any peculiar experiences with online assessment. Accordingly, we ran a cross tabulation between



mode of study and desire to undertake online assessments in future. The results are presented in Table 6 below.

**Table 6 Mode of study & proportion of future online assessments cross tabulation**

**Mode of Study \* Proportion of future online exams Crosstabulation**

			Proportion of future online exams				Total
			All	Most	Some	None	
Mode of Study	Full time	Count	20	6	21	30	77
		Expected Count	25.4	11.3	19.4	20.8	77.0
		% within Mode of Study	26.0%	7.8%	27.3%	39.0%	100.0%
	Part time	Count	14	4	9	4	31
		Expected Count	10.2	4.6	7.8	8.4	31.0
		% within Mode of Study	45.2%	12.9%	29.0%	12.9%	100.0%
	Distance Education	Count	38	22	25	25	110
		Expected Count	36.3	16.1	27.8	29.8	110.0
		% within Mode of Study	34.5%	20.0%	22.7%	22.7%	100.0%
Total	Count	72	32	55	59	218	
	Expected Count	72.0	32.0	55.0	59.0	218.0	
	% within Mode of Study	33.0%	14.7%	25.2%	27.1%	100.0%	

#### Chi-Square Tests

	Value	df	Asymp. Sig. (2-sided)
Pearson Chi-Square	14.961 <sup>a</sup>	6	.021
Likelihood Ratio	15.324	6	.018
Linear-by-Linear Association	5.820	1	.016
N of Valid Cases	218		

a. 1 cells (8.3%) have expected count less than 5. The minimum expected count is 4.55.

Only 33.8% of full-time students were willing to take all or most of their future assessments online, while a larger proportion, i.e. 39%, indicated that they would not prefer to take any future assessments via online platforms. On the other hand, 58.1% of part-time and 54.5% of ODeL students indicated that they would prefer to take all or most of their future assessments online. Part-time and ODeL students who did not prefer to take any future assessments online were a significant minority at 12.9% and 22.7% respectively. The Pearson chi-square value of 0.021 which is less than 0.05 confirms that there is a significant relationship between mode of study and desire to take future assessments via online platforms.

To buttress the findings above, we carried out an analysis of variance (ANOVA) to ascertain whether there was any significant difference in the means of fulltime, part-time, and ODeL students as regards adequacy of time to submit their online assessments. We present the ANOVA results in Table 7 below.

The ANOVA significance value of 0.007, which is less than 0.05, indicates that there is a significant relationship between mode of study and experience with online assessments. Clearly,

the mean of the respondents from the fulltime students (3.23) was significantly different from that of the part-time students (2.45) and their ODeL counterparts (2.63).

The reason part-time and ODeL students seem to prefer online assessments could be related to travelling costs and convenience. Part-time and ODeL students are normally in full time employment, so getting permission/leave to travel for face-to-face examinations could be a challenge. ODeL students are particularly adversely affected as most of them live in towns and cities far away from the University. We can also attribute our study's findings to the fact that part-time and ODeL students, most of whom are in gainful employment, have more resources and greater access to the internet than full-time students, and can therefore, easily participate in assessments conducted via online platforms.

**Table 7 ANOVA table for Mode of study and adequacy of time in submitting answer scripts**

**Descriptives**

Adequate time for submitting answer scripts

	N	Mean	Std. Deviation	Std. Error	95% Confidence Interval for Mean		Minimum	Maximum
					Lower Bound	Upper Bound		
Full time	77	3.23	1.413	.161	2.91	3.55	1	5
Part time	31	2.45	1.434	.258	1.93	2.98	1	5
Distance Education	110	2.64	1.463	.140	2.36	2.91	1	5
Total	218	2.82	1.469	.099	2.63	3.02	1	5

**ANOVA**

Adequate time for submitting answer scripts

	Sum of Squares	df	Mean Square	F	Sig.
Between Groups	21.099	2	10.549	5.075	.007
Within Groups	446.924	215	2.079		
Total	468.023	217			

#### 4.4 AGE AND ONLINE ASSESSMENT

The other issue we addressed in this study was to determine whether any significant relationship exists between age of the respondents and their experience with online assessments. Firstly, we ran a cross tabulation between age and overall satisfaction with online assessments. The results of the cross tabulation are presented in Figure 3 below.

We note from the cross tabulation that majority of the respondents across all the age groups were generally satisfied with their experience with online assessment. This is confirmed by the Pearson chi square value of 0.302 which is greater than 0.05, indicating that there is no significant relationship between age and satisfaction/dissatisfaction with online assessments.

Secondly, we ran another cross tabulation to establish whether there was any significant relationship between age and perceived effect of the switch to online assessments on results/grades. We present the results Table 8 below.

Again, the response patterns were generally similar across the age groups. The Pearson chi square value of 0.501, which is way above 0.05, indicates that there is no significant relationship between age and perceived effect of the switch to online assessments on results/grades.

**Figure 3 Cross tabulation between age and level of satisfaction/dissatisfaction with online assessment.**

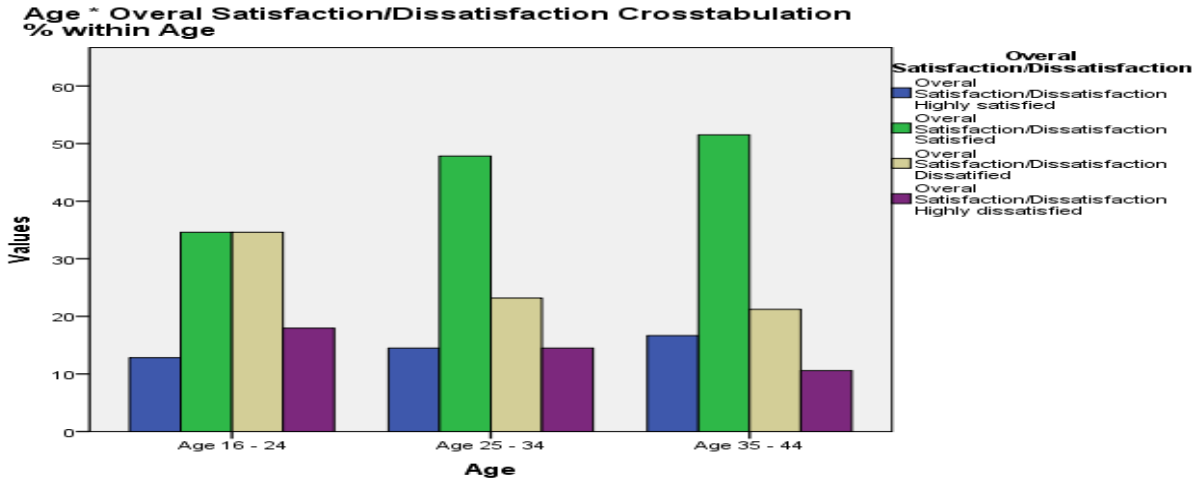

	Value	df	Asymp. Sig. (2-sided)
Pearson Chi-Square	7.204 <sup>a</sup>	6	.302
Likelihood Ratio	7.235	6	.300
Linear-by-Linear Association	4.471	1	.034
N of Valid Cases	213		

a. 0 cells (0.0%) have expected count less than 5. The minimum expected count is 9.61.

We think that age is not a factor in acceptability of online assessment because most of the University’s students are aged 44 or below. People in this age category have lived with modern information and communication technologies (ICTs) for most or all of their lives. They are therefore, likely to be tech-savvy. Additionally, the usage of ICTs in the country is quite high with mobile subscription and internet usage penetration rates of 106.81% and close to 60% respectively (Zambia Information and Communications Technology Authority, 2020).

**Table 8 Cross taulation between age group and effect on result/grades.**

**Age \* Change to online exam negatively affect grades/results Crosstabulation**

			Change to online exam negatively affect grades/results					Total
			Significantly	Highly	Moderately	Minimally	None	
Age	16 - 24	Count	8	13	20	20	17	78
		Expected Count	10.6	17.6	20.5	15.4	13.9	78.0
		% within Age	10.3%	16.7%	25.6%	25.6%	21.8%	100.0%
	25 - 34	Count	9	18	18	13	11	69
		Expected Count	9.4	15.5	18.1	13.6	12.3	69.0
		% within Age	13.0%	26.1%	26.1%	18.8%	15.9%	100.0%
	35 - 44	Count	12	17	18	9	10	66
		Expected Count	9.0	14.9	17.4	13.0	11.8	66.0
		% within Age	18.2%	25.8%	27.3%	13.6%	15.2%	100.0%
Total		Count	29	48	56	42	38	213
		Expected Count	29.0	48.0	56.0	42.0	38.0	213.0
		% within Age	13.6%	22.5%	26.3%	19.7%	17.8%	100.0%

**Chi-Square Tests**

	Value	df	Asymp. Sig. (2-sided)
Pearson Chi-Square	7.337 <sup>a</sup>	8	.501
Likelihood Ratio	7.393	8	.495
Linear-by-Linear Association	5.462	1	.019
N of Valid Cases	213		

a. 0 cells (0.0%) have expected count less than 5. The minimum expected count is 8.99.

**4.5 PROGRAMME LEVEL AND ONLINE ASSESSMENT**

We further analysed whether the level of study, i.e. postgraduate or undergraduate, had any significant influence on acceptability of online assessments. Accordingly, we firstly ran a cross tabulation between programme level and sufficient writing time during the online assessment. The findings are shown in Table 9 below.

**Table 9 Cross tabulation between programme level enough time allocation****Programme Level \* Enough time allocation for the exam Crosstabulation**

			Enough time allocation for the exam					Total
			Always	Most of the time	Often	Rarely	Never	
Programme Level	Undergraduate	Count	36	25	23	35	60	179
		Expected Count	42.7	26.3	24.6	33.7	51.7	179.0
		% within Programme Level	20.1%	14.0%	12.8%	19.6%	33.5%	100.0%
		% of Total	16.5%	11.5%	10.6%	16.1%	27.5%	82.1%
	Postgraduate	Count	16	7	7	6	3	39
		Expected Count	9.3	5.7	5.4	7.3	11.3	39.0
		% within Programme Level	41.0%	17.9%	17.9%	15.4%	7.7%	100.0%
		% of Total	7.3%	3.2%	3.2%	2.8%	1.4%	17.9%
Total		Count	52	32	30	41	63	218
		Expected Count	52.0	32.0	30.0	41.0	63.0	218.0
		% within Programme Level	23.9%	14.7%	13.8%	18.8%	28.9%	100.0%
		% of Total	23.9%	14.7%	13.8%	18.8%	28.9%	100.0%

**Chi-Square Tests**

	Value	df	Asymp. Sig. (2-sided)
Pearson Chi-Square	14.510 <sup>a</sup>	4	.006
Likelihood Ratio	16.128	4	.003
Linear-by-Linear Association	13.579	1	.000
N of Valid Cases	218		

a. 0 cells (0.0%) have expected count less than 5. The minimum expected count is 5.37.

We note that majority of the undergraduate students (53%) did not have enough time to attempt the final examinations. On the other hand, 59% of the postgraduate students had enough time to attempt the examinations at least most of the time. This indicates that postgraduate students had better experiences with the online assessment compared to their undergraduate counterparts. The Pearson chi-square value of 0.006, which is less than 0.05, buttresses this conclusion.

Secondly, we carried out an ANOVA to ascertain whether there was any significant difference in the means of undergraduate and postgraduate students with regard to their overall satisfaction/dissatisfaction with online assessment. The results are shown in Table 10 below.

**Table 10 ANOVA table of Programme level and Overall satisfaction**

**Descriptives**

Overall Satisfaction/Dissatisfaction

	N	Mean	Std. Deviation	Std. Error	95% Confidence Interval for Mean		Minimum	Maximum
					Lower Bound	Upper Bound		
Undergraduate	179	2.48	.938	.070	2.34	2.62	1	4
Postgraduate	39	2.15	.745	.119	1.91	2.40	1	4
Total	218	2.42	.914	.062	2.30	2.54	1	4

**ANOVA**

Overall Satisfaction/Dissatisfaction

	Sum of Squares	df	Mean Square	F	Sig.
Between Groups	3.416	1	3.416	4.151	.043
Within Groups	177.758	216	.823		
Total	181.174	217			

The mean for the undergraduate students was 2.48, which was different from that for postgraduate students at 2.15. Given that the significance value of 0.043 from the ANOVA output was less than 0.05, we conclude that there is a significant difference in the group means.

This implies that the overall level of satisfaction/dissatisfaction with online assessment was significantly different between postgraduate and undergraduate students.

We attribute our study's findings to the fact that postgraduate students, most of whom are in gainful employment or running their own businesses, have more resources and greater access to the internet than undergraduate students; and can therefore, easily adopt online education, including online assessments. Many studies on acceptability of online education have concluded that postgraduate students are more amenable to online education than undergraduate students (Gautam and Gautam, 2021; Kayombo and Mwiinga, 2021; Chung, Subramaniam and Dass, 2020b).

#### 4.6 FACTORS THAT INFLUENCE EFFECTIVENESS OF ONLINE ASSESSMENT

In the study, we also set out to establish the factors that impacted online assessments. Our results are presented in Figure 4 below.

We note that majority of the respondents' online examinations were always or most of the times adversely affected by typing speed, electricity load shedding, internet speed and cost of data bundles. Our findings in this regard are not surprising because these factors have been found to adversely affect online education in general (Agormedah *et al.*, 2020; Kajiita, Nomngcoyiya and Kang'ethe, 2020; Motala and Menon, 2020; Kayombo and Mwiinga, 2021).

Figure 4 also shows that access to the internet and unavailability of platform/link rarely affected students' online assessment, while bad electronic gadgets never affected their online assessments.

**Figure 4 Factors affecting online Assessments**

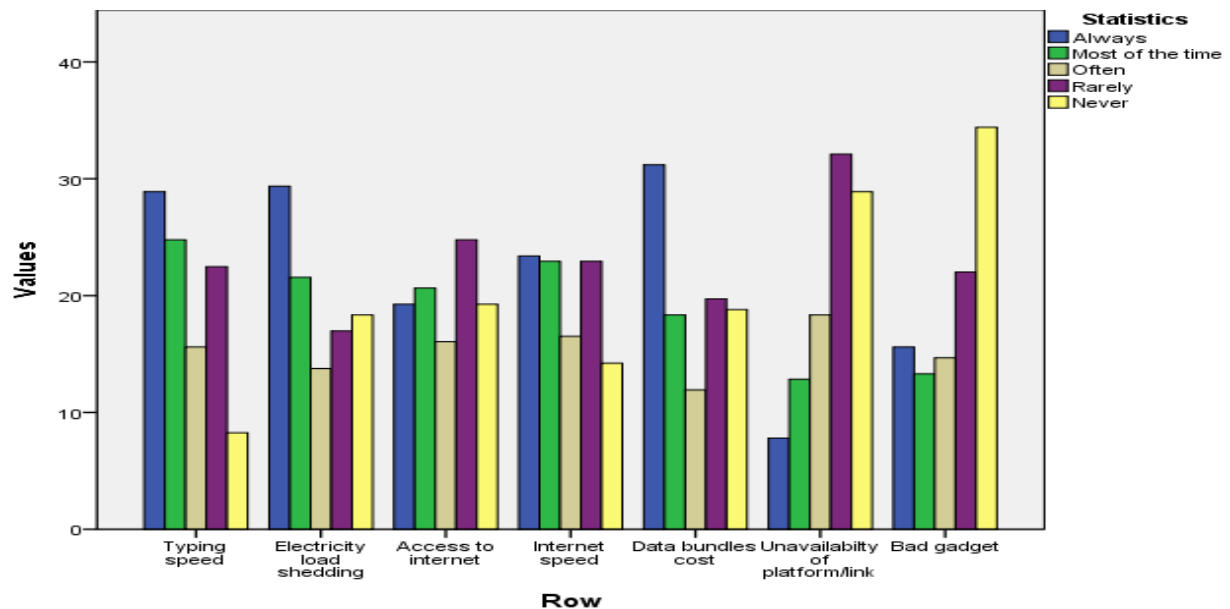

#### 4.7 OVERALL SATISFACTION WITH ONLINE ASSESSMENT

Lastly, the respondents were asked to rate their overall satisfaction/dissatisfaction with online assessment. The majority of students, i.e. 60%, were either satisfied or highly satisfied with the

online assessment as depicted in Figure 5 below. 40% were either highly dissatisfied or dissatisfied.

As shown in Figure 6 below, when the respondents were asked about the proportion of assessments they were willing to take online in future, only 27% indicated that they were not willing to take any of their future assessments via online platforms. The rest were willing to take all (33%), most (15%) or some (25%) of their future assessments online.

The findings in Figures 5 and 6 suggest that ZCAS University students were generally satisfied with online assessments. These findings are in accordance with the general view in the literature as evidenced in many studies (Bisht, Jasola and Bisht, 2020; Elzainy, El Sadik and Al Abdulmonem, 2020; Gonzalez *et al.*, 2020; Prigoff, Hunter and Nowygrod, 2020; Abdollahi *et al.*, 2021; García-Peñalvo *et al.*, 2021). The actual students' performance in the June 2020 examination session, which was similar to previous face-to-face sessions, seems to confirm that students' experiences with online assessments were positive.

**Figure 5 overall satisfaction/ Dissatisfaction of Online assessment**

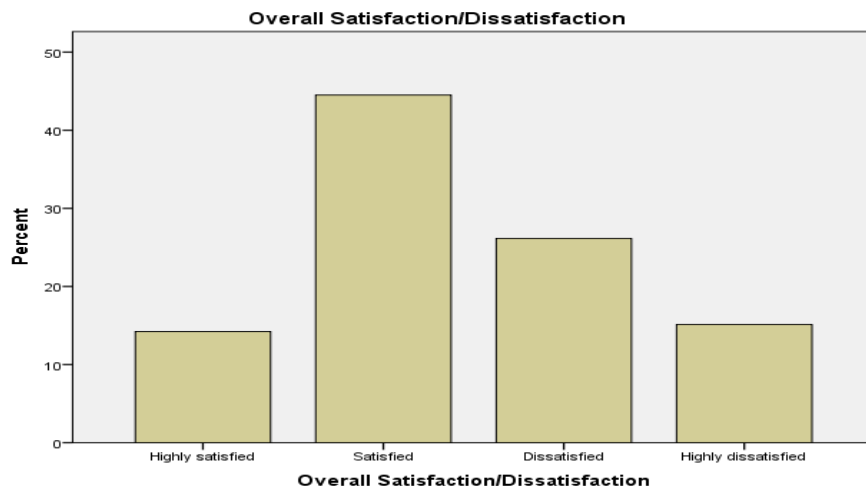

**Figure 6 Proportion of future online Assessment**

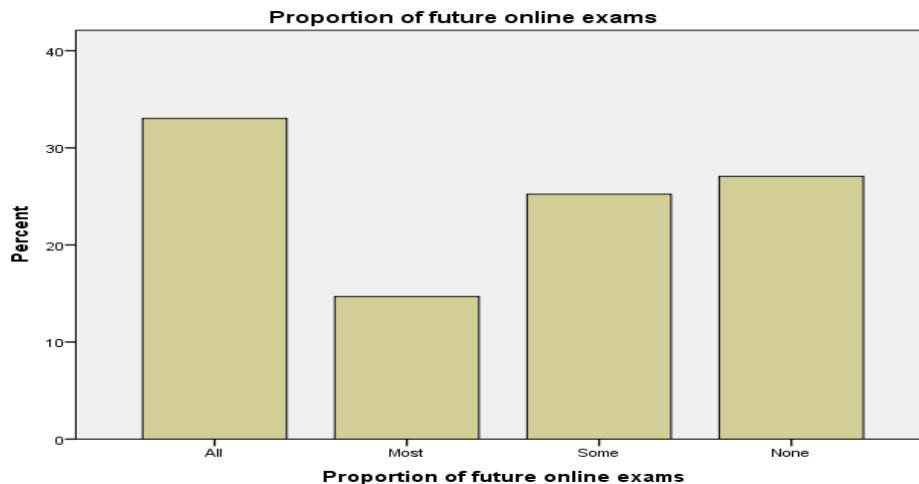

## 5. CONCLUSIONS AND RECOMMENDATIONS

### 5.1 CONCLUSIONS

This study endeavoured to explore the acceptability and challenges of online assessment at ZCAS University during the COVID-19 pandemic. The study assessed whether gender, age, programme level and mode of study had a significant impact on acceptability of online assessment. From the 218 respondents who participated in the online questionnaire, we were able to note that mode of study and programme level had a significance influence on acceptability of online assessments. Part-time, ODeL and postgraduate students were more inclined to online assessment than their full-time and undergraduate counterparts. However, gender and age did not seem to influence acceptability of online assessments.

The study went further to establish some of the common factors that influenced acceptability of online assessments. Typing speed, electricity load shedding, internet speed and cost of data bundles were some of the common factors that affected adoption of online assessments. However, even with the above impediments, the respondents were satisfied with online assessments overall.

### 5.2 RECOMMENDATIONS

Based on the findings and conclusions above, the following recommendations can be made with regards to online assessments:

- i. ZCAS University should consider introducing a dual assessment system whereby students are free to choose whether to take the examination in-person or online. Many full-time students who were not satisfied with the online assessment, for example, could choose in-person examinations, while part-time and ODeL students might opt for the online option. The system could be piloted during the mid-semester examinations in the second semester of 2021.
- ii. Although the University has entered into an agreement with one of the local internet service providers to zero-rate student access to the VLE, student uptake of this facility remains unknown. It is therefore, likely that many students are not benefiting from the reduced data cost that results from zero-rating access to the VLE. The University should carry out more sensitisation of the zero-rating facility to encourage student uptake.
- iii. Since typing speed adversely affected student experience with online assessment, the University should take steps to address this issue. For example, multiple choice and short answer questions that do not require a lot of typing could be introduced in future online assessments.

### REFERENCES

- Abdollahi, A. *et al.* (2021) 'Online Assessment for Pathology Residents during the COVID-19 Pandemic: Report of an Experience', *Iranian Journal of Pathology*, 16(1), pp. 75–78. doi: 10.30699/ijp.2020.129558.2425.
- Abdullah, F. and Ward, R. (2016) 'Developing a GETAMEL by analysing commonly used external factors.pdf', *Computers in Human Behavior*, 56, pp. 238–256. doi: 10.1016/j.chb.2015.11.036.



- Agormedah, E. K. *et al.* (2020) 'Online Learning in Higher Education during COVID-19 Pandemic: A case of Ghana', *Journal of Educational Technology and Online Learning*. doi: 10.31681/jetol.726441.
- Bisht, R. K., Jasola, S. and Bisht, I. P. (2020) 'Acceptability and challenges of online higher education in the era of COVID-19: a study of students' perspective', *Asian Education and Development Studies*. doi: 10.1108/AEDS-05-2020-0119.
- Chung, E., Subramaniam, G. and Dass, C. L. (2020b) 'Online Learning Readiness Among University Students in Malaysia Amidst Covid-19', *Asian Journal of University Education*, 16(2), p. 45. doi: 10.24191/ajue.v16i2.10294.
- Eaton, S. E. (2020) 'Academic Integrity During COVID-19: Reflections From the University of Calgary', *International Studies in Educational Administration (Commonwealth Council for Educational Administration & Management (CCEAM))*, 48(1), pp. 80–85.
- Edurole (2021) *EduRole Student Information System, School Report*. Available at: <https://sis.zcas.edu.zm/report/school?period=2020&mode=Both&term=2> (Accessed: 13 February 2021).
- Elzainy, A., El Sadik, A. and Al Abdulmonem, W. (2020) 'Experience of e-learning and online assessment during the COVID-19 pandemic at the College of Medicine, Qassim University', *Journal of Taibah University Medical Sciences*, 15(6), pp. 456–462. doi: 10.1016/j.jtumed.2020.09.005.
- García-Peñalvo, F. J. *et al.* (2021) 'Planning, Communication and Active Methodologies: Online Assessment of the Software Engineering Subject during the COVID-19 Crisis', *RIED. Revista Iberoamericana de Educación a Distancia*, 24(2), p. 19. doi: <http://doi.org/10.5944/ried.24.2.27689>.
- Gautam, D. K. and Gautam, P. K. (2021) 'Transition to online higher education during COVID-19 pandemic: turmoil and way forward to developing country of South Asia-Nepal', *Journal of Research in Innovative Teaching & Learning*, ahead-of-print(ahead-of-print). doi: 10.1108/JRIT-10-2020-0051.
- Gonzalez, T. *et al.* (2020) 'Influence of COVID-19 confinement on students' performance in higher education', *PLoS ONE*, 15(10). Available at: <https://doi.org/10.1371/journal.pone.0239490>.
- Guangul, F. M. *et al.* (2020) 'Challenges of remote assessment in higher education in the context of COVID-19 a case study of Middle East College.pdf', *Educational Assessment, Evaluation and Accountability*, 32, pp. 519–535.
- IndexMundi (2021) *Zambia Age structure - Demographics, Zambia Age structure*. Available at: [https://www.indexmundi.com/zambia/age\\_structure.html](https://www.indexmundi.com/zambia/age_structure.html) (Accessed: 26 March 2021).
- Kajiita, R. M., Nomngcoyiya, T. and Kang'ethe, S. M. (2020) 'The "revolution" on teaching and learning: Implications of COVID-19 on social work education in Institutions of Higher Learning in Africa | African Journal of Social Work', *African Journal of Social Work*, 10(3), pp. 25–33.

Kayombo, K. M. and Mwiinga, B. (2021) 'Acceptability and Challenges of Online Higher Education in the COVID-19 Era in Zambia', *ACADEMICIA An International Multidisciplinary Research Journal*, 11(2). Available at: <https://saarj.com>.

Kearns, L. R. (2012) 'Student Assessment in Online Learning: Challenges and Effective Practices', *Journal of Online Learning and Teaching*, 8(3), p. 11.

Ladyshevsky, R. K. (2015) 'Post-graduate student performance in "supervised in-class" vs. "unsupervised online" multiple choice tests: implications for cheating and test security', *Assessment & Evaluation in Higher Education*, 40(7), pp. 883–897. doi: 10.1080/02602938.2014.956683.

Motala, S. and Menon, K. (2020) 'In search of the "new normal": Reflections on teaching and learning during Covid-19 in a South African university', *Southern African Review of Education*, 26(1), pp. 80–99.

Prigoff, J., Hunter, M. and Nowygrod, R. (2020) 'Medical Student Assessment in the Time of COVID-19', *Journal of Surgical Education*, 78(2), pp. 370–374. doi: 10.1016/j.jsurg.2020.07.040.

Slamet, A., Amrullah, A. M. K. and Sutiah, A. R. (2021) 'Differences in the Experience of Lecturers and Students on Distance Learning In Higher Education in Indonesia: Case Study in the Pandemic of Covid-19', *Systematic Reviews in Pharmacy*, 12(1), p. 6.

White, A. (2020a) 'Amanda White on education for and detection of contract cheating in virus times | Campus Morning Mail'. Available at: <https://campusmorningmail.com.au/news/education-for-and-detection-of-contract-cheating-in-the-age-of-covid-19/> (Accessed: 20 March 2021).

White, A. (2020b) 'May you live in interesting times: a reflection on academic integrity and accounting assessment during COVID19 and online learning', *Accounting Research Journal*, ahead-of-print(ahead-of-print). doi: 10.1108/ARJ-09-2020-0317.

Wu, D. T. *et al.* (2020) 'The impact of COVID-19 on dental education in North America—Where do we go next?', *European Journal of Dental Education*, 24(4), pp. 825–827. doi: 10.1111/eje.12561.

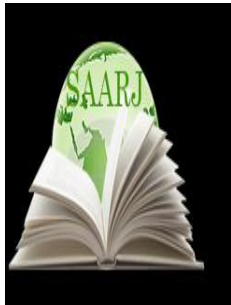

**ACADEMICIA**  
**An International  
Multidisciplinary  
Research Journal**  
(Double Blind Refereed & Peer Reviewed Journal)

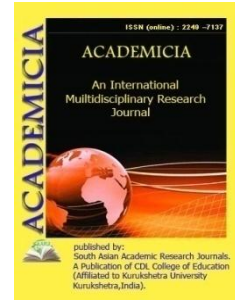

DOI: **10.5958/2249-7137.2021.01088.0**

## INTERACTIVE METHODS OF TEACHING MATHEMATICS IN PRIMARY EDUCATION

**Laziza Gaybullaevna Rasulova\***

\*Lecturer,  
Bukhara State University Bukhara,  
UZBEKISTAN

### ABSTRACT

*The article is devoted to the issues of interactive teaching of primary schoolchildren. The subject of the research is interactive methods for use in mathematics lessons in elementary school. You need to start by gradually using these methods. Both the teacher and the students need to get used to them and gain some experience in using them. It is better to carefully prepare a few interactive activities in the school year than to run often hastily prepared "games". During this process, all participants in the educational process interact with each other, exchange information, jointly solve problems, model situations, evaluate their own behavior and the actions of others.*

**KEYWORDS:** *Primary Education, Mathematics, Interactive Learning, Interactive Methods, Primary School Age.*

### INTRODUCTION

With the introduction of new educational standards in Uzbekistan, the ability to build a teaching technology becomes necessary for every primary school teacher. In accordance with the requirements of the standards, the educational process is organized by the teacher, taking into account the characteristics of the students. In this regard, the teacher must know the technique of constructing the learning process for younger students, including the use of interactive means.

Analysis of scientific literature shows that the use of interactive tools requires compliance with certain approaches described by many scientists of various profiles (philosophers, psychologists, didactics, methodologists).

However, despite the fact that the educational standard directly indicates the need for the active use of interactive tools for solving cognitive problems, there are still no developments in the

practical application of interactive tools for teaching mathematics to junior schoolchildren. In this regard, the question of finding ways to use new technologies for teaching mathematics is currently relevant.

During the years of independence, the system of education and upbringing has been radically reformed in our country, all organizational and legal conditions have been created for the comprehensive education of the younger generation. The Law of the Republic of Uzbekistan - On Education and on the National Program for Personnel Training contributes to increasing efficiency, reaching new heights. Consequently, in accordance with them, educational institutions were updated in accordance with the requirements of the time, educational institutions equipped with modern equipment were created, and most importantly, a system of training and retraining of qualified pedagogical personnel was created. All this is incredibly important from the point of view of a happy future of the younger generation, focused on ensuring that it grows no worse than anyone else.

### **The Main Findings and Results**

Especially over the past 20 years, the teaching of mathematics in our country, especially in secondary school, has undergone tremendous changes, especially in the primary education system. This is evidenced, in particular, by the publication of the law on elections and other decrees after the independence of our republic. Setting fundamentally new goals for the school leads to a radical change in the content of teaching mathematics. Mathematics makes significant changes both in the content of the initial course and in the methodology of teaching it in textbooks and manuals. When entering school, a 6-7-year-old child has a minimum of knowledge and skills in organizing his activities at school hours. This problem has become relevant in modern primary schools. Interactive teaching methods require a certain change in the life of the class, as well as a lot of time for preparation, both from the student and from the teacher. You need to start by gradually using these methods. Both the teacher and the students need to get used to them and gain some experience in using them. It is better to carefully prepare a few interactive activities in the school year than to run often hastily prepared "games". Using interactive methods is not an end in itself. It is only a means to achieve the atmosphere in the classroom that best contributes to the understanding of the spirit of the law and civil society as a spirit of cooperation, mutual understanding, goodwill. Thus, the knowledge gained by the student is at the same time a tool for self-acquisition.

According to RN Buneev, "the school has lost its monopoly on the provision of knowledge. Much of the information today is acquired from "external" sources. But school education should take on an equally important function: to teach activities with the subject material, to stimulate the development of the child by means of the subject, and in general to create a basis (platform) for students in the learning process for the systematic development of subject material, which will further allow expanding and replenish your subject knowledge. Each subject has a different developmental potential (compare, for example, mathematics and literature) and, of course, involves specific ways of studying. But there are several strategic provisions that are common to subject learning.

Acquaintance with basic information on the subject and with key concepts (creating a picture of the subject) - all this is necessary as an indicative basis for organizing activities on the material of the subject.

Training in various operations with subject material.

Formation of universal educational actions on the subject material.

Formation of subject competencies (for example, teaching counting, solving problems in the study of mathematics, etc.). Acquaintance with active and passive vocabulary (terms) characteristic of this subject, and mastering them in speech situations.

Mastering reading texts on this subject, listening techniques, speaking and composing your own texts using lexical means and structures characteristic of this subject "

The most important task of the modern education system as indicated

The law on education is "the formation of universal educational actions that provide students with the ability to learn, the ability to self-development and self-improvement."

As part of the main types of universal educational activities, set by the key goals of general education, four blocks can be distinguished:

- personal;
- regulatory (including also self-regulation actions);
- informative; communicative".
- Regulatory actions provide students with the organization of their learning activities.

**These include:**

- goal-setting as a formulation of an educational task based on the correlation of what is already known and assimilated by students and what is still unknown;
- planning - determining the sequence of intermediate goals, taking into account the final result; drawing up a plan and sequence of actions;
- forecasting - anticipating the result and the level of assimilation of knowledge, its temporal characteristics;
- control in the form of comparing the method of action and its result with a given standard in order to detect deviations and differences from the standard;
- correction - making the necessary additions and adjustments to the plan and method of action in the event of a discrepancy between the standard, the actual action, and its result; - assessment - the allocation and awareness by students of what has already been mastered and what else needs to be learned, awareness of the quality and level of assimilation;
- self-regulation as the ability to mobilize strength and energy, to volitional effort (to make a choice in a situation of motivational conflict), and to overcome obstacles.
- Cognitive universal actions include general educational, logical, as well as posing and solving a problem.

**General educational universal actions:**

- - self-selection and formulation of a cognitive goal;

- -Search and selection of the necessary information; application of information retrieval methods, including with the help of computer tools;
- -structuring knowledge;
- -conscious and arbitrary construction of a speech utterance in oral and written form;
- -selection of the most effective ways to solve problems, depending on specific conditions;
- -reflection of methods and conditions of auction, control, and evaluation of the process and performance results; - statement and formulation of the problem, independent creation of algorithms of activity in solving problems of a creative and exploratory nature.

**The main methods of interactive learning in primary school are:**

1. Creative task - it forms the basis and content of any interactive method, and also gives meaning to learning, motivates students;
2. Work in small groups - this gives an opportunity to practice the skills of cooperation, interpersonal communication, to participate collectively in the work;
3. Brainstorming - this method activates creative thinking in a group. In brainstorming, any student's answer to a question is accepted;
4. The "carousel" method consists in the fact that it is necessary to form two rings: external and internal. In the first case, students change places after a certain period of time, and in the second case, these are students sitting motionless;
5. Decision tree method - the class is divided into 3 or 4 groups with the same number of students. Then each group should discuss the issue and make notes on their "tree", then the groups change places and add their ideas on the trees of neighbors;
6. Method "mosaic" - the necessary material is divided into parts, to work with it, students are united in small groups. Each student in the group reads their piece of material, becoming an expert in its content and preparing to teach this content to others;
7. Method "aquarium" - for observation and analysis, the teacher distributes the roles of observers, critics, experts, and analysts among the students, but the remaining students act out the situation in a circle;
8. Method "puzzles" - a material or concept is divided into separate puzzles, which are put together piece by piece into one common picture. The teacher's task may vary depending on the goals and objectives set within the lesson. Students can assemble the final picture themselves, guess the coded answer or compose a story, build a logical chain, explain why the details of the picture were formed in this order, etc.

From my own experience, I can say that there are a large number of methods and they are all diverse, but each teacher should choose those methods that will be most appropriate and interesting for use in their class.

**Communicative actions include:**

Planning an educational collaboration with teacher and peers;

- Determination of the goal, functions of the participants, methods of interaction; - posing questions;
- Proactive cooperation in the search and collection of information;
- Resolution of conflicts - identification, identification of the problem, search and assessment of alternative ways to resolve the conflict, decision making, and its implementation;
- Management of the partner's behavior - control, correction, assessment of his actions;
- the ability to express their thoughts with sufficient completeness and accuracy in accordance with the tasks and conditions of communication; possession of monologue and dialogical forms of speech in accordance with the grammatical and syntactic norms of the native language.

**We can highlight the features of the formation of universal educational actions at primary school age:**

- 1) The younger student becomes the subject of educational activity, that is, the formation of universal educational actions ensures continuity in the transition from preschool to primary general education;
- 2) the formation of motivation for learning, the internal position of a younger student, since this age is sensitive for the development of stable cognitive needs and interests, it is necessary to ensure the student's conscious entry into the space of educational activity;
- 3) The level of physical readiness, manifested in the formation of basic skills and qualities used in any subject area, the ability to perform subtle movements appears, to master the skill of writing;
- 4) the level of psychological readiness is determined by the formation of arbitrariness and awareness in the management of perception, attention, memory, activity takes on an organized character, an important ability to express one's thoughts orally and in writing is acquired, thinking develops from emotionally figurative to abstract logical;
- 5) The formation of social and moral qualities, the elements of social feelings develop in the younger schoolchild, the skills of social behavior are formed (collectivism, responsibility for actions, mutual assistance, etc.) and the foundations of moral behavior are laid;
- 6) The assimilation of cognitive actions manifests itself in the formation of mechanisms for the transformation of educational material and its independent application in changed conditions and in the implementation of control;
- 7) The level of communicative actions, is considered in the formation of the relationship of a younger student with others, it is included in the whole system of collectives (all-school, classroom).

The development of universal educational actions ensures the formation of psychological neoplasms and abilities of the student, which in turn determine the conditions for high success in educational activities and the development of subject disciplines. Interactive teaching methods allow you to develop students, critical thinking, creativity, communication skills, and abilities, to establish emotional contacts between students, to provide educational tasks, as a result of which creative self-development of students occurs. The use of interactive teaching methods in

mathematics lessons in primary school makes it possible to conduct lessons at a high aesthetic and emotional level, to provide positive motivation for students' learning and a high degree of differentiation of learning. Also, significantly increase the efficiency and volume of work performed in the classroom.

Practice shows that interactive methods involve learning in collaboration, that is, students and the teacher are subjects of learning. During this process, all participants in the educational process interact with each other, exchange information, jointly solve problems, model situations, evaluate their own behavior and the actions of others. Students are immersed in a real atmosphere of business cooperation in solving problems, thus the lessons will be very exciting and informative.

As a result of our research, we came to the following conclusions. The analysis of psychological and pedagogical literature made it possible to consider the concept of interactive learning - this is a process of cognition, where knowledge is obtained in joint activities through dialogue, a polylogue of students between themselves and the teacher.

We have revealed the essence of interactive learning, which is that the interaction of a teacher and a student is understood as direct interpersonal communication. The most important feature of such communication is the ability of a person to "take on the role of another", to imagine how the communication partner (or group) will perceive this role, and to interpret the situation and construct their actions accordingly.

## REFERENCES

1. Gaybullaevna, R. L. (2021). Information technology in primary school. *ACADEMICIA: AN INTERNATIONAL MULTIDISCIPLINARY RESEARCH JOURNAL*, 11(1), 1498-1503.
2. Rasulova, L. G. (2021). Formation Of Abilities And Skills In Measuring Activity In Preschoolers. *The American Journal of Social Science and Education Innovations*, 3(02), 363-369.
3. Расулова Л. Г., Саидмуродова А. К. МЕТОДИКА ПОДГОТОВКИ ВОСПИТАТЕЛЕЙ К ОБУЧЕНИЮ МАТЕМАТИКЕ НА ОСНОВЕ КОМПЕТЕНТНОСТНОГО ПОДХОДА В ДОШКОЛЬНОМ ОБРАЗОВАНИИ //Academy. – 2020. – №. 12 (63).
4. Rasulova LG Formation and development of logical thinking in preschool children through mathematical development // Problems of pedagogy. - 2020. - No. 1 (46).
5. Расулова Л. Г., Расулова А. Г. ФОРМИРОВАНИЕ ЗНАНИЙ О ГЕОМЕТРИЧЕСКИХ ФИГУРАХ //Academy. – 2020. – №. 5 (56).
6. Расулова Л. Г., Холмуродов М. З. ОСНОВНЫЕ ПРОБЛЕМЫ ПРОГНОЗИРОВАНИЯ В УСЛОВИЯХ РЫНОЧНОЙ ЭКОНОМИКИ //ББК 65.0501 С 56. – 2019. – С. 340.
7. Turdieva M. J., Olimov K. T. Game Technologies As An Innovative Type Of Student-Centered Education //The American Journal of Social Science and Education Innovations. – 2021. – Т. 3. – №. 02. – С. 183-187.
8. Олимов К., Турдиева М. Maktabgacha ta'lim va tarbiya jarayonini amalga oshirishda innovatsion yondashuv va "ilk qadam" davlat o'quv dasturi //Общество и инновации. – 2021. – Т. 2. – №. 2/S. – С. 419-423.



9. Juraqulovna, Turdiyeva Mohira. "TYPES OF PERSON-CENTERED TECHNOLOGY IN THE EDUCATIONAL PROCESS." *E-Conference Globe*. Vol. 3. No. 1. 2021.
10. Gafurova D. H. Development Of Skills And Abilities Of Speech Communication Of Students // *International Engineering Journal For Research & Development*. - 2020. - Т. 5. - No. 4. - S. 4-4.
11. Temirovna O. L., Chorievna R. L. Methodology to organize independent work of students in mathematics lessons in primary school // *ACADEMICIAN: An International Multidisciplinary Research Journal*. - 2020. - Т. 10. - No. 10. - S. 387-393.
12. Рахмонова, Гуллола Шавкатовна, and Азиза Файзулло Кизи Чоршамова. "Значимые стороны национальных игр в процессе воспитания дошкольников." *Проблемы педагогики* 1 (46) (2020).
13. Рахмонова, Г. Ш., & Чоршамова, А. Ф. К. (2020). Значимые стороны национальных игр в процессе воспитания дошкольников. *Проблемы педагогики*, (1 (46)).
14. Gaybullaevna, R. L. (2021). Information technology in primary school. *ACADEMICIA: AN INTERNATIONAL MULTIDISCIPLINARY RESEARCH JOURNAL*, 11(1), 1498-1503.
15. Rasulova, L. G. (2021). Formation Of Abilities And Skills In Measuring Activity In Preschoolers. *The American Journal of Social Science and Education Innovations*, 3(02), 363-369.
16. Расулова, Л. Г. (2020). ФОРМИРОВАНИЕ И РАЗВИТИЕ ЛОГИЧЕСКОГО МЫШЛЕНИЯ ДЕТЕЙ ДОШКОЛЬНОГО ВОЗРАСТА ПОСРЕДСТВОМ МАТЕМАТИЧЕСКОГО РАЗВИТИЯ. *Проблемы педагогики*, (1), 57-59.
17. Расулова, Л. Г., & Саидмурадова, А. К. МЕТОДИКА ПОДГОТОВКИ ВОСПИТАТЕЛЕЙ К ОБУЧЕНИЮ МАТЕМАТИКЕ НА ОСНОВЕ КОМПЕТЕНТНОСТНОГО ПОДХОДА В ДОШКОЛЬНОМ ОБРАЗОВАНИИ.

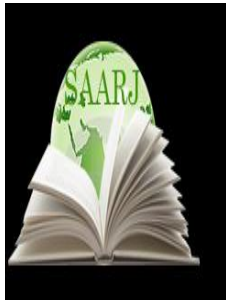

**ACADEMICIA**  
**An International  
 Multidisciplinary  
 Research Journal**  
 (Double Blind Refereed & Peer Reviewed Journal)

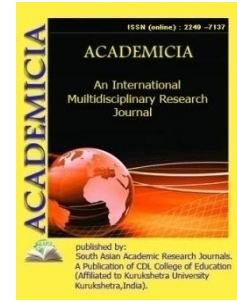

**DOI: 10.5958/2249-7137.2021.01063.6**

## REVIEWS OF EFFECTIVE USE OF EDUCATIONAL METHODS IN TEACHING LATIN AND MEDICAL TERMINOLOGY

**Makhmudov Zafar Mardanovich\***; **Sharipov Bobur Salimoviche\*\***;  
**Buriyev Dilmurod Arzimurodoviche\*\*\***

<sup>1,3</sup>Teachers of Samarkand State Medical Institute,  
 UZBEKISTAN

Email id: maxmudovzafar4510@gmail.com

Email id: sharipovbobur9689@gmail.com

Email id: buriyev.dilmurod@mail.ru

### ABSTRACT

*The article discusses the results of the effective use of modern teaching methods in teaching students Latin and medical terminology. Efforts were also made to provide more detailed information on teaching methods.*

**KEYWORDS:** *Teaching, Method, Teaching, Interactive, Brainstorming, "Wheel", Student, Effective, Role Play, Independent Learning, Learning.*

### INTRODUCTION

Teaching methods and their types. The purpose of the training is to provide students with the knowledge and skills set out in the state education standards. Teaching can only be considered successful if it is accepted and understood by the student, or if the student is able to demonstrate the tasks designed to improve the skills in practice.

It is known that the process of learning (information acquisition) is a process of systematic development of spiritual and mental abilities, the formation of knowledge and concepts, and the formation of the ability to use the acquired knowledge. This process can be done by the learner or with the help of another educator. The learning process is based on different methods.

Method is derived from the Greek word *methodos*, which means a way of research or knowledge, theory, doctrine.

Teaching method (method) can be defined as a systematic and regulated approach to the organization of purposeful, joint activities of the learner and the teacher.

The education model can be thought of as a structure for the implementation of the learning process using one or more teaching methods.

A teaching method is a systematic approach to the purposeful, organized interaction of a learner and a teacher.

### **MATERIALS AND METHODS**

Teaching methods can be divided into the following groups according to the characteristics of the organization of joint activities of students and teachers to achieve educational goals:

Teacher-centered styles;

Student-centered (interactive or interactive) styles.

Typically, one or more of these methods is used alone in some teaching models. Typically, the teaching process consists of two or more basic methods, which are fully relevant to the topic of the lesson and are applied depending on the level of knowledge and experience of the students.

Teacher-centered style. In this way, the teacher looks for ways to transmit the knowledge and skills he has acquired through the senses of the students. In this case, the participation of students is passive, that is, they listen, observe and write lectures.

These methods are mainly implemented through the following types of teacher activities:

Oral teaching method (speech, story) One of the simplest ways of communication between people - oral speech - is an oral description or verbal expression of the main content. This method is the most formal method of teaching, which is carried out entirely through "speaking". It lasts 40 minutes or more and usually leaves no room for student participation. It basically uses the student's hearing.

How to use descriptive expressions (illustration). Students will be able to use visual aids to illustrate the knowledge or skills that need to be conveyed through this activity. The information that is to be conveyed to the students is conveyed through descriptions and various symbols. Such visual expressions are made using the following tools: board, special white board, flipchart, video image, video projector, overhead projector, computer graphics, magnetic board, pictures, drawings, color pictures, diagrams and tables, diagrams, sample and special transparent paper 'other images.

Demonstration method. The teacher can demonstrate the use of a particular tool or equipment or the actions associated with the task as an example. One-on-one demonstrations encourage students to use their eyesight.

Student-centered (interactive or interactive) methods. When these methods are used, the teacher encourages the student to actively participate. The benefits of a student-centered approach include:

- More effective learning;
- High motivation of the student;
- Taking into account previously acquired knowledge;
- Adapting the intensity of reading to the needs of the student.

- Support for student initiative and responsibility;
- Practical study;
- Creation of conditions for bilateral discussions;
- maintaining a healthy learning environment;
- The teacher becomes a facilitator.

The student participates throughout the process. As a result, there will be sufficient student participation and practice to develop students' knowledge and skills.

These methods are mainly implemented through various forms of teacher activity. Here are some of them:

### **Question-based teaching method**

The teacher puts the questions in front of the students and encourages them to repeat the given information. This will ensure that they understand the verbal and other communication methods used by the teacher.

### **Discussion method**

Students will be invited to talk, clarify issues, ask questions, and analyze the information through discussion with the teacher.

### **Conversation method**

It is important to explain the topic in the context of the source material and as part of the lesson. Normally, the lecture time should not exceed 30 minutes, and the main time should be given to the teacher during the lecture and at the end of the lesson to ask questions.

The method of discussion in groups. This method of teaching allows the teacher to "talk" very little, and most of the time is devoted to student discussions. It is advisable to use this method when students have some knowledge of the topic. They may even have no idea about the topic, or they may use it to review what they learned at the beginning of the lesson.

How to learn by discovering something new. This approach not only allows students to apply the theoretical knowledge they have acquired, but also allows them to accumulate knowledge and skills through self-motivation.

The basic principles are as follows:

The purpose of the study is to determine the purpose in advance.

The learning process should be focused on a specific task.

The assignment provides:

Basis for basic information

Focus on a question that encourages the reader to delve deeper into information that is unfamiliar to them

Results based on pre-determined and healthy research.

Success is based on activity-achievement motivation.

Group collaboration: encourages thought and action calls for observation provides two-way feedback within the group.

Depending on the needs of the individual or group, the amount of time a teacher can contribute is limited.

The teacher is primarily responsible for facilitating the learning process and providing two-way feedback. Rarely does a teacher provide information.

Practical training. A teacher can use this method if he or she wants to teach a group of students through hands-on activities that shape their skills in whole or in part. Typically, this process can include speaking, visual expression, and teacher demonstrations and discussions. However, this process is carried out in workshops where materials and special equipment are available.

It is also important to keep in mind that students learn not only through formal learning, that is, through books, newspapers and magazines, television, the Internet, and classmates, but also through more direct contact. These tools can be used to reinforce the teacher's previous lesson.

The following methods and techniques can also be used to achieve high efficiency in the teaching process:

#### **Debate method**

The study group is divided into two groups, and discussions on a topic are held in the form of an exchange of views.

#### **Research method**

The highest level of mastery; conduct individual or collaborative research on a small problem that students have not yet explored based on their knowledge; verify the accuracy of the hypothesis on the basis of the evidence sought; Stages: to put a problem or issue of interest to everyone in the lesson, to study it, to collect data for research, to make assumptions, predictions about the solution of the problem and to determine how accurate they are. data-based analysis and inference; Students independently complete some research on a scientific basis, write it down, and analyze the goals and outcomes.

#### **Role-playing games**

Business or role-playing games are a type of challenging task. Only here, instead of textual material, is a real-life situation in which students play roles. Stages: explain the situation, assign appropriate roles, explain goals and objectives; monitor student behavior during play; enabling students to acquire knowledge, skills and competencies through their actions; game results analysis; compare game results with real-life events;

#### **Project method**

This method implements a comprehensive approach to education that involves knowledge and skills, analysis and evaluation. In the project method, students are more involved in planning, organizing, reviewing, analyzing, and evaluating the results of the work done. Students design some small project work, diploma and course projects, graduation theses on a scientific basis, perform them independently, write them, make presentations, analyze the goals and results.

Independent study method. This method is aimed at the ability of students to independently master the material, self-examination skills, to fully and consciously describe the content of the given text. This method is conducted from time to time, developing students' skills of independent study, textbook work and independent practical activities. Each student completes an individual or group assignment. The teacher directs and supervises the students through external feedback without interfering with their practical activities.

Mental attack. A way of summarizing and sorting ideas to solve a problem or answer a question related to a lesson topic. participants work together to solve an unsolved problem or find an answer to a question. They come up with their own ideas for the best solution. Stages: creating a problematic situation; engaging students to find solutions; hearing presentations of various solutions; comparison and selection of solutions; conclusion;

Pinboard method. This method is a form of brainstorming, in which ideas for solving a problem are written on separate pieces of paper and nailed to the board. In the second stage, they are divided into classes according to various criteria, sorted and placed on the board in a certain order.

How to learn by teaching others. In this way, learners share information with each other on a given topic or problem and share what they know with others.

Dictionary dictation is the current form of knowledge assessment; usually short-lived; is conducted to check students' knowledge of the terms and concepts covered;

Conference. It is a form of midterm examination, usually in the form of an oral presentation of independently written work on a specific topic for a quarter or year.

Pair communication. Encourage students to sit side by side on a topic; exchange ideas and listen to some of them;

Voting method. Cite a contentious situation during the lesson; to put the opinions of the disputing parties to a vote in the classroom in order to manage the dispute; identify dissent, consent, and neutrality on each point of view; hearing the arguments and opinions of the parties; then vote again; summary

"Wheel" method. This method is an improved version of the method of working in groups, with the help of which students can independently acquire certain knowledge on the material studied, the ability to work in a team, to teach others, to inform will have the ability to share and make decisions as a team.

## **CONCLUSION**

The Samarkand State Medical Institute carries out systematic work on the wide and effective use of the above methods in the teaching of Latin and medical terminology, as well as the enrichment of students' knowledge.

Through the use of modern teaching methods, teachers are implementing plans such as, firstly, to increase the effectiveness of education, secondly, to improve the level of knowledge of students, and thirdly, to increase students' interest in their chosen profession.

Students learn to memorize Latin dictionaries, reinforce the topic by using memorized terms in practical exercises, learn grammar knowledge and skills by teaching others, work with

vocabulary, pair communication, voice He puts into practice modern teaching methods such as the method of putting, "Wheel" method, debate method, Brainstorming, Research method, role-playing games, independent learning method. This is how 70-90% of Latin lessons are organized.

The use of modern teaching methods and the use of student-centered methods in the classroom will help to increase the level of knowledge of students. Through interactive methods, students can apply their knowledge in other disciplines. This is the highest duty of a teacher.

#### REFERENCES

1. Razikova L.T, Ziyadullayev H .: Improving the content of education is a requirement of the time, Methodical manual, Samarkand, "Dawn" 2015.
2. Rakhimov M.R, Khaydarov U.H: The use of modern teaching methods in medical colleges, Methodical manual, Samarkand, "Sogdiana press" 2007.
3. Latin language and the basics of medical terminology. Chernyavsky M.N., Tverkovkina E.P., Minsk "Higher School", 2018.
4. Dictionary of medical terminology. I.F. Erofeeva, A.L. Zalkinda, G.V. Casière. State Medical Publishing House, Kiev, 2018
5. Moscow "Medicine" 1998 Latin language and foundations of medical terminology, edited by Yu.F. Shulyts.
6. Latin language and foundations of medical terminology. Under the general editorship of M.N. Chernyavsky. Moscow "Shkola" 2007.

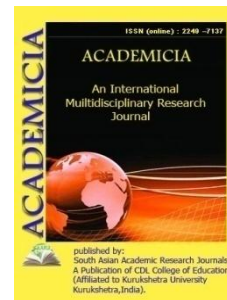
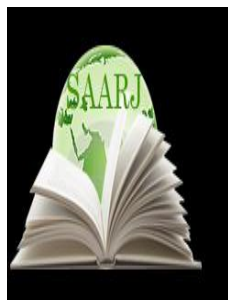

DOI: **10.5958/2249-7137.2021.01064.8**

## RESEARCH POLYMER COATINGS MATERIAL PROPERTIES AND APPLICATION FEATURES

**Makhammadjanov Khusanboy Alisherogli\***

Base Doctoral Student,  
Andijan Machine-Building Institute,  
UZBEKISTAN  
Email id: xusan7797@mail.ru

### ABSTRACT

*This article describes the coating processes on the working surfaces of many parts from different polymeric materials. Obtaining coatings from polymers is superior to other coatings in terms of quality, efficiency and low cost. coatings made of polymer composite materials in order to protect working surfaces from corrosion and increase the durability of service parts made of metals. They are quite resistant to chemicals, so it will not be possible to remove the polymer layer with a solvent. The coating can only be removed with a special tool. Pural is not as resistant to plastic deformation as plastisol, and is more expensive than polyester, but in terms of price-quality ratio, it is the best option from all of the above. Pural coatings are most widely used in the production of galvanized metal roofing elements.*

**KEYWORDS:** *Polymer, Polyester, Plastisol, Pural, Coating, Anti-Friction, Material.*

### INTRODUCTION

Polymer coatings are used to protect metal parts from corrosion and give them a decorative appearance. Antifriction coatings are a special type of polymer materials, which not only prevent wear of parts, but also serve as a lubricant. Polymer coatings are intended for the treatment of metal surfaces in order to protect against corrosion and give a decorative appearance. Polyester, polyvinylidene fluoride (PVDF), plastisol, pural, etc. can be used as a polymer coating. Let's consider these materials, their areas of application and application technologies in more detail.

### Methods and objects of research

**Polyester.** Polyester (polyester) is the most popular polymer used as a coating. It is characterized by high resistance to UV radiation, excellent anti-corrosion properties, elasticity (easy to form).



Figure 1. The polyester coating can withstand almost any temperature - both low and high. Compared to other types of polymers, polyester is the most affordable. Compared to other types of polymers, polyester is the most affordable. Not too outstanding strength characteristics of the material are compensated for by additional processing with quartz sand. However, the cost of coating is increased. Transportation of products with a polyester-quartz protective layer presents certain difficulties, since sand can damage adjacent surfaces.

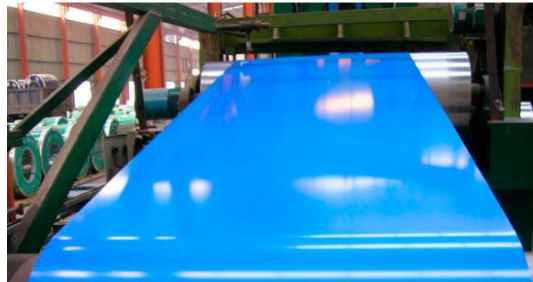

**Figure 1. Polyester coating**

### **PVDF coating**

Polyvinylidene fluoride (PVDF) is used to protect metals not much less often than polyester. This polymer consists of polyvinyl chloride (80%) and acrylic (20%). PVDF forms a shiny, fade-resistant layer on parts, therefore it is often used as a decorative coating. This material can give the surface a gloss, metallic effect, copper or silver tint. Polyvinylidene fluoride is resistant to mechanical stress and has the longest service life of all polymers. PVDF is used to treat metal surfaces that are exposed to aggressive environments.

### **Plastisol**

Plastisol, like PVDF coating, has excellent decorative properties. In terms of cost, it is the most expensive, but at the same time it has the best resistance to mechanical damage. Figure 2. Plastisol is applied in a thick layer (up to 200 microns) and is used to create textured coatings, embossed surfaces and stamped patterns.



**Figure 2. Plastisol coating**

This material perfectly protects parts from moisture and corrosion, however, under the influence of very high temperatures (over + 80 ° C) and direct UV radiation, it can lose its properties. That is why it is not recommended to use it in southern latitudes (in extreme cases, you can use light-colored plastisol with maximum reflectivity).

### **Pural**

Pural is made on the basis of polyurethane and modified polyamide. The pural coating has a silky-matte surface, high temperature resistance and resistance to sudden temperature changes. This material does not fade and does not deteriorate under the influence of chemically aggressive environments. Pural is not as resistant to plastic deformation as plastisol, and is more expensive than polyester, but in terms of price-quality ratio, it is the best option from all of the above. Pural coatings are most widely used in the production of galvanized metal roofing elements. Steel treated with pural gains a beautiful appearance, high anti-corrosion properties and resistance to UV radiation.

### **Polymer anti-friction coatings**

Antifriction solid lubricating coatings are a special type of polymer protective materials. Outwardly, they look like paints, but the pigment in their composition is replaced by highly dispersed particles of solid lubricants: molybdenum disulfide, graphite, polytetrafluoroethylene, etc. Figure 3.

**Figure 3. Polymer anti-friction coatings**

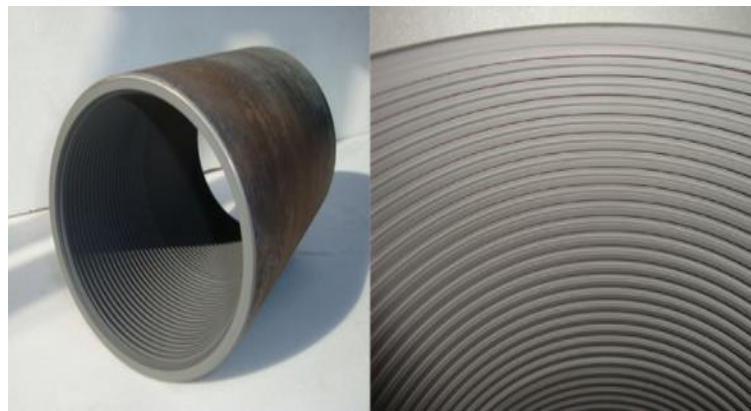

Solid lubricants are evenly distributed in a polymer binder: epoxy, titanate, polyurethane, acrylic, phenolic and other resins. The demand for antifriction solid lubricating coatings is due to their excellent performance characteristics: high bearing capacity, a wide range of operating temperatures, extreme pressure and anti-corrosion properties. Unlike conventional polymer coatings, anti-friction coatings withstand prolonged exposure to chemically aggressive media and extreme loads. At the same time, they perform not only a protective, but also a lubricating function, which also benefits from polymers.

Domestic coatings MODENGY can be cited as an example of such materials. They are used in a wide variety of industries and the automotive industry. Figure 4.



**Figure 4. Polymer anti-friction coating**

Typical coating units are medium and heavy loaded bearings, guides, gears, internal combustion engine parts (piston skirts, throttle valve, etc.), Threaded joints and other friction pairs made of various materials (metals, rubbers, plastics.) MODENGY anti-friction solid lubricating coatings are applied once for the entire service life of parts, which allows you to completely abandon oils and greases for further maintenance.

#### **ADVANTAGES AND DISADVANTAGES OF POLYMER COATINGS**

Polymer coatings have both undeniable advantages and obvious disadvantages.

The advantages of polymers include:

- Aesthetics
- Impermeability
- Relative heat resistance
- Electrical insulating properties
- Resistant to water
- Environmental friendliness
- High adhesion
- Large selection of colors

However, along with the positive aspects, polymer coatings are not without drawbacks. The main one is the high cost of application, which consists of the cost of the polymer itself, auxiliary (primer) materials, special equipment, etc.

Another disadvantage of polymer coatings is the difficulty of removing them. They are quite resistant to chemicals, so it will not be possible to remove the polymer layer with a solvent. The coating can only be removed with a special tool. A significant drawback of polymers is the impossibility of applying them without special tools, which are available only to industrial enterprises or narrow specialists. Among other things, not all metals can be coated with polymer compositions, but only those that conduct electric current. This is due to a special method of applying polymers - by magnetic induction.

## POLYMER COATING

Equipment plays a major role in polymer spray coating. Figure 5.



**Figure 5. The spray gun coating**

The spray gun tank is positively charged while the part to be painted is negatively charged. Due to this, when the polymer composition comes into contact with the surface of the product, a phenomenon similar to the magnetic induction when the electrode is closed occurs.

The entire application process is divided into stages, the adherence to which directly affects the quality of the final result. With the slightest deviations from technology, the performance of the polymer coating can be reduced to zero. At the first stage of work, the surface is prepared: it is thoroughly cleaned of dirt and degreased, those areas that do not need to be processed are closed. This is followed by preliminary priming of the product, application of the coating itself, varnishing is possible. All operations take place in a special closed chamber, isolated from the penetration of dust and other particles. One of the main requirements for this camera is good illumination, allowing the technician to see the surface of the part and apply the coating from any angle. The work-piece to be processed is suspended on special hooks, a negative charge is applied to it, and the coating is started. The whole process takes a lot of time, the material is applied in one layer to avoid unevenness.

The third stage is polymerization. The coated product is slowly warmed up in a special chamber with a maximum temperature of  $+200^{\circ}\text{C}$ . The process takes about 1 hour. The curing temperature and time depend on the layer thickness. An important factor in proper drying is the slow and uniform heating of the oven, during which the coating spreads over the part, penetrating into all hard-to-reach places. At the last stage, the product is cooled. For this, the temperature in the oven is gradually reduced to  $+100^{\circ}\text{C}$ . Do not allow the chamber to cool rapidly, as cracks may appear on the polymer coating. It is also forbidden to open the oven, as the temperature difference will cause the same consequences. The cooled part is removed from the oven and placed in a chamber for applying paint or varnish. This operation is optional and rather decorative. This gives the polymer coating additional shine and depth. Anti-friction solid lubricating coatings can be applied by standard painting methods: spraying, dipping, centrifugation, screen printing. Spraying is the easiest way. To implement it, you will need a spray gun with precisely tuned parameters, a source of compressed air and the coating itself.

## CONCLUSION

In conclusion, it should be noted that coatings made of polymer composite materials not only increase the life of the coated surface in terms of quality, but also have a positive effect on the

efficiency of the work. prevents unnecessary costs by protecting working parts from corrosion and external aggressive environment.

**REFERENCES:**

1. Tim A.Osswald and Georg Menges “Material Science of Polymers for Engineers” 3<sup>rd</sup> Edition. Carl HanserVerlag, Munich 2012.
2. SoumyaMondal, DipakKhastgir “Carbon-Containing Polymer composites”. Springer Singapore 2019.
3. У.А.Зиямухамедова. «Перспективные композиционные материалы на основе местных минеральных и энергетических ресурсов» Ташкент:ТашГТУ. 2011
4. William D.Callister, Jr. David G. Rethwisch “Materialsscienceandengineering8<sup>th</sup>edition”. USA 2010.
5. Gustavo Mendes and Bruno Lago“Strength of materials”. New York 2009.



**ACADEMICIA**  
**An International**  
**Multidisciplinary**  
**Research Journal**  
 (Double Blind Refereed & Peer Reviewed Journal)

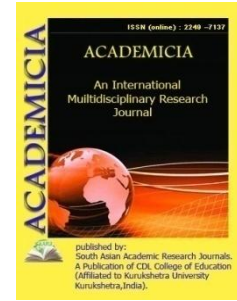

**DOI: 10.5958/2249-7137.2021.01065.X**

## THE ATTITUDE TOWARDS WOMEN IN UZBEKISTAN DURING THE SOVIET PERIOD

**Sobirova Dilfuza Tukhtasinovna\*; Abdullaev Farkhodbek Hasan ogli\*\***

\*Associate Professor of Andijan State University,  
 UZBEKISTAN

\*\*2nd year master of Andijan State University,  
 UZBEKISTAN

### ABSTRACT

*Policy of Soviet authorities regarding women in Uzbekistan is analysed in this article, and it has been given the analysis of the typical particularities of those policy and women's position in social life of Uzbekistan during this investigated period. They were partially freed from material dependence and were able to fully display their talents and abilities. This phenomenon has led to a change in the policy of almost all countries towards women, their attitude to them. From its earliest days, the Soviet government and the Communist Party pursued a policy of dividing the people into categories and groups. This undermined the idea of social partnership and created a social conflict among the local population. Not enough attention was paid to the problems of their marriage, life, family. The leaders of the Soviet government, in the interests of the Communist Party, tried and succeeded in exploiting women's labor in as many different ways as possible, that is, through incentives and coercion.*

**KEYWORDS:** *Women, Social Condition, Law, Idea, Economy, Policy.*

### INTRODUCTION

Although the issue of treatment of women has always been one of the most complex social problems in the history of mankind, the situation of Uzbek women was not considered an important social issue during the former Soviet regime.

The Soviet government and the Communist Party took the path of resolving this socio-political issue on the basis of their own political and economic interests. Therefore, many international documents adopted by foreign countries to address the issue of women's issues did not attract the attention of the former Soviet government [1]. For example, the 47th Convention on the

Reduction of Working Hours to 40 Hours a Week, adopted in Geneva on June 21, 1935, the Convention on Paid Annual Vacations, adopted on June 24, 1936, the Geneva Convention of 1919, and the 1952 These include the 103rd Convention on the Protection of Motherhood, revised on 28 June, and the Convention on the Elimination of All Forms of Discrimination against Women, adopted by the UN General Assembly in New York on 18 December 1979 and entered into force in 1981. . As a result, during the Soviet era, women's rights lagged far behind those of women in the world community in terms of social protection [2; 403].

Recognition of the shortcomings related to the problem of women as a global social phenomenon and a consistent effort to address these shortcomings, women's participation in public life, has increased their status in society. They were partially freed from material dependence and were able to fully display their talents and abilities. This phenomenon has led to a change in the policy of almost all countries towards women, their attitude to them. Recognizing that the future of the nation and society is full of women's participation, the world understands that society can have a perfect direction in its development only if they achieve their active participation in science, technology, production and management in all spheres of social life. It has been proven in every way, everywhere, that life in a place where women are helpless and cowardly is also full of helplessness and fear. It was found that a helpless woman could not give birth to and raise powerful sons and daughters. This paved the way for the feminization of society and enabled women to achieve great things in various social spheres.

During the former Soviet era, women's participation in public affairs increased due to "women's equal rights with men." While they were equally involved with men in society and public affairs, their traditional, ethnic status in the family: femininity, motherhood, and the division of family roles, they retained a large amount of work.

From its earliest days, the Soviet government and the Communist Party pursued a policy of dividing the people into categories and groups. This undermined the idea of social partnership and created a social conflict among the local population. This, of course, had a negative impact on women's marriages, further exacerbating their situation.

The Soviet government tried to mask the colonial nature of its policy among women in various forms.

**Including:**

- sought to change the social status and lifestyle of Uzbek women, ignoring the peculiarities of their mentality, their national and religious traditions, spiritual values;
- The feelings of rebellion and war in the psyche of women were directed to the production of material goods and mobilized to fight against their own national and religious traditions and customs;
- Due to the policy aimed at not forming the political and legal consciousness of Uzbek women, the awakening of their innate needs for national identity and the struggle for independence was not allowed;

To this end, efforts are being made to activate women in all spheres. We also see the Buja region during the war years.

From the first days of the war, the free-working women's movement in military hospitals expanded. In more than 30 hospitals in Uzbekistan, women worked with medical staff to care for soldiers who were seriously wounded in battle.

President IA Karimov said about the noble and humane qualities of the Uzbek people: “In those difficult years, when there was a shortage of bread, Uzbekistan sheltered thousands of families left homeless due to the war, gave bread, how many orphans were taken prisoner. rubs ». [3; 24]

However, the former Union's position, which was mainly focused on solving production tasks, had put social problems at the forefront. Therefore, the costs associated with the social protection of women who were forced to actively participate in production were significantly limited. The level of household and medical services provided to them was extremely low. The higher the demand for women's labor, the lower the focus on creating conditions for them [4; 153-154].

Women of the Republic took an active part in all spheres of public life during the years of post-war reconstruction and development of the national economy.

The percentage of unemployed women in Uzbekistan was higher than the average in the former Soviet Union, and the number of women living below the official poverty line was higher than in other Soviet republics.

Low-skilled, heavy, and low-paid labor slows down the socio-economic and spiritual development of a society. After all, he alienated those who worked from him, while at the same time intensifying in them the desire to protect their children from such hard labor in any way.

In the last years of the former Soviet Union, 14% of the able-bodied population of Uzbekistan (compared to 5.5% in other republics) was unemployed, and nine out of ten of them were women [5, 11].

In conclusion, the adopted laws and measures have been aimed at focusing women on socially useful work and praising the progress of production. Not enough attention was paid to the problems of their marriage, life, family. The leaders of the Soviet government, in the interests of the Communist Party, tried and succeeded in exploiting women's labor in as many different ways as possible, that is, through incentives and coercion.

#### REFERENCES:

1. Каримов И.А. Ватан саждагоҳ каби муқаддасдир. Т.: Ўзбекистон, 1995.
2. Муҳаммадова Ш. Истиклолаёллари //Ўзбекистонновози. 1997,- 18 сентябрь
3. Гендертадқиқотиасосларикурсихрестоматияси. Т.: Ўзбекистон, 2003.
4. Бобожонова Д. Ўзбекистондаижтимоий-иқтисодиймуносабатлар. Т.: Шарқ.1999.
5. Ўзбекистон: мамлакатнингумумийтавсифи. Т., 2003.
6. Андижондавлатуниверситети, 2010 йил 4 майдақабулқилинган: (Тақризчи: проф. И.Алимов)



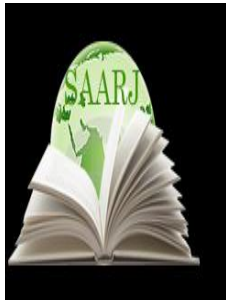

**ACADEMICIA**  
**An International  
 Multidisciplinary  
 Research Journal**  
 (Double Blind Refereed & Peer Reviewed Journal)

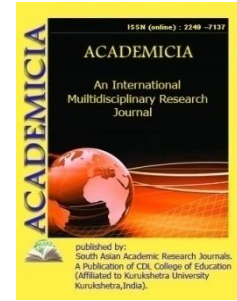

**DOI: 10.5958/2249-7137.2021.01066.1**

## OPTIMIZATION OF THE PARAMETERS OF THE AURBAND PROCESS IN THE MANUFACTURE OF WARP THREADS FOR NATIONAL AURB FABRICS

**Umarova Munavvar Omonbekovna\***; **Siddikov Patxillo Siddiqovich\*\***

\*senior Teacher Fergana Polytechnic Institute,  
 Uzbekistan, Department of "Descriptive Geometry and Engineering Graphics",  
 UZBEKISTAN

Email id: munavvar.omonbekovna.@gmail.com

\*\*Professor of "Textile Fabric Technology", t. f. d., prof,  
 Tashkent Institute of Textile and Light Industry,  
 UZBEKISTAN

Email id: Sid1943@mail.ru

### ABSTRACT

*Pullabrs threads is determined In work experimental for libit breakage a under existing and modernized adjuster instrument. As a result, in the process of dyeing aur yarns, dyes not provided for in the application penetrate the bonding areas where the specific density of the wrapping is insufficient. The specific gravity of the winding was measured with a PN-2 device (a device for measuring the density of the winding). Each measurement was repeated five times, and the experimental error did not exceed five percent.*

**KEYWORDS:** *Tossing.TONG-2.PN-2 Device. Experimental.Plots Of Libita*

### INTRODUCTION

The main peculiarity of obtaining patterns in auric weaving is that the weaving threads are dyed before weaving, tying the threads of the yarns together. Our research has shown that "Tossing" defect often occurs in tissues. The reason for such a defect is that in the process of tying the libit, due to the inequality of tension created by the tension, different specific densities of the yarns appear at the places of tying the yarn. As a result, in the process of dyeing aur yarns, dyes not provided for in the application penetrate the bonding areas where the specific density of the wrapping is insufficient. Experimental studies were conducted on the APM-3 avrband machine

and on this machine model (Picture 1). Along the width of the fill, the trunk tracks, which are fastened to the aurora threads on the avrband machines, are divided into ten sections.

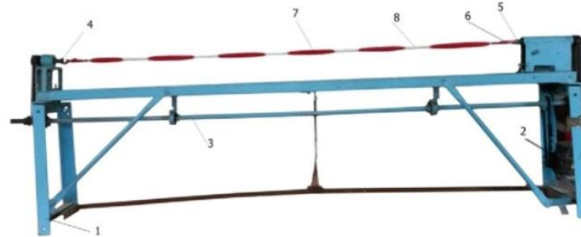

1 - stand; 2 - engine; 3 - middle bullet; 4, 5 - hooks; 6 - rope; 7 - painted area of libit; 8 is the unpainted area of the libit

Pics. 1. Model of emergency vehicle

Pull the aurora the yarns created by the tensioning device were measured with a modernized device to measure the TONG-2 yarn group. The specific gravity of the winding was measured with a PN-2 device (a device for measuring the density of the winding). Each measurement was repeated five times, and the experimental error did not exceed five percent. (Tables 1. and Picture 3) show that existing devices do not provide the same voltage, requiring improvement. In this regard, we have developed a modernized device (Pic. 4) for measuring the tension of the auric thread when tying libit threads.

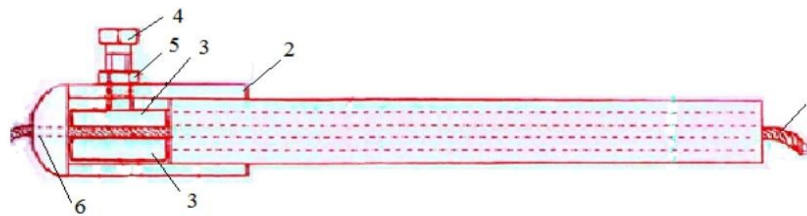

1 - set of aur threads; 2 - device for combing threads; 3 - leather pillows; 4 - adjusting screw; 5 - nuts; 6 - control eye

Pics. 2. Existing equipment for creating tension of Awr threads for tying libit.

Table 1 shows the results of measuring the winding density with an existing voltage device across the libit sections.

**TABLE 1**

№ п/п	Plots of libita									
	I	II	III	IV	V	VI	VII	VIII	IX	X
1.	0,7	0,6	0,6	0,5	0,31	0,59	0,4	0,48	0,6	0,7

2.	0,71	0,61	0,6	0,48	0,31	0,6	0,42	0,5	0,59	0,69
3.	0,73	0,6	0,61	0,51	0,28	0,61	0,4	0,51	0,6	0,7
4.	0,68	0,59	0,6	0,5	0,29	0,6	0,41	0,5	0,61	0,71
5.	0,67	0,6	0,6	0,5	0,32	0,6	0,4	0,51	0,6	0,7
6.	0,7	0,61	0,59	0,51	0,3	0,59	0,41	0,5	0,61	0,68
7.	0,72	0,62	0,6	0,5	0,3	0,6	0,42	0,51	0,6	0,72
8.	0,7	0,59	0,58	0,5	0,31	0,62	0,4	0,5	0,58	0,69
9.	0,7	0,6	0,62	0,51	0,31	0,59	0,38	0,49	0,6	0,7
10.	0,71	0,59	0,6	0,5	0,3	0,6	0,41	0,5	0,62	0,71
$\bar{y}$	0,702	0,601	0,6	0,501	0,303	0,6	0,404	0,5	0,62	0,69

The graph of the change in the density of the winding along the sections of the libit is shown in Pic. 2.



Pic. 3. Change the density of libit yellow when connecting libit to an existing tensioner.

1 - set of aur threads; 2 - device for combing threads; 3 - metal gaskets; 4 - adjusting screw; 5 - nuts; 6 - spring; 7 - control eye

Pics. 4. Modern device for creating tension of aurora thread for tying libit (Patent RUz № 00574)

Table 2 shows the results of measuring the winding density along the libit sections with a modernized tension device.

**TABLE 2.**

№ п/п	Plots of libita									
	I	II	III	IV	V	VI	VII	VIII	IX	X
1.	0,7	0,67	0,74	0,8	0,77	0,75	0,76	0,74	0,74	0,78
2.	0,71	0,7	0,75	0,78	0,75	0,77	0,74	0,76	0,75	0,77
3.	0,69	0,69	0,76	0,78	0,75	0,73	0,76	0,77	0,76	0,77
4.	0,7	0,68	0,75	0,76	0,73	0,76	0,78	0,75	0,77	0,78
5.	0,68	0,66	0,78	0,76	0,75	0,75	0,76	0,78	0,74	0,79
6.	0,71	0,68	0,76	0,8	0,74	0,77	0,78	0,77	0,76	0,75
7.	0,72	0,69	0,75	0,8	0,76	0,72	0,76	0,75	0,73	0,75
8.	0,70	0,68	0,76	0,76	0,75	0,75	0,75	0,76	0,75	0,78

9.	0,68	0,67	0,77	0,78	0,74	0,73	0,76	0,76	0,76	0,75
10.	0,7	0,68	0,75	0,77	0,76	0,75	0,76	0,77	0,77	0,76
$\bar{Y}$	0,7	0,68	0,76	0,78	0,75	0,75	0,76	0,76	0,75	0,77

The graph of the change in the density of the winding along the sections of the libit is shown in Pic. 4.

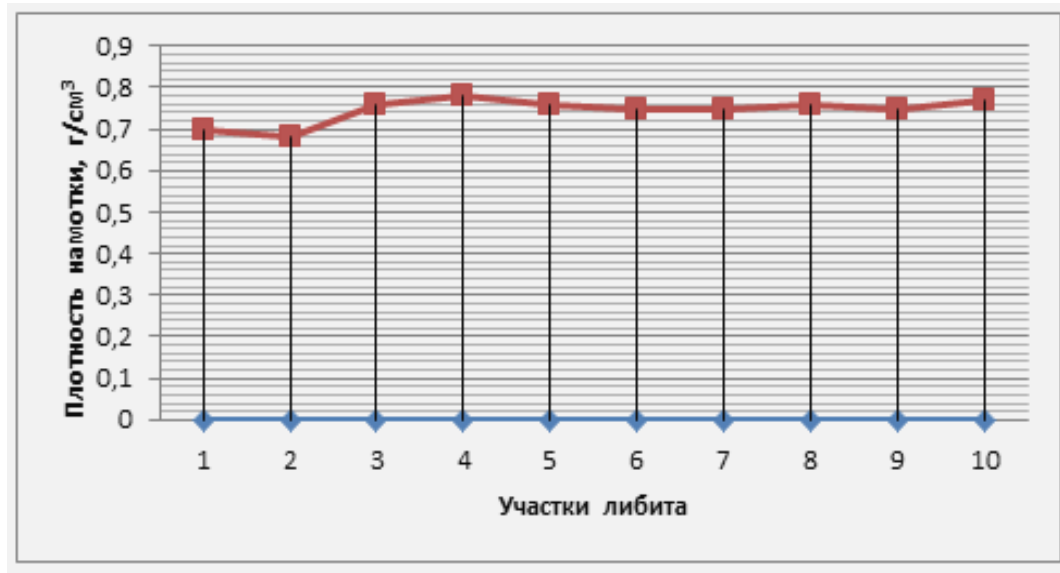

Pic. 5 Ventilation density varies with a modernized clamp

Pics. 5. It can be seen that when using a modernized device, the tension of the aurora rope and the specific gravity of the wrapping along the libit parts are equalized for tying the libit. As a result, stains on Nalejka fabric are eliminated and the quality of national Avra fabrics is improved.

### CONCLUSION:

1. A modernized device was developed and experimentally studied to adjust the tension of the aurora rope when tying libit.

### LIST OF USED LITERATURE:

1. Siddiqov P.S. Determining the parameters of the avarband process in tying the strings of libites. Textile industry №2. Moscow 2012. - S. 34 - 36.

2. Siddiqov P.S., Umarova M. O. ABOUT FORM LIBIT AND METHODS DETERMINATION PARAMETER WIND THREADS OF THE BASE ON LIBIT-WARPING DRUM. SJIF Impact Factor: 6. 260| ISI I.F.Value:1. 241| Journal DOI: ISSN: 2455-7838 EPRA International Journal of Research and Development (IJRD). INDIA, 5.03.2020.p.100-102.

3. Siddiqov P.S., Umarova M. O., Komilov.A.K., Yusupov.N.B STRUCTURE OF NATIONAL AVRY HAIR TISSUE AND SPECIFICITY OF ITS PRODUCTION. SJIF Impact Factor: 7.492 ISI I.F.Value:1. 241| Journal DOI: ISSN: 2249-7137 ACADEMICIA. INDIA, 2.02.2021.

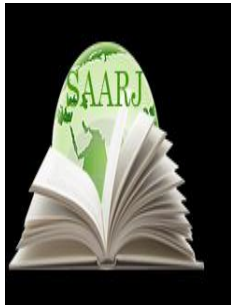

**ACADEMICIA**  
**An International  
 Multidisciplinary  
 Research Journal**  
 (Double Blind Refereed & Peer Reviewed Journal)

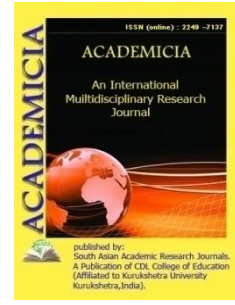

**DOI: 10.5958/2249-7137.2021.01075.2**

## THE ROLE OF HEALTH IN IMPROVING THE LIVING STANDARDS AND WELFARE OF THE POPULATION

**Firdavs Urokov Ortikniyozovich\***

\*Teacher,  
 Samarkand institute of economic and service,  
 UZBEKISTAN  
 Email id: firdavsurokov@gamil.com

### ABSTRACT

*This article discusses the important structural changes that have taken place in the health sector in Uzbekistan in recent years. The data of the State Statistics Committee, obtained as a result of the ongoing reforms in the country, were also collected and analyzed.*

**KEYWORDS:** *Services, Health, Well-Being, Life Expectancy, Living Standards, Medicine, Rural Health Center, Medical Services, UNICEF, Health Infrastructure.*

### INTRODUCTION

Health care is a system of social, economic and medical measures aimed at protecting the health of the population. Health care includes general measures aimed at preventing and treating diseases, creating healthy living and working conditions, ensuring high working capacity and longevity, and its main task is to provide modern, specialized and appropriate care to patients.

Healthcare has a long history in the East, especially in Uzbekistan. Especially in the Middle Ages, the region reached a high level of medical science. During this period, ancient medical works from Greek and other languages were translated into Arabic, and their recommendations began to be put into practice. At the same time, Eastern thinkers created world-class works in the field of medicine. In this regard, Abu Rayhan Beruni's "Medicine in Medicine" and Abu Ali ibn Sino's "Laws of Medicine" are well-known and have long been the main guides in world medicine. In particular, Abu Ali Ibn Sina became very popular in his time as a physician who used new methods of treatment. In recent years, medicine has been the main form of health care in Turkestan. Doctors were educated in madrassas or taught to treat various diseases and prevent diseases through mentoring. Many of them not only treated patients, but also prepared medicines. Sahibkiran Amir Temur, along with other educational activities, paid special

attention to the protection of public health. He brought famous doctors from other countries to the capital Samarkand and opened special hospitals<sup>1</sup>.

The transition to a market economy has also placed new demands on the health sector. In particular, measures are being taken to reduce administrative costs, use low-cost and efficient methods of treatment of patients, transfer part of the workload of hospitals to polyclinics, reduce the number of inefficient places, charge for contract work and other measures.

The protection of public health depends to a large extent on the activities of the state epidemiological service. In Uzbekistan, the "Health" Centers, which carry out organizational, methodological and coordinating work on the formation of a healthy lifestyle among sanitary-epidemiological stations and the population, carry out this task.

A network of specialized medical institutions for children has been established. The program "For a Healthy Generation" developed in the country, first of all, on the basis of regular medical examinations, identifies students and adolescents with poor health and sickness, and implements measures to improve their health and the younger generation in general.

On May 7, 1993, the Order "For a Healthy Generation" of I and II degrees was established for special services in the protection of motherhood and childhood, the best material conditions and the moral environment for the development of a healthy generation..

In Uzbekistan, great importance is attached to the continuity of medical education and professional development of specialists. The country's health care system has been gradually reformed. In the first phase (1991-1994), all attention was focused on improving maternal and child health services, stabilizing demographics, and reducing infectious diseases. In the second stage (1994-1998) pharmacies and a number of treatment and prevention facilities were privatized, outpatient services were developed and restructured. As a result, hospitalization decreased from 13.3% in 1997 to 13.8% in 2001.

In accordance with the Resolution of the Cabinet of Ministers of the Republic of Uzbekistan "On the program of development of social infrastructure of rural areas of the Republic of Uzbekistan until 2000" (May 21, 1996), a completely new institution in the field of health assistance was provided. For rural health posts, special criteria have been developed to meet international standards for all indicators - logistics, staffing, modern equipment and medicines.

Since 1998, a new era in the development of health care has begun - on November 10, 1998, the Decree of the President of the Republic of Uzbekistan adopted the State Program for the Reconstruction of the Health Care System for 1998-2005. It outlined measures to improve the quality of medical care for the population.

Under this program, measures have been taken to strengthen the primary health care system and to develop general medical practice. An extensive network of rural health posts has been established in all provinces, resulting in a two-tier system of medical care through rural health centers and the district central hospital. This work was carried out in cooperation with the World Bank on the basis of the project "Health". This has led to the development of new methods of managing and financing primary health care facilities, improving the quality of health care, and training general practitioners.

A new form of emergency care has been introduced. As a result, emergency medical care has been provided in all parts of the country, and the time between calling a doctor and receiving qualified medical care has been significantly reduced. The Republican Scientific Center of Emergency Care, its branches in Nukus and all regional centers, as well as departments of the central district and city hospitals. They provide training and retraining of personnel, as well as emergency medical care.

Positive changes have taken place in the training of medical personnel. The period of study at medical universities will be reduced to 6 years, and bachelors and masters, as well as highly qualified nurses - bachelors of nursing will be trained..

The main directions of the development of maternal and child health services are long-term state programs ["Maternal and child screening" (1998), "Healthy generation" (2000), "Mother and child" (2001), "Strengthening the health of women and the younger generation" on Additional Measures for Peace "(2002)]. In order to prevent the birth of children with congenital defects and inherited diseases, a system of screening of mothers and children has been established, and work is underway to create a State Register of Genetics.

As part of the implementation of measures to reform the health care system in the country, certain results have been achieved in the formation of a modern system of medical care. In the past, the system of primary health care has been improved through the establishment of rural health centers, urban and rural family clinics, and the population's access to these services has been expanded. A single centralized system of emergency medical care has been created, and the network of specialized scientific and practical medical centers providing high-tech medical care to citizens, including on the ground, is being improved..

The main wealth of the nation is its people, and the protection of public health has been and remains one of the main priorities of Uzbekistan and has always been in the focus of attention of the President and the Government. According to the Constitution, the population of Uzbekistan has free access to medical care provided through a network of state medical institutions - clinics, ambulances and public hospitals. In 2019, the health sector will reach 12.1 trillion soums (US \$ 1.27 billion), which is 30.5% more than last year, and in 2020 the state budget will allocate 14,842.6 trillion soums for health care. soums (1.56 billion US dollars).

From 2010 to 2019, the average birth rate in Uzbekistan remains almost stable, but with some growth. In 2019, the average life expectancy for women and men reached 77 years and 72.3 years, respectively. This is higher than the official figure for 2010, with a life expectancy of 75.1 years for women and 70.6 years for men. Life expectancy at birth in Uzbekistan ranges from 70 to 75 years. Women in Uzbekistan live an average of 5 years longer than men.

In 2018, 15.4% of Uzbekistan's GDP was directed to the health sector, which has doubled since 2016. This means that more and more attention is being paid to the health sector, attracting foreign investors to invest in this part of the public segment.<sup>2</sup>

Health is a sector of the national economy that is responsible for medicine in the broadest sense of the word. This is characterized by high barriers to entry for new entrants, as it requires licensing, large research costs, and intellectual property protection. According to various estimates, the global healthcare market will reach \$ 9.2 trillion in 2019, and the industry's projected growth rate will be 8.9 percent (2.6 percent of the world's gross domestic product).

taking into account the percentage increase). The prognosis is undoubtedly up to COVID, but the health care system is experiencing another crisis on a sustainable basis.

The health sector accounts for about 20% of the U.S. food program. The country is the world leader in per capita income: \$ 10,200 per year. It is followed by Switzerland (\$ 8,000) and Germany (\$ 5,700)<sup>3</sup>.

UNICEF supports the Ministry of Health in purchasing vaccines to ensure that every child is protected from preventable diseases. UNICEF is a key partner for the Global Alliance for Vaccines and Immunization (GAVI) in improving the planning, procurement and storage of vaccines. In particular, UNICEF calls for improved infrastructure at the national and regional levels, capacity building in the country and active participation in budget forecasting..

UNICEF works closely with the Ministry of Health, the Ministry of Finance, national and international research institutes, and UN agencies to achieve its goals. UNICEF is supporting the government in improving the planning, procurement and storage of vaccines through the Global Alliance for Vaccines and Immunization (GAVI). This work includes improving infrastructure at the national and regional levels, strengthening human resources in the country, and budgeting. UNICEF has spent perinatal care services and has provided evidence to demonstrate shortcomings in the existing system to improve the system.

If we look at the state statistics, we can see that the nominal volume of services has definitely increased in the last five years. The nominal size of the health sector within the service sector has also increased:

**Health care is one of the main types of economic activity volume of services provided in the field (in billions of soums)<sup>4</sup>**

<i>Table 1</i>	2016 y.	2017 y.	2018 y.	2019 y.	2020 y.
<b>Services - total</b>	<b>97 050,0</b>	<b>118 811,0</b>	<b>150 889,8</b>	<b>193 697,8</b>	<b>218 853,5</b>
Health services	1 416,3	1 701,5	2 220,0	3 104,3	3 209,4
<b>Share of health services (%)</b>	1,46	1,43	1,47	1,60	1,47

The table shows that the share of the health sector in services was the highest in 2019 (1.6%) and the lowest in 2017 (1.43%)..

**Health care is one of the main types of economic activity annual growth rates of the industry (as a percentage of the previous year)<sup>5</sup>**

<i>Table 2</i>	2016 y.	2017 y.	2018 y.	2019 y.	2020 y.
<b>Services - total</b>	<b>114,7</b>	<b>110,7</b>	<b>108,9</b>	<b>113,2</b>	<b>102,3</b>
Health services	122,2	116,9	113,4	114,7	89,9

The table shows that the highest growth in health services was in 2016 (+ 22.2%), while the lowest was in 2020 (-10.1%). we can say that Of course, the main reason for the decline is the damage to the economy caused by the coronavirus pandemic.

This crisis occurred suddenly in 185 countries around the world. This affected aggregate supply and aggregate demand at the same time. The emerging open global economy and national



economy have remained closed for several months. The world economic literature has not accumulated experience in identifying and mitigating the negative impact of the coronavirus pandemic on the world and regional economies, and the topic has not been routinely studied.

The head of state stressed that the main goal of all reforms is to improve people's lives, and that quality medical care plays an important role in this regard..

Over the past two years, 50 decrees, resolutions and orders of the President in this area, more than 70 resolutions and orders of the Cabinet of Ministers have been adopted. 6 new scientific-practical medical centers have been established, bringing their number to 16. In order to create more convenience for the population, 10 branches have been opened in the regions. 306 new specialized departments and 1,200 ambulance stations were opened in district and city hospitals. Another positive development was the recent Presidential Decree "On Measures to Strengthen Financial Incentives for Employees of Public Medical Institutions and Healthcare Bodies." According to him, the monthly salary of medical workers will be increased by 20% from December 1, and another 15% from April 1, 2019. President Sh.M.Mirziyoyev made proposals and recommendations on the development of a draft concept for the development of the healthcare system in Uzbekistan until 2025<sup>6</sup>.

#### **Foydalanilgan adabiyotlar:**

1. [https://uz.wikipedia.org/wiki/Sog%CA%BBliqni\\_saqlash](https://uz.wikipedia.org/wiki/Sog%CA%BBliqni_saqlash).
2. <https://www.rbasia.uz/zdravohranenie-sektor-uzbekistan>.
3. <https://vc.ru/finance/158871-sektor-zdravoohraneniya-health-care>.
4. <https://www.unicef.org/uzbekistan/uz/sogliqni-saqlash>.
5. [www.stat.uz](http://www.stat.uz).
6. <https://www.uzavtoyul.uz/uz/post/sogliqni-saqlash-tizimidagi-islohotlarning-yangi-ustuvor-yonalishlari-belgilab-berildi-9-11-2018.html>.
7. Ortikniyozovich, F. U. (2020). Theme: Forecasts And Results Of The Negative Impact Of The Covid-19 (Coronavirus) Pandemic On The World Economy And The Economy Of Uzbekistan. The American Journal of Interdisciplinary Innovations and Research, 2(08), 108-116.

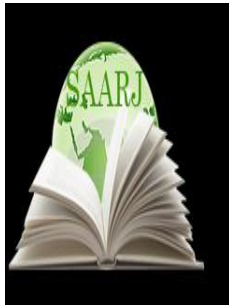

**ACADEMICIA**  
**An International  
 Multidisciplinary  
 Research Journal**  
 (Double Blind Refereed & Peer Reviewed Journal)

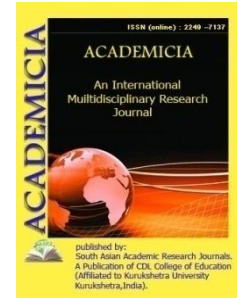

**DOI: 10.5958/2249-7137.2021.01076.4**

**THE ROLE OF HOTEL SERVICES IN THE DEVELOPMENT OF THE  
 ECONOMY OF OUR COUNTRY AND THE THEORETICAL ISSUES OF  
 THEIR DEVELOPMENT**

**Rakhimov Hasan Abdusaidovich\***

\*PhD, Teacher of the Department of Economic Analysis and Statistics,  
 Samarkand Institute of Economics and Service,  
 UZBEKISTAN

**ABSTRACT**

*The article describes the conceptual directions of improving the quality of service in hotels and scientific-theoretical and methodological issues of its evaluation. It shows the factors affecting the quality of hotel services, the specifics of hotel services, the system of indicators that reflect the quality of service in hotels, the content and ways to determine them.*

**KEYWORDS:** *Hotel, Service, Service, Quality, Quality Of Service, Quality Of Service In Hotels, System Of Indicators Of Quality Of Service In Hotels.*

**INTRODUCTION**

The implementation of measures for the development of tourism until 2010 has led to the acceleration of the growth rate of the industry and the growth of other economic indicators. The introduction of foreign currencies, the increase in profits and incomes of tourist organizations, the increase in jobs and the growth of current incomes of the population will be the result of the implementation of these measures.

Tourism is gaining a significant place in the country's economy. The development of this sector is characterized by the rapid development of the economy of the country (Table 1.3).

**TABLE 1.3 GROWTH RATE OF GDP AND TOURISM SERVICES IN UZBEKISTAN  
 IN 2000-2012<sup>1</sup>**

Indicators	Y e a r s													
	2000	2001	2002	2003	2004	2005	2006	2007	2008	2009	2010	2011	2012	
GDP growth rate,%	3 , 8	4 , 2	4 , 0	4 , 2	7 , 4	7 , 0	7 , 3	9 , 5	9 , 0	8 , 1	8 , 5	8 , 3	8 , 2	

Growth rate of tourist services,%	31,6	47,0	55,9	11,1	2,3	123,2	14,6	43,9	10,3	28,3	18,7	21,6	23,4
-----------------------------------	------	------	------	------	-----	-------	------	------	------	------	------	------	------

The table shows that in 2000, the country's GDP grew by 3.8%, while the growth rate of tourist services was 31.6%. In 2005, the GDP increased by 7.0%, while the volume of tourist services increased by 123.2%. At the same time as the growth rate of GDP in 2009 was 8.1%, tourism products increased by 28.3%. In 2011, this figure was 8.3 and 21.6%, respectively. It is also clear that the country's economy is experiencing a high annual growth rate of hotel services.

This picture shows that tourism services have a high growth rate relative to the country's GDP. Only in 2004 was the figure lower. At the same time, the impact of the extremist activities of 2003 cannot be denied. However, the reason for its sharp increase in 2005 was the high level of the Sharq Taronalari International Music Festival in Samarkand this year, which had a significant impact on the growth of this figure.

Tourism mainly involves people's recreational activities. In addition, tourism includes meetings with business partners and distant friends, but during such trips, entertainment and leisure activities are not excluded.

In particular, the age of the tourist determines the share of the demand segment and the main requirements for tourism services of this or that age group (for children, young people, middle-aged people). For example, today's age group requirements for the tourism market include unmarried young people under the age of 35, who are characterized by a high level of education, a desire to succeed, financial security, and a reluctance to associate themselves with family and home worries. In the major industrial cities of Europe, the group of "lonely" makes up about 50% of the total population. There are firms in the western tourism market that only work with this segment. In particular, the level of demand in this segment in Germany is 6-8 million people. Another promising age group of demand is "seniors" (50 years and older). Representatives of this group are well-off, strive to actively enjoy life and are ready to spend money on a "beautiful life" for personal needs.<sup>2</sup>.

A statistical analysis of tourism flows shows that the number of adult travelers is constantly growing and that people over the age of 55 have begun to play an important role in international tourism. The main part of this category of tourists falls on many countries with a large population of the elderly, such as the United States, Canada, Japan. The average life expectancy increased from 1985 to 1995 by 1-2 years in Japan and 1 year in Europe and the United States. Not only do people live longer, but they also maintain high levels of physical activity as they get older. Older people began to be much healthier. This is important in terms of economic security and requires the creation of the necessary conditions for travel. People between the ages of 55 and 59 travel 2-4 times a year within their own country and 0.8 times abroad. As of 2005, there were 18.8 million people aged 55-59 in the UK, the US and Japan. the population is about 6.3 million abroad. man traveled. It is noteworthy that family tourism has been developing recently. Its distinctive feature is that family-related tourism can be divided into two groups, namely, the first with children and the second without children. Based on the requirements for tourism by occupation, it is possible to cite groups of people united by a specific occupation working in an institution or a particular sector of the economy.

Tourism as a complex socio-economic system performs various functions. These include: introductory, recreational or health, political, economic, educational areas. Through travel, a person gets to know the world, gains experience, discovers new things, forms his own

worldview, and as a result, develops science, culture, art and becomes a key factor in social development. Through travel, people restore their health, gain new impressions and improve their physical and psychological condition. With the help of tourism, countries establish foreign economic relations. Because historically, tourism has always connected countries as a symbol of peace and friendship. All this expanded the culture of the nation and served to establish peaceful relations between them.

The economic function of tourism is that it is an advanced sector in the country and promotes the development of certain types of economic activities in cooperation with the industry. The educational function of tourism is that as a result of travel a person acquires knowledge and experience, as well as hardens, overcomes difficulties, misses and appreciates his country, respects the worldview and traditions of other nations.

There are many vital services in the history of personality. One of them is the services provided by the hotel industry. Because people travel from one place to another for various reasons (business trip, vacation, tourist destinations, treatment and other types of hospitality) has been going on since ancient times and is still becoming a part of our lives as a very intense process. Due to this, this type of service is also developing in the service system.

The services provided in the hotel industry also have their own characteristics in the system of services. To identify and study these requires clarification of a number of terms related to this service. These include "Guest", "Hotel", "Hotel Management", "Hotel Services", "Hotel Industry", and "Hotel Business". As a result of the development of definitions of these concepts, the specifics of the services provided by the hotel industry will be clarified.

There are different views on these concepts in the scientific literature. However, we explain our views based on the comments given in the 5-volume "Explanatory Dictionary of the Uzbek language".

In the "Explanatory Dictionary of the Uzbek language" it is noted that the word "guest" is derived from the Persian language and means "guest, visitor".<sup>3</sup> He then gave her three comments. 1 Wedding, banquet, etc. the person who visited (visited) on the occasion. 2 A person invited from abroad to a meeting, assembly, council, etc. 3 Visitor from abroad, temporary landing person.<sup>4</sup>

By summarizing these, it is possible to develop a definition of the word guest. In our opinion, the guest should be described as follows. A guest is a person who temporarily visits the city (village, apartment) for various reasons (meeting, meeting, council, wedding, banquet).

The word "hotel" is also defined in the dictionary as "(guest + room)". "1 guest house. 2 A building with rooms for temporary accommodation of guests"<sup>5</sup>.

Apparently, the hotel is, to put it bluntly, a room that welcomes guests, consisting of special buildings such as a house. But it is also necessary to give a scientific definition. In our opinion, the hotel can be described as follows. A hotel is a special building with appropriate facilities, which welcomes visitors for various reasons and ensures their comfortable stay for a short period of time.

The phrase "hotel business" is not mentioned in the "Explanatory Dictionary of the Uzbek language". This word is different from hotel. First, the hotel does not always open for profit.

An example of this is a hotel in a private home. However, the hotel business is often organized on the basis of entrepreneurship, with the aim of obtaining a certain fee. Second, hotels do not always carry out economic activities. However, business activities take place in the hotel business, and it is registered as a business entity, obtains the appropriate permit and is obliged to pay part of the profits to the state budget in the form of taxes. Based on this, it is possible to describe the hotel business. A hotel business is a legal entity or an individual who is registered as a business entity in order to create favorable conditions for guests, has a permit to engage in this activity and is obliged to pay part of the profits to the state budget in the form of taxes.

When theoretically studying the issue of services provided by the hotel industry, it is necessary to clarify the concept of "services provided by the hotel industry." This can be deduced from the content of the hotel and the services provided. Based on the above, it is possible to develop a definition of this concept. In our opinion, this concept can be defined as follows. Hotel services are a set of all services (accommodation, catering, transportation, entertainment, entertainment, etc.) for a fixed fee, aimed at ensuring the comfort of guests.

In the current situation, the hotel industry also plays an important role in the development of tourism and economic growth. Therefore, we think it is expedient to develop a definition of this concept as well. There are several definitions of the term "hotel industry" in the scientific literature, and their content is given in glossaries. For example, H.M. Mamatkulov admits that he sees the hotel industry as a modern manufacturing enterprise, service enterprise and organization.<sup>6</sup>. "It specializes in serving visitors for short-term vacations, business meetings or personal purposes." Below we see his explanation of this concept in more depth. The hospitality industry includes services and links such as service activities, guest accommodation, catering, transportation, recreation, and entertainment. The hospitality industry, by its very nature, is part of the infrastructure of the leisure and tourism industries and is a segment of customer service in cooperation with their hotels, catering centers and infrastructure.<sup>7</sup>.

It is clear from this comment that the hotel industry also plays an important role in hospitality. In view of this, we found it expedient to describe it as follows. The hotel industry is a set of opportunities for the provision of services such as hotels, the number of rooms in them, accommodation, catering, transportation, travel, recreation (recreation), entertainment.

We have acknowledged that the hotel business is organized for business purposes. If this is the case, it should be noted that the hotel business is also reflected in it. The economic literature provides several definitions of the concept of business. However, the definition of the hotel business is poorly developed and rarely covered in the economic literature. In view of this, we consider it appropriate to define the "hotel business" as follows. A hotel business is a set of services provided for a certain fee aimed at satisfying all the requirements of guests related to accommodation and recreation. This definition is a combination of the words hotel and business and their meaning.

## REFERENCES:

1. Statistical Review of the Republic of Uzbekistan for 2000-2009. T:Gosstandart. Corresponding years.
2. Kotler F., Bowen J., Makenz J. Marketing. Hospitality. Tourism: Text book for universities. Second edition.-M.: UNITY-DANA, 2002.--1063p

---

**3.** Explanatory dictionary of the Uzbek language : more than 80,000 words and phrases. J.II./ Editorial staff: T. Mirzaev (head) and head; Institute of Language and Literature of the Academy of Sciences of the Republic of Uzbekistan.-T.: “National Encyclopedia of Uzbekistan” State Scientific Publishing House,2006.

**4** Mamatkulov X.M. Glossary of terms and phrases in the field of services.-T.: "ECONOMY-FINANCE" Publishing House, 2010.-Pages167-168.

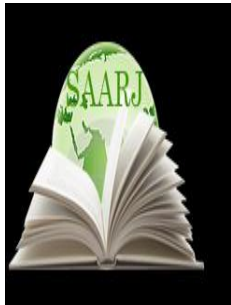

**ACADEMICIA**  
**An International  
Multidisciplinary  
Research Journal**  
**(Double Blind Refereed & Peer Reviewed Journal)**



**DOI: 10.5958/2249-7137.2021.01077.6**

## **SOME DISADVANTAGES OF THE ARCHITECTURAL DESIGN OF RESIDENTIAL BUILDINGS AND THEIR SOLUTIONS**

**Rakhmonov Gayrat Fazliddinovich\***

\*Bukhara Engineering-Technological Institute,  
UZBEKISTAN

### **ABSTRACT**

*Currently, creativity is developing rapidly. But, unfortunately, there are drawbacks in the construction industry: Climatic conditions, underground geology and wind direction must be taken into account when designing medium and high-rise residential buildings, especially in the construction of residential buildings. Also, residential buildings are built without the use of external enclosing structures, entrances and other elements that protect them from excessive sunlight. On improving the design of residential buildings, taking into account the above factors.*

**KEYWORDS:** *Orientation, Temperature, Operation, Dew Point, Hygroscopic Humidity, Condensation*



## INTRODUCTION

5-storey houses built in 2018 on Bukhara Avenue, Kagan District, Bukhara Region.

When designing protective devices for buildings in the climatic conditions of the Bukhara region, it is necessary to take into account the environment and humidity of the device. The reasons for the formation of moisture, the moisture content of external barrier structures are inextricably linked with the physical properties of heat. For this reason, the moisture content of external barriers is also included in the topic "Special architectural issues". Moisture is measured in two different units: g/m<sup>3</sup>.

Since water is in a gaseous state, it will have pressure. Therefore, in the block pressure: Pa can be expressed in N / m<sup>2</sup>. Relative humidity is the ratio of the amount of water present in the gaseous state in a volume of 1 m<sup>3</sup> to the maximum possible amount at a given temperature. Relative humidity is expressed in%:

$\varphi = E / E_{\text{max}} \cdot 100\%$  e- amount of water in 1 m<sup>3</sup>. E is the maximum ability of air to trap water vapor.

Relative humidity determines how much water vapor is in the air at a given temperature. Air's ability to trap water vapor to its maximum depends on temperature. Condensing temperature is defined as the temperature at which condensation forms during the subsequent cooling process. The body of building materials and external barrier structures are naturally and to a certain extent influenced by the bulk density, thermophysical and other properties of this building material. It is known that the higher the moisture content of the building material, the greater its thermal conductivity. Therefore, when designing external enclosing structures, it is necessary to take measures to protect them from the effects of natural external moisture, as well as to use building materials with low humidity, that is, with low moisture absorption, not only thermal, but also physical and moist. taken into account. need to get. Building materials with high humidity are also considered sanitary. First of all, this material, along with an increase in the humidity of the air in the room, creates wet spots and mold on the surface of the two roofs of the walls. This leads to spoilage of food, the spread of various diseases. Secondly, the strength of these building materials is low, they are not resistant to external influences and are not durable for a long time. To carry out an engineering calculation of the moisture content of external enclosing structures and in the process of using these building materials to ensure moderate climatic conditions, it is necessary to determine the reasons for the state of moisture in them.

The reasons for the appearance of moisture in the building material:

1. Technological moisture in construction is moisture generated during the preparation of building materials and the restoration of a building or equipment.
2. Moisture passes through the floor. This moisture passes through the soil through the capillary draft into the walls. This humidity can rise 2-2.5 m above ground level in the wall. An example of this is the architectural monuments built in Samarkand in the IV century, including the Rukhabod mosque. If the walls and foundation are well covered with a moisture-proof layer, the moisture in the soil will not affect the moisture in the walls.
3. Moisture passing through the atmosphere. This moisture, along with exposure to wind from blindness and rain, affects the outer barrier structures. To prevent this effect of moisture, it is



necessary to build a protective layer of low-permeability or moisture-insulating material on the outer surface of the external barrier structures.

4. Humidity due to environmental influences. This moisture is generated during the operation of the building and mainly affects the walls and floors in the case of steam and water in workshops of industrial buildings, domestic utility buildings. To prevent exposure to this moisture, the surface of the walls and floor is protected with a layer of ceramic and glass tiles.

5. Hygroscopic humidity. The process of formation of condensing moisture is inextricably linked with the thermo physical state of external barriers. Condensation moisture often causes an increase in the moisture content of the outer barrier and the building materials in it. One of the conditions for the formation of condensing moisture is that, as is observed in nature, the actual elasticity of water vapor in the body and surfaces of the structure changes with changes in the outside air temperature. As a result of these abrupt changes, the true elasticity of water vapor is equal to the maximum elasticity of water vapor at a given temperature point, and dew drops appear in this short period of time. Water droplets increase the moisture content of the structure. The temperature during the period of time during which water droplets form is called the dew point temperature. If the surface temperature of any building material drops sharply and the surface temperature is below the dew point temperature without changing the air humidity, water droplets similar to dew will form on the surface of that material. This condition is called the condensation humidity condition. Condensing moisture from building material surfaces and external barriers is slowly absorbed by the building material body over time, increasing the relative humidity of the structure. Moisture condensation can be observed with a sharp decrease in the temperature of the surfaces of external barrier structures. This condition is observed in the corners of the outer walls, in the section of the cornice, at the junction of the walls with the plinth and at the junctions of the panel walls with each other, as well as at the junction of the walls with the window. The process of formation of condensation moisture on the surface of external barrier structures depends on the following factors: 1)  $t_{sh} > t_b$  - if condensation moisture forms only in the corner of the external barrier; 2)  $t_i > t_{sh} > t_{min}$  - from time to time condensing moisture forms when the temperature of the inner surface of heat-resistant structures decreases. In winter, condensation moisture can often be observed to form on the outer surface of external barrier structures. The main reason for this is that after a strong cold, the air heats up sharply or the warm air cools down sharply. This situation can be observed on the outer surface of unheated building structures, on the surface of columns, bridge structures and sculptures. The temperature of the inner surface of the barrier, taken into account in the engineering calculation of the moisture state of the outer barrier structures, should not be lower than the dew point temperature. To prevent the formation of condensation on the inner surface of external barriers, it is necessary to dramatically increase air exchange in the room and reduce air humidity. In addition, the temperature of the inner surface of the barriers must be above the dew point temperature. This is achieved by increasing the thermal conductivity of the outer barrier or decreasing the thermal conductivity of its inner surface. If the air humidity in the room is high and approaches 90-100%, it is difficult to prevent the formation of moisture condensation on the inner surface of the outer barrier, etc.) layer.

Housing construction has a long history. From the very beginning of humanity, he built a shelter to protect himself from enemies, predators, cold and heat, and housing was a key factor in a person's rest and work. Over time, the function of housing has improved and expanded. The

architecture of housing has been adapted to the social conditions of society, the spirit of the times and other conditions. From a simple tent or cave to our time, it has turned into a modern dwelling, that is, an object ennobled with modern furniture. From the beginning, it was very difficult to access housing due to the lack of labor and building materials due to the helplessness of the economy. Therefore, then the question arose about the construction of housing and communal services. A special feature of conventional intermediate houses is that this is achieved by placing several families in rooms in the same house. That is, each family is placed in one room through a corridor or corridor. The kitchen, bathroom and toilets were common here. Of course, this type of house is not very comfortable, but these houses partially helped to solve the housing issue during that difficult period. That is, homeless families managed to move into such houses. After the restoration of the national economy, new types of housing were built. That is, ways have been developed to accommodate families not only in rooms, but also in apartments / flats /. At the same time, each family was provided with separate apartments. These houses, unlike the previous ones, had a separate toilet, washbasin and corridors. This has created more amenities for the population than previous common lounges. But here the principle of moving from room to room began to be applied. By 1955, instead of moving apartments from one apartment to another, a separate one-room apartment was created for each family member. Instead of overlapping rooms, structural units of multi-room apartments with separate rooms have been developed. The formation of any housing was greatly influenced by the geographic environment. For example, in northern-built houses, the interior of the apartment was protected from the external environment, because here the main requirement was the opposite - to protect the houses from heat and overheating. It was also necessary to connect the interior of the house with the external environment. Thus, on the basis of conflicting requirements, the structure of the structure of the northern and southern houses arose, which were completely different from each other.

National culture and customs also influence the structure and diversity of housing. Therefore, even if houses in the south with the same climate are similar to each other, they will change in accordance with the history and customs of the locals. Consequently, the Traditional settlements of the Uzbek people were adapted to their climatic conditions, level of culture, customs and artistic traditions.

Housing construction in Uzbekistan has a long tradition.

Basically, these houses are divided into three types: houses built in the style of Bukhara, Fergana and Khiva.

Bukhara houses were very developed during the feudal period and were densely built up, they were built opposite the courtyard. The rooms were one- and two-story. They were built around the courtyard.

The aforementioned national houses have been very well adapted to climatic conditions with simple equipment and methods.

Based on the above factors, we will give an example of the disadvantages and advantages of the orientation of residential buildings.

Figure 1: Direction of solar orientation in summer and winter.

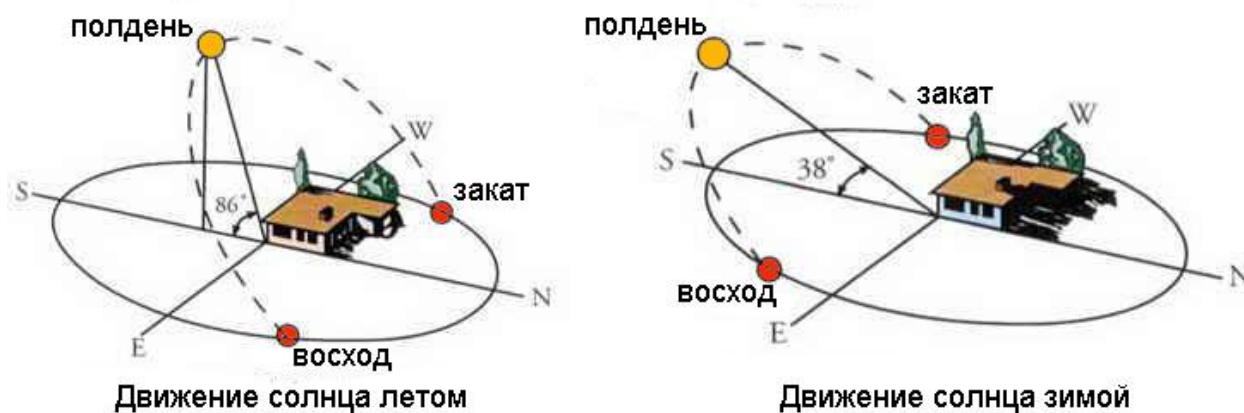

Figure 2: Aerial survey showing the precarious location of residential buildings in their current state.



Figure 3: Aerial survey of residential buildings in standard position versus orientation.

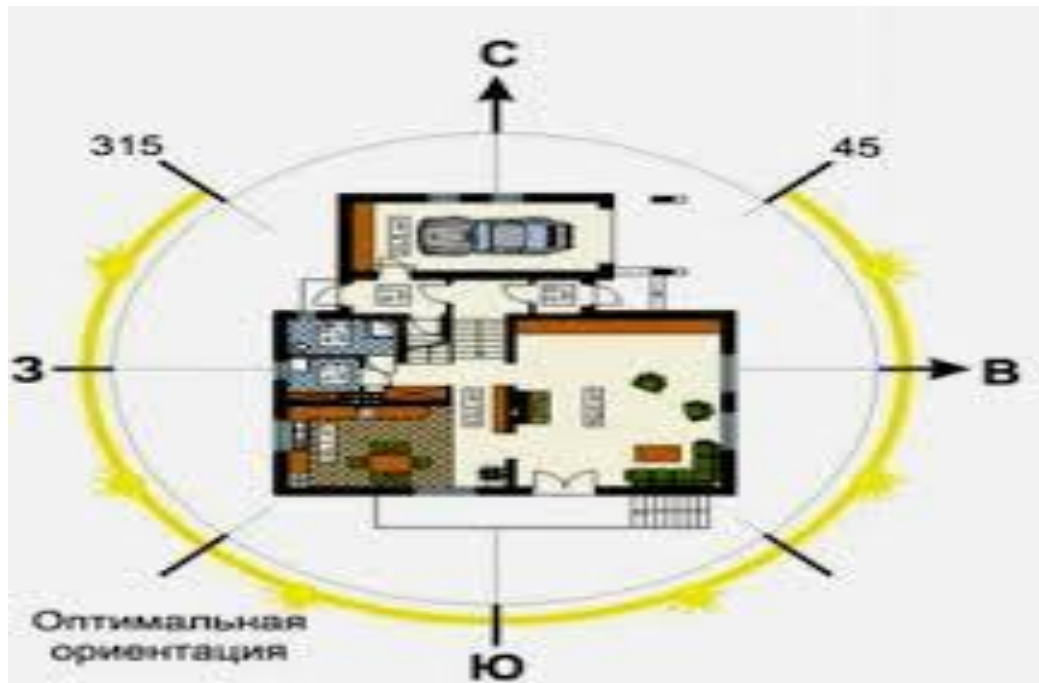

Figure 4: Typical Oriented Enclosure Layout References:

1. K.V. Babievsky. "Typology of a building" Tashkent.: Teacher, 1986.

Barshch M.O., Lisitsyan M.V., Turgenev V.P., Fedorova N.V., Architectural design of Zhiliks buildings M., 1984

Barksin B.G. Methods of architectural design M., 1982

Kiselevich L.N., Kosakovsky A.A., Reksina O.I. "Housing construction in a bright climate abroad, M., 1965".

Yarkina Z.N., Khachatryan K.K. Social foundations of an architectural project. tirovanie Moscow Stroyizdat 1990

I.E. Rogin et al. "Architectural design of public buildings and structures. Moscow Stroyizdat 1985.

SNiP Residential Buildings official publication / Uzbek-Russian / Tashkent 1996

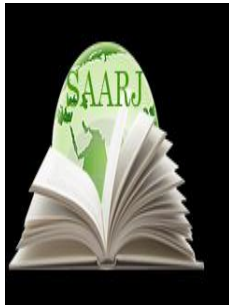

**ACADEMICIA**  
**An International  
Multidisciplinary  
Research Journal**  
(Double Blind Refereed & Peer Reviewed Journal)

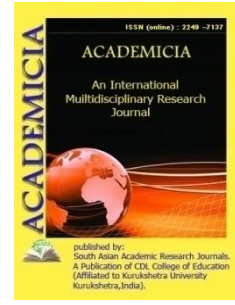

DOI: **10.5958/2249-7137.2021.01078.8**

## **CONTROL OF STOCK CURRENT IN FIELD-EFFECT TRANSISTORS BY GATE VOLTAGE**

**Suvonova Sohiba Ahmedjonovna\* ; Turaev Akmal Ataevich\*\***

\*Master,  
Bukhara State University, UZBEKISTAN

\*\*Associate Professor of Physics,  
Bukhara State University,  
UZBEKISTAN

---

### **ABSTRACT**

*This paper examines the preparation of a field-effect transistor and how the current is controlled by the gate voltage supplied by the source, which is determined by the value of the current resistance flowing through the channel in a bipolar circuit.*

**KEYWORDS:** *Transistor, field-effect transistor, integral optics, p-n junction, epitaxial structure, gate, stock, bipolar circuit.*

---

### **INTRODUCTION**

The creation of the transistor was one of the most important events of the twentieth century, leading to the rapid development of the field of semiconductor electronics, which began in 1833 with the experiment of the English scientist Michael Faraday with semiconductor material-silver sulfide.

Transistor (English: transfer-transfer and resistor-resistance) is a three-electrode semiconductor device designed to amplify, generate and convert electrical vibrations.

According to the structure, principle of operation and parameters of transistors divided into two: bipolar and field (unipolar) transistors. Bipolar transistors use semiconductors with both types of conductivity (p-type and n-type). A bipolar transistor operates at the expense of a p-n junction located close to each other and directs current through a base-emitter junction. Field-effect transistors are semiconductor devices that are controlled by a change in the electric field in the conduction channel to control the current value, and the input voltage acting on the output

current in the transistors creates an electric field. Only one type in field-effect transistors (n-type or p-type) semiconductors are used.

Two types of primary and non-primary charge carriers play an important role in a bipolar transistor. In field-effect transistors, the current is generated using the main current carriers, and the charge of the non-main current carrier does not play an important role. This is why a field-effect transistor is also called a unipolar transistor. In a bipolar transistor, the output current is controlled by the input current of the base or emitter. The input resistance is small. A bipolar transistor can be used where the input resistance needs to be small. But some circuits require a large input resistance. Current control in field-effect transistors For AC-controlled alternating current and low-frequency alternating currents, the input resistance of the transistor is very large: 10<sup>8</sup>-10<sup>15</sup> Ohms, the field-effect transistor preparation technology is simpler than that of a bipolar transistor. In addition, field-effect transistors occupy a small surface area in chips and consume less current. It therefore allows the generation of several thousand to tens of thousands of transistors and resistors on a small scale. Field-effect transistors are designed to amplify egkdsh udulek signals and power.

In field-effect transistors, unlike bipolar transistors, only one type of charge carrier is involved in current formation: either electrons or cavities. Therefore, they are also called unipolar transistors.

Today, semiconductors play an important role in science and technology. Semiconductor electronic devices are used in various sectors of the economy. Year after year, the hitherto unknown properties of semiconductors are being identified and new devices are being developed from them.

Different types of field-effect transistors are required to increase the reliability of the operation of integrated optics. The issue of stabilizing the parameters of the illuminator (generator) is very important. These parameters are very sensitive to changes in the operating mode and require special electronic circuits. Special current limiters for semiconductor lasers and LEDs are needed, especially if a current source is needed to create accurate measuring devices. The use of field-effect transistors for these purposes simplifies the circuit, unlike bipolar transistors. In this paper, the operation of a current limiter based on a field-effect transistor controlled by a p-n junction is analyzed.

The field-effect transistor under study was prepared based on the epitaxial structure. An n-type conductivity layer has been planted on the bottom of the p-type silicon, which represents the gate area. The length of the channel is 25 μm, width 560 μm, stock and istok contacts width 12 μm. The gradient of the current carrier concentration increases in the channel width in the p-n junction direction.

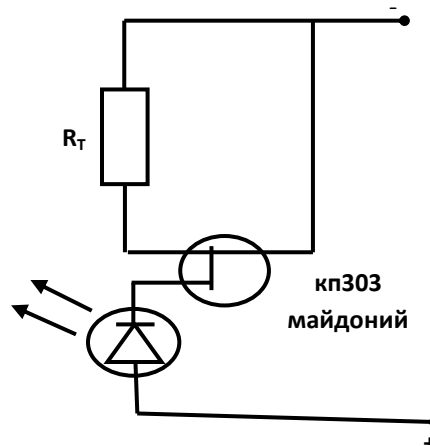

**Figure 1. Connection of a field-effect transistor to a circuit in current-limiting mode.**

The maximum current of the stock is 6.31 mA, the voltage across the duct is 2.4 V. The current in the form of a bipolar pole is generated by connecting the outputs of the gate with an external resistor. As a result, the automatic shift mode is set (Figure 1).

Such a mode differs from the voltage regimes determined by the common demand connection mode or voltage divider according to the saturation mechanism of the stock current. In this case, the channel modulation process is effective. The dynamic resistance of the channel increases sharply. In automatic displacement, the channel is compressed by the transverse and longitudinal components of the electric field. As can be seen from the circuit diagram of the limiter, the current flowing through the “channel-to-resistor” circuit is determined from the relationship (voltage corresponding to the resistance). At a given voltage, the saturation mode on the volt-ampere line of the stock current corresponds to the value of the external resistance. In addition to the stabilization current, such a stabilizer is characterized by a slope characteristic, saturation voltage, and breakdown voltage in the stabilization field.

In a field-effect transistor, the stock current is controlled by the gate voltage supplied by the source. Also in the two-pole circuit under consideration, the current flowing through the channel is controlled by the value of the resistance. an increase in the value of the resistance leads to a decrease in the stock current (Fig. 2).

The maximum value of the stabilization current is equal to the maximum current of the field-effect transistor at zero displacement. Indeed, from the measurement results, the stabilization current at zero resistance is equal to the maximum current of the field-effect transistor (Table 1).

**TABLE 1 THE DEPENDENCE OF THE STABILIZATION CURRENT ON THE EXTERNAL RESISTANCE**

$R_T, \text{OM}$	$S_{st}, \text{MA}$	$R_T, \text{OM}$	$S_{st}, \text{MA}$
0	6,31	1000	1,27
100	4,40	1500	0,96
200	3,45	2000	0,80
400	2,45	3000	0,53
700	1,70	4000	0,44

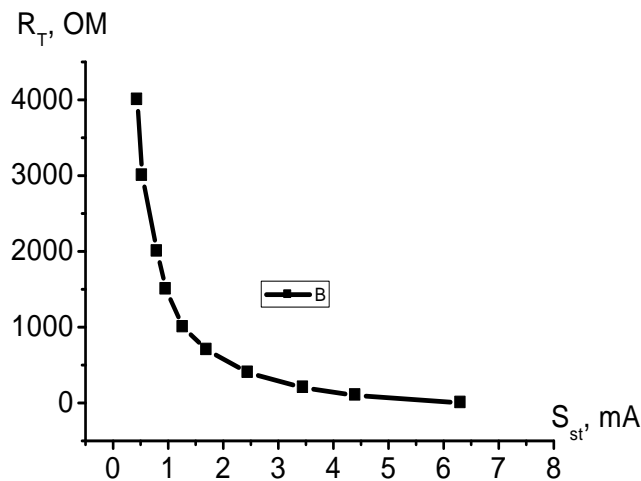

**Figure 2. -dependence of stabilization current on external resistance**

As the external resistance increases, the stabilization current decreases. For example, at a resistance of 200 Ohms, the stabilization current is 3.45, which is generated at a closing voltage of 0.8V. At a resistance of 400 Ohms, the current corresponds to a voltage of 0.1V.

The dependence of the stabilizing current on the resistance can be explained as follows: the external resistance of the controller, together with the channel of the field-effect transistor, resembles a voltage divider that closes the channel. As a result, the voltage drops proportional to the value of the resistance, and the current remains controlled according to the value of the resistance. The correspondence of the volt-ampere characteristic lines can be explained by the fact that in both modes the same voltage is present in the circuit.

## REFERENCES

1. Valiev U.V., Dzhuraev D.R., Malyshev E.E., Saidov K.S. Electronic structure of the ground multiplet of the  $Dy^{3+}$  ion in the  $DyAlO_3$  orthoaluminate// Optics and Spectroscopy (1999) PP 703-706.
2. Valiev U.V., Nekvasil V., Mukhamedhanova Sh.I., Dzhuraev D.R., Saidov K.S. Experimental Definition of Zeeman Splitting of Excited States of  $Tb^{3+}$  Ion in  $Y_3Al_5O_{12}$  // physica status solidi (b) (1999) PP 493-501.
3. Файзиев Ш.Ш., Саидов К.С., Аскарлов М.А. Зависимость магнитно модулированной структуры от ориентации поля в кристалле. //Вестник науки и образования ( 2020) № 18(96) Часть 2 С 6-9.
4. Файзиев Ш.Ш., Саидов К.С. Электронная структура основного мультиплета иона диспрозия в ортоалюминате// Academy, (2020) С 4-6.
5. Atoeva M.F., Arabov J.O., Kobilov B.B. Innovative Pedagogical Technologies For Training The Course Of Physics.// Journal of Interdisciplinary Innovations and Research, (2020). 2(12), PP 82-91.



6. Abdulxaev, OA, Yodgorova, DM, Karimov, AV, Kamanov, BM, va To'raev, AA (2013). Oqimni cheklaydigan rejimda maydon effekti tranzistorining harorat xususiyatlarining xususiyatlari. *Muhandislik fizikasi va termofizika jurnali*, 86 (1), 248-254.
7. Karimov, A. V., Dzhuraev, D. P., Kuliev, S. M., & Turaev, A. A. (2016). Distinctive features of the temperature sensitivity of a transistor structure in a bipolar mode of measurement. *Journal of Engineering Physics and Thermophysics*, 89(2), 514-517.
8. Djuraev, D. R., Karimov, A. V., Yodgorova, D. M., & Turaev, A. A. (2019). THE PRINCIPLES OF INCREASING THE SENSITIVITY OF TRANSISTOR STRUCTURES TO EXTERNAL INFLUENCES. *Euroasian Journal of Semiconductors Science and Engineering*, 1(1), 36.
9. Karimov, A. V., Djuraev, D. R., Abdulhaev, O. A., Rahmatov, A. Z., Yodgorova, D. M., & Turaev, A. A. (2016). Tenso properties of field-effect transistors in channel cutoff mode. *International Journal of Engineering Inventions e-ISSN*, 2278-7461.
10. Karimov, A. V., Dzhuraev, D. R., Edgorova, D. M., Rahmatov, A. Z., Abdulhaev, O. A., Kamanov, B. M., & Turaev, A. A. (2011). Nekotorye osobennosti ogranichatelya toka na polevom tranzistore. *Tehnologiya i konstruirovaniye v elektronnoj apparature*, (1-2), 90.
11. Каримов, А. В., Джураев, Д. Р., Ёдгорова, Д. М., Рахматов, А. З., Абдулхаев, О. А., Каманов, Б. М., & Тураев, А. А. (2011). Некоторые особенности ограничителя тока на полевом транзисторе. *Технология и конструирование в электронной аппаратуре*.
12. Rahmatov, A. Z., Abdulkhaev, O. A., Karimov, A. V., & Yodgorova, D. M. (2013). Features of the performance of a transient voltage suppressor in the pulsed mode. *Semiconductors*, 47(3), 387-391.
13. Тураев, А. А., & Ахтамов, Б. Р. (2017). Основные критерии параметров полевого транзистора для многофункционального датчика. *Наука без границ*, (6 (11)).
14. Тураев, А. А., & Жураев, А. Р. (2016). *Модуль приема оптических сигналов с входным каскадом на полевом фототранзисторе* (Doctoral dissertation, Сумский государственный университет).
15. Абдулхаев, О. А., Ёдгорова, Д. М., Каримов, А. В., Каманов, Б. М., & Тураев, А. А. (2013). Особенности температурных свойств полевого транзистора в режиме ограничения токов. *Инженерно-физический журнал*, 86(1), 232-237.

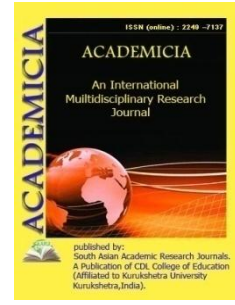
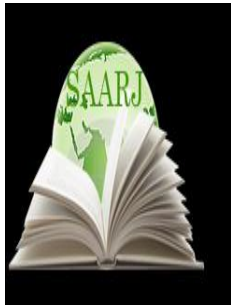

DOI: **10.5958/2249-7137.2021.01079.X**

## “COMPOSITIONAL STRUCTURE AND DESIGN SOLUTION OF ARCHITECTURAL ENSEMBLES AND COMPLEXES OUTSIDE BUKHARA”

Usmonov Erkin Toyirovich\*

\*Assistant,  
Bukhara engineering-technological institute,  
UZBEKISTAN

### ABSTRACT

*In this article, the vertical composition of the city is one of the important components of the historic city complex. The figurative nature of the city, its diversity and uniqueness, in a sense, the richness of the urban silhouette to the dominants, the contrast of the vertical heights and the relationship of the surrounding buildings, how they relate to each other and the towers in the history of the city. studies related to how expressive the towers themselves are with their construction and appearance have been analyzed.*

**KEYWORDS:** *Vertical, Composition, Dynamics, Dominant, Tradition, Silhouette, Dome, Combination, Proportion.*

### INTRODUCTION

#### Vertical composition of historical cities

Considering the spatial structure of historical cities, urban planners of the past understood the importance of its vertical composition and used all means to make it rich and unique. The silhouette of the ancient city was, as usual, rich in high dominants. The location of the original core (e.g., the Ark Fortress in Bukhara), the high elevation, and the accumulation of numerous verticals in the form of a tower adjacent to the blue-domed mosques and madrasas, led to a dominant general hierarchy. This system is filled with the vertical dimensions of the Poyi Kalon complex, the memorial complex of the Ulugbek and Abdulazizkhan madrasas, and the trade domes of the Taqi Zargaron and Abdullahan teams.

Thus, in the general construction of a large number of urban accents, the main and auxiliary parts of the composition are distinguished. The correspondence between the vertical accents and the

location of the historical nodes allows us to get an idea of the history of the city, its history, the location of the leading links and elements of local significance (small areas - residential neighborhood centers, urban neighborhood guzars, streets).

Many of the memorial complexes and neighborhood mosques, especially the prison building, are located in the highlands of the city, which is enhanced by man-made verticals under natural conditions. The vertical composition of the ancient cities has always been dominant and preserved, and in the process of reproduction of ordinary mosques and madrasas through the reconstruction of domes and minarets there was a strong contrast to the surrounding buildings.

Much attention was paid to the completion of vertical structures, because it was their top from the top of the horizon of urban buildings, from long distances that gave an idea of the quality of this or that structure and participated in the formation of urban originality. Here the diversity of shapes of the places of completion (domes, towers and their group combinations, flat-surfaced roofs) and fine proportions (proportions), clear lines are observed. In conclusion, it can be noted that the main features of the vertical composition of ancient cities are observed: the richness of the urban complex to a large number of verticals, the use of topographic conditions for the convenient location of vertical dominants.

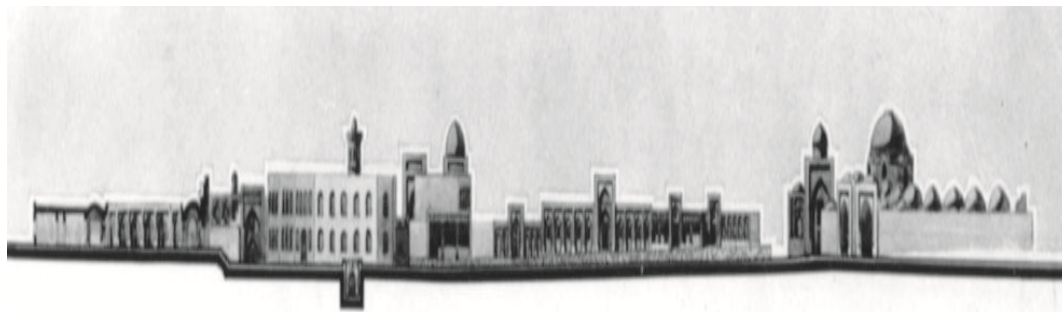

Comparing historical data with the current situation, unfortunately, in many cases it is possible to note a number of cases that worsen the condition of the vertical composition of the city complex. This is mainly due to the disruption of a number of historic verticals and the development of modern multi-storey buildings in the historic part of the city. The verticals were destroyed due to the loss of their functions and the lack of understanding and underestimation of their urban role (destruction of mosques and minarets, demolition of castle walls, etc.). Modern construction, carried out without taking into account the role of historical verticals in the complex, led to the flattening and alignment of the urban silhouette.

In historic cities with different levels and different rates of development, the disruption of vertical composition that has historically occurred occurs to varying degrees. Many changes have taken place in large cities, while in small towns the resulting complexes are well preserved. However, in recent times, many of these cities have undergone necessary and inevitable temporary constructions related to social conditions.

This is one of the important problems of the restoration of historic city centers with a rich heritage and can be solved only on the basis of thorough research. The importance of this or that vertical structure in the urban structure does not always correspond to the favorable topographic situation. Therefore, the next stage of research should consist of a direct study of the whole

hierarchy of vertical dominants: their size, mutual position and appearance between them, visual connections.

Perception through the silhouette and visual connections can be manifested in the spatial environment typical of the overall complex of the city, achieved due to the appearance of the emphasis on the urban construction horizon. In this case, researchers are interested in perceptual spatial visual communication when several towers can be seen at the same time, and impressions are accumulated because of their ability to see and remember.

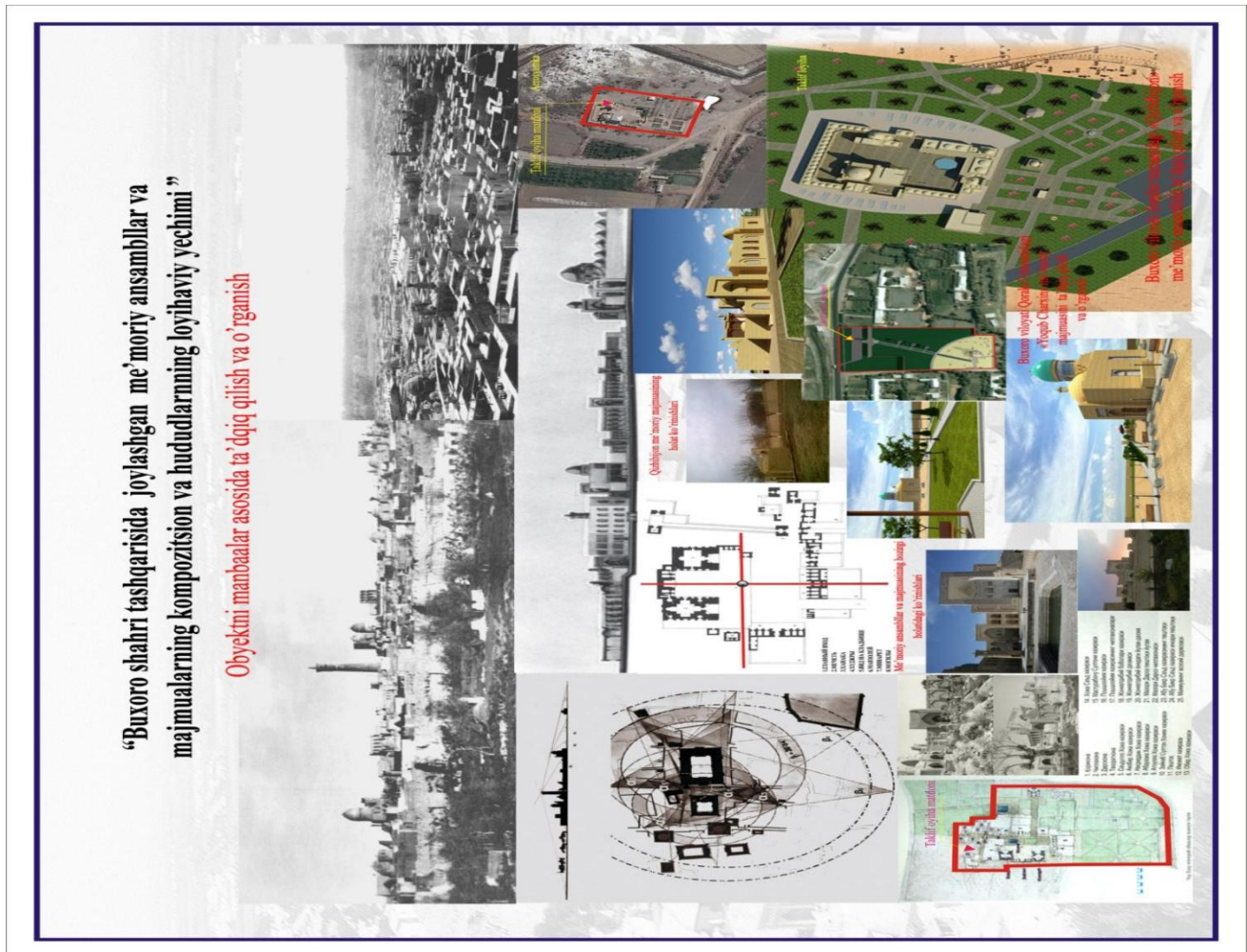

Each dominant has its own field of view and zone of compositional influence. These zones are the basis for determining the order of restoration of the surrounding areas. The boundary of the field of view is determined by searching and recording in nature the edge points of the dominant view in the plan. At the same time, objective factors limiting this zone are determined: relief, ancient plans and buildings, as well as destructive factors - partial destruction of the dominant, subsequent devices made without taking into account the existing dominant, high crops and others. There may also be cases where the field of view is fragmented. Because of the nature of the building, an additional point of view is determined from the ascending part of the site to the dominant side. In such cases, in addition to the main zone, such parts of the site are also recorded in the master plan.

The three-dimensional structure of the architectural complex, the compositional, visual connections and scale relations of the historical city form the architectural unity of all components - natural landscape, schematic diagram, structure (system) of leading volumetric and vertical dominants, main buildings and complexes and public buildings. It lies in each component such features as the external and internal appearance of the complex. The internal structure of the architectural complex, the collection of impressions and the creation of an appropriate image based on it are of particular importance in the daily interaction of the population with the architectural environment.

The structure of the historic city is an open and complete spatial unit. Open space includes artificially organized, organized spatial spaces - streets, sidewalks and natural spaces. The full space includes the dimensions of architectural structures and their complexes, as well as high green areas and other voluminous elements of the landscape.

The basis of the unity of the spatial structure of an architectural ensemble and complex is the inter-compositional relationship of its individual parts and the subordination of the construction of each of them to the overall system. Such interactions are considered in the compositional direction, in the volumetric construction, as in the location of architectural complexes in the city plan. In order to reliably assess the compositional-artistic advantages of architectural complexes and to develop reasonable recommendations for their restoration, it is necessary to understand and disclose these compositional connections in a historical context.

## REFERENCES

1. Sh.M.Mirziyoev. "Together we will build a free and prosperous, democratic state of Uzbekistan." Tashkent, 2016
2. Civil Code of the Republic of Uzbekistan. Approved by the Law of the Republic of Uzbekistan dated 04.04.2002 № 353-II.
3. "Urban planning norms and rules" Tashkent. Committee on Architecture and Construction of the Republic of Uzbekistan. 2009 y.
4. M.Q.Ahmedov. "History of Central Asian Architecture". Tashkent, 1995 y
5. M.Q.Ahmedov. "Architectural heritage"
6. Uralov A. S., Saidov I. M. Architectural monuments of Central Asia - material sources for studying the history of our country.- Samarkand, 2009.y
7. Z.N.Yargina. "Aesthetics of the city" Moscow. Stroyizdat, 1991 y

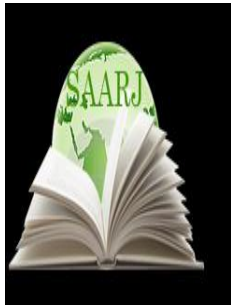

DOI: **10.5958/2249-7137.2021.01080.6**

## THREE ASPECTS OF DETERMINING PEDAGOGICAL SKILLS (RESEARCH, EXPERIENCE AND RESULTS)

**Nizom Toshmanov\***; **Ahadxon Muhammadiev\*\***

\*Docent,

Candidate of pedagogical sciences,  
TSPU Shahrizabz branch, UZBEKISTAN

\*\*Associate Professor,

Candidate of Philological Sciences,  
(TSPU Shahrizabzbranch), UZBEKISTAN

### ABSTRACT

*The article deals with three aspects of determining the skills of a teacher - the personal characteristics of the teacher, his competence and upbringing, the level of knowledge of the subject he teaches. The topic was covered based on the results of experiments and research conducted at the Shahrizabz branch of Tashkent state pedagogical university*

**KEYWORDS:** *Pedagogue, Skill, Competence, Education, Upbringing, Mental Labor, Cerebral Hemisphere, Stress, Mental Labor, Nerve Cells, Fatigue, Knowledge, Enlightenment ...*

*Education is for us life or death, salvation or destruction, whether it is happiness or disaster...*

*Abdulla Avloni*

### INTRODUCTION

Human society has emerged that education and upbringing are one of the main issues that are causing controversy. Alisher Navoi, the Sultan of Poetry, wrote the following about schools and schoolchildren (teachers) in the eighteenth chapter of the first part of Mahbub ul-Qulub (mentioned by the people of Dabiristan):

"Maktabdor begunoh ma'sumlarg'a jafokor. Atfol azobig'a rog'ib va alar ta'dibig'a murtakib. Zoti bemadoro, dimog'i po'lod va ko'ngli xoro. G'azabdin qoshida chin, gunahsizlar bila oyini xashmu kin. Ko'pragida tab' g'ilzati va tama' illati padidor va aql qillatig'a giriftor. Ammo tavsani atfol ta'bini jafo bila rom qilg'uvchi, nohamvor sig'or tavig'a siyosat bila andom

berguvchi. Agarchi xo‘ylari durushluqda namoyondur, ammo atfol nohamvorlig‘i islohig‘a irik suhondur” [Navoi, 1998: 22].

So, according to Navoi, the teacher (schoolboy) is a tormentor, a tormentor to young innocents. He was prone to torture babies and began to discipline them. He (the educator) is uncompromising, beandasha, angry and hard-hearted. His forehead is furious with rage, and his habit with the innocent (young children) is bitterness and enmity. Most were dark, greedy, and mentally retarded. But he is the one who subdues the taste of naughty and rebellious babies by harassing them, and the one who regulates the behavior of disorderly children (cows) with politics.

Therefore, the pedagogue (teacher) is a specialist who carries out educational work with students in secondary schools, academic lyceums and vocational colleges in various fields. Because a teacher influences the formation of members of society, his or her personal qualities are more important than his or her professional qualities. Because it shapes the image of society today and tomorrow. Therefore, it is not enough for a teacher to be professionally mature. His spiritual world must be saturated with the noble human qualities intended to be inculcated in the students.

Modern pedagogy notes that the teacher has such functions as practical, research, organizational, mediating, executive. Only a teacher who fully fulfills these tasks can influence the formation of today's young generation as harmoniously developed individuals. Decision-making of such features in teachers of the independence period is a factor in ensuring the development of the country [Encyclopedia, 2000: 79].

We continue with Navoi's description of teachers:

“Aning ishi odamdin kelmas, qaysi odamki, dev qila olmas, har qattig‘ kishini bir tiftl muhofazati ojiz etar, ul bir surukka ilm va adab o‘rgatgay, anga ne yetar. Oncha borkim, ul qavmning idroku fahmi oz tushar, andoq kishiga yuz muncha mashaqqat ne bushar. Har taqdir bila atfolg‘a haqqi ko‘pdur, agar podshohliqqa yetsa va anga qulluq qilsa xo‘bdur. Shogird agar shayx ul-islom, agar qozidur, agar ustod andin rozidur – Tengri rozidur”[Navoi, 1998: 22].

As you can see, Navoi is pointing out how difficult the teaching profession is. Navoi deserves a description of the profession, saying that not only a strong and energetic man, but also a giant can not stand the hardships of a teacher who introduces black and white to a child who has not yet realized anything. Therefore, a teacher "has a great right to a child with any destiny, and it is good if he reigns and serves him." According to Navoi, a student needs the consent of the teacher no matter what career he or she pursues. The approval of the Master is the approval of God.

Navoi's conclusions on this subject are summarized in the following verse:

Haq yo‘lida kim senga bir harf o‘qutmish ranj ila,

Aylamak bo‘lmas ado oning haqin yuz ganj ila[Navoi, 1998: 22].

Although these definitions of Navoi are almost specific to primary education, they are common to educators at all levels. So, teachers are divided into categories that teach pedagogical subjects and other science teachers. The division into such categories is conditional, resulting in two different approaches to the organization of lessons. A teacher of pedagogy uses science topics as an example in the study of a method or technology, the purpose of which is to reveal the method or technology being studied. Science teachers use pedagogical methods or technologies in

explaining a topic of science, the purpose of which is to reveal information on that topic of science.

Today, the amount of knowledge and skills that a school teacher needs to know and be able to apply is increasing, as the information is updated hour by hour, not day by day. In any case, the teacher should not underestimate his potential in three areas. These are: knowledge of the subject being taught, pedagogical skills and hygienic standards of education. These three indicators are of equal value, and if the performance of any of them decreases, the quality of the course it forms will not be high.

Science is a human activity aimed at developing and systematizing objective knowledge about reality. This activity is accomplished through the collection of facts, their regular updating, systematization, and critical analysis. New knowledge is created based on the observation of nature, social phenomena, and the disclosure or generalization of their interrelationships, which allows for scientific prediction.

The sum of the results obtained by observing these hypotheses is recognized as a law of nature or society, which is proved on the basis of experiments.

Science is a system of knowledge about the world, one of the forms of social consciousness. It includes both the acquisition of new knowledge and the knowledge that forms the basis of the scientific landscape of the universe, the product of that activity; represents some area of human knowledge.

The immediate goal of science is to describe, explain, and predict the processes and events of that reality on the basis of discovering the laws of reality that are the subject of its study. The first buds of science emerged in connection with the emergence of human society. Early knowledge was of a practical nature [Encyclopedia, 2005: 274].

If we look at history, a lot of data has been gathered through observations, investigations, and experiments. In terms of the specificity of this information, they were closely related to each other and divided into groups. In the future, science emerged at the heart of these groups. As a result of the deepening of a particular science, the directions of that science emerged.

The level of knowledge of the educator means the knowledge of the specialist in the field of science, the ability to apply this knowledge in life and awareness of innovations in the field of science. This is assessed on the basis of his knowledge or level of knowledge. Knowledge is a very broad concept and has different interpretations.

Knowledge is the information that people generate about natural and social phenomena; the reflection of reality in human thinking. Such belief is knowledge if we believe in what is in our daily imagination and this belief does not contradict the events and phenomena (rules) we are accustomed to. In order for our knowledge of reality to rise to the level of knowledge, it must meet the following conditions: first, the relevance of that information to reality; second, to be sufficiently convincing; third, this information must be based on evidence. All three conditions together bring the available data to the level of knowledge. In the process of social development, man moves from ignorance to knowledge, from abstract knowledge to the formation of perfect and concrete knowledge. Man's knowledge of the material world is relative, it is constantly evolving. Knowledge is accumulated through daily experience, observation [Encyclopedia, 2000: 29].

---



Knowledge is the result of understanding that can be logically and evidence-based and tested empirically or practically. Knowledge is the evidence-based product of human thinking, according to modern epistemology. When we talk about knowledge, we mean in this process - the reflection of reality in the human mind. Science and its scientific methods play an important role in gaining knowledge about the structure of objects and phenomena, their interdependence.

The potential of the educator in the second direction is pedagogical skill. If a teacher does not have a deep knowledge of his subject as well as pedagogical skills, the level of mastery of teachers will not be high. The high pedagogical skills of the teacher are the basis for the organization of quality lessons.

Pedagogical skill is a feature that defines such personal (childhood, kindness, humanity, kindness, etc.) and professional (knowledge, intelligence, devotion, creativity, erudition, etc.) qualities of a teacher, which deepens his knowledge and comprehensive knowledge, pedagogical-psychological and methodological training, finding and applying in practice the optimal ways of teaching, educating and developing students. Thus, in order to acquire pedagogical skills, a teacher must know his subject in accordance with the requirements of the time, master the disciplines of pedagogy, psychology, methodology, and strive to incorporate humanity and devotion [Ochilov, 1996: 91].

Any forced activity has a negative effect on the body. This effect is caused by the nervous system. In particular, the teaching process itself is a mandatory activity. In order to maintain the health of students during the lesson and at the same time increase their mastery, the teacher should know the requirements of educational hygiene, classroom and classroom equipment. At the same time, it is necessary to have mastered such concepts as the physiological basis of teaching, the ability of students to work, the hygiene of the nervous system of the student.

In order to prevent the disruption of the functional activity of the student's body, it is necessary to properly regulate the alternation of mental and physical activity during the working day, week and quarters of the school year. When one type of activity is replaced by another, the running cells rest. The norm of the load that a teacher gives to a student is determined by his age, state of health, cognitive ability, type of nerve and teaching conditions. When a student is overworked, his brain gets tired, and the younger the child, the faster he gets tired.

Prolonged cessation of muscle movements during the lesson impairs the child's ability to work mentally. As a result, the child's attention is distracted and his muscles begin to relax. Kindergarten children fall asleep when they are tired. When Hadeb engages in the same type of mental activity, the child's interest decreases and he falls asleep. Excessive fatigue or exhaustion can lead to decreased appetite, headaches, lethargy, memory and attention deficits. When a person is severely tired, the functional state of the nervous system changes and braking occurs.

During the course, students are influenced by many external and internal factors. Deviation of any of these factors from the norm becomes a pathogenic factor and harms the health of the student. For example, the height of the desk does not correspond to the height of the student, the lighting in the classroom is below or above the norm (norm 175-350 lux), the temperature is low or high, the air circulation and composition in the classroom is disturbed, the teacher deviates from hygienic norms.

All mental processes are closely related to the neural processes in the large hemispheres of the brain, because at the heart of each mental process are the neural processes: excitation, inhibition, distribution, concentration, dominance, and others. In addition, mental processes are formed on the basis of speech [Sodiqov, 1992: 82].

It is necessary for educators to create and practice all types of internal braking in the education of children and adolescents. It is important to keep in mind that the learning process will only be effective if the methods of comparison and contrast are used. Demonstrating colorful, shiny visual aids in the teaching process can create a dominant focus in the cerebral cortex by stimulating children to an exciting, delightful level, improving attention, and increasing the interest of the learning material. On the contrary, the same effect, the same conditions, the same tone of speech causes children to fall asleep, to lose interest.

Mental work is the result of the activity of cortical cells in the cerebral hemispheres. Therefore, when you work hard mentally, the nerve cells of the brain become exhausted, and the person becomes very tired.

Fatigue is the inhibition of brain cells. Fatigue is manifested by distraction, lethargy, drowsiness. If fatigue is not prevented, it leads to fatigue, in which the child has a headache, dizziness, decreased appetite, or the person becomes very impressionable, speaks in his sleep, wakes up, and so on. The lesson does not enter the brain well, the materials are not very memorable. Fatigue often occurs when the workload is increased, the schedule is disrupted, the child is less in the fresh air, and he does not eat properly.

Workability refers to the ability to do a job over a long period of time without compromising quality. Working ability varies from person to person and depends on age, health, strength, mood, work experience, exercise, team and family relationships, responsible approach to work, and many other factors. The ability to work varies from day to day, week to year, year to year. When the student wakes up from sleep, the ability to work is not so high, the body gradually begins to transition to a state of work. As the work progresses, it gradually increases, reaches a certain peak, then remains in this state, then subsides.

If a person works without getting enough rest on time, he will get very tired. It adversely affects the functions of the body, especially the central nervous system, resulting in deterioration of mood, increased sensitivity, insomnia, decreased interest in work, decreased ability to work.

The student's mental activity in the classroom is divided into 5 periods:

- ✓ Start-up period - lasts a few minutes in the classroom, the student adapts to the working conditions;
- ✓ optimal period of work - a period of stabilization of mental work;
- ✓ full compensation period - the first signs of fatigue begin to appear, but they are compensated by the willpower of the person and do not appear;
- ✓ Unstable compensation period - an increase in fatigue is characterized by a decrease in performance.
- ✓ period of progressive decline in labor activity - this period is characterized by a rapid increase in fatigue, a sharp decrease in labor productivity;

In order to ensure high productivity of mental work in the classroom, to prevent fatigue, it is necessary to carry out the following activities:

- ✓ visit and fill in the journal at the time of commencement of work;
- ✓ Explain the new material when the student has the optimal working ability;
- ✓ In the first half of the lesson, using active methods of teaching, the student explains without keeping his attention on one subject for a long time;
- ✓ change the method of teaching;
- ✓ Extensive use of visual aids, didactic and technical teaching aids in explaining the course material;
- ✓ Conducting physical minutes between lessons;
- ✓ high mood of the teacher when explaining new material, the teacher speaks in different tones [Aripova, 2010: 103].

In conclusion, the knowledge of the teacher means not only the knowledge he has acquired in his subject, but also the ability to convey this knowledge to the student, that is, his knowledge of pedagogical skills and the organization of lessons in accordance with the rules of hygiene is understood as a set of knowledge in the field of health care. Therefore, the disciplines of pedagogy and hygienic standards of education are taught in universities that train teachers.

In the process of preparing the article, we conducted an experiment to determine the knowledge of teachers of the Shahrizabz branch of Tashkent State Pedagogical University named after Nizami. 350 students participated in our experiment. The students commented on the 35 teachers who have been teaching them. The experiment (student response) was based on a questionnaire survey. In our questionnaire for teacher evaluation, the following four qualities of a teacher were highlighted:

1. Personal characteristics of the teacher.
2. Competence and education of the teacher.
3. The level of knowledge of the subject taught by the teacher.
4. Knowledge of educational hygiene.

The first quality is the personal characteristics of the educator. This teacher's voice timbre, temperament, majesty and so on ...

The second quality is the competence and upbringing of the teacher. The following were used to study these traits:

1. To what extent can the teacher organize lessons?
2. Teacher's pedagogical skills.
3. Level of audience management.
4. Fluency of speech (speech without parasitic words).
5. Justice during supervision.

6. Level of knowledge of ICT.
7. Graduality of speech.
8. The level of organization of lessons ...

The third characteristic is the level of knowledge of the subject taught by the educator himself. This quality of the teacher was determined on the basis of the following parameters:

1. The level of knowledge of the teacher of his subject.
2. The level of ability to apply knowledge in practice.

And finally, the teacher's knowledge of educational hygiene. This quality was determined by:

1. Sanitary condition of the classroom.
2. Suitability of equipment for student height.
3. Conduct the lesson in a high mood.
4. Ability to keep students from getting tired during class.
5. Features such as distraction skills when signs of fatigue appeared were reflected in the questionnaire.

Our experience based on this questionnaire, as we have noted, was organized within the framework of the activities of 35 professors and teachers. However, as part of the article, we divided them into three categories (associate professors, senior lecturers, and teachers).

The result is as follows:

Position	Qualities	Excellent	Good	Medium	Unsatisfactory
Associate professors	Personal characteristics of the teacher	59%	27%	9%	5%
	Teacher's competence and education	68%	18%	9%	5%
	The level of knowledge of the subject taught by the teacher	86%	9%	5%	0%
	Knowledge of educational hygiene	68%	27%	5%	0%
Senior teachers	Personal characteristics of the teacher	19%	49%	25%	7%
	Teacher's competence and education	10%	56%	32%	2%
	The level of knowledge of the subject taught by the teacher	29%	51%	17%	3%
	Knowledge of educational hygiene	32%	54%	12%	2%
Teachers	Personal characteristics of	3%	53%	27%	17%

	the teacher				
	Teacher's competence and education	10%	43%	24%	23%
	The level of knowledge of the subject taught by the teacher	13%	43%	20%	34%
	Knowledge of educational hygiene	33%	40%	14%	13%

The conclusion of our experience on associate professors is that 59% of students gave a grade of "5" to the personal characteristics of the teacher; 27 percent of students received a "4" grade; 9% of students received a grade of "3" and 5% of students received a grade of "2". It is obvious that the percentage of students who gave associate professors a grade of "5" in all four areas of the questionnaire was high.

Our summary of senior teachers is as follows:

19% of students rated the teacher's personal characteristics as "5"; 49 percent of students received a "4" grade; 25% of students received a grade of "3" and 7% of students received a grade of "2". As you can see, the percentage of students who gave senior teachers a "4" in all four areas of the questionnaire was high.

Our conclusion on teachers is as follows:

10% of students rated the teacher's personal characteristics as "5"; 53 percent of students received a "4" grade; 27% of students received a grade of "3" and 17% of students received a grade of "2". As it is known, the percentage of students who gave "4" marks to teachers in all four directions of the questionnaire was high, but we can see that the percentage of students who gave "3" and "2" marks was relatively high.

Also, during the experiment, we tried to clarify the average pedagogical experience of associate professors, senior lecturers and teachers and how many times they improved their skills. As a result, the indicators of the participating professors and teachers in this area are as follows:

Scientific position	Average pedagogical experience	Pedagogical experience in higher education	Average training
Associate Professors	20	16	5 times
Senior teacher	12	11	2 times
Teacher	3	2	Unqualified

The data in these tables show that the majority of those who are highly rated by students are professors and teachers with many years of teaching experience and academic titles. So, as a result of our research, it can be seen that a teacher with scientific potential has proven to be a quality teacher. He analyzes the material throughout the lesson, shapes it in his imagination, and digests it himself. The effectiveness of the lessons organized by such educators will be high.

Our observations also found that teachers with no academic degree had a relatively low level of analysis and synthesis of materials around the topic. They are accustomed to accepting material as it is in the scientific literature. The result casts a shadow over the full scope of the subject. Lessons organized by a teacher in this category may have some degree of shortcomings. This has a negative impact on lesson effectiveness.

Another important aspect of our experience is that teachers have the opportunity to learn about the achievements and shortcomings of university professors based on the assessment given by students, and to discuss this information individually with their participation.

So, the discussion based on the results of the experiment with the participation of professors and teachers gave good results. Participating professors understood and tried to work on what aspects of themselves they needed more.

This experience has proven to be a catalyst for professors to work on themselves. After all, there is no doubt that only experienced teachers will be able to develop experienced and talented teachers in the future.

#### **REFERENCES:**

1. Alisher Navoi. Mahbub ul-qulub. A perfect collection of works. Twenty volumes, fourteen volumes. - Tashkent: Fan, 1998. - 238 p.
2. Aripova X.S. Age physiology and hygiene. 2010
3. S.Ochilov. "Human adornment is manners." T. : «Teacher», 1996.
4. National encyclopedia of Uzbekistan. Volume 1 A - Beshbaliq. Editorial board: M.Aminov, B.Akhmedov, H.Boboev and others. T. : "National Encyclopedia of Uzbekistan" State Scientific Publishing House, 2000. - 736 p.
5. National encyclopedia of Uzbekistan. Volume 9 Wedding Hafiz - Waterfall. Editorial board: A.Azizkhodjaev, B.Alimov, M.Aminov and others. T. : "National Encyclopedia of Uzbekistan" State Scientific Publishing House, 2005. - 704 p.
6. Q.S.Sodiqov. Physiology and hygiene of children and adolescents. - Tashkent: Teacher, 1992



**ACADEMICIA**  
**An International  
Multidisciplinary  
Research Journal**  
(Double Blind Refereed & Peer Reviewed Journal)

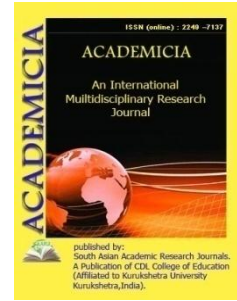

DOI: **10.5958/2249-7137.2021.01067.3**

## **THE ACTIVE PARTICIPATION OF STUDENTS IN THE FORMATION OF THE EDUCATIONAL PROCESS IS A KEY TO EFFICIENCY**

**A.A. Kholmurzaev\*; I.Kh. Tokhirov\*\***

\*Associate Professor,  
Candidate of Technical Sciences,  
UZBEKISTAN  
Email id: abdirasul60@gmail.com

\*\*Assistant  
Fergana Polytechnic Institute, ORSID  
UZBEKISTAN

### **ABSTRACT**

*The article discusses the issues of attracting students in the process of forming educational materials, as well as the problems of increasing the effectiveness of educational and cognitive activities of students. In the "Learn" option of the test, immediately after selecting the correct answer, a message will appear stating that the answer is correct or incorrect. It contains the messages "correct", "incorrect" and "partially correct".*

**KEYWORDS:** *Modernization, Educational Process, Educational And Cognitive, Independent Education, Effective Teaching, Test, Graphic Disciplines*

### **INTRODUCTION**

From the point of view of modern development trends aimed at modernization of higher education and humanization, the problem of preparing future professionals for creative activity in the Technical University is important.

Pedagogical experience shows that the learning process does not involve the direct participation of students in the formation of generalized types of knowledge and activities in the construction of the learning process by traditional methods. Such reading does not stimulate the student's learning activity in the process of acquiring knowledge, skills and qualifications, does not allow for independent learning, development and self-expression.

The effectiveness of the learning process in relation to the acquisition of knowledge and creative development is determined by the fact that the student is focused on the correct organization of personal learning activities.

The problem of effective learning is not new to the science of teaching theory. This problem has been studied in the scientific works of I.G. Pestalotsi, K.D. Ushinsky and a number of similar scientists. Scholars such as SI Arkhangelsky, AP Arkhipov, B.C. Merlin, VA Sukhomlinsky and G.I. Shchukin also contributed to the coverage of this issue. They theoretically substantiated that the achievement in the process of learning increases the activity of learning and mastery, leading to the manifestation of important aspects of intelligence.

The tendency to improve the quality of education of future professionals and, at the same time, the constant decline of the graphic sciences requires the professor to look for new ways to improve the educational process.

The dramatic changes in the education system pose a number of challenges for teachers and students of technical colleges to think carefully about their activities.

While the main type of student activity is learning activity, for the professor-teacher it is educational work. Of course, the success of these two goals of the teacher and the student of the higher education system depends on their joint cooperation in improving the learning process. This collaboration will ultimately lead to an increase in learning.

There are a number of features that lead to a decrease in the performance of graphics in higher technical education:

- The low level of school readiness of those entering the technical university requires both teachers and students to engage in additional educational activities;
- Lack of psychological preparation of the student to master this course due to irresponsible attitude to the subject "Drawing" when entering the technical university;
- The novelty of the subject "Descriptive Geometry" for students, its unusual for the student, such as mathematics and physics, requires additional mental and willpower in their work;
- Lack of knowledge and skills in graphic work requires additional effort and a lot of time to learn the rules of drawing from the student;
- The teaching of graphic sciences coincides with the period of adaptation of the student to the educational process in the higher education system, the period of transition to the conditions of the higher education system, which differs significantly from the school environment.

It would be expedient to consider the above problems not only in the educational process at the Fergana Polytechnic Institute, but also as a global problem that exists in higher education institutions throughout the country.

Life itself requires the study of the problem of activating the student's learning, knowledge and its social, psychological, methodological and other causes.

At present, various forms of determining student knowledge are used in the educational process. In particular, test-type control works are used during intermediate, current and final tests.



Drawing geometry is one of the branches of geometry, which deals with the study of the geometric basis of the construction of images of objects in the plane, the methods of solving spatial geometric problems through images. The generality of methods in mathematics is also characteristic of this science. Drawing geometry is the theoretical basis for solving technical drawing problems.

The part of descriptive geometry of the subject "Descriptive Geometry and Engineering Graphics" in the curriculum is taught mainly in the 1st semester of the academic semester in most areas. The number of tests compiled from this section was more than 200 and was initially tested in the Mytest system. The questions included in it were unofficial and did not allow to reveal the full essence of science. In the Mytest program there is an opportunity to ask questions in the form of pictures. However, their capabilities are limited. Due to this, the level of knowledge detection is insufficient.

The solution of the above limitations in the Isrping software complex has provided an opportunity to take advantage of the latest advances in information and communication technologies. Thus, versions of test programs on the subject "ChG and MG" created in the software complex Isrping Quizmaker were developed. New pedagogical technologies have been introduced, "Learning" and "Testing" programs have been introduced into the educational process, including 12 different forms of test questions.

The program includes test questions "correct-incorrect", "1 correct choice", "many correct choices", "fill in the blanks", "compatibility", "arrangement", "enter the number", "missing word", "summary answers"., The presence of such types as "vocabulary", "active space" allowed to effectively use the questions in the form of graphics.

In the "Learn" option of the test, immediately after selecting the correct answer, a message will appear stating that the answer is correct or incorrect. It contains the messages "correct", "incorrect" and "partially correct". In the "Learn" version of the test, all the answers come in sequence. The variation option is disabled and the student has the opportunity to explore questions on topics that are consistent with the sequence in the science plan.

Previously, theoretical and practical questions were asked in written tests in midterm examinations. Practical questions were answered by students by drawing sketches. When theoretical answers were given in writing, they were mostly copied, either directly from a book or by telephone. As a result, the student's grade did not match his or her real knowledge.

With the introduction of the test program, the participation of the "human factor" in determining the student's grade will be reduced, which will be determined by computer.

An important role in the research work carried out at the department to improve the educational process is played by the management of independent work of students. Among the various types of modern technologies of pedagogical control, special attention is paid to test methods.

This method activates memory, activity, thinking, attention in the student. The inevitability of passing a test-based test control creates a motivating force in the student. Increases his activity related to reading and learning.

However, the main part of the existing tests in graphic arts at the present time is intended for use only in the intermediate and final controls and does not meet the requirements of the student's independent reading and learning activities.

Almost no research has been done on involving students in the preparation of pedagogical test assignments. Ways to improve this process in technical universities have not been sufficiently analyzed and substantiated. Lack of standards for assessing the level of knowledge, skills and competencies in special disciplines of modern technical education leads to a breakdown of feedback between teacher and student. The student is unable to reflect on the knowledge he or she is acquiring, to correct the teaching, and to determine the path to the main goal - successful learning and creative development.

To find ways and means to increase the learning and cognitive activity of first-year students during the period of adaptation to the educational process, based on the study of the experience of higher and secondary schools, analysis of philosophical, sociological and psychological-pedagogical literature is an important challenge. To study the contradiction between the growing public demand for the creative activity of the future engineer and the need to increase his professional and creative training in this regard is the main direction of our research.

Problems of increasing students activity in the classroom are not sufficiently developed pedagogically, theoretically and methodologically - the lack of science-based test assignments to assess the quality of teaching students in engineering graphics and increase their learning activity is also a major part of the problem.

It is necessary to develop a new approach to the issue of directing students from stressful situations to positive activities, which will increase their interest in the topic studied during the period of adaptation to the learning process. Research in this area shows that the use of pedagogical tests increases the quality of student learning and learning.

To do this, it will be necessary to involve the student in the following activities:

- use a specially designed bank of experimental test assignments;
- perform knowledge testing on a regular basis;
- involving students in the preparation of test assignments independently;
- creating conditions for pedagogical testing and ensuring that students have a deep penetration into the subject.

## REFERENCES

1. Ушинский К. Д. Избранные педагогические сочинения. В 2 т. Том 1. Теоретические проблемы педагогики - Москва: Педагогика, 1974
2. Kholmurzaev, A. A., & Polotov, K. K. (2020). Methods of using media education in the learning process. *Theoretical & Applied Science*, (5), 205-208.
3. Холмурзаев, А. А., Алижонов, О. И., Мадаминов, Ж. З., & Каримов, Р. Х. (2019). Эффективные средства создания обучающих программ по предмету «Начертательная геометрия». *Проблемы современной науки и образования*, (12-1 (145)).

4. Холмурзаев, А. А., Мадаминов, Ж. З., Рахмонов, Д. М., &Расулжонов, И. Р. (2019). Методика развития профессиональной компетентности информационно-технических средств будущих учителей черчения. *Актуальная наука*, (4), 112-115.
5. Polotov, K. K. (2020). Features of teaching engineering and computer graphics. *Theoretical & Applied Science*, (6), 573-576.
6. Абдукаримов, Б. А., &Тохиров, И. Х. (2019). Research of convective heat transfer in solar air heaters. *Наука, техника и образование*, (9 (62)).
7. Holmurzaev, A. A., Madaminov, Zh. Z., Rahmonov, D. M., &Rasulzhonov, I. R. (2019). Metodikarazvitiyaprofessional`nojkompetentnostiinformacionno-tehnicheskisredstvbudushhihuchitelejcherchenija. *Aktual`najanauka*, (4), 112-115.
8. Holmurzaev, A. A., Alizhonov, O. I., Madaminov, Zh. Z., &Karimov, R. H. (2019). Jeffektivnyesredstvasozdaniyaobuchajyshhihprogrammopredmetu «nachertatel`najageometrija». *Problemysovremennojнауки i obrazovanija*, (12-1 (145)).
9. Rustamova, M. M., Oxunjonov, Z. N., &Madaminov, J. Z. (2020). Use of graphics computer software in the study of the subject "Drawing and engineering graphics". *ACADEMICIA: An International Multidisciplinary Research Journal*, 10(5), 83-86.
10. Madaminov J. Z. (2020). Methods of developing students' design competencies in the discipline "Engineering and computer graphics". *ACADEMICIA: An International Multidisciplinary Research Journal*, 10(5), 66-71.
11. Xusanboev, A. M., Umarova.,&Abdullayeva, D. T. (2020). The rectification of curve flat arch. *ACADEMICIA: An International Multidisciplinary Research Journal*, 10(5), 62-65.
12. Kholmurzaev, A. A., IsakovichAlijonov, O. I., &Madaminov, J. Z. (2020). Effective tools and solutions for teaching — "Drawing-geometry and engineering graphics". *ACADEMICIA: An International Multidisciplinary Research Journal*, 10(5), 58-61.
13. Valikhonov, D., &Arziev, S. (2020). Using gaming technologies in engineering graphics lessons. *ACADEMICIA: An International Multidisciplinary Research Journal*, 10(5), 95-99.
14. Kholmurzaev, A. A., Polotov, K. K., &Toxirov, I. X. (2020). Methods of using media education inthe learning process. *ISJ Theoretical & Applied Science*, 05 (85), 205-208.
15. Polotov, K. K., &Toxirov, I. X. (2020). Features of teaching engineering and computer graphics. *ISJ Theoretical & Applied Science*, 06 (86), 573-576.

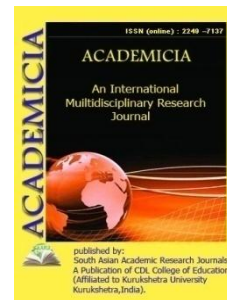

DOI: **10.5958/2249-7137.2021.01068.5**

## DETAILED DESCRIPTION OF LEXICAL ITEMS IN “STRONG ARGUMENT”

**Nurullaeva Zarina Hasanovna\***

\*Teacher of SSU,  
UZBEKISTAN

---

### ABSTRACT

*The article provides useful theoretical information on the appropriateness of the use of the term interpretation to express the meaning of words in lexicography, and explains the two principles of word interpretation with examples from ancient and modern dictionaries. There is also a detailed interpretation of lexical words in "Burhoni Qote" in comparison with "Ghiyas-ul-lugat".*

**KEYWORDS:** *Culture, Philological Cultures, Commentary, Terminology, Sema, Free Expressions, Phraseological Expressions.*

---

### INTRODUCTION

In interpretive cultures, the interpretation of lexical units (words and structures) is one of the most important and topical issues of lexicography, because the primary task of cultural studies is the interpretation of words and phrases to be explained. For complete and complete coverage of the lexical structure of the language, the fund of card indexes-separate sheets, with examples from the existing written literature, plays an important role. Without addressing these issues, it is impossible to compile modern explanatory dictionaries: to define the semantic boundaries of words and their semantic nuances, to reveal the meaning of artificial and complex words, to explain free and phraseological expressions, and finally to identify different ways of interpreting words, which the lexicographer deals with.

Today in the Tajik literary language the term of interpretation is used to express the meaning of words in lexicography, which, in our opinion, is more appropriate in all respects. In recent years, a number of works and articles have been written by scholars of the former fraternal republics and foreign scholars to clarify such important and topical issues of lexicography and lexicology. These works and articles are interesting in every way and are undoubtedly used as a theoretical guide for lexicography. For example, in the introductory part of his article A.P. Evgenyeva addresses the issue of clarifying the meaning of words, noting that in lexicography the terms

"definition", "explanation", "interpretation" are used. Among these terms, he prefers to use the term "commentary" as a lexicographical term, as "definition" and "explanation" have other meanings as well.

In Russian and foreign lexicography there are basically two principles in the interpretation of the meaning of words. One is that well-known words are not interpreted; only their semantic nuances and underused and rare words are interpreted. Another is that all words, including those that people have learned since childhood, are included in dictionaries and interpreted. Dictionaries that take into account the first trend in interpretation are designed for a certain range of readers: feel the nuances of it and are able to practice analyzing the semantic nuances of words.

If we look at the history of Tajik and Persian culture from the first point of view, we can see its components in some of our ancient dictionaries. For example, in "Burhani Qote" and "Ghiyas-ul-Lughat" the words are not given common meanings, but are satisfied only with the words "well-known" and "famous". In these cultures the figurative and homonymous meanings of words are more recorded. Here are a few examples:

Otash//otish آتش ma'ruf ast; va ba arabi nor xonand...BQ. I , 41.

Ob آب ma'ruf ast ... BQ. I, 34; ser - سير ma'ruf ast, ki naqizi gurusna boshad: BQ. II, 188.

Fire // fire آتش is popular; and read in Arabic ... I, 41. Water is popular ... I, 34; Sir - Sir is known to be a hungry rapper: BQ. II, 188.

Sol سال -bar vazni mol; ma'ruf ast. BQ. II, 135.

SHab شب -ma'ruf ast ba arabi layl xonand... BQ. II, 204.

SHona شانه - bar vazni chona; ma'ruf ast... BQ. II, 199.

Xar خر hayvoni ma'ruf. G'l. II, 299.

Simurg' سيمرغ - qonvarest mashhur ... G'l. I, 447.

ear by year - by weight of goods; is popular. Software. II, 135. Shab شب is popularly known as Layl in Arabic ... II, 204. Comb شانه - on the weight of the comb; is known... Software. II, 199. Every famous animal. Gl. II, 299. Simurgh Simurgh is a famous animal ... I, 447.

The task of lexicography is to reflect the lexical structure of a given language, and all words and structures must be included. In the commentary cultures, the lexical structure of the language of a certain historical period should be collected in a certain order and interpreted with examples from the literature and the written press.

Explanatory dictionaries mainly explain the original and figurative meanings of words, and they completely or partially lose their meaning in the composition of phraseological units. In the culture of "Burhoni Qote" the style of detailed interpretation plays an important role and it is based on the principle of the author's work. At the same time, these lexical articles can be seen, in which the nature of encyclopedic dictionaries is clearly seen. Authors of earlier cultures, in particular, "Burhoni Qote" and "Ghiyas-ul-Lughat" in lexical articles sometimes go beyond philological culture and bring some different myths and legends and prose and verse fragments, which have a kind of logical connection with the meaning of the key word. They bring some

customs and traditions that are related to the meaning of the same word and have an ethnographic character and express the customs of the peoples of India, Iran and Central Asia.

In the detailed interpretation of words and phrases, their original meanings and figurative meanings are written in detail, and a witness must be brought to confirm them. However, Burhan does not provide an example to confirm the meaning of this or that explanatory word, and as the author points out in the introduction, most of the sources he uses are reference dictionaries. Here are a few examples to illustrate the point:

Dand دند bar vazni chand; ustuxoni pahlu boshad; va darvesh va miskin va bechoraro niz go'yand; va ba ma'nii ablah va nodon; va bebok; va xudkom ast va duzd va bediyonatro niz guftaand; va afzore boshad qo'lohagonro –va on cho`best dandona –dandona ba arzi porcha, ki mebofand va az har dandonai on tore meguzaronand; va ba ma'nii dandon ham omadaast, ki ba arabi sinn xonand; va har chize nafis, ki dahonro biyafshurad, monandi mozu va po`sti anor va amsoli on; va xirva'i chiniro niz go'yand va onro habbulxatoi va habbussalotin xonand; bidon, ki on mushili rutubot boshad; va nomi giyohe ham hast; va qisme az gadoyon boshand, ki shoxi go'sfande bar yak dast va shonai go'sfande bar dasti digar girifta bar dari xona va peshi dukkoni mardumon oyand va shoxro bad-on shona ba unvone bikashand, ki az on sadoi g'aribe baroyad va chize talab kunand. Agar ahyonon dar dodan ehmoie voqe' shavad, ba kord a'zoi xudro maqro`h sozand va shoxshona in ma'ni dorad... BQ.II,39.

Dand دند on the weight of a few; lateral bones; and the poor and the needy and the needy; and in the sense of foolish and ignorant; and childless; and the thief, and the ungodly. and as for a piece of wood, which is a piece of wood, it is woven into a piece of cloth, and a net is passed through each tooth. and also means tooth, to read in Arabic age; and all that is sweet to the mouth, such as the skin of a pomegranate, and the like thereof; and they shall also call the Chinese khirwa, and shall call it habbulxatoi and habbussalotin; know that it is a moisturizer; and there is also the name of the plant; and some of the beggars, having a sheep's horn in one hand and a sheep's comb in the other, come to the door of the house and to the store of the people, and draw the horn to the comb in the name of a strange voice, and demand something. If there is a rare case of giving, they will injure their limbs with a knife, and royal means this ... BK.II, 39.

In the Tajik Language Dictionary, the word "dand" is interpreted as follows: Dand I دند 1. stupid, idiot, ignorant.

And there was a great uproar in this city.

Everyone is stupid and ignorant.

Andar in shahr base nokas barxostaand,  
Hama xartab'u hama ahmaqu bedonishu dand.

Labibi

2. a thief; atheism Read it when the jeweler, Neighbors also have a few bodies. duzd; bediyonat:

Bixond on gahe zargari dandro,  
Zi hamsoyagon ham tane chandro.

Abushakuri of Balkh

3. Something that makes a person's mouth sting and squeezes, such as pomegranate peel, etc. Take the sugar out of him, get rid of the poison, Whatever is best for your soul in the end, it is pleasing.

Chize, ki dahani insonro qoq mekunad va meafshurad, az qabili po`sti anor.

Qand ҷudo kun az vay, dur shav az zahri dand,

Har chi ba oxir beh ast ҷoni turo, on pisand!

Rudaki

Dand II دند see. tooth. FZT.I. 321. In the "Interpretive Dictionary of the Tajik language" "dand" is described as follows:

Dand I bookish. stupid, foolish, ignorant. 2. the thief. 3. something that dries and squeezes a person's mouth; toothpick (such as raw dates).

Dand II bookish. a grain of unripe Chinese fruit, which resembles a pistachio and has medicinal properties. FTZT.I, 421.

This word (dand) is also mentioned in the "Culture of Hope" and its initial homonymous meaning corresponds to the superstitious cultures, but its II meaning is more detailed:

Dand is the fruit of a tree, the size of a small pistachio, all three of which are in a shell and initially green and then yellow or black in color. it grows in China and India, the leaves are similar to eggplant leaves and the flowers are yellow and reach a height of three meters. FA.490-491. If we divide the word "dand" according to modern culture in terms of meaning, such a division can be made. Dand I. 1.Kit.stupid, stupid; ignorant; 2. a thief; atheism.

Dand II. 1. دند lateral bone, rib; 2. Some beggars take a sheep's horn in one hand and a sheep's comb in the other and come to the door of the house of the people and pull the horn on the comb in the name of a strange sound and demand something. If it is seldom given, the knife is used to injure the limbs, and royal means this. Dand III. 1. A tool made by weavers and it is a piece of wood with a toothpick that weaves and passes a net through each tooth. 2. The teeth and say in Arabic age. Dand IV everything that a human mouth can swallow, like pomegranate peel and raw dates. Dand V is a small Chinese dentist; medicinal plant.

In the explanation of this word in "Farhangi Amid" and "Burhoni Qote" there are components of encyclopedic interpretation.

They are separated by proximity and homonymy. Let's look at another issue:

Rang رنگ bar vazni sang; chand ma'ni dorad:1.ma'ruf ast va ba arabi lavn go'yand. 2.Hissa va qismat va nasib buvad; 3.Aybu orro go'yand; 4. Mehnat va ozor va ranç boshad; 5.Zo`r va quvvat va tuvonoj; 6. Ro`h va ҷonro go'yand; 7. SHuture qavi, ki az bahri natoç nigoh dorand; 8.Molu zar va asbobro go'yand; 9.Naf` va foida boshad; 10. Jandae, ki darveshon po`shand; 11.Tarz va ravish va sirat va qoida va qonun boshad; 12.Misl va monand va nazir va shabehro go'yand; 13. Naxçir va buzi ko`hi va govi dashti; 14. Makr va hilla va dag`o; 15. Rustan va ro`idan boshad, chi xudrang va ma'nii xudro` va rangidan ba ma'nii ro`idan boshad; 16. Xubi va latofat; 17. Xushi va xushholi va tandurusti; 18. Xiçolat va sharmandagi; 19. Xunro go'yand va on ba arabi dam xonand; 20. Rivoç va ravnaqi kor; 21. Moyai andak va qalil; 22. Zaru simi duzdi; 23. Qimor va hosili qimor; 24. Xudovand va voli va sohib; 25. Badro go'yand, ki naqizi

xub ast; 26. SHaxsi ahvalro go`yand; 27. Kinoya az axz va qar boshad; chunonki kase az kase tama` va tavaqqo`e dorad. Go`yad "range ba ro` nadori", ya`ne axzu qare nametavon kard; 28. Xole va nuqtai siyohe, ki bar qoe guzorand; 29 shirinxori, ya`ne masdari fe`li xub shudan; 30. qalochili doyra; 31. Xashmi bo xiqolat omexta 32. SHarmu hayo; 33. Norosti va xiyonat. BQ.II, 74-75.

Color رنگ on the weight of the stone; It has several meanings:

1. It is well-known and is called Lawn in Arabic. 2. To have a share and a share and a share; 3. Blame it; 4. Labor and harassment and suffering; 5. Strength and power and might; 6. Say the spirit and the soul; 7. A strong camel that protects from the sea; 8. Say goods and gold; 9. Benefit and benefit; 10. The one who covers the poor; 11. The manner and manner of life and the rules and the law; 12. Say the like, and the like, and the like. 13. Nahjir and mountain goat and steppe cow; 14. Deceit and trickery and deceit; 15. Growth and growth, what is self-color and the meaning of self and coloring is the meaning of growth; 16. Goodness and grace; 17. Happiness and happiness and health; 18. Embarrassment and shame; 19. Say the blood and recite it in Arabic; 20. Development and prosperity of work; 21. Small and thick milk; 22. Stealing wires; 23. Gambling and gambling yields; 24. The Lord and Guardian and Lord; 25. They say evil is good. 26. Tell the person the situation; 27. An allusion to the ahz and the jar. as one desires and desires from another. It says, "You have no color," that is, you can't do anything; 28. A black dot and a dot. 29 sweetness, that is, the infinitive of being a good verb; 30. the circle of the circle; 31. Anger mixed with embarrassment 32. Shame; 33. Injustice and betrayal. BK.II, 74-75.

When the reader has more than 33 meanings of the word "color", he is convinced that the text is used to confirm these meanings.

The following meanings of this word are mentioned in phraseology:

Rang I. گنر 1.gun; heat. The mother was separated from the male peacock, To each mouse over clean another color. Rang I. رنگ 1.gun, lavn; tobish.

Zi modar qudo shud chu tovusi nar,

Ba har mo`sh bar toza range digar.

Ferdowsi.

2. refreshing, water-resistant: Not many come to this house, That's the color of spring. tarovat, obu tob:

Base barnayomad bar in ro`zgor,

Ki rang andaromad ba xurram bahor.

Ferdowsi.

3. tricks:

It's all about his return, Sharang is drunk and his face is yellow. hilla, makr, tazvin:

Hama ba tunbalu rang ast bozgashtani o` ,

SHarang no`shomeg` astu ro`y zarandud.

Rudaki



4. benefit, interest, fortune, court, profit:

When I saw the flowers, they had no color. After all, I was satisfied with the smell. manfiat, bahra, nasib, sud, foida:

CHun az visoli on gul didam, ki nest range,  
Oxir ba sad zarurat qone' shudam ba bo`yash.

Hiloli.

5. style, procedure, approach, rule: I don't know why the color isn't familiar, Black-eyed peas? tarz, tartib, ravish, qoida:

Nadonam az chi sabab rangi oshnoi nest,  
Sahiqadoni siyahchashmi mohsimoro?

Hafiz.

6. gold: My long red night I got to dust, The wine melts like a dye. Manuchehr. zar, tillo:

Shabe daroz man surx man girifta ba chang,  
Mae ba soni aqiqu gudoxta chun rang.

Color II رنگ mountain goat color. FZT, II, 119.

In the "Interpretive Dictionary of the Tajik language" the word "color I" has the following meanings: 1. The appearance of anything that catches the eye of the viewer white, red, green, etc. looks like; 2. Mineral, chemical, and herbal dyes mixed with oil to give things a different color; 3. Black for writing; 4. Shape, type. 5. Style, approach. FTZT.II, 147.

In the "Culture of Hope", color is described as follows: what appears and can be seen from the appearance of green and red and yellow and black and its appearance. It also means deceit and trickery and judgment and benefit, suffering and hard work, and it also means hirqa and mountain goat and camel, which are kept for the birth of a child. FA, 535.

From these comparisons it can be concluded that some authors do not agree on defining the semantic boundaries of words. From the materials "FZT", "FTZT", "FA" it can be concluded that the word "color" has 5-6 meanings, and through this word a number of free and stable phrases are formed. We do not comment on the meaning of the word "color", as Burhan 33 has shown, but it is not easy to say what such a word means and to name them one by one. We are sure that "Farhangi Jahangiri", "Latoif-ul-Lughat" and "Burhoni Qote", which the author of "Ghiyas-ul-Lughat" gives in the explanation of this word, and even he mentions some superfluous meanings in this word. Therefore, the text (document) has a special place in the commentary cultures. Since the Interpretive Dictionary of the Tajik Language (Vol. 1, 2008; Vol. II, 2015) does not provide examples to confirm the meaning of a word or phrase, the Rudaki Institute of Language and Literature of the Academy of Sciences of Tajikistan decided to promote the full culture of the Tajik language. Hence, defining the semantic boundaries and semantic nuances of words is of particular importance for a lexicographer and requires a comprehensive knowledge of the lexicographer, the ability to "feel" the nuances of language.

From the various texts, especially in polysemantic words, finding the general meaning of words and arranging them requires special attention and hard work. Explaining the meaning of monosemantic words is relatively simple. Glossary dictionaries should not only show the semantic development of words and phrases, but also the popular meanings of words, as cultures are designed not only for philologists, who deal more with the history of the origin and gradual development of word meanings, but also for the general public. . Each word has its own historical course and changes its form and meaning over time. The lexicographer deals with all these meanings of the word and reflects them in the dictionary. From this it follows that the usage of words is determined only in the text. In dictionaries, it is necessary to give a general and usable meaning to a certain system of words.

In dictionaries, the lexical composition of a language in a certain historical period is reflected to some extent. If we look at the previous cultures, we can see that each culture, along with the use of previous cultures, has made a significant contribution to the science of cultural studies. For example, Muhammad Hussain Burhan in “Burhoni Qote”, which is a relatively general dictionary, puts the information about a word into a certain format and in some cases expresses his opinion, especially the words and phrases that are originally Tajik in the culture. recorded. Some lexical items have detailed explanations and include their original and figurative meanings.

In “Burhani Qote” mainly national and quotation vocabulary is explained. The author has tried to explain the meaning of this or that word in the best possible way, using previous dictionaries. However, the dictionary article does not list them all, but the cultures used are mentioned in the introduction.

#### REFERENCES:

1. Arnold K.V. Lexicology of modern English. –Moscow, 1999.
2. Muhammadiev M. On the word and the development of its meaning. –Dushanbe, 1976;
3. Budagov R.A. The history of words in the history of society. –Moscow, 1991.
4. Sharofutdinova K.A. Explain the meaning of words in a bilingual dictionary. - Tashkent, 1968;
5. The problem of interpretation of words in philological dictionaries. AN Latvin Publishing House, Riga, 1963 (hereinafter: "The problem of interpretation.")
6. Raufov H. "World Culture" as a source of Tajik and Persian lexicography. - Dushanbe, 1973.
7. Evgenyeva A.P. Definition in interpretive dictionaries. The problem of interpretation in philological dictionaries. AN Publishing House of Latvia; Riga, 1963, p.9.
8. Vohidov A. Persian-Tajik culture in the X-XIX centuries. Samarkand 2018. p.28-46.
9. “The definitive proof” of Muhammad Husayn bin Khalaf of Tabriz, according to Muhammad Mu'in, first, Tehran, 1360 AH, p.87.
10. Muhammad Ghiyosiddin Ghiyos-ul-lugat, edited by Amon Nurov, Dushanbe, “Adib” 1987.



**ACADEMICIA**  
**An International**  
**Multidisciplinary**  
**Research Journal**  
 (Double Blind Refereed & Peer Reviewed Journal)



**DOI: 10.5958/2249-7137.2021.01069.7**

**EVALUATION OF THE EFFECTIVENESS OF NEUROPROTECTIVE  
 THERAPY ON RETINAL MORPHOMETRIC PARAMETERS IN  
 PRIMARY OPEN-ANGLE GLAUCOMA**

**Karimova M.Kh\*; Abulkasimova Kh.Kh\*\***

\*Republican Specialized center of eye microsurgery,  
 Tashkent, UZBEKISTAN

\*\*Central Polyclinic Of JSC "Uzbekiston Temir Yullari",  
 Tashkent, UZBEKISTAN

**ABSTRACT**

*Neuroprotective therapy refers to measures preventing damage to neurons in the retina and optic nerve. It should be carried out when the damage to the nervous tissue has not yet become irreversible [2, 3, 7, 8]. We examined 60 patients (120 eyes) with POAG I, II and III stages with the duration of glaucoma from 5 to 15 years. IOP was compensated by selective laser trabeculoplasty (SLT) surgery or local hypotensive therapy treated at the Central Polyclinic of JSC "UZBEKISTON TEMIR YULLARI", Tashkent. The patients were divided into 2 groups: group 1 (control) – 30 patients (60 eyes), who received only traditional medication therapy for glaucoma. Group 2 (main) consisted of 30 patients (60 eyes) who received OMK 2 in 1 drop 3 times a day for 1 month along with traditional medical treatment. All patients underwent the following ophthalmic examination methods with OCT, which was carried out on the device "3D OCT-1" by "Maestro 2". In this study, structural and functional progression in the control group was accompanied by a decrease in the thickness of the RNFL, GCC and the volume of the NRR. In the main group, these parameters were stable during the observation period or had a positive trend, which indicates the neuroretinoprotective effect of OMK 2. Thus, the use of OMK 2 allows improving the functional characteristics in patients with POAG. The positive effect is presumably associated with IOP control and neuroprotective properties of the medicine.*

**KEYWORDS:** Primary Open-Angle Glaucoma, Neuroprotective Therapy, Optical Coherence Tomography, Citicoline (CDP-Choline).

## INTRODUCTION

Primary open-angle glaucoma (POAG) is a chronic, progressive optical neuropathy in which morphological parameters in the optic nerve head and nerve fiber layer change in the form of retinal ganglion cell apoptosis and narrowing of the visual fields (European Guidelines for Glaucoma) in the absence of other eye diseases and congenital anomalies [6,8].

Apoptosis is a naturally regulated, ongoing, genetically programmed physiological process in which the death of single cells is observed, and then they are phagocytosed with the help of macrophages [2,3,15]. In pathological conditions, cells may die or as a result of necrosis – when a large amount of cells die under the influence of the violent actions of damaging (pathogenic) factors [4,8].

Neuroprotective therapy refers to measures preventing damage to neurons in the retina and optic nerve. It should be carried out when the damage to the nervous tissue has not yet become irreversible [2, 3, 7, 8].

To date, the choice of the optimal metabolic drug [5,15] for the treatment of glaucomatous optic neuropathy (GON), which should affect cell metabolism and ionic homeostasis, as well as have membrane stabilizing and antiapoptotic effects [8,9,10], remains relevant. A number of foreign studies show [11,13] a positive effect of citicoline (CDP-choline) on GON, by activating the biosynthesis of structural phospholipids of neuronal membranes, thereby increasing the synthesis of phosphatidylcholine and cerebral metabolism [14,18].

To ensure early detection of GON, as well as to assess the dynamics of glaucoma treatment, an incomparable role is played by one of the objective diagnostic methods of research – optical coherence tomography (OCT), which assesses the state of the optic nerve head (ONH) (optic nerve disc (OND)) and the retinal nerve fiber layer (RNFL)) [12,16].

This method makes it possible to estimate the magnitude and depth of the light signal, as well as to detect RNFL defects in the zones corresponding to changes in the visual fields using a beam of coherent infrared (IR) radiation with a wavelength of 820 nm, reflected from tissues of different optical properties, which determines the echo delay of the reflected light waves by measuring the intensity and depth of the signal [1,17]. When a light beam is focused on the target tissue, it is scattered and partially reflected from internal microstructures at different depths [19].

The diagnostic accuracy of measuring the thickness of the nerve fiber layer reaches more than 90% with a specificity of the study of 90%, therefore, the measurement of the thickness of the nerve fiber layer is mandatory when performing OCT for diagnostic purposes if glaucoma is suspected, as well as when observing patients with glaucoma. Theoretically, the thickness of the retinal nerve fiber layer, to a greater extent than the neuroretinal rim, reflects the state of the ganglion cells, since the volume of the latter, in addition to the nerve fibers, is largely filled by connective tissue and glial cells [1,19].

### Objective

To evaluate the effectiveness of citicoline on optic nerve (ON) morphometric parameters in POAG with a stabilized level of intraocular pressure (IOP) using the OCT method.

## MATERIALS AND METHODS

We examined 60 patients (120 eyes) with POAG I, II and III stages with the duration of glaucoma from 5 to 15 years. IOP was compensated by selective laser trabeculoplasty (SLT) surgery or local hypotensive therapy treated at the Central Polyclinic of JSC "UZBEKISTON TEMIR YULLARI", Tashkent.

The age of the patients ranged from 40 to 85 years. As the stage of the disease increased (stages II and III), the patients of more advanced age (over 60 years) were more frequent. The average age of the patients was  $69.7 \pm 5.3$  years.

*Figure 1: Distribution of patients with POAG by age*

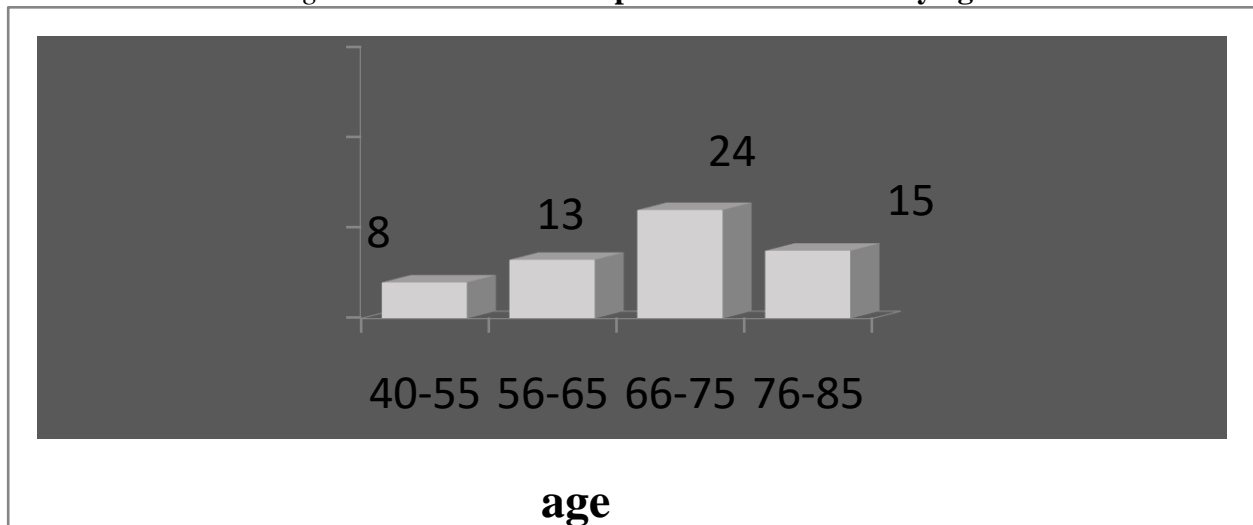

*Figure 2: Distribution of patients with POAG in the study groups depending on the stage of the disease*

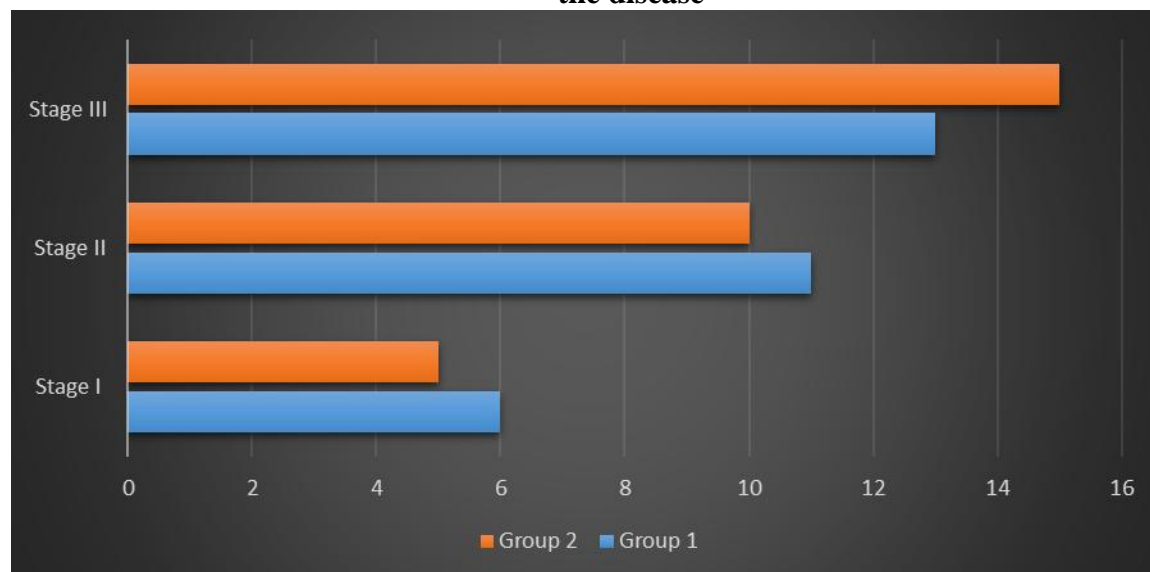

The patients were divided into 2 groups depending on the type of treatment: group 1 (control) – 30 patients (60 eyes), who received only traditional medication therapy for glaucoma in a day hospital: 1% emoxipin solution at a dose of 0.5 ml 10 days (parabulbarly); 10% solution of piracetam at a dose of 5.0 ml (intravenously); 5% solution of pyridoxine hydrochloride at a dose of 1.0 ml, 5% solution of ascorbic acid at a dose of 2.0 ml intramuscularly for 10 days; cyanocobalamin 100 mg/day (intramuscularly), and cavinton 1 tab. 3 times a day, aevit 1 dragee 3 times a day for 1 month.

Group 2 (main) consisted of 30 patients (60 eyes) who received OMK 2 in 1 drop 3 times a day for 1 month along with traditional medical treatment. All patients underwent the following ophthalmic examination methods: visiometry with correction, perimetry, biomicroscopy, gonioscopy, ophthalmoscopy, tonometry, tonography according to A.P. Nesterov, also OCT, which was carried out on the device "3D OCT-1" by "Maestro 2".

Optic disc scanning was performed using the Optical Disc scanning protocol. The Optic Nerve Head analysis protocol is applied to this protocol. This program allows to determine the size of the optic nerve head, its excavation, parameters of the neuroretinal rim (NRR, rim volume), the ratio of the dimensions of the excavation and the disc, the average width of the nerve in the disc area and other parameters necessary for the diagnosis of glaucoma.

Statistical processing of the obtained results was performed by using standard methods of variation statistics with the use of Student's t-test to assess the reliability of differences on the Statgraphics software on an Intel computer, PentiumCore 2 Duo model, using MicrosoftExcel software.

Dynamic observation and control examination with OCT was performed before treatment and 6 months later in the course of therapy.

Dynamic observation and control examination with OCT was performed before treatment and 6 months later in the course of therapy.

## Results

OCT in patients with POAG stages I, II and III was used to assess the state of average NRR volume, dynamics of average retinal nerve fiber layer thickness (RNFL thickness), average thickness of retinal ganglion cell complex (GCC thickness).

The study revealed a decrease in the thickness of the retina in the macular region (Table 1). The analysis of the findings of the retinal ganglion cell complex showed that in both groups there was a thinning of this layer of varying severity depending on the stage of glaucoma.

An identical topography of ganglion cells (GC) layer was detected in both groups: the minimum thickness of the GCC in the foveal and parafoveal zones (from the temporal side, the gradient of the drop towards decreasing was significantly higher), the maximum thickness of the GCC – in perifovea.

The change in the GCC thickness during scanning with the transition from the parafoveal to the perifoveal and foveal zones was smooth. At the same time, in the upper half of the macula, the GCC thickness was significantly higher than in the inferior temporal and inferior nasal regions.

The dynamics of RNFL in the main group with the inclusion of patients was  $82.32 \pm 13.12 \mu\text{m}$ . During 6-month observation there were no significant changes –  $84.33 \pm 14.12 \mu\text{m}$ . In the control group, the RNFL thickness also did not change considerably; before treatment, it was  $81.40 \pm 12.16 \mu\text{m}$ ; after 6 months it became  $81.42 \pm 11.10 \mu\text{m}$ .

Objective registration of the NRR volume did not show any significant progressive reduction of the rim within 6 months of continuation of treatment. The average volume of the NRR in the main group was  $0.09 \pm 0.09 \text{ mm}^3$  before the study, after 6 months of observation it became  $0.11 \pm 0.09 \text{ mm}^3$ .

In the control group, the NRR volume when included in the study was  $0.10 \pm 0.07 \text{ mm}^3$ , and by the end of the six months of observation it became  $0.10 \pm 0.08 \text{ mm}^3$ . As a result of the analysis, no statistically significant changes in the dynamics of NRR were found in the control group.

Analysis of data on the assessment of global loss of volume (GVL) revealed a slight decrease in the GCC thickness in patients in the main group, including the three inner retinal layers that most susceptible to damage in glaucoma, in this group was almost unchanged.

Statistical analysis demonstrated statistically significant stabilization throughout the entire observation period ( $76.56 \pm 2.65 \mu\text{m}$  before treatment, at the end of observation  $77.99 \pm 2.67 \mu\text{m}$ ).

In the control group, GCC thickness remarkably decreased during the course of the study ( $78.57 \pm 1.98 \mu\text{m}$  before treatment, at the end of observation -  $75.65 \pm 2.78 \mu\text{m}$ ).

## CONCLUSION

In this study, structural and functional progression in the control group was accompanied by a decrease in the thickness of the RNFL, GCC and the volume of the NRR. In the main group, these parameters were stable during the observation period or had a positive trend, which indicates the neuroretinoprotective effect of OMK 2.

Including the applications of OMK 2 medications were relatively sensitive GCC parameters, and demonstrated statistically significant stabilization.

Thus, the use of OMK 2 allows improving the functional characteristics in patients with POAG. The positive effect is presumably associated with IOP control and neuroprotective properties of the medicine.

## REFERENCES

1. Abulkasimova Kh.Kh., Karimova M.Kh.. Evaluation of the local antihypertensive drugs effect on the status of the morphometric parameters of the optic nerve and macula in patients with primary open-angle glaucoma/ *Sovremenniye tekhnologii v oftalmologii* No. 3 2019 (in Russian). «Fyodorovskiye chteniya» XVI All-Russian scientific and practical conference with international participation, 10-13 pages. [doi.org/10.25276/2312-4911-2019-3-10-13](https://doi.org/10.25276/2312-4911-2019-3-10-13)
2. Abulkasimova Kh.Kh., Karimova M.Kh., Zakirkhodjayeva M.A. Comparative Analysis Of The Electrophysiological Indicators Of The Optic Nerve In Complex Treatment Of Patients With Primary Open-Angle Glaucoma. *The American Journal of Medical Sciences and*

- Pharmaceutical Research, 2(08), 11-17. (TAJMSPR) SJIF-5.286 DOI-10.37547/TAJMSPR.Volume 2 Issue 8, 2020. ISSN 2689-1026.
3. Abulkasimova Kh.Kh., Karimova M.Kh. Citicoline applications as a complex primary treatment. Uzbek medical journal. №6 2020. DOI <http://dx.doi.org/10.26739/2181-0664-2020-6-3>. 18-22 pages.
  4. Abulkasimova Kh.Kh. Assessment of the effect of nootropic eye drops to peripheral visual field in patients with primary open-angle glaucoma. 38<sup>th</sup> Congress of the EUROPEAN SOCIETY OF CATARACT & REFRACTIVE SURGEONS. Amsterdam 2020.
  5. Kasimova M.S., Madirimov I.R. Evaluation of the neuroprotective effect of combination therapy in patients with primary open-angle glaucoma (POAG). Stomatologiya No.2 (75) 2019, 64-66 pages.
  6. Bikbov M.M., Babushkin A.E., Orenburkina O.I. Current opportunities for the prevention of excessive scarring after antiglaucoma surgeries using antimetabolites. Natsionalniy zhurnal glaukoma. 2019; 18(3):55-60.
  7. E.A. Egorov, V.P. Elichev, V.V. Strakhov, S.YU. Petrov, T.B. Romanova, M.V. Vasina, V.S. Zinina, A.S. Makarova, S.YU. Kazanova, A.V. Yartsev. Structural and functional changes in the retina of patients with primary open-angle glaucoma and compensated intraocular pressure while undergoing retinoprotective therapy. Vestnik Oftalmologii No.3, 2019, 20-30 pages.
  8. Korelina V.E., Chekurova L.V., Lauta V.F. POSSIBILITIES OF NEUROPROTECTION IN GLAUCOMA. Conference Glaucoma: theory and practice. Horizons of neuroprotection. Collection of scientific articles, St. Petersburg 2014. Issue No. 9, 43-47 pages.
  9. Lavinsky F, Wu M, Schuman JS, et al. Can macula and optic nerve head parameters detect glaucoma progression in eyes with advanced circumpapillary retinal nerve fiber layer damage? Ophthalmology 2018; 125:12:1907.
  10. Petrova K., Anguelov B. Diagnostic accuracy of ganglion cell complex parameters in early, moderate advanced glaucoma // Bulgarian forum glaucoma. 2014. V. 4. № 2. P. 53-58.
  11. Ahmad A. Aref, MD, MBA, Anand Bhatt, Ian Conner, MD, PhD and Samuel Asanad, MD. American Academy of ophthalmology. Neuroprotection in Glaucoma. By Ian Conner, MD, PhD on April 22, 2020.
  12. Banegas SA, Anton A, Morilla A, et al. Evaluation of the retinal NFL thickness, the mean deviation, and the visual field index in progressive glaucoma. J Glaucoma 2016; 25:3:e229-e235.
  13. Gandolfi S, Marchini G, Caporossi A, et al. Cytidine 5'-Diphosphocholine (Citicoline): Evidence for a Neuroprotective Role in Glaucoma. Nutrients. 2020; 12(3).
  14. Kaur IP, Smitha R. Penetration enhancers and ocular bioadhesives: two new avenues for ophthalmic drug delivery. Drug Dev Ind Pharm. 2002 Apr; 28(4):353–69. <https://doi.org/10.1081/ddc-120002997> PMID: 12056529.
  15. Kaushik S., Pandav S.S., Ram J. Neuroprotection in glaucoma. J Postgrad Med 2003; 49(1):90–95.



16. Lee WJ, Baek SU, Kim YK, et al. Rates of ganglion cell-inner plexiform layer thinning in normal, open-angle glaucoma and pseudoexfoliation glaucoma eyes: A trend-based analysis. *Investig Ophthalmol Vis Sci* 2019;60:2:599-604.
17. Mori S., Hangai M., Nakanishi H., Kotera Y., Inoue R., Morishita S., Aikawa Y., Hirose F., Ojima T. Measurement by spectral domain optical coherence tomography for glaucoma diagnosis N. Yoshimura Kyoto University. Kyoto, Japan. IOVS. 2008. Suppl. 4651 P. 368–375.
18. Roberti G, Tanga L, Parisi V, et al. A preliminary study of the neuroprotective role of citicoline eye drops in glaucomatous optic neuropathy. *Indian J. Ophthalmol.* 2014; 62:549–553.
19. Xu X, Xiao H, Guo X, et al. Diagnostic ability of macular ganglion cell-inner plexiform layer thickness in glaucoma suspects. *Med (United States)* 2017; 96:51:e9182.

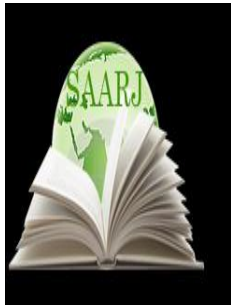

**ACADEMICIA**  
**An International**  
**Multidisciplinary**  
**Research Journal**  
 (Double Blind Refereed & Peer Reviewed Journal)



**DOI: 10.5958/2249-7137.2021.01089.2**

## IMPACT OF DIVIDEND POLICY DETERMINANTS OF LISTED COMPANIES ON INDIAN CAPITAL MARKET

**Ms. Anuriya K.J\* ; Mr. Sreejith P.R\*\* ; Dr. A. Ananth\*\*\***

\*II MBA

Gnanam School of Business,  
 Trichy - Thanjavur Expressway Sengipatti, Thanjavur District,  
 Tamil Nadu, INDIA

\*\*II MBA

Gnanam School of Business Expressway,  
 Trichy - Thanjavur Expressway Sengipatti, Thanjavur District,  
 Tamil Nadu, INDIA

\*\*\*Professor

Gnanam School of Business  
 Trichy - Thanjavur Expressway Sengipatti, Thanjavur District,  
 Tamil Nadu, INDIA

### ABSTRACT

*The core purpose of financial management is the maximization of shareholders' wealth with three core decisions namely, dividend, financing and investment decisions. In simple words dividend is that percentage of net profit of a company which is distributed among the shareholders. The research gap we identified for this study is that, a comparison of different industries dividend policy impact on the Indian Capital Market and the samples drawn from the National stock Exchange (NSE) India. The main objective of this project is to study the influence of dividend policy on the market price of selected company's scrip in NSE. The researcher has chosen Empirical study to prove the hypothesis and 15 companies balance sheet for 10 years (2007-2016) were collected from the respected companies websites and the following ratios have been calculated to test the hypothesis, net profit ratio, gross profit ratio, earning per share, dividend yield, dividend payout ratio, return on equity and the market price of share. The analyses conducted, the parameter estimates are then viewed within AMOS graphics and it displays the standardized parameter estimates. The regression analysis model revealed that the significant impact of the above said independent variables on the market price of share. The*

---

*result shows that there is significant impact of dividend policy variables on the outcome variable market price.*

**KEYWORDS:** *Capital Structure, Shareholders' Equity, Debt, Financial Ratios And Share Price. JEL CLASSIFICATION: G32, G35*

---

## 1. INTRODUCTION

Dividend policy is a guiding principles a company uses to decide how much portion of its earnings it will pay out to shareholders or shows that weather the company go for either to pay dividend to its owners or to retain a share out of profits to plough back in the firm or at the end of each year, company have to decide whether and how much cash they will return to their stockholders in the form of dividends. Mainly there are three types of dividend they are stock dividend which increase the number of share outstanding and generally reduce the price per share. Second, the dividend can be a regular dividend, which is paid in the form of regular intervals (quarterly, semi-annually, or annually). Third one is special dividend, which is paid in addition to the regular dividend.

There are three main dividend policies are using by the companies: residual dividend policy, stability dividend policy and hybrid dividend policy. These policies chosen by them based on their growth opportunities. If the company have great opportunity to grow then they should retain more. For that the company reduce their dividend pay-out rate. The capital market is the place where the company can raise the capital. Same time the investors can invest in the company's capital. Share price is one of the important component that really influence investors to purchase of shares. The share price of the companies will always shows volatility because the impacts of some factors. The dividend policy is the one of the factor that impacts the stock market price of the company. But the real impact on the dividend policy in stock market is still in the controversy. So this study will analyses the real relationship between the dividend policy and stock market price. The variables like net profit ratio, gross profit ratio, earning per share, dividend yield, dividend payout ratio, return on equity and the market price of share are used here for analyzing the impact level.

## 2. LITERATURE REVIEW

Md. Abdullah Al- Hasan<sup>1</sup>, Md. Asaduzzaman and Rashed al Karim<sup>3</sup> (IOSR Journal of Economics and Finance 2013) conducted a study on The Effect of Dividend Policy on Share Price. The study has mainly pointing at evaluating the effect of dividend policy on market price of share in the context of Bangladesh. For the analysis of data they used tools like Dividend policy, Market price per share, Earning per share Correlation and multiple regression models. Finally, it concludes that the findings over the effect of dividend policy on market price supports the relevant theory of dividend policy.

Adnan Ali, Farzand Ali Jan and Ilyas Sharif (Business & Management Studies: An International Journal 2015) were analyzed the effect of dividend policy on stock prices. They analyzed 45 non-financial companies listed on KSE-100 index that have earned profits and paid dividend for a period of twelve year w.e.f. 2001. And they used Profit after tax, Earning per share and Return on Equity are the three control variables. Some of findings of this study were profit retention by

firms will result in a decrease in the value of the stock market prices and dividend pay-out have positive impact on the share prices of respected stocks.

Stephen Bassey Duke, Nneji Ikenna D and Nkamare S.E (Archives of Business Research 2015) conducted a study on Impact of Dividend Policy on Share Price Valuation with respect to Nigerian Banks. The researchers were utilized data on two banks operating in the Nigerian economy, GT Bank and United Bank for Africa. The study found that dividend policy had a positive effect on shareholders wealth. And the right dividend policy helped to the growth of the banks and also the Nigerian economy.

Byson B. Majanga (Accounting and Finance Research 2015) did a study on the topic of The Dividend Effect on Stock Price. The study conducted by the author with refer to the Listed Companies of Malawi. The variables used by the researchers were Stock price, Dividend per share, retention ratio, return on equity, earnings per share and net profit after tax. The study was conducted over the seven years and it shows a positive association between stock prices. The result found that there is a strong positive relationship between a firm's dividends and its stock price on the stock market.

### 2.1 Research Problem:

I M Pandey (11<sup>th</sup> edition of Financial Management) Evaluated dividend policy determinants and its impact on market value of scrip. Many authors says, dividend policy has insignificant impact on the market value of the firm but the dividend policy determined based on the investment opportunities available for the company. The present study aims to find the impact of identified dividend policy determinants on the market price of the firm.

### 2.2 Objective of the Study:

The study is focused on achievement of following objectives:

- To study relationship between dividend policy determinants
- To find the impact of dividend policy determinants on the market price.
- To evaluate the dependency of dividend policy determinants on market price of various industries.

### 2.3 Need and scope of the Study:

The study covers the companies listed in the National Stock Exchange (NSE) and spanned a period from 2007 to 2016 and the data used for the analysis is secondary in nature. The Variables which are used for this project are; Dividend Yield, Retention Ratio, Return on Equity, Dividend Pay-out Ratio, Market Price, Earnings per Share. The study help to control the stock price variance happen because of the dividend policy by using effective dividend policy.

### 3. Research Methodology

The researcher chosen empirical study to test the impact of dividend policy determinants on Indian capital market. The present study involves a sample of 150 balance sheet and profit and loss account from three industries for the period of 2007 to 2016. The variables were empirically tested with the hierarchical regression on the companies from three industry such as **pharmaceutical, Energy, and Media. From each industry taken five companies and thus a total of 15 companies are selected. The companies which include are Sun Pharma, Cipla,**

Glenmark Pharma, Dr.Reddys Laboratory, Lupin, Reliance, Gail,BPCL, ONGC, Tata Power, Network 18, Sun TV, PVR, ZEEL, and TV Today Network. The analyses conducted, the parameter estimates are then viewed within AMOS graphics and it displays the standardized parameter estimates. The regression analysis revealed that how much the factors of dividend policy such as Net Profit Ratio, Gross Profit Ratio, Earnings per share, Dividend yield, Dividend, Dividend pay-out ratio, and Return on equity influence the market price. The estimated p-value of the model can be used to test the hypothesis. If the values are significant at 5% significance level (i.e.) less than 0.05 then the alternate hypothesis are proved to be true, otherwise the null hypothesis is selected.

**4. Analysis:**

In hierarchical regression, the predictor variables are entered in sets of variables according to a pre-determined order that may infer some causal or potentially mediating relationships between the predictors and the dependent variable (Francis, 2003). Such situations are frequently of interest in the social sciences. The logic involved in hypothesizing mediating relationships is that “the independent variable influences the mediator which, in turn, influences the outcome” (Holmbeck, 1997). However, an important pre-condition for examining correlational relationships is that the independent variable is significantly associated with the dependent variable prior to testing any model for mediating variables (Holmbeck, 1997).

**Chart 4.1: Structural Model – (Div-SEM Model)**

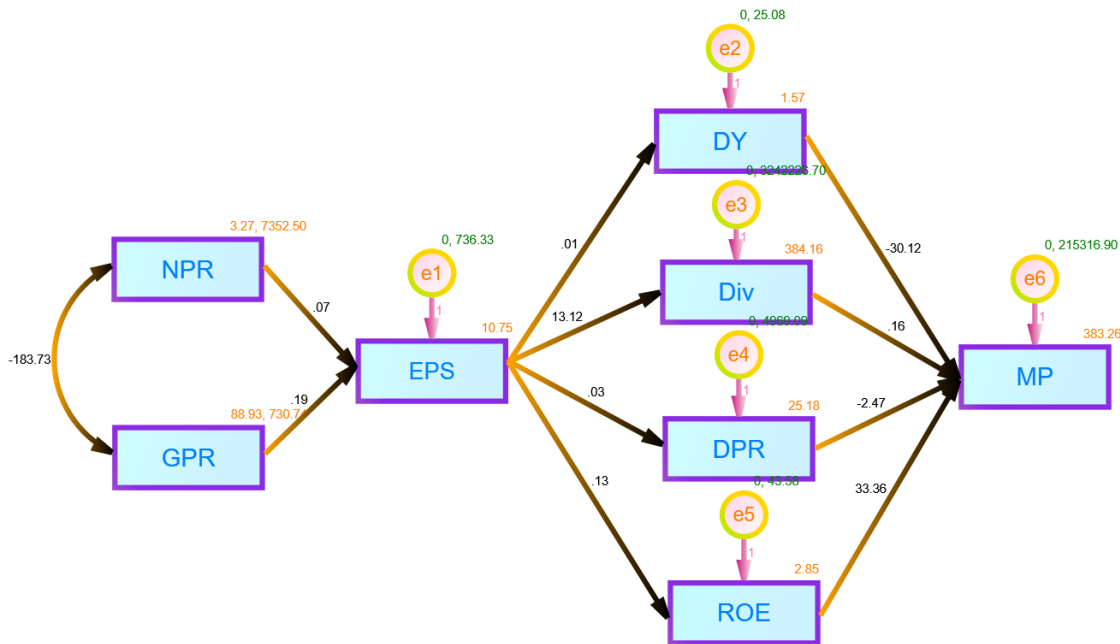

**TABLE: 4.1 REGRESSION WEIGHTS: (DEFAULT MODEL)**

			Estimate	S.E.	C.R.	P	Label
EPS	<---	GPR	.188	.082	2.279	.023	
EPS	<---	NPR	.067	.026	2.559	.010	

			Estimate	S.E.	C.R.	P	Label
DY	<---	EPS	.006	.015	.428	.669	
Div	<---	EPS	13.119	5.248	2.500	.012	
DPR	<---	EPS	.030	.205	.145	.884	
ROE	<---	EPS	.128	.019	6.632	***	
MP	<---	ROE	33.360	5.084	6.562	***	
MP	<---	DPR	-2.470	.539	-4.580	***	
MP	<---	Div	.164	.021	7.917	***	
MP	<---	DY	-30.123	7.588	-3.970	***	

**TABLE 4.2: STANDARDIZED REGRESSION WEIGHTS: (DEFAULT MODEL)**

			Estimate
EPS	<---	NPR	.203
EPS	<---	GPR	.181
DY	<---	EPS	.035
Div	<---	EPS	.201
DPR	<---	EPS	.012
ROE	<---	EPS	.477
MP	<---	DY	-.229
MP	<---	Div	.459
MP	<---	DPR	-.264
MP	<---	ROE	.380

**TABLE 4.3: SQUARED MULTIPLE CORRELATIONS: (DEFAULT MODEL)**

	Estimate
EPS	.068
ROE	.228
DPR	.000
Div	.040
DY	.001
MP	.504

As per the analysis, the P value of the Fig. 4.1., shows the impact level of independent variables on dependent variables. The Gross profit ratio is significant to Earnings per share (.023), Net profit ratio is significant to Earnings per share (.010), Earnings per share is insignificant to

Dividend yield (.669), Earnings per share is significant to Dividend (.012), Earnings per share is insignificant to Dividend pay-out ratio (.884), Earnings per share is highly significant to Return on equity (.000), and the independent variables like Return on equity, Dividend pay-out ratio, Dividend, Dividend Yield ratio is highly significant to Market price (.000), Here the result shows that the dividend highly influence the market price.

The R square value shows that the overall model explaining the market is about 50.4%, the dependent variables such as Net profit ratio and Gross profit ratio is impact the Earnings per share by 6.8% and the other factors impact Earnings per share as per the R square value is, Return on equity by 23%, Dividend by 4% and Dividend pay-out ratio and Dividend yield are very meager.

**TABLE: 4.4: COMPARISON OF INDUSTRY VALUES:**

PATH	Pharma	Energy	Media
EPS < --- NPR	<b>.086</b>	.001	***
EPS < --- GPR	<b>.075</b>	***	<b>.371</b>
Div < --- EPS	<b>.373</b>	<b>.978</b>	***
DY < --- EPS	.039	<b>.098</b>	.002
ROE < --- EPS	***	***	***
DPR < --- EPS	<b>.123</b>	.018	<b>.070</b>
MP < --- Div	***	.018	***
MP < --- DY	***	***	***
MP < --- ROE	<b>.542</b>	***	***
MP < --- DPR	***	<b>.150</b>	<b>.661</b>

The above table shows the comparison of regression analysis of the pharma, Energy, and Media industry. The Dividend and Dividend yield are highly significant to Market price and also the Earnings per share is highly significant to Return on equity with respect to all three industries. In Energy and Media the Net profit ratio is highly significant to Earnings per share, but the pharma is slightly varying (.086). Gross profit ratio to Earnings per share only Energy have the significance and other two industries are shows insignificant. Earnings per share to Dividend, the Media is highly significant and other two are insignificant. Earnings per share to Dividend yield except Energy other two industries are significant and Earnings per share to Dividend pay-out ratio only Energy have significance and other two are insignificant. The Return on equity to Market price, except Pharma other two industries are significant and Dividend pay-out ratio to Market price only Pharma have significance.

### 5. Managerial Implication:

According to our study we found that the investor should consider more on Dividend, Dividend yield, and Return on equity before they invest in securities because these variables are highly significant to Market price. The overall model shows more than 50% R square value which means the dependent variables have a clear impact on Market price. So the investors should consider these variables before they invest in any securities for a better return.

**CONCLUSION:**

As mentioned early the dividend policy is the one of the factor that impacts the market price of the company in Indian Stock market. But the real impact on the dividend policy in stock market is still in the controversy. After this study we analyzed that the Dividend policy have an impact on Market Price.

**REFERENCE:**

1. Md. Abdullah Al- Hasan, Md. Asaduzzaman, Rashed al Karim (4(Sep-Oct) 2013) The Effect of Dividend Policy on Share Price: An Evaluative Study, IOSR Journal of Economics and Finance (IOSR – JEF).
2. Adnan Ali, Farzand Ali Jan, Ilyas Sharif (2015) Effect of Dividend Policy on Stock Prices, Business & Management Studies: An International Journal (BMSIJ).
3. Stephen Bassegy Duke, NnejiIkenna D, Nkamare S.E (February 25, 2015) Impact of Dividend Policy on Share Price Valuation in Nigeria Bank, Archives of Business Research.
4. Dr.Zahra Lashgari<sup>1</sup>, MousaAhmadi (2014) The Impact of Dividend Policy on Stock Price Volatility in the Tehran Stock Exchange, Arabian Journal of Business and Management Vol 3.
5. Dr. Sanjay J. Bhai (2008) Dividend policy behaviour in the Indian capital market: A study of BSE-30 Companies, DIAS TECHNOLOGY REVIEW.
6. S.M. Tariq Zafar, D.S. Chaubey and S.M. Khalid (July 2012) A study on Dividend policy and its impact on the shareholders wealth in selected banking companies in India, International journal of financial management.
7. UpanandaPani, Dividend policy and stock price behaviour in Indian corporate sector: A panel data approach, Research Scholar, Department of Humanities and Social Sciences.
8. Dr.NiharikaMaharshi, Sarika Malik (2015) The impact on Dividend policy on the stock market price of the shares and growth of joint stock companies covered in Sensex, IJISET - International Journal of Innovative Science, Engineering & Technology.
9. Byson B. Majanga (Aug 10, 2015) The Dividend effect on stock price – An empirical analysis of Malawi listed companies, Accounting and Finance Research.
10. Fawaz Khalid Al-Shawawreh (2014) The impact on Dividend policy on share price volatility: Empirical evidence from Jordanian stock market, European Journal of Business and Management.
11. Simon MainaWaithaka, John KaranjaNgugi, Jonah KipkogeiAiyabei, Julius KirimiItunga, and PatrickKirago (2012) Effects of Dividend policy on share price: A case of companies in Nairobi securities exchange, Prime Journal of Business Administration and Management (BAM).
12. Abdullah Al Masum (2014) Dividend policy and its impact on stock price – A study on commercial bank listed in Dhaka stock exchange, Global Disclosure of Economics and Business.



13. Owen Jakata, Philimon Nyamugure (2014) The effects of Dividend policy on share prices: Empirical evidence from the Zimbabwe stock exchange, International Journal of Science and Research (IJSR).
14. Lilian Luvembe, Mungai John Njangiru, Dr. Eddie Simiyu Mungami (Nov 2014) Effect of Dividend payment on Market value of listed banks in Kenya, International Journal of Innovative Research & Development.
15. Hidayat Ullah, Shahab e Saqib, Hazrat Usman (2015) The impact of Dividend policy on stock price volatility: A case of selected firm from textile industry in Pakistan, International Journal of Academic Research in Economics and Management Sciences.
16. Holmbeck (1997) toward terminological, conceptual statistical clarity in the study of mediators and moderators: examples child-clinical and pediatric psychology literatures. Journal of consulting and clinical psychology, 65, 599-610.
17. Francis (2003) Variations in maternal care in the rat as a mediating influence for the effects of environment on development, Physiology and behavior, 74, (2003), 359-371.
18. Stephen A. Ross, Randolph W. Westerfield, Jeffrey Jaffe (2004) Corporate Finance (Page no:- 514-515)
19. Aswath Damodaran (2008) Corporate finance Theory and Practice (Page no: 659-685)
20. I M Pandey (2015) Financial Management (Page no: 440-457)

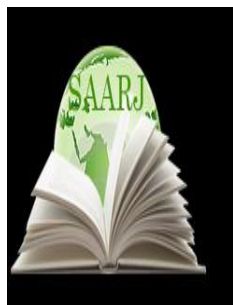

**ACADEMICIA**  
**An International**  
**Multidisciplinary**  
**Research Journal**  
 (Double Blind Refereed & Peer Reviewed Journal)

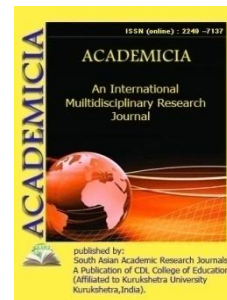

**DOI: 10.5958/2249-7137.2021.01081.8**

## EFFECTIVE STRATEGIES IN TEACHING LISTENING SKILL

**Hikmatova Dildora\* ; Bakhridinova Odina\*\* ; Mavutova Shakhlo\*\*\***

\*Teacher of Academic Lyceum in Karakul,  
 UZBEKISTAN

<sup>2,3</sup>Students of Samarkand State Institute of Foreign Languages,  
 UZBEKISTAN

---

### ABSTRACT

*This article is about strategies of teaching listening skill. And about preparing the learners for listening by setting the scene, introducing the characters, pre-teaching vocabulary, checking the answers to this task, playing the recording again if necessary, making the recording, and the tasks, as 'authentic' as possible.*

**KEYWORDS:** *Recording, Practice, Listeners, LI (Native Speakers)*

---

### INTRODUCTION

One aspect of language which is particularly crucial to listening skills is pronunciation, but this receptive side of pronunciation is still rather neglected in comparison with the productive side. This is perhaps where recordings – recordings of speakers with different accents – in conjunction with transcripts, can be particularly valuable, in providing material for the study of what spoken English actually sounds like: regional variations in vowel sounds, the compression and reduction of unstressed syllables, elision and assimilation, intonation patterns and so on.

There is a lot to be said for these approaches, and they have certainly been very helpful in spreading a concern for supporting the development of learners' listening skills, rather than just testing them. But they should not be accepted unquestioningly, or used to the exclusion of other approaches.

#### **Use plenty of recorded material**

There are certainly plenty of good reasons for using recordings. It is a way of bringing different voices into the classroom: male and female, different ages, different accents, different voice qualities and so on. It means you can present dialogue as well as monologue. If the recording isn't scripted and rehearsed, it means you've got 'authentic' material – see suggestion 7 below. A

recording can be played as many times as you like, and will sound exactly the same every time. These can all be advantages.

But there are also some disadvantages and limitations. In practice, the range of accents on commercially available listening material is fairly narrow. In particular, accents which are close to British and American standard ones predominate, and non-native accents are neglected, which is a serious shortcoming in view of the fact that most learners of English nowadays are more likely to interact with other 'non-native' speakers than with 'natives'. Ideally, listening work in the classroom should try to equip learners with the flexibility to deal with a wide range of accents.

Recordings are particularly suitable for practicing the kind of listening where the listener has no opportunity to interact with the speaker: listening to the radio, listening to public announcements at airports, stations etc., or eavesdropping on strangers' conversations. But this probably only accounts for a small proportion of the listening that most people actually do. More typically, listening happens in the context of interactions such as conversations and meetings, where both (or all) the participants act both as speakers and as listeners, and, in the listener role, have the opportunity to give feedback to the speaker, or to interrupt the speaker to signal understanding, lack of understanding, need for repetition or reformulation, etc.

This suggests it would be helpful to give learners more opportunity to listen to 'live' voices – visitors to the class, if feasible, or, most obviously, the teacher. This, of course, goes against recommendations to 'reduce teacher talking time'. But the teacher's voice is a neglected resource in providing listening practice in which the speaker can continuously monitor the listeners' interest, attention and apparent comprehension, adding any necessary repetitions, reformulations and explanations, and where the listeners can give the speaker signals both non-verbal (e.g. nodding, frowning) and verbal (e.g. "I see", "So, do you mean ....?", "I'm not sure what you mean by ....") – so that the listener is not just a passive, more or less successful, receiver, but understanding is mutually constructed.

Even for the 'eavesdropping' kind of listening, it would probably be more helpful, and more realistic, to make more use of video recordings rather than purely audio ones, since we can usually see people we're listening to – whether we're listening to them 'live' or on film or television. The visual component provides a wealth of information about the setting, the characters and the relationship between them, without which a listener is severely disadvantaged. In fact, by depriving learners of this visual information, we're actually contributing to their feeling that listening is inordinately difficult.

Furthermore, there can be a substantial loss of acoustic information in the processes of recording and, especially, playback, and this can also add considerably to the difficulty of listening. Of course, listeners do sometimes need to deal with less-than-ideal acoustic conditions, but it seems unfair to add too much too soon to the difficult task that learners have to face when they start listening to a foreign language.

**Prepare the learners for listening by setting the scene, introducing the characters, pre-teaching vocabulary etc.**

This makes a lot of sense, particularly because it helps to compensate for the lack of a visual element, and because when we listen, we normally have some prior knowledge, expectations and predictions about what we're going to hear. In other words, it helps listeners to establish a

'schema' which they can use to interpret what they hear. On the other hand, though, there are also occasions when we start listening without the benefit of such a schema, and have to patch together our understanding of what we're listening to as we go along. For instance, we might switch the radio on at random and hear something that sounds kind of interesting, although it isn't immediately apparent exactly what's going on. Or we might ask someone a question and receive an answer so completely at odds with our expectations that we can't immediately interpret what we're being told. It would seem useful to prepare learners to deal with this kind of situation. In the classroom, this might mean letting them listen for a short time without any preparation, then asking questions like "Who / Where are the people?", "What are they talking about?", "What are they doing?", etc., then letting them hear a bit more before asking the same questions again, and so on; the purpose of the questions, then, is to help them piece together their understanding bit by bit, on the basis of the gradually accumulating evidence of what they hear.

**Before the learners listen, set a listening task which directs them to an overall 'gist' understanding of the passage.**

The idea of this is to support and direct learners' listening, and the comments about preparation for listening under 2 above are relevant here. Also, gist understanding doesn't necessarily precede detailed understanding; the 'gist' sometimes only emerges from a prior understanding of details. Teachers often tell learners that they don't have to understand everything, just the main points or the key words, but it could be argued that you sometimes need to understand everything in order to know what the main points or key words are! And in any case learners, as listeners, might find a different interest in listening from what the teacher or materials writer thinks is the 'gist'.

**Check the answers to this task, playing the recording again if necessary.**

Re-playing a recording – perhaps several times – is fine as a pedagogic device. But remember that outside the classroom people sometimes only have one opportunity to hear something, and have to be satisfied with whatever understanding they can glean from that single exposure. On other occasions, they can request a repeat listening from a live speaker, but with the expectation that the speaker will not merely repeat, but clarify, paraphrase and simplify.

**Set a further task, or tasks, which direct learners to a more detailed understanding.**

As with any teacher-imposed or materials-imposed task, there is a risk of disrespecting the learners' own motivation and interest in what they're listening to. Very often, they will be able to come up with their own listening tasks – and very often these will be to do with language rather than content (see 7 below).

**Only use the typescript (if there is one!) as a last resort.**

In L1 (first language; native language) listening, it's unusual to read a transcript of what we listen to – whether before, during or after listening. And clearly learners need to gain experience and confidence in listening without the support of the written word. But this is a gradual process, and there's no reason why that process shouldn't include, especially in the early stages:

- listening once, then using a transcript to clarify points of confusion before listening again.
- reading before listening, to establish understanding of content, before listening to what that content actually sounds like.

- reading and listening simultaneously, tracking the relationship between the spoken and written forms of the language.

**Make the recording, and the tasks, as 'authentic' as possible.**

The notion of 'authenticity' is a complex one and has been widely commented on from various points of view. Some points that seem relevant here include the following:

- A recorded (or written) text loses its authenticity when it's exported out of the context in which it was created. For example, a conversation in a restaurant may be authentic for the participants in that conversation, but not for a group of language learners listening to it in a classroom thousands of miles away and years later.

- Authentic recorded material is particularly likely to suffer from poor recording quality.
- Even if the technical quality is fine, it may be too culture-bound for learners, or simply not interesting.
- Even with very careful preparation and unambitious listening tasks, some learners may perceive authentic recordings to be inordinately difficult, and this can have a devastating effect on confidence.
- Tasks that simulate out-of-classroom listening activities may not necessarily seem very relevant or motivating to learners. If you are in Britain or Canada for example, and you are weighing up a number of alternative activities for the coming weekend, then listening to a weather forecast, paying attention to the outlook for your particular region and making plans accordingly is a real listening activity. But if you're in China, you might not feel fully enthusiastic about imagining yourself into that scenario. You might think it is more interesting to listen out for the tense forms and modals used to describe a current weather situation and make predictions; this could actually be a more truly authentic task for someone who's listening as part of the process of learning the language. In other words, it might be more interesting to pay attention to language rather than content.

**REFERENCES**

- Brown, Douglas. 2000. *Teaching by principles an Interactive Approach to Language Pedagogy (second edition)*. California
- Fauziati, Endang. 2015. *Method of Teaching English as a Foreign Language (TEFL)*. Surakarta: Era Pustaka Utama
- Flick, Uwe. 2009. *An Introduction to Qualitative Research*. Singapore: SAGE Publication Asia-Pacific Pte Ltd. Jonathan Marks. *Methodology: new ways to teach listening*
- Lincoln, Y.S., & Guba, E.G. 1985. *Naturalistic Inquiry*. Newbury Park, CA: Sage
- Moore, Kenneth. 2014. *Effective Instructional Strategies (from theory to practice)*. Singapore: SAGE Publication.

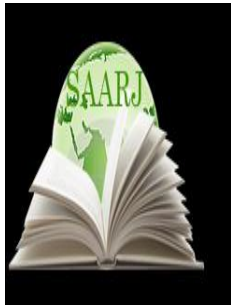

**ACADEMICIA**  
**An International  
 Multidisciplinary  
 Research Journal**  
 (Double Blind Refereed & Peer Reviewed Journal)



DOI: **10.5958/2249-7137.2021.01082.X**

## OWN TORSIONAL VIBRATIONS OF A CYLINDRICAL SHELL IN AN ELASTIC MEDIUM

**Saliyeva Olima Kamalovna\***; **Sharipova Nazira Raxmatilloevna\*\***

\*Associate Professor,  
 Candidate of Technical Sciences,  
 Bukhara engineering and technological Institute Bukhara city,  
 UZBEKISTAN  
 Email id: saliyevaok@mail.ru

\*\*Assistant  
 Bukhara engineering and technological Institute Bukhara city,  
 UZBEKISTAN  
 Email id: shnr\_80@mail.ru

### ABSTRACT

*The article covers that we consider the own axisymmetric torsional vibrations of an infinitely long cylindrical shell in an elastic inertial medium. The dependences of the first shell oscillation frequency in an elastic medium on the dimensionless wavelength are obtained.*

**KEYWORDS:** *Natural Torsional Vibrations, Axisymmetric Vibrations, Cylindrical Shell, Vibration Frequency.*

### INTRODUCTION

Axisymmetric natural torsional vibrations of an infinitely long cylindrical shell in an elastic inertial medium are investigated. The movement of the shell and the mass is described by the dynamic equations of the theory of elasticity.

The equation of motion of the Kirchhoff - Love shell, taking into account the response of the array, can be written in the form.

$$\frac{\partial^2 \vartheta}{\partial x^2} - \frac{P}{G} \frac{\partial^2 \vartheta}{\partial t^2} = \frac{1}{Gh} q_c \quad (1)$$

Taking into account that only shear waves are excited for a torsional load, we obtain the equation of motion of the medium.

$$\frac{\partial^2 u_0}{\partial r^2} - \frac{l}{r} \frac{\partial u_0}{\partial r} - \frac{u_0}{r^2} + \frac{\partial^2 u_0}{\partial x^2} = \frac{P_c}{G_c} \frac{\partial u_0}{\partial t^2} \quad (2)$$

The values of nonzero components of the stress tensor in the medium are determined through tangential displacements by the formulas

$$\sigma_{r0} = G_c \left( \frac{\partial u_0}{\partial r} - \frac{u_0}{r} \right); \quad \sigma_{x0} = G_c \frac{\partial u_0}{\partial x} \quad (3)$$

The boundary conditions of the problem at  $r = R$  have the form

$$u_0 = v, \sigma_{r0} = -q_c; \quad (4)$$

Considering the axisymmetric vibrations of the shell, we find solutions to equations (1) and (2):

$$(\vartheta, u_0, q_c) = \{\vartheta_0, U(r), q_{c0}\} \cos m x e^{-i\omega t} \quad (5)$$

where  $\pi/m$  is the wavelength along the generatrix;  $\omega$  is the circular frequency of natural vibrations.

Substituting expression (5) into (1), we obtain the relationship between the amplitudes of the array reaction, and the displacements of the shell

$$q_{c0} = G x^2 (x^2 \omega^2 - \delta^2) U_0; \quad x = \frac{h}{R}, \quad \delta = mR; \\ \omega^2 = \frac{\rho R^2}{G x^2} \omega^2; \quad U_0 = U_0/h; \quad (6)$$

Dependences (6) allow the boundary condition for the medium at  $r = R$  to be written in the form

$$\sigma_{r0}^0 = -G x^2 (x^2 \omega^2 - \delta^2) U_0 \quad (7)$$

Substituting expression (5) into (2), we obtain

$$\frac{d^2 U_0}{d\bar{r}^2} + \frac{1}{\bar{r}} \frac{dU_0}{d\bar{r}} - \frac{U_0}{\bar{r}^2} - (\delta^2 - \alpha^2) U_0 = 0 \quad (8)$$

$$\text{where } \bar{r} = \frac{r}{R}; \quad U_0 = \frac{U}{h}; \quad \alpha^2 = \frac{x^2 \gamma}{\rho \omega^2}; \quad \gamma = \frac{G}{G_c}; \quad \rho = \rho/\rho_c$$

Solving equations (8) taking into account the condition of damping of oscillations at infinity, we have

$$U_0 = AK_1(\beta r^*); \quad \alpha < \delta; \quad U_0 = A/r; \quad \alpha = \delta; \quad (9a)$$

$$U_0 = AH_1^{(2)}(\bar{\beta} r); \quad \alpha > \delta; \quad (9b)$$

$$\text{Here } \beta = \sqrt{\delta^2 - \alpha^2}; \quad \bar{\beta} = \sqrt{\alpha^2 - \delta^2}$$

$$K_1(x); \quad H_1^{(2)}(x) \text{- Macdonald and Hankel functions.}$$

If we do not take into account the inertia of the medium, then  $\rho_c = 0$  ( $\alpha = 0$ ) and the solution to equation (8) will be the equality

$$U_0 = AK_1(\delta r^*) \quad (10)$$

Substituting solutions (9) into (3) taking into account the boundary condition (7), we obtain the characteristic equation:

$$x\gamma(\delta^2 - x^2\omega^2) + 2 - \bar{\beta} \frac{H_0^{(2)}(\bar{\beta})}{H_1^{(2)}(\bar{\beta})} = 0, \quad \alpha > \delta \quad (11)$$

For  $\alpha < \delta$  in equation (11), instead of the last term, it is necessary to insert with a plus sign the expression  $\frac{\beta K_0(\beta)}{K_1(\beta)}$

The condition  $\alpha = \delta$  is satisfied for  $\rho^* = \gamma + 2/x\delta^2$ .

This case is of no practical interest, since for most materials  $\rho^* < \gamma$ .

Note that the vibration frequency of the shell in vacuum ( $\gamma = \infty$ )

$$\omega^* = \delta/x \quad (12)$$

In a non-inertial environment

$$\omega^2 = (x\gamma\delta^2 + 2 + \delta K_0(\delta)/K_1(\delta))/x^3\gamma \quad (13)$$

For a shell in an inertial medium, the natural vibration frequencies are determined by solving the transcendental equation (11) on a computer.

2. Let us describe the vibrations of the shell by equations of the Timoshenko type. Then for axisymmetric torsional motion we have:

$$\frac{\partial^2 \vartheta}{\partial x^2} - \frac{K^2}{R} \beta - \frac{P}{G} \frac{\partial^2 \vartheta}{\partial t^2} = \frac{1}{Gh} q_c$$

$$\frac{\partial^2 \beta}{\partial x^2} - 12 \frac{k^2}{h^2} \beta - \frac{P}{G} \frac{\partial^2 \beta}{\partial t^2} = \frac{6}{Gh^2} q_c \quad (14)$$

Here  $\beta$  is the angle of rotation of the normal in the tangential direction,  $k_2$  is the Timoshenko coefficient.

The boundary conditions for the medium at  $r = R$  are as follows:

$$u_0 = r + \frac{h}{2}\beta; \sigma_{r0} = -q_c \quad (15)$$

Representing the solution of equations (14) in the form (5), we determine the parameters  $q_c, \alpha_0$  through the displacements  $v_0$

$$q_{c0} = Gx^3 \frac{\alpha_1 \alpha_2}{Gk^2 + x\alpha_1} \bar{\vartheta}_0; \alpha_0 = G\gamma \frac{\alpha_2}{GR^2 + x\alpha_1} \bar{\vartheta}_0$$

$$\alpha_1 = x^2\omega^2 - \delta^2 - 12 \frac{k^2}{x^2}; \alpha_2 = x^2\omega^2 - \delta^2 \quad (16)$$

Taking into account expression (16), we transform the boundary condition for the medium.

$$\text{For } r=1 \quad \sigma_{r0}^2 = -Gx^2 \frac{a_2}{a_3 a_4} U_0$$

$$\text{where } a_3 = 1 + \frac{k^2}{x} \frac{6}{a_1}, \quad a_4 = 1 + \left( \frac{3a_2}{a_1 a_3} \right) \quad (17)$$

Since the solution of the equation of motion of the medium does not depend on the adopted shell model, the further derivation of the equations is similar to that considered above for the



Kirchhoff-Love shell. The choice of the shell model affects only the form of the boundary conditions (17).

Instead of the characteristic equation (11), we write equations of the form:

$$xy^{\frac{\alpha_2}{\alpha_3\alpha_4}} + 2 - \bar{\beta} \frac{H_0^{(2)}(\bar{\beta})}{H_1^{(2)}(\bar{\beta})} = 0 \alpha > \delta \quad (18)$$

For the case  $\rho_c = 0$  ( $\alpha = 0$ ), we obtain the characteristic equation for the Timoshenko shell in an inertial-free medium. At  $G_c = 0$ , we find the frequencies of torsional vibrations of the Timoshenko shell in vacuum

$$\omega_* = \delta/x; \omega_2_* = \frac{1}{x} \sqrt{\delta^2 + 12 \frac{k^2}{x^2}} \quad (19)$$

The first frequency, as for the Kirchhoff-Love shell, corresponds to the rotation of the section like a ring, the second to the form of vibrations caused by the rotation of the normal in the tangential direction.

The first frequency, as for the Kirchhoff-Love shell, corresponds to the rotation of the section like a ring, the second to the form of vibrations caused by the rotation of the normal in the tangential direction.

Putting in equations (11), (18)  $h = 0$  ( $\alpha = 0$ ) and introducing the dimensionless frequency  $\omega^2 = \frac{\rho_c R^2 \omega^2}{G_c}$ , we obtain the characteristic equation for the natural axisymmetric torsional vibrations of an elastic inertial mass with a cylindrical cavity.

$$\bar{\beta}_2 H_0^{(2)}(\bar{\beta}_2) - 2H_1^{(2)}(\bar{\beta}_2) = 0 \quad (20)$$

$$\text{Moreover, } \omega > \delta, \bar{\beta}_2 = \sqrt{\omega^2 - \delta^2}$$

3. Let us obtain the exact solution of the problem for the case when the motion of the shell is described by equation (2). Then the boundary conditions will be as follows:

$$\text{For } r = Ru_\theta^{(1)} = u_\theta; \sigma_{r0}^{(1)} = \sigma_{r0}$$

$$\text{for } r = R - h \sigma_{r0}^{(1)} = 0; \quad (21)$$

Here, index 1 denotes a shell.

We write the general solution of the equations of motion of a cylindrical layer in the form

$$U_0^{(1)} = A_1 K_1(\beta_1 r) + \beta_1 I_1(\beta_1 r); x\omega < \delta;$$

$$U_0^{(1)} = A_1 \frac{1}{r} + \beta_1 r \quad x\omega = \delta;$$

$$U_0^{(1)} = A_1 Y_1(\bar{\beta}_2 r) + \beta_1 J_1(\bar{\beta}_2 r); \quad x\omega > \delta; \quad (22)$$

Where  $\beta_1 = \sqrt{\delta^2 - \omega^2}$ ;  $\bar{\beta}_2 = \sqrt{\omega^2 - \delta^2}$

$J_1(x)$ ,  $Y_1(x)$  are the Bessel functions of the first and second kind.

Substituting expression (22), (9) into (3) and satisfying boundary conditions (21), we obtain the characteristic equation

$$\det \|a_{ij}\| = 0, \quad i, j = 1, 2, 3 \quad (23)$$

Determinant elements:

For  $\sqrt{\frac{\rho}{\gamma}}\delta, \sqrt{\frac{\rho}{\gamma}}\delta < x\omega < \delta, \delta < x\omega$  has a different form.

For example, for the third case:

$$\begin{aligned} a_{11} &= Y_1(\bar{\beta}_1); a_{12} = J_1(\bar{\beta}_1) a_{13} = -H_1^{(2)}(\bar{\beta}_1) \\ a_{21} &= \bar{\beta}_1 Y_0(\bar{\beta}_1) - 2Y_1(\bar{\beta}_1); \quad a_{22} = \bar{\beta}_1 J_0(\bar{\beta}_1) - 2J_1(\bar{\beta}_1) \\ a_{23} &= -\left(\frac{1}{Y}\right) \left(\bar{\beta} H_0^{(2)}(\bar{\beta})\right) - 2H_1^{(2)}(\bar{\beta}); \quad a_{31} = \bar{\beta}_1 Y_0(\bar{\beta}_1 \varepsilon) - \left(\frac{2}{\varepsilon}\right) Y_1(\bar{\beta}_1 \varepsilon); \\ a_{32} &= \bar{\beta}_1 J_0(\bar{\beta}_1 \varepsilon) - \left(\frac{2}{\varepsilon}\right) J_1(\bar{\beta}_1 \varepsilon); \quad a_{33} = 0; \quad \varepsilon = 1 - x; \end{aligned}$$

4. For all considered types of the equation of motion of the shell, numerical results are obtained. Figure 1 shows the dependence of the dimensionless frequency of torsional vibrations on the relative thickness of the shell. Calculation 1 is carried out for  $\delta=3, \gamma=30, \rho=4, k^2=2/3$ .

Curve 1 corresponds to the first mode of movement, 2-to the second. 3-rd third. The solid line marks the shell in the inertial mass, the dashed line - in the inertial-free medium, and the dotted line - in the vacuum.

Calculations have shown that for the first mode of motion, the results for all three theories practically coincide, and the effect of the medium on the vibration frequency is especially significant for relatively thin shells ( $x < 0.03$ ). If the inertia of the medium is not taken into account, the value of the first frequency is overestimated. The third frequency (the second for the Timoshenko shell) is almost unaffected by the medium. Thus, for a shell with a thickness of  $x < 0.07$ , the obtained frequency values practically coincide with the exact ones.

If the shell motions are described by the equations of the theory of elasticity, a second mode appears (curve 2), associated with the uneven twisting of the cylinder along the thickness, caused by the presence of an elastic mass.

Thus, to determine the first vibration frequency of the shell in an elastic medium, it is necessary to use equations (11), (formula (13) gives overestimated values), for higher vibration frequencies - equation (23).

The dependence of the first vibration frequency of the shell in an elastic medium on the dimensionless wavelength for different relative rigidity of the array is shown in Fig. 2. ( $x = 0.01$ ). For curves

$$1 - \gamma = 120, \quad \rho = 4; \quad 2 - \gamma = 30, \quad \rho = 4; \quad 3 - \gamma = 5, \quad \rho = 1$$

The solid line shows the oscillation frequencies of the shell in the inertial array, the dashed line - inertia-free, the dash-dotted line - in the vacuum. As seen from Fig. 2. with an increase in the rigidity of the array, the error increases, which is introduced without taking into account the inertia of the medium (especially in the region of short waves). Using asymptotic representations

of cylindrical functions, we obtain formulas for the first frequency of natural oscillations in the case of long waves  $\omega^2 = \frac{\bar{\rho}}{x^2\gamma} (a + \sqrt{a^2 + b})$

$$\text{There } a = \frac{64x\gamma\delta^2 + 96 - 9x\bar{\rho}}{128x\bar{\rho}}; b = \frac{9(2+x\gamma\delta^2)}{64x\bar{\rho}}$$

If we do not take into account the inertia of the array  $\bar{\omega}_0^2 = \frac{(x\gamma+1)\delta^2+2}{x^3\gamma}$

Then on  $1.5\delta \leq 1$ , the results by asymptotic formulas practically coincide with the exact solution.

In conclusion, to determine the first vibration frequency of the shell in an elastic medium, it is necessary to use the equation of motion of the Kirchhoff - Love shell; for higher vibration frequencies, the equation of motion of the theory of elasticity.

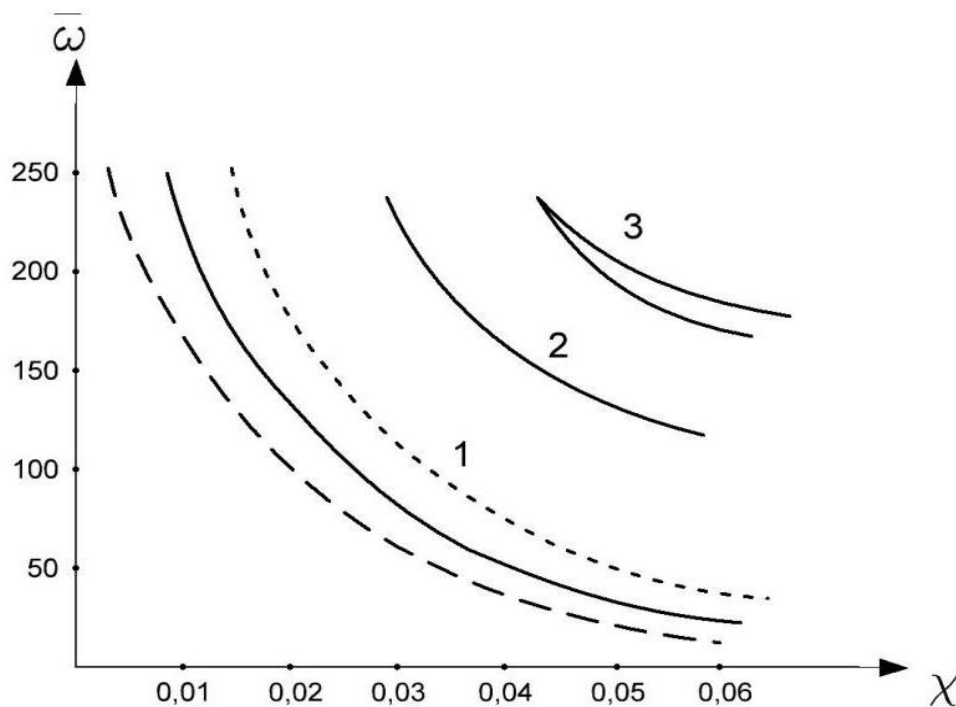

Fig.1. Changes in natural frequencies depending on x.

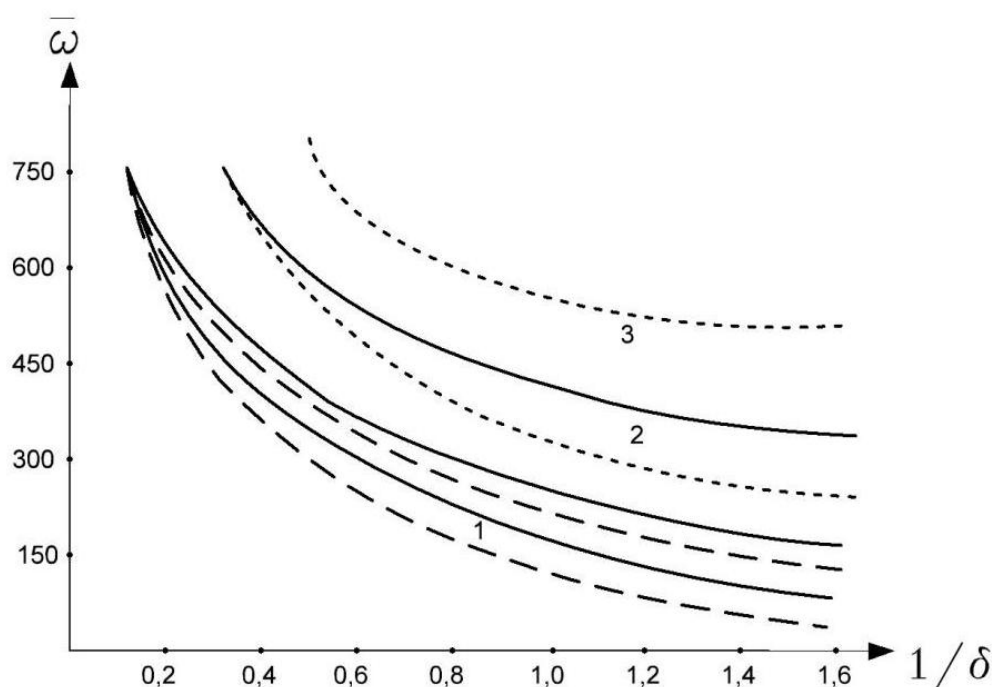
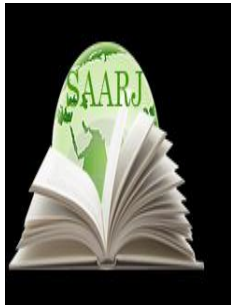

Fig.2. Change of natural frequencies from  $1/\delta$ .

## REFERENCES

1. Сафаров И.И., Ахмедов О., Салиева О.К. Собственные колебания цилиндрических тел, находящиеся в упругой среде. Проблемы внедрения современной техники и технологий в производство. Сборник научных трудов республиканской научно-практической конференции, Джизак, 2007г., стр42-47
2. N.Z.Sharipov, K.KH.Gafurov, M.S.Mizomov, "Soybean seeds from the peel seperating of local growing". International journal for innovative Engineering and Management research, Volume 10, February 2021
3. <https://eprajournals.com/article.php> Qobilov H.X., Abduraxmonov O.R., Abidov K.Z. Creation of new technology of coal briquette manufacturing босма SJIF Impakt Faktor: 7.032EPRA International Journal of MULTIDISCIPLINARY RESERCH (IJMR)01.11.2020 390-393 б
4. Абидов К.З. Создание математических моделей реальных процессов на основе компьютерных технологий. Международная научно-практическая конференция: Реальность – сумма информационных технологий. Курск, 08-10 сентября. 2016г. С. 32-34.



**ACADEMICIA**  
**An International  
 Multidisciplinary  
 Research Journal**  
 (Double Blind Refereed & Peer Reviewed Journal)



**DOI: 10.5958/2249-7137.2021.01083.1**

**THE ROLE OF INTRODUCTORY WORDS AND PHRASES WITH A  
 MODAL MEANING IN THE PROCESS OF STUDYING LITERARY  
 STYLES AND WORKS**

**Baymatova Asal Rustamovna\* ; Ishtukhtayeva Feruza Khurshid qizi\*\* ;  
 Toshmukhamedova Nafisa Shaxobiddin qizi\*\*\* ; Hasanova Sevinch Hotam qizi\*\*\*\* ;  
 Mukhammadieva Shakhzoda Farkhodovna\*\*\*\*\***

<sup>1,5</sup>Students of Samarkand State Institute of Foreign Languages,  
 UZBEKISTAN

**ABSTRACT**

*Introductory are words that are not grammatically related to the members of the sentence, are not members of the sentence and express the attitude of the speaker to the expressed thought, characterizing the way in which it is designed, etc. Introductory words are inherent in the intonation of introductory, expressed in a decrease in voice and their faster pronunciation compared to the rest of the sentence and in a kind of unstressed.*

**KEYWORDS:** *Introductory Words, Modal Meaning, Assessment, Plug-In Constructs, Parenthesis.*

**INTRODUCTION**

Introductory words may refer either to the whole sentence or to individual members.

The speaker's attitude to the content of the statement, his assessment, additional emotional and expressive connotations of the meaning express not only individual words, but also introductory phrases.

By their expressed value, introductory words and combinations are divided into several digits:

The big group is made by the parentheses and phrases with modal value expressing assessment telling degrees of reliability reported (confidence, the assumption, doubt, uncertainty, etc.): of course, undoubtedly, certainly, it is indisputable, obvious, without any doubt probably most likely, as a matter of fact, certainly, needless to say, maybe, probably, perhaps, apparently, it has to be valid, etc.

Assessment of the reported facts in terms of their commonness is expressed by such parenthesis's as: happens, sometimes, as usual, as always, as usual, on custom, etc.

The emotional assessment of the reported is given by introductory words and phrases expressing the feelings of the speaker (joy, pleasure, regret, surprise, indignation, etc.): fortunately, to joy, to pleasure, unfortunately, to unhappiness, to surprise, to amazement, to sadness, to regret, to annoyance, strange deed, uneven hour, which is good, as on purpose.

Parentheses can specify assessment of a measure of what it is reported about (the most bigger, the most smaller, at least, etc.) and also to have other values expressing the relation speaking to the idea introduced by it.

As introductory words, either words specifically intended for this purpose are used (however, please say, therefore, etc.), or words of various parts of speech in cases where they express the above meanings (the overwhelming number of introductory words).

Without being syntactically linked to the members of the sentence, the introductory words nevertheless, in some cases, serve a constructive role and are necessary for the structure of the sentence. For example: He will take a platoon, or maybe a company (Schip). In these cases, the function of introductory words is close to the function of unions (dividing, opposing, joining, etc.).

Thus, the repeating introductory word "may" (possibly) serve to express dividing relations. For example: I do not know where Opanas's bones are buried: maybe under the rakita bush, maybe in the graveyard (Bagr.) (cf. Either... or).

The introductory words "however, opposite," etc., serve to express opposing relations. For example: The weather was windy, the wind, however, was not quite the same (Gonch.) (Wed and the wind...; wind...).

The introductory word "truth" can serve as a concession. For example: True, his lunch consisted of two or three dishes made by a retired soldier, but champagne was poured on the river (P.) (cf. Although... but...).

On morphological expression the parentheses in the vast majority correspond either to names, or to verbs, or to adverbs.

Parentheses of personalized type are expressed:

- a) Nouns (without pretext or with a pretext), for example: the truth, say, undoubtedly, fortunately, on a trouble, according to the legend;
- b) The adjectives (substantivized), for example: generally, by the way, most important;
- c) Pronouns (in combination with a pretext), for example: besides, opposite to that.

Parentheses of adverbial type are correlative with adverbs, for example: possibly, probably, undoubtedly rather is shorter, by the way, at last. Introductory words of the verb type are expressed:

- a) personal forms of the verb, for example: see, imagine, I think, they say, tell (introductory constructions of this type are on the line between introductory words and introductory sentences, since words of the type "I think, we believe" can be considered as single-component certain-

personal sentences, and words of the type say, tell - as single-component indeterminate-personal sentences);

b) Infinitives or infinitive combinations, for example: to see, to confess, by the way, to say the truth;

c) depraptions (in combination with a noun or name), for example: more precisely, to put it mildly, speaking the truth, speaking in conscience.

### **Introductory sentences**

The meanings inherent in introductory words and phrases can be expressed in whole sentences that preserve the intonational features of introductory constructions.

In terms of structure, introductory proposals can be:

Two-part proposals.

Single-component (most often uncertain-personal or impersonal).

Introductory sentences can join the main sentence either without the help of unions (examples see above), or with the help of unions (union words).

### **Plug-in constructs**

Words, phrases and sentences that provide additional information to the main sentence, accompanying comments, clarifications, explanations, amendments, etc.

Like introductory constructions, insert constructions are usually not syntactically related to the main sentence, within which they are even more intonationally isolated by significant pauses characteristic of the so-called inclusion intonation.

Unlike the introductory constructions, the insert constructions do not express the attitude of the speaker to the thought expressed, do not contain an assessment of the message, an indication of its source, communication with other messages, etc. In addition, if the introductory constructions may take place at the beginning, middle and end of the main sentence, then the insertive constructions may be located only at the middle and, less often, at the end of the main sentence, but not at the beginning.

Insert words and phrases in some cases take the form of sentence members.

In other cases, insertion words and phrases are not framed as members of a sentence.

An insert sentence can be combined with the main sentence either without unions, or with the help of unions (compositional or subordinate), as well as allied words.

Insert constructions, on the one hand, are common in oral speech, and on the other, are widely used in the language of fiction.

### **Plug-in constructs**

The plug-in constructs I have encountered can be classified into three main categories:

. Explanation Value

. Date

. The value of the application.

And also:

in the value of the introductory constructions.

Consider everything in order. The largest group is inserted constructs in the meaning of explanation. For example:

He announced that for each killed he would pay twelve thousand dinarii (about five thousand rubles in gold).

"About five thousand rubles in gold" - insert. As we see, it is completely devoid of structural connection with the proposal and has an additional character - explains what was said earlier.

The price per head was really set amazingly high - twenty-five thousand dinarii (about eight thousand rubles).

"About eight thousand rubles" - insert. Again, the meaning of the explanation. There is an adaptation of the text, Zoshchenko seems to confirm that he writes for everyone, simply and understandably, the style of his speech gravitates to the colloquial.

Here he got damn rich (and it was at the beginning of the nep) and, rich, began, of course, to acquire various valuable things, different paintings, carpets, lamps, blankets.

"And it was at the beginning of the nep" - an inset sentence. If in the first two examples the insert constructions were at the end of the sentence, here in the middle. N.S. Valgina writes that "they cannot begin a sentence, unlike introductory words, combinations and sentences." Here also the meaning of the explanation, the author refers us to a certain period to emphasize the reliability of the reported.

And if at the same time (that is, during torture) the convict dies or is injured, or if bleeding or self-harm follows, then this happened through his fault, because he did not want to confess and tell the truth.

"That is, when tortured" - insert. Explanation of the indicative pronoun, giving the author's speech a colloquial character.

The compiler writes about the execution in this style: "The latter (that is, persevering) went with strange pale in their face, with their eyes darkened and, as it were, erupting flames, with the appearance that they seemed obsessed with demons...."

"That is, persevering" - insert. As in the previous example, explains what was written earlier. Not without a structural connection with the proposal, but, rather, even draws closer to its members functionally and syntactically. According to N.S. Valgin, "their specificity consists only in the inset character, in the violation of the syntactic straightforwardness of the sentence."

One Swedish officer who was present at the treasury by a quarter of the traitor Patkul (under Charles XII) shot this criminal.

"Under Charles XII" - insert. Explains the duration of the action reported by the author.

The next group of inserts, at least numerous, are inserts with a date value. For example:



It is curious that the tsarist government appointed a very large amount for the head of the Russian provocateur Degaev (1874).

By the way, there was a famous case when the bandit, speculator and the most shameless adventurer, the Scottish Lowe (1716), who made several million by dark means, was appointed Controller General of Finance in France.

For example, there was such a famous case: the Kaluga governor Lopukhin (1819) for bribes terminated all cases in the province entrusted to him.

He was extradited to the French and shot by them (1810).

History has preserved this infrequently curious document - a letter from P. Tolstoy (dated June 10, 1706).

All of them are additional in nature, give the said shade of reliability. There is no structural connection with the proposals, although they could be revealed in sufficient time/involved turnover. For example:

History has preserved this infrequently curious document - a letter from P. Tolstoy, which was written on June 10, 1706.

History has preserved this infrequently curious document - a letter from P. Tolstoy, written on June 10, 1706.

But at the same time, the meaning of the proposal changes somewhat. Zoshchenko is not so important the time when this letter was written, he simply states this information, tells us the facts for, as already written above, giving credibility.

The third group is inserts in the meaning of the explanatory application.

However, there were bad prices out of hand: If they kill a smerd (peasant) - five hryvnias.

The law was not alien to humane considerations: Who will kill the breadwinner (uncle) - twelve hryvnias.

The Persian king Cambiz (son of the famous Cyrus) proposed to the daughter of the Egyptian pharaoh Amasis II (529 BC).

Poet Leonid Semenov (a friend of Blok) for revolutionary activity was beaten to death by city police.

The worker (weaver) revolutionary Pyotr Alekseev (1849-1891), sentenced to ten years of hard labor, made famous speech at the trial.

In all of them the syntactic link remains. Applications are issued by the author in the form of plug-in designs for creation of effect of a live conversation with the reader. Zoshchenko kind of interrupts himself, seeking to report as much as possible new and interesting to the reader.

Also in the book there are plug-in designs with value introduction, for example:

This high price so worked on imagination of citizens that (the history tells) "murderers hourly entered Sula's house, carrying the chopped-off heads in hands".

"The history tells" - the plug-in offer, value introduction as information source.

And those gala days when it isn't aren't absolutely clear to us (it is ashamed to admit).

"It is ashamed to admit" - a plug-in design, value introduction, points out the expressional nature of a statement.

Having investigated materials of this book, having reviewed various examples, having tried to find out their value, we will try to draw conclusions from everything above-written now.

Plug-in and parenthetical constructions enrich his work, making this story very picturesque and brought closer to real life.

Unlike other writers, Zoshchenko remains faithful in the stories to one functional style, namely colloquial everyday which it peculiar transforms and uses for characteristic not only typical for the era, but also the most this era

In an interview with I. Eventov, the writer reveals the secret of the language of works as follows: "I try to bring language closer to the living speech that I encounter in everyday life. The evening does not pass so that I do not put any word in the notebook, a fragment of the phrase, a street shout, a fragment of the future plot. Then in the manuscript I seam, try to make the speech natural, smooth. "

How do the insertion and introduction structures contribute to this?

By examining this book by writing out examples and classifying them according to the meaning, we can see that, filling work with all kinds of inserts and introductory expressions, Zoshchenko leads a conversation with the reader, supporting the conversation using these constructions, as, for example, here:

And we, sorry, do not believe that now this is not happening at all like it happened before.

In addition, as Kulakovsky notes, "imitation of dialogue with the reader allows you to create a special comic atmosphere of the work."

Using introductory with the meaning of modality gives us the opportunity to feel the author's irony:

Well, of course, love.

The insert constructions also give the text a colloquial character. So you hear live speech, interrupted at times by the author to explain some detail, for example, the time of what is happening:

But once, half a century later (43 BC), when the price for the head accidentally jumped even higher, such a massacre occurred that it seems that the world did not know anything like that.

Reading the book, we have the feeling that we are sitting with the author in the kitchen, and he tells us with the inherent irony of various stories from life over a cup of tea. And just to create the effect of comic, the writer uses introductory and insertion constructions:

And everything else flowed, of course, in the wonderful light of serene existence.

This high price so affected the imagination of citizens that (the story tells) "the killers hourly entered Sulla's house, carrying their heads chopped off in their hands."

With all the seemingly simplicity of the Zoshchenko language, we can see that his work is read easily and with interest, it is saturated, rich in expressions (belonging to the colloquial style). Introductory and insertion constructions help the writer express attitude to the narrative, to make the author feel, his sparkling irony, his lively dialogue with the reader. The use of introductory constructions sometimes where it seems not necessary, also contributes to the creation of a comic effect and a relaxed atmosphere.

### **BIBLIOGRAPHY**

- Brewster, Jean and Dennis Girard. 1992.
- The Primary English Teacher's Guide. England: Penguin Group. Brown, H Douglas. 2000.
- Principle of Language Learning and Teaching Fourth Edition. New York: Pearson Edition. Brumfit, C J Moon and Tongue, R. 1995.
- Teaching English to Children. New York: Longman Group Ltd. Gower, Roger, Diane Phillips, and Steve Walter. 1995.
- Teaching Practice Handbook New Edition. England: Heinemann. Hadfield, J. 1998.
- Elementary Communication Games. England: Longman. Harmer, Jeremy. 1991.
- The Practice of English Language Teaching New Edition. New York: Longman. -----, 1998.
- How to Teach English. Harlow: Addison Wesley. Haycraft, John. 1997.
- An Introduction to English Language Teaching. England: Longman. Phillips, Sarah. 1996.
- Young Learners. Oxford: Oxford University Press. Scoot, Wendy A and Lisbeth H Ytreberg. 1998.
- Teaching English to Children. Harlow: Longman. Suyanto, Kasihani K.E. 2007.
- English for Young Learners. Jakarta: Bumi Aksara. Wright, Andrew. 1984.
- Games for Language Learning. Cambridge: Cambridge University Press. . 2003.
- Longman Dictionary of Contemporary English New Edition. Harlow: Pearson Education.

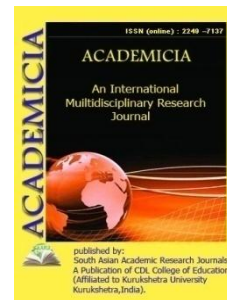
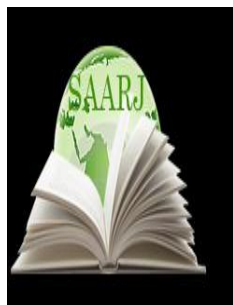

DOI: **10.5958/2249-7137.2021.01084.3**

## VALENCE PROPERTIES OF THE VERB AND ITS POLY FUNCTIONALITY

**Gafurova Vazira Alisherovna\***; **Raximova Madina Ramizovna\*\***;  
**Amrillayeva Sabrina Azimjon qizi\*\*\***; **Uktamova Shakhzoda Najmiddin qizi\*\*\*\***;  
**Yuldasheva Sevara Ikhlos qizi\*\*\*\*\***

<sup>1,5</sup>Students,  
 Samarkand state Institute of Foreign Languages,  
 UZBEKISTAN

### ABSTRACT

*This article tackle with exploring valence properties of the verb and its polyfunctionity. Moreover, in this research the basic functions of the verb in terms of context is presented. These functions are explained by means of examples, as well as some comparisons.*

**KEYWORDS:** *Valence Properties, Combination, Lexico-Semantic, Morphological Features, Verb.*

### INTRODUCTION

The fact that the combined possibilities of a word are primarily determined by its belonging to a part of speech is generally accepted and without doubt.

In such distributive models as NV, VD, VprpN, VN, V'Ving, V'V=, one and all meaning-bearing verbs meet.

On the other hand, the surroundings of a word are largely determined by its meaning.

As noted by many authors [7, c.21; 11, s.20], the semantic structure of the leading word of the phrase predeterminates the appearance in the sentence of certain classes of words, i.e., a surface structure. Since there is considerable commonality in the values of words belonging to one lexico-semantic group (LSG), a number of combination features characterizing the group as a whole in terms of the development of poly functionity can be assumed.

The semantic capacity and broad design capabilities of the verb put the problem of studying its combinability first.

The verb is more than the other part of speech, able to diagnose its surroundings. Directed action verbs have an "open structure," meaning that there is an object, destination, or direction circumstance of the action in the sentence.

Every sentence is built around a predictive element, which is accompanied by usually named elements, the composition of these elements is dictated by the semantic structure of the verb.

Thus, a verb is the constructive core of a sentence, and knowledge of its deep (semantic) structure is necessary to understand the polyfunctional processes that result in a particular surface structure of the sentence.

By examining the valence of the verb, we distinguish between its compulsory and optional surroundings. The former is determinable, dictated by a particular verb, the latter only potentiated by them due to the inherent class of verbs of syntax combinability.

The realization of potential combination capabilities depends on the content of the speech. Since optional elements can be included in the surroundings of almost every verb, that is, they are characterized by a low degree of selectivity, their presence or absence cannot be a relevant distribution property of the verb.

Cp: I never thought of you as one. [106, page 155]

It was a fixed principle with him never to allude to June [109, c.45].

You will notice, never gives himself away [108, c.117].

It would be a mistake, however, to consider any regional environment irrelevant. The fact is that the lexical filling of the L element in the VD model is largely determined by the semantics of the verb itself, so comparing the adverbs found in the surroundings of different verbs helps to reveal the peculiarities of the sense structure of each of them.

In the real division we try to show the connection between the meaning structure of the word and its combination. At the same time, we believe that differences in the syntax behavior of words always signal the presence of semantic differences between them, that is, a certain type of environment indicates the type of value of the control word.

Six verbs of visual perception were selected for the study, which are part of the first thousand most frequency significant words see, notice, look, watch, regard, obsession.

All these verbs are part of a class combined by the lexical meaning "passive - active perception.

The verbs we have selected fall into two groups:

- 1) arbitrary action verbs (look, watch, regard) and
- 2) verbs of involuntary action (see, notice).

The verb observe- occupies a special position, as it can denote both an involuntary act of vision and an inproizvol observation of an object. Therefore, in the following we will talk about observe1 with the value of the involuntary action and observe2 with the agenative value [indicating the producer of the action].

Features of verbs of the see group allow to call them experiential. These verbs denote processes and need to be supplemented. However, it is hardly possible to consider the relationship between words in a Tomsawasnake sentence as a relationship between figure, action, and object.

Subject to verbs of this group names not a figure, but a person whose mindset or mental processes are exposed. Additions to this group 's verbs do not denote the subject being actively affected, but the subject affecting our memory, vision and hearing. To offers with eksperiyentsialny verbs it is possible to raise the question whathappened? and newhatdidtomdo?

In sentences with verbs of type look, the person to be is a purposeful action agent. Therefore, the question of Tomlookedatasnakeis whatdidTomdo?

Verbs considered in this work are also differentiated by the "realized/unrealized act of vision."

The verbs of the see (notice, observe1) group denote the implemented act of vision. The verbs of the look group (watch, regard, observe2) are heterogeneous. The "realized possibility of vision" seed is part of the sense structure of the verbs watch, look, regard, observe2, but is not mandatory in the structure of the verb look.

So we meet suggestions like

He looked at the grand piano and noticed the music on the rack [106, c.88].

He looked up in order to see if she was still crying [108, c.110]

Predlozheniyazhetipa:

"\* He saw the piano and noticed" or "\* He watched in order to see is not English language.

Consider in more detail the morphological and syntax features of verbs in order to test the correctness of preliminary remarks about differences and similarities in their semantic structure.

Verb see

The most common form is the general type of apparent inclination. In the form of a command inclination, the verb met us only 2 times:

1. Come with me, and see what the world is really like [107, c.160].
2. See the hunchback marching in Miss Amelia's footsteps when on a red winter morning they set out for the pinewoods to hunt. See them working on her properties [106, c.172].

Apparently, in the first of these offers of see "learn, get acquainted" matters, and in the second - "to imagine, present mentally".

The almost complete absence of a command inclination with a verbomsee is a formal indicator that seeexamination of an involuntary action that is not performed at the request of the Iliprikazu.

The significant prevalence of the general form over the long form is due to the fact that the speaker 's attention is not concentrated on the process of vision, but on its object.

The most frequency models registered with verbs are VN, VNV "≡, VNVing, VD, VcnjS, VS, VO, VprnN.

A characteristic feature of the verb see is its use with both direct and proposed addition. And the same pretexts prevail as after the usual verbs of motion when pointing to distance, the limit of motion is -into, along, behind, through, to (Sr.thebirdflewbehindatree = the bird flew place behind tree).

The same meaning these pretexts convey in combination with the see- limit of what can be discerned by the eye.

That is why in the "seeprpN" model, see almost always acts with the verb can.

John shrank back and stood where he could see into the hall [106, c.219]

The grass was so tall, that even from their horses the two men could not see over it [108, c.259].

In the VD model, time adverbs (often, frequently, never, etc.) are the most used, as well as adverbs indicating the degree of clarity of vision (perfectly, plainly, clearly).

She slid over on to the sofa until she could see plainly into the studio [109, c.128].

The adverbs of the way of action, common in agentive verbs, with the verb see do not combine.

The VcnjS model is dominated by the union that, which also emphasizes the importance of "the act of seeing an object."

Speaking of the VO model, we consider it necessary to distinguish between cases of absolute use of the verb see, when the supplement is omitted and easily restored from context, and cases of use of it as a non-transient verb with the meaning "to have the ability to see."

Cp: 1.know some of my work is good if only people could see[107, c.145].

2. I can't see...It's a black – quite black [107, c.149].

Thus, the morphological features of the verb see and its combinability are the means of actualizing the major components of its semantic structure:

- (1) Ability to see;
- (2) Realized object vision act;
- (3) Neproizvolnostprotessa of vision;
- (4) Visibility limit,

Verb notice

Its distribution is similar to that of the verb see. The exception is the Vprp N model, in which the verb notice is not registered. The absence of this model seems to be an indicator of the absence of the "limit of vision" seed in the meaning structure of the verb notice. Tiny, notice does not possess a seed "ability to see," which finds reflections of the impossibility of its non-transient use.

The main seeds of the content structure notice are:

- (1) The failure of an act of vision;
- (2) The surprise and short-term nature of this act.

Analysers allocated this is, on the one hand high the chastotnosttakikh of models as V N, V cnjS (especially about soyuzomthat), on the other hand - lack of modal verbs in its environment, impossibility to use notice in the form of a long look and an imperative mood.

The VD model is not as frequency for notice as it is for see, because it only meets time adverbs (suddenly, never, frequentlyetc).

Thus, being very close in meaning words, see and notice nevertheless have a number of differences in depth structure, which is signaled by their morphology and syntax in functioning.

Verb look

It is an agenerative verb, that is, a verb denoting arbitrary facial action.

Hence a number of features of its use. First of all, it is easily combined with adverbs of the way of action (carefully, intently, indignantly, curiouslyetc.)

She stared at the window and then slowly looked at him [108, c.297].

In addition, it is regularly found in the form of a command inclination and is easily combined with any modal verb, for example, Lookatmyface, Dick, andtellmewhatyousee. - Dickdarednotlookather [107, c.161].

Look is most common in the Vprp N model, with the at pretext being particularly common. Usage: to, towards, along, over, across, down, into.

Of the pretexts listed, only at and towards are not found with the verb see. The other pretexts are used after both verbs. If with the verb see they denote the limit of vision, then with the verb look they call the general direction of view, like the same pretexts with verbs of movement:

Cp: The hunchback stood leaning against the banister of the porch, looking down the empty road[109, c.112].

Hewwent down the road to the house where he had been raised[107, c.139].

A comparison of the following examples is also illustrative:

1. By turning their heads they could see,through another window, along an alleyway...and into the back door of Groff's bakery [108, c.44].

2. After that she did not look along the alleyway any more[108, c.45].

The first example is that the character of the story could see from the window, what was the limit of yeopole vision.

In the second example, the author talks about the hero 's decision not to look towards the alley.

If the speaker does not specify in which direction the view moves (through, over, inside, etc.), but only in general terms transmits the idea of direction, the pretext at. (Cp. Its use in the same meaning with verbs of movement such as throw. rush, jump).

Consequently, the ability of pretexts over, across, along, etc., to combine with both look and see is due to the dual nature of their semantics: they call both the limit and the direction.

The component "direction of view" in the semantic structure of the verb lockactualized also by numerous adverbs indicating the direction: down, round, about, up, etc.



For example: Not willing to the mill and looked inside [106, c.148].

They leaned to look out[109, c.249].

In many cases, there is a combination of the at pretext, which conveys the general meaning of the direction, with the adverb, which specifies this direction.

For example: Henry Macu locked up at the corner of the ceiling [108, c.102].

Unlike the verb see, which denotes the vision of the subject, lockno contains the mandatory component "vision" as in the following example: Not looked up but did not see the dark sky [108, c.104].

Thus, in the semantic structure, the seeds "the arbitrariness of the viewing process" and "the direction of the view" are separated, that is, the components of the semantic structures see and look are in the position of additional distribution, as shown in the following diagram:

Семы	see	look
1. The general sposobnost to see	+	-
2. Realizovankny act videkniya	+	-
3. Direction of a look	-	+
4. Any process	-	+
5. Vision limit	+	-

#### Verb watch

It is an agenative verb, like look, but, unlike it, has a "realized act of vision" component in its semantic structure, which brings it closer about the verb see.

This feature of the sense structure watch is reflected in its morphology and syntax.

The verb watch forms a phrase with the same models as see (VN, VNV =, VNVing, VcnjS), but, unlike the latter, does not combine with the proposed turnovers. It demonstrates lack of a sema at it "betrayed visions". The verb watch is not combined also with subordinate clauses, the entered union of that as the VthatS model assumes value of suddenness, unexpectedness of vision of an object.

Drugiyesintaksicheskiyeosobennostisblizhayutwatchsglagolomlook.

Thus, the verb is easy to understand - must, san, dareidr.

For example: Hewatchedherfacekeenly [106, page 177].

Helikedtowatchothershardatwork [109, c.202].

The morphological behavior of watch also brings eroclook- both often appear in the forms of continued species and command inclination.

For example, She was always watching him [106, c.251].

Watchme, Daddy![107, c.88].

Thus, the grammatical features of the verb watch reflect the presence in its sense structure of both the components of the semantics of the verb look and the components characterizing the verb see.

#### Verb regard

It 's close in importance to watch.

Cp. She regarded him steadily [109, c.188].

She watched him face steadily [108, c.214].

The main model in which regard acts as the lead is VN, as for the verb watch.

It is as wide as watch, combined with adverbs of time and way of action (always, steadily, keely, closely).

However, unlike the verb watch, regard is not registered in the models VNVing, VNV "=", VcnjS, it does not meet and in the absolutive use.

The morphological properties of the regard are the same as those of watch: it is widely used both in the form of a general and a form of a long-term species, as well as in the form of a command inclination.

For example: Massiewasstillregardingthesea [106, c.228].

Comparative analysis of nouns included in models watchN and regardN makes it possible to make the assumption that there is a certain semantic difference between verbs -watch easily combined with features, designating objects, faces, activities (a person, parade, work, processing, etc.); Regardwatch with nouns denoting fixed objects or abstract concepts (face, house, year, feeling, conducting, etc.).

It seems that in the semantic structure regardvoditcomponent "to consider mentally," to reflect, "and in the semantic structure watch- component" to consider moving objects. "

It is this distinction that can explain the absence of complexes with infinitive and herundium after the verb regard.

#### Verb observe

It has in its semantic structure a component common with the verb se- "realized act of object vision" and the verb component watch "object observation."

Cp.: The forked veins in his temples throbbing plainly enough to be observed across the room [109, c.259].

Observethevirtuoushorrorofthelions [106, c.123].

As a synonym for ssee, the verb obsession is usually combined with s- adverbs like plainly, clearly and with the modal verb can, and as a synonym of watch, it is combined with adverbs of the way of action and is used in the form of a command inclination, that is, behaves like an agenative verb.

The study of six verbs of visual perception allows to draw the following conclusions:

1. These verbs have a set of common distributive properties, primarily due to the presence of common components in their semantic structure.
2. The greater the similarity between the syntax and morphological properties of verbs, the more common we observe in their semantics.
3. Each of the verbs considered has its own set of syntax means, distinguishing it from other verbs of the given group and signaling the peculiarities of its semantic structure

**REFERENCE:**

1. Freud, S. (1953). The method of interpreting dreams: An analysis of a specimen dream. In J. Strachey (Ed. & Trans.), *The standard edition of the complete psychological works of Sigmund Freud* (Vol. 4, pp. 96-121). Retrieved from <http://books.google.com/books> (Original work published 1900)
2. Luijkx, J. B., Marsman, G. W., & Rijt, G. A. J. van der. (1987). *Effecten van SOA-voorlichting: Evaluatie van een Sire-campagne*. Nijmegen, Nederland: Katholieke Universiteit Nijmegen, Instituut voor Massacommunicatie.
3. Shotton, M. A. (1989). *Computer addiction? A study of computer dependency* [DX Reader version]. Retrieved from <http://www.ebookstore.tandf.co.uk/html/index.asp>
4. Schiraldi, G. R. (2001). *The post-traumatic stress disorder sourcebook: A guide to healing, recovery and growth* [Adobe Digital Editions version]. <http://dx.doi.org/10.1036/0071393722>
5. Thomas, N. (Ed.) (2002). *Perspective on the community college: A journey of discovery* [Monograph]. Retrieved from <http://eric.ed.gov/>

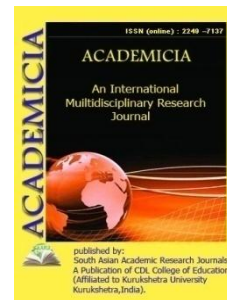
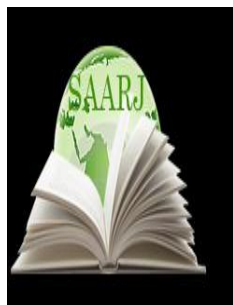

DOI: **10.5958/2249-7137.2021.01085.5**

## POLY FUNCTIONALITY OF A WORD IN THE CONTEXT OF SPEECH

**Sarimsokov Sirojiddin Shoyzokhovich\***; **Sattarova Ismigul Bahtiyarovna\*\***;  
**Khalilova Lenie Fevziyevna\*\*\***

<sup>1,3</sup>Teachers of Samarkand State Institute of Foreign Languages,  
UZBEKISTAN

### ABSTRACT

*This paper is about poly functionality of a word in the context of speech. On the top of that, examples are presented to justify the research. The outcomes are implemented in compliance with analysis.*

**KEYWORDS:** *Speech, Word, Poly functionality, Literature, Context, Sentences.*

### INTRODUCTION

Non-direct speech is a stylistic technique that consists in combining the subjective plans of the author and the hero. The speech is on behalf of the author, but its content, intonation, lexical and syntactic features indicate her belonging to the hero [7, c.22].

With the help of non-direct speech, the author introduces the reader into the inner world of the hero, depicts his thoughts, feelings, and his attitude to various phenomena of reality. Its content can be both internal and external speech.

In English and American literature, non-direct speech was most developed in the 20th century in the works of Golsworthy, Dreiser, Game, Malz, Cronin and other writers [114]. Despite the presence of common features characteristic of non-direct speech in English, each writer has his own individual-artistic manner of using this technique, which often changes with the growth of his skill [28, c.112].

From the point of view of the polyfunctionality of the word, we highlight the following issues:

- 1) Decoration unit of non-direct speech;
- 2) Means for recognizing non-direct speech;
- 3) Means of combining non-direct speech with the author's speech and the hero's speech;
- 4) The order of non-direct speech;

5) Use of non-direct speech as a form of transmission of internal and external speech of the hero [8, c.128].

Most often, non-direct speech in the language of works of English literature is found in the form of one or more independent sentences.

Examples:

1. "Oh! Denis, how can you say such a thing!" cried Mary indignantly. But she gazed doubtfully at the suggestive angle of the yachting cap. Was it merely sausy, or was its purpose more profoundly significant? [106, p.54].
2. She shuddered at the recollection of her visit to the doctor, but firmly she blotted out from her mind the odious experiences of the last two hours. She would be brave for Denis! [106, p.155].
3. Peter Perry's chance remark had given her the solution she had been blindly seeking, and it was that which now impelled her in this contrary direction. She would go and see a doctor. Doctors were wise, trustworthy, kind; they healed, advised, comforted, yet respected one's confidence. Immediately she thought of the only practitioner she knew, Dr. Lawrie... [107, pp.130-131].
4. As her eyes met his, he could see that she meant absolutely very grim word she uttered, and he pressed her arm again, tenderly. How could he, even for an instant, have considered leaving this lovely, defenceless creature who, but for him, would still have been a virgin and who now, because of him, was soon to be a mother. And how passionately attached to him she was! It thrilled him with a fierce joy to see her complete dependence upon him and her submission to his will. [108, p.154].

Often, non-direct speech is equal in volume to part of a complex sentence.

1. Angrily he thrust this from him, suring himself, in his own axiom that it was the man, not the money that mattered, and with a quick gesture, he swaggered his way through the imposing portals [109, p.260].
2. ...he touched the parcel under his arm, exploded into activity before this peculiar lady might regain her sanity, and vanished like a puff of smoke down the street [109, p.145].
3. He was now aware that he would have to bond his house ... No one would know, he would go secretly to a lawyer in Glasgow who would arrange everything, but already, he felt dully as if his own house did not belong to him [108, pp.237-238].
4. His vague allusions had shocked her; she must know more, be at all costs reassured [108, p.247]

The non-direct speech, presented as part of a complex sentence, is sometimes followed by another independent sentence:

1. He looked at her quersly, asking himself if the old girl thought he was still at her apron strings. Perhaps he had been too unguarded with her [107, p.246].

2. He was proud of his achievement, and felt in agreeable anticipation that he would do even better next time, that Mamma must have a tidy sum tucked away in a safe place. It would be his for the asking! [107, p.278].

The non-direct speech, presented as part of a complex sentence, is sometimes followed by another independent sentence:

1. Well! she must see her name – the name of Nessie Brodie. That, surely, was no hardship – to view for one moment her own name. That moment had come! [108, p.148].
2. Why, she asked herself, did she enjoy herself always so exquisitely with him? Why did he seem, in his kindness, generosity, and tolerance, so different from anyone she had known? Why should the upward curl of his mouth and the lights in his hair, the poise of his head, make her heart turn with happiness in her breast? [107, p.110].

In the author's narrative, elements of non-actual direct speech are often found - individual words and phrases that are characteristic of the hero's speech, but not framed as speech. Examples:

1. He knew the value of these sudden departures, felt the restrained dignity of his leaving the sodden dogs to sing and rant in the fashion that fitted them, whilst he departed at the moment when he could so retire with majesty and honour [108, p.295].
2. Brodie was beginning to become enraged; the fact that he could not beat down this young sprig's eyes, nor yet provoke him to temper, annoyed him [108, p.161].
3. His attitude repudiated the idea of such sour wizened apples as she might obtain for him in this unproductive land; he waved his hand eloquently... [109, p.262].

In the first two examples, elements of non-direct speech respectively reflect the point of view of James Brody, his opinion about some members of the Livenford Club and the groom of his daughter Mary. In the third passage, the words this unproductive land belong to Matthew Brody, who, after returning from India, treats everything with neglect.

## BIBLIOGRAPHY

Brewster, Jean and Dennis Girard. 1992.

The Primary English Teacher's Guide. England: Penguin Group. Brown, H Douglas. 2000.

Principle of Language Learning and Teaching Fourth Edition. New York: Pearson Edition. Brumfit, C J Moon and Tongue, R. 1995.

Teaching English to Children. New York: Longman Group Ltd. Gower, Roger, Diane Phillips, and Steve Walter. 1995.

Teaching Practice Handbook New Edition. England: Heinemann. Hadfield, J. 1998.

Elementary Communication Games. England: Longman. Harmer, Jeremy. 1991.

The Practice of English Language Teaching New Edition. New York: Longman. -----  
-, 1998.

How to Teach English. Harlow: Addison Wesley. Haycraft, John. 1997.

An Introduction to English Language Teaching. England: Longman. Phillips, Sarah. 1996.

Young Learners. Oxford: Oxford University Press. Scoot, Wendy A and Lisbeth H Ytreberg. 1998.

Teaching English to Children. Harlow: Longman. Suyanto, Kasihani K.E. 2007.

English for Young Learners. Jakarta: Bumi Aksara. Wright, Andrew. 1984.

Games for Language Learning. Cambridge: Cambridge University Press. . 2003.

Longman Dictionary of Contemporary English New Edition. Harlow: Pearson Education.

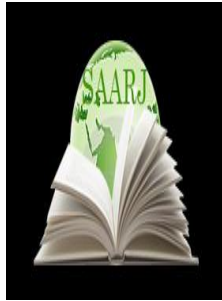

**ACADEMICIA**  
**An International**  
**Multidisciplinary**  
**Research Journal**  
(Double Blind Refereed & Peer Reviewed Journal)



DOI: **10.5958/2249-7137.2021.01090.9**

## **IMPROVING THE USE OF DISTANCE LEARNING IN HIGHER EDUCATION**

**Xidirova Barchinoy Ilxomovna\***; **Goziev Rzoiddin Cholpon ogli\***

\*Assistant,  
Department of Management and Marketing,  
Tashkent State University of Economics,  
Tashkent, UZBEKISTAN

### **ABSTRACT**

*The article is devoted to researching the problem and improving the use of distance learning in higher education. One of these challenges is the full introduction of distance learning opportunities in the educational process, the formation of its normative framework, including the development and implementation of a unified methodological approach to the full coverage of the process, its development and implementation opportunities related to.*

**KEYWORDS:** *Distance Learning Opportunities, New Solutions in Education, Innovation In Education, ZOOM Platform, Coronavirus Pandemic.*

### **INTRODUCTION**

The introduction of modern information and communication technologies in the educational process has led to the creation of a new form of teaching - distance learning, in addition to traditional teaching methods. In particular, the Coronavirus pandemic has changed the way education is taught around the world. Thousands of students have lost access to traditional education. At the forefront of the coronavirus pandemic, first of all, medical staff can be imagined, and in the second part, the active participation of thousands of professors and teachers of general secondary schools in the process of overcoming its consequences. The sudden move of yesterday's classroom lessons to the online platform was also a great experimental school for educators.

According to the order of the Minister of Higher and Secondary Special Education of the Republic of Uzbekistan dated March 27, 2020 No 233 "On the introduction of distance learning in higher education institutions" teaching in higher education institutions was transferred to distance learning [1].



In the context of the epidemiological situation in our country, online classes have been launched in a very short period of time in all educational institutions of the country. Initially, these changes undoubtedly caused certain inconveniences, but the changes observed due to the pandemic and new solutions in education have led to the introduction of innovations in the field of education, which are necessary for the modern era [2].

## **MATERIALS AND METHODS**

Indeed, what is distance learning and how can it be used in a continuing education system. What shapes and models does it have? At the end of the twentieth century, humanity faced several problems, which are directly related to the significant changes in the field of information telecommunications, in particular, the rapid development of information technology. New means of information and communication began to enter various spheres of education, production and human society. The development of the global computer network of the Internet has led to the opening of new directions for the improvement of the education system around the world. First, the drastic change in the technical equipment of educational institutions, the wide access to secular information resources has led to the need to use new forms and methods of teaching [2-4].

The introduction of modern information and communication technologies in the educational process has led to the creation of a new form of teaching - distance learning, in addition to traditional teaching methods. In distance education, the student and the teacher are in constant communication with each other using spatially separated training courses, forms of control, electronic communication and other technologies of the Internet.

Distance learning based on the use of Internet technology provides access to the global information education network, performs several important new functions with the principle of integration and interaction. Distance learning provides an opportunity for all those who want to learn to continuously improve their skills. In the process of such teaching, the student learns independent teaching materials in an interactive mode, undergoes supervision, carries out control work under the direct guidance of the teacher and interacts with other "vertical learning group" students in the group.

For obvious reasons, distance learning is a convenient form of education for those who do not have the opportunity to study in full-time departments of educational institutions, for example, do not require health, intends to change their profession or are older, intend to improve their skills. Different information and communication technologies are used in distance learning, that is, each technology depends on the purpose and nature of the problem [2-5].

For example, while traditional print-based teaching aids (textbooks, manuals) are based on introducing students to new material, interactive audio and video conferencing is designed to interact over a period of time, sending and receiving e-mail directly and back. While pre-taped video lectures allow students to listen and watch lectures, facsimile communication, messages, and the rapid exchange of assignments over the network allow students to learn through feedback. Based on the above, we give a description and definitions of some of the terms that are currently being mentioned repeatedly in the educational process. Distance learning is education based on distance learning.

Distance learning is a relationship between a student and a teacher based on the purpose, content, method, organizational forms and teaching methods - Internet technology or other interactive methods and components of all learning processes at a certain distance from each other [6-8].

A distance learning system is a training system based on the conditions of distance learning. Like all education systems, the distance learning system has its own structural purpose, content, methods, tools and organizational forms. Pedagogical technologies of distance learning is a set of teaching methods and techniques that provide the educational process of distance learning based on the selected teaching concept. Case technology is such a method of organizing distance learning, which is based on the use of a set of textual, audio-visual and multimedia (case) teaching materials in distance learning. TV technology is a method of organizing distance learning, which serves to convey educational and methodological information to students through television and is based on the installation of one of the optional interactive methods of external communication.

Currently, online classes are organized through the ZOOM platform, where every professor of the university evaluates students' knowledge in a timely manner, including video lectures, the text of lectures, presentation materials on the topics, independent work, open and closed tests. An online lesson is a new style and radically different from a traditional lesson. This means that every teacher now has to partially forget the approaches in the classroom and adapt to virtual audiences because these lessons also have their own serious requirements and conditions. Through online classes, students will be able to work more independently, engage in scientific creativity, and read books. Teachers, on the other hand, participate in online videoconferences with the participation of foreign scientists and strive to work regularly to develop their professional skills.

At present, there is an objective basis for a qualitatively rapid transition to new technologies of teaching and education, as innovative processes in economic and social life require radical changes in self-education as well. No teacher-educator can be left out of this process sooner or later. In the context of modern globalization, the quality of education is expected to further increase as a result of the enrichment of online teaching methods in higher education with modern media. In this regard, the method of distance learning is of particular importance, as it has several advantages for both teachers and students. The current situation makes it necessary to develop computer programs based on the necessary teaching materials and manuals for students. After all, distance learning provides an opportunity to obtain and summarize the methodological literature of the world educational centres, modern and up-to-date information in any field.

## **RESULTS AND DISCUSSION**

With the large-scale introduction of technology in our country, online teaching can also facilitate the solution of several socially significant issues. The need of the republic for qualified and competitive specialists will be met by creating conditions for meeting the needs of students in the field of education. It is also possible to increase the social and professional activity of students. It creates favourable conditions for students studying in part-time departments, especially for young people studying in isolation from production.

Training on the basis of this method plays an important role in the training of future professionals and serves to strengthen the active participation of working people in society and enrich their worldview. This puts the task of implementing priority plans, such as strengthening

the economic potential of the country, with the scientific achievements accumulated in higher education institutions, specialists and their participation. In this regard, it should be noted that the meetings of scientific and technical councils under the Ministry of Innovation Development are also held online these days. Online meetings not only allow you to use your time more efficiently but also optimize the meeting preparation process. Based on the general requirements for the formation and implementation of the state order for research projects in accordance with the Regulations on the state order for research, the establishment of an online system of work based on the criteria for evaluating scientific expertise on projects. encourages a more responsible approach.

## CONCLUSION

Summarizing the above, it can be said that the introduction of the distance learning complex in higher education institutions will bring all-around benefits. The higher education system has all the conditions for the introduction of this complex. All higher education institutions in the country are well equipped with computers, information and communication technologies. They are all connected to the Internet. The widespread introduction of these technologies in the education system will help to solve many problems facing higher education institutions in a timely manner. Nowadays, the teaching of sciences using computers is becoming more important. The opportunities of computer technology can be effectively used in the development of students' personality-oriented development, creative abilities. Educators use the computer not only in the preparation of methodical materials for the lesson but also in the use of computer programs necessary for teaching science, as well as in the process of individual work with students.

## REFERENCES

1. Order of the Minister of Higher and Secondary Special Education of the Republic of Uzbekistan dated March 27, 2020 No 233 "On the introduction of distance learning in higher education institutions."
2. Abdukadirov, Abdukakhor Abduvakilevich. (2009). Theory and practice of distance learning. monograph. T. Academy of Sciences of the Republic of Uzbekistan, "FAN" publishing house. 145 s.
3. Hakimova, M. (2020). Improving the quality and efficiency of education in higher education institutions is a requirement of the times. *Archive nauchnyx issledovaniy*, (32).
4. Umaraliyev, O. (2021). Possibilities of distance education system in Uzbekistan. *Mir issledovaniy*, 1 (1).
5. Phipps, R., & Merisotis, J. (1999). What's the difference? A review of contemporary research on the effectiveness of distance learning in higher education.
6. Ali, W. (2020). Online and remote learning in higher education institutes: A necessity in light of COVID-19 pandemic. *Higher Education Studies*, 10(3), 16-25.
7. Trinidad, J. E. (2020). Understanding student-centred learning in higher education: students' and teachers' perceptions, challenges, and cognitive gaps. *Journal of Further and Higher Education*, 44(8), 1013-1023.
8. Zikirov, M. C., Qosimova, S. F., & Qosimov, L. M. (2021). Direction of modern design activities. *Asian Journal of Multidimensional Research (AJMR)*, 10(2), 11-18.



**ACADEMICIA**  
**An International**  
**Multidisciplinary**  
**Research Journal**  
(Double Blind Refereed & Peer Reviewed Journal)

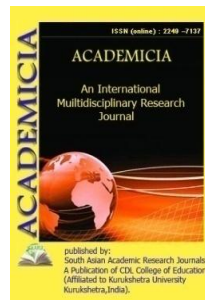

DOI: **10.5958/2249-7137.2021.01092.2**

**INFORMATION TECHNOLOGIES IN TEACHING PHYSICS IN A  
TECHNICAL HIGHER EDUCATION INSTITUTION**

**Irkabaev Djumanali Usmanovich\***

\*Almalyk Branch of Tashkent State Technical University named after Islam Karimov,  
UZBEKISTAN

**ABSTRACT**

*The article discusses current issues related to the methodology of teaching physics in technical universities. The prospects of information technology in the modernization of the educational process in physics, as well as in solving a number of methodological problems were discussed.*

**KEYWORDS:** *Innovative Approach To Teaching, Information Technology, E-Learning Resources, Experimental Modelling, Multimedia, Distance Learning.*

**INTRODUCTION**

Physics is one of the priority subjects in the educational process in the training of engineers in higher education institutions. It is the basis for the study of special disciplines, explaining the basic laws of physical phenomena and processes, as well as shaping the worldview and thinking skills of future professionals. For many years, the traditional system of teaching physics has been preserved. This system includes lectures, laboratory and practice problem-solving. The curriculum in general physics has hardly changed over the years, which means that in its time it was considered to meet the requirements of engineering training. At the same time, the achievements of fundamental research in physics in recent years, the demand for human resources in production, the need to modernize technological processes, new opportunities for modern information technology and the need to revise curricula.

The growing role of nanotechnology in various fields of modern production has led to the need for students to study in detail the basics of quantum physics, solid-state physics because the behaviour of nanoparticles is governed by specific laws of quantum mechanics. The physics program is divided into three different levels of complexity depending on the type of engineering major. However, even in the simplest version, it is so wide that it is very difficult to fully master it in the hours allotted for training. In addition, one of the major challenges in modernizing the teaching process of physics in higher education is related to outdated laboratory equipment that

has not been updated since the 1970s. Old devices that have been repaired many times are used during the presentation of the lecture-demonstration. As for educational films designed to show specific physical phenomena, it can be said that they are manually and materially obsolete.

## **MATERIALS AND METHODS**

There is no doubt that the endless possibilities of modern information technologies can make a great contribution to solving many of the listed problems and modernizing the educational process in physics. However, auxiliary computers and information technology tools in the learning process cannot completely replace the physical equipment in the training laboratory rooms. Due to the high cost of new, modern physical equipment, their purchase remains a topical issue. In recent years, many foreign and domestic companies are producing modern training laboratory equipment.

Many leading engineering universities, taking the long-awaited funding independence, are giving preference to manufacturers in Western Europe, primarily PHYWE (Germany, Göttingen), when purchasing training laboratory equipment. The worthy popularity of the equipment of this company is mainly due to the scientific tradition of the University of Göttingen, which has awarded 44 Nobel Prizes to the world. The equipment manufactured by PHYWE is visual, methodologically well designed and reliable in performance. The creative initiatives of advanced educators to modernize the physics course are diverse and undoubtedly innovative, as reflected in the fact that many ideas have already been implemented in educational institutions, in the materials of many conferences each year on physical problems [2].

Computer-assisted modelling of physical experiments, use of the Internet information environment in laboratory classes, multimedia presentations in lectures, remote laboratory practice by a researcher or student - this is an incomplete list of innovative innovations that contribute to solving more complex methodological problems. The physics program covers several complex topics. The most effective way to discuss such issues is to demonstrate these physical phenomena on real equipment. Unfortunately, it is not always possible to demonstrate a complex experiment in a training laboratory. In such cases, computer-simulated virtual experiments become a good methodological aid for the teacher in organizing the learning process in explaining complex processes to students. The fears of opponents of computerization in the teaching of physics are also not unfounded.

An excessive passion for computerization can sometimes turn out to be not only beneficial but also detrimental to shaping the knowledge of future engineers. An example of such problems is when students blindly download materials from Internet sites while preparing topics, coursework, and abstracts for independent work without understanding the essence of the issue. Even to perform simple arithmetic operations, many students turn to a computer without understanding the meaning of the task or the purpose of the actions being performed. An analysis of the methodological problems associated with the use of information technology suggests that the most appropriate approach is to conclude that it is a method that rationally combines traditional and information education technologies. It turns out that a virtual experiment performed on computers cannot completely replace a real experiment, and it should only be involved when necessary. Before the introduction of information technology in the educational process, a lot of hard work is done, such as creating the necessary computer programs on the topics based on the curriculum, as well as the purchase of licensed e-learning products. In

addition, the methodological and organizational aspects of the lessons should be well thought out, the computer classroom should be equipped with the necessary technical equipment, e-learning manuals should be available.

Traditionally, a lecture course in physics provides coverage of the material being studied through lecture presentations. In this context, it is information technology that can provide the necessary methodological assistance in creating presentation materials for lectures. At the same time, the information resources of the global Internet are a useful source of information in the selection of audio and video materials for a physics lecture course. The procedure for developing e-learning products, creating multimedia materials, videotaping demonstration experiments for a physics course is a very expensive and laborious task [1].

A presentation of lectures in electronic form has been developed for reading lectures on the full course of physics. Presentation slides prepared in MO PowerPoint program allow displaying formulas, drawings, graphics in animated mode.

The course of electronic lectures includes videos of real physical experiments taken from the Internet [4], video assignments (author prof. A.I. Fishman), animations from the site "Physics in animation" [2], as well as materials "Open Physics 1.1" [3].

The constant addition of such videos to the electronic lecture course allows supplementing it with necessary and useful materials [5]. During the presentation, the working slides of the electronic abstract are filled with formulas, pictures, and graphics in animation mode. That is, as the presentation continues, the material is broken into pieces. During the lesson, the speaker will give the necessary explanations orally, as well as use the board in the classroom. Clear images displayed on the screen allow students to record high-quality recordings of the material being studied. At the same time, the speaker takes the time to explain, explaining the most difficult issues. Formulas, diagrams, graphs, drawings in electronic form are easier to understand than those drawn by hand on the board. One of the main advantages of such a lecture course is the opportunity to improve it, to fill it with new materials. The achieved quality of the e-lecture course made it possible to start designing it in the form of a compact multimedia disc. The main work plan is to create a multimedia product for a full course of physics, which should help students and teachers in their work, both in reading lectures and in students' independent work. The disc project includes theoretical materials on this topic, along with video experiments, reviews. The disk contains attachments in the form of pdf-files, which provide a detailed description of the material provided. These attachments are copied from the slide so as not to confuse the viewing area with large amounts of text. The advantage of this multimedia product is its clarity, informative content and the ability to constantly improve it. At this stage, the structure of the future disk was developed, part of the work on its filling was completed.

## CONCLUSION

In conclusion, the introduction of information technology in the modernization of the educational process in physics, taking into account the organizational components of the working program in the teaching of physics in technical higher education institutions, is a promising method.

**REFERENCES**

1. Сб. докл. X-й Междунар. конф. «Физика в системе современного образования » (ФССО), г. Санкт-Петербург, 31 мая – 4 июня 2019г. 353 с.
2. Сб. "Актуальные проблемы преподавания физики в ВУЗах России". Материалы совещания заведующих кафедрами физики ВУЗов России, г.Москва, 29 июня – 1 июля 2018. 364 с.
3. СД «Открытая физика 1.1» под редакцией С.М. Козела, ООО «Физикон», 2001.
4. Лаптенков Б.К., Тихомиров Ю.В. Физика. Виртуальный лабораторный практикум: В 2 ч. Ч. 2. электричество и магнетизм. Оптика. Квантовая физика /Чуваш. ун-т. Чебоксары. 2004. 144 с.
5. Ж.У.Иркабаев, С.С.Шералиев Физикани ўқитишда ноанъанавий ёндашувлар. VII Международной научно -практической Конференции «наука и образование в современном мире: Вызовы XXI века» Казахстан, Нур-султан – 2020. 167 с.



**ACADEMICIA**  
**An International**  
**Multidisciplinary**  
**Research Journal**  
 (Double Blind Refereed & Peer Reviewed Journal)

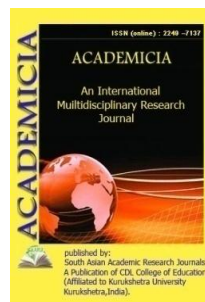

**DOI: 10.5958/2249-7137.2021.01093.4**

## THE METHODOLOGIES OF LEARNING ENGLISH VOCABULARY AMONG FOREIGN LANGUAGE LEARNERS

**Kuziyev Sarvarbek Ilmiddinovich\***

\*Assistant,

Department of Teaching Languages,  
 Fergana Polytechnic Institute, Fergana, UZBEKISTAN

Email id: sarvarkuziev1988@ferpi.uz

### ABSTRACT

*Vocabulary is indispensable in improving learners' language abilities which are reading, writing, speaking and listening. English competency level is administered by the expansiveness and profundity of learners' vocabulary knowledge. Having an enormous load of vocabulary particularly academic and specialized vocabulary is extremely fundamental for building up the language capability and preparing students to get by in the academic world. Nonetheless, learning vocabulary requires viable and key vocabulary learning methodologies (VLM). This research checked on writing on the VLM utilized among learners in tertiary organizations. Learners' prosperity rate in learning vocabulary is related to address the utilization of jargon learning methodologies that are advantageous in helping the learners' advancement in their learning.*

**KEYWORDS:** *Language Skills, English Proficiency, Foreign Language Learning, Vocabulary Knowledge, Vocabulary Learning Methodologies.*

### INTRODUCTION

English is perceived as quite possibly the most preferred dialects worldwide because of the way that it is utilized in numerous exchanges like an overall exchange, admission to science and innovation, and the unremarkable teaching method inside schools and organizations (Sun, Yin, and Brien, 2017). Harmon, Antuna, Juarez, and Wood (2018) claim that due to various content-area texts, literacy of English as a foreign language has been accentuated and consideration has additionally been given intensely onto the learners, prompting innumerable arising proficiency methodologies that emphatically have influenced learners' interaction of learning. This is because the more learners know the words and their construction, the better they could be (Susanto and



Halim, 2017). During the time spent dominating a foreign language, students ought to have more comprehension of each word and their design so learners would utilize it effectively, in any circumstances.

Great English language learners are needed to have a great vocabulary in their munitions stockpile as vocabulary is the establishment of English and its job is crucial. Without knowing the parts of vocabulary, a language learner will discover trouble to convey, read, write or fathom a foreign language (Schmitt, 2010). The stress on the imperativeness of the roles played by vocabulary is featured plainly through the explanation.

Easterbrook (2013) claims that jargon is characterized in two unique manners, which are orthographically (as a free language thing which holds meaning) or phonologically (the blend of autonomous things that are known as the multiword which is identified with morphological instruments, for example, affixes or etymological parts). Consequently, it is perceived that vocabulary is the language thing that is identified with phonological, morphological and grammatical structure. Then again, knowing vocabulary is known as various highlights of a term or phrasing that ought to be considered in term of having the thing and framework structures (Nation, 2015). To ensure that learning interaction of vocabulary can happen easily, even though there appears to be a separation which gives off an impression of being of two unique methods of learning; generally and exceptional vocabulary learning procedures, learners are more encouraged to give up the customary techniques and start to apply the various vocabulary learning methodologies that are found by the unmistakable specialists (Aziz and Hossain, 2010).

In the present life, because of globalization and modernization, vocabulary is considered to be a significant part of correspondence which may prevent the declaration of thoughts and encoding data in the event that it is trifled with that lead to issues over the long run. This implies that if students of a subsequent language partake yet idly during learning measure, they are really overlooking the main issue that to be phenomenal clients of English, it is required to have an expansive width of vocabulary information. This case is additionally upheld by Khalid and Almuslimi (2016) saying that meanings of arising words are purposely stressed, regardless of whether in composing books or during classroom learning measure. Subsequently, the part of vocabulary is irrefutably fundamental and should be given more opportunity for contemplating and dominating at it.

Nonetheless, for students of English as a foreign language, the pressure of learning another information can't be denied. Learning another language is troublesome on the grounds that it includes students' first language which is their native language and it is demonstrated through numerous explores completed before (Marin, 2006). For instance, when learners are getting the hold of the standards and guidelines of the recently educated English language; the vocabulary, elocution and syntax rules of their first language come in the manner and meddle with their learning cycle (Mohd Noor, Nik Yusoff, Md. Yasim, and Kamarudin, 2016). The investigation shows that learners, who are learning a cognitive language, think that its hard to dominate the punctuation rules since they are having the obstruction with their local dialects just as well as the first language. As they are learning, they erroneously apply the vocabulary of their initial language into the foreign language, along these lines driving them to linguistically wrong arrangements and reacts.

Other than that, investigations refer to that among urban and provincial secondary schools learners, there are tremendous differentiates that show the degrees of capability between them. Urban school learners are discovered to be of a more significant level of capability whenever contrasted with their partners, which are the provincial school learners. Urban school learners are better achievers since they are utilizing the more suitable methodology in learning, and it makes unmistakable contrasts from the lower achievers in provincial schools.

Furthermore, picking incorrectly language learning methodologies is additionally the greatest supporter of the absence of progress during the learning of a specific language (Gillies, 2016). This statement is demonstrated genuine in light of the fact that the investigation shows that learners who adapt separately and autonomously, perform essentially ineffectively if a correlation is made with learners who learn two by two, bunch or can be said as helpfully. Adapting agreeably permits learners to have a more dynamic job during the learning cycle and it can diminish the language pressure just as nervousness (Khalid and Almuslimi, 2016). Hence, if students of English as a foreign language apply the correct language learning methodologies, they have a superior possibility of improving outcome, in altogether less time.

Subsequently, numerous issues wait around vocabulary and its job. Students of a foreign language are meddled by their first language, approaches used to gain proficiency with a language and the methodologies applied during the learning cycle. Every one of these issues should be survived if the students are intending to improve over the long haul. This paper intends to audit the various methodologies that have been applied by learners in dominating vocabulary.

### **THE IMPORTANCE OF LEARNING VOCABULARY**

Cheon and Ma (2016) refer to that the width of vocabulary knowledge isn't simply essential to demonstrate one's capacity and capability of a foreign language. For as far back as a couple of years, numerous examinations have been done with respect to vocabulary learning and individuals realize that learning vocabulary is significant for the individuals who need to utilize the foreign language absolutely (Cohen and Wang, 2018). It is showed that the centre is given onto the learning methodologies and it is on the grounds that the right methodologies should be executed so vocabulary learning can happen effortlessly. Be that as it may, albeit numerous examinations have been led before, they are thought to be deluding because innumerable inquiries are still can't be replied to. Moreover, these investigations are completed to recognize the talk types, grammatical structure and lexical information that are important to be applied pedagogically to give better knowledge among language and its substance (Vaish, 2018). Through these investigations, students can separate and have a more clear vision of the language that they are learning. There is a lot of reasons why students ought to be giving their best in attempting to dominate the vocabulary of English. Students ought to give their best for they are attempting to master a language.

Vocabulary knowledge permits students to completely use the language that they are adapting yet it isn't right if understudies' capability is resolved exclusively dependent on their vocabulary knowledge and their authority (Nation, 2001). In any case, the significance of vocabulary learning will not be ignored. Alqahtani (2015) refers to that open competency is made up of great vocabulary information. The correspondences are fruitful on the grounds that students are reacting great during the association with the subsequent language. They can process the

messages that are conveyed to them and give answers to them. Along these lines, jargon is demonstrated to be essential for fruitful correspondence (Teng, 2014).

Besides, students' capacity to peruse appreciation will improve amazingly in the event that they have satisfactory vocabulary information. When the learners have improved over the learning cycle, they have become educated learners of English and can process their readings effortlessly. The readings can be of any materials like academic compositions, diaries, amusements and numerous others. The students are not, at this point expected to peruse the materials that are in their first language. This case can be additionally upheld by an investigation made by Rojananak and Vitayapirak (2015) expressing that great students can peruse materials that are converted into the second language better than the frail students since they have more extensive jargon information and their statement tallies are higher. In this manner, to comprehend and understanding the material, it is important to learn and infer every one of the linguistic guidelines.

In contrast, there are cases whereby the first language meddles with the learning of a foreign language. In any case, late examinations show that learning the subsequent language prompts an upgrade of the main language authority (Lam and Chen, 2018). This implies that a few principles of the subsequent language can be applied to the primary language, making the students utilize a more exact and exact first language. The first language is typically procured normally from the guardians, though foreign language expects students to learn it officially (Gu and Johnson, 1996). A normally procured first language isn't learned as correctly as the foreign language, making it be utilized incorrectly. By learning and applying the syntax rules of a foreign language, it permits students to utilize the primary language all the more precisely.

All in all, learning the vocabulary of English is significant for students as it improves them from various perspectives. Truth be told, the learning interaction ought to be treated all the more appropriately with the goal that students can dominate it in a more limited timeframe.

### **VOCABULARY LEARNING METHODOLOGIES**

Vocabulary learning methodologies have become a significant worry for some analysts and language experts as of late (Cohen and Wang, 2018). This assertion shows that for students to improve step by step, they are needed to apply the correct learning methodologies which are useful in making their learning methodologies goes effortlessly. This case is additionally expounded through an examination made by Kafipour and Naveh (2011), showing that through the utilization of learning methodologies, any space of learning or any points can be dealt with effectively and students are destined for success in getting great English as second language students. Until this point, it is tracked down that different methodologies have been set up and it is demonstrated to be advantageous for the students over the long haul. For instance, the pioneers of language learning methodologies are O'Malley and Chamot (1990) and Oxford (1990) which guarantees that learning methodologies are isolated into four unique classes which are metacognitive, psychological, social, and effective (Zhang and Lu, 2015).

Essentially, there are countless procedures to be recorded. Sanaoui (1995) claims that in grown-ups' jargon learning measure, two methodologies have been uncovered which are organized and unstructured. An examination that is made by Xie (2009), shows that organized learning is considered to be more gainful and unstructured learning gets surplus all through the learning cycle. This is on the grounds that organized learning offers a more efficient path in getting sorted

---

out and taking care of things. In another examination, it is perceived that there are six various types of methodologies which are speculating, alluding to word reference, practice, encoding and actuation – along with two partner factors which are convictions of vocabulary learning and metacognitive guideline (Gu and Johnson, 1996).

## CONCLUSION

English is a significant language that everybody ought to consider in learning. Great English language clients accompany great jargon information. One's jargon information goes about as the marker of their degree of capability. Students of English as a foreign language ought to apply and execute the correct language learning procedures so they can concentrate effortlessly and dominate essentially. There are numerous methodologies that a student can apply in their interaction of improving the authority of English. When the English language is dominated, students will improve in any part of public activity.

## BIBLIOGRAPHY

1. Chang, Y. H., Liu, T. C., & Paas, F. (2018). Cognitive resources allocation in computer-mediated dictionary assisted learning: From word meaning to inferential comprehension. *Computers & Education*, 127, 113-129. <https://doi.org/10.1016/j.compedu.2018.08.013>
2. Ilmuddinovich, K. S. (2020). Methods Of Teaching English To Young Learners. *The American Journal of Social Science and Education Innovations*, 2(11), 65-69.
3. Kuziyev Sarvarbek Ilmuddinovich. (2020). Online evaluating the language learners on the platforms of the social networking services and delivery people. *International Journal of Research in Economics and Social Sciences(IJRESS)*. Vol. 10 Issue 11.
4. Ma, J. H., & Cheon, H. J. (2018). An experimental study of dictionary use on vocabulary learning and reading comprehension in different task conditions. *International Journal of Lexicography*, 31(1), 29-52. <https://doi.org/10.1093/ijl/ecw037>
5. Ergasheva, N. N., & Kuziev, S. I. (2019). Problems in developing speaking skills of students of technical higher educational institutions. *Проблемы современной науки и образования*, (12), 95-96.
6. Cohen, A. D., & Wang, I. K. H. (2018). Fluctuation in the functions of language learner strategies. *System*, 74, 169-182.
7. Davoudi, M., & Chavosh, M. (2016). Vocabulary learning strategy use by Iranian EFL learners across proficiency levels. *International Journal of Linguistics*, 8(1), 67-81. <https://doi.org/10.5296/ijl.v8i1.9032>
8. Easterbrook, R. M. (2013). *The process of vocabulary learning: Vocabulary learning strategies and beliefs about language and language learning* (Doctoral dissertation, University of Canberra).

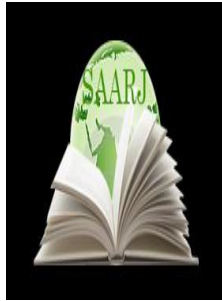

**ACADEMICIA**  
**An International  
 Multidisciplinary  
 Research Journal**  
 (Double Blind Refereed & Peer Reviewed Journal)



**DOI: 10.5958/2249-7137.2021.01096.X**

## E-COMMERCE IN A MODERN BUSINESS SYSTEM

**Xidirova Barchinoy Ilxomovna\***; **Goziev Rzoiddin Cholpon ogli\***;  
**Karimova Shirin Zoxid qizi\***

\*Assistant,  
 Department of Management and Marketing,  
 Tashkent State University of Economics,  
 Tashkent, UZBEKISTAN

### ABSTRACT

*It is no exaggeration to say that the widespread introduction of modern information and communication technologies in our economy, in turn, has brought the interaction between consumers and producers to a new level. Today, the country has introduced and effectively used interactive services for customers in the banking sector through electronic payments, the global Internet and mobile communications. It provides a sufficient basis for the effective use of electronic payments and e-commerce opportunities by businesses, including small businesses and entrepreneurs, in the course of their activities, strengthening their competitiveness and achieving high economic results. The article discusses e-commerce opportunities and their importance in the modern business system.*

**KEYWORDS:** *Small Business And Entrepreneurship, A Global Network Of Internet, E-Commerce Opportunities, The Consumer.*

### INTRODUCTION

During the years of independence, small business and private entrepreneurship have become a leading force in our country. Artificial barriers to free enterprise have been removed. To this end, effective measures have been taken. The widespread introduction of trade and services through the use of information and communication technologies is an important factor in the development of business, as well as the creation of a favourable business environment. This, in turn, will increase the competitiveness and quality of products and services produced by entrepreneurs in the global market. The development of science and technology has necessitated the emergence of several new areas in social life. In particular, the development of information and communication technologies has led to radical changes not only in social life but also in

business [1-3]. The reason for the emergence and development of e-commerce also depends on the rapid development of information and communication technologies. The use of information and communication technologies (ICT) in business has created a revolution in the direct relations of companies with consumers. An important issue today is to take a strategic position, identify the opportunities available to firms and reach the highest level of profitability through the effective use of opportunities based on a simple, businesslike and viable e-commerce strategy in the information age and the new economic environment [4-7]. At the same time, the scope of e-commerce has expanded. Initially, e-commerce was an economic transaction through the Internet, but now, with the development of ICT and the expansion of e-commerce opportunities, e-commerce is now an entrepreneurial activity involving the sale of goods, works and services using information systems. Nowadays, not only the Internet but also other networks - local area network, virtual local area network, corporate network, regional networks are widely used to increase e-economic activity.

## **MATERIALS AND METHODS**

Currently, along with the growing global trend in the use of modern information and communication technologies in the banking and financial sector, the growth of bank plastic cards and the development of electronic payments and e-commerce, the implementation of several projects in e-payments and e-commerce. Banking and financial institutions of our country provide their customers with remote electronic services such as electronic payments, SMS-banking, Mobilbanking through the global Internet and mobile networks.

It should be noted that the relevant regulatory framework for regulating e-commerce has been created in the country. In particular, the Law "On Electronic Commerce", the Law "On Informatization", the Law "On Electronic Payments", the Law "On Electronic Digital Signature" and a number of other normative documents [4-9].

However, the current level of development of information technology and commerce requires a more thorough regulation of relations in the field of e-commerce. Participants in the e-commerce market can be companies, consumers, government, administration, ie government agencies, investors.

The e-commerce market is divided into several main sectors depending on the electronic interaction of the e-market participants. These are business for business, business for consumer, business for government, consumer for consumer, government for consumer and mobile commerce. Of these e-commerce market sectors, the combined share of business sectors for business and business sectors for consumers is close to 90%. The development of e-commerce is influenced by technological factors, market factors, economic factors. Alternatively, businesses that integrate their activities with e-commerce may have the following advantages and opportunities:

- reducing the cost of maintaining business infrastructure,
- reduction of the price of goods as a result of reduction of advertising costs,
- save time on receipt and execution of orders, control over all orders,
- increase the number of potential customers, conduct their business on a global scale.

In developed countries, the use of e-commerce, its widespread use in all spheres of life is highly developed. This is due to the environment that promotes the development of e-commerce - the general infrastructure that promotes the development of computer science, the level of development of information and communication technologies (ICT), the availability of information networks (Internet) and access to these networks for each citizen. Level of provision, the level of use of ICT in society is provided at a high level.

However, in developed countries, there are various barriers that prevent e-commerce from taking full advantage of opportunities. These are language barriers, infringements of intellectual property rights, different tax and value-added tax (VAT) systems, different currencies, different technical standards used in e-commerce, and more. But for developing countries, the use of e-commerce opportunities is much more beneficial. These are:

- Facilitates the access of large and small businesses to world markets,
- E-commerce leads to the development of international tourism in developing countries,
- E-commerce facilitates international marketing of agricultural products in developing countries,
- facilitates access of small businesses in developing countries to the network of suppliers of raw materials in international B2B and B2G markets;
- E-commerce has expanded the range of services of service companies in developing countries, etc.

E-commerce, like traditional economics, is an area that needs to be managed and regulated. However, as e-commerce is a new field, government management tools have not yet been developed in this area. Alternatively, states do not have enough experience to manage these relationships. The regulation and support of e-commerce depend on the level of development of countries. The legal framework governing e-economic activity in Uzbekistan is sufficiently developed. A total of 17 laws and regulations have been developed in the Republic of Uzbekistan to regulate ICT and e-commerce. These are the law on electronic signatures, the law on electronic document management, the law on electronic commerce, the law on electronic payments, and so on [7-10]. At the same time, the legal framework for the development of e-commerce in Uzbekistan should be improved in the following areas.

These are the development of a sequence of legal regulation of online services for the population and business, the strengthening of the specifics of certain types of services in e-commerce, the establishment of procedures for appeals to the law on e-commerce, standardization of electronic documents used in e-commerce, e-commerce issues of determining the procedure for licensing the activities of participants.

## **RESULTS AND DISCUSSION**

In Uzbekistan, the process of implementing e-government as a branch of e-commerce has begun. The first steps in this area began with the process of equipping government agencies with information technology. Later, the single Internet portal of the Republic of Uzbekistan [www.gov.uz](http://www.gov.uz) was created.

Today, all public authorities and administration have their own websites. At the same time, the rate of paperless paperwork between government agencies is growing. It should be noted that in

addition to the implementation of e-commerce in Uzbekistan, there are also problems. These are psychological factors (our population still can not clearly imagine trading in a virtual environment), insufficiently developed information and communication infrastructure, the inability of entrepreneurs to clearly imagine the possibilities of e-commerce, low computer literacy among middle-aged and older people, banks in the Internet non-establishment of payment services (internet-banking), etc.

Despite the above obstacles, the prospects for e-commerce in Uzbekistan are bright. Because ICT indicators in our country are growing rapidly. And the number of Internet users is growing rapidly.

## CONCLUSION

1. It is necessary to further develop the ICT infrastructure in our country. Because the current ICT infrastructure does not allow us to take full advantage of e-commerce opportunities. The development of ICT infrastructure will accelerate the implementation of e-commerce in our country.
2. The legal framework for the development of e-commerce in Uzbekistan should be improved in the following areas. These are the development of a sequence of legal regulation of online services for the population and business, the strict strengthening of the specifics of certain types of e-commerce services in the law, the procedure for applying to the law on e-commerce, standardization of electronic documents used in e-commerce, licensing e-commerce participants issues of determining the order of the process.
3. Along with the development of ICT infrastructure, it is necessary to increase the computer literacy of the population. To do this, it is necessary to ensure the use of information technology by the younger generation and the deepening of their knowledge in this area.
4. It is necessary to ensure the abandonment of conservative views of banks in working with electronic payments and further development of SMS banking.
5. It is necessary to develop the necessary incentive government programs for entrepreneurs to use e-commerce opportunities and increase their e-economic activity.

## REFERENCES

1. Zaures, A., Elmira, B., Moldir, B., Ainur, A., & Nazym, T. (2020). The development of e-commerce infrastructure in modern conditions. In *E3S Web of Conferences* (Vol. 159, p. 04028). EDP Sciences.
2. Sepashvili, E. (2020). Digital Chain of Contemporary Global Economy: E-Commerce through E-Banking and E-Signature. *Economia Aziendale Online*, 11(3), 239-249.
3. Hakimova, S., Habijonov, S., & Hojaev, A. (2018). Statistical prognosis of the production of fruits and vegetables grown by farmers in the Fergana region. *Bulletin of Science and Practice*.
4. Mamadiyarov, Z. (2020). The innovative approaches of remote banking types services in the process of transformation of banks to E-commerce. *Архив научных исследований*, (12).
5. Türegün, N. (2020). Accounting for the e-commerce sector. *International Journal of Critical Accounting*, 11(5), 429-438.



6. Махмудов, Л. У. (2020). Тадбиркорлик соҳасида электрон тижоратнинг тугган ўрни. *Инновацион технологиялар*, (2 (38)).
7. Кулматова, С. (2020). Рақамли платформалар рақамли иқтисодиёт бизнес модели сифатида. *Архив научных исследований*, (3).
8. Oliy Majlis of the Republic of Uzbekistan. (2015, May 22). No. ORQ-385 dated 22.05.2015. On amendments and additions to the Law of the Republic of Uzbekistan "On electronic commerce". lex.uz. <https://lex.uz/docs/2650293>
9. Atabaeva, Z. A., & Khojaev, A. S. (2020). Investment activity and analysis of investment projects. *ISJ Theoretical & Applied Science*, 5(85), 714-720.
10. Toshtemirovich, R. S. (2020, December). E-commerce security: legal and policy aspects of technology solutions in Uzbekistan. In *Archive of Conferences*, (Vol. 10, No. 1, pp. 153-155).

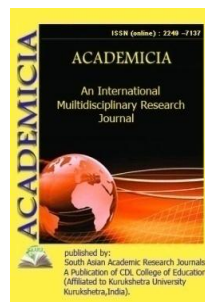

DOI: **10.5958/2249-7137.2021.01095.8**

## ABOUT THE ONE METHOD OF CREATION OF ELECTRONIC TEXTBOOKS

**R. Raxmonkulov\***; **K.K. Toshtemirov\*\***; **G.A. Toshtemirov\*\*\***

<sup>1,3</sup>Almalyk Branch of Tashkent State Technical University named after Islam Karimov,  
UZBEKISTAN

### ABSTRACT

*In this work, one of the tasks of the methodology for creating an electronic textbook is considered, in the example of teaching the subject "the basics of programming for machine tools with programmed control". The basic concepts of file organization have been developed, which are required to reveal the essence of the studied subject using an electronic textbook by the power of a teacher.*

**KEYWORDS:** *Electronic Textbook, CAD, CAM, CAE, Traditional Algorithmic Languages, Video Files, Frame.*

### INTRODUCTION

Modern education is unthinkable without modern teaching aids. Among them are electronic resources, in particular, electronic manuals reproduced on a computer.

### LITERATURE REVIVE

The study of electronic textbooks is presented in the works of O.B. Tyschenko, V.P. Bepalko, N.V. Apatova, N.N. Bulgakov, A.A. Verbitsky, A.M. Podkovyrova, G.K. Selevko, B.S. Gershunsky, M.V. Druzhinin, L.I. Korneeva, I.M. Kurdyumova, K.M. Levitan, T.S. Serova, E.V. Tkachenko, D.A. Toropov and others. Combining the opinions of these authors, we can conclude:

The use of various IT (multimedia, hypertext, diagrams, tables) in electronic textbooks provides significant didactic advantages of an electronic textbook in comparison with a printed one:

- A learning environment appears in multimedia technology with an interesting and visual presentation of information, which undoubtedly attracts the attention of listeners;

- The use of hyperlinks simplifies navigation and provides an opportunity to choose an individual scheme for studying the material;
- Application of modelling of the learning process, allows you to supplement the textbook with texts, track and adjust the trajectory of learning the material, and thus provide feedback.

Taking into account the theoretical analysis of the literature on the topic, the following didactic functions of a modern electronic textbook can be distinguished:

- Increases and stimulates the interest of listeners through multimedia;
- Activates mental activity and the effectiveness of memorizing material due to interactivity;
- Allows you to simulate and visualize processes for presentation in reality;
- allows you to individualize learning by speed, the pace of learning the material, as well as by logic and type of perception;
- Allows you to organize distance learning by correspondence or emergency training;
- Simplicity and ease of handling;
- Ability to update the resource of the electronic textbook;
- Automation of the educational process and an increase in the speed of providing educational services;
- Completeness of the transmitted information.

Such an innovative teaching technology as the use of electronic textbooks has not yet been sufficiently studied, although among the researchers of the role of electronic textbooks in the learning process it is advisable to note various scientists: A.A. Kuznetsov, A.A. Grechikhin, T.M. Lepsova, E.S. Polat, V.A. Wool, V.M. Gasov, A.M. Tsyganenko, V.N. Ageev, M.M. Subbotin, Yu.M. Tsivenkov, E.Yu. Semenov and others [2, p. 53].

The use of the aforementioned electronic textbook in English classes will contribute to the study of this issue. The process of creating and introducing modern electronic textbooks is going on all over the world; many countries have already started using e-textbooks in educational practice. The library and textbooks, where one could find answers to all relevant questions, were replaced by the epochs of the "electronic" version of books, magazines and articles.

Since 2007, the "Electronic Textbook" program has been operating in South Korea and a virtual interactive book has been used, i.e. 3D tutorial using so-called "augmented reality". The results of the experiment showed that academic performance in general increased by 30%.

In February 2012, the US launched the state initiative "The Digital Textbook Collaborative", within the framework of which, in the near future, it is planned to provide every American student with modern electronic textbooks.

In Russia, the introduction of ES was planned within the framework of the national initiative "New School". Under this program, in September 2015, in a number of schools in Moscow, students began to use ES in their lessons [1,3]. Tools for creating electronic textbooks can be divided into groups, for example, using a complex criterion that includes indicators such as

purpose and functions performed, requirements for technical support, and application features. According to this criterion, the following classification is possible:

- Traditional algorithmic languages;
- General-purpose tools;
- Multimedia tools;
- Hypertext and hypermedia tools;

As a technical base, in the future, we mean IBM compatible computers, as the most common in our country and available to educational institutions.

## MATERIALS AND METHODS

This article examines, on the basis of the above classification, the creation of an e-book for teaching students in the direction of "mechanical engineering" at the university. For example, you can take the subject "Programming machine tools with numerical control". It should be noted that at present there are many CAD, CAM, CAE systems that can automatically output the NC program applicable for machine tools with numerical control programs. But using a ready-made control program, he does not understand how to correct a failed situation, or create a new control program, in the event of a change in the technical tool.

This leads to the fact that the user should be sufficiently familiar with the program that he uses. Because of this, students are taught the subject of Numerical Control Machine Programming.

The theoretical description of a part of the subject is not difficult. But to understand all the keywords involved in the program, without the participation of the movement of the cutting element of the machine, in the processing of workpieces. Using traditional algorithmic languages, you can solve this problem. For example, the movement of a cutting tool may be directed by three Cartesian coordinates (up to a maximum of 9 coordinates). This movement cannot be shown using PowerPoint or other programs, which control the movement is based on the frame. Since taking into account any situation, the movement of the cutting tool is either very laborious, or it is not possible. Traditional algorithmic languages, for example, Delphi 7 (C ++, Java, etc.) easily solve the problem. Below is a program is written in this language:

Unit Unit1;

Interface

Uses

Windows, Messages, SysUtils, Variants, Classes, Graphics, Controls, Forms,

Dialogs, ExtCtrls, StdCtrls, Buttons;

type

TForm1 = class (TForm)

Image1: TImage; Image2: TImage; Image3: TImage; Image4: TImage;

Image5: TImage; Image6: TImage; Image7: TImage;

---

```
ScrollBar1: TScrollBar; ScrollBar2: TScrollBar; ScrollBar3: TScrollBar;
Label1: TLabel; Label2: TLabel; Label3: TLabel;
procedure FormCreate(Sender: TObject);
procedure ScrollBar1Change(Sender: TObject);
procedure ScrollBar2Change(Sender: TObject);
procedure ScrollBar3Change(Sender: TObject);
private { Private declarations }
public { Public declarations }
end;
var Form1: TForm1;
var rasm:array [1..10,1..4] of integer;
xn,yn,zn:integer;
implementation
{$R *.dfm}
procedure TForm1.FormCreate(Sender: TObject);
var r:real;
begin
rasm[1,1]:=image1.Height; rasm[1,2]:=image1.Left; rasm[1,3]:=image1.Top;
rasm[1,4]:=image1.Width;
rasm[2,1]:=image2.Height; rasm[2,2]:=image2.Left; rasm[2,3]:=image2.Top;
rasm[2,4]:=image2.Width;
rasm[3,1]:=image3.Height; rasm[3,2]:=image3.Left; rasm[3,3]:=image3.Top;
rasm[3,4]:=image3.Width;
rasm[4,1]:=image4.Height; rasm[4,2]:=image4.Left; rasm[4,3]:=image4.Top;
rasm[4,4]:=image4.Width;
rasm[5,1]:=image5.Height; rasm[5,2]:=image5.Left; rasm[5,3]:=image5.Top;
rasm[5,4]:=image5.Width;
rasm[6,1]:=image6.Height; rasm[6,2]:=image6.Left; rasm[6,3]:=image6.Top;
rasm[6,4]:=image6.Width;
rasm[7,1]:=image7.Height; rasm[7,2]:=image7.Left; rasm[7,3]:=image7.Top;
rasm[7,4]:=image7.Width;
```

---

```

scrollbar2.Position:=scrollbar2.Max;
end;
procedure TForm1.ScrollBar1Change(Sender: TObject);
begin xn:=scrollbar1.Position; image3.Left:=xn+rasm[3,2]; image7.Left:=xn+rasm[7,2];
end;
procedure TForm1.ScrollBar2Change(Sender: TObject);
begin yn:=scrollbar2.Position; image7.Left:=xn+rasm[7,2]; image7.Top:=yn+rasm[7,3]; end;
procedure TForm1.ScrollBar3Change(Sender: TObject);
begin
zn:=scrollbar3.Position; image3.Left:=xn+trunc(zn*cos(pi/3));
image3.Top:=yn-trunc(zn*sin(pi/3)); image7.Left:=xn+trunc(zn*cos(pi/3)); image7.Top:=yn-
trunc(zn*sin(pi/3));
end;

```

With the help of this program, you can show the listeners an infinite number of positions of the cutting tool of the executing organ of programmed machines (Fig. 1). At the same time, you can explain the setting of the executive element of the machine to the beginning of the processing of work pieces. It is then easy to show machining using linear or circular cutter interpolation. It is enough to understand the essence of the block and the commands G00, G01, G02, G03.

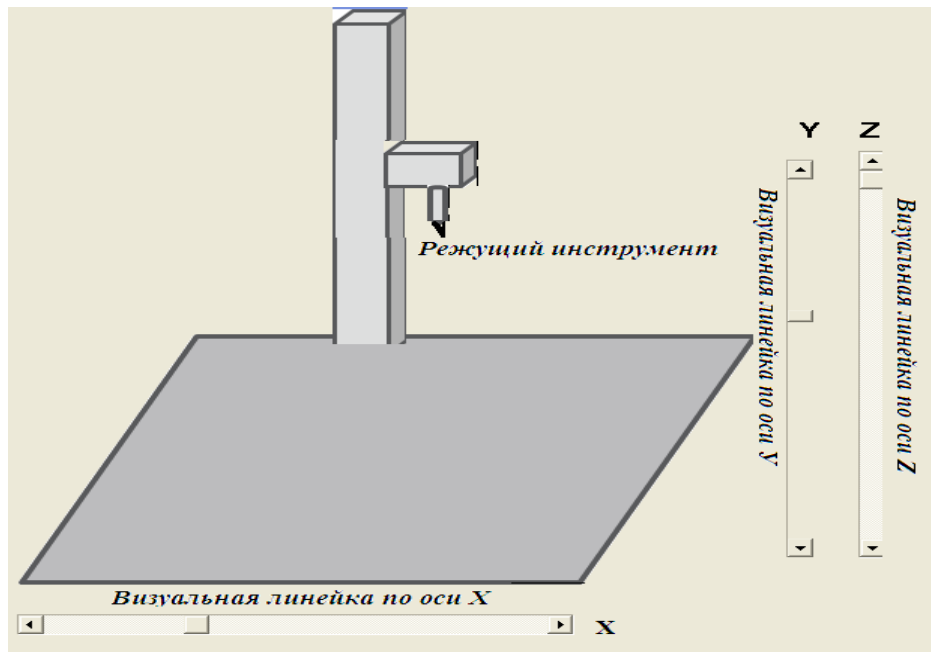

Figure 1.

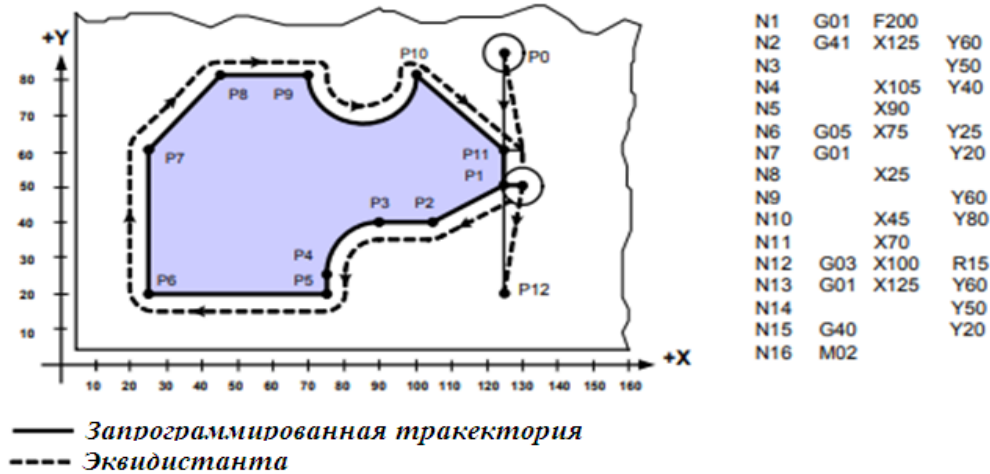

Figure 2.

Using traditional algorithmic languages, it is easy to compose a program illustrating the movement of the organs of a machine tool with numerical control, which is shown in Figure 2 and this program is shown next to the figures. We think everyone knows general-purpose tools in the operating system and it is not required to stop over this split.

Multimedia is now used very often thanks to modern electronic technology. Currently, using the Internet, you can find a lot of different types of videos showing one or another technological process. But these videos show the process that these producers planned to show (Fig. 4).



Figure 3.

Figure 3 shows a commercial for the manufacture of complex machine parts on numerically controlled machines.

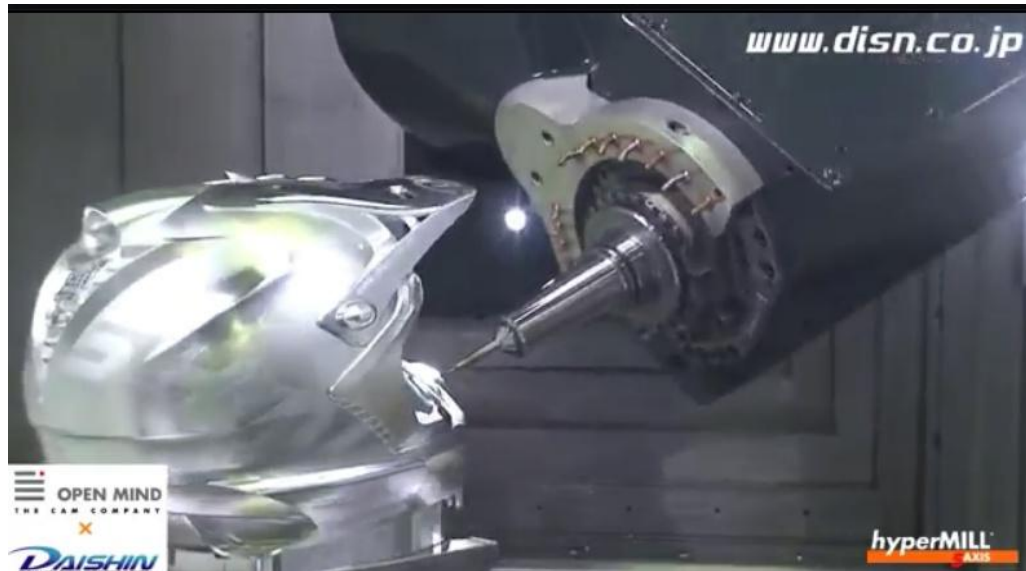

Figure 4.

Figure 4 shows the work of the executive bodies of 9-coordinate machine tools with programmed numerical control. Hypertext links are used to open the necessary files related to the subject. At the same time, it is advisable to use a slinging window, which allows you to correctly redirect the opening of the necessary files. In addition, you can use the speech accompaniment of the lesson.

## CONCLUSION

During the course of classes on subjects, the abacus widely uses modern computer technology. To that end, benefit from the latest advances in this technology. To widely use traditional algorithmic languages, which gives a deeper understanding of the essence of the process, especially required by technical personnel. To save files that are used for explanations of topics, use a separate folder, which makes it easier to organize links to execution files.

## REFERENCES

1. Tregubova O. P., (2014). Creation of an electronic textbook, festival of pedagogical ideas "Open Lesson", Moscow.
2. Kabanov A. M. Electronic textbook as a means of improving the quality of teaching a foreign language at a technical university. 3.00.02-Theory and methodology of teaching and upbringing Abstract of the dissertation for the degree of K.P.N.
3. Federal Institute for the Development of Education (FIRO), Electronic textbooks, Moscow, 2012
4. Koblova, D.V., & Kosareva, S.A. (2012). Electronic textbook as an innovative tool in the educational process. In Actual problems of pedagogy (pp. 146-148).
5. SINUMERIK 840D Programming Manual. The basics. Issue 09.01. [Electronic resource; pdf format], - SIEMENS, 2001.
6. SINUMERIK 840D Programming Manual. Advanced programming. Issue 09.01. [Electronic resource; pdf format]. - SIEMENS, 2001.



7. SINUMERIK 840D Programming Manual. Cycles. Issue 09.01. [Catalog]. - SIEMENS, 2001.
8. SINUMERIK 810D / 840D / 840DL Beginner's Manual: Milling and Turning. Edition 10.03. [Computer file; .pdf]. - SIEMENS, 2003.

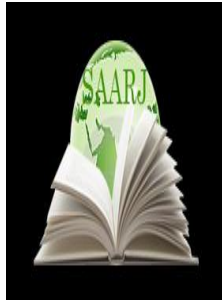

DOI: **10.5958/2249-7137.2021.01094.6**

## TRENDS IN THE DEVELOPMENT AND FORMATION OF ARTIFICIAL INTELLIGENCE IN THE ECONOMY

**Qoldasheva Nargiza Komoliddin qizi\***; **Xidirova Barchinoy Ilxomovna\*\***;  
**Goziev Rzoiddin Cholpon ogli\*\*\***

\*Assistant,  
Department of "Mathematical Methods in the economy",  
Tashkent State University of Economics,  
Tashkent, UZBEKISTAN

\*\*Assistant,  
Department of Management and Marketing,  
Tashkent State University of Economics,  
Tashkent, UZBEKISTAN

---

### ABSTRACT

*Any achievement of science and technology must serve the progress of mankind. At the heart of the state programs aimed at the development of artificial intelligence in our country is the noble goal of improving the quality of services provided to the population, saving time and money of citizens, as well as the developing of the industry at world standards. Economic growth in most countries of the world has slowed in the last decade, caused by structural changes and imbalances in the global economy as a whole. At the present stage, the problems of finding fundamentally new sources of economic development and growth have become actualized, which in the future would determine the success of individual countries and companies in the competition in the world market. The article discusses the main aspects of the use of artificial intelligence technologies in conjunction with the need to ensure sustainable development of the modern world economy.*

**KEYWORDS:** *Economic Development And Growth, Artificial Intelligence, Digital Technologies, Structural Imbalances.*

## INTRODUCTION

In accordance with the Strategy "Digital Uzbekistan - 2030" and in order to accelerate the introduction and widespread use of artificial intelligence technologies in our country, to provide access to digital data and their high quality, to create favourable conditions for training in this field, "Accelerated introduction of artificial intelligence technologies Resolution of the President of the Republic of Uzbekistan No. PP-4996 of February 17, 2021 "On measures to create conditions for the introduction of artificial intelligence technologies in our country, their widespread use, expanding the use of digital data, training of qualified personnel in this field" in other words, many tasks aimed at developing the industry at the level of world requirements have been identified.

Today, "Smart Clocks", which measure our blood pressure, calculate our steps and energy expenditure, "Smart Maps", which guide us by GPS, and various data processing programs are becoming our companions every day. It is noteworthy that the efforts to develop these areas are intensifying in our country. The expanding IT parks, Million Programmers, and Youth Technoparks give hope for the future of the industry. Strategies for the development of artificial intelligence have been adopted in more than 30 countries, including the United States, Germany, Japan, France, Korea, and Canada. The resolution of the President "On measures to create conditions for the accelerated introduction of artificial intelligence technologies" is also in line with the strategy "Digital Uzbekistan - 2030" and the rapid introduction of artificial intelligence technologies and their widespread use in the country, expanding the use of digital data. was accepted for training [1-3].

## MATERIALS AND METHODS

In accordance with the above decision, first of all, financial mechanisms will be developed for the development of the field of artificial intelligence. For this purpose, a special account will be opened in the Fund for Support of Innovative Development and Innovative Ideas under the Ministry of Innovative Development, which will be used to finance artificial intelligence projects. Measures will also be taken to develop mechanisms for financing startup projects.

Artificial intelligence is a technology that focuses on thinking and acting like humans on computers. Artificial intelligence requires high-powered computers, data, artificial intelligence algorithms to work [4-6]. It helps to automate an arbitrary field, analyze big data, and achieve great things. This decision approved a program of measures for the study and introduction of artificial intelligence technologies in 2021-2022. The program identifies several tasks related to the development of artificial intelligence development strategy and regulatory framework, its widespread use in improving the quality of public services, the creation of a local ecosystem of innovative developments in the field and the development of international cooperation.

The resolution also approved a list of pilot projects for the introduction of artificial intelligence technologies in 2021-2022. These projects cover 9 economic and social projects such as agriculture, finance, banking, taxation, energy, healthcare. According to the resolution, the Ministry of Information Technologies and Communications will create technological conditions for the development and implementation of software products. The Ministry of Innovative Development is responsible for supporting scientific and technical research and innovation in the field of artificial intelligence.

According to the resolution, a research institute for the development of digital technologies and artificial intelligence will be established. Also, the organization of research aimed at implementing the strategy "Digital Uzbekistan - 2030" and the development of models, algorithms and software for the introduction of artificial intelligence technologies in the economy, social sphere and public administration, based on which to automate management and production processes. is responsible for functions such as output. According to the decision, a "Joint Union" for the development of artificial intelligence in government agencies, commercial banks and large industrial enterprises is being established. This union will serve for the rapid and joint implementation of priority projects for the introduction of artificial intelligence technologies in the economy and the social sphere, public administration, optimization of costs for their development, dissemination of best practices in this area among government agencies and bodies. By September 1, 2021, a digital data platform will be created for the population and the necessary users to use artificial intelligence-based software and other data.

At the present stage of development of the economies of foreign countries, especially developed ones, ensuring sustainable economic growth remains an urgent problem, since its traditional sources have already been exhausted. The growth of the world economy is mainly due to the high rates of development of developing countries, primarily China. At the same time, even medium-term forecasts show that the world economy will face another imbalance in the coming years, which is generally due to the continuation of the relative strengthening of the competitive positions of some subjects of the world economy. A cursory analysis of these forecasts shows that, for example, by 2022, a decrease in the intensity of economic growth is expected not only in the United States and Japan but also in some developing countries [12].

## RESULTS AND DISCUSSION

The growing risk of the global economy falling into the "slow growth trap" once again testifies to a large volume of problems and imbalances that have accumulated in it. Many national economies remain stable, but at the same time they become ineffective systems, and in this case, this is already a consequence of global institutional traps. Meanwhile, the slowdown in economic growth is largely due to a decrease in labour productivity in individual national economies (although it is obvious that since the 1970s, under the influence of scientific and technological progress, this indicator has been steadily increasing). Thus, recent studies show that over the past two decades in 30 out of 31 developed countries there has been a decrease in labour productivity (for example, if in the United States the average annual value of this indicator was 2.5% in 1995-2005, then in 2005-2015 it was 2.5%). - already less than 1%) [3].

Recently, imbalances in the world economy have been commonly associated with structural imbalances in the financial sector (which is reflected in the growth in the volume of derivative financial instruments, the separation of the financial sector from the real, etc.).

Obviously, this factor has a significant impact, but we tend to associate the imbalances of the modern world economy, first of all, with the different possibilities of the real sectors of national economies for self-growth. The latter, in particular, is associated with such factors as technological readiness, the maturity of the country's innovation system, leadership in the latest technologies and knowledge. Artificial intelligence (AI), analysed in the framework of this article, is considered by us as a fundamental attribute of the development of the world economy,

which, even if it does not contribute to the elimination of these imbalances, will definitely contribute to its self-growth as a whole.

The expansion and deepening of AI technologies can have an even greater positive impact on economic growth. Foreign experts predict that based on the introduction of artificial intelligence (AI) technologies by 2035, it is possible to double the rate of economic growth and increase labour productivity by 40% in developed countries [5].

At the same time, the positive impact of AI on the world economy for the next decade is estimated in the range of 1.49-2.95 trillion, dollars, while in the group of high-income countries GDP due to the use of AI will increase by \$ 296.5-657.7 billion [4].

At the same time, one should take into account the direct impact of AI on GDP, when GDP growth is achieved due to the growth of sectors producing AI technologies, and indirect (when labour productivity increases in traditional industries using AI). According to PwC forecasts, by 2030, as a result of the use of AI, global GDP growth will be 14% higher, which will add an additional \$ 15.7 billion to the world economy in added value. At the same time, the benefits from the use of AI will be distributed unevenly: for example, the corresponding GDP growth in China will be 26%, in Europe - 9%, developed countries in Asia - 12%, and in general for the group of developing countries - less than 6% [2].

Thus, the use of AI will further enhance the uneven development of individual countries, which, paradoxically, will in the long term be the main factor in the growth of the world economy as a whole. What are the effects of AI on global economic growth? It is possible that the ongoing automation and intellectualization of production will offset the contribution of population growth to the exponential growth of the world economy, as AI contributes to an ever greater replacement of human labour. Theoretically, according to the researchers, AI can contribute to "... the creation of infinite income in a finite period of time" [1].

For the economies of countries such as China, the problem of leadership in the global AI market is most acute. In 2017, the growth rate of the Chinese economy is expected to slow down to 6.7% (by 2022 - to 5.8%) [8]. China is gradually losing its traditional drivers of economic growth: only two of them survived - the country's active foreign investment in infrastructure projects and the creation of fundamentally new technologies based on AI. That is why the country's leadership is pursuing a policy of achieving leadership in the field of intellectual development, gradually catching up with the United States in many ways. Analysts at the Boston Consulting Group (BCG) expect that 415 million new jobs will be created in the digital sectors of the Chinese economy by 2035, and the share of the digital economy in GDP will reach 48% [9].

The last aspect is fundamentally important: the economy of any country, introducing AI technologies, refuses a certain number of jobs, gradually replacing human labour.

However, in the economies of developing countries, where the branches of the digital economy have not yet been essentially created, the use of AI, on the contrary, leads to their creation, thereby contributing to increased employment.

Therefore, the idea that the development of AI systems and technologies negatively affects labour markets is not well-founded, especially when it comes to emerging markets.

---

What is the key implication of human labour replacement for economic growth?

The fact is that the massive replacement of labour as a factor of production will inevitably lead to a decrease in income in the respective national economies (if only because all employed people receive a certain income), and this already leads to a decrease in demand. Restrictions on demand in the context of a large aggregate supply of goods and services in the world economy will lead to even greater overproduction.

Despite the fact that earlier we indicated a slowdown in the growth of the world economy, nevertheless, in accordance with the available forecasts, in the long term, it is a group of key developing countries in terms of the volume of GDP created that will lead in comparison with developed countries [11, p. nine].

We considered two groups of countries - E7 (Emerging 7 - a group of leading developing countries: China, India, Brazil, Mexico, Russia, Indonesia, Turkey) and G7 (G7 countries: USA, Japan, Germany, France, Great Britain, Italy, Canada).

This leadership will strengthen in favour of the former (from the standpoint of our analysis, this is the same gap, but in favour of another group of countries, leading to another imbalance in the world economy).

In this regard, we believe that in the group of developed countries the use of AI technologies will be increasingly socially oriented, while in developing countries, on the contrary, it will be determined by the requirements of the development of industrial sectors.

It should be added that active participation in international trade for any country is also a significant factor in economic growth. Modern international trade is increasingly "digitalized": the export of information and communication services for the period 2010-2015 increased by 40%. The volume of e-commerce trade reached \$ 25.3 trillion, while the United Nations Conference on Trade and Development (UNCTAD) estimates cross-border deliveries using the "business-to-consumer" system (English - B2C - bussines4o-cusloter) at 189 bills. Dollars (7% of all e-commerce), while almost 42% of these supplies fall on only two countries - the United States and China [7]. The positive impact of AI on international trade lies primarily in increasing its mobility through ensuring more flexible operation of global supply chains, saving time for logistics and sales, introducing smart contracts into business practices, and increasing the availability of loans for trade finance.

The world is gradually witnessing a transition from traditional trade (starting in the 1920s) to e-commerce and further to trading using AI technologies [10].

At the same time, the growth of international trade mobility will inevitably lead to increased international competition, which, in turn, will increase the technological superiority of some countries and lag behind others. On the other hand, due to the limited use of AI in certain industries (for example, in the extractive industries, the requirements for technologies are not as great as in the manufacturing industries), international competition will reach the greatest extent in the service and high-tech industries. At the same time, the assessment of the involvement of different groups of countries in the world market of AI systems will remain an interesting object of special scientific research. We are talking about different countries not in terms of the level of their socio-economic development, but in terms of, for example, the capacity of markets (small

and large in terms of the territory and population of the country), the presence of “niche” industries in the national economy (for example, in the countries of Northern Europe).

## CONCLUSION

Analysing the role of AI as a new factor of production, one should identify the degree of its impact on national economies, assess its effects on internal economic growth. Equally important is the assessment of the implications of AI for assessing (and re-evaluating) the gains of countries from participation in international trade and its distribution among countries.

Another important aspect from the standpoint of economic growth: since AI is objectively a new category, this means that new goods and services can be created on its basis. This, in turn, shows that the volume of markets and the world economy as a whole can be expanded (although in the course of their evolution, markets have been constantly expanding, which was due to the influence of scientific and technological progress). If we compare the growth rates of the world market of AI systems and technologies and the growth of effective demand in the world economy, then the former is significantly superior to the latter. Considering that in the structure of world consumer demand there is an increasing substitution of traditional goods created based on AI, it should be understood that, in principle, the conditions for such substitution are still extremely limited. This alignment shows that the supply of goods and services based on AI will inevitably grow faster than demand.

And this is another limiting factor in the context of considering the role of AI in economic the growth of the world economy (i.e. in the long term, despite the rapid development of the global AI market, restrictions on this growth will remain).

## REFERENCES

1. Aghion, P. Artificial Intelligence and Economic Growth / P. Aghion, B.F. Jones, C.I. Jones // NBER Working Paper, October 2017/ - 56 p.
2. AI to drive GDP gains of \$15.7 trillion with productivity, personalisation improvements // PwC Press Room. - 27.06.2017
3. Artificial Intelligence, Automation, and the Economy. - US., Wash DC.: Executive Office of the President, December 2016. - 49 p.
4. Matyushok, V. M., Krasavina, V. A., & Matyushok, S. V. (2020). Global artificial intelligence systems and technology market: formation and development trends. *RUDN Journal of Economics*, 28(3), 505-521.
5. Fuel for Growth // Accenture [Electronic resource]. - Mode of access: <https://www.accenture.com/us-en/insight-artificial-intelligence-future-growth> (дата обращения: 27.10.2017).
6. Graetz, G. Robots at Work / G. Graetz, G. Michaels // The London School of Economic and Political Sciences: Centre for Economic Performance (CEP) Discussion Paper No 1335, March 2015. -53 p.
7. Information Economy Report - 2017. - UN: UNCTAD, 2017. - 112 p.

8. People's Republic of China: 2017 Article IV Consultation-Press Release; Staff Report; and Statement by the Executive Director for the People's Republic of China // Country Report No. 17/247.- IMF, August 8, 2017. - 92 P.
9. Popkova, E. G., & Parakhina, V. N. (2018, April). Managing the global financial system based on artificial intelligence: possibilities and limitations. In *International Conference Project "The future of the Global Financial System: Downfall of Harmony"* (pp. 939-946). Springer, Cham.
10. The Future of Trade 'Who, what, where & how' automation and artificial intelligence are disrupting the marketplace. L.: Big Innovation Centre, July 2017. - 52 p.
11. The World in 2050. Will the shift in global economic power continue? - PwC, February 2015. -43 p. (P. 9).
12. World Economic Outlook April 2017. Gaining Momentum? - Washington, DC: International Monetary Fund, 2017. 238 p.





**ACADEMICIA**  
**An International**  
**Multidisciplinary**  
**Research Journal**  
 (Double Blind Refereed & Peer Reviewed Journal)



**DOI: 10.5958/2249-7137.2021.01091.0**

## THE EFFECTIVENESS OF USING THE CREDIT MODULE SYSTEM IN THE HIGHER EDUCATION SYSTEM

**Xidirova Barchinoy Ilxomovna\***; **Goziev Rzoiddin Cholpon ogi\***

\*Assistant,  
 Department of Management and Marketing,  
 Tashkent State University of Economics,  
 Tashkent, UZBEKISTAN

### ABSTRACT

*This article reflects the complex issues of the effectiveness of the use of the credit module system in the higher education system and the introduction of the credit module system in higher education. Its purpose is to provide the necessary information on the organization of educational processes in the credit-module system of higher education. The article introduces and briefly explains the terms of the credit-module system, which allows getting acquainted with the basic concepts of the new system, to explain the education policy in different countries and the transition to a single multi-level international program.*

**KEYWORDS:** *Credit, System, Compulsory Subjects, Elective Subjects, Independent Study, Working Hours, Study Hours, Independent Work.*

### INTRODUCTION

In the system of "credit module" of education, which is gradually entering the system of higher education of the Republic of Uzbekistan, higher education institutions can develop catalogues (booklets) for each bachelor's or master's program and which subjects can be studied transparently by students, who teaches these subjects, giving detailed information about what knowledge, skills and abilities will be acquired during the program, after which the start of the academic year is one of its positive aspects. As part of the integration of the national education system into the global educational environment, the Government of the Republic of Uzbekistan and the Ministry of Higher and Secondary Special Education have developed strategic plans to ensure the comprehensive transition of our higher education system to the Bologna process. came out. . The concept of development of the higher education system of the Republic of Uzbekistan until 2030 has a special place in these processes [1-3].

At present, the credit-module system is being formed as one of the mechanisms for the integration of the higher education system of the Republic of Uzbekistan into the international educational environment. One of the unique features of this system is that it emphasizes the independent learning of students, which in turn shapes the lifelong learning skills of future professionals. Therefore, the next stages of modernization of higher education in the Republic of Uzbekistan are aimed at testing the credit-module system as a basis for the organization of the international academic education system [4,5].

## **MATERIALS AND METHODS**

The educational process in higher education is a complex process that includes many aspects, such as the development of organizational, managerial, educational activities for the preparation of highly qualified specialists.

The learning process consisted mainly of training sessions and monitoring processes. Courses include all types of academic preparation, student self-study and practice. The control processes show how well the students have mastered the curriculum.

The planning of the educational process is one of the important elements of the management of the educational activities of the university. It is carried out in the following stages:

- Initially, during the academic year, an academic calendar will be created, reflecting the main educational processes and the timing of their implementation;
- In addition to the standard curriculum, a list of optional subjects will be formed;
- After a typical curriculum and a list of optional subjects for each student, an individual curriculum is formed under the supervision of the registration office and the dean with the help of consultants;
- working curricula have been developed;
- working curricula of disciplines have been developed;
- After the working curricula of areas and specialities, the workload of departments is planned and the staff of the teaching staff and the loans allocated to them are approved;
- The program is designed in accordance with academic directions and groups.

The standard bachelor's program consists of 4 blocks:

- a) block of humanities and natural sciences;
- b) a block of general professional disciplines;
- c) block of special sciences;
- d) additional scientific block

The standard master's program consists of 3 blocks:

- a) block of general methodological sciences;
- b) a block of special sciences;
- c) block of elective sciences.

Disciplines in scientific blocks can be compulsory and optional. Compulsory subjects include the topics specified in the qualification requirements that must be mastered. Optional subjects include topics provided by the university at the request of staff.

Compulsory subjects are included in standard curricula along with credits assigned to them. Credits for elective subjects are determined independently by higher education institutions. Working curricula of the direction and specialization are developed on the basis of individual curricula of the largest contingent of students in order to optimize costs. Adaptation of the working curriculum to a wide contingent, which will fully cover the future professional activities of students, will increase the effectiveness of the educational process.

In the system of credit training, the volume of educational work is determined by the volume of training materials and is measured by credits[5-7].

Credit is a unit of measure for academic workload, which can be equal to 30 academic hours (in a 15-week semester). At the same time, the number of classrooms and independent study hours at the bachelor's and master's level can be 1: 1.

The size of each item is represented by the total number of credits. Considering that the average number of subjects does not exceed 40, each subject can be allocated on average  $240/40 = 6$  credits, and for subjects, there may be more or fewer credits. The share of classroom lessons in the working curriculum (lecture, practical, laboratory, etc.) is determined by the scientific and methodological council of the university based on the conclusion of the commission based on the methodology of teaching the subject. Each subject in the curriculum must have a unique name. At the bachelor's level, it is desirable that the number of subjects is small and the volume is large. When determining the share of compulsory and optional subjects in the curriculum, it is advisable to take into account the requirements for the level of teaching, the content of subjects and learning outcomes, the structure of disciplines and their interdependence and the degree of unification.

All types of internships and theses are carried out under the program of additional natural science education and are included in the total amount of credits. In the final semester, 15 credits for internship and 15 credits for postgraduate study are recommended. It is advisable to teach physical education in sports sections at the expense of additional subjects.

The total weekly workload is 60 hours at the undergraduate level, of which 30 hours are allocated for the classroom and 30 hours for self-study of students, including 8-14 hours of independent work under the guidance of a teacher. According to table 1, the student's time budget is as follows: theoretical lessons -  $240 \times 30 = 7200$  hours, including in classrooms -  $15 \times 240 = 3600$  hours, for independent work -  $15 \times 240 = 3600$  hours.

As you can see, the student's workload per semester is 30 credits and is a 1: 1 sum and an independent study load (240 credits: 8 semesters = 30 credits). The credit system of education provides for the planning of educational activities of teachers and students according to an individual educational trajectory for the current academic year.

At the heart of any educational process is an individual curriculum, which is developed by a student before the start of the educational process on the recommendation of a consultant. The basis for its development will be a standard curriculum, including compulsory and optional subjects specified in the qualification requirements. Individualized study programs should reflect

the needs of the labour market, the needs of employers and the interests of students. At the same time, they contribute to the formation of general literacy, socio-economic, organizational and managerial, general scientific, professional and specialized skills so that bachelors can freely find their place in the labour market and continue their studies in the future. Accordingly, when developing individual curricula in certain areas and specialities of higher education, a list of disciplines is recommended that will allow students to fully master the professional skills set out in state educational standards, and qualification requirements are given. For example, a Bachelor of Engineering provides general technical knowledge in the natural sciences, information technology, and engineering graphics. Accordingly, it is advisable to include subjects that are the basis of professional activity in the optional part of the general education block. Working curricula are based on the approved individual curriculum for all students. At the same time, it is very important to create conditions for a conscious approach for students. The level of professional training of a future specialist depends on how carefully thought out and improved the educational trajectory of students. Consequently, higher education institutions will have to organize consulting services in their organizational structures. The consultants can be both experienced teachers of specialized departments, whose students have the opportunity to formulate individual curricula and specialists of the enterprise who replace it. When drawing up an individual curriculum, the student must take into account the study of subjects in the amount of 30 credits per semester, which must include compulsory subjects in the standard curriculum.

The student also has the right to choose science teachers. Students must provide information on the academic level and status of teachers, as well as on the educational and regulatory documents they have developed. In order to create conditions for pupils to choose a teacher, there will be open lessons for teachers who want to teach science in the first week of the semester, the teachers' lessons must be scheduled at different times. One of the most important issues of educational activity is planning the workload of universities and departments. The norms of the pedagogical load must be approved before the planning of educational work. Currently, the norms of the teaching load are recommended by the Ministry of Higher and Secondary Specialized Education. In the current conditions of globalization and reforms in the field of higher education, several factors are on the agenda that determine the ranking of higher education institutions.

Therefore, it is advisable for each university to take them into account and make adjustments to the norms of the pedagogical load in terms of increasing its rating and organizing the educational process in a modern way. The provision of such opportunities to higher education institutions by the Ministry of Higher and Secondary Specialized Education creates a solid foundation for improving the efficiency of teachers and raising the ranking of higher education institutions.

Planning the workload of the department and the staffing of the department of higher education should be based on the working curricula of the bachelor's and master's degrees. In this case, the calculation of the study load is based on credits. Planning workloads in the context of a credit education system also depend on the number of academic streams and their capabilities. In the credit education system, academic streams and groups are formed depending on the number of students admitted to study subjects. In this case, in the first week of the academic semester, all candidates recommended for the study of the subject study on the basis of voluntary student participation, and the process ends with the enrollment of students in the subject of their choice. From next week, academic streams and groups will be formed based on the selection of students.

To determine the number of academic streams and groups, the university must determine in advance the permissible limits for the number of students for lecture, practical and laboratory classes in subjects.

The number of teachers will depend on the type of training load for the positions. The hierarchy of associate professors should be revised in connection with the transfer of all teaching positions to the credit training system. As a rule, the speaker can be a professor or associate professor, a tutor - assistants. In this case, the composition of speakers and teachers is determined based on the ratio of lectures and other types of lessons. The ratio of the total workload of a university to the number of professors determines the average workload per professor. The number of professors and teachers in higher education faculties is traditionally determined by dividing the workload by the average workload per teacher and rounding the result to 0.25.

## RESULTS AND DISCUSSION

It is advisable to differentiate the average workload of teachers of the department according to the positions of professors, associate professors and assistants. After that, the departments begin to plan and distribute the teaching staff based on the established workload. It is recommended that topics corresponding to a one-day teacher per semester are 3-6 in the faculties of the speciality.

The general pedagogical load of teachers includes all classroom loads (lecture, practical, laboratory, etc.), independent types of student work under the guidance of a teacher (accounting work, course work, thesis, master's work), qualification practice and others.

The planning process for the school year ends with the development of lesson plans, copies of which are distributed to teachers and students. When scheduling lessons, it is recommended to evenly distribute the workload of the teacher and students throughout the week.

The educational process is organized on the basis of approved curricula, academic calendar, staffing table, academic flow and groups, lesson schedule and independent work of students under the guidance of a teacher. All information on the organization of the educational process is posted in the windows of faculties and departments, as well as on the university website.

Higher Education Institutions operating in the credit system of education must create the most favourable conditions for their students to master special subjects within the framework of state educational standards and qualification requirements, as well as to complete their studies and obtain an academic degree. In this case, the university is responsible for the methodological support of the educational process. For this purpose, the following will be developed:

- a) information and instruction for each student;
- b) curricula for each subject (working curricula);
- c) teaching materials for classroom studies in subjects (lecture notes, descriptions of practical and laboratory classes, interactive handouts, multimedia applications, etc.);
- d) materials for independent work of students under the guidance of a teacher (homework and assignments, control materials for self-assessment, abstracts and term papers (projects) and methodological materials for their implementation, electronic teaching materials);

- e) materials for testing knowledge (written test assignments, written and electronic tests, exam tickets);
- f) materials used in qualification practice (plans and training programs, diaries, forms of reporting documents);
- g) materials for independent work of students (digests, frequently asked questions), curricula, platforms for distance learning and forums.

An important aspect of the educational process is the organization of students' enrollment in subjects (selection of teachers). To do this, students choose subjects under the guidance of a dean and the guidance of an advisor. In the first week of the semester, teachers are selected by attending classes and analyzing them.

Registration of students in the disciplines is carried out by the Registrar's Office (RO) in the following order:

1. A new student receives a working curriculum for the 1st year from the dean's office in August before the start of the course. After consulting with the Adviser and selecting subjects, he or she enrolls in the subjects of his or her choice during the first week of study, forms a personalized curriculum for his or her academic year, and meets science teachers by attending classes, answers questions of interest, and selects science teachers. After that, it is not allowed to change the individual curriculum for the current academic year.
2. In the first week of November of the fall semester and April of the spring semester, students select subjects for the next semester and make adjustments to their individual work plans. The amended individual curriculum is signed by the student and submitted to the RO.
3. The RO, in agreement with the deans, determines the minimum number of students studying in the disciplines, and for each teacher - the maximum number of students studying in the academic stream (group).
4. If less than the prescribed number of students are enrolled in an elective subject, that subject will not be opened and it will not be included in the working curriculum. The RO will announce this within a week in the information window and on the faculty page on the university's website. A student enrolled in a cancelled elective subject must re-select the subjects within one week of the announcement and apply them to the RO for changes to the individual curriculum. In shaping the student's personal educational trajectory and enrolling in elective subjects, the student's study of the underlying subjects (prerequisites) is taken into account, otherwise, the student will not have the right to choose this subject. It is also important for the student to know which subject (post requisites) will be the basis for the subject of his/her choice in the future.

The summer semester is one of the important components of the curriculum in the context of the credit education system. It is organized on a paid basis at the initiative of the student to obtain additional knowledge, transfer academic debts, and eliminate differences in the educational program.

The duration of the summer semester is determined based on the academic calendar by areas, specialities, and courses.

Studying in the summer semester is allowed in the following cases:

- Students with “good” and “excellent” grades (for additional education);
- students who did not pass the exam on the results of rating-control (for full mastery of the subject);
- students who have academic debts for previous academic periods (to apply for academic debts);
- Students who are recovering, transferring and returning from academic leave (so that they can eliminate differences in subjects).

The RO must take into account the GPA level of the students when allowing them to study in the summer semester. For example, a GPA of 3 or higher (B) allows you to study up to 4 subjects, and a GPA of 2.0-3 allows you to study up to 3 subjects.

The summer semester is organized according to the following regulations:

- before the start of the summer semester, the student applies to the RO with an application stating the reasons and interests of his / her study in the summer semester;
- RO reviews student applications;
- At the end of the spring session, the RO decides on the admission of students to the summer semester;
- The RO draws up a course schedule for the summer semester and submits it to the Vice-Rector for Academic Affairs after the student has paid the tuition fee. The course schedule is based on the free time of lecturers and tutors involved in the summer semester;
- The summer semester is organized according to the current system of assessment and the principle of independent assessment of students; In addition to the curriculum, the final assessments in the subjects organized based on students' interests can be carried out by lecturers and tutors who taught in the summer semester;
- RO is responsible for timely payments for the summer semester.
- The results of the examinations mastered in the summer semester in the disciplines of specialization curricula determine the level of GPA for the next academic year.

## CONCLUSION

Particular attention is paid to providing the educational process with normative and methodological working documents. It reveals the content and importance of new educational-methodical documents for students, for example, educational-methodical complexes of specialities and disciplines, catalogues of elective subjects.

The organization of educational processes in the credit-module system ensures the transparency of all types and stages of educational activities in higher education. The selectivity of education, the freedom to choose the individual educational trajectory, the regular monitoring and recording of students' mastery and achievements increase his interest in learning, his constant research and reading, self-improvement and engages in an independent study.

Thus, the proposed credit-module system, based on a comparative analysis of traditional and new approaches to the organization of the educational process, has the following advantages:

---

- increase the level of academic freedom (independent choice of subjects, setting deadlines, selection of teachers);
- the share of independent learning in the educational activities of students will increase (at least 50%);
- Ease of converting lesson schedules into a 5-day system (30 hours per week, 6 hours per day);
- the emergence of a developmental environment in the teaching activities of teachers (counselling classes, independent work of students under the guidance of a teacher);
- Decrease in the share of theoretical knowledge and increase the measurable practical skills of the student (criteria for the introduction of various interactive teaching methods, the continuation of practical training in independent teaching and their assessment through concrete activities);
- educational activities of students focused on independent research (study on the trajectory of individual education of their choice);
- to teach students to be independent in life, to allow them to study in different academic groups each semester;

## REFERENCES

1. Resolution of the Cabinet of Ministers of the Republic of Uzbekistan dated January 5, 1998 No 5 "On the development and implementation of state educational standards for continuing education."
2. Resolution of the Cabinet of Ministers of the Republic of Uzbekistan dated August 16, 2001 No 343 "On approval of state educational standards of higher education".
3. Reform and development of higher education. UNESCO, Paris, 1995.
4. Lisbon Convention: "On the recognition of qualifications related to higher education in the European region". April 11, 1997
5. Resolution of the Cabinet of Ministers No. 824. (2020, December 31). 824-son 31.12.2020. On measures to improve the system related to the organization of the educational process in higher education institutions. lex.uz. <https://lex.uz/docs/5193564>
6. "National Training Program" of the Republic of Uzbekistan. Tashkent, 1997, August 29 №463-1.
7. Bologna Declaration "On the European region of higher education". g. Bolonia, Italy. 1999.





**ACADEMICIA**  
**An International  
 Multidisciplinary  
 Research Journal**  
 (Double Blind Refereed & Peer Reviewed Journal)

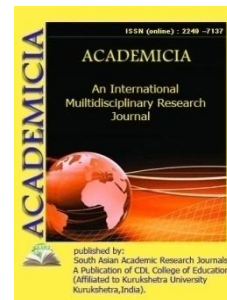

**DOI: 10.5958/2249-7137.2021.01087.9**

**DEVELOPMENT OF EFFECTIVE COMPOSITIONS OF THERMAL-  
 SALT-RESISTANT COMPOSITE CHEMICALS USING LOCAL AND  
 SECONDARY MATERIALS**

**Sharifov Gulomjon\*; Negmatova Komila\*\*; Sharipov Shavkat\*\*\*;  
 Urazov Sharofiddin\*\*\*\*; Abdullaev Nurmukhammad\*\*\*\*\***

\*Lecturer at the Department of Chemistry and Teaching Methods,  
 Jizzakh State Pedagogical Institute, UZBEKISTAN  
 Email id: sharifov-gulom@mail.ru

\*\*Senior Researcher,  
 Doctor of Technical Sciences,  
 State unitary enterprise «Fan va taraqqiyot»,  
 UZBEKISTAN

\*\*\*Candidate of Chemical Sciences,  
 Jizzakh State Pedagogical Institute, UZBEKISTAN

\*\*\*\*Lecturer,  
 Department of Chemistry and Teaching Methods,  
 UZBEKISTAN

\*\*\*\*\*Lecturer at the Department of Chemistry and Teaching Methods,  
 The Republic of UZBEKISTAN

---

**ABSTRACT**

*The article presents the results of research on the development of effective compositions of thermo-salt-resistant composite chemical reagents using local and secondary materials. Due to the high salinity of the reservoir water for the preparation of drilling fluids, water is brought from long distances and costs increase significantly. Based on the conducted research, we propose to introduce 3-20% (depending on the amount) of the KHR-R reagent to the composition of the drilling mud as an acid-soluble additive when opening fractured oil and gas reservoirs.*

**KEYWORDS:** *Composition, Chemical Reagent, Drilling Fluids.*

## INTRODUCTION

The big problem today facing the drillers of the oil and gas industry of our republic is the creation of reliable and affordable chemical reagents and drilling fluids that are resistant to the aggressive effects of high-pressure, highly mineralized water during rapaproyavlenie, used when drilling the salt-bearing strata of fairly stable rocks. The thickness of the rapaproyavleniya is from 500 to 1500 meters at the depth of the well 1500-3000 meters.

Brine consists mainly of melts of magnesium chloride ( $MgCl_2$ ) and magnesium sulfate ( $MgSO_4$ ) salts. When drilling salt deposits, the melt of these salts under reservoir pressure begins to push the working drilling fluid out of the well. As the upper zones of the borehole are reached, the melt cools and, when mixed with the working drilling fluid, crystallizes, which leads to the capture of the drilling tool. Most often, drilling operations are stopped and this well is preserved. Currently, there are several dozen such preserved wells in the western fields of Uzbekistan (Beshkent, Kultak, Zevasi, Pamuk), for which multimillion-dollar financial resources have been spent {1}.

The composite chemical reagents and drilling fluids based on them developed by us will be heat-resistant, will allow to deconservate the above-mentioned wells and accelerate the opening of productive horizons in these fields.

Another important problem is the use of reservoir water for the preparation of drilling fluids. Due to the high salinity of the reservoir water for the preparation of drilling fluids, water is brought from long distances and costs increase significantly. The composite chemical reagents developed by us will make it possible to obtain rapa-resistant drilling fluids using highly mineralized reservoir waters.

Thus, the development of technology for the production of composite chemical reagents for the preparation of rapa-resistant drilling fluids using highly mineralized reservoir waters is a very urgent problem {1-3}.

**Research objects.** The objects of research are caustic and soda ash, carboxymethylcellulose-CMC, polyacrylamide (PAA) and some inorganic mineral ingredients. Recently, in the course of carrying out research work on the development of effective composite chemical reagents for clay-free drilling fluids, we have chosen the composite chemical reagent-rapaproyavleniya (KHR-R) as the object of research.

**Research methods.** In determining the physical, chemical and operational characteristics of the developed composite materials, as well as organic and inorganic ingredients, methods, devices and installations were used in accordance with the relevant GOST standards adopted in the CIS.

**The results of the study.** The steady increase in the share of deep exploration drilling in the total volume of drilling operations constantly requires the creation and introduction of highly effective, cheap and affordable chemical reagents – stabilizers of drilling fluids.

Currently, when drilling oil and gas wells, a wide variety of chemicals necessary for drilling fluids, both domestic and foreign production, such as CMC, K-4, K-9, GIPAN, SSB, CSSB, NaOH,  $CaCO_3$ , USHR and others, are used, which are expensive and many of them are imported to Uzbekistan from abroad. However, these reagents do not always meet the requirements for reagents used in the complicated geological and technical conditions of Uzbekistan {4-5}.

We have developed composite chemical reagents for drilling in saline and chemical aggressive environments since it is stable to cations in polyvalent salts ( $Mg^{++}$ ,  $Ca^{++}$ ,  $Na^+$ ,  $K^+$ ). When developing new composite chemical reagents, we used local raw materials, waste from food production and waste from non-ferrous metallurgy. The main physical and chemical properties of the composite chemical reagent KHR-R (composite chemical reagent-rapaproyavleniya) are given in Table № 1.

**TABLE №1 PHYSICO-CHEMICAL PROPERTIES OF THE COMPOSITE CHEMICAL REAGENT-RAPOPROYAVLENIE (KHR-R)**

№	Name of indicators	Characteristics of the norm
1	Color	from light brown to brown
2	Consistency	Solid powder
3	Specific gravity, g/cm <sup>3</sup>	1,10
4	Solubility in water, %	97
5	Main substance, %	75
6	Mass fraction of total fat to the mass of KHR-R, %, not less	5,5
7	Conditional viscosity of 10 % solution, s	24
8	Acidity, 10% solution	11
9	Humidity, %	5

From Tables No. 1, it can be seen that the composite chemical reagent-rapoprevention has qualitative characteristics when used for drilling fluids, such as high acidity, water solubility, and partially affects the filtration of solutions.

At the suggestion of JSC "Uzgeoburneftegaz", laboratory tests were carried out in the Service Service for drilling and cement solutions of JSC "Neftegazispytanie" to obtain a weighted drilling mud based on the developed composite chemical reagent-rapaproyavlenie (KHR-R). The results of laboratory tests to obtain a formulation of weighted drilling mud based on the chemical agent KHR-R are shown in Table No. 2.

**TABLE № 2 TECHNOLOGICAL PARAMETERS OF WEIGHTED DRILLING MUD BASED ON KHR-R AND BARIT (UZBEKISTAN)**

№	Composition of weighted drilling mud	$\rho$ , g/sm <sup>3</sup>	T <sub>500</sub> , s	F, sm <sup>3</sup> /30 min	T <sub>10</sub> , mm	pH
1.	1000 ml R-Solution (Chulkuvar 39)	1,34	52	10	1,2	9
2.	No. 1 r-r + 100 g NaCl	1,38	64	12	1,5	7
3.	No. 2 r-r +60 g KHR-R	1,32	69	8	1,0	9
4.	No. 3 r-r +100 ml Oil	1,34	72	8	1,0	9
5	No. 4 r-r +1000 g barit (Uzbekistan)	1,81	195	8	1,0	9
6	After heating at 80 °C	1,81	90	8	1,0	9
7	No. 4 r-r + 5 g CMC 80°C	1,81	148	5,5	0,8	9

Table 2 shows that it is possible to obtain a weighted drilling mud with a density of 1.81 g/sm<sup>3</sup> based on the chemical agent KHR-R and CMC of Namangan production. The acidity of the weighted drilling mud based on the chemical agent KHR-P is reached to 9 without the addition of caustic or soda ash.

The composite chemical reagent-rapoprevention (CCR-R) also has a positive effect on the filtration properties as it has decreased from 12 sm<sup>3</sup>/30 min to 8 sm<sup>3</sup>/30 min. According to the results of the conducted laboratory tests, a production test was recommended at the fields No. 39 Chulkuvar of Uzgeoburneftegaz.

In well No. 39 Chulkuvar, production tests of weighted drilling mud based on composite chemical reagent-rapaproyavleniya (KHR-R) and CMC of Namangan production (CarboNam) were carried out. The well uses a rotary type of drilling design depth of 3600 m, salt-anhydrite strata from 2800 to 3200 m drilled with weighted drilling fluids based on the chemical agent KHR-R and CMC (CarboNam). The results of the production tests carried out in the well No. 39 Chulkuvar are shown in Table № 3.

**TABLE № 3 TECHNOLOGICAL PARAMETERS OF WEIGHTED DRILLING MUD  
BASED ON THE COMPOSITE CHEMICAL REAGENT KHR-R**

№	Date	Go deep on, m	Composition of treated weighted drilling mud	Specific gravity, g/sm <sup>3</sup>	Viscosit, T,s	Water recoil, sm <sup>3</sup> /30 min	pH	Crust, mm
1	4.03	2808	Initial clay solution	1,34	52	10	8	1,2
2	5.03	2808	Initial Solution + KHR-R (5%) + Oil (5%) + CMC (0.5%) + NaCl (2%) + Barite (40%)	1,60	56	8	9	1,0
3	6.03	2808	Initial solution + KHR-R (4%) + Oil (4%) + CMC (0.5%) + NaCl (2%) + Barite (30%)	1,76	58	8	9	0,8
4	7.03	2808-2812	Initial solution + KHR-R (2%) + Oil (1%) + CMC (0.4%) + NaCl (2) + Barite (10%)	1,80	61	7	9	0,7
5	8.03	2812-2864	Working solution + KHR-R (1%) + Oil (1%) + CMC (0.4%) + Barite (4%)	1,81	62	6	9	0,7
6	9.03	2864-2920	Working solution + KHR-R (1%) + Oil (1%) + CMC (0.4%) + Barite (4%)	1,82	63	6	9	0,6
7	10.03	2920-3092	Working solution + Na <sub>2</sub> CO <sub>3</sub> (0.5%) + CMC (0.4%) + CarboPac (0.1% kg) + NaOH (0.1%) + Barite(4%)	1,83	65	5	9	0,5
8	11.03	3092-3200	Working solution + Na <sub>2</sub> CO <sub>3</sub> (0.5%) + CarboPac (0.2%) + NaOH (0.1%) + Barite (4%)	1,84	68	5	9	0,5

After conducting a production test of the composite chemical reagent-rapaproyavlenie (KHR-R) at well No. 39 Chulkuvar to obtain weighted drilling mud, it can be seen that all the technological parameters of the drilling mud meet the standards specified in the GTN. With increasing concentration (KHR-R), the alkalinity of the solution increases, the filtration of the solution decreases, and the specific gravity steadily increases to the required value, since from 1.34 to 1.84 g/sm<sup>3</sup>.

## CONCLUSIONS

Thus, the KHR-R reagent developed by us allows us to comprehensively solve these problems and fully meets the requirements that are imposed on drilling fluids used in complicated geological conditions and in areas with highly mineralized reservoir waters and rapaproyav leniyami. The KHR-R reagent developed by us with the use of waste from various industries and local raw materials contributes to solving this problem and intensifying oil and gas production, hence increasing their production volume. Based on the conducted studies, a good compatibility of KHR-R with widely used chemical reagents (YSHR, K-4, CMC i gipan) in the composition of drilling fluids was revealed. Based on the conducted research, we propose to introduce 3-20% (depending on the amount) of the KHR-R reagent to the composition of the drilling mud as an acid-soluble additive when opening fractured oil and gas reservoirs. The addition of KHR-R to the drilling fluid composition will prevent irreversible blockage of cracks and pores of the productive formation with clay and the solid phase of the solution, will help preserve the natural permeability of oil and gas reservoirs, reduce the time of well development and lead to an increase in oil production. According to the positive technological parameters of the weighted drilling mud based on the composite chemical reagent-rapaproyavlenie (KHR-R) is recommended for drilling wells with salt-anhydrite deposits in the fields of JSC "Uzgeoburneftegaz".

## REFERENCES:

1. Basarygin Yu. M., Bulatov A. I., Proselkov Yu. M. Drilling of oil and gas wells. - M: Nedra-biznestsentr, 2002 -- 632 p.
2. Isakov A.M., Shaimuratov T. H., Ganiev Sh. M., Negmatov S. S., Mamadaliev R., Sharifov G. N., Salimsakov Yu. A., Rakhimov Kh. Yu. "Composite polymer material effective chemical agent for drilling fluids", // Composite materials, Tashkent, No. 1, 2009, - p. 74.
3. Sharifov G. N., Negmatova K. S., Kobelev N. S., Rakhimov Kh. Yu., Rapeseed development: composite chemical reagents based on organic and inorganic ingredients for drilling fluids used in drilling oil and gas wells. Composite materials No. 4/2015 p. 124-125.
4. Komila Negmatova, Soyibjon Negmatov, Akrom Rajabov, Gappor Rahmonberdiev, Jaxongir Negmatov, Gulom Sharipov, Shodil Isakov. Research And Development of Surface-Active Powder Composite Material Based on Viscous-Flow Waste of Oil and Fat Production // International Porous and Powder Materials Symposium and Exhibition, PPM-2013, Turkey, 2013. –pp. 475-480.
5. Negmatova K.S., Negmatov S.S., Salimsakov Yu.A., Rakhimov H.Y., Negmatov J.N., Isakov S.S., Kobilov N.S., Sharipov G.N., Negmatova M.I. Structure And Properties of Viscous Gossypol Resin Powder// AIP Advances. American Institute of Physics, USA, 2012. – pp. 300-302 (02.00.00; №1).

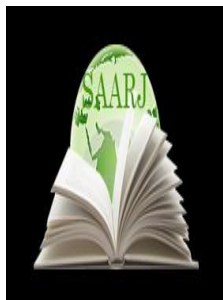

**ACADEMICIA**  
**An International  
Multidisciplinary  
Research Journal**  
(Double Blind Refereed & Peer Reviewed Journal)

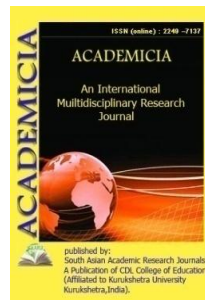

DOI: **10.5958/2249-7137.2021.01097.1**

**IMPROVING THE ORGANIZATION OF TEXTILE PRODUCTION  
BASED ON MARKETING RESEARCH**

**Fayoza Tuxtamurodovna Bazarova\***

\*Senior Lecturer,  
Tashkent Financial Institute,  
UZBEKISTAN

**ABSTRACT**

*The objective of the article is to examine the marketing strategies of textile companies and improving the organization of textile production based on marketing research. The issues of marketing research methodology, especially the problems of pricing, have received considerable attention in recent years in the domestic literature. However, some aspects of the issue under study have not yet received sufficient coverage. The practical significance of the work lies in the possibility of applying to the use of refined methods for calculating prices and volumes of demand and supply at enterprises engaged in the production of an assortment of fabrics for consumer use.*

**KEYWORDS:** *Marketing Strategies, Textile Industry, Production, Market Environment.*

**INTRODUCTION**

With the transition of the domestic economy to market relations, the textile industry faced many problems, the main of which are: insufficient development of their own raw material base, lack of necessary information about the population's demand for fabrics, rising prices for factors of production and, as a consequence of all of the above, difficulties in strategic planning of financial and economic activities. The activity of an enterprise in a market environment requires a revision of the very function and planning tasks. The issues of marketing research methodology, especially the problems of pricing, have received considerable attention in recent years in the domestic literature. However, some aspects of the issue under study have not yet received sufficient coverage. These are practical calculations of the equilibrium prices of fabrics for consumer use and raw material factors, assessing the influence of various factors on the equilibrium price, and forecasting consumer demand for fabrics.

### **The main results and findings**

Particular attention should be paid to the problem of production forecasting as an effective method of conducting marketing research. A feature of production forecasting is that it encourages enterprise managers to analyze future changes in the external environment and the consequences to which these changes may lead. It should be borne in mind that due to a number of circumstances, namely: fluctuations in the economic environment, the instability of the situation in the commodity and financial markets, changes in the economic conditions of activity, etc., forecasting has become especially difficult.

The above problems of the topic under study confirm its relevance, determine the need for deepening research. Purpose of the study: development of organizational and methodological support for the automated workplace of the textile marketer.

In accordance with the set goal, the following tasks are formulated in the work:

- Study of the theory and generalization of the practice of organizational and methodological support of the marketing services of textile enterprises;
- analysis of the state of the markets for raw materials and products of textile production, identifying general patterns and trends in the domestic market for consumer textiles, world and domestic raw materials bases;
- Analysis of the use of flax fiber in the production of blended fabrics in our country and abroad;
- Development of methodological support for the AWP of the marketer of textile production;
- Research of the theoretical and methodological foundations of the formation of demand and supply of fabrics from natural fibers, demand and supply of raw materials for these fabrics;
- Development of recommendations for improving the determination of the forecast of the equilibrium price for fabrics and the raw material factor; ...
- Formation of the structure of the databases necessary for the functioning of the regional marketing center;
- Development of methodological support for forecasting the effective demand of the population for fabrics;
- Development of principles for the classification of human behavior options when buying fabrics;
- Refinement of the algorithm for determining the supply of fabrics and the algorithm for determining trends in the equilibrium price for flax fiber;
- Development of software for the automated workplace of a marketer of textile production for forecasting the market situation for fabrics and raw materials.
- Verification of the developed methodological support of the automated workplace of the marketer of textile production;

The subject of the research is the organizational and methodological support of the automated workplace of the textile marketer.

The object of research in the dissertation is the consumer fabrics market and the factors of production market (raw materials market). In the dissertation work, industry-specific methodological and regulatory materials on this issue were used, as well as materials from state statistics and statistics of enterprises in the textile and processing industries. The research was carried out using economic and statistical methods, a software package in the Pascal language was developed for processing initial data on personal computers.

The practical significance of the work lies in the possibility of applying to the use of refined methods for calculating prices and volumes of demand and supply at enterprises engaged in the production of an assortment of fabrics for consumer use. The workstation of a marketer of textile production will allow textile enterprises to respond more quickly to changes occurring in the domestic and world markets, and will increase the quality and efficiency of their work.

*Scientific novelty of the research.* In the process of performing the work, the following results were obtained with scientific novelty:

- 1) The tendencies in the change in the structure of the raw material base of the textile industry were revealed, which made it possible to determine the sequence of calculations to determine the equilibrium price for raw materials and finished products of the textile industry.
- 2) The composition and structure of the databank for the automated workplace of the textile marketer have been determined, including the architectonics of the databank, the source of statistical data, the determination of the time period for research and forecast.
- 3) When forecasting the price of flax fiber, the need to take into account such factors as the demand for flax in the cotton and woolen sectors of the textile industry is substantiated.
- 4) The methodological support of the AWP of the marketer of textile production has been developed, which includes:
  - A methodology for forecasting the demand for fabrics for consumer use;
  - An algorithm for determining the supply of tissues;
  - An algorithm for determining the generated demand for flax fiber in the textile industry;
  - An algorithm for determining the equilibrium price for flaxseed raw materials.

A distinctive feature of this technique is the ability to differentiate the effective demand of the population by income groups. The developed methodology provides the following methodological principles:

- The use of flax fiber in various branches of the textile industry;
- Real technological capabilities in various industries;
- The unity of the functional purpose of the products;
- Dependence of consumer behavior options on the size of the consumer budget.

- 5) The proposed method for forecasting demand uses a graphical-analytical approach to calculating the forecast of demand for fabrics, it includes three stages:



- Determination of the volume and price of consumption. The calculation is carried out according to the proposed dynamic parametric model, which takes into account the ratio of income and expenses growth. Depending on this ratio, a consumer behavior option is selected;
  - Construction of a demand curve based on the data obtained on the ratio of income levels of the population, prices and consumption of fabrics;
  - Determination of the forecast of demand for fabrics by the graphic-analytical method.
- 6) The equilibrium price for flax fiber has been determined, taking into account its use in the cotton and woolen industries.

The first chapter examines the theoretical and methodological aspects of the organizational and methodological support of the marketing services of textile enterprises, described in domestic and foreign literature, an analysis of the state of textile production at all stages of the process from processing of raw materials to the production of finished products is given, methodological foundations of forecasting prices for raw materials are developed, which made it possible to resolve the issues discussed in the subsequent chapters of the work.

The second chapter provides a methodological rationale for calculating the effective demand of the population for consumer fabrics, taking into account income differentiation, clarifies the methodological approach to developing the supply of fabric by textile factories in conditions of inflation, analyzes the specifics of determining the equilibrium price for finished products and for raw materials, taking into account the peculiarities of textile production.

The problems of the theory and practice of forecasting the demand for fabrics for consumer use, prices for fabrics made of natural fibers, prices for raw materials considered in the work allow us to draw some conclusions and make proposals for determining the price of flax fiber, provided it is used in various sectors of the textile industry.

The problems of improving the organization of textile production on the basis of a marketing approach using the forecasting method considered in the dissertation work allow us to draw appropriate conclusions and make proposals for the organization of marketing services on the basis of textile enterprises.

## CONCLUSION

1. The importance of the marketing approach to the process of improving the organization of textile production has been substantiated.
2. Analyzed the problems of theory and practice of organizing the activities of industrial enterprises on the principles of marketing, which made it possible to substantiate the need to use forecasting methods in marketing research.
3. The market for the sale of textile products has been analyzed, which has shown the need for close cooperation between the marketing services of manufacturing enterprises and consumers of their products in order to obtain objective information about consumer demand for textile products.
4. The necessity of studying the elasticity of demand for fabrics in view of the variability of the income level of their consumers has been substantiated.

5. Applied the method of forecasting demand based on the study of its elasticity in the implementation of marketing research.
6. Questionnaires have been developed for conducting sociological research among consumers of consumer goods, as well as among employees of organizations selling textile products.
7. The algorithm of the activity of a marketer of a textile enterprise is presented, which is based on the method of studying the elasticity of demand for fabrics.
8. A method for studying the elasticity of demand has been developed, which makes it possible to predict the demand for fabrics for consumer use using the graphic-analytical method. This technique allows:
  - to determine the existing demand for fabrics of consumers with different income levels and a certain type of behavior;
  - to determine the degree of influence of various factors on the behavior of the elasticity function of demand for tissue;
  - to determine the projected demand for fabrics in accordance with the needs of consumers and the capabilities of the enterprise.
9. A classification of factors influencing the elasticity of demand is proposed, which can be used in the organization of production in the implementation of forecasting in any industries producing consumer goods.
10. The algorithm for assessing the risk of the marketing activities of a textile enterprise has been refined.
11. Revealed the reasons that hinder the introduction of marketing services at textile enterprises.
12. The structural diagram of the organization of the marketing service at a textile enterprise is proposed, which is based on a functional segment orientation, with the designation of the directions of the main information flows.

**REFERENCES:**

1. Ansoff I. Strategic management: Abbr. per. from English / Scientific. ed. and ed. submitted L.I. Evenko. M.: Economics, 1989. - 519 p.
2. Appak M.A. An automated workstation based on the Iskra 226 microcomputer. - M.: Finance and statistics, 1987.-110 p.
3. Arshinova V.I. Calculations of the effectiveness of options for the future development and placement of the industry (sub-industry). Methodical development. M.: ANKh USSR, 1989.-64 p.
4. Business and manager. // Comp. Chernoiivanov I.P., Dorokhovskiy Ch.S., Prekhul G.V. Moscow: Azimutttsentr, 192 .-- 448 p.
5. Berezin V.A., Mazokhin S.I. Consumer Goods Market: Needs and Opportunities. M.: Knowledge, 1990.- 62 p.
6. Bolt G.J. A practical guide to management. sales. Translated from English, - M.: EconomicsD990.-270 p.

7. Bragina ZV, Volkova T.I., Suslova N.N. Scientific and technical forecasting in the textile industry: Text of lectures / Fire. technol. in-t. Yaroslavl, 1988 .-- 51 p.
8. Vasilyeva N.E., Kozlova L.I. Price formation in market conditions. M .: JSC "Business School" Intel-Sintez ", 1995. - 64 p.
9. Vasiliev Yu.N., Forecasting and long-term planning in industry. St. Petersburg: Lenizdat, 1973 .-- 196 p.
10. Mescon M., Albert M., Hedouri F. Fundamentals of Management: Textbook.- M .: Delo, 1998.- 800 p.



# ACADEMICIA

## An International Multidisciplinary Research Journal

(Double Blind Refereed & Peer Reviewed Journal)

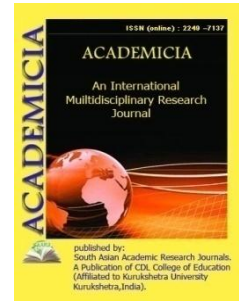

DOI: [10.5958/2249-7137.2021.01053.3](https://doi.org/10.5958/2249-7137.2021.01053.3)

### EFFICIENCY AND FINANCIAL SUSTAINABILITY OF MICROFINANCE INSTITUTIONS: A STUDY OF JAFFNA DISTRICT

Velnamby, T\*; Ajanthan, A\*\*

\*University of Jaffna, SRI LANKA  
Email if: tvnamby@yahoo.co.in

\*\*University of Jaffna, SRI LANKA  
Email id: ajanthan198703@gmail.com

#### ABSTRACT

*Microfinance is the provision of thrift, saving, credit and financial services and products of very small amount to the poor in rural, semi-urban and urban areas for enabling them to raise their income levels and improve their standard of living. (Sen., 2008). In numerous studies done across the world, it is generally believed that various microfinance initiatives have been able to make a difference in the target populations lives. However, increasing doubts have been raised over the financial sustainability of microfinance institutions. MFIs need to be economically viable and sustainable in the long run but economic implications of long term sustainability are not being considered (Srinivasan et al., 2006). Microfinance collectively refers to the supply of loans, savings accounts, and other basic financial services like insurance, to the poor. About one billion people globally live in households with per capita incomes of one dollar per day (Morduch J. 1999). Microfinance Institutions (MFIs) are special financial institutions. They have both a social nature and a for-profit nature. Their performance has been traditionally measured by means of financial ratios. The context of the study is to analyze the prospects of micro finance industry in Jaffna District special reference to MPCSC Co-operative Rural Bank. This study examines the relationship between efficiency of co-operative rural banks with its financial sustainability. The objective of the study is to evaluate efficiency and financial sustainability of microfinance institution in relates with its rate of interest, operating revenue, administration & operating expenditure, administrative, operating, and financial and staff efficiency. 10 rural banks were selected in Jaffna district using stratified random sampling method. Research hypothesis were formulated that there is an impact of efficiencies on financial sustainability and operational and financial efficiencies are significant impact in determining the financial*

---

*sustainability. Ratio analysis was used to evaluate the efficiencies of the rural banks. Findings say that there is a relationship exists between efficiency and financial sustainability.*

**KEYWORDS:** *Micro finance Institutions, Efficiency, and Financial Sustainability.*

---

## **INTRODUCTION**

Microfinance collectively refers to the supply of loans, savings, and other basic financial services like insurance, to the poor. As the poor people cannot avail these financial services from the formal commercial banks (because of the collateral requirements), microfinance tends to provide to them exclusive of these conditions. For these financial services, the poor people are willing to pay for because of the added advantage they receive for not collateralizing anything. The term also refers to the practice of sustainably delivering such services. More broadly, it is a movement that envisions a world in which as many poor and near poor households as possible have permanent access to an appropriate range of high quality financial services, including not just credit but also savings, insurance, and fund transfers (Christen, R. P., Rosenberg, R., and Jayadeva, V., 2004).

Microfinance institutions focus on providing credit to the poor who have no access to commercial banks. While microfinance institutions try to be financially sustainable, they appear to be often loss making. Nevertheless, they succeed in lending to domestic small companies and poor agents since Western donors and NGOs are still willing to provide financial support against below market interest rates. Recently, however, there seems to be a shift from microfinance institutions to a further focus on financial sustainability and efficiency. Financial sustainability and efficiency of microfinance institutions is obviously very important for a well-functioning financial system in developing countries.

### **Background and Significance of the study**

Microfinance began as a financial system to provide assistance to poor families in order to help them to begin and sustain income-generating activities. Micro credit arose in the 1970s, through the efforts of Mohammed Yunus, a microfinance pioneer and founder of the Grameen bank of Bangladesh.

Microfinance has evolved as an economic development approach intended to benefit low income groups. Asian Development Bank (ADB) has defined Microfinance as “the provision of a broad range of financial service such as deposits, loans, payment services and insurances to the poor and low income households and their Micro enterprises”. In this regard, Microfinance activities usually involve small loans, typically for working capital, informal appraisal of brewers and investments to repeats and larger loans based on debt capacity and repayment performance steam lined-loan disbursement and monitoring secure serving products.

The typically microfinance clients are low income persons that do not have access to formal financial institutions. Microfinance clients are typically self employed often house hold based entrepreneurs. In rural areas they are usually small farmers and others who are engaged in small income generating activities such as food processing and petty trade. In urban areas Microfinance activities are mire device and include shop keepers, service providers, artisans, street vendors etc.

The earlier paradigm was that Microfinance was an act of charity as lending for micro enterprises and the poor were not profitable. There were many deficiencies in such lending. That is repayments rates were low, unintended beneficiaries were large, inefficient operations and funds were often not used for the purpose for which they were given and the total outreach was not significant. Due to these reasons MFIs became unable to sustain in their operations. If MFIs should be sustainable it must be financially self-sufficient.

Even though microfinance institutions try to be financially sustainable, they appear to be often loss-making. Nevertheless, they succeed in lending to domestic small companies and poor agents since western donors and (Non Government Organizations) NGOs are still willing to provide financial support against below market interest rate. Recently, however, there seems to be a shift from microfinance institutions to a further focus on financial efficiency and sustainability. Financial efficiency and sustainability of microfinance institutions is obviously very important for well-functioning financial systems in developing countries.

### **Significance of the Study**

Microfinance is a well-integrated broad range of financial services provided to the poor and low income persons who are excluded from availing themselves of similar services from formal financial institutions. Thus policy makers have paid increasing attention to rural development as an important element of the national development strategy. They have recognized the need for providing financial services at micro level for achieving sustainable rural development and economic empowerment of the poor, which account for a very high proportion of the rural population.

Since, Microfinance can increase the availability of capital for developing income-generating micro enterprises and rural agriculture while providing savings and other financial products at village level for increasing the financial security of the poor and low income persons (A.S.Jeyawardene-2003). Due to this microfinance has emerged as a major instrument to provide financial facilities to low income group clients including the small entrepreneurs. Because of this, in recent times there is a huge demand for microfinance activities all over the world especially in developing countries like Sri Lanka. This reflected in rapid growth of the number of institutions engaged in microfinance activities.

If the microfinance institutions are financially sufficient, they will increase their capital base. This would in turn increase their capacity to expand the scale of their operation. Therefore,

- Finding of this research will help the institutions to find out the relationship between the efficiency of the operation and achievement of financial sustainability.
- Finding of this research will highlight the present situation of the co-operative rural banks in Jaffna district.
- Findings of this research will help the institutions to identify the factors which determine the efficiency of their operation and could help the institution to carry out their operation efficiently as well.
- Findings of this research will also help further research questions for further investigation in the future on financial sustainability of any MFIs in Jaffna and Sri Lanka.

### **Objectives of the Study**

The researcher has planned to carry out this study on the efficiency and financial sustainability of the microfinance. The objectives of the research are;

- To identify the relationship between efficiency and financial sustainability of co-operative rural banks.
- To find out the impact of efficiency on financial sustainability of selected cooperative rural banks.
- To find out the factors which determine the efficiency and financial sustainability.
- To evaluate the trend on efficiency and financial sustainability during the years of 2007, 2008, 2009, 2010 & 2011.
- To suggest the co-operative rural banks to improve or develop the operation in efficient manner in order to uplift the financial sustainability in its operation.

### **Research Problem**

The research aims to study the relationship between efficiency of co-operative rural banks and its financial sustainability. ‘ A financially self - sufficient credit institution must cover its operating expenses, loan losses and the cost of funds with the income earned from charging fees and interest (Jan Evers, Stefanie Jack, Adriaan Loef & Hedwing Siewertsen ,2000). Therefore the research problems are as follows;

1. Why efficiency of cooperative rural banks is low?
2. Do the rural banks perform their activities towards financial sustainability?

### **Literature and Hypothesis development**

The term “ Microfinance” pertains to the lending of extremely small amounts of capital to poor entrepreneurs in order to create a mechanism to alleviate poverty by providing the poor and destitute with resources that are available to the wealthy, albeit at a smaller scale. This particular form of lending has existed in the world for quite some time, though formalized by Mohammed Yunus in Bangladesh during the 1970’s. Yunus won the Nobel Peace Prize in 2006 for his efforts in combating poverty and resources to the poor via the Grameen bank and the microfinance model.

According to Otero (1999) Microfinance is “the provision of financial services to low income poor and very poor self-employed people”. These financial services according to Joanna Ledgerwood (2000) generally include savings and credit but can also include other financial services such as insurance and payment services.

Schreiner and Colombet (2001) define microfinance as “the attempt to improve access to small deposits and small loans for poor households neglected by banks.” Therefore, microfinance involves the provision of financial services such as savings, loans and insurance to poor People living in both urban and rural settings who are unable to obtain such services from the formal financial sector.

According to common definition of Asian Development Bank (ADB, 2000) “microfinance is the provision of a broad range of financial services such as credit, saving, insurance and money transfer for low income individuals or households”. The term low income used in the definition of microfinance is a relative concept; it varies from countries to countries or even among different areas within a country.

Microfinance is the provision of financial services to the poor who do not have access to capital and financial services (Kosiura, 2001). Financial services can include one or any combination of the following: lending, savings, insurance, pension/retirement and payment services. Increasingly mature MFIs also provide diverse products-housing loans (primarily improvements, repair and maintenance), insurance (both health and life insurance), and private pensions. Microfinance is also frequently combined with the provision of social and business development services, such as literacy training, education on health issues, management or accounting training.

The role of microfinance for development efforts around the world, particularly for poverty alleviation has been significant. Providing poor people with access to financial services are seen to reduce capital market distortions to exclude the poor, reduce vulnerability by providing the poor with financial resources when needed, and opportunities for income-generating activities. Microfinance enables clients to protect, diversify and increase their income, as well as to accumulate assets, reducing their vulnerability to income and consumption shocks (Robinson, 2002).

Similarly, microfinance refers to as “the provision of loans, savings, payments and other basic financial services to low income populations. Microfinance activities involve small loans, employ collateral substitutes, streamline procedures and offer swift and frequent access. Their clients cover typically self-employed, low income entrepreneur and households in both rural and urban areas” (Imboden, 2005).

### **Efficiency**

Efficiency ratio provides information about the rate at which microfinance institutions generate revenue to cover their expenses. Efficiency refers to the cost per unit (Joanna Ledger wood, 2000). Efficiency measures how well the available resources are utilized to maximized output (Monica brand, 2000).

Efficiency is defined here as the amount of outputs per unit of cost. Costs are defined as expenses recorded in the organizations accounts a long with any unrecorded expenses or implicit Subsidies. Outputs of a microfinance organization may be the amount of the loan portfolio or the number of loans outstanding or the number and amount of loan disbursed. (Claudio Gonzalex - Vega, Mark Schreiner, Richard L. Mayer, Jorge Rodriguez & Serigo Navajas, 1996).

A number of accounting variables reflect the efficiency of the microfinance institutions. These accounting variables are administrative expense ratio, number of loans per loan officer and loan officers to total staff, portfolio size, loan size, lending methodology, source of funds and salary structure as the efficiency drivers and hence as the measurements for MFI efficiency.(Todd Forrington, 2000)

### **Studies Related to Efficiency**



Avishay braver and Monica brand (1991) argues that purely supply driven credit schemes must be transformed into self sustainable systems and rural financial intermediaries must become viable and self carrying agents. Intervention in rural financial markets of developing countries should focus on re-structuring and strengthening rural financial institutions and remove obstacles to the efficient functioning of rural credit markets.

Reinhard schmid (1994) found that credit technology also one of the determinants of cost minimization process or institution's sustainability. The study discloses individual based credit technology giving benefits to the borrower in the form of reduced transaction costs.

USAID (1995) in this study they argue the prerequisites to operational efficiency appear to include the adaptation of an effective service delivery methodology and significant institutional competence in such areas as delinquency control information management and staff development.

Hume David and Paul Mosley (1996) pointed out that operational efficiency is of paramount significance as it has a direct bearing on the quality of lending and the rate of defaults. The rate of defaults is the single most important factor in cost as the interest rate has to be enhanced considerably to off-set the amount of defaults, other cost, remaining the same.

Cecile Lapenu [1999] conducted a study which relates to efficiency of the MFIs, as Distribution, Growth, and performance of MFIs in Africa, Asia and Latin America. The study reveals that by continent Asia accounts for the largest volume of savings and loans. It employs the largest number of MFI staff, but has lower personnel costs than Africa and Latin America. At the same time staff productivity in Africa is low as the continent still faces the constraints of poor infrastructure, undiversified economies and high transaction costs as well as poverty and illiteracy among potential Clients. All of this limits transaction volume per staff member.

David Richardson (2000) describes that the achievement of the efficiency in the operation is the vital condition. He prescribed the seven doctrines of success for micro lenders or micro lending institutions. One of his doctrines emphasizes that "by broadening base, increase loan size, and revaluating salary and incentive structures on micro lending institutions can continue to provide high quality services to their clients while lowering its operating expenses".

The study of USAID (2001) based on operation efficiency of the MFIs. According to the study, its success in holding down administrative cost plus loses from bad loans strongly affects its overall financial suitability. Further the study argues that attainable level of operational efficiency differ according to local performances, the methodology pursued by the MFIs and the target group that rural financial intermediation is very expensive less attention has been directed towards microfinance programs operate efficiently.

Todd Forrington (2000) in his study rightly pointed out that improving efficiency is an effective way of reducing the interest rate charged to borrowers. Based on his Latin American MFIs study, MFIs can wring significant efficiencies from operating process and systems. The study highlights some efficiency innovations employed by leading Latin American MFIs. They are easy access to information is must essential client information also enhances efficiency, specialized products for low risk borrowers can reward repayment performance and simultaneously lower administrative expenses specialized loan officers also can improve

efficiency, borrow per screening and geographic concentration of loan officers in specific zones is efficient and it reduces credit risk.

Craig Churchill and Dan Coaster (2001) argue that efficiency remains one of the greatest challenges for MFIs. It reflects an organization ability to manage costs per unit of output and thus is directly affected by both cost control and level of outreach. Inefficient MFIs waste resources and ultimately provide clients with poor services and products as the cost of these inefficiencies are ultimately passed on to clients through higher interest rates and higher client transaction costs.

Monica brand and Julie Gerschick (2001) argue that high level of operating efficiencies in microfinance is unfortunately the exception rather than the rule. The reason is twofold. First many MFIs have not fully exploited the minimum economies of scales required to improve efficiencies. There are many small MFIs serving to few clients to operate efficiently. Second many MFIs still operate in non competitive environment where there is little pressure to improve efficiency given that high operating costs often can be covered by charging higher interest rates. Further they argue that MFIs can improve efficiency in three ways;

1. Increase the number of clients to achieve greater economies of scale.
2. Stream line system to improve productivity and
3. Cut costs, the first two goals are closely related both seek to increase the no of clients, or units of output.

The MFIs serves by having staff work harder or preferably smarter. In MFI that are not managed in a businesslike manner, employees often have excess capacity. Third goal addresses cost side of the equation. Administrative cost including salaries and other operating expenses, represent the greatest component of the cost structure of an MFI. Reducing the delivery costs associated with providing financial services improves operating efficiency. If these costs can be reduced the savings can be passed on to clients through more competitively priced products, ultimately improving customer satisfaction. Improving efficiency should however be of paramount importance to MFIs from a social as well as a financial perspective. Competition market saturation will prevent many MFIs from charging undifferentiated high interest rates in perpetuity for inefficient MFIs facing these conditions that only way to maintain self-sufficiency is via larger loan which are typically not well suited to lower market segments and thus may conflict with the designed social mission. Thus efficiency is critical for a MFI to remain agile competitive and responsive to client needs.

Indrani Hettiarachchi (2003) argues that sustainability of MFI in any country depends on their ability to operate efficiency and gain the confidence of the community as reliable institution capable of providing the required services. This depends on the acceptability of MFIs by the clients, funding organizations, and the regulatory mechanism of the country.

### **Financial Sustainability**

Financial sustainability is defined as the ability of microfinance institutions to cover actual operating expenses as well as adjustments for inflation and subsidies with adjusted income generated through its financial services operations. Financial sustainability implies commercial leverage for donors and repeat use for customers (Mark Schreiner, 1996).

Financial sustainability refers to the ability of an MFI to develop a diverse resources based on that it could continue its institutional structure and production of benefits for intended clients' population after support cessation of donor financial support (Naser Abdelkarim, 2002). The concept of financial sustainability means that a program must meet its operational expenses entirely of out of the income generated by the services it offers to its clients. That is an institution should be maintained by its clients not by donors (Robert Peck Christen, 1997).

Full financial sustainability measures how well a MFI can cover its costs taking into account a number of adjustments to operating revenues and expenses. The purpose of most these adjustments is to model how well the MFI could cover its costs if its operation were unsubsidized and it was funding its expansion with commercial cost liabilities. Financial sustainability can be gauged by an organization's net income (the surplus of revenues over expenses); liquidity (the cash available to pay bills); and solvency (the relationship of assets and debt or liabilities). Again, this manual promotes a broad, interdisciplinary role for financial management, as one component of overall sustainability.

Many factors influence the financial sustainability of an organization, including the operating environment, national and local politics and policy, the activities of other organizations, the availability of skilled personnel, Institutional innovations, Strong commitment and political support for change, Learning and experimentation, New products appropriate for the poor, Long term banking relationship, Procedural simplification, Enabling macroeconomic environment and Reforming a government bank to reach the poor. Understanding the nature and impact of these influences on the organization and programs is critical because it better prepares to anticipate and respond to changes in the external environment in order to generate sufficient resources to consistently meet the clients' needs.

There are varying degrees of sustainability, and therefore some organizations are more sustainable than others. The "starting point" is different for each organization: each has strengths that can be enhanced and weaknesses that can be improved upon. For example, some organizations always require international donor funding, while others may be able to generate sufficient funds through cost recovery and local donations.

### **Studies Related to Financial Sustainability**

Berenbach and Guzman (1992) in their study revealed that lending methodology also one of the Determinants factors for the sustainability of the MFI since a dysfunctional methodology may produce various manifestation of weakness, such as poor quality portfolio, high clients' desertion, and difficulty enforcing contracts, the inability to reduce cost sufficiently or to achieve sustainability. Further he pointed out that to become sustainable MFI may change their methodology to increase scale and improve efficiency since decision to modify product pricing costs and increase staff productivity have significant ramifications on the lending methodology.

Claudio Gonzalez- Vega (1994) explains that the sustainability generates compatible incentives for all those with an interest in its survival, such as clients, managers, and the staff because it underpins of the microfinance organization's permanency.

Claudio Gonzalez – Vega, Mark Schreiner, Richard L. Mayer, Jorge Rodriguez & Serigio Navajas(1996) conducted a case study about a microfinance institution in Bolivia, in their study they reveal that organizational design and technological development also contribute financial

sustainability of an institution. Leaders' attitudes about sustainability gradually lead through a process of search for formalization to self sustainability. According to them, this concern will also reflect among other things. Such as adoption of interest rate policies those seek to cover the costs of lending and in a resolute attitude toward loan collection. Further their lending technologies always appropriate its market niche. The study pointed out that success of on the development of a microfinance program rests on the accumulation of knowledge and experience about the environment in which it operates relevant features of the clientele it series, the individual credit worthiness of heterogeneous clients, this success requires constant time- turning and adjustment of the technology to varied local circumstances. In this way, the particular institution always in line with these concepts. Payton (1997) conducted a study as outreach and sustainability, comparative analysis of savings first vs. credit – a comparative analysis of eight MFI in Africa. In his study he argues “ability to reach large number of clients with financial services in the long run is a function of their financial viability is necessary to reach the poor”. However, he pointed out that “a program that reaches the very poor”. But relies on donor fund is wasteful in several ways.

Mark Schrenier (1997) revealed sustainable MFI helps a lot of poor people through a time frame. At the same time understandable MFI helps just a few people through a short time frame. He argues that this sustainability requires profit since profit perfect the permanency. That is when the donors leave this will protect the institution. But, sustainability requires more than just financial sustainability from profit. According to his argument, are you of high profit and strong performance do not mean a MFI is sustainable. Therefore he places several conditions. If financial sustainability last in the long run. Such as structure of the rules and incentives and the system of organization prompt. He emphasizes that sustainability is meeting goals now and in the long term with subsidized funds replaced with market funds.

Jan Evers, Stefanie Jack, Adriaan Loef, Hedwing Siewertsen (2000) according their book the sustainability is divided into four different levels;

1. High subsidized programs grants and soft loans cover operating expenses and establish the revolving loan fund. The fund erodes due to loan losses and inflation. There is a permanent need for subsidies and grants.
2. Fully revolving fund interest earned covers the cost of funds and some operating expenses. Grants are required to finance some operational expenses.
3. Operational sustainability income covers cost of funds and operational expenses. However, some element of subsidy remains due to the financial cost of maintaining the value of a revolving loan fund in a high inflationary environment or of paying commercial rates of refinancing cost.
4. Financial sustainability or FSS: all costs are covered with interest and fees charge by the organizations and funds are raised at commercial rates from formal financial institutions.

Moreover, institutions that do not cover 100 percent of their operational costs will remain dependent on donations or government subsidies to maintain their current activity level. A drop in subsidies would automatically deplete loan capital and result in a reduction in the number of borrowers using the institution. Institutions that cover more than 100% of their operational costs

but do require funds for lending. Institutions that cover operational & financial costs are fully sustainable.

Paul (1997) in his study point out transaction costs of lending and borrowing are major barrier to providing access to micro credit services for the poor on a sustainable basis.

Mohsmmst Mazirwam (2003) argues that strengthening institutional capacity is one of the key issues for the sustainability of the microfinance sector. String institutions together with good governance will be able to provide good quality financial services to the poor increase their outreach significantly and achieve financial sustainability.

Otero (1999) argues to be successful financial intermediaries that provide services and generate domestic resources must have the capacity to meet high performance standards. They must achieve excellent repayments and provide access to clients and they must build forward operating and financial sustainability. According to the study, in order to do so MFIs need to find ways also to broader their resources base.

Canadian International Development Agency (1999) in their reference guide clearly pointed out that gradually changing has as more MFIs decrease their donor dependence. Some became totally non-dependent to maintain their non-operations. They further revealed that this being done by contribution of changes including;

- Increasing scale of operations.
- Improving the efficiency of delivery of the financial service.
- Setting appropriate interest rate policy.

All these build up the institution to become sustainable.

David Richardson (2000) states that to achievement of the efficiency in the operations is the vital condition. He prescribed seven doctrines of success for micro lenders or micro lending institutions. One of his doctrines emphasized that by broadening base increase loan size and re-evaluating salary and incentive structures on micro lending institution can continue to provide high quality services to their clients while lowering its operating expenses.

### **Methodology**

When the research population is seen large or in extreme, the researchers mostly use samples of research because it is difficult to take as a whole for the research. Jaffna's microfinance sector is served by a diverse range of institutions. These can be segregated into the following broad categories,

- ✓ Co-operative rural banks and other co-operatives
- ✓ Thrift and credit co-operative societies (TCCSs/ sanasa societies)
- ✓ Samurdhi bank societies (SBSs)
- ✓ Non government organizations (TRRO, etc)
- ✓ Licensed specialized banks
- ✓ Other financial institutions (commercial banks, registered finance companies,etc)

Regarding the research, there are several microfinance institutions in Jaffna district. But all MFIs have not properly provided or maintain the data in microfinance activities. So, co-operative rural banks were selected for this research. In the case of co-operative rural banks, there are 31 rural banks which are functioning under 23 MPCs in Jaffna district. For the purpose of this research 10 rural banks were selected under 10 AGA's division or DS's division by using stratified random sampling method.

### Hypotheses

Based on the conceptual model and the research question the following hypotheses are taken in this research;

H<sub>1</sub>: There is a relationship between efficiency and financial sustainability of co-operative rural banks.

H<sub>2</sub>: There is an impact of efficiencies on financial sustainability of co-operative rural banks.

H<sub>3</sub>: Operating and Financial efficiencies have significant impact on financial sustainability of co-operative rural banks.

### Data Analysis

The efficiency and financial sustainability which is based on the calculated ratios are presented in the form of statistical output.

**TABLE 1: CORRELATIONS MATRIX FOR RURAL BANKS**

	Administrative efficiency	Operating efficiency	Financial efficiency	Staff efficiency	Financial sustainability
Administrative efficiency	1				
Operating efficiency	.084	1			
Financial efficiency	-.228	-.497	1		
Staff efficiency	-.281	.261	.220	1	
Financial sustainability	-.200	-.691*	.651*	.256	1

\*. Correlation is significant at the 0.05 level (2-tailed).

Table 1 describes the correlation between efficiencies and financial sustainability for cooperative rural banks. The value of correlation between administrative efficiency and financial sustainability of rural banks is -.200 which is not significant at 0.05 levels, represent weak negative relationship between administrative efficiency and financial sustainability of rural banks.

The value of correlation between operating efficiency and financial sustainability of rural banks is -.691\* which is significant at 0.05 levels; represent strong negative relationship between operating efficiency and financial sustainability of rural banks. Therefore, when operating expenses reduces financial sustainability of cooperative rural banks in Jaffna district increases.

The value of correlation between financial efficiency and financial sustainability of rural banks is .651\* which is significant at 0.05 levels; represent strong positive relationship between financial efficiency and financial sustainability of rural banks. Therefore, when financial revenue from loan portfolio increases financial sustainability of cooperative rural banks in Jaffna district increases.

The value of correlation between staff efficiency and financial sustainability of rural banks is .256 which is not significant at 0.05 levels; represent weak positive relationship between staff efficiency and financial sustainability of rural banks.

### The Impact of Efficiency on Financial Sustainability

Efficiency and financial sustainability of microfinance institutions is very important for a well functioning financial system in developing countries, financial sustainability is equally important for any microfinance institutions as is wide outreach. Here multiple regressions are used to identify the relationship between efficiency and financial sustainability.

**TABLE 2 REGRESSION ANALYSIS FOR RURAL BANKS**

Dependent variable	Independent variable	Beta	Standard error	R <sup>2</sup>	t	Sig
Financial sustainability	Administrative efficiency	.064	4.589	.852	.348	.742
	Operating efficiency	-.772	3.525		-3.492	.017
	Financial efficiency	.583	.054		2.876	.035
	Staff efficiency	.154	8.923		.703	.513

Table 2 reveals the multiple regression summaries. In this model the specification of four variables (administrative efficiency, operating efficiency, financial efficiency and staff efficiency) revealed the ability to predict financial sustainability ( $R^2=.852$ ). Respective  $R^2$  value of 0.852 denotes that 85.2 percent of the observed variability in financial sustainability can be explained by the differences in four independent variables namely administrative efficiency, operating efficiency, financial efficiency and staff efficiency. The remaining 14.8 percent is not explained which means that the remaining 14.8 percent of the variance in financial sustainability is related to other variables not depicted in this model (such as environmental factors, competitors etc). In the above table 4.16, t values are significant for independent variables namely financial efficiency and operating efficiency. (p value < 0.05).operating efficiency has negative correlation as well as financial efficiency has positive correlation which means financial sustainability increases with increasing level of financial efficiency and decreasing level of operating expenses.

### Hypotheses Testing

**H1: There is a relationship between efficiency and financial sustainability of co-operative rural banks.**

This hypothesis is subdivided into three because; efficiency includes Administrative efficiency, operating efficiency, financial efficiency and Staff efficiency.

**H1<sub>a</sub>: There is a negative relationship between Administrative efficiency and financial sustainability of co-operative rural banks.**

When considering the above table 4.15, correlation value between administrative efficiency and financial sustainability is -.200. so there is a weak negative correlation between them. This implies that when administrative expenses decreases financial sustainability can increase in a small level. Because it is not significant at 0.05 levels. So H1<sub>a</sub> is accepted.

**H1<sub>b</sub>: There is a negative relationship between operating efficiency and financial sustainability of co-operative rural banks.**

When considering the above table 4.15, correlation value between operating efficiency and financial sustainability is -0.691\*. so there is a strong negative correlation between them. This implies that when operating expenses decreases financial sustainability can increase in a larger level. Because it is significant at 0.05 levels. So H1<sub>b</sub> is accepted.

**H1<sub>c</sub>: There is a positive relationship between financial efficiency and financial sustainability of co-operative rural banks.**

When considering the above table 4.15, correlation value between financial efficiency and financial sustainability is +0.651\*. So there is a strong positive correlation between them. This implies that when financial revenue increases financial sustainability can increase in a larger level. Because it is significant at 0.05 levels. So H1<sub>c</sub> is accepted.

**H1<sub>d</sub>: There is a positive relationship between staff efficiency and financial sustainability of co-operative rural banks.**

When considering the above table 4.15, correlation value between staff efficiency and financial sustainability is +0.256. So there is a weak positive correlation between them. This implies that when staff efficiency increases financial sustainability can increase in a small level. Because it is not significant at 0.05 levels. So H1<sub>d</sub> is accepted.

**H2: There is an impact of efficiencies on financial sustainability of co-operative rural banks.**

According to the table 4.16 administrative, operating, financial and staff efficiencies have greater impact ( $R^2 = 0.852$  OR 85.2%) on Financial sustainability of co-operative rural banks. so H<sub>2</sub> is accepted.

**H3: Operating and Financial efficiencies have significant impact on financial sustainability of co-operative rural banks.**

According to the table 4.16, both operating efficiency and financial efficiency have high beta value of 0.772 & 0.583 are respectively. At the same time both are significant at 0.05 levels. Because P value of operating efficiency is .017 ( $p < 0.05$ ) and financial efficiency is 0.035 ( $p < 0.05$ ). so H3 is accepted.

**Findings of the Study**

Any research is carried out to find out truth. Based on the presented data and data analysis, findings are identified. To conducting this research four different types of efficiencies were considered. Then how these efficiencies impact on financial sustainability was analyzed by using



statistical tools. Based on the correlation and regression analysis many findings related to the relationship between efficiency and financial sustainability is identified.

The value of correlation between administrative efficiency and financial sustainability of rural banks is -0.200 which is not significant at 0.05 levels, representing a weak negative correlation between the administrative efficiency and financial sustainability of rural banks. The value of correlation between operating efficiency and financial sustainability I of rural bank is -0.691\* which is significant at 0.05 levels, represents a strong negative relationship between the operating efficiency and financial sustainability of rural banks.

The value of correlation between financial efficiency and financial sustainability of rural banks is +0.651\* which is significant at 0.05 levels, representing a strong positive correlation between the financial efficiency and financial sustainability of rural banks. The value of correlation between staff efficiency and financial sustainability of rural banks is +0.256 which is not significant at 0.05 levels, representing a weak positive correlation between the staff efficiency and financial sustainability of rural banks. 85.2 % of the observed variability in financial sustainability can be explained by the differences in four independent variables namely administrative efficiency, operating efficiency, financial efficiency and staff efficiency. The remaining 14.8% is not explained which means that the remaining 14.8% of the variance in financial sustainability is related to other variables.

### **Overall Findings of the Research**

- Rural bank of MPCs utilizes its retail earnings to the portfolio investment (outstanding).
- Financial assets of the rural banks of MPCs are utilized efficiently every year.
- There is not enough staff for rural banks to carry out their activities.
- There is a high level of gearing or leverage and which trend is in on increasing manner every year.
- There is an increasing trend of administrative expenses and operating expenses over the year's from 2007 to 2011.
- Major revenue source of more rural bank is interest income from direct investment in head office and banks.

### **Suggestions and Recommendations**

Suggestion to manage rural banks' efficiency and to increase their financial sustainability. In this analysis, it is given that how efficiency deals with sustainability. So, suggestions are presented to manage the efficiency and to increase sustainability. Some suggestions are given to manage the microfinance institution's efficiency. They are;

- The management of microfinance institutions should reduce their administrative and operating expense. Then only they can provide more loans to existing customers by extending maximum loan limit and they can attract new customers.(increasing efficiency)
- The management of MFIs increases the loan to borrower through reducing the interest rate.
- For sustainable development of rural banks, a mechanism must be there to help the poor farmers or borrowers instantly and quickly in the event of any emergency need.

- The office layout system is very poor in public sector. Therefore, department head should establish proper layout system in their office.
- A rigorous and deeper investigation is required to find out the ways to prevent the misuse or inappropriate use of credit by borrowers and encourage the clients to settle the loan quickly.
- Operating income should be increased for set off the transaction cost of rural banks. Therefore, interest rate structure should be reviewed, and appropriate interest rate should be determined scientifically.
- Rural banks should maintain their records properly. For this, they should completely computerize their activities quickly and very accurately.
- When they introducing new loan system or work scheme, they should provide proper training to their loan officers for loan recovery and group decision making should be encouraged.
- Importantly, the rural banks should recruit new loan officers and staff for providing their services to the clients effectively and staff for providing their services to the clients effectively and staff should work at office from 9 am to 4 pm.
- The co-operative rural banks should follow flexible conditions for getting the loans. They should encourage clients to invest in important sectors to develop our country.
- MFIs officers should not do in same work continuously. They should transfer another subject to every two or three years, by which they can't feel degradation among their work.

### **Suggestions for Future Research**

- This research has been done, taking the Jaffna district as a sample. But, future researcher should take other districts as samples.
- There are 31 rural banks which are functioning under 23 MPCs in Jaffna district. This research has taken only 10 rural banks as sample. But, the future research should take more than 20 rural banks as sample.
- This research was carried out based on only give years from 2007 to 2011.this types of research require long rue period.

### **REFERENCES**

1. Asia Development Bank (2000), 'Finance for the Poor: Microfinance Development Strategy', Manila.
2. Akhtar, M.H. & Bokhari, S.M.H (2005), 'X- efficiency Analysis of Commercial Banks in Pakistan: A Preliminary Investigation'. European Journal of Scientific Research, 10 (2), 78-91.
3. Avishay. B and Monica. H (1991),' Improving rural finance in developing countries'. A quarterly publication of the international monetary fund and the World Bank vol.28, no. 1.
4. Berenbach and Guzman (1992), 'the solidarity group methodology worldwide: evaluation of credit methodologies', concept paper,

5. Claudio Gonzalez- Vega, Mark Schreiner, Richard L. Mayer, Jorge Rodriguez & Sergio Navajos(1996), BANCOSOL- the challenge of growth for microfinance organization’.
6. Canadian International Development Agency (1999), ‘Reference guide for the microfinance sector’, 200, promenade du portage Gatineau, Quebec, august.
7. Craig Churchill and Dan Coaster (2001),’ Microfinance Risk Management Hand Book’, Care international.
8. Damian von Stauffenberg (1998), ‘Definitions of Selected Financial Terms, Ratios and Adjustment for Microfinance’, Micro Banking Bulletin., July.
9. Elisabeth Rhyne (1998), The yin and yang of microfinance: reaching the poor and sustainability, Micro Banking Bulletin., July.
10. Global Micro Rate Africa (2003), ‘Performance Indicators for Microfinance Institutions, Technical Guide’, Johannesburg, RSA, Washington D.C.
11. Hume David and Paul Mosley (1996),’ micro credit interest rate’, CGAP secretariat. Occasional paper no.1 august, Washington D.C.
12. Jacob Yaron (1992), ’successful rural finance institutions’, World Bank discussion papers. The World Bank Washington, D.C.
13. Jan Evers, Stefanie Jack, Adriaan Loef & Hedwing Siewertsen (2000), ‘reducing cost and managing risk in leading to micro enterprise: hand book for micro leading in Europe’, IFF- Institutfurfinanzdien Steleistungen e.v., Hurburg Germany. February.
14. Jayewardene. A.S (2003), ‘Role of Microfinance in Rural Development, Issues and Challenges of Microfinance’: Workshop Report: Sarvodaya Economic Enterprise Development Services (GTE) Ltd. Hotel Coral Gardens, Hikkaduwa, Sri Lanka.
15. Joanna Ledgerwood (2000), Microfinance Hand Book. The World Bank Washington D.C., July.
16. Marguerite S. Robinson (2002), the Microfinance Revolution- Sustainable Finance for the Poor, the World Bank Washington D.C, Open Society Institute, New York.
17. Martin Holtman (2001), Designing Financial Incentives to Increase Loan Officer Productivity: Handle with care, Micro Banking Bulletin, April.
18. McIntosh, de Janvry and Sadoulet (2005),’microfinance: a panacea for poverty’, development research briefings, university college Dublin, 1997.
19. Monica Brand (2000), ‘More Bang for the Buck: Improving Efficiency’, Micro Banking Bulletin, February.
20. Monica Brand and J.Gerschick (2001), ‘Finance for the poor’ – volume 2, Asian development bank publication Unit.
21. Naser Abdelkarim (2002),’ the long term financial sustainability of the Palestinian NGO sector, an assessment study commissioned by the welfare association consortium.
22. Nimal Sanderatne (2003), ‘Microfinance Interest rate and Financial Viability’, Research Paper 1<sup>St</sup> of May.

23. Otero (1999), 'Managing Growth: The Organizational Architecture of Microfinance Institutions', Paper prepared for Micro enterprise Best Practices, Development alternatives, Inc., Bethesda, Maryland.
24. Richart Gant, Dulan De Silva, Anura Attapattu & Steve Durant (2002), National Microfinance Study of Sri Lankan Survey of Practice and Policies, Colombo, June.
25. Robert Peck Christen (1997), 'An Expanded and Revised Guide Book for Microfinance Institutions', February.
26. Schreiner and Colombet (2001), 'Microfinance: A Panacea for Poverty', Development Research Briefings, University College, Dublin.
27. Todd Forrington (2000), 'Efficiency in Microfinance Institutions', Micro Banking Bulletin, February.
28. USAID (1995), 'Maximizing the outreach of micro enterprise finance': the emerging lessons of successful programs.

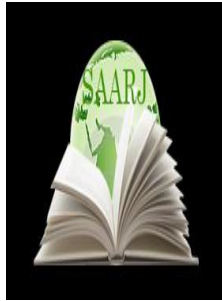

**ACADEMICIA**  
**An International  
Multidisciplinary  
Research Journal**  
(Double Blind Refereed & Peer Reviewed Journal)



DOI: **10.5958/2249-7137.2021.01098.3**

## **PROSPECTS FOR SMALL BUSINESS AND ENTREPRENEURSHIP DEVELOPMENT IN UZBEKISTAN**

**Sanjar Sabirjonovich Sabirjonov\***; **Jamshid Nizam oglu Kubayev\*\***

\*Senior Lecturer,  
Tashkent Financial Institute,  
UZBEKISTAN

\*\*Student,  
Tashkent Financial Institute,  
UZBEKISTAN

### **ABSTRACT**

*This article discusses the prospects for the development of small business and private entrepreneurship in Uzbekistan, based on the achievements of advanced science and innovative technologies, the development of small business and private entrepreneurship. Private entrepreneurship can be active only in certain areas, so it is necessary to create the necessary conditions for the development of small business. For this, in our opinion, it is necessary to create financial funds. This shows that there are great opportunities for the development of entrepreneurship in rural areas. At the same time, it is necessary to redistribute the surplus labor force engaged in agricultural production to service, processing and so on.*

**KEYWORDS:** *Private Entrepreneurship, Small Business, Prospects, Development, Market Economy.*

### **INTRODUCTION**

One of the essential goals of building a socially oriented market economy in Uzbekistan is the priority development of small business and private entrepreneurship in the country. To achieve this goal, economic reforms have been carried out, and large institutional frameworks have been created to enhance its role. These include legal and regulatory documents governing the organization of entrepreneurial activity, non-governmental organizations and enterprises that assist entrepreneurs. The establishment of a complex of private entrepreneurship and small business in Uzbekistan is successfully underway.

### **The main results and findings**

The main factor in the sustainable development of our economy is innovation. With the help of innovative technologies, it is possible to deep restructure small businesses and private entrepreneurship and further increase productivity. It is known that today small business and private entrepreneurship play a leading role not only in accelerating the growth of the national economy, but also in addressing the issues of employment and improving living standards, which are relevant today.

The compactness and mobility of small business, its ability to adapt to changes in market conditions and consumer needs will help it to overcome the negative effects of the global financial crisis and create new jobs and increase incomes in the context of sustainable post-crisis economic development.

Indeed, by ensuring the consistent development of small business and private entrepreneurship, our country is achieving the formation and strengthening of the middle class, which is the socio-political support and foundation of our society. Therefore, we must now not only increase the number of small businesses, but also develop them, first of all, qualitatively, in this regard, we must pay special attention to the transition from simple production to complex, high-tech production focused on domestic and foreign markets.

In our opinion, the development of small business and private entrepreneurship in Uzbekistan based on advanced scientific achievements and innovative technologies and increase its efficiency is an important necessity due to the following factors:

- ❖ first, the fact that small businesses have the ability to adapt to changes in market conditions and consumer needs has a positive effect on the introduction of innovative technologies in terms of low risk compared to large enterprises;
- ❖ secondly, the introduction of innovative technologies in the activities of small businesses will reduce their high transaction costs and increase profitability;
- ❖ third, the potential of small businesses to absorb innovations quickly allows them to earn high returns from the commercialization of innovations;
- ❖ fourth, the introduction of innovative management technologies in the activities of small businesses will increase their export potential and competitiveness by reducing the cost of their products, increasing the range of goods and services, expanding sales of new types of goods and developing promising markets for products.

Small businesses can create jobs independently of the state, that is, without large capital investments, reduce the shortage of temporary goods, and even eliminate this shortage completely. In today's society, it is necessary to direct the activities of small businesses to meet the needs of individuals. This is evident in the field of consumer services and consumer goods. Small businesses also play an important role in introducing technological innovations.

The number of small businesses and private entrepreneurs in our country and the volume of their products is growing every year. Laws of the Republic of Uzbekistan "On Enterprises", "On Property", "On Guarantees of Free Entrepreneurship", Presidential Decrees, Resolutions of the Cabinet of Ministers and others it is organized on the basis of supporting documents.

In the context of scientific and technological development, small business and private entrepreneurship are increasingly finding their place in the transition of leading industries to new technologies. They demonstrate the basic connective quality of the whole system, which provides the work process with new ideas and improvements in production, the introduction of new information technologies.

Today, small business and private entrepreneurship operate in all sectors of the economy, in the production of machinery, consumer goods, agriculture and food, and other areas.

The products produced by small businesses and private enterprises differ from the products produced by state-owned enterprises in terms of quality and, in some cases, even higher. 60-70% of the activities of small business and private entrepreneurship in the country are directly related to production, they are farmers, industrialists and processors of agricultural products, etc.

Compared to large companies, small enterprises adapt quickly to market conditions and have a number of advantages in ensuring the success of their products in the market. This is due to the fact that small businesses are quickly adapting their activities to narrow production programs, advanced technology, the production of low-demand science-intensive products, and quickly master the basics of the market.

According to the forms of ownership, the following types of small enterprises can be distinguished:

- State-owned small businesses
- Small businesses based on community ownership
- Small businesses that operate on an individual basis based on the property of citizens
- Rental businesses
- Small joint ventures.

There has been a steady increase in the number of small businesses in the country in all sectors of the economy, including transport, communications, healthcare and other non-manufacturing sectors.

Small business and private entrepreneurship are also gradually developing in the field of foreign economic activity. The main exports of small businesses are agricultural, textile, processing, electrical products and handicrafts.

The above analysis shows that in recent years in the Republic of Uzbekistan, enterprises engaged in private entrepreneurship, small business are being established in all sectors of the economy. At the same time, the role and importance of small businesses in the economy is growing. The role of private entrepreneurship and small business in the development of the national economy is characterized by:

- ✚ private entrepreneurship provides the necessary speed in a market economy, creates deep specialization and branched cooperation in production, without which high efficiency is impossible;
- ✚ creates the necessary competitive environment for the market and is characterized by the ability to quickly change the type of production in response to changing market demands;

✚ it is able to quickly fill the gaps in the consumer sector and quickly recoup the investment made using the latest machinery and technology.

Small business and private entrepreneurship and everything connected with it are an important and integral part of the organizational structure of modern social production. Therefore, small business and private entrepreneurship play an important role in the development of the state economy and are supported by the state.

Private entrepreneurship and small business are finding their place in the context of accelerating the development of science and technology, the transition to new technologies in advanced industries. Such entrepreneurship is an integral part of the whole system, which provides work with new information technologies, new ideas and modernization of production. In addition, small businesses are one of the preferred forms of production in high-risk conditions.

Small businesses also play an important role in introducing technological innovations. Small businesses, which adopt new technological ideas faster than large enterprises, have less risk and can get things done faster than large-scale production. This can contribute to the development of scientific and technological progress in our conditions.

While acknowledging the positive role of small business and private entrepreneurship in the development of the economy, it is also wrong to overestimate its importance. Private entrepreneurship can be active only in certain areas, so it is necessary to create the necessary conditions for the development of small business. For this, in our opinion, it is necessary to create financial funds. These funds should guarantee entrepreneurs to obtain soft loans in commercial banks, serve as a source of subsidies, including non-repayable subsidies (for the development of enterprises in certain priority sectors of the economy).

Improving the system of financial support for small businesses in Uzbekistan should be aimed at stimulating the activities of banks, funds, investments and insurance companies that provide services to small businesses and private entrepreneurship. In the Republic of Uzbekistan, as in other countries, the company can receive soft loans if it participates in the priority state program (creation of new equipment, development of remote areas, etc.). At the same time, the minimum interest rate and long-term repayment are the main conditions for lending.

## CONCLUSION

Deepening economic reforms, development of small business and private entrepreneurship is one of the main directions of economic reforms in the country. This requires the development of economic competition, filling the consumer market with goods and services, as well as the creation of a wide range of private entrepreneurs. With this in mind, today the Republic needs to address the following issues:

- introduction of a wide range of the population to market activity, elimination of their dependence, consumer psychology, arousal of the population's desire to be actively engaged in private entrepreneurship, small business;
- radical renewal of economic relations in agriculture, further development and increase in the number of farmers and farms, the creation of small businesses in the regions to provide additional jobs for the temporarily unemployed;



- acceleration of market relations and infrastructure in the region, creation of conditions for the development of economic competition;
- creation of economic and social conditions that will fully meet the growing needs of the population of the republic;
- sharply increase the range and scope of services provided, ensure a high level of organization of banking, auditing, consulting and various intermediary activities on the basis of modern science and technology;
- creation of conditions for increasing the efficiency of management of enterprises, ensuring their economic independence;
- introduction of small enterprises that can produce goods for export, filling the consumer market with goods that can easily adapt the types and volume of products produced locally to market requirements.

It is known that more than 65% of the able-bodied populations in the country live in rural areas. This shows that there are great opportunities for the development of entrepreneurship in rural areas. At the same time, it is necessary to redistribute the surplus labor force engaged in agricultural production to service, processing and so on. Addressing organizational and economic issues at various levels of government related to the development of entrepreneurship and its small businesses in rural areas is one of the priorities.

#### REFERENCES:

1. Primova A. A. "Texts of lectures on the course" Small business and entrepreneurship "Bukhara -2013.
2. Boltabaev M.R., Qosimova MS, Ergashkhodjaeva SH.J., G'oyipnazarov I; .K., Samadov A.N., Khodjaev R.S. Small business and entrepreneurship. - T .: AV1VMAZNK1UOT1, 2016.
3. Small business. Organization, ekonomika, upravlenie: Uchebnoe iosobie dlya vuzov / Pod red. Prof. V.YA. Gorofinklya, prof. V.YA. Gorfinkelya, N.L. SHvandara.-2eizd., Prereb. Idop.-M.:YUNITI-DANA,2018.
4. <https://talaba.su/>

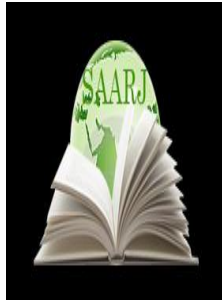

DOI: **10.5958/2249-7137.2021.01099.5**

## MILITARY REFORMS AND MILITARY TRAINING IN THE REPUBLIC OF UZBEKISTAN

**Ravshan Siddikov\***

\*Assistant Professor, Candidate Of Historical Sciences,  
National University Of Uzbekistan, Named After Mirzo Ulugbek,  
Tashkent, UZBEKISTAN

### ABSTRACT

*In article it is examined many-sided activity of country for reform of armed forces of the Republic of Uzbekistan, corresponding modern demands and processes of becoming mobile, scanty, good armed modern army, and also problems of formation of the system of highly qualified national officer specialists and development of higher military education on the base of practical learning of achievements and experience of foreign countries.*

**KEYWORDS:** *Armed Force Of The Republic Of Uzbekistan, Modern Army, Reforms In Military Sphere, National Military Specialists, The Higher Military Institutions, And Military Education.*

### INTRODUCTION

From the first days of independence, the First President of the Republic of Uzbekistan Islam Karimov - Commander-in-Chief of the Armed Forces, has always paid great attention to the reform of the Armed Forces and its modernization in line with modern requirements [1]. It is known that the main goal of military reforms is to create an army that is modern, small, mobile, well-armed, able to effectively address strategic and tactical tasks and protect the country's sovereignty, security and territorial integrity, as well as peace and stability from any aggression. To this end, a long-term program of building and organizing the Armed Forces on a completely new basis, taking into account the rapidly changing socio-political situation in the world, based on the "Concept of National Security of the Republic of Uzbekistan" adopted on August 29, 1997 by the Decree of the First President Islam Karimov. developed. [2]. At the initial stage of the formation of the Armed Forces of the Republic of Uzbekistan, the main focus was on organizational and structural issues, primarily the creation of military districts, border and military units in key areas. Also, the composition of the Armed Forces was optimized by

combining the Military Air Force and air defense troops into a single center. At a later stage, in order to improve the military system, the United States was newly formed-the Armed Forces, capable of solving operational and strategic tasks, embodying the defense force of the country, which is subordinated to a single center, which unites the important joints of all Armed Forces on the basis of the General Staff.

### **The main results and findings**

In order to ensure the potential of the military personnel of the Armed Forces of Uzbekistan at the modern level, schools of training of sergeants in all military districts began their activity. On a planned basis, the composition of the Armed Forces was replenished on a contractual basis. In recent years, the combat readiness of military units of the Armed Forces of Uzbekistan has been steadily increasing. As a result of the reforms, the transition to a professional army on a contract basis is almost complete. Over the past period, the material and technical and educational base of military schools and sergeant training schools have been strengthened and modernized, as well as equipped with modern computers, the introduction of information and communication technologies in the educational process. As a result, it is possible to train and educate a new generation of highly qualified national military personnel.

At the same time, the Government of the Republic of Uzbekistan pays constant attention to the provision of the Armed Forces with modern weapons and military equipment. At the same time, close military-technical cooperation with leading countries, including the Russian Federation, the People's Republic of China and others. established.

In military construction, special attention was paid to the social protection of servicemen of the Armed Forces and their families, and the issues of providing them with housing and medical care were implemented on the basis of targeted programs. Today, Uzbekistan has a small modern army and plays an important role in maintaining peace and stability in Central Asia.

It should be noted that in a short historical period, as a result of gradual reforms, the Armed Forces of the Republic of Uzbekistan has acquired the most potential, well-trained army in the region, equipped with modern equipment.

Today, great attention is paid to increasing the combat readiness of the Armed Forces, strengthening its organizational structure and further improving the joint action of all military districts and types of troops. The increase in the share of sergeants and contract servicemen in the army, the reduction of military service by one year has led to a radical change in the morale of the Armed Forces and the morale of the military.

As a result of gradual reforms and modernization based on the adopted Military Doctrine and a comprehensive long-term program, modern standards of command and control of the Armed Forces, and possibly a theater of military action, take into account the peculiarities of the rapidly changing world situation. , a new system based on the practical mastery of the experience and achievements of foreign countries has been formed.

An entirely new organizational structure of the Armed Forces and its main combat units were introduced. As a result, the speed, mobility and combat readiness of military units have been increased. Most importantly, the independence and responsibility of commanders at all levels has been increased. Operational special units of the Armed Forces have also been established in key

strategic areas. Much attention was paid to the preparation of special units, their provision with modern weapons.

The fact that special forces played a key role in the suppression of international terrorist groups that invaded the mountainous areas of Surkhandarya and Tashkent regions proved the correctness of the chosen path. One of the most pressing issues in the process of formation of the Armed Forces of the Republic of Uzbekistan - the training of military personnel and the improvement of military education is one of the main directions of the system of the Ministry of Defense. Theoretical foundations of the formation of the military management system and training of military personnel in Uzbekistan were presented by the First President of the Republic of Uzbekistan Islam Karimov. developed in his works entitled.

Indeed, in order to form a system of training national military personnel, in accordance with the Resolution of the Supreme Council of the Republic of Uzbekistan "On military units and military educational institutions located in the territory of the Republic of Uzbekistan" on January 14, 1992. The existing military schools were also taken over by the Republic of Uzbekistan.

The first president of the Republic of Uzbekistan Islam Abduganievich Karimov addressed the problems in the field of military construction in the early years of independence in his work "our National Army is a strong guarantee of our independence, peaceful and peaceful life": "the most difficult problem we faced in this regard was the issue of personnel in the army. At that time, there were very few local personnel in the ranks of the military. In 1990, local officers insisted that only 0.6% of the migrants in our country were in the military presence in the country, and 4% were in the military presence in the country.

In order to solve this problem, the military education system has been radically reformed. A number of higher military educational institutions have been set up to train military personnel with sufficient military service potential. Currently, the Tashkent Higher Military Command, Chirchik Higher Tank Command-Engineering, Jizzakh Higher Military Aviation Schools, Tashkent University of Information Technologies are preparing highly qualified personnel in various military fields.

In 1995, on the initiative of the First President of the Republic of Uzbekistan Islam Karimov, the Academy of the Armed Forces of the Republic of Uzbekistan, the only one in Central Asia, was established. This institution is tasked with training and retraining of qualified officers, as well as coordinating modern, innovative scientific and practical research and development in the military sphere, the development of military education in our country. In 2012, the Faculty of Military Medicine was established at the Tashkent Medical Academy. Training of highly qualified medical officers, reserve and reserve officers with high intellectual potential, regular increase and retraining of military and professional training of medical personnel of the Armed Forces, deepening of special knowledge and skills, conducting research in the field of military medicine. defined as the direction of activity.

Today, the higher military educational institutions of the Ministry of Defense of the Republic of Uzbekistan are training highly qualified officers for our Armed Forces in about 30 areas. An effective system of training, retraining and advanced training of officers and sergeants has been created in the country. Higher courses and the Academy of the Armed Forces of the Republic of Uzbekistan. These educational institutions provide servicemen with the opportunity to improve

their professional, theoretical and practical knowledge, experience and skills in military activities.

In accordance with the Decree of the First President of the Republic of Uzbekistan Islam Karimov dated April 19, 2005 "On additional measures to improve the system of military education in the Republic of Uzbekistan" [5], largescale reforms were carried out in all military educational institutions. This allowed young military specialists to improve their professional skills and improve their training process. All conditions have been created for future officers to receive a thorough knowledge of martial arts and academic sciences on the basis of modern training programs. In this regard, it is necessary to dwell on the activities of the Tashkent Higher Military Command School. Indeed, the Tashkent Higher Military Command School, the first of the modern military educational institutions in the Republic of Uzbekistan, has a rich history and now plays an important role in the training of highly qualified officers with higher special military education. Today, this educational institution is one of the leading institutions of higher military education, which trains highly qualified officers to fill the command and tactical units of the general and border units of the Armed Forces. Since 1992, more than 6,000 officers have graduated from this higher military education institution. 500 of them graduated with honors. Due to its rich material and technical base and high intellectual potential of cadets, Tashkent Higher Military Command School won the competition "The most advanced higher military educational institution" of the Ministry of Defense of the Republic of Uzbekistan for the fifth time [6].

The Military Doctrine of the Republic of Uzbekistan pays special attention to improving special military education, taking into account global threats and the threat of religious extremism and terrorism in the world. For this purpose, the faculty of training specialists in counter-terrorism and special operations was opened at the Chirchik Higher Military School of Command and Engineering [7].

To date, the military academy has trained tank and airborne units, as well as commanders of anti-aircraft missile units and engineers of tank units.

Thus, as the first president of the Republic of Uzbekistan Islam Karimov said in the festive greeting to The Defenders of Vatan on the occasion of the 24th anniversary of the establishment of the Armed Forces of the Republic of Uzbekistan "the development of a new co-operation in the field of military construction in the organization of the modern Armed Forces of It should be noted that this conciliation is based on the comprehensive consideration of the peculiarities of the old, the passing of its life, the complete rejection of decisions in one mould, perhaps the theater of military actions under arrest, as well as the rapidly changing situation around us, near and far, as well as on the practical assimilation of the experiences and achievements. In short, as a result of the reforms carried out in the military sphere in the Republic of Uzbekistan, the Army was restored, capable of protecting the country's security and peace League from any aggression, modern, well-armed, fast-paced and highly qualified officers, meeting the requirements of the globalisation period.

## CONCLUSION

It is known that the Law on Defense Doctrine of the Republic of Uzbekistan, adopted on December 18, 2017, defines the principles and approaches to ensuring the national security of the Republic of Uzbekistan in the military sphere, which confirms the doctrinal nature of the

doctrine □ 9 □ . This, of course, is a sign that Uzbekistan is committed to a peaceloving policy. In 2021, the Armed Forces of Uzbekistan took 51st place in the Global Firepower Index, one of the most prestigious rankings in the world. Of the neighboring Central Asian states, the Republic of Kazakhstan ranks 62nd. In total, the list includes 138 countries, whose military strength is assessed on the basis of more than fifty factors. The Uzbek army is recognized by the authoritative publication as the strongest in Central Asia and one of the strongest in the CIS [10]. Of course, this recognition is a high assessment of the reforms carried out in the military sphere in recent years under the leadership of the President of the Republic of Uzbekistan, Commander-in-Chief of the Armed Forces Shavkat Mirziyoyev.

#### REFERENCES:

1. The Constitution of the Republic of Uzbekistan. - T .: Uzbekistan, 2015. - P.47.
2. On approval of the National Security Concept of the Republic of Uzbekistan dated August 29, 1997. [www.Lex.uz/pages/getpage.aspx?\\_id=118360](http://www.Lex.uz/pages/getpage.aspx?_id=118360)
3. Resolution of the Supreme Council of the Republic of Uzbekistan № 527 - XII. 14.01.1992.
4. Karimov I.A. Our national army is a strong guarantee of our independence, our peaceful and serene life. –T .: Uzbekistan, 2004. - B.10.
5. [www.Lex.uz/pages/getpage.aspx?Lact\\_id=1282790](http://www.Lex.uz/pages/getpage.aspx?Lact_id=1282790)
6. A place for training highly qualified officers. <http://xalq-ijodiyoti.uz/yksak-malakali-ofitserlar-taiyorlanad/>. 23.01.2016.
7. <http://uzbek.irib.ir/item/17247>. Retrieved 15.03.2016.
8. Halq suzi. January 14, 2016.
9. <http://lex.uz/docs/3495885>.
10. <https://uz.sputniknews.ru/amp/20210115/Uzbekistan-podnyalsya-v-reytinge-voennoy-moschi-no-ustupil-Belarusi-15798102.html>. 15.01.2021
11. Siddikov, R. (2021). Higher Education And Training In Uzbekistan On The Eve Of Independence. *The American Journal of Social Science and Education Innovations*, 3(02), 88-92.
12. Siddikov, R. B. (2021). Reforms In The Higher Education System Of Uzbekistan: Problems Of Transformation. *Journal of Contemporary Issues in Business and Government*, 27(1), 399-412.
13. Siddiqov, R. B. (2015). TRADITIONS AND INNOVATIONS OF ISLAMIC EDUCATION IN INDEPENDENT UZBEKISTAN. *Islam in the modern world*, 11(4), 241-248.
14. Mardievna, B. M., Mukhamadjanovna, J. S., Nematovich, N. O., & Azamovich, T. V. (2020). The importance of modern methods and technologies in learning English. *Journal of critical reviews*, 7(6), 143-148.

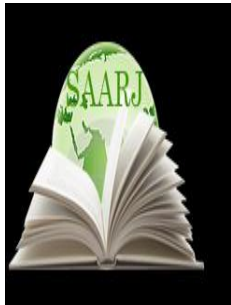

**ACADEMICIA**  
**An International**  
**Multidisciplinary**  
**Research Journal**  
 (Double Blind Refereed & Peer Reviewed Journal)



**DOI: 10.5958/2249-7137.2021.01100.9**

## THE ROLE OF THE TEACHER IN ENSURING THE QUALITY OF EDUCATION

**Shaniyazova Dilafruz Sabirovna\***

\*Senior Lecturer,  
 Department of Pedagogy,  
 Psychology and Education Management of Kashakadarya,  
 UZBEKISTAN

### ABSTRACT

*This article deals with the importance of the teaching profession in society, the attention paid to it and the growth of the status, honor and dignity of teachers in our country. Although he was a disciple of Aristotle, known throughout the world as the first teacher, he acknowledged the wisdom of the elders and learned much from our people. During the years of independence, raising the prestige of the work of coaches, the main executor of education, the prestige of teachers has also become one of the important issues within the government. In this process, the teacher suffers a lot, experiences hardships. That is why students should feel indebted to the teacher for life. Even if a student achieves a royal position, it is worthwhile to serve the teacher.*

**KEYWORDS:** *Aristotle, Hardships, Independence*

### INTRODUCTION

The teaching profession has been glorified since ancient times, and the scholars of the East, in their invaluable spiritual heritage, have shown boundless respect and reverence for the Master and embodied in their image the image of a perfect man who can be an example to all. At the same time, there are a number of requirements for these professionals, including the following requirements for teacher etiquette in Navoi's Mahbub-ul-qulub:

- The teacher should not treat children according to the position and wealth of their parents;
- The teacher should teach children what they know, not try to teach what they do not know;
- Defects such as arrogance, pride, greed, ignorance are qualities that are alien to the teacher's ethics;

- The teacher must stay away from bad deeds, impurity;
- Teachers, who are considered scientists in the eyes of the people, should be able to refrain from bad deeds and corruption.

One of the oldest manuscripts in the world, the Book of Avesto, which was created on our soil 30 centuries ago, reads: Education should be the most important pillar of life. It is necessary to bring up every young person in such a way that he first rises to the highest level by organizing good reading and songwriting.

According to Greek historians, Alexander the Great had a conversation with the elders of the people when he was shooting from a country between two rivers. Although he was a disciple of Aristotle, known throughout the world as the first teacher, he acknowledged the wisdom of the elders and learned much from our people. One day, when Alexander was asked why he valued his teacher more than his father, he replied: My father raised my body and brought it down from heaven to earth. My Master, on the other hand, nurtured my spirit and raised it from earth to heaven.

Indeed, the role of teachers in the development of great scholars is invaluable. The minister and scholar Abu Nasr ibn Iraq saw a boy on the outskirts of the city, immediately noticing his talent and raising him. Abu Nasr shows paternal love to the child and teaches him as a teacher. This child grows up and is known to the world as an encyclopedic scholar Abu Rayhan Beruni.

The teacher-student Mirzo Ulugbek and Ali Kushchi embody many wisdom of life. Mirzo Ulugbek, Ali Kushchi was dedicated to growing up as a leading scientist, and the student showed dedication in promoting his teacher's scientific heritage to the world.

Yes, when we say a teacher, we mean a radiant image of selfless people who bring up people who contribute to the peace of the country, the prosperity of the Motherland and the well-being of the people. Thankfully, thanks to the services of such teachers, a harmoniously developed generation is growing up in our country, laying the foundation stones for the great future of Uzbekistan. During the years of independence, raising the prestige of the work of coaches, the main executor of education, the prestige of teachers has also become one of the important issues within the government. This has expanded the ranks of dedicated teachers, inspiring the teaching community to creative endeavors. Thanks to the hard work of our teachers, today's schools in Uzbekistan are becoming the cradle of true virtues, the threshold of recruitment to greatness.

Many talented students of our country take high places in international science Olympiads, music and art festivals, sports competitions. Teachers of such students, who spread the fame of our country to the world, deserve the Hero of Uzbekistan, People's Teacher and other high awards of our Motherland.

After all, the President of the Republic of Uzbekistan Sh. Mirziyoyev, while giving the necessary instructions to raise the prestige of the teacher, said in a video conference on June 21, 2018 that I do not respect those who do not respect the teacher. Such attention to the teacher will definitely serve the development and prosperity of the country.

Following the adoption of the Presidential Decree No. PQ-3931 of September 5, 2018 on measures to introduce new principles of governance in the public education system, the law No. ID-1852 on the status of a teacher was adopted in accordance with this decision. It is safe to say



that the fact that the law guarantees the honor and dignity of teachers has encouraged teachers in our country to work more diligently, not to lag behind the requirements of the times, and to help their students to become full-fledged adults in the future.

In addition, the increase in teachers' salaries by an average of 2.5 times over the past three years, the introduction of additional incentives for teachers working in remote areas, serve to increase the willingness of dedicated teachers to work harder and achieve greater success in education.

From the above considerations, it is clear that the teaching profession is not only difficult but also honorable. At this point, the question arises as to what is his hardship and what is his honor. We found it necessary to answer this question with the following thoughts of Navoi, that is, in his opinion, sometimes one person is unable to bring up one child, and the teacher teaches science to several children. In this process, the teacher suffers a lot, experiences hardships. That is why students should feel indebted to the teacher for life. Even if a student achieves a royal position, it is worthwhile to serve the teacher.

From this point of view, a person who loves his profession and enjoys his work is truly happy. Awakening every morning with the desire to see a few disciples, to contribute to the upbringing of the next generation, and to send compassion to innocent hearts is the pinnacle of happiness.

#### **REFERENCES:**

1. Resolution of the President of the Republic of Uzbekistan dated September 5, 2018 No PP-3931 on measures to introduce new principles of governance in the public education system.
2. Alisher Navoi Mahbub ul qulub. T. : Gofur Gulom Publishing House, 1993, p.79.
3. Official telegram channel "For public educators".

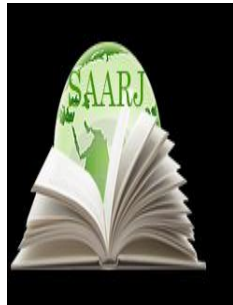

**ACADEMICIA**  
**An International**  
**Multidisciplinary**  
**Research Journal**  
 (Double Blind Refereed & Peer Reviewed Journal)



**DOI: 10.5958/2249-7137.2021.01101.0**

## LINGUODIDACTIC BASES OF TEACHING OF THE TOURISM TERMS IN ENGLISH LANGUAGE AT EDUCATIONAL SYSTEM OF UZBEKISTAN

**Nishanova Khafiza Vafokulovna\***

\*A Researcher of Uzbekistan State World Languages University,  
 UZBEKISTAN

Email id: hanifa\_81@mail.ru

### ABSTRACT

*In this scientific article it is described that the problem of teaching students to linguodidactic bases of terms. Linguodidactics as a general theory of foreign languages learning, in the process of teaching terms about tourism specialty requests taking into consideration the linguistic peculiarities of those terms. Thus, the purpose of studying the terms related to tourism in English is to increase the vocabulary of students in the profession and to form their skills in working with texts related to tourism in English. It is necessary to take into account the achievements of modern linguistics, to generalize the modern perception of terms by students in English and to provide continuous training to future professionals, as well as the need to create a new generation of textbooks on terminology.*

**KEYWORDS:** *Method, Methodology, Linguistics, Tourism, Tourism Industry, Didactics, Vocabulary, Technology, English, Uzbek, Language, A Principle Bases, Foreign, Term.*

### INTRODUCTION

Resolution of the President of the Republic of Uzbekistan dated December 10, 2012 No PR-1875 "On measures to further improve the system of learning foreign languages" increasing the demand for common culture, the formation of readiness for international and intercultural cooperation [1].

Resolution of the President of the Republic of Uzbekistan dated August 13, 2019 No PR-1875 "On measures to further develop the tourism industry in the Republic of Uzbekistan" provides for further development of tourism in the Republic of Uzbekistan and training of qualified personnel in this field [2].

Resolution of the Cabinet of Ministers of the Republic of Uzbekistan No. RCM-433 of July 10, 2020 "On measures to create favorable conditions for the restoration and development of tourism in the Republic of Uzbekistan" also states that licenses for entrepreneurs engaged in tourism are written in at least two languages. indicates the need for a thorough study of terms in the field [3].

According to above mentioned facts, in present days successful results of the sciences that are connected with teaching methods of foreign languages are causing to develop significantly foreign language educational methods. The status of the foreign languages has changed in our society, the function of foreign languages is getting wider, we can observe this situation while preparing the students for any special professions. Nowadays one of the important problems on all stages of educational system, such as on higher educational system is to research new methods and techniques of teaching of foreign language, because it is being paid significant attention to develop teaching process.

Didactics is a theory of teaching, and in a wider sense, a theory and practical application of teaching and learning. In demarcation from "mathetics" (the science of learning), didactics refers only to the science of teaching. This theory might be contrasted with open learning, also known as experimental learning, in which people can learn by themselves, in an unstructured manner, on topics of interest. The theory of didactic learning methods focuses on the baseline knowledge students possess and seeks to improve upon and convey this information. It also refers to the foundation or starting point in a lesson plan, where the overall goal is knowledge. A teacher or educator functions in this role as an authoritative figure, but also as both a guide and a resource for students [4]. Methodology of teaching foreign language is inseparable part of the lingo-didactics.

Linguodidactics – a branch of science studying the patterns of students' evolution with a new language and culture in conjunction with their native language and culture [5].

In present days English language is one of the dominance languages that is being used in the world. Science, technics, culture, education, social and economic sciences as well other types of subjects cannot be imagined. Furthermore, the demand of the modern world is that every specialists and employees must have knowledge and experience about English skills. Especially, future employees of the tourism industry have to know specific tourism terms. Because, while they will have a conversation with tourists, of course they use English language.

Terms and tourism branches are two social phenomenon that depend on each other. Modern society cannot be imagined without tourism industry. Tourism industry is one of the important drivers to increase gross domestic production (GDP) of the country. Representatives of tourism industry describe and attract their clients, tourists, guests and visitors by the help of means of language. So, language is important means that provides collaboration between social, cultural and economic branches.

While using the language it is not always possible to describe the meaning of objects, phenomenon and their situations by the help of one word only. Therefore, sometimes the objects, phenomenon and their situations should be described with joining of two or more than collocations of terms.

People analyze their life experience that they achieved of course with word. Because, every happened phenomenon is described by the help of specific words. A word describes

understandings as a part of language. The collections of terms in language consist of tourism terms as a system of words. Teaching of tourism terms consists of base of the teaching languages.

The most important elements in topics about tourism industry are exactly terms. About this Catrin E. Morris mentioned that “Tourism is a multi-billion dollar business with hundreds of millions of travelers arriving in destinations across the world every year, but there’s a lot more to tourism than just the tourists” [6].

“*Tourism Studies and the Social Sciences* is based upon a multi-disciplinary social science approach to understand the significance and role of tourism in contemporary society. It introduces social science disciplines to the reader and applies relevant theories to the understanding of tourism.” [7].

It is an important issue to divide the differences between terminological part of philological science and understandings of nomenclature for learning new terms. The word “Terminology” was created from Latin word “terminus” and Greek word “logos”. It means “a science that is about specific terms” [8].

As A.A. Reformatskiy mentioned, the main function of terms is to name things and phenomenon. So, in functions of terms mainly nouns are used [9]. Also, R. Doniyorov said that, “The terms that consists of only nouns can be object of terminology” [10]. Also, F.S. Abdullayva mentioned that Linguodidactic basis of legal terms teaching in English consist of mainly nouns [11].

## **MATERIALS AND METHODS**

Students should have knowledge and experience about properties of tourism terms, namely their creating methods. Therefore, during the lessons of course it is necessary to pay attention to linguistic properties while teaching terms in English. Because, every term is inseparable part of all literature vocabulary of language.

## **RESULTS AND DISCUSSIONS**

While teaching English language linguistic properties of terms should be paid attention as followings:

- In English main terms consist of alone lexicon collocations, they are not divided to meaningful morphemes. For example: tour-qisqa sayohat, travel-uzoq masofali sayohat, hotel-mehmonxona, ticket-chipta, sightseeing-diqqatga sazovor joy, tourist-sayohatchi, guide-yo'l ko'rsatuvchi, etc.;
- while teaching terms about tourism, we should pay attention that might be multi-component terms;
- according to construction collocated terms, they might consist of two, three or multi-component tokens: cultural tourism-madaniy turizm, gap-year tourism-maktab yoki oliy ta'lim yoshlari biror masofaga borib ko'ngilli bo'lib, ham ishlab ham sayohat qilishlari, low environmental impact-past darajali muhit ta'siri, five-star hotel-besh yulduzli mehmonxona, etc.;

- although one component terms are not many, they are described as soft terms and they mean differently and they are mainly created by prefix: uncleared-tozalanmagan, unpaid-to'lanmagan, unconvertable-o'zgarmaydigan, etc.

While working with topics about tourism, learning lexical materials is performed by two steps:

1. Learning new vocabulary.
2. Starting to use the terms in the process of speech (it is a period to make perfect primarily the materials).

During the step of learning new vocabulary, the information of term is explained about its form, meaning and using position. Explaining the meaning of term (systemizing) is traditional method, in functional methodology it is not described as specific stage. Before presentation of term in learning language, the information is presented about term in students' mother tongue.

It was defined that teaching method with comparing Uzbek and English terms is more effective according to results of experiments about teaching tourism terms at tourism faculties of Universities. When terms in English language and Uzbek language were compared, their properties were defined as following:

- Partly suitable to terms in Uzbek language of terms in English language;
- Terms about tourism industry that are not met in Uzbek vocabulary;
- Pronunciation of English word is not suitable to pronunciation of Uzbek word;
- There are multi-component terms in Uzbek language too like in English language;
- There is a difference between the meaning of words that were transferred from English language to Uzbek language and etc.

While teaching terms about tourism in English language the experience of students about language should be paid attention. Because, students' language experience about tourism terms in Uzbek language influences to teaching process of pronunciation, reading, writing of tourism terms in English language. This influence can be positive and negative, as a results of negative influence "interference" might be appeared.

Students' experience in their mother tongue influences effectively when they learn English tourism terms as following two situations:

- Students can make some sentences by using terms as if their mother tongue when they describe their opinion, because the position of terms in English sentence is suitable to Uzbek language;
- Students learn how to use methods of terms in English language with paying attention to linguistic properties of tourism terms in English and Uzbek language

It is difficult for students to remember tourism terms in English, as a consequence that students do not know well terms using for tourism in their mother tongue. They can use to remember the meaning of new terms of tourism as following two forms, namely –it is performed without translation or with means of translation.

The non-translational method uses two categories, namely internal and external exhibitions. The methodological methods used in acquiring the meaning of new lexical units depend on the following factors: the nature of the term; belonging to the term active / passive; educational stage and student level; the presented form of the new term (hearing or reading comprehension); a place to introduce a new unit (lesson, textbook, dictionary), etc.

The presentation process is organized as follows. When a new word is taught in a non-translational way, it is broadcast, demonstrated in narration, picture, text, audiotape, and given approximately the following tasks:

- Understand the meaning of the term;
- translate;
- use in a sentence, etc.

Getting acquainted with the meaning of a lexical unit is the first printed educational step on the way to mastering it. The study of the compounding properties of a new word requires a special second stage. At this stage, exercises for repetition of terms, application in live speech are performed.

There are two ways to use a lexical unit in an exercise to gain access to a skill: the word being studied is used with different units in one place, or a lexical skill is formed by performing exercises using new phrases or changing places in different places.

Lexical exercises consist of informational and operational parts. The first part is an example of shwa performance since instruction, consisting of intermediate exercises that combine language rules as well as speech practice.

The task of the educational objectives is to achieve the level of application of the term tourism, which is the final work in the process of developing skills in the process of teaching foreign language tourism terms.

The use of the term is the final stage in the formation of a skill, and the free use of the term in the speech process, the meaning of which is revealed and begins to be used in speech, corresponds to the period of transition from skill to skill. Stepping from exercise to speech practice is understood to use the term tourism without the involvement of the mind in expressing ideas.

Prospective employees of the tourism industry must have the following skills in learning English:

- Oral and written translation of moderately difficult translation materials from English into Uzbek or from Uzbek into English;
- correct use of dictionaries and information on special terminology in the field of tourism;
- to find alternatives in the native language of lexical, grammatical phenomena in English;
- express the same terms using different language tools;
- to use a dictionary of terms in the field of tourism.

One of the directions of interdisciplinary communication in teaching English is the creation of bilingual dictionaries on various branches of tourism. This in itself enriches the vocabulary of lexical terms related to students' professional speech.

An indicator of mastery is the free use or recognition of speech in the field of tourism. Mastering means knowing at the skill level. The control of the level of mastery of the term is carried out in direct speech activity, not by deliberate inquiry, special inquiry.

The following principles are followed in the teaching of terms in the process of professional training:

1. The principle of reasonable limitation of the use of vocabulary in learning a foreign language.
2. The presentation of lexical units in language teaching is goal-oriented: the units used to reinforce lexical operation are designed to develop a specific skill and are used in conjunction with other units.
3. Taking into account the linguistic features of lexical units and the psychological aspects associated with their acquisition: lexical units are presented in the presentation and practice periods by describing abstract concepts, lexical units by visualization, lexical units by comparison and grouping, and functional (auxiliary) terms in context.
4. The principle of taking into account the didactic and lingo didactic laws of education: each lexical unit is gradually expanded in the stages of presentation, practice and application, namely the scope of meaning, sound and writing symbols and various combinations, context and group use are taught consistently.
5. The principle of combining the development of speaking skills and the acquisition of the term tourism in the process: the process of acquisition of the term implies the acquisition of material and the development of skills.

Based on the experience of the university, it can be noted that these principles are applied in the teaching of English terms.

## **CONCLUSION**

Thus, the purpose of studying the terms related to tourism in English is to increase the vocabulary of students in the profession and to form their skills in working with texts related to tourism in English.

It is necessary to take into account the achievements of modern linguistics, to generalize the modern perception of terms by students in English and to provide continuous training to future professionals, as well as the need to create a new generation of textbooks on terminology.

In conclusion, the following should be noted:

- When teaching English, it is necessary to take into account the linguistic features of the terms;
- In terms of teaching terms, it is effective to compare them with terms in English and Uzbek;
- When teaching the term tourism in English, it is necessary to take into account the language experience of students from Uzbek and English;
- It is advisable to develop lexical skills through exercises.

**REFERENCES**

1. <https://www.lex.uz/docs/2126032>
2. <https://lex.uz/docs/4474527>
3. <https://lex.uz/ru/docs/4930291>
4. [https://en.wikipedia.org/wiki/Didactic\\_method](https://en.wikipedia.org/wiki/Didactic_method)
5. <https://www.igi-global.com/dictionary/modern-linguodidactics-as-a-scientific-foundation>
6. Flash on English for tourism, Second edition. [www.elionline.com](http://www.elionline.com)
7. Andrew Holden, Tourism studies and the social sciences 241 p. [www.eBookstore.tandf.co.uk](http://www.eBookstore.tandf.co.uk). 2006.
8. Tsitkina F.A. Terminology and Translation: Towards the Basics of Comparative Terminology. - Lviv, 1988. (*In Russian language*)
9. Reformatskiy A.A. Thoughts on terminology. // "Modern problems of Russian terminology." - M., 1986. (*In Russian language*)
10. Doniyorov R. Some issues of technical terminology of the Uzbek language. - T.: «Fan», 1977. (*In Uzbek language*)
11. Abdullayva F.S. Linguodidactic basis of legal terms teaching in English. // Modern education. 2015. (12), p. 40-44. (*In Uzbek language*)





**ACADEMICIA**  
**An International  
 Multidisciplinary  
 Research Journal**  
 (Double Blind Refereed & Peer Reviewed Journal)

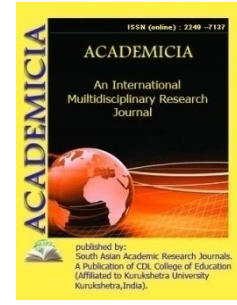

**DOI: 10.5958/2249-7137.2021.01102.2**

## THE EFFECT OF REPLANTING ON THE THICKNESS OF SEEDLING SEEDLINGS DEPENDS ON ITS VIABILITY AND SOIL FERTILITY

**Komilova Dilfuza Kutbidinovna\***; **Khalilova Marguba Gulomovna\*\***;  
**Turgunbaev Khondamira khtiyorovich\*\*\***

\*Andijan Institute of Agriculture and Agrotechnology,  
 UZBEKISTAN

\*\*Magister,  
 Andijan Institute of Agriculture and Agrotechnology,  
 UZBEKISTAN

\*\*\*Student,  
 Andijan Institute of Agriculture and Agrotechnology,  
 UZBEKISTAN

### ABSTRACT

*When obtaining seeds from sugar beet, the maternity depends directly on the timing of sowing the tubers and the thickness of the seedlings. Germination at 10.09 days (third term) Germination started on the 5th day after sowing and full germination was achieved in 5 days. During the last sowing period, there were some difficulties in germination. In conclusion, it can be said that in the Fergana Valley, the mother tubers, which are prepared for seeding from sugar beets, should be sown in the twentieth and thirtieth days of August and buried in the soil to minimize exposure to cold.*

**KEYWORDS:** *Sugar Beet, Seed Yield, Agrotechnical Measure, Repeated Crop, Economic Efficiency.*

### INTRODUCTION

In agriculture, seeds are the main factor in obtaining high and quality crops. The higher the quality of the seed, the higher the efficiency of the agro-technical measures taken to obtain the harvest. Today, the world's growing population requires increasing the efficiency of land use. To do this, it is important to constantly increase the share of crops per hectare, while achieving high quality. This problem exists in our country as the population grows. Based on the above

considerations, one of the most pressing issues to date is the efficient use of vacant areas of wheat, that is, the planting of secondary crops, which is also useful when sowing.

S.S. According to Makarova [pp. 3,26-27], the quality of sugar beet seeds in the black soil regions of Russia leads to an increase in yield by 50g60 ts / ha.

M.A. Belousov [1] According to the experience of Uzbekistan in the conditions of gray soils, the germination of sugar beet seeds is 98%, purity 94planting at a purity of 94% ensures that its root yield is 650 ts / ha.

D. According to Shpaar [4, p. 28], thickening of seedlings to obtain seed from sugar beet leads to rhizomania disease. As a result, seed germination decreases sharply.

Although sugar beet was first cultivated in Uzbekistan in the 1940s and 1950s, little research has been done (only Golodkovsky and Belousov). But he was not engaged in seed at all. The required amount of seed material was imported. It should be noted that because sugar beet is a biennial plant, in the first year the root crop is harvested, in the second year the root crop is planted and the seed crop is harvested.

In our experiment, V.A. Dospekhov [2] 's "Methodology of field opyta." based on the methodology, we defined the experimental system as follows (Table 1).

When growing mother tubers for seed, each variant has a width of 4.8 m, length - 50 m, total area - 240 m<sup>2</sup>. The experiment consisted of 4 repetitions of 10 options, with a total area of 960 m<sup>2</sup> for each option and a total area of 9660 m<sup>2</sup> for the experiment.

In the experiment, ammonium nitrate (34% N), urea (46% N), superphosphate (17-20% P<sub>2</sub>O<sub>5</sub>) and potassium chloride (51-60% K<sub>2</sub>O) are used as mineral fertilizers.

Experiments, phenological observations, soil and plant sampling were carried out in accordance with the manuals "Methodology polevqxopqtov" (Dospekhov, 1985), "Methodika Gosudarstvennogosortaispqtaniyaselskokhozyaystvennqxkultur" (1964) and "Methods of field experiments" (2007). Quantities of humus, general and mobile species of NPK in soil samples are carried out according to the methods "Methods of agrochemical, agrophysical and microbiological research in pollinated cotton fields" (1963) and "Methods of agrochemical analysis of soil and plants of Central Asia" (1977).

**TABLE 1 EXPERIMENTAL SYSTEM**

options	Sowing method	Sowing time	Method of winter storage of roots
1	Ordinary (sugar beet is planted as a mother root)		In winter, the mother tubers are stored in a warehouse
2	New method (seeds are sown to get maternal roots)	20.08	In winter, the mother root is stored in the field
3			In winter, the mother tubers are kept covered with soil in the field
4		30.08	Asinoption 2
5			Asinoption 3
6		10.09	Asinoption 2
7			Asinoption 3

8		20.09	Asinoption 2
9			Asinoption 3

In the experiment, we took into account the germination and thickness of seedlings of sugar beet seeds sown to obtain maternal roots. According to him, when studying the germination of seeds, the best performance was observed in 2-3 variants sown in the first period (20.08). In these variants, germination of beet seeds started on the 4th day after sowing, germination was completed within 4 days, and normal seedling thickness was achieved. When planted in the next period (30.08), germination was slightly different from the previous sowing period, according to which, although there was no difference in germination, germination duration lasted one day longer than the previous period. Germination at 10.09 days (third term) Germination started on the 5th day after sowing and full germination was achieved in 5 days. During the last sowing period, there were some difficulties in germination. A sharp drop in weather affected the germination time of the seed, which ensured the appearance of the first shoots in just 7 days, and the germination duration increased to 7 days. The resulting plants did not form a weak, flat.

In the experiment, we also studied the effect of planting times on the seedlings to achieve flatness in the options. At the same time, we found that the tumors survived after winter. We can also see this data from Table 2 below.

**TABLE 2 THE ACTUAL SEEDLING THICKNESS OF SUGAR BEET IN THE EXPERIMENTAL OPTIONS, AT THE EXPENSE OF A THOUSAND PIECES**

Bap.	Sowing method	Sowing time	How to store tubers for the winter	Pre-winter seedling thickness	Post-winter seedling thickness	Number of seedlings killed
2	New method (seeds are sown to get maternal roots)	20.08	In winter, the mother root is stored in the field	54	51.2	2.8
3			In winter, the mother tubers are kept covered with soil in the field	54	53.1	0.9
4		30.08	There are 2. suchas	54.5	50.1	4.4
5			There are 3. suchas	54.2	53.2	1.0
6		10.09	There are 2. suchas	53.8	49.2	4.6
7			There are 3. suchas	53.6	52.3	1.3
8		20.09	There are 2. suchas	52.3	46.8	5.5
9			There are 3. suchas	52.4	48.1	4.3

The early timing of planting ensures that the seedlings will be a flat, vigorous. This leads to a reduction in plant mortality during the winter. In our experiment, too, the thickness of the seedlings was determined before the onset of winter when the sugar beet root was grown for seed production the following year. According to him, it was observed that the thickness of seedlings formed in the early planting periods (20.08 and 30.08) was relatively high. It was found that from 54.0 thousand to 54.5 thousand units. When the remaining sowing periods were late (10.09 and 20.09), this figure was 52.4 and 53.8 thousand, respectively.

When we determine the actual seedling thickness in the field options after wintering in early spring, we observe that most seedlings die late, i.e., when planted at 20.09, and the tubers are left in the field in the normal way. At the same time, 5.5 thousand seedlings died when left in the normal way, and 4.3 thousand seedlings when covered with soil. The lowest seedling variant was planted in 20.08 and 30.08, and the topsoil-covered variant was obtained, with only 0.9 and 1.0 thousand seedlings killed, respectively.

In conclusion, it can be said that in the Fergana Valley, the mother tubers, which are prepared for seeding from sugar beets, should be sown in the twentieth and thirtieth days of August and buried in the soil to minimize exposure to cold. This leads to a relatively low frost tolerance of seedlings. This resulted in the death of an average of 0.9-1.0 thousand seedlings per hectare.

#### **LIST OF USED LITERATURE**

1. Belousov M.A. Agrotechnics of sugar beet in Uzbekistan Tashkent, GosizdatUzSSR, 1945.
2. Dospexov V.A. «Methods of field opyta» izd. 5-e dop. andpererob. M.Agropromizdat, 1985.
3. Makarova S.S. New retordant - stressprotectors for saccharine beets. J. Saxarnayasvekla, 1987 № 5, st.26-27.
4. Shpaar D. Rhizomania - opasnayabolezn, sposobnaya u nesti do 90% urojaya, j. Saxarnayasvekla, 1993 № 5. St. 28.
5. Komilova D.K. Scientific-educational electronic journal Education and science in the XXI century 2020 g.st 738-742

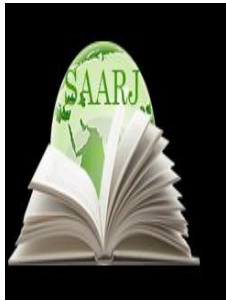

**ACADEMICIA**  
**An International  
 Multidisciplinary  
 Research Journal**  
 (Double Blind Refereed & Peer Reviewed Journal)

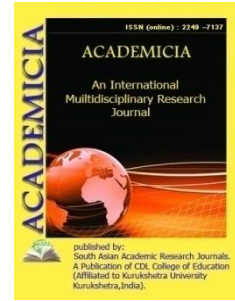

DOI: **10.5958/2249-7137.2021.01103.4**

**THE ROLE AND IMPORTANCE OF PROBLEMS IN THE THINKING OF  
 PRIMARY SCHOOL STUDENTS**

**Dilfuza Tashpulatova\***

\*Teacher,

Shakhrisabz branch of Tashkent State Pedagogical University named after Nizami,  
 UZBEKISTAN

**ABSTRACT**

*The article focuses on the role and importance of issues in primary school, their educational aspect, and their positive aspects related to other subjects. In the development of the student's creative ideas, the secular knowledge of the teacher of mathematics is also reflected. For example, he has to make a mock-up of a moving ship. Let's say that three ships sailing opposite the three ships on the river came to a standstill. Of course, this also depends on the skill of the math teacher. The teacher should not only refer to complex examples, but also use pictorial, interesting, philosophical, confusing issues. The mastery of a teacher depends on his knowledge of the world and his mastery of other sciences.*

**KEYWORDS:** *Historical Sources, Swimmer Learns, Philosophical, Arithmetic*

**INTRODUCTION**

Since the basis of the human point of view is first of all connected with ideas, he sees all his goals in a precise way. Estimates, measures, calculates. Hence, the "accountant" of our way of life are also mathematical elements. When a child with a pencil for the first time tries to express the word mother, he estimates the roundness of the surroundings, the shape of the house in which he lives with a mathematical expression.

This means that mathematics is one of the main subjects studied after the motherland. If we turn our attention to the first-grade mathematics textbook, first of all the big, small, large and small qualities in it, we will encounter problems with the participation of numbers in the second stage of the school year. A teenager who used to do things now starts to tie it to issues.

Well, why does the swimmer need issues? The question naturally arises as to how important they are in mathematics.

Our goal is to study the educational and scientific impact of both problems and logical problems on the student. Historical sources also state that the issue is to clarify this puzzle. For example, there were two sparrows on a tree branch. Two more birds flew by. We simply threw the question among the primary school swimmers to find out how many birds there were. This means that if a swimmer simply adds two numbers to two in the first step, that is, in the example, the second step is to try to solve the problem by adding the number of birds to the problem.

So the problem is not just the answer to the example, it solves the bird puzzle. It should be noted that the issues are related to other disciplines and provide additional knowledge to the swimmer. For example, with the science of nature, the swimmer begins to understand the family to which birds belong, not on land, but in the sky, not in the water. The above information gives him an additional source, knowledge. If we look at the problem in the third number on page 42 of the Grade 1 math textbook, we have a picture on the table with four apples on each side and two apples on the other side of the plate.

With this issue, the swimmer learns to speak as if it were a native language subject. That is why the first grade textbook is formed by the end of the school year with pictorial questions. This will help the child to fluent in speech, to communicate, to think deeply, to be responsive, and especially to speak, to increase vocabulary so that he or she can move on to the next grade.

The educational significance of the issues is also immeasurable. For example, Laziz asked his grandmother about the age of his youngest grandson. Her grandmother said, "My youngest grandson is as old as I am. "How old are you?" Laziz said, a little confused. Her grandmother said, "If you add my age with my grandson, it will be 65. How old is my granddaughter? Laziz's grandmother is now sixty and her granddaughter is five. So, this lesson taught young Laziz that the younger ones should respect the older ones and the older ones should respect the younger ones.

In this case, the role of a few chups increases not only the child's future home, but also his devotion to his family, homeland and community. For example, change the position of the Three Chups so that the house facing left is facing left. By changing the position of the child chups, he develops the qualities of proper and quality home-building and increases his responsibility to the family. With these issues, he begins to realize from a young age that the belt of the family budget depends on it in the future, that it must be managed by accurate calculations and actions.

Another important aspect of the issues is that it helps the child to develop new innovative ideas. Adding a "soul" to a piece of paper is also a way of putting it into action. For example, he has to make a mock-up of a moving ship. Let's say that three ships sailing opposite the three ships on the river came to a standstill. The river was so narrow that it could not hold two ships side by side, but there was a bay that could hold one ship. How can these ships continue their voyages?

It is in this process that the prospective explorer approaches the essence of the problem, using intersections. He invents methods that allow not only ships, but also new bays and oceans to multiply. Or new ships moving in such short corridors are discovered.

It should be noted that a brother, a sister, two sons and two nephews went fishing. His brother said, "I taught you to fish, and he caught 18 fish. The swimmer, who understands the total number of points when he catches twice as many points as the others, also notices that the unity

of the swimming force, the combined break, and every action taken from one side gives good results.

In the same way, when the number of fathers, mothers, brothers, and sisters in the family is "calculated", the infidelity in the family begins to be understood at this age. Issues involving animals, plants, and beasts teach us to love and respect nature, while issues involving roads, cities, and countries develop his diplomatic views.

In addition, the issues at stake are also important. The difference between them and a simple problem is that we both enjoy and enjoy the process of solving it and finding the answer. Puzzles teach the child to be alert and resourceful, to develop the ability to concentrate, to think broadly, to compare a large number of facts with each other and to distinguish between what is needed.

In conclusion, the importance of mathematics in primary school is great. The issues help the student to understand both secular and philosophical views as a teenager, to digest these sciences. Of course, this also depends on the skill of the math teacher. The teacher should not only refer to complex examples, but also use pictorial, interesting, philosophical, confusing issues. The mastery of a teacher depends on his knowledge of the world and his mastery of other sciences. If you know arithmetic, if you don't know other subjects, your lesson will be boring, and your swimmer's mastery will be poor.

#### **LIST OF USED LITERATURE**

1. "A thousand and one puzzles." F.Baxromov, S.Burxonov, U. Khudoyorov. Future-books publishing house 2020.
2. Mathematics textbook for 1st grade of general secondary schools. "Turon-Iqbol" Tashkent 2019
3. Improved "Bolajon" base program. T. : 2016.
4. Ishmukhamedov R.J., Yuldashev M. Innovative pedagogical technologies in education and upbringing. T. : "Nihol" publishing house, 2013, 2016.
5. Tolipov O., Usmonboeva M. Applied bases of pedagogical technologies T. : 2006.
6. Ishmuhamedov R. Methods of using interactive methods and pedagogical technologies in the learning process. T. : RBIMM, 2008.
7. Ishmuhamedov R., Abduqodirov A., Pardaev A. Innovative technologies in education (practical recommendations for teachers of educational institutions). - T. : Iste'dod, 2008.

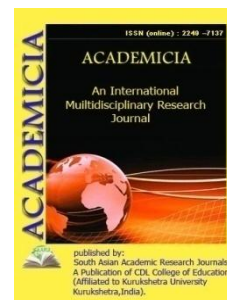
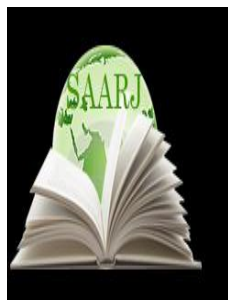

DOI: **10.5958/2249-7137.2021.01104.6**

## EDUCATION IN PRESCHOOL EDUCATIONAL ORGANIZATIONS - THE IMPORTANCE OF USING THE MARIA MONTESSOR METHOD IN THE PROCESS OF EDUCATION

**Boboqulova Nazokat Yusufvna\***

Faculty of Preschool Education Lecturer,  
Department of Preschool Education Methods,  
Termez State University, UZBEKISTAN

### ABSTRACT

*Modern educational space is "impregnated" with ideas of humanization and personality-oriented concept. In this regard, it becomes necessary to study and understand the potential of those pedagogical systems and techniques of a personal orientation that have taken their solid place in the educational space, having proved their importance, efficiency and productivity. One of the most striking representatives of ideas with a humanistic focus is the Italian teacher, psychologist, founder of the method of scientific pedagogy M. Montessori. The article discusses the positive and negative aspects of the developing method of M. Montessori.*

**KEYWORDS:** *Montessori, Pedagogy, Primary School, Psychology.*

### INTRODUCTION

Civilized society has great experience in the field of education. It tries to organize the child to develop as comfortable as possible and to obtain the necessary knowledge, skills and skills for professional formation in society. Education is an important area of society, as education depends on the development of the whole country and even the world. For this reason the modern pedagogics reinterprets problems of training, education and personal development of the person, analyzing changes in a new sociocultural situation and considering new requirements to formation of the personality. Modern education is increasingly seeking humanization and anthropization, which proves the relevance of M. Montessori 's ideas in the modern pedagogical process, because it is in Maria Montessori 's ideas that «freedom» «self-development» and «creation »are key words.

Unfortunately, many parents who have sent their children to Montessori schools or special groups are not well acquainted with the Montessori methodology. A lack of awareness has given



rise to many myths about this learning system. We will analyze the shortcomings of the Western system introduced in Russia and consider the most popular myths.

One of the most popular misconceptions regarding Montessori's pedagogy is the opinion that this is a "silent" technique. Maria Montessori herself wrote for teachers working with children: "Keep an account of your words." She did not mean that the teacher should completely limit himself in contact with the pupil, but that he should not interfere with him and be imposed. Do not do what the child can do by himself. Experience with children shows that comments at the time of the implementation of the activity prevent the child from concentrating. The teacher comes to the rescue when the student asks him about it. Irina Isaeva, chairman of the Interregional Montessori Association, says, "Montessori is suitable for all children." It is impossible not to support disagreement in this, because, based on their own life observations, there are children with inborn shyness and inactivity in communication, and such a child may just be shy to ask for help from the teacher, hence the development of isolation is quite possible. It seems to me that such children will be better suited to the teaching methodology in which the teacher will be the first to take the initiative in contacting the child.

Another common myth about M. Montessori's pedagogical system: it is difficult for children who have completed pre-school education on this system to adapt in an ordinary traditional school and obey its rules. According to the ideas of humanistic pedagogy, freedom is not permissiveness, but the right of independent choice. Montessori schools also have rules that pupils willingly obey, because they are taught that rules help, not interfere. Many educational institutions that have received natives of Montessori schools characterize such children as disciplined, eager to make contact with adults and peers, independent and consciously accepting the rules of the educational institution.

### **Method**

The following misconception relates to the pedagogical process of the Montessori system: there are no games in it, although the game is one of the main activities of preschoolers. Maria Montessori did not deny the game, she only attributed them not to the main activity, but to rest. In the main time, children should learn the real world around them. "The child is exiled to the world of toys, removed from the affairs that he needs for internal development," said the humanist educator. Where it is better to give the child real dishes, instead of plastic toys, so he will have the opportunity to satisfy his needs and to know the real world around him. Many are also mistaken in saying that it is impossible to work in a group with children of different ages. And this is how not only the kindergarten is arranged, but also the M. Montessori school. It is difficult to agree with this, because a group of different ages reminds me of a large family in which younger children are taught respect for elders, and older ones help and support babies, set an example for them and motivate them to learn. Such an experience will certainly be useful for children in adapting to a new team in the future.

Having delved into the theoretical and methodological foundations of Montessori pedagogy, as well as having studied the practical experience of other Montessori teachers, we can highlight, in addition to the pluses, some negative aspects of such a training system. Since the M. Montessori system has begun to gain popularity recently, training in such centers is quite expensive and is even considered elite. For example, tuition at a Montessori school in Moscow ranges from 20 to 200 thousand rubles, which not every parent can afford. The downside of this pedagogy is that

there is no place for fairy tales in it. Maria Montessori wrote that fairy tales immerse the child in a non-existent world, while he must know the real one. She believed that it was better to tell real things to children: for example, how life processes occur on Earth, why the sun shines, etc., instead of telling fictional stories. One cannot disagree with the fact that fairy tales primarily develop fantasy and imagination in children, and also many fairy tales contain a huge amount of instructive information, therefore fairy tales are necessary for children. Another disadvantage of the Montessori system is that the teachers who teach children in this program lose their authority in some way. This applies specifically to Russia, because traditionally here teachers are looked upon as leaders who indicate what to do, and not as observers and assistants.

From January 1, 2014, textbooks and teaching aids according to the new Federal State General Educational Standard were received in secondary schools. The new standard introduces more and more humanistic ideas. Many teachers who do not have competence in the pedagogical system of M. Montessori do not know how to implement the program by all the usual methods and help the child in the formation of personality. Without Montessori's pedagogy, this is difficult to achieve, and the formation of a Montessori teacher is a rather lengthy process. In addition, the current examination system is completely contrary to the ideas of humanistic education. Standardized test exams significantly affect the psyche of children and the quality of education in general. Many criticize the Unified State Exam and do not consider it an indicator of graduate knowledge. Preparing for such an exam forms children's skills in automatically completing test tasks, and this has nothing to do with knowledge.

## Results

What are the ideas behind Montessori childcare? There are two main ideas: First, children create their own sense of 'self' through interaction with their environment. Rather than sitting at a desk and being lectured, children are encouraged to *do* things. Play with a selection of toys, explore a selection of areas; try out new things and see what works for them on an individual level.

Second, that children have their own innate path towards healthy psychological development. It is only by following this highly personal path to psychological development that they can reach a healthy end point, and not everyone's path is the same.

However, Maria Montessori and her son, Mario, did identify a series of universal characteristics which they went on to call 'human tendencies'. They are as follows:

- Abstraction
- Activity
- Communication
- Exactness
- Exploration
- Manipulation of Environment
- Order
- Orientation
- Repetition

- Self-Perfection
- Workor ‘purposeful activity’

The philosophy instructs that education should be built up around these principles in order to best facilitate a healthy psychological development – ideally with the intention of developing independence in all of the listed areas.

As they are ‘universal’ tendencies, it can be reasonably assumed that education systems established with a healthy respect for these characteristics will find it easier to establish a base or foundation, from which they can build their more individualistic ‘ad hoc’ instructions.

What is the Montessori approach to early childhood education?

There is a strict emphasis on learning through interaction with environment, in this philosophy.

It encourages what it terms ‘free activity’ within an established ‘prepared environment’. What this activity may be, and even what kind of an environment is required, is up to the individual teacher – and in part, should be inspired by the individual needs of the student.

The philosophy does provide some guidance as to what these environments should look like, and recommends that teachers hit a few key notes:

- An arrangement that facilitates movement and activity
- Beauty and harmony, cleanliness of environment
- Construction in proportion to the child and her/his needs
- Limitation of materials, so that only material that supports the child's development is included
- Order
- Nature in the classroom and outside of the classroom

The Montessori pedagogical system is good and has many advantages, but do not forget about the cons. We can conclude that the Montessori methodology training should be better defined for additional education and combined with the usual traditional in order to compensate for these same disadvantages. In general, the effectiveness of Montessori pedagogy has been proven more than once and should, at least partially, be used in traditional pedagogical practice, because, in my opinion, the idea of free, but controlled education is in line with modern society.

What about Montessori homeschooling? Montessori philosophy is easily transferred into the home. As a consequence of the advocated ‘freedom’ in regards to lessons and activities, a classroom is not required.

Each of the lessons proscribed by a Montessori approach can be replicated within the home, but the child will struggle to develop upon the social aspects of the philosophy while lacking contemporaries. This may prove to be an issue once the student develops into the Elementary stages of schooling.

What would a Montessori Elementary experience look like? These classes serve students between the ages of six and nine years old, but it’s not uncommon to see classes with an age bracket of six to twelve.

There is still a strong emphasis on independent choice, and following their own interests within the class. At this stage of development, a student can expect to be introduced to topics like history and biology – and be encouraged to further explore whichever one is most appealing to them. These are referred to within the philosophy as ‘Great Lessons’.

They will be introduced at the beginning of the school term, and the student will dive deeper into the subject as the term progresses.

What does a Middle School look like when done in a Montessori style? The education at this level is less well-developed than in earlier stages.

With more emphasis on earlier childcare, the philosophy is somewhat vague when extended to older students.

Maria Montessori did not develop a program for adolescents in her lifetime, but a number of schools have tried to extend the teachings to teens.

The common consensus between these schools is that the philosophy works best when applied in rural areas, suggesting that it may be better for students to leave busier towns and cities in order to study in the countryside.

What is a Maria Montessori education centre?

A Maria Montessori education centre is simply a school which teaches in accordance with the Montessori philosophy. There are many such facilities all across the world.

These should not be confused with THE Maria Montessori Education Centre, the foremost centre for Montessori teaching. Located in Canada, it’s essentially ‘the main one’ in terms of Montessori schools.

What does Montessori teacher training entail?

The training can be received in three different formats:

A Diploma course is available for those looking to become proficient in all age groups, and can be taken in one or two-year courses. This is the only option for those looking to become a fully-fledged Montessori-style teacher.

A Certificate course is a shorter, part time evening course which takes place during the spring term. It specialises in producing assistants, but is insufficient training for those looking to lead the classroom as a teacher.

A Lecture series is provided for those who simply wish to learn more about the approach without taking a formal course of study. This is not a qualification and will not constitute ‘teacher training’.

So how can this be applied in my classroom? Even without taking the time to become a fully qualified Montessori teacher, it might be worth taking to heart her thoughts on free choice and physical interaction.

It’s obviously of greater use to those of you teaching English to younger children, and if you take large classes then you’re going to struggle to apply the theory to each child individually, as the philosophy instructs.

If you're teaching English to students over the age of eighteen then you're going to struggle to find any use for this philosophy. As indicated above, the research into Montessori education for older students is almost non-existent. The philosophy is about developing them into a more rounded person – if your student is twenty five years old then they're probably already pretty developed...

But those of you teaching to students between the ages of six and fifteen, which I suspect is most of you, then you may find something worth taking away from all of this.

### **CONCLUSION**

The Montessori pedagogical system is good and has many advantages, but do not forget about the cons. We can conclude that the Montessori methodology training should be better defined for additional education and combined with the usual traditional in order to compensate for these same disadvantages. In general, the effectiveness of Montessori pedagogy has been proven more than once and should, at least partially, be used in traditional pedagogical practice, because, in my opinion, the idea of free, but controlled education is in line with modern society.

### **REFERENCES**

1. Belgorod National Research University / Center for Education M. Montessori [electronic resource] 2016.
2. Vozrozhdeniemontessori-pedagogiki v sovremennojRossii. [electronic resource]2012.
3. Kritika M.Montessori. [electronic resource] 2014.
4. M. Montessori v Rossii. [electronic resource] 2014.
5. O principahmoejshkoly. M. Montessori. Per. s angl. V.3latopol'skogo // Uchitel'skayagazeta. 1992.
6. PedagogicheskayasistemaMarii Montessori. /Uchebnoeposobie. Borodaeva L.G. M.MCM. 1998.



**ACADEMICIA**  
**An International  
 Multidisciplinary  
 Research Journal**  
 (Double Blind Refereed & Peer Reviewed Journal)

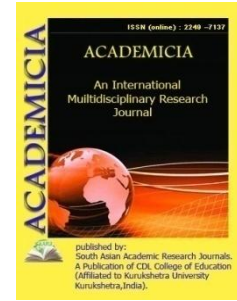

**DOI: 10.5958/2249-7137.2021.01105.8**

**SELECTION OF LARGE SEED AND HIGH YIELDING LINES OF  
 BREAD WHEAT FOR DROUGHT CONDITIONS**

**Dilmurodov Sherzod Dilmurodovich\*; Shodiyev Sherzod Shomiljonovich\*;  
 Abdumajidov Jaloliddin Raxmatullaevich\*; Hayitov Azizbek Sherkulovich\*\*;  
 Mavlanov Javokhir Sarvar ogli\*\*\***

\*Senior Scientific Researcher,  
 Doctor of Philosophy (PhD) in Agricultural Science,  
 Kashkadarya branch of the Research Institute for Grain and Leguminous crops,  
 UZBEKISTAN  
 Email id: s.dilmurodov@mail.ru

\*Junior Scientific Researcher,  
 Kashkadarya branch of the Research Institute for Grain and Leguminous crops,  
 UZBEKISTAN

\*Junior Scientific Researcher,  
 Kashkadarya branch of the Research Institute for Grain and Leguminous crops,  
 UZBEKISTAN

\*\*Master's Student,  
 Department of General Technical Sciences,  
 Karshi branch of the Tashkent Institute of Irrigation and,  
 Agricultural Mechanization Engineers,  
 Karshi city, Kashkadarya Region, UZBEKISTAN

\*\*\*Junior Scientific Researchers,  
 Gallaaral Research and Experimental Station of the Research Institute of Grain and,  
 Legume crops. Gallaaral District, Jizzakh Region,  
 UZBEKISTAN

**ABSTRACT**

*One of the most important tasks in the creation of new varieties is the study of various features of world collection lines of bread wheat suitable for the soil and climatic conditions of the republic, the selection of high-yielding, disease and pest-resistant lines and their involvement in selection work. With the help of ICARDA, 165 varieties and lines were planted and studied in the Optional*

---

*and Winter Wheat Observatory (25th - FAWWON - IR) from the International Winter Wheat Improvement Program (IWWIP - CIMMYT Turkey). As a result of studying the valuable properties of bread wheat varieties and lines, 10 lines superior to standard varieties were selected and transferred to the next stage of selection.*

**KEYWORDS:** *Bread Wheat, Variety, Line, Breeding, Vegetation Period, 1000 Kernel Weight.*

---

## INTRODUCTION

In 2019, world wheat production was 762.2 million tons, an increase of 3.9% over the 2018 season. Wheat production in the world reached its highest level in 2017 - 773 million tons [1, 2, 5].

Looking at last year's list of the most advanced wheat-growing countries, China (134 million tons), India (102 million tons) and Russia (75 million tons) are among the top three countries with the highest wheat production in 2019. together it accounts for 41 percent of world production. These countries are followed by the United States, France, Canada, Ukraine, Pakistan, Australia, Turkey, Germany and Argentina, which together account for 34% of world production [11, 22].

When creating the best varieties of bread wheat on irrigated lands, the early maturing properties of the variety, the composition of the grain and its quality indicators, the external environment and agronomic measures have a strong influence [3, 6, 7].

Wheat can be exposed to heat at any stage of the growing cycle. The average air temperature for the growth and development of wheat is 18 - 25 °C, and when it exceeds 32 °C it begins to have a negative effect. An increase in air temperature above 32 °C has a strong effect on the reproductive organs, having a major negative effect on the process of grain filling in the middle and late stages of developmental phases [4, 10, 12].

There are important rules on the selection donor varieties. In the practice of synthetic breeding for the creation breeding material first of all parenting pairs are selected by hybridization. The success of hybridization depends on how properly the parent pairs are selected [8, 9, 13].

In turn, high-yield selection leads to a decrease in resistance to adverse external factors i.e. abiotic and biotic influences, so a comprehensive approach to the creation of competitive varieties is required. One of the decisive factors in achieving an increase in productivity and resistance to adverse conditions in selection is the correct planning of the selection process, i.e. the choice of research direction and methods. This task can be performed only with a complete understanding of the exact state of productivity in the conditions of the area where the selection work is carried out [14, 18, 20].

The productivity of wheat grain is studied in relation to the elements of yield. The analysis of yield elements allows breeders to take a conscious approach to the synthetic selection of varieties. Selection is a final and relatively responsible component in obtaining valuable forms in the selection process. Therefore, it is especially important for the breeder to know the relationship between the characteristics of the selection work, as well as the characteristics of the plant. When the selection work is carried out using correlation, it creates the basis for a relatively efficient work [15, 17].

In the process to create new varieties with high yield, the crossing is carried out to take an attention of productivity features of plants. For example, for the wheat they are the quantity of productive plants, a grain size, a weight of 1000 grains, a yield of variety and etc [16, 19].

The weight of 1000 grains is an indicator of the size and fullness of the grain. This is a sign of diversity, and at the same time emphasizes that the climate during the period of strong saturation depends on the conditions. It has been scientifically determined that the size of a grain of wheat depends on the duration of the growth period, in particular, on the elongation period of maturing [21, 26].

The amount of protein in wheat grain is one of the main elements of quality indicators and is closely related not only to its nutritional value, but also to its technological quality [24, 25, 36].

Today, 15-20 percent of the wheat grown in the world meets the demand for strong wheat, while the quality of grain is 50-55 percent of weak wheat. This weak wheat can give quality bread only if 20-40 percent strong wheat is added to it [23, 27].

Wheat yield depends on plant structure, metabolism, and substances in the grain. Every physiological phenomenon can change under the influence of genotype and environment, and there is an inextricable link between genotype and environment [28, 30, 34].

The variability and heredity of quantitative traits are not uniformly covered in the literature. A characteristic feature of this is that it depends on the external environmental conditions, which poses a great difficulty in selection. The most important thing in selection is a specific genotype or homo- and heterozygous and other indicators of productivity is what genetic potential it has [27, 29].

These two factors depend on the selection of the best genotypes from hybrid mixtures in hybridization. Dilmurodov et al. stressed the need for a comprehensive study of complex primary forms in order to properly apply genetic theory in the selection process [31, 33, 38].

The duration of vegetation stages are used for the selection of pairs and creation varieties with early maturity. Moreover, for this, in the crossing process a vegetation stage of a pair should be shorter, on the second pair not exactly this vegetation period, but another one should be short. Only then, it could be for the purpose of what was focused [32, 35, 37].

## **MATERIALS AND METHODS**

On the nursery of the selection of primary source and donors for the breeding 165 varieties and lines were selected and researched which belonged to different ecological and geographical regions. The varieties and lines were placed on 1 m<sup>2</sup> with 1 replications. In research a placement scheme of the field experiment was based on the “Alpha lattice design” of the program Genestat 3. A placement of the experiment and during the research a phenological observation, a calculation and analysis were based on the method of Union Institute of Plant Breeding (UIP,1984), and biometric analysis were based on the methods of the Commission of the State variety testing of agricultural crops (1985, 1989). Mathematical and statistical analysis of the experiment were committed according to the developed guide by B.A. Dospekhov (the Method of field experiment, 1985).



## RESULTS AND DISCUSSION

Experiments of winter cereal crops the seeds were sown on October 22 in 2017-2018 seasons. Of these studied varieties and lines, 18 varieties and lines were selected mainly according to drought, early maturing, yield and 1000 grain weight and other valuable economic characteristics. During phenological observations of varieties and lines, the sown seeds germinated on November 5-6 after irrigation, and in the experiment it was noted that the varieties and lines entered the harvesting phase on December 5-8.

While the tubing phase of the varieties and lines was observed from 28 February to 5 March, it was found that early on BEZOSTAYA, BiII98 varieties and lines were 2 and that these lines entered the tubing phase on 28 February. Varieties and lines such as KACHU / SOLALA, OGOSTA / SE 7/7 / 91-142 ..., PASTOR / MILAN / 7 / Z .., ESPADA / KARAHAN, PRL / 2 \* PASTOR // PB ... body and entered the tube phase on March 1-5.

When analyzing the days from germination to germination, it became clear that the germination period of the studied varieties and lines was 155-177 days. In the Gozgon variety, which was taken as a standard variety, this period was 163 days, while in 89 varieties and lines, the germination period was shorter.

It was noted that out of 18 selected varieties and lines, 9 varieties and lines entered the mating phase in 155-158 days, 8 varieties and lines in 158-169 days, and the remaining 2 varieties and lines in 170-176 days.

In the experiment, the transition of varieties and lines to the full maturing phase took place from 25 May to 6 June. It was observed that the variety Gozgan entered the full maturing phase on June 2, and the number of varieties and lines that entered the maturing phase in a shorter period of time than the standard was 125. It was noted that 29 of the studied varieties and lines entered the full maturing phase on 25 May and were identified as early maturing lines.

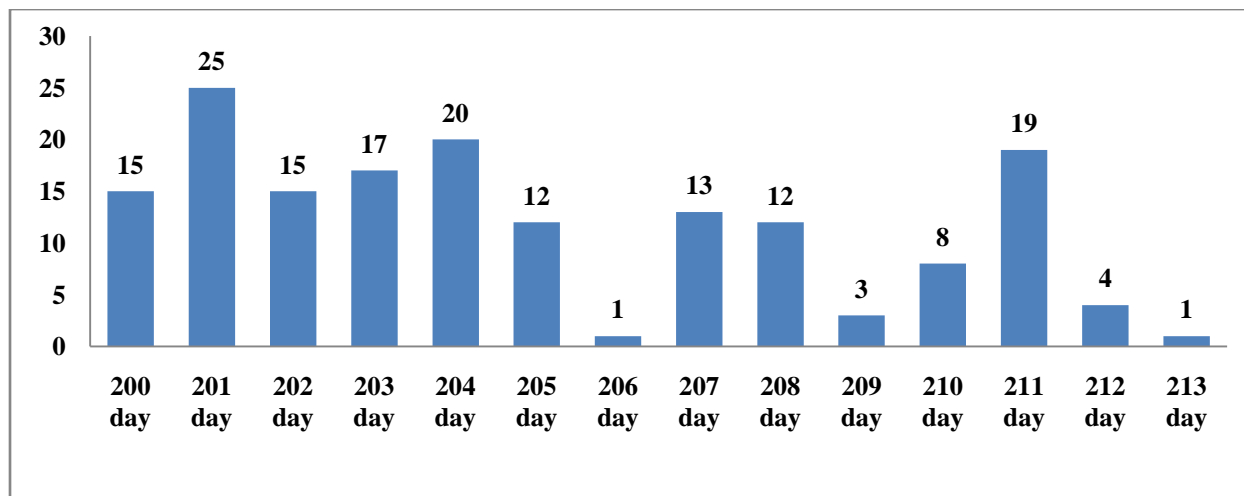

**Figure 1. Number of varieties and lines according to the period of growth, day (Karshi, 2017-2018).**

The growing period of the studied varieties and lines was 200-213 days at the time of determination. The Gozgon variety, taken as a local check, was found to have entered the full maturing phase in 207 days.

**TABLE 1 VARIETIES AND LINES SELECTED ACCORDING TO THE CHARACTERISTICS OF EARLY MATURING (KARSHI, 2017-2018).**

Plots	Name	Germination date	Tillering date	Shooting date	Heading date	Days to heading date	Maturity date	Days to maturity date
14	ND643//2*PRL/2*PASTOR/6/C HEN/AE.SUARROSA (TAUS)//BCN/4/RAN/NE701136 //CI13449/CTK/3/CUPE/5/130L1 .11/GUN91//KINACI97	05.но я	05.де к	28.фе в	11.ап р	157	25.май	201
15	DANPHE #1/6/CA8055/4/ROMTAST/BON /3/DIBO//SU92/CI13645/5/AGRI /BJY//VEES	06.но я	08.де к	27.фе в	11.ап р	156	25.май	200
16	WHEAR//INQALAB 91*2/TUKURU/3/PYN/BAU//AT TILA	06.но я	06.де к	01.ма р	11.ап р	156	25.май	200
35	DESCONSE../3/494J6.11//TRAP #1/BOW/5/ALAMOOT/3/ALVD/ /ALDAN"S"/IAS58/4/ALAMOO T/GASPARD	06.но я	06.де к	03.ма р	12.ап р	157	25.май	200
43	AGRI/NAC//ATTILA/6/TAST/S PRW//ZAR/5/YUANDONG 3/4/PPB8- 68/CHRC/3/PYN//TAM101/AMI GO/7/494J6.11//TRAP#1/BOW	05.но я	08.де к	01.ма р	13.ап р	159	25.май	201
44	BILINMIYEN96.27//ZNAKHID KA/5/HK48/MNCH/4/BLL//F72. 23/TLL/3/MNCH	05.но я	07.де к	04.ма р	12.ап р	158	25.май	201
61	ESPADA/KARAHAN	06.но я	08.де к	27.фе в	12.ап р	157	25.май	200
62	ESPADA/KARAHAN	05.но я	07.де к	01.ма р	12.ап р	158	25.май	201
63	WHEAR//INQALAB 91*2/TUKURU/3/PYN/BAU//AT TILA	05.но я	05.де к	02.ма р	27.ап р	173	25.май	201
84	OGOSTA/SE.../7/91-142 A 61/3/F35.70/MO73//1D13.1/MLT /6/PI/MZ//CNO67/3/LFN/4/ANT/ 5/ATTILA/8/ZARGANA-3	06.но я	08.де к	02.ма р	12.ап р	157	25.май	200

85	PFAU/MILAN/3/SKAUZ/KS94U 215//SKAUZ/4/OVL*3/AMAD/5 /BILLINGS	05.но я	06.де к	28.фе в	12.ап р	158	25.май	201
87	PRL/2*PASTOR//OVL/5/T67/JG R 'S//K92/3/SNF/4/JGR 'S//JGR 'S/HBC059E	05.но я	07.де к	27.фе в	12.ап р	158	25.май	201
91	PVN//CAR422/ANA/5/BOW/CR OW//BUC/PVN/3/YR/4/TRAP#1 /6/WELS- 2/7/AP01T2421/BCG99-156	06.но я	06.де к	03.ма р	13.ап р	158	25.май	200
116	KS010525-1-3/KS020363WM~1	06.но я	07.де к	02.ма р	12.ап р	157	25.май	200
117	EVEREST/KS050176^1	05.но я	08.де к	03.ма р	12.ап р	158	25.май	201
123	SARVAR	06.но я	06.де к	27.фе в	10.ап р	155	25.май	200
124	ISFARA	05.но я	07.де к	01.ма р	10.ап р	156	25.май	201
125	CMH80A.768/3*CNO79//AZADI /3/2*ZRN	06.но я	08.де к	03.ма р	10.ап р	155	25.май	200
126	ALD/SNB//ZRN*2/3/YACO/PA RUS//PARUS	05.но я	05.де к	28.фе в	10.ап р	156	25.май	201
156	CROC_1/AE.SQUARROSA (210)//PBW343*2/KUKUNA/3/P BW343*2/KUKUNA	05.но я	07.де к	27.фе в	10.ап р	156	25.май	201
157	T.DICOCCON CI9309/AE.SQUARROSA (409)//MUTUS/3/2*MUTUS	06.но я	05.де к	02.ма р	11.ап р	156	25.май	200
158	DANPHE #1*2/SOLALA	05.но я	07.де к	26.фе в	10.ап р	156	25.май	201
159	REEDLING#1	05.но я	08.де к	01.ма р	10.ап р	156	25.май	201
162	KVZ/PPR47.89C//TACUPETO F2001*2/BRAMBLING/3/2*TA CUPETO F2001*2/BRAMBLING	06.но я	05.де к	05.ма р	10.ап р	155	25.май	200
163	T.DICOCCON CI9309/AE.SQUARROSA (409)//MUTUS/3/2*MUTUS	06.но я	08.де к	01.ма р	11.ап р	156	25.май	200
164	PRL/2*PASTOR//PBW343*2/K UKUNA/3/ROLF07/4/CMH75A. 66/SERI	05.но я	06.де к	02.ма р	10.ап р	156	25.май	201
165	KACHU/SOLALA	06.но я	05.де к	02.ма р	10.ап р	155	25.май	200

It was noted that the plant height of the studied varieties and lines ranged from 59 to 115 cm before analysis. In the selection of the variety and lines, attention was paid to the selection of lines resistant to medium-sized deposition. When the relationship between plant height and yield was studied, it was found that there was a positive correlation between  $r = 0.33$  and  $r = 0.21$  per 1000 grain weight.

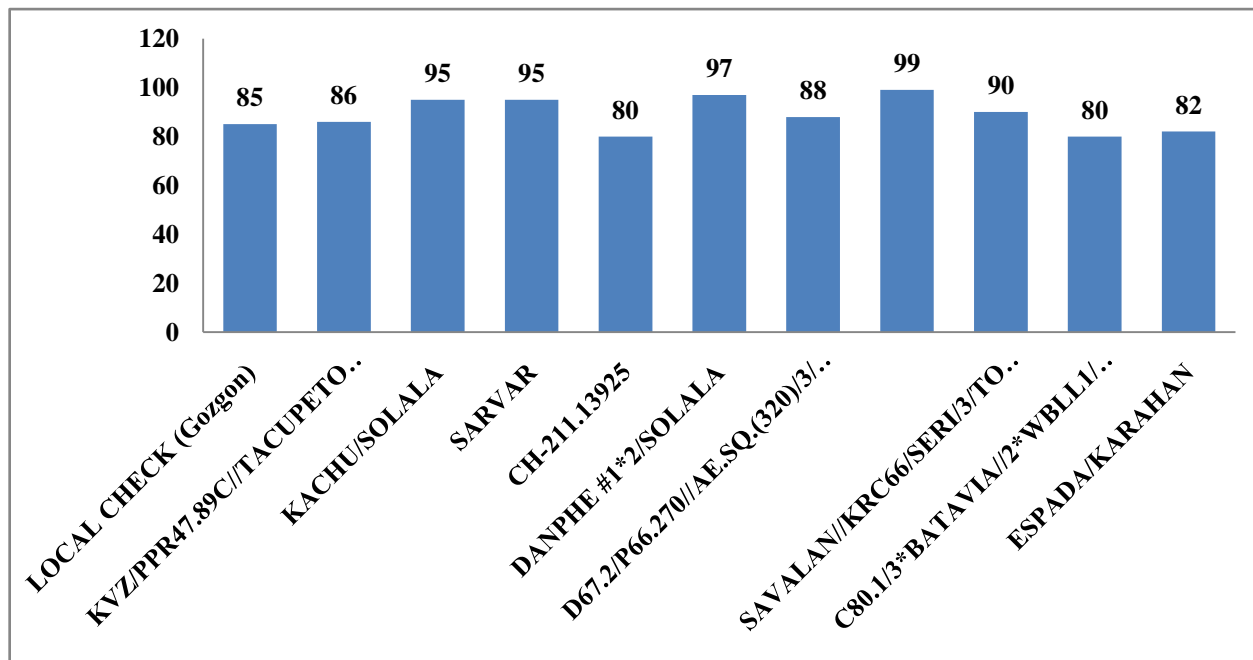

**Figure 2. Selected varieties and lines plant height indicator, cm (Karshi, 2017-2018).**

In the experiment, the final joint length of the cultivar and lines was also determined. The main purpose of this is that the length of peduncle in years of drought indicates drought tolerance. It was noted that the length of peduncle in varieties and lines was 25 - 54 cm. In the Gozgan variety, planted as a standard variety, the length of peduncle was 35 cm, while in 68 varieties and lines, this figure was found to be higher than the standard variety. The number of lines with a final peduncle length of 40 cm and a height of 33 cm was 33.

Spike length has a positive effect on the yield of varieties and lines. In the experiment, it was noted that the spike length index ranged from 7 to 13 cm. In the Anzoda variety, this figure was 12 cm. The number of varieties and lines with spike lengths of 10 cm and above was 82.

It was noted that the number of spikes in the spike ranged from 10 to 22. The number of spikes in the standard Gozgan variety was 20. It was found that there were 5 lines with a higher number of spikes than the standard variety.

**TABLE 2 PRODUCTIVITY INDICATORS OF SELECTED LINES (KARSHI, 2017-2018).**

Plots	Name	Grain yield, c/ha	1000 kernel weight, g	DF days to heading date	Days to maturity date	Plant height, cm	Peduncle length, cm	Spike length, cm
1	BEZOSTAYA	44	40.5	17 1	21 1	70	30	11
2	SERI	34	38.2	16 7	21 1	76	32	10
3	SULTAN95	14	29	17 7	20 2	70	30	11
4	KATIA1	30	35	15 7	20 3	76	32	10
5	KONYA	32	36.8	16 1	21 0	85	30	9
6	Gozgon (check)	51	39.4	16 1	21 0	85	35	10
16 2	KVZ/PPR47.89C//TACUPETO F2001*2/BRAMBLING/3/2*TACUPETO F2001*2/BRAMBLING	54	49	15 5	20 0	86	33	11
16 5	KACHU/SOLALA	34	48. 8	15 5	20 0	95	40	9
12 3	SARVAR	69	48. 2	15 5	20 0	95	42	12
15 5	CH-211.13925	44	47. 8	17 4	21 1	80	30	10
15 8	DANPHE #1*2/SOLALA	46	46. 2	15 6	20 1	97	40	10
10 0	D67.2/P66.270//AE.SQ.(320)/3/CUNNINGHAM/4/ U1254-4-4-7-2/DONG XIE4/3/VORONA//PRL/VEE#6 (OCW00M604S- 1)/5/TX91D6991/B1551	54	45	17 0	20 2	88	35	9
89	FRET 2*2/4/SNI/TRAP #1/3/KAUZ*2/TRAP//KAUZ/4/OK91P648/OK94P 597 (OK03520)/5/ENDURANCE	58	42. 8	16 2	20 4	99	35	10
57	SAVALAN//KRC66/SERI/3/TORIK/4/2*F10S- 1//STOZHER/KARL	58	41. 6	15 9	20 3	90	36	10
72	C80.1/3*BATAVIA//2*WBL1/3/2*KRONSTAD F2004/4/BONITO//KAREE/TUGELA	48	41	15 6	20 2	80	40	10
61	ESPADA/KARAHAN	50	40. 8	15 7	20 0	82	32	8

It was noted that the weight value per 1000 grains of the studied varieties and lines ranged from 23.8 to 49 g. While the sample Gozgon variety had a grain weight of 39.4 g per 1000 grains, this figure was found to be higher in 33 varieties and lines. The number of varieties and lines weighing 40 g and above per 1000 grains was 30.

When the correlation of 1000 grain weights with the yield index was studied, it was found that  $r = 0.25$  had a positive correlation.

The yield of varieties and lines was determined to be 14 - 90 c / ha. While the standard Gozgon variety showed a yield of 51 c / ha, 47 varieties and lines were found to be superior to the standard.

Based on the results of the study of all the valuable properties of the studied lines, 8 lines were selected for testing in the selection nursery next year.

## CONCLUSION

In the observatory collection nursery of optional and winter wheat, 8 lines with all valuable properties were selected and transferred to the breeding nursery.

## REFERENCES

1. Juraev D. T. et al. To study the heat resistance features of bread wheat varieties and species for the southern regions of the republic of Uzbekistan //European Journal of Molecular & Clinical Medicine. – 2020. – Т. 7. – №. 2. – С. 2254-2270.
2. Дилмуродов Ш. Д. Подбор исходного материала для селекции пшеницы озимой мягкой для условий Узбекистана на основе изучения хозяйственно ценных характеристик //Аграрная наука. – 2018. – №. 2. – С. 58-61.
3. Хазраткулова Ш. У., Дилмуродов Ш. Д. Взаимосвязь погодно-климатических условий с продуктивностью и качеством зерна сортов озимой пшеницы //Фундаментальные основы инновационного развития науки и образования. – 2019. – С. 59-61.
4. Мейлиев Т. Х., Дилмуродов Ш. Д. Рост и развитие, урожайность и устойчивость к желтой ржавчине сортов в питомнике отбора продуктивных сортов //Приоритетные направления развития науки и образования. – 2019. – С. 130-133.
5. Juraev D. T. et al. Influence of hot dry winds on productivity elements of wheat crop observed in southern regions of the republic of uzbekistan //International jurnal of applied and pure science and agriculture. ISSN. – 2017. – С. 2394-5532.
6. Sh K. N. et al. Selection of early bread wheat lines based on studying the time of development //INTERNATIONAL SCIENTIFIC AND TECHNICAL JOURNAL “INNOVATION TECHNICAL AND TECHNOLOGY”. – 2020. – Т. 1. – №. 2. – С. 69-71.
7. Дилмуродов Ш. Д., Бойсунов Н. Б. Юмшоқ буғдой дурагай тизмаларида ҳосилдорликнинг биометрик кўрсаткичларга боғлиқлиги //Инновацион технологиялар. – 2020. – №. 2 (38).
8. Fayzullayev A. Z. et al. SELECTION OF HIGH-YIELDING AND HIGH-QUALITY LINES OF BREAD WHEAT //INTERNATIONAL SCIENTIFIC AND TECHNICAL

- JOURNAL "INNOVATION TECHNICAL AND TECHNOLOGY". – 2020. – Т. 1. – №. 3. – С. 10-14.
9. Odirovich J. F., Anvarovich A. O., Dilmurodovich D. S. VALUABLE PROPERTIES AFFECTING THE HIGH-YIELD ELEMENTS OF DURUM WHEAT //INTERNATIONAL JOURNAL OF DISCOURSE ON INNOVATION, INTEGRATION AND EDUCATION. – 2020. – Т. 1. – №. 2. – С. 37-41.
  10. Дилмуродов Ш. Д. Юмшоқ буғдойнинг маҳаллий маҳсулдор тизмалари селекцияси //Life Sciences and Agriculture. – 2020. – №. 1.
  11. Juraev D. T. et al. Heritability of Valuable Economic Traits in the Hybrid Generations of Bread Wheat //Annals of the Romanian Society for Cell Biology. – 2021. – С. 2008-2019.
  12. Дилмуродов Ш. Д., Жабаров Ф. О. Селекция высокоурожайных линий озимой твёрдой пшеницы с высоким качеством зерна //Молодой ученый. – 2019. – №. 31. – С. 34-38.
  13. Дилмуродов Ш. Д., Бойсунов Н. Б. Отбор продуктивных линий мягких пшениц из гибридного питомника в условиях южного региона Республики Узбекистан //World Science: Problems and Innovations. – 2018. – С. 58-60.
  14. Khushvaktovich M. A., Dilmurodovich D. S. THE CHOICE OF EARLY MATURING LINES OF SPRING BREAD WHEAT FOR IRRIGATED AREAS //НАУКА, ОБРАЗОВАНИЕ, ОБЩЕСТВО: АКТУАЛЬНЫЕ ВОПРОСЫ. – 2021. – С. 30.
  15. Дилмуродов Ш. Д., Бойсунов Н. Б. Селекция местных гибридных линий мягкой пшеницы на юге Республики Узбекистан //Сборник материалов. – 2018. – С. 113-119.
  16. Dilmurodov S. Some valuable properties in evaluating the productivity of bread wheat lines //INTERNATIONAL SCIENTIFIC AND TECHNICAL JOURNAL "INNOVATION TECHNICAL AND TECHNOLOGY". – 2020. – Т. 1. – №. 1. – С. 60-62.
  17. Дилмуродов Ш. Д., Зиядуллаев З. Ф. Юмшоқ буғдойда ўтказилган оддий ва мураккаб дурагайлаш ишлари натижалари //Life Sciences and Agriculture. – 2020. – №. 2.
  18. Дилмуродов Ш. Д., Бойсунов Н. Б. Рақобатли нав синаш кўчатзориди юмшоқ буғдойнинг биометрик кўрсаткичларини ўрганиш //Life Sciences and Agriculture. – 2020. – №. 1.
  19. Дилмуродов Ш. Д. и др. Гибридизация в различном направлении и создание гибридного поколения мягкой пшеницы //Инновационное развитие науки и образования. – 2018. – С. 74-77.
  20. Дилмуродов Ш. Д., Зиядуллаев З. Ф. Selection of early and productive lines in preliminary yield trial of bread wheat //INTERNATIONAL SCIENTIFIC AND TECHNICAL JOURNAL "INNOVATION TECHNICAL AND TECHNOLOGY". – 2020. – Т. 1. – №. 1. – С. 55-59.
  21. Дилмуродов Ш. Д. ЦЕННЫЕ СВОЙСТВА, ВЛИЯЮЩИЕ НА ВЫСОКОУРОЖАЙНЫЕ ЭЛЕМЕНТЫ МЯГКОЙ ПШЕНИЦЫ //ББК. – 2020. – Т. 60. – С. 38.

22. Dilmurodovich D. S., Bekmurodovich B. N., Shakirjonovich K. N. WINTER BREAD WHEAT GRAIN QUALITY DEPENDS ON DIFFERENT SOIL-CLIMATE CONDITIONS //INTERNATIONAL JOURNAL OF DISCOURSE ON INNOVATION, INTEGRATION AND EDUCATION. – 2020. – Т. 1. – №. 5. – С. 377-380.
23. Жураев Д. Т., Дилмуродов Ш. Д. Юмшок бутдойнинг бошқоқлаш-пишиш даврида иссиқликнинг таъсири //Life Sciences and Agriculture. – 2020. – №. 2-2.
24. Жураев Д. Т. и др. Влияние суховеев, наблюдаемых в южных регионах республики узбекистан, на продуктивные элементы мягкой пшеницы //Путь науки. – 2017. – №. 2. – С. 84-92.
25. Dilmurodovich D. S., Shakirjanovich K. N. ANALYSIS OF YIELD AND GRAIN QUALITY TRIATS IN THEADVANCED YIELD TRIAL OF WINTER BREAD WHEAT //Euro-Asia Conferences. – 2021. – Т. 1. – №. 1. – С. 550-555.
26. Dilmurodovich D. S. et al. Analysis of yield and yield components traits in the advanced yield trial of winter bread wheat //INTERNATIONAL JOURNAL OF DISCOURSE ON INNOVATION, INTEGRATION AND EDUCATION. – 2021. – Т. 2. – №. 1. – С. 64-68.
27. Дилмуродов Ш. Д., Каюмов Н. Ш. ОЦЕНКА ПРОДУКТИВНЫХ ПОКАЗАТЕЛЕЙ ЛИНИЙ МЯГКОЙ ПШЕНИЦЫ //Вестник науки и образования. – 2020. – №. 17-1 (95).
28. Dilmurodov S. D., Toshmetova F. N., Fayzullayeva D. SELECTION OF HIGH-QUALITY DONOR VARIETIES OF BREAD WHEAT FOR HYBRIDIZATION //МОЛОДЫЕ УЧЁНЫЕ РОССИИ. – 2020. – С. 55-58.
29. Дилмуродов Ш. Д., Каюмов Н. Ш., Бойсунов Н. Б. ЗНАЧЕНИЕ БИОМЕТРИЧЕСКИХ И ПРОДУКТИВНЫХ ПОКАЗАТЕЛЕЙ ПРИ СОЗДАНИИ ПШЕНИЦЫ С КОМПЛЕКСОМ ЦЕННЫХ СВОЙСТВ //Life Sciences and Agriculture. – 2020. – №. 2-3.
30. DILMURODOVICH D. S. et al. Productivity, quality and technological characteristics of bread wheat (*Triticum aestivum* L.) variety and lines for the southern regions of the Republic of Uzbekistan //Plant cell biotechnology and molecular biology. – 2021. – С. 63-74.
31. Dilmurodov S. D., Tukhtayeva U. A. SELECTION OF HIGH-YIELDING AND GRAIN-QUALITY DONORS OF WINTER BREAD WHEAT FOR IRRIGATED AREAS //НАУКА И ОБРАЗОВАНИЕ: СОХРАНЯЯ ПРОШЛОЕ, СОЗДАЁМ БУДУЩЕЕ. – 2020. – С. 92-95.
32. Kayumov N. S., Dilmurodov S. D. SELECTION OF HEAT AND DROUGHT TOLERANT VARIETIES AND LINES OF CHICKPEA FOR RAINFED AREAS //ВЫСОКИЕ ТЕХНОЛОГИИ, НАУКА И ОБРАЗОВАНИЕ: АКТУАЛЬНЫЕ ВОПРОСЫ, ДОСТИЖЕНИЯ И ИННОВАЦИИ. – 2020. – С. 129-131.
33. Хазраткулова Ш. У., Дилмуродов Ш. Д. Оценка жароустойчивости сортов и линий мягкой пшеницы //Наука и образование сегодня. – 2019. – №. 9 (44).
34. Dilmurodovich D. S. et al. STUDY OF MORPHO-BIOLOGICAL PROPERTIES AND RESISTANCE TO YELLOW RUST DISEASE OF NEW LINES OF WINTER BREAD WHEAT //InterConf. – 2021.



35. Shakirjanovich K. N., Dilmurodovich D. S. Analysis of yield and protein content of drought-resistant chickpea lines for rainfed areas //INTERNATIONAL JOURNAL OF DISCOURSE ON INNOVATION, INTEGRATION AND EDUCATION. – 2021. – Т. 2. – №. 1. – С. 108-111.
36. Dilmurodovich D. S., Nasirulloevna T. F. SELECTION OF EARLY MATURITY LINES IN AGROECOLOGICAL YIELD TRIAL OF BREAD WHEAT //НАУКА, ОБРАЗОВАНИЕ, ИННОВАЦИИ: АКТУАЛЬНЫЕ ВОПРОСЫ И. – С. 41.
37. Дилмуродов Ш. Д. и др. Сувсизликка чидамли кузги юмшоқ буғдой нав ва тизмаларининг баъзи қимматли хусусиятларини баҳолаш //Молодой ученый. – 2020. – №. 34. – С. 158-161.
38. Дилмуродов Ш. Д., Орипов Д. М. Суғориладиган майдонлар учун юмшоқ буғдойнинг F5 авлод дурагайлари селекцияси //Молодой ученый. – 2020. – №. 33. – С. 163-165.
39. Xolbazarovich K. K., Sarvarogli M. J., Nikolaevna P. M. Drought and heat tolerance of durum wheat varieties for rainfed conditions of Uzbekistan //ACADEMICIA: An International Multidisciplinary Research Journal. – 2020. – Т. 10. – №. 5. – С. 599-603.

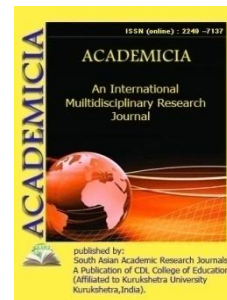
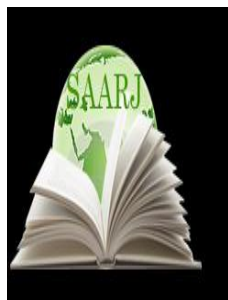

DOI: **10.5958/2249-7137.2021.01106.X**

## **HOMOCYSTEINE: EFFECT ON BIOCHEMICAL PROCESSES IN THE HUMAN BODY**

**Kucharova Inobat Sharofovna\***; **Akbarov Nurislom Akhtamjon ugli\*\***

\*Senior Lecturer,  
Department of Organic and Biological Chemistry,  
Candidate of Biological Sciences,  
Tashkent Pharmaceutical Institute,  
UZBEKISTAN

\*\*2nd year student of the Faculty of Industrial Pharmacy,  
Tashkent Pharmaceutical Institute,  
UZBEKISTAN

### **ABSTRACT**

*The article presents a review of the literature on the metabolism of the amino acid homocysteine, the emergence of risks for the development of a number of diseases due to excessive accumulation of homocysteine in the human body, and possible ways of correcting hyperhomocysteinemia.*

**KEYWORDS:** *Homocysteine, Homocysteine Metabolism, Hyperhomocysteinemia, Hemocoagulation, DNA Dimethylization, Oxidative Stress, Vitamins Of Group B.*

### **INTRODUCTION**

It is known that modern science is interested in the search for biochemical markers that could reflect the risks of development and the nature of the course of various diseases, as well as predict their outcome ... In recent years, many compounds have been discovered that can reflect and influence the biochemical profile of the body. The metabolic product of methionine, homocysteine, is one of them and attracts the attention of many researchers of various specializations.

## Homocysteine. Basic information

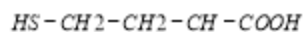

Homocysteine ( ) is a sulfur-containing non-protein compound that is synthesized in the body during methionine catabolism. This compound is necessary for the body, but in excess, it can cause oxidative stress, cause genetic mutations, induce cell apoptosis, promote the development of atherosclerosis, regardless of the presence of other atherogenic factors.

### Homocysteine Synthesis and Utilization Pathway

Homocysteine is synthesized from methionine in the liver to form SAM, which is a methyl group donor in transmethylation reactions. The optimal concentration of homocysteine in the blood is 5–16  $\mu\text{mol} / \text{L}$  and is maintained at this level by two main metabolic pathways: transsulfuration with the formation of cysteine or remethylation, ie, the conversion of homocysteine to methionine under the action of the enzyme methionine synthase.

For these reactions to occur, vitamins B6, B12 and folic acid are required (Fig. 1). It is the deficiency of these substances that can lead to hyperhomocysteinemia.

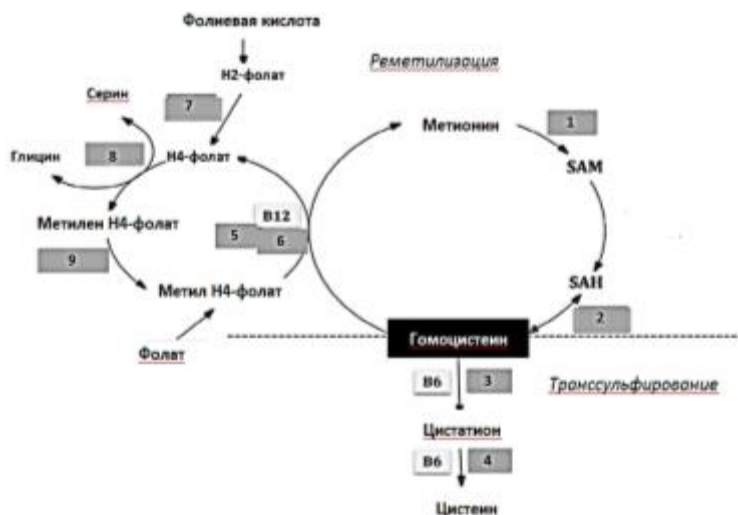

Fig. 1. Simplified scheme of homocysteine metabolism: enzymes: 1 - methionine adenosyltransferase; 2 - s-adenyl-L-homocysteine hydrolase; 3 - cystathion  $\beta$ -synthase; 4 - cystathionine  $\gamma$ -lyase; 5 - methionine synthase reductase; 6 - methionine synthase; 7 - dihydrofolate reductase; 8 - serine hydroxymethyltransferase; 9 - methylene tetrahydrofolate reductase

Hyperhomocysteinemia Hyperhomocysteinemia is a condition characterized by elevated levels of homocysteine in the blood.

Causes of hyperhomocysteinemia:

- ❖ hereditary fermentopathies;
- ❖ lack of folic acid and B vitamins in the body;

- ❖ gene polymorphism;
- ❖ smoking and drinking alcohol;
- ❖ hormone-dependent diseases;
- ❖ excessive consumption of coffee;
- ❖ impaired renal function;
- ❖ sedentary lifestyle.

Homocysteine increases the risk of thrombosis, causes DNA methylation and oxidative stress, and damages nerve cells and mitochondria (Fig. 2).

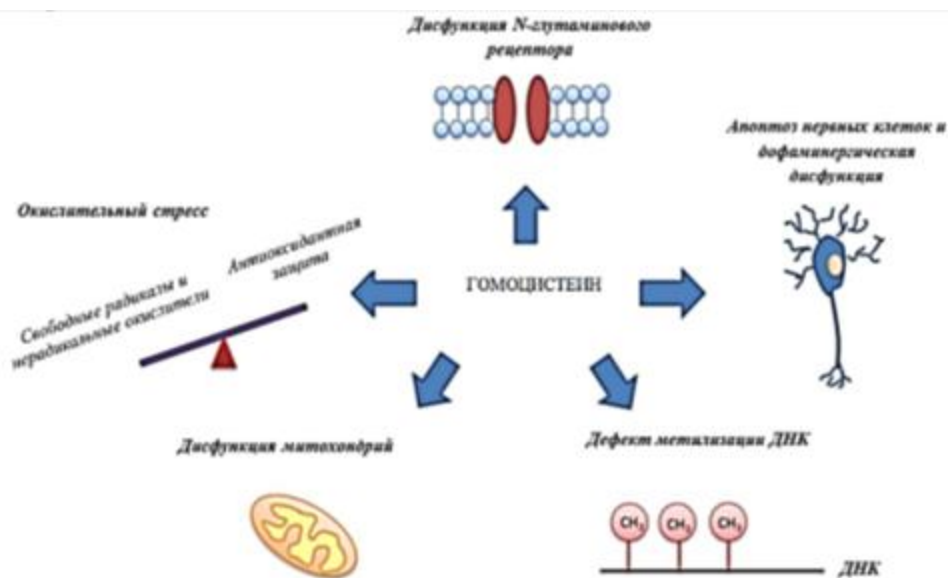

Fig. 2. Mechanism of action of homocysteine

According to the literature, hyperhomocysteinemia can cause resistance of factor V to the action of activated protein C due to the binding of factor V to homocysteine. Homocysteine also blocks the interaction of thrombomodulin with thrombin, which prevents the activation of protein C. Along with this, homocysteine disrupts the binding of antithrombin III with heparan sulfate, which is located on the vascular endothelium, leading to an even greater suppression of the anticoagulant system (Fig. 3)

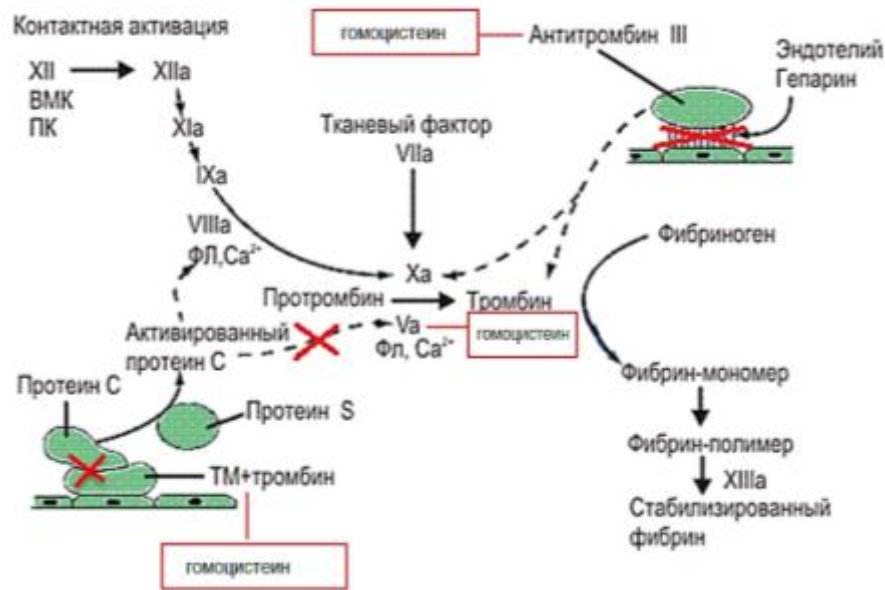

Fig. 3. Influence of homocysteine on the process of hemocoagulation

Normally, annexin II stabilizes the plasminogen receptor S100A10 and facilitates its movement to the cell surface, where the receptor binds to plasminogen and regulates the formation of plasmin. Homocysteine, binding to one of the annexin II domains, blocks the activation of plasminogen, which contributes to the formation of strong blood clots resistant to lysis, as well as an increase in the risk of thrombosis.

Moreover, according to McCullyKS studies, homocysteine damages the endothelium of arteries, initiating the process of activation of cytokines, cyclins and other mediators of inflammation and cell proliferation.

Under the action of homocysteine, reactive oxygen species are formed, which have an oxidative effect on LDL and lipids of endothelial cell membranes, leading to their destruction. An increase in homocysteine concentration can lead to dimethylation of the CpG gene and thus suppress the activity of methyl-CpG-binding protein. As a result, the activity of histone cytylase decreases and the acetylation of histones H3, H4 occurs, which leads to a decrease in gene expression. These processes occur in relation to passive transcriptional chromatin, a change in conformation of which can increase binding by repressor proteins and suppress transcription.

At low glycine concentrations, homocysteine acts as a partial antagonist for the N-glutamate receptor, resulting in hypofunction of glutamatergic transmission, leading to depressive disorders (Fig. 4).

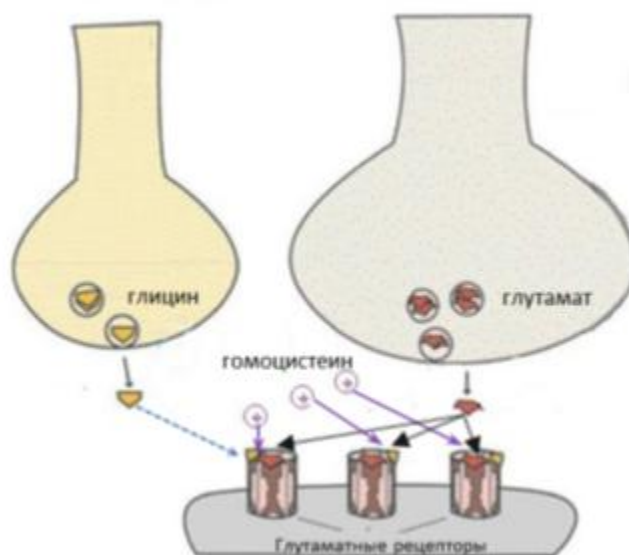

Fig. 4. Interaction of homocysteine with glutamate receptors

**Prevention of the damaging action of homocysteine** Paraoxonase plays a special role in protecting endothelial cells from the damaging action of homocysteine. This enzyme is localized on HDL and has lactonase activity, which prevents lipoprotein oxidation and detoxifies proteins that have undergone a reaction with homocysteine. B vitamins and folic acid, which are present in sufficient quantities in the body and supplied with food such as greens, cereals, nuts, whole grain bread, the liver participate in the metabolism of homocysteine, catalyzing the reactions of converting it into non-toxic products, and thus prevent the development of hyperhomocysteinemia ...

**Prospects for research** Already at this stage of the study, the effect of homocysteine on biochemical and pathophysiological processes in the human body is unconditional. It has been proven that hyperhomocysteinemia can indicate disorders in the course of many metabolic pathways and be a risk factor for the occurrence of diseases such as Alzheimer's disease, dementia, myocardial infarction, heart failure, renal failure, atherosclerosis and other diseases associated with vascular damage and tissue ischemia. However, the mechanism of the damaging effect of this compound on mitochondria and on nerve cells is not sufficiently understood, which is an urgent topic for further research.

## REFERENCES

1. Andrianova M. Yu., Roytman E. V., Isaeva A. M., Kolesnikova I. M., Nureyev M. V. Pathogenetic and clinical rationale for complex prevention of hyperhomocysteinemia // Archive of internal medicine. 2014. No. 4. URL: <http://cyberleninka.ru/article/n/patogeneticheskoe-i-klinicheskoe-obosnovanie-kompleksnoy-profilaktiki-gipergomotsisteinonii> (date of access: 12.12.2015).
2. Vilchuk KU The role of homocysteine and oxidative stress in the pathogenesis of endothelial dysfunction in children with pyelonephritis // Problems of health and ecology. 2013. No. 1 (35). URL: <http://cyberleninka.ru/article/n/rol-gomotsisteina-i-okislitel'nogo-stressa-v-patogeneze-disfunktsii-endoteliya-u-detey-s-pielonefritami> (date of access: 12.12.2015).

3. Graban A. Yu., Ryglevich D. Hyperhomocysteinemia - an independent risk factor for atherosclerosis // Vestnik VSMU. 2003. No. 3. URL: <http://cyberleninka.ru/article/n/gipergomotsisteinemiya-nezavisimyy-faktor-riska-ateroskleroza> (date of access: 12.12.2015).
4. Shevchuk VV, Malyutina NN Association of hyperhomocysteinemia with the functional state of the thyroid gland in adolescents in the iodine-deficient region // Modern problems of science and education. 2012. № 2. URL: <http://cyberleninka.ru/article/n/assotsiatsiya-gomotsisteinemii-s-funktsionalnym-sostoyaniem-schitovidnoy-zhelezy-u-podrostkov-v-yoddefitsitnom-regione> (date of access: 12.12.2015) ...
5. PardayevaMaftunaIlhomovna, &AkbarovNurislomAkhtamjonugli. (2021). ROSEHIP AND ITS HEALING PROPERTIES. JournalNX - A Multidisciplinary Peer Reviewed Journal, 7(04), 65–67. Retrieved from <https://repo.journalnx.com/index.php/nx/article/view/2839>



**ACADEMICIA**  
**An International  
 Multidisciplinary  
 Research Journal**  
 (Double Blind Refereed & Peer Reviewed Journal)

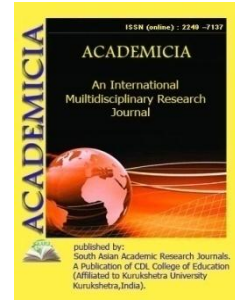

**DOI: 10.5958/2249-7137.2021.01107.1**

**THE CURRENT STATE OF THEORY AND TECHNOLOGY  
 ENRICHMENT OF POLY METALLIC ORES AND ENRICHMENT  
 PRODUCTS**

**Mutalova Markhamat Akramovna\*;  
 Salidzhanova Gulnara Kakhkharovna\*\*;  
 Ibragimov Izatilla Sulaymonovich\*\*\*;  
 Suyarov Jakhongir Usmon ugli\*\*\*\*;  
 Abdurakhmanova Nargiza Abdurasul qizi\*\*\*\*\***

\*Associate Professor, Department of Mining,  
 Almalyk branch of the Tashkent State Technical University named after Islam Karimov,  
 UZBEKISTAN

\*\*Associate Professor, Department of Mining,  
 Tashkent State Technical University named after Islam Karimov,  
 UZBEKISTAN

\*\*\*Senior Teacher of the Department of Mining,  
 Almalyk branch of the Tashkent State Technical University named after Islam Karimov,  
 UZBEKISTAN

\*\*\*\*Assistant to the Department of Mining,  
 Almalyk Branch of the Tashkent State Technical University named after Islam Karimov,  
 UZBEKISTAN

\*\*\*\*\*Student,  
 Almalyk branch of the Tashkent State Technical University named after Islam Karimov,  
 UZBEKISTAN

---

**ABSTRACT**

*Many lead and especially lead-zinc ores contain copper. The copper content in lead concentrates obtained by enriching such ores with flotation is significant (3.5%). The presence of copper in lead concentrates reduces the extraction of lead during metallurgical alteration, and also complicates and increases the cost of lead smelting, and, in addition, creates difficult working conditions for workers in metallurgical workshops. In practical terms, the task of separating lead-copper concentrates by selective flotation is one of the most difficult. Researchers in recent years have been able to significantly develop and improve the technology for the separation of*



*lead-copper concentrates, due to which a number of factories have reduced the copper content in lead concentrates and increased lead extraction. However, this issue has not yet reached its radical solution, due to the difference in ores of different deposits in its chemical, mineralogical composition and other features.*

**KEYWORDS:** *Selection, Desorption, Depression, Extraction, Product Output, Content, Ammophos, Mineralogical Composition, Phase Analysis, Polymetallic Ores, Qualitatively Quantitative Scheme.*

## INTRODUCTION

Uzbekistan in the proven reserves of gold, copper, lead, zinc, uranium and other metals occupies a leading place among the CIS countries. In the conditions of independence of the republic, the mining and metallurgical industry faced a whole complex of complex problems. This is primarily an increase in environmental requirements, an increase in the need for non-ferrous metals, including copper and lead, a shortage of flotation agents, requirements for the cleanliness of the resulting product, and the problem of waste disposal.

The task of creating a rational and integrated technology for the processing of technologically advanced polymetallic industrial products is very relevant.

Increased production of lead and zinc requires the involvement of new deposits, off-balance sheet ores, and waste from concentration plants.

Improving the technology of enrichment of polymetallic ores and methods of separation of collective concentrates can significantly increase the production of copper, lead, zinc, rare and noble metals without high costs.

### Main part

Material-complicated polymetallic ores are processed at most concentration plants according to various technological schemes.

Polymetallic sulfide ores are enriched according to the collective selective flotation scheme with a collective concentrate. Then the collective concentrate is sent for selection.

Preliminary search experiments showed the positive effect of ammophos as a depressor, however, the reproducibility of the results was unstable. Therefore, we put experiments to determine the optimal parameters of the flotation separation of lead-copper concentrate.

The experiments caused by the consumption of ammophos (0-10 kg/t) without preliminary desorption of reagents from the surface of lead-copper concentrate did not give stable positive results, there was a significant transition of halenite to the foam product, and with an increase in the consumption of ammophos of more than 10 kg/t concentrate and copper minerals are noticeably depressed. The selection was successful in some cases and not with a fresh concentrate. This is due to the fact that particles of minerals are covered with films of flotation reagents (Xantogenate, foaming agent, T-92, etc.). These films do not allow the interaction of ammophos with the surface of particles.

The process of desorption of collective concentrate was carried out in the following order: a certain amount of collective concentrate was mixed with a solution of sodium sulfate for 15-20

minutes, then the pulp was diluted with tap water to H: L - 1: 20, mixed, defended and drained the illuminated part to solid content in a condensed pulp equal to 50%.

The effect of the duration of contact of the pulp with sulfur sodium and the number of collective concentrate was studied on the degree of separation of lead-copper concentrates. Further experiments conducted preliminary desorption of reagents with sulfur sodium.

An increase in the number of launderers slightly improves the separation of copper and lead minerals. However, this improvement was not highly effective. Therefore, when conducting further experiments, we produce one washout using water dilution to H: L = 1:20.

Experiments have shown that in order to remove flotoreagettes from the surface of particles, it is necessary to contact the concentrate with a solution of sodium sulfate for 15 minutes. when the last 6-8 kg/t is consumed.

The collective concentrate cleared of flotation reagents was subject to flotation separation. The dependence of the degree of separation of copper was studied

and lead during flotation from ammophos consumption from the duration of contact with ammophos, from pH of medium.

The results of experiments on the effect of ammophos consumption on the degree of separation of copper and lead showed that a fairly complete separation occurs when ammophos 2.5-3 kg/t is consumed. concentrate. With fewer ammophos, it is apparently not enough to cover all particles of ammophos with film, and at high costs ammophos depression and copper minerals begin. The effect of the duration of mixing collective concentrate with ammophos after desorption and washing was also studied. Agitation in various experiments lasted from 15 to 60 minutes. Ammophos consumption was 2.5 kg/t. The results of the experiments are presented in the table.1

**TABLE 1 DEPENDENCE OF THE DEGREE OF EXTRACTION OF COPPER AND LEAD DURING FLOTATION ON THE CONSUMPTION OF AMMOPHOS.**

Name product	Exit, %	Content, %		Extraction, %		Consumption ammof.kg/t concentrate
		Cu	Pb	Cu	Pb	
Copper.concen.main one	56,4	4,6	54,75	77,4	60,20	0
Tails are copper.flotation	43,6	1,74	46,83	22,6	39,80	
Ex. Pb - Cu concentrate	100,0	3,35	51,30	100,00	100,00	
Copper.concen.main one	23,7	11,4	23,5	80,9	10,86	0,5
Tails are copper.flotation	76,3	0,84	59,90	19,1	89,14	
Ex. Pb - Cu concentrate.	100,0	3,35	51,30	100,00	100,00	
Copper.concen.main one	22,0	12,6	19,6	82,73	8,40	1,0
Tails are copper.flotation	78,0	0,74	60,24	17,27	91,60	
Ex. Pb - Cu concentrate	100,0	3,35	51,30	100,00	100,00	
Copper.concen.main one	21,30	15,30	17,60	84,60	7,30	2,5
Tails are copper.flotation	78,70	0,65	60,40	15,40	92,70	
Ex. Pb - Cu concentrate.	100,0	3,35	51,30	100,00	100,00	
Copper.concen.main one	23,00	12,30	20,40	84,40	9,15	5,0
Tails are copper.flotation	77,00	0,69	60,50	15,60	90,85	

Ex. Pb - Cu concentrate.	100,0	3,35	57,30	100,00	100,00	
Copper.concen.main one	28,90	10,80	33,50	93,00	18,87	10,0
Tails are copper.flotation	71,10	0,33	58,50	7,00	81,13	
Ex. Pb - Cu concentrate.	100,0	3,35	51,30	100,00	100,00	

In the presence of ammophos with an increase in the duration of agitation, the lead content in copper concentrate is reduced.

When campaigning for 15-30 minutes, incomplete depression of halenite occurs and the flotation of chalcopirit is deteriorating. When campaigning for 45 minutes, satisfactory results were achieved.

When campaigning for more than 45 minutes, copper minerals are partially depressed and the copper content in copper concentrate decreases.

Experience in determining the effect of pH in which lead-copper concentrate with ammophos was mixed (45 min., consumption 2.5 kg/t) were carried out by adding a solution of soda ash. The results of the experiments are given in table 2.

These experiments have shown that creating an alkaline environment (pH 8.9 and higher) negatively affects breeding. If with pH from 6.4 to 8.2 the lead content in copper concentrate was 25.7% - 28.9%, then with pH = 8.9 this content increased sharply to 38.1%.

This is because the depression of lead minerals is associated with the displacement of xanthogenate ions with phosphate ions from its surface.

With low pH formed  $PbHRO_4$ , which shows a deterioration in the separation of lead-copper concentrate. With a higher pH = 9-10, the balance shifts towards education  $Pb_3(PO_4)_2$ . Therefore, we can conclude that at pH = 8.5, hydrophilization of the surface of halenite occurs and HP ions are formed.  $bO^{-2}RO_4^{-3} 4ON^{-}$  due to what positive results obtained. Therefore, depression should be carried out at pH not more than 8.2.

Thus, the following conditions of copper-pig breeding were determined from laboratory experiments: the pulp of the original lead-copper concentrate is mixed with 15 min with sodium sulfate (cost 6-8 kg/t) at H: L = 1: 3. Then follows water dilution to H: L = 1:20, sucks and draining of the illuminated part to the solid content in the condensed pulp, equal to 50%.

Galenite depression is carried out by 45 minutes when mixed with washed collective concentrate with ammophos (cost 2.5 kg/t), then basic copper flotation and four copper concentrate reins in an open cycle. According to this technology, various experiments produced copper concentrate with a copper content of 18-30% (extract of 50-81%), lead - 2.3-3.4% (extract from 0.2-0.7%) .

When breeding lead-copper concentrate, metal losses in mixed concentrates are inevitable. Losses of lead with copper concentrate can be reduced by introducing an additional lead-free operation of copper concentrate.

**TABLE 2 THE EFFECT OF PH ON THE SELECTION OF LEAD-COPPER CONCENTRATE**

Name product	Exit, %	Content, %		Extraction, %		pH at agitation with ammophos
		Cu	Pb	Cu	Pb	
Copper concentrate.	30,0	11,62	28,9	95,0	15,6	6,4 Without soda
Tails are copper.flotation	70,0	0,30	67,1	5,0	84,4	
Ex.Pb-Cu concentrate.	100,0	3,70	55,4	100,0	100,0	
Copper concentrate.	23,1	12,36	25,7	96,0	13,1	7,6
Tails are copper.flotation	76,9	0,20	66,9	4,0	86,9	
Ex.Pb-Cu concentrate.	100,0	3,70	55,4	100,0	100,0	
Copper concentrate.	30,0	11,72	28,6	90,0	15,5	8,2
Tails are copper.flotation	70,0	0,20	66,8	10,0	84,5	
Ex.Pb-Cu concentrate.	100,0	3,70	55,4	100,0	100,0	
Copper concentrate.	35,2	10,19	38,1	95,7	23,1	8,9
Tails are copper.flotation	64,8	0,25	55,5	4,3	76,9	
Ex.Pb-Cu concentrate.	100,0	3,70	55,4	100,0	100,0	

The operation of desalination of copper concentrate, as is known from the practice of domestic and foreign factories, is carried out by depression of copper minerals with cyanide and before flotation of lead minerals into the foam product. An overhanging operation can take place without prior desorption of reagents from the surface of minerals if copper minerals are represented by chalcopyrite.

Experience in debating copper concentrate IV miscalculations were carried out at cyanide consumption from 0.2 to 2 kg/t of the initial lead concentrate. The duration of the contact (10 minutes) was selected experimentally, the flotation time was 5 minutes.

Copper losses in lead concentrate of do flotation were 5.4% of the original product, or 7.5% of the operation. The content in copper lead concentrate is reduced to 1.25%.

Since the output of the lead product after lead is insignificant, it can be sent directly to the finished lead concentrate.

To obtain the final version of the technological scheme for the separation of lead-copper concentrates, two identical experiences were set: desorption of reagents with sulfur-sodium for 15 minutes, at pH = 8.5 agitation with ammophos 45 minutes, ammophos consumption 2.5 kg/t of concentrate and four stripping with brass concentration at optimal parameters with an open and closed cycle. Based on the results of these experiments, we can conclude that the results of the experiments in the closed cycle are more real and the copper content in the copper concentrate is high. (Table 3)

The results of experiments in the open cycle of separation of lead-copper concentrate allow us to conclude that when used as a depressor of lead minerals of ammophos (2.5 kg/t of concentrate) and the introduction of the operation of desalination of copper concentrate (cyanide consumption 1.0 -1.5 kg/t), a copper concentrate with high rates is possible. The concentrate contains 30.3 % copper, 1.6% lead when 56.8 % copper and 0.24 % lead are extracted into it.

The results of the experiments were close and can be considered quite satisfactory in all respects. A copper concentrate with a copper content of 32.6 % and a extraction of -90.45 % were obtained.

**TABLE 3 RESULTS OF EXPERIMENTS IN A CLOSED CYCLE**

Product Name	Exit, %	Content, %		Extraction, %	
		Cu	Pb	Cu	Pb
Copper concentrate.	8,2	32,60	1,70	90,45	0,22
Pb concentrate.	91,8	0,31	70,10	9,55	99,78
Ex.copper-plumbum.concent	100,0	2,96	64,34	100,00	100,00

With him, 0.2-0.22% of lead was lost. The quality of lead concentrate increased by 5-5.76 %. The foam product of copper concentrate had a yield of 1.4-1.6 % and contained 13.7-17.2 % copper, 2.1-7.2% lead and 2.4 % zinc. This technology has been recommended for industrial testing.

## DISCUSSION

Accelerating scientific and technological progress requires increasing the complexity of ore processing, the completeness of the extraction of valuable metals from them. Decisions of the Government of the Republic of Uzbekistan provide for a significant increase in the production of non-ferrous metals. At this is given special attention to the development of poor and complex deposits through the development of new technologies and reagent regimes, the wide automation of technological enrichment processes. The task of creating a rational and integrated technology for the processing of technologically advanced polymetallic industrial products is very relevant.

Increased production of lead and zinc requires the involvement of new deposits, off-balance sheet ores, and waste from concentration plants.

As a result of the studies, the mechanism of action of ammophos on the surface of copper and lead minerals has been comprehensively studied and disclosed, and it has been proven that ammophos is an effective depression of lead minerals when dividing lead-copper concentrates.

## CONCLUSION

1. It was found that the results of flotation of pure minerals of lead and copper mainly depend on the flow rate of the reagent, on the size of the grinding, pH of the medium, mixing speed, etc.d.

2. The process of selection of lead-copper concentrate using ammophos has been studied and the optimal flotation mode has been established: flushing the initial collective concentrate with a solution of sodium sulfate at a flow rate of 6-8 kg/t for 15-20 minutes, then flotation of copper at a consumption of ammophos of 2.5 kg/t, butyl xanthogenate 30 g/t.

3. A highly efficient, new technology for breeding collective lead-copper concentrate using cheap, non-toxic local raw materials - ammophos, as an effective depressor of lead minerals has been developed.

**REFERENCES**

1. Abramov A.A. Technology for the enrichment of non-ferrous metal ores.- Moscow: Nedra. 1988. - 358s.
2. Abramov A.A. Flotation enrichment methods. -Moscow: Nedra. 1984. -382s.
3. Abramov A.A. etc. Enrichment of non-ferrous and rare metal ores in Asia, Africa and Latin America.- M.: Nedra. 1991. -309s.
4. Bogdanov O.S. etc. Study of the action of flotation reagents. L.: 1965.- 239s.
5. Shubov L.S, Zalesnik I.B, I.B.Mitrofanov S.I. On the interaction of ditiophosphates with copper ions in the flotation pulp. // W.non-ferrous metals. 1975.No. 11. S.84-86.
6. Shubov L.S, I.B.Mitrofanov . The mechanism of hydrofibrization of chalcopyrite in flotation with ditiophosphates. // W. non-ferrous metals. 1976.Number 4. S.82-86.
7. Mutalova M.A, Abdurahmanov S.A, Extraction of valuable components from the tailings of the processing plants of AGMK. // W. Mountain Bulletin of Uzbekistan. 2000. No. 2 . WITH. 21-23.
8. Mutalova M.A., Abdurahmanov S.A, Askarov M.A. Study of chemical transformations of ammophos with halenites. // Problems and prospects of chemistry and chemical technology: Tes.dokl.Resp.scientific.conf. October 29-31, 1998.- Navoi, 1998 s95-96
9. Mutalova M.A, Abdurahmanov S.A. The study of the dependence of the degree of separation of copper and lead on the consumption of ammophos. // Non-traditional technologies for the extraction and processing of minerals - the progress of mining science of the 21st century: Tes.dokl. Resp. scientific. conf. May 25-27, 2000.- Navoi, 2000.from 114-115.
10. Mutalova M.A, Abdurahmanov S.A. Increasing the extraction of color and noble metals in collective concentrate. // Non-traditional technologies for the extraction and processing of minerals - the progress of mining science of the 21st century: Tes.dokl. Resp. scientific. conf. May 25-27, 2000.- Navoi. 2000. from 128-129.

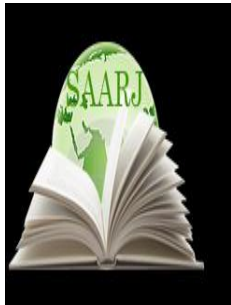

**ACADEMICIA**  
**An International  
 Multidisciplinary  
 Research Journal**  
 (Double Blind Refereed & Peer Reviewed Journal)

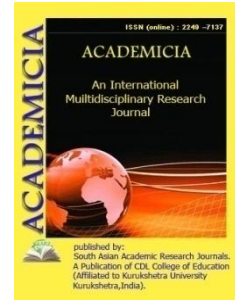

**DOI: 10.5958/2249-7137.2021.01108.3**

## USE OF PORTFOLIO TECHNOLOGY TO EVALUATE TEACHERS AND STUDENT RATINGS

**Xaitova Zarina Xobilovna\***; **Yuldosheva Zulfizar Sayfulloqizi\*\***

\*Master,

Samarkand branch of Tashkent University of Information Technologies named after Muhammad al-Khwarizmi, UZBEKISTAN

Email id: xabarlar3736@gmail.com

\*\*Master,

Samarkand branch of Tashkent University of Information Technologies named after Muhammad al-Khwarizmi, UZBEKISTAN

Email id: yoldashevazulfizar@gmail.com

---

### ABSTRACT

*The article describes the methods and technology of using "portfolio" technology. Evaluation of the results of scientific activity of university teachers, students and masters, monitoring data allow to support the level of understanding of the goals and opportunities of the portfolio of teachers and students and its implementation. According to the research of teachers, the introduction of a portfolio has a positive impact on the organization of the learning process.*

**KEYWORDS:** *Portfolio Technology, Virtual Portfolio, Rating, Scientific Teacher And Student Activities, Technology, Scientific Achievements.*

---

### INTRODUCTION

Today, the problem of assessing the quality of education is of great importance in all countries of the world. Assessment technologies are largely based on the concepts and strategies of education that exist in different education systems. The process of evaluating the effectiveness of the university does not depend on pedagogical activity and subjective factors that characterize its scientific features and the quantitative parameters given to society. In this regard, there is a need to determine the effectiveness of teachers' activities, and the quality of student training, in particular, the assessment of their scientific achievements, as well as the criteria for quantitative evaluation of scientific activities are not sufficiently developed. Therefore, it is the development of systematization technology, the development of scientific documents, the determination of the

effectiveness rating of teachers and students. Evaluation of research and scientific-methodical activity of professors and teachers and determination of the rating of research work of university students is an important educational process.[1]

We have used "portfolio" technology for teachers and students to store, organize and document the results of scientific activities.

The term "portfolio" has long been familiar to art professionals: many, now and in past centuries, some artists have created a portfolio of their creative work.

There are many approaches today in interpreting the concept of 'portfolio'. A portfolio is a form of realistic assessment of learning outcomes based on scientific activity created by a student or teacher in the process of learning, creative, social and other activities. The portfolio emphasizes the planning and self-assessment of learning outcomes by teachers and students. Thus, the portfolio is consistent with the goals, objectives, programs, and technology of the training.[3]

**Portfolio evaluation.** The portfolio is evaluated by the administration of the educational institution or by a public body depending on the purpose of its presentation. The evaluation will look at all the materials in the portfolio in terms of how they have affected student outcomes and teacher development. Thus, the pedagogical electronic portfolio is, on the one hand, the personal portfolio of the teacher, on the other hand, the integration and understanding of the experience of other educators, methodologists, IT-specialists. It provides space for the educator and his students to work independently and creatively. In addition, the communicative role in the development and use of electronic portfolios, which is reflected in the communication and interaction with other teachers, students (e-seminars, consultations, web projects, etc.) in the educational environment using computers and the Internet we emphasize. These processes help to develop the technology of the university's portfolio of faculty and students.[1,3]

***In real pedagogical practice, there are three main types:***

Portfolio of documents "- a portfolio of a certified (documented) individual.

"Work portfolio" - a description of various creative, project collections, research work, as well as the main forms and directions of activity.

A "commentary portfolio" is an assessment by an author of his or her accomplishments, an analysis of various activities and their outcomes, a conclusion, future planning stages of professional growth, as well as various reviews and more.

The purpose of the traditional portfolio for teachers and students is to present their work to demonstrate their educational achievements. However, it is very important to form a university student who accepts the news. That is why in our research we talk about the portfolio of scientific achievements of the teacher and the student. The main task of research and teaching research activities is to deepen and strengthen students' knowledge, increase the share of ratings. Teachers 'and students' scientific activities and scientific-practical tasks, as well as their participation in scientific-practical activities of students in different areas of conducting scientific-practical conferences The introduction of research elements into various forms of teaching eliminates contradictions at the present time. very effective. The role of scientific advisors, teachers and curators in increasing the effectiveness of the student portfolio is great.[2]



***Principles of the technological portfolio of scientific achievements of teachers and students:***

- Voluntary participation in the project, self-assessment of students' results;
- Mastering certain types of scientific activities;
- Systematic and regular self-monitoring;
- The structure and consistency of the information provided in the Portfolio;
- Reliability, integrity of the submitted materials.

***The portfolio of teachers of the University for scientific research and scientific-methodical activities is as follows:***

- Qualification characteristics (academic degree, title, membership (RAS, RAO));
- Scientific supervision and departmental awards, honorary titles for masters, graduate students and doctoral students;
- Membership in UMO in scientific and methodological councils on the specialty;
- Provide information on all types of scientific and methodological and research;
- Information on inventive activity, preparation of candidates and doctors of sciences, preparation of students of Olympiad winners of different levels and student scientific competitions;
- The volume of research of economic contract and state budget, as well as the completion of various types of research work with students and scientific, organizational work.

A very large list of scientific activities and activities, research and scientific-methodological activities of teachers, the research does not allow students to perform them systematically in a timely manner, the use of modern information technology is advisable. An important component of the student portfolio and the teacher's portfolio is the module, which allows to determine the level of their scientific effectiveness and to assess the virtual portfolio of students' scientific achievements. The level of participation in events, the number of works performed and their evaluation, is determined by the level of activities.[4,5]

In the window of editing information on the results of the teacher's scientific activity: Rankings are calculated throughout the university, by faculties, departments, frameworks and academic groups are calculated at the end of each semester, as well as throughout the educational process. Four researchers will be provided to ensure that the results are comparable. Categories of teaching staff:

- professors,
- Associate Professors,
- Senior teachers,
- Assistants.

Teacher and researcher rankings describe the teacher's accumulated qualification potential, working hours, as well as production and creative activities. The teacher's rating for the last five years is determined accordingly. In the e-portfolio of teachers and in the e-portfolio of students

new scientific achievements in the format of personal documented web resources as well as the rating of scientific achievements allow to have a variety of analytical data.[6]

For each teacher, an absolute rating of his or her academic performance is obtained, and efficiency and relative rankings are determined among colleagues in the work group. All points are shown in the table of generalized rating of teachers based on the portfolio of scientific achievements. Thus, student and teacher portfolios are the basis of the ranking of scientific achievements in the web resource format, the ability to improve the system of criteria for students and teachers and the regulation of indicators of performance evaluation of university departments. technologies are used. Therefore, the diversity of portfolio models, the differences in the areas of education and professions in which they operate, the specific goals of certain types of portfolios are constantly trying to create a certain typology of it with teachers and requirements. Nowadays, the importance of the portfolio of teachers and students for the university is of great importance as a way to increase the effectiveness of teaching and support the improvement of teaching. Describes the curriculum portfolio as documents and materials that together reflect the scope and quality of faculty training. The training portfolio will also increase the scientific effectiveness of the list of publications, grants and benefits.

## CONCLUSION

Working with portfolio technology can help solve many pedagogical problems. Modern educational innovations make the teacher and the student the subject and center of the educational process, giving him maximum freedom and responsibility in setting goals and organizing their educational activities. focuses on self-assessment. For example, in the search for sources of information, the selection of specialists and leaders in educational research, the development of individual curricula, and so on. The article describes the purpose and essence of the portfolio, the presented technological processes, portfolio models and methods of their evaluation, as well as the specific features of each portfolio model, the authors use portfolio technology as a required educational technology.

## LITERATURE

1. Xuzina, S.A. Rating assessment of research quality and scientific-methodical activity of the teacher: textbook / T.A. Shulgin, C.A. Xuzina, G.N. Vorobyov. - Chelyabinsk: RECPOL Publishing House, 2015. - 70 p.
2. Xuzina, S.A. Research and development of electronic portfolio students // New information technologies in education: materials International scientific-practical conference, Yekaterinburg, 2012.
3. Smolyaninova OG Certification of teachers of higher educational institutions: Russian and foreign experience // Design materials - seminar "Improvement of the system of evaluation of university professors on the basis of the electronic portfolio method". 2016 S. 74-80.
4. Aldjanova "Educational portfolio - as a tool for the formation of professional competence in future teachers" Journal of Pedagogical Education, No. 4, 2017, p.
5. I.A.Pastukhov individualistic - two-way achievements of the IP portfolio, kontrolnootsenochnoePeda - gogical tool // Professional Obra - associations. 2016.
6. S.Musaeva "Purpose and essence of portfolio" Journal of pedagogical education, issue 1, 2013, page 20.

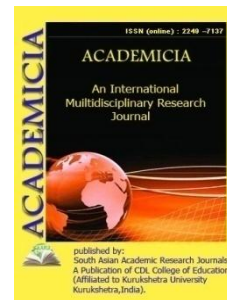
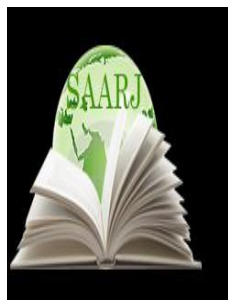

DOI: **10.5958/2249-7137.2021.01109.5**

**SCIENTIFIC AND METHODOLOGICAL BASES OF INTEGRATIVE  
IMPROVEMENT OF THE COURSE "POLYMER CHEMISTRY"  
UNDERGRADUATE EDUCATION "CHEMISTRY"**

**Kurbonova Gulchekhra Rayimovna\*<sup>\*</sup>; Nishonov Mirkozimjon Fozilovich\*\*<sup>\*\*</sup>**

\*Teacher at Chemistry Department,  
Fergana state University, UZBEKISTAN

\*\*Professor,  
Chairman of Chemistry Department,  
Fergana state university, UZBEKISTAN  
Email id: Nishonov17157@scientifictext.ru

**ABSTRACT**

*In this article, we will show how polymers are taught in the section on this topic. Information on the history of the Department of Polymers at the Faculty of Chemistry is provided at universities. Polymer science courses at the University of Concept are an integral part of the curriculum in seven programs - chemistry, biochemistry, bioengineering, civil engineering in materials, chemical analysis, chemistry and civil engineering in chemistry. A detailed description of the polymer-based courses included in the curriculum, as well as the scientific and methodological basis for the integrative improvement of the course "Polymer Chemistry" in the bachelor's degree program "Chemistry" in universities.*

**KEYWORDS:** *Polymer Chemistry, Methodology, Chemistry, Integrative Improvement, Teaching Methods, University, Curricula.*

**INTRODUCTION**

Polymers are a part of our lives; scientists dedicated to polymer science are developing new materials, thinking about environmentally friendly methodologies and meeting people's needs. In many universities, polymer science is taught by academics associated with traditional chemistry departments (organic, analytical, physical, and inorganic chemistry). Like various sciences, polymer chemistry has its own language and terminology. Poly- means many, inheritance- means size. Also, the molecular mass of polymers is very large. Their exact scientific name is called

high-molecular compounds. However, you are well aware that the so-called "polymer" is synonymous with science, technology and is widely used in life. The molecule of polymers is also called a macromolecule because they actually have a molecular mass. Polymers are high-molecular compounds whose macromolecules have a chain structure, consisting of groups of atoms (joints) that repeat many times.

Due to the interdisciplinary nature of teaching polymer chemistry to undergraduate students, there are specific difficulties in conveying the topic clearly. It aims to propose a new curriculum for teaching this core course to overcome some major barriers. In particular, new integrative research methods are being added to the professors responsible for teaching first-year polymer chemistry. Starting with the simplest chemical pathway, i.e. live anionic polymerization, we intended to facilitate polymerization. In addition, some pedagogical challenges are highlighted in this article. These new scientific methods of polymer teaching are based on knowledge of organic chemistry.

What is the purpose of the science of "polymer chemistry"? In fact, it is to acquaint undergraduate students in the field of chemistry with the basics of polymer chemistry and its important practical features, which the chemist-bachelor should know, and to help them to test their theoretical knowledge in practice. The general course focuses on explaining the properties of polymers that differ from ordinary submolecular compounds due to the large size and chain structure of macromolecules. The general theoretical course of the subject "Chemistry of Polymers" is carried out by students through laboratory work.

Teaching improvement processes:<sup>1</sup>

- Strategies for providing teaching and workshop opportunities to improve teaching staff;
- Creating opportunities to improve academic courses and research through conferences;
- Update by reading more books and articles related to the course;
- Improving methods in the classroom and allowing students to focus on the learning process through relationships such as improving and enhancing the teacher-student relationship. World experience shows that the relationship between teacher and students certainly affects the quality of education.

Polymer chemistry course materials and learning outcomes should be reviewed periodically and modified. The development of scientific and methodological bases for the integrated improvement of the course of polymer chemistry and the introduction of innovations in this area require the use of modern and interactive teaching methods, mainly through the initiative. Pedagogy is a fundamental and applied science. First fundamental applied research and is characterized by the expression of fundamental priorities. The strategic goal of fundamental research is to identify laws and regularities, to create theories and concepts, to systematize the properties and significance of real objects.

The increasing use of IT or web directories will also make it easier to educate students through changes in content as a result of new research. Polymer Chemistry course materials will be posted on the website, which students can access and can easily use both intensive and integrative coursework. Electronic materials and computer-based software are used to support the course material.

It is necessary to continuously use traditional and interactive methods during the teaching of students, mainly in the course of Polymer Chemistry. It is also important in this area, as it is in every field. The laboratory room is a place where students test their theoretical knowledge in practice. Chemistry is a complex science and we need to be able to explain it to students in a simple and easy way through various interactive and interactive lessons, using modern methods. Fundamental research performs not only prognostic, ontological, but also heuristic and methodological functions to reveal new aspects of the problem in the education system that need to be explored and to develop heuristic technologies and strategies for applied research.

In the context of information globalization, the enrichment of science with different information, a high degree of freedom to analyze and interpret information, like other disciplines, determines the sense of looking at the science of pedagogy from different angles, ie perspectives. An understanding of the course of polymer chemistry that is incompatible with its nature, and attempts to forcibly assimilate approaches, may also be overlooked. The main way to preserve the fundamental nature of this science is to clarify and correctly explain its methodology.

Why is the motivational method necessary for the course of polymer chemistry ?!

Motivation for everyone is a power and a power that inspires a sense of inner confidence that can empower you to take a bold step toward your goal. I believe that the most important result will be a good result if teachers and professors teach students using motivational methods during the course. These methods and integrative scientific methods have been tested in my own teaching activities.

According to the results of the new research, lessons are organized on the basis of interactive methods by introducing the content of the course and giving assignments to improve the overall skills of the student. The main purpose of this course is to acquaint students with current methods of spectroscopic analysis. They are used in a variety of analytical applications by studying and linking their performance, design, problems, and using the following methods with data:

- Instrumental integrative research methods;
- Analytical interactive methods;
- Methodology of analysis and thinking.

The result of science as a system of scientific knowledge and scientific activity is reflected in new scientific knowledge of theoretical and practical type. In general, the existence of truth and novelty is the most fundamental value for scientific knowledge. Science as a component of culture is based on a socio-cultural perspective, a specific historical and cultural context, develops in an axiological context; on the other hand. - serves as a basis for the development of science and culture.

Based on the need for a scientific and methodological basis for the integrated improvement of the course "Chemistry of Polymers" in the bachelor's degree program "Chemistry", which fully reflects the methodology of scientific and pedagogical research, the creative team provided textbooks, methods and manuals. was created. Because this science is complex, understanding a textbook can certainly be a little harder at the beginning. You will have to rely on philosophical and logical thinking in situations like this. According to pedagogical, methodological and scientific research, using the results of scientific research on the course of polymer chemistry, it

is possible not only to understand the essence of the course of polymer chemistry, but also to study the lessons intensively.

In conclusion, I can say that the educational process is always in need of innovation, new teaching and learning methods. A solution to this problem can be found mainly through the scientific research of university students and teachers. In teaching the science of polymer chemistry to young people on the basis of interactive, integrative scientific methods, which have become popular in recent years, it is necessary to conduct lessons with students, both collectively and individually.

By studying the scientific and methodological basis of the integrative improvement of the course "Polymer Chemistry" in the bachelor's degree program "Chemistry" in universities, we see both the quality of education and its level. Basically, it is necessary to conduct research in this area and use the power of modern technology, as well as to guide students in this regard. In the future, we intend to develop new methods in the field of polymer chemistry and to train mature and knowledgeable personnel through lessons based on each of the integrative scientific methods used in the further development of these fields in our country.

#### **REFERENCES:**

1. Askarov MA, Ismailov II Chemistry and physics of polymers. Tashkent, Uzbekistan, 2004.
2. Young, RJ (1987) Introduction to Polymers, Chapman & Hall ISBN 0-412-22170-5
3. Rashidova S.Sh., Nadjimutdinov NN, Usmanov TI Introduction to polymer chemistry. Tashkent. 2003.
4. <http://goldbook.iupac.org/>
5. "Glossary of Basic Terms in Polymer Science," IUPAC Recommendation [http://goldbook.iupac.org/src\\_PAC1996682287.htm](http://goldbook.iupac.org/src_PAC1996682287.htm)
6. <http://www.chemistry.com>
7. Нишонов, М. Ф., Юнусов, М. М., & Курбонова, Г. Р. (2020). ПРЕПОДАВАНИЕ ТЕМЫ «АЗОТНАЯ ПРОМЫШЛЕННОСТЬ» НЕТРАДИЦИОННЫМ МЕТОДОМ. Проблемы современной науки и образования, (12-2 (157)).



**ACADEMICIA**  
**An International**  
**Multidisciplinary**  
**Research Journal**  
 (Double Blind Refereed & Peer Reviewed Journal)



**DOI: 10.5958/2249-7137.2021.01110.1**

## CLINICAL SIGNS AND FREQUENCY OF POSTPARTUM ENDOMETRITIS IN BREEDING COWS

**Abdiev S.B\***

\*Senior Teacher,  
 Samarkand Institute of Veterinary Medicine,  
 UZBEKISTAN

### ABSTRACT

*The main factors causing postpartum endometritis in imported dairy cows in our country are the low level of feeding and housing conditions, lack of motivation, the incidence of this disease on farms is more common in spring and winter, complications of endometritis, increased service life of cows, several times of repeated intercourse, loss time, decreased milk production, untimely calving and even infertility after effective treatment of the disease, and the exclusion of cows after the third birth can cause significant economic damage to farms.*

**KEYWORDS:** *Breeding Cows, Endometritis, Purulent-Catarrhal, Infertility, Cervicitis, Ovarian Dysfunction, Trauma, Etiology, Opportunistic Microorganisms.*

### INTRODUCTION

The livestock breeders of the republic are faced with the urgent task of providing the population of our country with ecologically clean local food. To solve this problem, it is necessary to increase the herd population, prevent various diseases of the uterus and infertility of cows, increase milk production and reduce early weaning of cows. The main factors affecting the fertility of cows on dairy farms are congenital and postpartum diseases, as a result of which cows develop endometritis, cervicitis, ovarian dysfunction and others. [2,3,5,9,10,11].

Endometritis - is an inflammation of the lining of the uterus. Depending on the course of endometritis: acute, semi-acute and chronic, depending on the manifestation, it has a clear clinical sign and is latent. Acute endometritis can be catarrhal, purulent, purulent-catarrhal, fibrinous, necrotic and gangrenous, depending on the form of inflammation [6].

After childbirth, various microorganisms enter the genital tract and cause serious diseases of the genital organs. Microorganisms can enter the genitals in 2 ways: exogenous and endogenous [7].

Microorganisms enter the genitals when they help to give birth exogenously through the hands of an obstetrician, tools, dirty bedding and other objects. Microorganisms endogenously enter the genitals long before birth. These are saprophytes trapped in the uterus or vagina, and microorganisms prone to disease when the body's defenses are weakened[1].

In recent years, endometritis has become very common among cows, causing significant economic damage to dairy farms. The disease was diagnosed on average from 24.6% to 44% of cows[9]. In the Republic of Dagestan, the incidence of endometritis is recorded in 50% of pedigree cows of the Red Desert, about 30% in brown Caucasian and Swedish cows, in 10.5% in Simmental cows and in 9% in local cows[8].

A survey of existing cows on the farms of the Vologda and Vladimir regions revealed the incidence of acute postpartum endometritis in cows from 29.8% to 32.4%[9].

In the farms of the Krasnodar Territory, postpartum endometritis ranged from 5% to 40% among frequently infected cows at different times of the year[4].

Taking into account the above, the study of regional etiological factors causing postpartum endometritis among imported cows in the country, the degree of their occurrence and clinical signs is of great scientific and practical importance.

**Research purpose.** In connection with the above, the study of regional factors causing postpartum endometritis in imported cows in our country, the degree of their occurrence and clinical signs was carried out.

**Research object and methods.** Studies, including the study of regional factors, the degree of morbidity and research work related to the clinical signs of postpartum endometritis, were carried out in the "Feruzjon Boglari" of the Samarkand region and the district, the livestock farm "Farovon Grand Invest" in the Akdarya district, the livestock farm "Agro Gold Spring" in the Narpay district, the livestock farm "Utkir Chorvo Invest" in the Pakhtachinsky District.

The frequency of postpartum purulent endometritis in farms, the number of days after birth, the onset and symptoms of the disease, the etiology and pathogenesis of the disease were studied. Methods of obstetric and gynecological examination G.A. Cheremisinov and others, namely: time, quantity (ml), color, pH (medium), the consistency of the liquid secreted from the genital organs of cows; the clinical signs of the disease, urinary incontinence, and changes in posture were studied and diagnosed.

**Research results.** A study of the incidence of postpartum endometritis in 2020 in the Feruzjon Boglari farm of the Samarkand region and the district, the Farovon Grand Invest livestock farm in the Akdarya district, during a clinical examination of 47 cows that gave birth in winter, 9 of them revealed the presence of purulent catarrhal endometritis with clear clinical signs and this figure was 17.39% in a clinical examination of 37 cows that gave birth in the spring, 9 of which had purulent-catarrhal endometritis with obvious clinical signs, and 31.87% in a clinical examination of 22 cows that gave birth in the summer, 1 of them had purulent - catarrhal endometritis and this indicator was 4.54%, and during a clinical examination of 28 cows who gave birth in the fall, the presence of purulent-catarrhal endometritis was detected in 2 of them with obvious clinical signs and this indicator was 7.14%.



Similarly, in 2020, a clinical examination of 19 cows that gave birth in winter at the Agro Gold Spring farm in Narpay district of Samarkand region revealed the presence of purulent catarrhal endometritis in 4 of them, it was 21%, of 22 cows that gave birth in the spring underwent a clinical examination and 5 of them were diagnosed with purulent-catarrhal endometritis and it was 22.72%, 16 cows who gave birth in the summer were clinically examined, of which 1 had purulent-catarrhal endometritis and it was 6.25%, in 17 cows who gave birth in the fall during a clinical examination in 1 of them was found to have purulent-catarrhal endometritis with clear clinical signs at the beginning, and it was noted that it was 5.88%.

When examining 17 cows that gave birth in the winter months at the Utkir Chorvo Invest livestock farm in the Pakhtachinsky district, it was found that 3 of them have purulent-catarrhal endometritis, and it is 17.64%, with a clinical examination of 20 cows that gave birth in the spring months, 4 of them revealed the presence of purulent-catarrhal endometritis with obvious clinical signs, and it was found that it is 20%, during a clinical examination of 14 cows who gave birth in the summer months, 1 of them revealed the presence of purulent-catarrhal endometritis, which was 7.14%, a clinical examination of 15 heads of cattle that gave birth in the fall revealed the presence of purulent-catarrhal endometritis in 1 of them, which at first had obvious clinical signs, which amounted to 6.58%. Similarly, at the Utkir Chorvo Invest livestock farm in the same area, 17 cows that gave birth in the winter months were examined, of which 4 have purulent-catarrhal endometritis with obvious clinical signs, which amounted to 23.52%, a clinical examination of 16 cows that gave birth in the spring, revealed the presence of purulent-catarrhal endometritis in 5 of them, which was 33%, during a clinical examination of 12 cows that gave birth in the summer, the presence of purulent-catarrhal endometritis with clinical signs was revealed in 1 of them, which amounted to 8.33%, with clinical Examination of 13 cows that gave birth in the fall revealed the presence of purulent-catarrhal endometritis with clinical signs at the beginning in 1 of them, and this amounted to 7.69%.

During the seasonal analysis of the survey data obtained, it was noted that purulent-catarrhal endometritis with more pronounced clinical signs is more common in winter and spring. At the same time, in 2018, 84 cows were clinically examined that gave birth in the winter months from 4 farms, of which 15 (18.89%) cows, during a clinical examination, 91 cows gave birth in the spring of which 23 (26.40%) cows, during a clinical examination of 72 cows that gave birth in the summer, of which 6 (8.56%) cows, and during a clinical examination of 82 cows that gave birth in the fall, it was revealed that 5 (6.84%) cows were diagnosed with the initial stage of purulent-catarrhal endometritis and processes with clear clinical signs.

In cows, the processes of purulent-catarrhal endometritis were mainly acute and chronic, with the release of a grayish-white fluid from the uterus, mainly in most animals 5–6 days after birth. Mixed purulent discharge of caruncles and rotten fragments of the placenta from the uterus of some cows was observed when the animal strained, lay down or massaged the rectum with his hands, and in most cases the exudate hardened in the abdominal part of the tail. There was edema, redness and hemorrhage on the mucous membrane of the vagina and cervix, the exudate from the uterus was collected in the vaginal corridor, especially in front of the cervix, the cervical canal was opened 1-2 fingers wide.

When we examine the uterus through the rectum, the wall of the uterus becomes hollow, in some cases of a pasty consistency. Although the general condition of the cow was satisfactory, there was a decrease in the amount of milk. The animal walks and feeds with the general herd. The

general condition of the cow depends on the state of purulent-necrotic processes in the uterus, depending on the severity of the process, its general condition worsens, bends, weakens, begins to lose weight dramatically and the overall temperature rises to 1-1.5 ° C.

In pedigree dairy cows in the republic, the main factors causing postpartum endometritis are metabolic disorders and a decrease in immunobiological properties due to low nutritional levels and storage conditions and lack of mobility, as a result, opportunistic microorganisms enter the body through injuries of the uterus during childbirth. and cause the development of purulent-inflammatory processes 8-10 days (in some cases 3-6 days) after birth.

In recent years, the introduction of highly mechanized industrial technologies based on the standards of different countries for the storage and milking of pedigree livestock, some shortcomings in the design and construction of livestock buildings, increased the number of injuries and stress among animals and caused general discomfort. These stressful situations and general discomfort ultimately lead to a decrease in the resistance of animals and, as a result, the development of endometritis, cervicitis, ovarian dysfunction and other pathological processes in cows.

In many developed countries, postpartum endometritis is one of the leading obstetric and gynecological diseases, even among cows that are fed according to modern highly mechanized industrial technologies and are provided with modern veterinary services. The complications of the disease are severe; cows temporarily or permanently become infertile. Early diagnosis of the disease is not always achieved, and treatment does not give good results. In many farms, postpartum endometritis is poorly treated, and the treatment of animals is left to chance.

What complications are caused by untreated and effectively cured endometritis? The lifespan of the cows is increased. If a cow has a lifespan of 180 days, the farm will have to spend a lot of money, labor and time to heal that cow and mate it several times.

It is known that any disease that occurs in animals leads to a decrease in milk yield, which also causes great economic damage to the farm. If bacterial drugs, such as the tetracyclines group, are used to treat the disease, the economic damage increases again, as the economic damage caused by antibiotic use to dairy farms in developed countries averages 30% of farm profits. The cause of infertility, such as the inability to calve during similar economic losses and even after effective treatment of the disease, is exacerbated by the deregistration of cows after the third birth. If the deregistered cow was bought abroad, the economic damage to the farms will be even greater.

## CONCLUSION

1. The main factors that cause postpartum endometritis in dairy cows in our country are the low level of feeding and storage conditions, lack of motivation, leads to the ingestion of opportunistic microorganisms through lesions of the uterus during childbirth and the development of purulent-inflammatory processes due to metabolic disturbances. and a decrease in immunobiological properties.

2. In a clinical examination of 84 animals from farms, of which 15 cows (18.89%), in a clinical examination in the spring, 91 cows gave birth, of which 23 cows (26.40%), in a clinical examination of 72 cows that gave birth in the summer, of which 6 cows (8.56%) and in the fall, during a clinical examination of 82 cows that gave birth, it was revealed that 5 of them (6.84%)

were infected with the initial stage of purulent-catarrhal endometritis and processes with obvious clinical signs.

3. As a result of complications of untreated and effectively cured endometritis, prolongation of the life of cows, repeated intercourse several times, loss of time, reduced milk yield, not getting a calf on time and even the cause of infertility even after effective treatment of the disease, it was noted that deregistration of cows after the third birth will cause great economic damage to farms.

#### **LIST OF USED LITERATURE:**

1. Ata-Kurbanov Sh.B., Eshburiev B.M., Biotechnology of animal reproduction. Samarkand-2014.
2. Bagmanov, M.A. The effectiveness of the drug "ETD" in acute postpartum endometritis of cows / M.A. Bagmanov // Modern problems of veterinary obstetrics and biotechnology of animal reproduction: Proceedings of the International scientific practical conference dedicated to the 85th anniversary of the birth of Professor G.A. Cheremisinov. To the 50th anniversary of the establishment of the Voronezh school of veterinary obstetricians - Voronezh, "Istoki", - 2012.-P. 72-77.
3. Dyulger G.P. Differentiated hormone therapy of cows with follicular and luteal ovarian cysts under ultrasound control // Veterinary of agricultural animals. - 2010. - No. 6 - p. 32-42.
4. Ilyinsky E.V. On some aspects of the etiology of endometritis prophylaxis in cows / E.V. Ilyinsky K.G. Gabrilyan // Problems of obstetric-gynecological pathology and breeding of farm animals: Materials of scientific-practical. Conf, dedicated to the 100th anniversary of A.P. Studentsov-Kazan, 2003.-Part 1.-p161-165
5. Nezhdanov A.G., Lobodin K.A., Matyunin V.I. Follimag for the regulation of sexual cyclicity in cows // Veterinary medicine. - 2003. No. 5 - p. 32-34.
6. Polyantsev, N.I. Veterinary obstetrics, gynecology and reproduction biotechnology. / N.I. Polyantsev // Textbook for universities special literature. - St. Petersburg. Lan Publishing. 2015 - p. 244-300.
7. Kuldoshev O.Yu. Mavlonov S.I. Treatment of obstetric and gynecological diseases of cows. // "Zoo veterinary", No. 10.-p.33-34.2012.
8. Khmylov, A.G. Endometritis - etiology and modern therapy / A.G. Khmylov, F.S. Kirzhaev // Veterinary Medicine. - 2009.-№3-p. 6-8.
9. Khanmagomedov S.G. Cattle / S.G. Khanmagomedov, S.G. Karaev, Ya.D. Jalalov and others // Breeds of farm animals and birds bred in Dagestan. - Makhachkala, 2002-p. 9.
10. Chomaev A.M., Varenikov M.V. Progestogens for ovarian dysfunction in first-calf heifers // Veterinary Medicine. - 2003. - No. 3. - P. 38-39. (3, 5, 9, 10, 11)
11. Cheremisinov G.A. Development and improvement of hormonal methods of regulation and stimulation of the reproductive function of cows // Dissertation of Doctor of Veterinary Sciences. Voronezh. : 1975. -- 338 p..

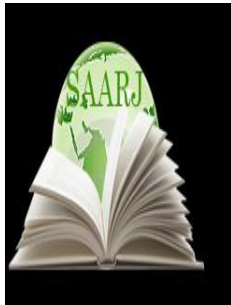

**ACADEMICIA**  
**An International  
 Multidisciplinary  
 Research Journal**  
 (Double Blind Refereed & Peer Reviewed Journal)



**DOI: 10.5958/2249-7137.2021.01111.3**

## PREDICATIVITY AND INTONATION AS THE MAIN GRAMMATICAL FEATURES OF THE SENTENCE

**Elvira Narbekova\*; Khurshid Khayrullayev\*\***

\*Master student,  
 Navoi State Pedagogical Institute,  
 UZBEKISTAN

\*\*Professor,  
 DSc, Samarkand State Institute of Foreign Languages,  
 UZBEKISTAN

### ABSTRACT

*The sentence is traditionally defined as the expression of a complete thought. But this seems to be open to thought and discussion because completeness is, in fact, very relative and depends largely on the purpose of the speaker or writer as well as on the context, linguistic or situational. This article is dedicated to the study of the sentence and its main grammatical features: predicativity and intonation.*

**KEYWORDS:** *Sentence, Predicativity, Intonation, Declarative Sentence, Interrogative Sentence, Imperative Sentence, Exclamatory Sentence.*

### INTRODUCTION

The traditional definition is that a sentence is a group of words expressing a complete thought is to-day often criticised on the ground that a sentence is sometimes one word and that the thought is not always complete but largely depends on the meaning of preceding sentences.

Some recent writers have attempted to make "utterance" do the work of the classical term "sentence". But this does not seem fully justified because the two terms belong to different planes, one historical and the other linguistic.

The dissatisfaction with the term seems to result from the fact that accurate studies of syntax distinguishing what is grammatically self-contained in writing, and what are the corresponding structures in actual speech, have not yet been made. This deserves special systematic description.

The sentence is the immediate integral unit of speech built up of words according to a definite syntactic pattern and distinguished by a contextually relevant communicative purpose. Any coherent connection of words having an informative destination is effected within the framework of the sentence. Therefore, the sentence is the main object of syntax as part of the grammatical theory. [1]

The sentence, being composed of words, may in certain cases include only one word of various lexico-grammatical standing.

Cf.: *Good! Look! Thanks! Away! Why? Certainly.*

The actual existence of one-word sentences, however, does not contradict the general idea of the sentence as a special syntactic combination of words, the same as the notion of one-element set in mathematics does not contradict the general idea of the set as a combination of certain elements. While the word is a component element of the word-stock and as such is a nominative unit of language, the sentence, linguistically, is a predicative utterance-unit. It means that the sentence not only names some referents with the help of its word-constituents, but also, first, presents these referents as making up a certain situation, or, more specifically, a situational event, and second, reflects the connection between the nominal denotation of the event on the one hand, and objective reality on the other, showing the time of the event, its being real or unreal, desirable or undesirable, necessary or unnecessary, etc.

A sentence is a unit of speech the grammatical structure of which conforms to the laws of the language and which serves as the chief means of conveying a thought. A sentence is not only a means of communicating something about reality but also a means of showing the speaker's attitude to it. And it possesses the following properties:

- The sentence as a linguistic expression of extralinguistic reality must be actualized. Actualization of the sentence content makes predicativity an inseparable property of every sentence.
- The sentence, just like any other meaningful language unit, has a form. Every sentence has an intonation pattern.

The function of the sentence is to model some fragment of the world. This model should be referred to the original, to a fragment of the world. It means that a sentence is to be referred to reality. This property of sentence was first proposed and described by V.V. Vinogradov in the late 1930s. V.V. Vinogradov named this feature predicativity and showed that predicativity means reference of the content of the sentence to reality indicating its time in relation to the moment of speech, the degree of probability of the fact described in the sentence, and its relation to the participants of communication. [2]

## **METHODS**

The sentence differs from the word-group by its relatedness to objective reality – predicativity. Every sentence shows the relation of the statement to reality from the point of view of the speaker. [3]

There are three approaches to the interpretation of predicativity:

- semantic approach interprets predicativity as a reference to a certain situation of objective reality;
- logical – interprets predicativity as reference to a proposition, which is the main form of thought;
- formal-syntactical approach rests on the interpretation of predicativity as subject-predicate relations. There is no contradiction between the suggested interpretations of predication. Each of them deals with a separate side of one and the same phenomenon.

The communicative function of the sentence distinguishes it from phrases and words, which have one function – naming.

*E.g. 1) The doctor's arrival.*

*2) The doctor has arrived.*

Both examples consist of the same lexemes and render the information about one and the same person and his action. Nevertheless, there is a fundamental difference between them. The 1st example does not express an event, which refers to a particular time. The 2nd example expresses an actual fact, which refers to the past. Grammatically the 2nd example is characterized by the categories of tense and mood, by means of which this structure refers to objective reality. Thus, the 1st example is a non-predicative word-group and the 2nd example – a sentence. The correlation of the thought expressed in the sentence with the reality situation of speech is called predicativity.

The functional essence of predication has hitherto been understood in linguistics as the expression of the relation of the utterance (sentence) to reality, or, in more explicit presentation, as the expression of the relation between the content of the sentence and reality. This kind of understanding predication can be seen, for instance, in the well-known "Grammar of the Russian Language" published by the Academy of Sciences of the USSR, where it is stated that "the meaning and purpose of the general category of predication forming the sentence consists in referring the content of the sentence to reality". [4] Compare with this the definition advanced by A. I. Smirnitsky, according to which predication is understood as "referring the utterance to reality". [5]

Predicativity is also expressed by intonation, which is the essential feature of the sentence as a unit of speech.

In written language a sentence is a string of words standing between an initial capital letter and the mark of punctuation at the end while in spoken language a sentence is marked by special intonation. [6]

Intonation is the combination of pitch, stress and juncture with which an utterance is spoken. [7]

Being a unit of speech, the sentence is intonationally delimited. Intonation separates one sentence from another in the continual flow of uttered segments and, together with various segmental means of expression, participates in rendering essential communicative-predicative meanings (such as, for instance, the syntactic meaning of interrogation in distinction to the meaning of declaration). The role of intonation as a delimiting factor is especially important for sentences which have more than one predicative center, in particular more than one finite verb.

Cf.: 1. *The class was over; the noisy children filled the corridors.*

2. *The class was over. The noisy children filled the corridors.*

Special intonation contours, including pauses, represent the given speech sequence in the first case as one compound sentence, in the second case as two different sentences (though, certainly, connected both logically and syntactically).

## DISCUSSION

The structural types of sentences do not have connections with any special meanings. Yet if we take a sentence and start changing its structure, we may observe that the sentence received as a result of transformations possess some common and altering meanings.

Cf.: John will come tomorrow.

Will John come tomorrow?

Come tomorrow, John!

Comparing these sentences, we can see that all of them describe one and the same event – John's arrival at a certain place. But the first sentence presents this event as a fact that is to happen, and the speaker INFORMS the listener about it. The second sentence shows that the speaker wants to know if the event will become a fact and ASKS the listener to confirm or to negate it. The third sentence also shows that the speaker demands something of the listener, this time that the listener should do so that the event should become a fact. The difference of meanings corresponds to the difference of the form of the sentences. It means that we observe here an opposition of forms reflecting a certain meaning, which corresponds to the idea of a grammatical category. The semantic basis of the category or in other words its categorical meaning is the speaker's influence upon the listener. This basis corresponds to the illocutionary meaning of speech acts. If we compare these meanings with the illocutionary classes, we can see that they reflect two most frequent classes – in formatives and directives. The first sentence embodies the informative type of speech acts and is called declarative. The other two belong to the directives and formally differentiate direction for an action (the third sentence) and has the name of imperative or direction for a special type of action – informing the speaker (the second sentence) and is termed interrogative.

A declarative sentence states a fact in the affirmative or negative form. It is generally pronounced with a falling intonation.

*Charles Dickens was born at Landport, Portsmouth. (Laing)*

*They don't want anything from us – not even our respect. (Douglas)*

An interrogative sentence expresses a question, i.e. a request for information. It is connected with an answer, forming together a dialogue unity.

There are four kinds of questions:

- a) General questions
- b) Special questions
- c) Alternative questions

d) Disjunctive questions.

a) General questions require the answer *yes* or *no* and are spoken with a rising intonation. They are formed by placing part of the predicate, i.e. the auxiliary or modal verb before the subject of the sentence.

*Do you like painting?*

*Can you speak German?*

b) Special questions begin with an interrogative word and are spoken with a falling intonation. The order of words is the same as in general questions, but the interrogative word precedes the auxiliary verb.

*Where do you study?*

When the interrogative word is the subject of the interrogative sentence or an attribute to the subject, the order of words is that of a statement, i.e. no inversion is used.

*Who lives in this room?*

*Whose book is on the desk?*

c) Alternative questions indicate choice and are spoken with a rising intonation in the first part and a falling intonation in the second part.

*Do you live in town or in the country?*

e) Disjunctive questions require the answer *yes* or *no* and consist of an affirmative statement followed by a negative question, or a negative statement followed by an affirmative question. The first part is spoken with a falling intonation and the second part with a rising intonation.

*You speak English, don't you?*

*You are not tired, are you?*

An imperative sentence serves to induce a person to do something, so it expresses a command, a request or an invitation. As Hall stated that imperative sentence commands and requests use the simple form of the verb without any stated subjects. [8]

Commands are characterized by a falling tone.

*Come to the blackboard!*

*Stop talking!*

Requests and invitations are characterized by a rising intonation.

*Open the door, please!*

*Do come to see me tomorrow.*

An exclamatory sentence expresses some kind of emotion or feeling. It often begins with the words *what* and *how*, it is always in the declarative form, i.e. no inversion takes place. It is generally spoken with a falling intonation.



*What a lovely day it is!*

*How wonderful!*

## CONCLUSION

The sentence is the smallest unit of speech that expresses a thought, both orally and in writing. In oral form, the sentence pronounced by the sound up and down and hard soft, interrupted by pauses, and ended with a final intonation followed by a silence that prevents sound assimilation or fusion or other phonological processes. In the form of writing, a sentence begins with a capital letter and ends with a dot (.), question mark (?), or an exclamation mark (!), And in it can be included punctuation such as a comma (,), colon (:), split (-), and spaces.

The center of predication in a sentence of verbal type (which is the predominant type of sentence-structure in English) is a finite verb. The finite verb expresses essential predicative meanings by its categorical forms, first of all, the categories of tense and mood (the category of person, as we have seen before, reflects the corresponding category of the subject). However, proceeding from the principles of sentence analysis worked out in Russian school of theoretical syntax, in particular, in the classical treatises of V.V. Vinogradov, we insist that predication is effected not only by the forms of the finite verb connecting it with the subject, but also by all the other forms and elements of the sentence establishing the connection between the named objects and reality, including such means of expression as intonation, word order, different functional words. Besides the purely verbal categories, in the predicative semantics are included such syntactic sentence meanings as purpose of communication (declaration – interrogation - inducement), modal probability, affirmation and negation, and others, which, taken together, provide for the sentence to be identified on its own, proposemic level of lingual hierarchy.

## REFERENCES

1. Blokh M.Y. Theoretical Grammar of the English Language – M. 1983. – p. 236
2. Vinogradov V.V. Grammar of the Russian language. – M. 1960. –p. 80
3. M. A. Ganshina and N. M. Vasilevskaya. English grammar. Moscow, 1964. – p. 321
4. Academy of Sciences of the USSR “Grammar of the Russian Language” – M. 1960. V. 2. – pp. 79-80
5. Smirnitsky A.I. Syntax of the English language. – M. 1957. – p. 102
6. Fromkin, V., Rodman, R. & N. Hyams (2003), An Introduction to Language. 7th edition. USA, Thomson: Heinle.
7. Frost, R. (1975). The way of language: an introduction. New York: Harcourt Brave Jovanovich, Inc. 238
8. Hall, Eugene J. 1992. Grammar for Use: A Realistic Approach to Grammar Study for Immediate and Practical Application. USA: VoluntadPublisher, Inc.

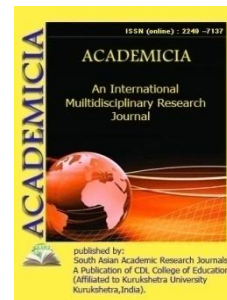
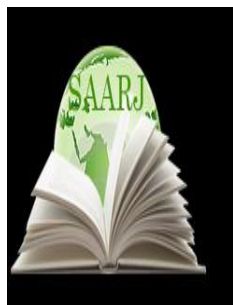

DOI: **10.5958/2249-7137.2021.01112.5**

## FACTORS IN THE DEVELOPMENT OF LOGICAL THINKING IN MATHEMATICS LESSONS

**B.H. Eshpulatov\***; **B.T. Karamatov\*\***; **G.SH. Ashurova\*\*\***;  
**D.SH. Gafforova\*\*\*\***; **G.M. Turlibaeva\*\*\*\*\***

<sup>1,2,3,4,5</sup>Teacher,

Navoi State Pedagogical Institute,  
UZBEKISTAN

### ABSTRACT

*This article describes the views formed on the basis of science and experience aimed at developing independent thinking and creativity in students in the educational process. In this regard, it can be said that the teaching module of the subject in the education system: educational-methodical complex, electronic educational-methodical complex (syllabus), glossary in many respects has the ability to provide students with a variety of additional information. Such cases are quite common in the interpretation of data types and additions, data classifications. This is probably necessary for transition textbooks, but they cannot be justified from a mathematical and didactic point of view. Therefore, such withdrawals should be phased out of textbooks.*

**KEYWORDS:** *Educational-Methodical, Necessary*

### INTRODUCTION

Achieving our great goals and noble intentions today, the renewal of our society, the development and prospects of our lives, the ongoing reforms, the effectiveness of our plans, the fate, first of all, depends on the problem of training highly qualified, intelligent, independent thinking and creative professionals. The role of pedagogical-mathematical knowledge in the formation of the younger generation as a mature and harmoniously developed person is invaluable.

Significant changes and restructuring in the education system remain a vital necessity to nurture a creative, active, independent-minded individual. Therefore, radical changes in education, the

creation of a scientific basis for the training of active, creative, intelligent, intelligent professionals are becoming an urgent task of a number of disciplines, including mathematics.

Also, one of the most important issues facing the world of pedagogy and mathematics today is the search for ways, means and means of forming an independent thinking person who is not only knowledgeable but also logically thinking.

If we look at the history, our thinkers who have lived and worked in our country, in their time, have put forward important ideas on what methods and means of teaching should be used in the education of independent-minded, creative people. In particular, the encyclopedic scholar Abu Rayhan Beruni in his works focuses on these issues and explains which aspects should be paid more attention in education in order to develop the personality and thinking of the student. In particular, Beruni emphasizes that in teaching it is important not to memorize, but to understand, to think logically, to draw conclusions.

Based on the above, it is possible to identify the following current problems facing the science of mathematics in the education of an independent-minded, logical-minded person in the educational process today:

- Mathematical methods (methods, forms), tools, methods that can meet the modern requirements of the process of education (formation) as a person in educational institutions, enriching them with new content, dialogic, innovative (innovation-based), cooperation with the teacher from the monologue teaching system transition to new types of education, such as harmonization of student activities);
- revision of the curriculum, syllabus for teaching students and textbooks, manuals, developments, lecture notes based on them, taking into account the achievements of modern mathematics;
- The formation of thinking in students in the educational process, teaching them to think logically, to achieve the formation of critical thinking;
- organization of activities of talented students in educational institutions, ensuring their diversity of logical tasks and the formation of their ability to perform them, understanding the existence and continuity of elements of logical thinking, directing students to perform non-standard tasks;
- Education should be built on the basis of active methods, so that the teacher-student cooperation takes precedence. Ensuring that active, independence-oriented teaching methods and forms, such as tests, debates, business games, complex pedagogical problems, heuristics, training, psychodrama, puzzles, brainstorming, logical problem solving, and problem-solving, become the basis of education.

In the organization of education in this area, the correct choice and application of teaching methods, improving the quality of education, the education of an independent thinker in the educational process, the following have risen to the educational center:

- Cognitive - is an educational activity that leads a person to the process of thinking, encourages cognitive activity to enter into the essence of a vague, unknown new elemental problem and directs to solve it, and leads to the growth of knowledge and information, individual consciousness, creativity and intellectual development;

- Dialogic learning - ensuring the interest of each learner not only by activating learners, but also by creating a creative environment and providing an exchange of ideas by discussing the topic or problem in a group setting with the teacher. Through this the learner becomes the subject of the learning process from its object;
- Consciousness - the ability to demonstrate a conscious attitude to the learning process, to draw inductive conclusions through the thought process of the given task or tasks.
- Problem-based learning - teaching students to solve problems and situations

Naturally, the above criteria allow students to think independently and freely, to be active and analyze their own point of view, providing them with the opportunity to take the initiative, knowledge and make full use of their intellectual potential.

Based on the above, the main directions of educating an independent-minded, logical-minded person in the educational process today can be identified as follows:

- "Industrialization of education", ie the strengthening of the intellectual activity of modern youth on the basis of computerization and technology;
- Transition from the most prevalent forms of education to the methods and forms of active learning. This direction is the transition from the "school of memory" to the "school of understanding", the "school of thinking";
- Transition from strictly defined control methods in the organization and management of the educational process to developmental, activating, improving methods and game methods. This creates an opportunity to support and develop the organizational-creative, independent activity of students;
- organization of interaction between the student and the teacher, ie ensuring the participation of students as a joint team activity. In this case, the main emphasis is shifted from the teacher's "teaching" activities to the student's "learning" activities.

It should be noted that today many textbooks and manuals are being prepared in a content aimed at developing students' independent thinking and creativity. In particular, curricula and textbooks in the general education system, developed in accordance with state educational standards, are based on the criteria and scientific principles set out in the Law "On Education" and the "National Training Program". Clearly, they are composed of materials in the context of things and events related to the student's lifestyle and daily life, designed for the level of psychological development of learners at each age stage.

Both the step-by-step sequence in the teaching of new textbooks and assignments, the ways in which the practice of developing students' mental activity in each subject becomes more complex, and the process of learning begins with active observation and ends with practical application. fully compatible with cognitive psychodidactic foundations. Clearly, the consistent application of such a method of education in practice, gaining experience in this area requires correction, supplementation and clarification.

To do this, we can first list the following methods and techniques aimed at solving the tasks facing the system of continuing education:

- One of our most important tasks is to popularize the method of verbal cognitive education (a new pedagogical technology of education today) among teachers. Because unless teachers learn to use modern pedagogical technologies, computer technology, and the practical use of visual aids to apply this method, they will not be able to achieve effective results in this area;

- In order to increase the effectiveness of textbooks and teaching methods, students must be provided with additional sources of information, which currently include textbooks, Internet data, electronic resources, student memory, daily life, other subjects, and inquiries from others. That's definitely not enough. Therefore, teachers must be provided with an encyclopedic reference, a variety of information (explanatory information, logical situational issues, pictorial materials, etc.) that combines the riches and capabilities of science and can convey them to learners. In this regard, it can be said that the teaching module of the subject in the education system: educational-methodical complex, electronic educational-methodical complex (syllabus), glossary in many respects has the ability to provide students with a variety of additional information. In addition, this would drastically reduce the current size of the textbooks, which would basically consist of an algorithm of assignments to study each topic (think creatively and create something within each topic). Of course, this is a big deal. But whether we have stepped into the method of verbal cognitive education and set ourselves the goal of nurturing a creative and independent-minded person, we have no choice but to do so. Without them you will not achieve our goal;

- In our opinion, in some of the current textbooks, "looking back" - it seems out of the norm to first rely on previous scientific interpretations and then deny or update them. Such cases are quite common in the interpretation of data types and additions, data classifications. This is probably necessary for transition textbooks, but they cannot be justified from a mathematical and didactic point of view. Therefore, such withdrawals should be phased out of textbooks. To do this, it seems necessary to reconsider the curriculum and textbooks of the primary grades in the entire education system, especially in secondary schools. The main factor in this is purely pragmatic - as shown in the program, the scientific knowledge that is not necessary for mass practical application is redundant for students, especially students of a young age;

- Do we think that in some textbooks it is necessary to give comments with the comment "learn", which completes the study of each topic, which is sometimes encountered, and the essence of which serves to check the independent conclusion of the learner ?! In this case, the reader prefers to read what is ready rather than invent it! In essence, these "learns" are answers and solutions to examples and problems in mathematics. So we think that if these, too, were too concise and given at the end of the textbook, it would have encouraged the children to search more independently;

- Tests are given in textbooks, especially in the repetition sections. These tests, on the other hand, are far from cognitive and verbal, they are more retroscopic and receptive in nature. It's time to think and research on the creativity of these tests. To this end, it would be expedient to increase the number of questions and assignments required for our own old, oriental tests, or 'competition of the talents', which are partially reflected in the textbooks.

In conclusion, the above-mentioned ideas are the views formed on the basis of our scientific and life observations aimed at developing the ability of students to think independently and creatively in the educational process. However, in our opinion, such issues have a special place

in the educational process in the formation of students' ability to think independently and in the development of a creative personality.

**REFERENCES:**

1. Law of the Republic of Uzbekistan "On Education"
2. National training program.
3. Qosimov F.M. Non-standard assignments. // «Primary education», T., issue 9. 2007.
4. Djurakulova A.X. The importance of non-standard issues in shaping students' abilities. // «Social sciences in Uzbekistan», T., Academy of Sciences of the Republic of Uzbekistan, 2011, issues 1-2.

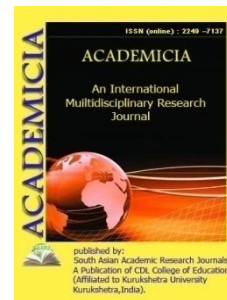
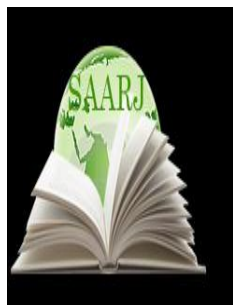

DOI: **10.5958/2249-7137.2021.01113.7**

## IMPROVEMENT OF IRRIGATION REGIME OF COTTON VARIETIES DEPENDING ON SOIL AND CLIMATE CONDITIONS OF THE REPUBLIC OF KARAKALPAKSTAN

**Mambetnazarov Bisenbay Satnazarovich\***; **Oteuliev Jaksilik Begdullaevich\*\***

\*Professor,  
Doctor of Agricultural Sciences,  
Karakalpak State University, UZBEKISTAN

\*\*Assistant of Karakalpak State University,  
UZBEKISTAN

### ABSTRACT

*In the conditions of the southern zone of the Aral Sea region, a water-saving and optimal irrigation regime has been developed for medium-fibrous cotton varieties "S-4727", "Sulton" and "Chimboy-5018". Comparative analysis showed that a high yield of cotton variety "Sulton" was achieved with soil before irrigation at a moisture level of 80-80-60% of LCMF and an irrigation rate of 650-800 m<sup>3</sup> / ha and an irrigation rate of 3500 m<sup>3</sup> / ha. At the same time, the yield of cotton was 31.2-32.6 c / ha.*

**KEYWORDS:** Cotton, Fibers, Irrigation Scheme, S-4727, Chimboy-5018, Sulton, LCMF, Raw Yield, Meadow–Alluvial, Moisture, Soil;

### INTRODUCTION

There has been a water shortage in Karakalpakstan for the last 5-6 years. In years of water scarcity, the water supply of agricultural crops is 30-40% and in many areas leads to a decrease in crop yield and quality. Therefore, the area of saline lands in irrigated lands is expanding as a result of anthropogenic impacts.

In the current context of global and local climate change, one of the urgent tasks is to improve the demand for water in agriculture, to conduct research to take into account natural and climatic conditions in determining the impact of external factors on soil properties

In the irrigated lands of the republic, comprehensive measures are being taken to ensure the efficient use of water resources and increase the yield of cotton. Therefore, the Decree PF 5748

of June 17, 2019 "On measures for the efficient use of land and water resources in agriculture" and other regulations related to this activity to some extent serve the implementation of the tasks.

**Research methods:** All observations, measurements, calculations and analyzes were carried out on the basis of the techniques [1-3]. In all variants, in order to determine the minimum moisture capacity of the field before irrigation, in early spring, a trial plot measuring 1.5x1.5 was laid on the plots. The duration and rate of irrigation was determined by taking soil samples at each site (0-50 cm before flowering, 0-70 cm during flowering and 0-50 cm during cotton opening) from each 10 cm layer to determine moisture content by drying in a thermostat within 6 hours and subsequent weighing on the scales. The amount of water used for irrigation was determined using 50 cm wide Chipoletti water meters.

**Experimental results:** Field experiments In 2018-2020, in the meadow-alluvial soils of the northern and southern regions with a groundwater level of 2-3 m, the irrigation regime of medium-fiber cotton varieties "S-4727", "Chimboy-5018" and "Sultan" was studied and the effect on yield was determined.

According to scientific research, in the northern region of the Republic of Karakalpakstan, the yield of cotton varieties "S-4727", "Chimboy-5018" and "Sultan" with an average soil moisture of 70-70-60% of ChDNS in 2018 averaged 25.3 ts / ha of S-4727. In 2019 and 2020 it was 27.1 and 26.9 ts / ha, respectively.

**TABLE 1 IMPACT OF IRRIGATION SYSTEM ON COTTON YIELD (2018-2020)**

Op t. s/n	Pre- irrigation soil moisture relative to ChDNS, %	Cott on vari eties	Northern region				Southern region			
			Irriga tion syste m	Season al irrigati on rate, m3 / ha	The averag e yield in three years is ts / ha	Addit ional yield, ts / ha	Irriga tion syste m	Seaso nal irrigati on rate, m3 / ha	The averag e yield in three years is ts / ha	Addit ional yield, ts / ha
1	70-70-60	C- 472 7	0-2-0	2129	26,4	± 0,0	1-2-0	2856	27,2	± 0,0
2	80-80-60	-//-	1-3-0	2952	27,4	+ 1,0	1-4-0	3559	28,9	+ 1,7
3	70-70-60	Chi mbo y- 501 8	0-2-0	2221	28,7	+ 2,3	1-2-0	2918	29,3	+ 2,1
4	80-80-60	-//-	1-3-0	2826	30,0	+ 3,6	1-4-0	3891	30,9	+ 3,7
5	70-70-60	Sult an	0-2-0	2145	30,3	+ 3,9	1-2-0	2864	31,5	+ 4,3
6	80-80-60	-//-	1-3-0	2928	31,2	+ 4,8	1-4-0	3430	32,6	+ 5,4

With the transition of soil moisture to 80-80-60% relative to ChDNS, an increase in cotton yield was observed and 26.8 per cent, respectively; 27.6; The yield was 27.9 ts / ha.



It should be noted that in all cotton varieties studied, the highest yield of cotton was observed when the soil moisture before irrigation was 80-80-60% of ChDNS, while relatively good results were obtained in the variety "Sultan"

In the Chimboy-5018 variety, when the soil moisture was 70-70-60% relative to the ChDNS, an average yield of 28.7 t / ha per hectare was obtained in 3 years, or 2.3 t / ha more than in the S-4727 variety. It was found that with an increase in soil moisture from 70-70-60% to 80-80-60%, the cotton yield increased by 3.6 ts / ha.

Cotton yield of "Sultan" variety when soil moisture is 70-70-60% from ChDNS 2018-31,2; 2019 y-30.4 and 2020 y-29.3 ts / ha, or an average of 30.3 ts / ha in 3 years, which is 1.6 ts / ha higher than the navigation "Chimboy-5018".

However, with an increase in soil moisture relative to ChDNS by 80-80-60%, the yield per hectare in 2018, 2019 and 2020 was 33.1, respectively; 29.4 and 31.0 ts / ha, ie an average of 31.2 ts / ha in 3 years, and an additional cotton yield of 4.8 ts / ha compared to the standard navigation. Compared to the Chimboy-5018 navigation, the additional cotton yield was 1.2 ts / gani. According to the level of yield of cotton varieties can be placed in the following order: "Sultan" (29.4-33.1 ts / ha), "Chimboy-5018" (29.7-30.3 ts / ha) and "S-4727" ( 26.8-27.9 ts / ha)

Irrigation regimes of these varieties at optimal times, depending on the biological characteristics of cotton varieties, climatic conditions, allowed to obtain high yields.

Medium-fiber varieties of cotton "S-4727", "Chimboy-5018" and "Sultan" in 2018-2020, the grassland-alluvial soils of the southern region, the groundwater level is 2-3 m. Irrigation system was studied and its effect on productivity was determined.

Yields of cotton varieties studied in the southern region are irrigated in 1-2-0 systems per year when irrigation is carried out in the order of 70-70-60% relative to soil moisture, with irrigation norms of 910-1075 m<sup>3</sup> / ha and seasonal irrigation norms of 2800-3015 m<sup>3</sup> / ha. Yield on cotton variety "S-4727" averaged 26.1-27.8 t / ha, on variety "Chimboy-5018" 28.4-30.0 t / ha and on variety "Sultan" 31.0-31 , Was 9 ts / ha.

Irrigation rate was 640-890 m<sup>3</sup> / ha and seasonal irrigation rate was 3350-3930 m<sup>3</sup> / ha when pre-irrigation soil moisture was carried out at 80-80-60% humidity relative to ChDNS and required 5 times irrigation, irrigated in 1-4-0 system. . In the above irrigation regime, the average yield of S-4727 cotton was 28.9 ts / ha in three years, Chimboy-5018 - 30.9 ts / ha and Sultan - 32.6 ts / ha

This means that cotton varieties require a 1-4-0 system of irrigation in the southern region of Karakalpakstan, and require an additional one or two times irrigation compared to cotton varieties grown in the northern region.

## CONCLUSIONS

In all the cotton varieties studied in the northern and southern regions of the Republic of Karakalpakstan, the highest cotton yield was observed when the soil moisture before irrigation was 80-80-60% relative to ChDNS, while relatively good results were obtained in the Sultan variety with high yields. In the southern region, the periodic irrigation rate is 600-700 m<sup>3</sup> / ha, the total irrigation rate is 2800-3500 m<sup>3</sup> / ha and requires irrigation in the 1-4-0 system, i.e. the

irrigation regime of cotton varieties is recommended to be irrigated one or two times more than in the northern region.

**REFERENCES:**

1. Авлиёкулов А.Э. Гидромодульное районирование и режим орошения культур хлопкового севооборота при интенсивном ведении их в Сурхан-Шерабадской долине. Изд-во “Меҳнат”, Тошкент, 1992. С.120-135.
2. Беспалов Н.Ф., Авлиёкулов А.Э., Ёдгоров А.Х. Ғўзани суғориш.-Тошкент: Фан.1984.-48-52.
3. Методика полевых и вегетационных опытов с хлопчатником. – Ташкент, Изд.4, 1973. – С. 1-225
4. Шамсиев А.С. Влияние климатических показателей на водопад рябленые хлопчатника “Актуальные вопросы науки. XVIII Международной научно-практической конференции. Москва, 2015. С. 61-62.

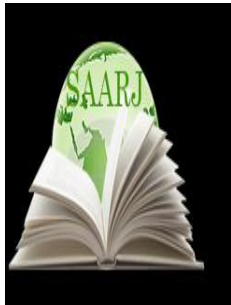

**ACADEMICIA**  
**An International  
Multidisciplinary  
Research Journal**  
(Double Blind Refereed & Peer Reviewed Journal)

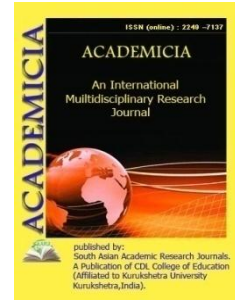

DOI: **10.5958/2249-7137.2021.01114.9**

## **THE IMPORTANCE OF INTEGRATED LESSONS IN PRIMARY EDUCATION**

**B. A. Mavlonov\* ; Jamshid Esirgapov\*\***

\*Teacher,  
Jizzakh State Pedagogical Institute,  
UZBEKISTAN

\*\*Master's Student,  
Jizzakh State Pedagogical Institute,  
UZBEKISTAN

---

### **ABSTRACT**

*In the integrated lessons, taking into account the didactic and psychological requirements, a well-thought-out system of tasks of varying complexity is developed through group work in specially organized individual and separate groups within a particular subject. Mastering the topic requires certain pedagogical conditions. Under such conditions, education progresses.*

**KEYWORDS:** *Modern Education, Integrated Learning, The Importance Of Integrated Lessons, Modern Pedagogical Technologies, Integrated Course.*

---

### **INTRODUCTION**

The future of our country will largely depend on the innovative changes in the field of education, the level of work aimed at raising it to a level that meets the new requirements of our time. This requires the training of future professionals in a competitive manner, taking into account the requirements of the times.

In the modern education system, the organization of the educational process in a certain coherence and interconnectedness of the content and objectives of general subjects, along with improving the quality and effectiveness of education, expands the worldview of students and their serves to enrich the world of thought with bright images. The possibilities of interdisciplinary communication are endless in optimizing the content and scope of education, enriching the learning process with modern pedagogical technologies and information and communication technologies, embodying the content of education in the minds and thinking of young people through life images.

## THE MAIN FINDINGS AND RESULTS

That is, the organization of integrated lessons in primary education is a feature of the lesson, in which two or three and sometimes more teachers can participate. Is such an integrated education easy or difficult? Much depends on the teachers. However, it is important to remember that the lesson is an important part of the job. It is through the course that the key issues are addressed in an integrated course, and the outcome can be successful or unsuccessful. However, the concept of integrated learning remains controversial. What are the hallmarks of an integrated lesson?

1. The integrated course itself is a new complex unit, in a completely different form, and focused on solving problems clearly and effectively.
2. They are planned on the basis of two or three disciplines. Therefore, several teachers or several teaching materials are combined mechanically.
3. Skills and competencies will be developed in ways to stimulate interest in learning.

The purpose of the integrated lesson is to develop students' creative interests, aspirations and creative thinking. Integrated lessons take many forms, depending on the tasks assigned to teachers and students.

In peer review classes, couples and couples work together. This requires students to be well-prepared. All activities require an objective and accurate assessment.

The creative research class focuses on students solving independent problems. These processes increase students' cognitive, conscious learning, and effectiveness. The main feature of an integrated lesson is that such a lesson is based on one subject, it is the main focus, the rest are integrated with it, and it is used to understand the meaning of science in the study of its relationships and processes, to apply the acquired knowledge in practice.

Integrated learning outcomes are reflected in the development of teachers' creative disciplines. Interdisciplinary integration is not about showing how many subjects are related to each other, but about giving students an idea of the integrity of the world around us through integrated learning. Scientists say that integration accelerates the formation of the learner's worldview

Another important quality of a future primary school teacher is that he / she organizes educational activities on the basis of the principles of interdependence of primary and secondary education subjects and the principles of interdependence of primary education subjects. There are many problems in the work of primary school teachers in urban and district schools today, including shortcomings in the use of non-traditional teaching methods in the teaching of private subjects in primary education; inaccuracies in the assessment of students' knowledge; inability to feel the psychological state of students and, as a result, not be able to motivate them to the learning process; inability to ensure interdisciplinary communication in the learning process; there are cases of non-compliance with didactic principles due to a lack of understanding of their essence. Without a positive solution to these problems, it is impossible to talk about the quality and effectiveness of education in the primary grades.

The experience of pedagogical activity is absorbed through the teaching, upbringing and development of each learner through the acquisition of scientifically based, specially selected and somewhat structured knowledge, skills and competencies. This experience is passed on by educators and the structure of learners is shaped by the interconnected learning process. The

educational process in the educational institution is methodologically based and each component of the process is enriched with pedagogical principles. Each component of the educational process: goals, content, organizational forms and methods, teaching aids, behind the design of pedagogical principles, there are many pedagogical and psychological paradigms, concepts, approaches and theories.

From the above, it is clear that the pedagogical experience of a teacher has a complex structure and, no less, a complex content, and is mainly creative in nature. Not all educators can instill this experience in the learner, and not every learner can apply it. Therefore, the educational institution has special requirements for the professional and personal qualities of the teacher and the student, teaching and learning activities; they are reflected in the job responsibilities of the faculty and in the responsibilities of the students. For example, the educator must be a component of his professional and pedagogical activity, have knowledge of science, skills and abilities, a high level of duty and responsibility, creative potential, creativity, communication skills. The teacher's constant search, increasing knowledge and experience, deep understanding of students, understanding of their inner world, monitoring of growth and development, and the success of the educational process are all factors.

The deeper and more comprehensive the preparation of future teachers for practice, the more they must choose the right direction of pedagogical integration. At the same time, the integration of methodological, technological and personal pedagogical knowledge will be much easier, faster and more productive for the purpose. The following components are activated by: firstly, the acquisition of theoretical knowledge and experience of methodological reflection, secondly, pedagogical knowledge at the methodological and technological level, thirdly, the task of personal development of the teacher, the formation of identity enters.

Talented youth is the foundation of the future. Selecting them, targeting their activities and thinking is one of the main directions of our education policy today. Coordinating the activities of talented young people with promising research plans requires a great deal of responsibility and research from the educator.

It can be easily used in solving the problems of optimizing the educational process and in shaping the updated educational content to improve the training of future professionals, and it will undoubtedly provide creative pedagogical results.

It is determined by the fact that educators and learners have an integrative character and a humanitarian component on the one hand and a technocratic component on the other. At the same time, each of these components affects the other, changing the process of formation of learners in all its aspects.

An integrated approach based on intelligent teaching aids and systems will provide a solid didactic basis for training future teachers and, on this basis, for mastering effective innovative methods and technologies, as well as their implementation in practice.

So, integration means creativity, ingenuity, memory consolidation, research, imagination. Imagination creates a creative spirit, and creativity stimulates the development of thinking. That is why it is important to know the relationship between the disciplines, to be guided by these laws in the educational process.

## CONCLUSION

In conclusion, the process of integrative education requires every future teacher and educator to have great intelligence, patience, high love for students and their profession. The success of the teaching and learning process is due to the fact that the teacher is always inquisitive, constantly increasing his knowledge and experience, and is able to help with words, deeds or practical actions when needed. The results of this research can be easily used to address the issues of optimizing the educational process and the formation of an updated educational content to improve the training of future professionals, and undoubtedly provide creative pedagogical results.

In this regard, an integrated approach based on intelligent teaching aids and systems will be a solid didactic basis for training future teachers and, on this basis, the development of effective innovative methods and technologies, and their implementation in practice to increase the effectiveness of education.

## REFERENCES

- [1] Mirziyoev Sh.M. (2016). *Together we will build a free and prosperous, democratic state of Uzbekistan*. Speech at the joint session of the chambers of the OliyMajlis dedicated to the inauguration of the President of the Republic of Uzbekistan: Sh.M.Mirziyoev. – Tashkent: O‘zbekiston. – p. 56. (Mirziyoev Sh.M. Erkin va farovon, demokratik O‘zbekiston davlatini birgalikda barpo etamiz. O‘zbekiston Respublikasi Prezidenti lavozimiga kirishish tantanali marosimiga bag‘ishlangan Oliy Majlis palatalarining qo‘shma majlisidagi nutqi / Sh.M.Mirziyoev. – T.: O‘zbekiston, 2016, 56 b.)
- [2] Mirziyoev Sh.M. (2017). *We will build our great future together with our brave and noble people*. – Tashkent: “O‘zbekiston”. –p. 488. (Mirziyoev Sh.M. Buyuk kelajagimizni mard va olijanob xalqimiz bilan birga quramiz . T.: “O‘zbekiston” 2017. – 488 b.)
- [3] Mavlonova R., Rakhmonkulova N. (2009). *Integrated pedagogy of primary education*. – Tashkent. (Mavlonova R., Raxmonqulova N. Boshlang‘ich ta‘limning integ-ratsiyalashgan pedagogikasi. T., 2009-y.)
- [4] Turagulova I.Kh. , Mavlonov B.A. (2019). *Integration of education and upbringing in the spiritual education of students*. Proceedings of the International Scientific and Practical Conference “Professionalism of a teacher: a competence-based approach in education”. – Shymkent. Vol2. – pp. 205-210.
- [5] Rasuljanovna, I. N. (2019). The phenomenon of lacunarity as the linguacultural issue. *Prospects of world science-2019*, 226.
- [6] Atxamdjanovna, F. K. (2020, December). Effectiveness of physical culture education effects of adolescents on scientific thinking in growth location of effective information. In *Конференции*.

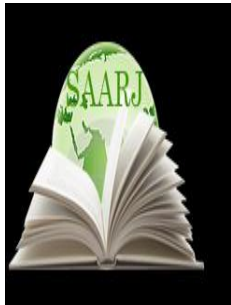

**ACADEMICIA**  
**An International**  
**Multidisciplinary**  
**Research Journal**  
 (Double Blind Refereed & Peer Reviewed Journal)



**DOI: 10.5958/2249-7137.2021.01115.0**

## FORMATION OF NATIONAL PRIDE BASED ON HADITHS IN PRIMARY SCHOOL CHILDREN OF HOUSES OF KINDNESS

**Bibixol Khairullaevna Karimova\***; **Munisa Shamsiddinovna Oripova\*\***

\*Researcher,

Termez State University of the Republic of UZBEKISTAN

Email id: bibixol.karimova@bk.ru

\*\*Researcher at the Teacher training center,

Surkhandarya region of the Republic of UZBEKISTAN

### ABSTRACT

*This article discusses the problems of forming national pride in the primary school students of the orphanage based on hadith sources. The theoretical and practical significance of the problem is analyzed, as well as opportunities for primary school pupils to use interactive teaching methods to formation national pride through hadiths, and the experimental results are summarized.*

**KEYWORDS:** *Orphanage, Primary School, National Pride, Hadith, Lesson, Occupation, Criteria, Factors, Educator, Pupil.*

### INTRODUCTION

In the world, the problems of social protection and education of children who have lost their breadwinners have been studied in detail and put into practice because they have achieved good results. A child can become an orphan during adulthood due to various social reasons. Orphan prevention issues are handled in the Foster family. This issue is one of the main problems of every state. Globally, the Foster family is the primary form of upbringing dedicated to the prevention of orphanhood. In the Foster family, every opportunity is created for children who cannot get along with their parents. In the Foster family, the children are brought up and returned to their family after a positive outcome.

In accordance with the Convention on the Rights of the Child of 20 November 1989, adopted by the United Nations General Assembly, orphanages receive social protection. It feels that every state is responsible for achieving the goal set out in it. In particular, children in orphanages need

to find solutions to problems related to the formation of personality traits and a number of mental problems, crime among neglected children, the nature of delinquency, the fact that a child is never born a criminal or delinquent, the re-education of delinquency and delinquency among neglected children. attention.

The Regulation on the House of Mercy, approved by the Resolution of the Cabinet of Ministers of the Republic of Uzbekistan No. 230 of October 17, 2008, was adopted and ensured its current implementation. Also, the Resolution of the Cabinet of Ministers of the Republic of Uzbekistan No. 171 of April 12, 1999, Article 22 of the Law «On Education» and Article 64 of the Constitution of the Republic of Uzbekistan guarantee full control and social security of children in orphanages. Resolution of the President of the Republic of Uzbekistan dated February 11, 2019 No PP-4185 «On additional measures to strengthen social protection of orphans and children deprived of parental care» Development of the program of de-institutionalization of orphanages for 2019-2023, Ministers of the Republic of Uzbekistan No. 824 of September 30, 2019, “On the choice of alternative forms of placement of orphans and children deprived of parental care, strengthening the institution of the family.

**Relevance of the topic and purpose of the Research:** Scientists of our country have opinions on the topic, including the management of orphanages, preparing them for family life, cultivating national pride in adolescents, their individual and socio-psychological characteristics, the formation of tolerance, intestinal microbiocenosis and the specificity of the immune system. forms, methods, means and ways of correctional and pedagogical work.

**Methods used in the Research:** Theoretical (pedagogical-psychological analysis, comparison, systematization), empirical (pedagogical experiment, test, questionnaire and mathematical-statistical analysis (descriptive statistical methods).

**Literature Review:** The issues of returning orphans to their families, bringing them up as full-fledged adults are covered in the research work of K. Petrovich, E. Tukhtamurodov, U.M. Askarova, I.O. Khaydarov, G. Yusupova, N.A. Adilkhonova, L. Muminova, Ya. Chicherina, E. Azamkhodjaeva, G. Koshanova, F. Ruzikulov, N. Egamberdieva, G. Yadgarova and other psychologists, pedagogical scientists.

In the past, special organizations were almost never engaged in the protection of orphans. The orphan would do his job and hear the gratitude of the man. Orphanhood is an economic impoverishment. It is known that social insecurity complicates the situation of orphans. Accordingly, many of them suffered a lot, even to feed their stomachs. Orphanhood is a phenomenon that requires public attention. Uzbek humanity, childhood, and the grief of this people have always encouraged the protection of the interests of orphans, at least on a community basis. This noble spirit shines in the following. “Do not weep for the orphan,” “Do not call the orphan an orphan,” “Do not eat the orphan's right,” “The orphan's right has dried up seven rivers,” “The orphan's right is God's arrow.”

Bringing up the young generation as harmoniously developed people has always been an important task, and even the Republic of Uzbekistan pays special and high attention to this issue, because young people know that today is tomorrow. That is why it is pursuing a special state youth policy in this regard. Especially during the years of independence, great attention has been paid to this issue, including the opening of opportunities for our youth to get an education and show their strength and knowledge in all areas among all countries.



«We have no right not to study, describe and promote this heritage, as long as the great thinkers of our history have passed away, their scientific and spiritual heritage, exemplary life and teachings have helped us to solve today's problems.» Of course, the right conclusion must be drawn from these considerations. This applies to every citizen. It is the duty of the younger generation to remember that our ancestors, who have great national pride, are our pride and to always follow in their footsteps.

Thanks to our great blessing of independence, every sphere has been radically reformed, including the sphere of education. In this regard, special attention was paid to the honorable tasks of forming national pride in the child, because our national pride plays an important role in the development of the child. Nationally proud youth are the builders of a free and civil society. One of the main issues is to bring up our youth with national pride, paying special attention to this issue. The implementation of these issues has become one of the most pressing issues in the education system. During the years of independence, a special approach was taken. It is included in the curricula and textbooks of social sciences and humanities in general secondary schools. It is the samples of folklore in reading, etiquette and music textbooks of primary school that are important source of cultivating national pride. On the basis of the given themes the child develops such qualities as patriotism, wisdom, honesty, humanity, courage, heroism.

Based on the individual psychological and pedagogical characteristics of children in the same situation, it is important to form national pride in orphanages. Why is it necessary to form national pride on the basis of hadiths in orphanages primary school pupils?

As the Republic of Uzbekistan moves forward at the level of developed democracies, education plays an important role in raising our country to the level of developed countries. The activity of teachers is important in this. Education is a two-way street. That is, the teacher is the student, and in orphanages the process of activity between the educator-student. Educators working at orphanages should be sweet, polite and demanding to their students. The formation of national pride on the basis of hadiths is one of the most important issues in the primary school pupil of foster child. Because the correct organization of each lesson, educational activities plays an important role in the life of the pupil. It is important that every lesson, educational event should be organized in accordance with today's requirements. Only then will the formation of national pride in the foster child be at a high level.

It is important and effective to form national pride on the basis of hadiths in foster child primary school pupils.

It is necessary to pay attention to and understand the content of the basic concepts in the coverage of the content of the formation of national pride on the basis of hadiths in the primary school pupils of foster child. That is: pride, national pride, and hadith.

When we think of national pride, we first talk about pride, and then what the meaning of national pride means, because the solution of a psychological and pedagogical problem, such as the formation and upbringing of national pride, is directly related to the meaning of the words and phrases.

The word pride means pride, pride, arrogance, pride, joy, rejoicing. In classical poetry and prose, in veterans, ballads and epics, as well as in folklore, the above words are used in synonymous

terms. The taste of the word pride is as sweet as the heat of bread, as dear as air and water. Pride is the most precious of all feelings given to people.

Only a person who knows and learns the language, religion, history, meaningful life of his ancestors, world-wide discoveries, can understand who he is and a sense of pride in his heart, body and soul. Also, in it, the desire to be faithful to one's ancestors and to perfect oneself enhances one's pride, one's true qualities.

National pride is derived from the historical past of a nation, national values, achievements of science, religion, literature, art and culture, which have been recognized around the world for centuries, and the geniuses who created them, historical monuments, national customs and traditions, motherland, a sense of pride and pride in the wise people, the beautiful past and present of the Motherland, the heroes of the national people.

Professor S. Otamuratov says the following about national pride. National pride is national pride. National pride is the care and respect for all the material and spiritual riches, historical heritage, customs, traditions, morals, lifestyle, high spirituality, all historical achievements and lessons of its people, created over the years. . According to M. Kuronov, national pride means the material and spiritual heritage of the nation, pride in the people, the motherland, views and attitudes to the psychology of the nation. It is reflected in the glorification of the country where a person was born and grew up, in the blood of his umbilical cord, in his grief and pride for his past, present and future. In the opinion of U. Mahkamov, national pride is a great force that unites the power of the people, their dreams and aspirations.

National pride is characterized by the glory, vitality and truthfulness of the people and the country. National pride portrays nation as nation, nation as nation. Thanks to the independence of Uzbekistan, the sense of national pride of the Uzbek people has risen around the world. Therefore, today Uzbekistan is recognized as one of the most influential countries in the world.

According to U. Makhkamov, to be proud, to defend the interests of the people, to benefit the people. Our people have always relied on the rules of morality and spiritual values, which embody the most noble ideas in their lives and way of life. Thanks to such advanced ideas, justice, honesty, purity, non-betrayal of the rights of others, compassion for the disabled, humanity, brotherhood and other human values have developed in our country. At the heart of our national pride lies these universal feelings.

R.A. Mavlonova gives the following description of national pride by giving a rough example of the indicators and criteria of national upbringing of pupils in the field of national oriental education. «To understand one's ethnicity means to understand the essence of the Uzbek people, to understand oneself as a child of one's own nation, to understand one's national duties, to love one's mother tongue, to speak and think correctly in that language».

Bringing up the younger generation with national pride is one of the great tasks facing education today. Therefore, every educator is responsible for this. A child should be brought up with national pride from the very beginning of primary school. These ideas also apply to orphanages's primary school pupils.

In our next opinion, we will briefly dwell on the hadith and its content.

The hadith is that in the countries of the East, man and society “play an important role in strengthening their spirituality and educating young people in a moral and ethical manner. Because the hadiths contain comments on the management of society, the formation of a just society and a perfect person in the country, life experiences, education. That is why the hadiths have been deeply rooted in human nature for centuries and have fulfilled their unique qualities. The great significance of the hadiths is that they help people to live in harmony by turning moral norms into obligatory norms of conduct for all”.

Hadiths have served as a lesson for centuries, strengthening people’s sense of trust, purifying and elevating them, and overcoming life’s trials, problems, and difficulties. The hadiths determine the effectiveness of shaping a high level of spirituality in the younger generation. The spiritual and moral qualities in the hadiths have not lost their significance and relevance even today. The spiritual and moral ideas in the hadiths of the Prophet Muhammad are important in seeking and finding ways to get rid of such moral evils as ignorance, oppression, injustice, dependency, indifference, in order for our country to rise to the level of developed countries.

The study of hadiths has its own history. This history began with the works of great hadith scholars, ie from the VIII to IX centuries, and continues to this day. During the years of independence in our country, after the collapse of the dictatorial regime, communist ideology and the education system that serves it, there is an opportunity to conduct research on the spiritual heritage and its enrichment. An important source in the organization of spiritual and moral education, a number of works have been done on the publication of the work. In particular, the publication of Bukhari's four-volume works «Al-Jami as-Sahih» and «Al-Adab al-Mufrad» in Uzbek, as well as «A Thousand and One Hadiths», «One Hundred and One Hadiths», «Etiquette and Morality» It is expedient to publish our spiritual heritage, such as «Gulistan».

Hadith is at the same time a set of high moral qualities that have become universal values. A human child who embodies these moral qualities will never raise his hand against his parents, will not become their killer in the pursuit of his evil intentions, but will live according to the principle of «Parents agree, God approves.»

Those who do not betray their homeland will not become traitors to their homeland in return for the loyalty of others. Consequently, they will be able to protect themselves from the influence of their religious fanatics. We see that hadiths are also important in the fight against religious fanaticism. Although the History of World Religions introduces students to the hadiths, their ability to fully reveal their educational significance is limited. Because the task of academic science is not only to teach pupils the knowledge of hadith.

It is known that our compatriot, Imam al-Bukhari, has a special authority in the science of hadith. We should be justifiably proud that the hadiths collected by our great ancestor are recognized in the Islamic world as the second source after the Qur'an, and that we are the grandchildren of the great scholar. The main purpose of the science of hadith is to contribute to the work of educating people to be patriotic, moral, knowledgeable and enlightened, and ultimately perfect. It is a great task to give a true knowledge of the science of hadith, and to teach the knowledge gained to apply it in life.

Al-Marwazi was the first in Mawarounnahr to teach a collection of hadiths. In addition, al-Marwazi, Ishaq ibn Rahawayh al-Marwazi, al-Shashi, al-Barakati, al-Nasafi, and others have classified collections of hadith. Over time, the hadiths were selected and those that were

considered important were put into a system. At the beginning of the IX-X centuries, there were 6 collections of hadith, which are considered the most reliable among the believers. These are: Sahih Bukhari, Sahih Muslim, Sahih al-Tirmidhi, Sunan Abi Dawud, Sunan Ibn Maajah, Sunan al-Nasa'i. Two of the muhaddithin who compiled these 6 collections of hadith were from Movarounnahr.

One of the innovations after independence was the translation into Uzbek of a collection of reliable hadiths by Bukhari, Al-Jami as-Sahih, described in the Islamic world as the «Imam of the Hadiths» and the «Sultan of the Science of Hadith.» The great muhaddith's work «Al-Jami as-Sahih» was translated from Arabic into Uzbek and published in thousands of copies in the early 90s of the last century by the current edition of the Qomus (National Encyclopedia of Uzbekistan).

“Hadith” - (Arabic - news, speech, news). The main source after the Qur'an is the science of hadith. Hadiths play an important role in strengthening the spirituality of man and society in the East, in educating young people in a moral and ethical manner. Because the hadiths contain comments on the management of society, the formation of a just society and a perfect person in the country, life experiences, education. That is why the hadiths have been deeply rooted in human nature for centuries and have fulfilled their unique qualities. The significance of the hadiths is that they help people to live in harmony by turning moral values into obligatory norms of behavior for all”.

**The scientific essence of the article:** While the hadiths glorify moral qualities such as kindness, chastity, patience, and gratitude from human qualities, they condemn such vices as extravagance, greed, greed, lust, envy, and ignorance. The science of hadith purifies the spiritual world of every human being. Leads to good. Forms human qualities. It makes you a believer and encourages you to be proud of life and live it with pride. It is this pride that forms national pride in a person. Hence, hadith is also a force that shapes national pride. Taking into account the age characteristics of the pupils in the formation of national pride on the basis of hadiths in the primary school pupils of Orphanage, the conduct lays the groundwork for achieving an effective result. Our independent country today wants to see our young people who are able to behave in all aspects of spirituality and enlightenment, who can defend their honor and pride.

That is why today it is necessary to bring up every child with national pride. In this regard, every educator is required to perform responsible duties.

The science of hadith, which has become our noble values, forms the best qualities in the heart of every human being. Looking at the hadiths with kindness, respect and love adds strength to his power. Increases self-confidence. As a result, the child also develops respect, trust and kindness to others.

What is important is that pride becomes pride, national pride emerges.

The formation of national pride in the primary school students of Orphanage on the basis of the science of hadith sets important tasks for educators. Concluding from these tasks, first of all, educating the students with national pride is one of the priority tasks. It is more important to start this task from Orphanage primary school pupils, because the knowledge, skills and abilities imprinted on a child's mind and thoughts from an early age will last forever. There is a saying, «Knowledge acquired in youth is a pattern carved in stone.» Also, in the opinion of Yusuf Khas

Hajib, «Where there is knowledge, there is greatness, and where there is knowledge, there is greatness.» Concluding from these considerations, we found it important to form national pride in Orphanage primary school students.

The science of hadith leads the students to greatness and priority. The science of hadith must be used to achieve this goal. Then national pride is formed in the pupils, they try to apply it throughout their lives. As a result, the following characteristics are formed in students:

Living with pride: respect for the language and religion of the nation: knowledge of history: appreciation of the rich heritage of their ancestors: study of universal discoveries: achievements of science, religion, literature, art and culture and their geniuses, historical monuments and monuments, national traditions, feelings of pride and pride in the traditions, the motherland, the wise people, the beautiful past and present of the homeland, the heroes of the national people. Relationships are also formed, such as treating all historical achievements and lessons with boundless respect and reverence, taking care of them. Today, our state has a high level of care for students of orphanages, and educators and teachers must be able to approach it responsibly.

Speaking of national pride, everyone who says he is Uzbek should have a sealed feeling in his heart. They can even be observed in important documents of our state. For example, the State Youth Policy, the Constitution of the Republic of Uzbekistan, the Law on Education of the Republic of Uzbekistan, the Action Strategy of the Republic of Uzbekistan, and the Convention on the Rights of the Child.

When we use the science of hadith to form national pride in Orphanage primary school pupils, first of all, it is necessary to cite the criteria of national pride. In the formation of national pride, first of all, it is necessary to pay attention to its criteria. Below are the criteria for national pride.

**TABLE 1**

<b>Pride of the homeland</b>	<b>Oriental etiquette</b>	<b>Humanity</b>	<b>The national idea</b>
Knowledge of the history of our country, its past, interest in the brave and courageous heroes. Enrichment of understanding of the Motherland, study and preservation of its material and spiritual riches, love for the Motherland, readiness to serve the Motherland, zeal for the Motherland, becoming a brave defender of Uzbekistan, participation in events that can contribute to the development of the Motherland, selflessness. Know and follow the national values, traditions and customs of the people. Respect for universal values,	Rules of greeting, respect for adults, respect for children, friendship, cleanliness, politeness, etiquette for boys and girls, adherence to oriental national etiquette, good manners, family etiquette, behavior in public, understanding of etiquette, scientific enlightenment.	Conscientiousness, honesty, integrity, honesty, positive behavior patterns, proper understanding of one's duty, avoidance of injustice, ability to have the right relationship with people.	An independent country is a sign of independence of Uzbekistan, a sense of pride in what is being done, an understanding of Uzbekistan's position in the world, a sign of respect for the state language.

<p>oriental traditions and mother tongue.</p> <p>Knowing and following the teachings of Eastern scholars. Respect for the art of the Uzbek people.</p>			
--	--	--	--

It is possible to create and improve national pride by forming defined criteria in educators. The procedure for using hadiths to achieve this goal is given below.

While national pride is formed through feelings of love and pride for the homeland, attention should be paid to enriching the knowledge of students about the homeland. Therefore, it is necessary to teach 1st graders to love and respect the Motherland by describing it.

There is such a great word in the world that it always shines in the human heart like divine light, scattering light gives strength to the body, pleasure to the soul, a lifetime of rest to human life. This is a delicious and dear word «Vatan». She stands next to the majestic word «Mother.» There will be one mother and one motherland in the world, this notion will never change, it will never become obsolete. As bread is always delicious, no matter how many times these words are spoken, their value never diminishes. In both cases, we call the Motherland «motherland» by the definition of the most beloved person. It is no coincidence that the most honorable words in the world are said to parents, motherland.

Uzbekistan is becoming more beautiful day by day. New, beautiful buildings, bridges, smooth, flat roads have been built in our country. We are proud of our Motherland, because our great ancestors lived in this sacred land.

Everyone loves their homeland, and even these hadiths state, «Loving one's homeland is a matter of faith.»

We quote the following hadith about the first homeland of man. “Man's first homeland is his mother's stomach. When he is born, his birthplace can be his homeland. “As the Motherland is equated with the most precious human being in the world, we must protect our Motherland as we protect our mother.

The first part of the textbook «Odobnoma» for 1st grade is called «Uzbekistan - a free and prosperous country», which includes topics about the homeland. The feeling of love for the Motherland is expressed on the basis of themes. Through the topics of this section, the child develops such qualities as patriotism, pride in the Motherland. The motherland is equated with the mother, and the mother is called the motherland.

It is advisable to use hadiths to form this feeling in 1st graders.

Samples of age-appropriate and hadith-related tales can be used to help students understand the content of the hadiths quoted, as 1st graders are very interested in fairy tales. In fairy tales, good triumphs over evil. It was considered expedient to explain the content of the hadiths on the basis of fairy tales. From them, the trainees draw the right conclusions, as well as understand the content of the hadith. The story of the «Seven Girls» can be a proof of our opinion.

Based on the content of the hadith, it would be expedient to convey the content of the fairy tale «Seven Girls» to the children in roles. The trainee not only memorizes the content of the hadith, but also becomes accustomed to acting on stage. It is also quick to remember.

We have recommended the use of role-playing games. Role-playing games are appropriate for the child's age and psychological characteristics. When they are used, the quality and effectiveness of in-class and out-of-class activities increase. Pupils are encouraged to be active in extracurricular activities, to express themselves independently and freely. It is important that each trainee actively participates in the training without being left out. There will also be a high level of interest in learning. In this, the pupil learns himself and learns from one another what he does not know.

Pupils are encouraged by the tutor after performing the roles based on the content of the fairy tale. Based on the content of the story, the educator asks questions. For example:

1. What did you learn from the story?
2. Did the girls do the right thing?
3. Do you consider the courage of girls as loyalty to the motherland and people?
4. Can you imagine what would happen if the king's daughters did not behave like that?
5. Is the work done by the king's daughters a duty?
6. How would you behave when you were there?

Crosswords were given to explain the hadiths. Based on them, there will be an opportunity to memorize the content of the hadith.

A crossword puzzle on the topic

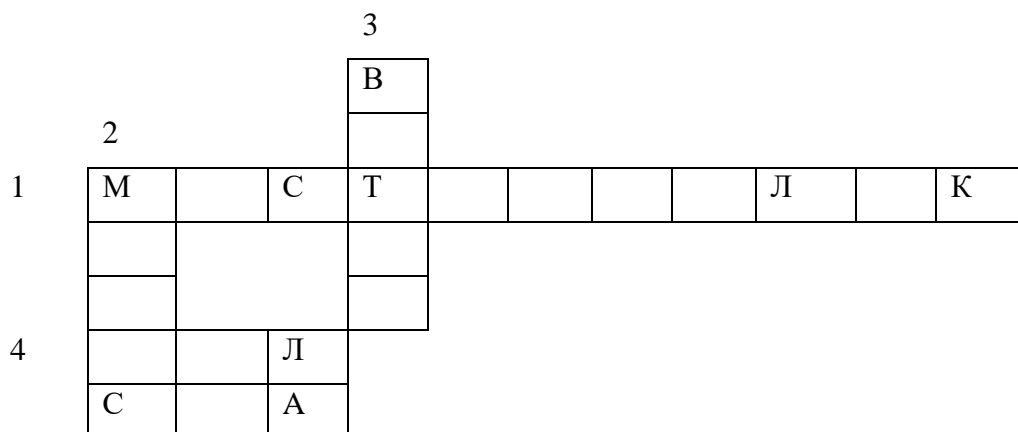

Crossword questions:

1. September 1....
2. From the ancestors... country.
3. Our... is Uzbekistan.
- 4... - small homeland.

All the information presented is based on the theoretical aspect of national pride, that is, it focuses on the content of national pride for the reader, why a person needs it, and the possibility of forming national pride on the basis of hadiths. It also shows ways to gain an understanding of the hadith and its content. Tales were given according to the content of the hadiths, taking into account the quick comprehension of the reader.

Crossword puzzles are given in accordance with the content of the hadith, which encourages the child to work mentally. So, all of them can be the basis for the formation of national pride. The interest of the 1st grade pupil in applying the theoretical knowledge gained in practice will prevail. Only then will he have the skills to remember and apply in life.

## RESEARCH RESULTS

Based on the points made, it should be noted that practical work is always of effective importance. Therefore, below are ways to put the topic into practice. Now we present the content of practical work on the formation of national pride on the basis of hadiths.

To do this, it is appropriate to use a mental attack based on the solar schedule. On one side of the image are the hadiths on the theme of the homeland, and on the other side are the criteria that shape the national pride formed as a result of mastering the hadith.

For example, as follows:

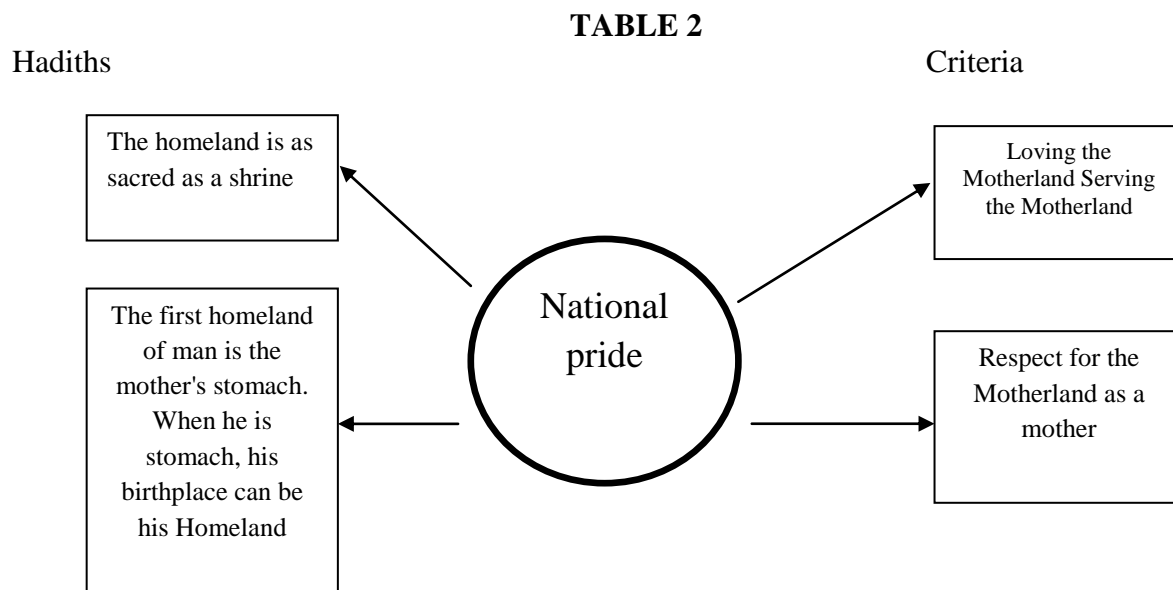

This table is distributed to 1st graders. On this basis, they receive an assignment, that is, after mastering the content of the hadiths on the right, the criteria are written on the basis of the left. (The content of the hadith given in each class section is performed by the pupil in this order). As a result, the child becomes aware of their responsibilities and becomes accustomed to accepting them as a responsibility.

The future of every nation is determined by the quality of education provided to the younger generation. The work being done in our country in this regard is noteworthy. Achieving the effectiveness of education on the basis of the criteria set out in the Law «On Education» and the



«National Training Program» is one of the important tasks facing every educator. Therefore, it is necessary for educators to use advanced pedagogical technologies that develop the worldview of young people in extracurricular activities and, as stated in the «National Training Program», «to introduce new forms and methods of education.» For this purpose, we have given some examples of interactive methods.

Pupils of the wheel method are divided into groups and given a sheet with assignments. For example: Determine the content of the hadiths.

TABLE 3

Hadiths	Homeland	Greetings	Good manners	Science and profession	Material and spiritual wealth
Homeland - mother, the threshold is gold.					
The first homeland of man is the mother's stomach. When he is born, his birthplace can be his Homeland					
Your best ones are kind, sweet conversationalists.					
Whichever young man respects the old man, he will see that respect as he grows older.					
The best of the qualities bestowed on human beings is good morals.					
The word of man is the scales of the mind.					
Man becomes great by doing good to his people					
The crumbs of bread is also bread					
Every wealth ends, science and profession are endless wealth.					

Procedure:

TABLE 4

Ҳадислар	Homeland	Greetings	Good manners	Science and profession	Material and spiritual wealth
Homeland - mother, the threshold is gold.	+				
The first homeland of man is the mother's stomach. When he is born, his birthplace can be his Homeland	+				
Your best ones are kind, sweet conversationalists.			+		
Whichever young man respects the old man, he will see that respect as he grows older.			+		

The best of the qualities bestowed on human beings is good morals.			+		
The word of man is the scales of the mind.			+		
Man becomes great by doing good to his people	+				
The crust of bread is also bread					+
Every wealth ends, science and profession are endless wealth.					+

The task in the table can be done by the trainees on a group basis and individually. The task can be completed by placing a “+” sign in the columns or writing words, depending on the assignment.

The following tabular handouts are available for use in written discussions in educational institutions:

Group 1

**TABLE 5**

Discussion: Is it one's duty to serve The people?
<p><b>Yes</b></p> <ul style="list-style-type: none"> <li>• Answer. Everyone should love his hand as much as he loves his homeland. Therefore, serving the wind, the heart must always be with them. Because it is everyone’s duty. Only such a person strives for perfection with the blessing of the hand.</li> <li>• Give evidence. There are many such people in our country is formed. For example, we can proudly cite the first President of the Republic of Uzbekistan IA Karimov. From him we learned to love the Motherland, to serve the people and the Motherland. Each of us, like our ancestors, must follow in their footsteps and serve our people.</li> </ul>

To 2 groups

**TABLE 6**

Discussion: Is it one's duty to serve the PEOPLE?
<p><b>No.</b></p> <ul style="list-style-type: none"> <li>• Answer. Serving the people can also be seen as a task. Because every task I perform is a service to the people.</li> <li>• Give evidence. For example, being a good student, being a good person, doing my daily work can serve the people.</li> </ul>

Each group that writes this table comments on their ideas. Those who have a positive opinion should try to confirm their opinion. At the end of the session, the educator encourages the active group. The advantage of the above-mentioned written discussion training is worth mentioning. At the same time, each student is able to freely express their independent opinion and is encouraged to take action.

The degree to which national pride is formed on the basis of hadiths in primary school pupils of orphanages is scientifically based, according to the study. Experimental work on the formation of national pride on the basis of hadiths in the primary school pupils of orphanages showed that they initially had a low level of understanding and knowledge of national pride.

TABLE 7

Number of pupils	The first stage of the experiment								
	2017-2018			2018-2019			2019-2020		
	e.g. - 60 people c.g.- 63 people			e.g. -61 people c.g. - 64 people			e.g. - 64 people c.g.- 64 people		
	High	Medium	Lower	High	Medium	Lower	High	Medium	Lower
<b>Experimental group</b>	26 (43,3%)	24 (40%)	10 (16,7%)	26 (42,6%)	26 (42,6%)	9 (14,8%)	28 (43,8%)	30 (46,8%)	6 (9,4%)
<b>Control group</b>	26 (41%)	24 (38%)	13 (21%)	27 (42,2%)	24 (37,5%)	13 (20,3%)	27 (42,2%)	25 (39%)	12 (18,8%)

So, at the end of the study in the experimental group БК-4,7% (Lower), 48,4% (Medium) and 46,9% (High). The control group had the following indicators after the experiment: ТК - эса 14% (Lower), 41% (Medium) and 45% (High).

TABLE 8

Number of pupils, people	The final stage of the experiment								
	2017-2018			2018-2019			2019-2020		
	e.g. - 60 people c.g.- 63 people			e.g. -61 people c.g. - 64 people			e.g. - 64 people c.g.- 64 people		
	High	Medium	Lower	High	Medium	Lower	High	Medium	Lower
<b>Experimental group</b>	26 (43,3%)	24 (40%)	10 (16,7%)	28 (45,9%)	27 (44,3%)	6 (9,8%)	30 (46,9%)	31 (48,4%)	3 (4,7%)
<b>Control group</b>	26 (41%)	24 (38%)	13 (21%)	28 (43,8%)	25 (39%)	11 (17,2%)	29 (45%)	26 (41%)	9 (14%)

## CONCLUSION

Educators working in orphanages have certain responsibilities. One of them is educating young people with national pride. It is advisable to perform this task from the first elementary school period of the pupil. The use of hadiths in the formation of national pride is an effective tool. Based on the above considerations, an example of the formation of national pride in 1st graders on the basis of hadiths was given. From this it can be concluded that.

- Extracurricular activities for children from orphanages. The use of hadiths in their time teaches them to follow the rules of etiquette. Therefore, it is advisable to use hadiths through extracurricular activities.

- Educators of orphanages act as parents. Parents bring up a child at home on the basis of the teachings of our ancestors, the example of adults, the hadiths. These goals should be effectively implemented by the educators of orphanages. Fairy tales are used to explain the content of the hadith. He was able to easily understand the content of the hadith. Crosswords, on the other

hand, can stimulate mental activity and increase interest. The given information serves to form national pride in pupils.

- national in primary school pupils of orphanages the solar schedula we have proposed is effective in the practical study of the theoretical knowledge gained in shaping pride on the basis of hadiths.

Effective from recommended interactive methods and hadiths when used, the opportunity to form national pride on the basis of hadiths in the primary school pupils of orphanages is purposefully realized. Following our comments above, the following

recommendations.

- Hadiths of national pride in orphans use in the creation of a set of teaching aids as a didactic tool for educators in the formation of

- Training courses for parents involved in the organization of a foster family.

- Orphanages are electronic for primary school students use in the creation of methodological manuals.

## REFERENCES

1. Vohidova N. Fostering national pride in primary school students based on folklore. p.f.n.dissertation. - T.: 2011. - 155 p.
2. Pazilova M. Pedagogical bases of formation of student's spirituality by means of hadiths. p.f.n Dissertation. - T.: 2004. - 162 p.
3. Mahmudov Yu. The criterion of national pride and spiritual perfection. - T.: Dizayn - press, 2011. - 276 p.
4. Mansurov A. Hadith lessons. - T.: Literature and Art, 1999. 63 p.
5. Hamidova M. Grandma's chest. - T.: Yangi asr avlodi, 2015. - 168 p.
6. Yusuf Khos Khojib. Qutadg'u bilig. - T.: Fan, 1971.- 964 p.
7. Quronov M. National education. - T.: Manaviyat, 2007. - 237 p.
8. Qodirov B. Pedagogical bases of perfect human education. - T.: - Mehnat, 2001. - 194 p.
9. Karimova B.X. Possibilities of formation of national, pride, with using khadiths in the first-year pupils of orphanages. // European Journal of Research and Reflection in Educational Sciences. Vol, 7 No. 11. 2019. - P. 118-124 (13.00.00. №3).
10. Karimova B.X. Content and criteria for formation of national pride in primary school pupils of orphanages // European Journal of Research and Reflection in Educational Sciences. Vol, 8 No. 7, 2020. - P. 75-79 (13.00.00. №3).

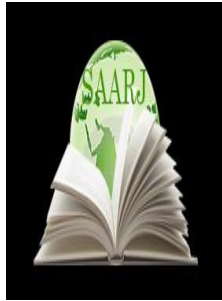

**ACADEMICIA**  
**An International**  
**Multidisciplinary**  
**Research Journal**  
 (Double Blind Refereed & Peer Reviewed Journal)

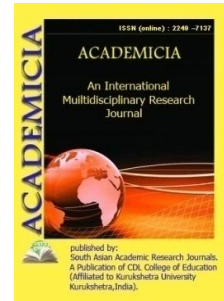

**DOI: 10.5958/2249-7137.2021.01116.2**

## ANALYSIS OF THE LEGISLATION ON CIVIL SERVICE IN THE REPUBLIC OF UZBEKISTAN

**Dilmurodjon Rakhimov\***

Base Doctoral Student,  
 Academy of Public Administration under the President,  
 Republic of UZBEKISTAN  
 Email id: drakhimov95@gmail.com

### ABSTRACT

*The article analyzes legislation on the civil service of the Republic of Uzbekistan. The legislation was studied in terms of labor and responsibility relations, the organization and management of the civil service. Based on the research, proposals and recommendations for improving the legislation of the civil service of the Republic of Uzbekistan has been developed.*

**KEYWORDS:** *Civil Service, Legislation, Labor Relations, Responsibility Relations, Disciplinary Liability, Administrative Responsibility, Criminal Liability, Action Strategy.*

### INTRODUCTION

The civil service as a legal institution is a kind of interrelated social relations, that is, a set of legal norms governing the civil service. It is known that the Law "On Civil Service" has not yet been adopted in the Republic of Uzbekistan. So legal norms governing the civil service are reflected in laws and other normative legal acts.

The legislation on civil service can be divided into three parts:

1. Legislation regulating labor relations in the civil service;
2. Legislation regulating liability in the civil service.
3. Legislation related to the organization of civil service.

***Labor relations of civil servants*** are established by labor legislation. In particular, it should be noted that the Labor Code of the Republic of Uzbekistan, which came into force on April 1, 1996, is the legal basis for regulating labor relations in the civil service. Article 18 of the Code

stipulates that "the specifics of the regulation of labor of civil servants shall be determined by law." [1]

This Code contains more systematic, perfect and clear norms than the labor legislation of other states, especially Western states. True, this Code regulates the civil service relationship in terms of the relationship between the employer and the employee, the social, labor rights and obligations of employees, but does not define the principles and legal regime of the organization of the civil service.

Recruitment, dismissal, working hours, vacation time, remuneration, guaranteed payments and compensation payments, labor discipline, financial responsibility, employer liability, labor protection, additional guarantees and benefits, social insurance rules, provision of benefits is carried out on the basis of the provisions of the Labor Code, unless otherwise provided by law.

The employment relationship of a civil servant is determined by the employment contract. An employment contract is concluded in writing and is a normative document. Its content is determined by the agreement of the parties and the provisions of labor legislation. The terms of employment contracts with civil servants may vary. The procedure for concluding an employment contract, the procedure for amendment, the procedure for termination, the documents required for the conclusion of the contract, the circumstances preventing the conclusion of the contract are specified in detail in the Labor Code. [2]

The procedure for appointing and dismissing ministers, heads of some central institutions, and regional governors is established by the Constitution of the Republic of Uzbekistan. For example, regional khokims are appointed and dismissed by the President of the Republic of Uzbekistan, and their appointment and dismissal are approved by the relevant regional Councils of People's Deputies.

***Legislation regulating liability in the civil service*** has a special role in the system of public civil service legislation. Liability of civil servants means the application of certain types of penalties provided by law for violations of the law by civil servants. [3]

Liability can arise in case of non-compliance with the law, violation of service discipline, non-performance or improper performance of official duties or negligence, material damage to the state, public associations, violation of the rights and legitimate interests of citizens. The subject of this responsibility will be the civil servant.

The responsibility of civil servants can be as follows:

- Disciplinary liability;
- Administrative responsibility;
- Criminal liability.

The main document determining the rules of disciplinary liability is the Labor Code of the Republic of Uzbekistan, on the basis of which the rules of internal labor may be established.

The following disciplinary measures may be applied to a civil servant for violation of labor discipline by an authorized body or a manager: a fine in the amount not exceeding thirty percent of the average monthly salary (internal labor regulations may also provide for a fine in the

amount not exceeding fifty percent of the average monthly salary). termination of employment contract.

If the administrative liability of civil servants is established by the Code of Administrative Responsibility of the Republic of Uzbekistan, if there is a criminal element in their actions, it can be resolved by the Criminal Code of the Republic of Uzbekistan and the Code of Criminal Procedure of the Republic of Uzbekistan.

In particular, according to Article 15 of the Code of Administrative Responsibility of the Republic of Uzbekistan, a person holding a certain position in an enterprise, institution, organization, regardless of the form of ownership, is subject to management, organizational, ordering, inspection and control of material assets. is considered an official if the existing tasks are assigned. [4]

Not all officials are considered civil servants. To be a civil servant - a subject of administrative responsibility, of course, must hold a certain position (position) of the state in a public organization, perform the duties and functions of the state and commit an administrative offense in connection with civil service activities. [5] As a rule, civil servants (officials) are a special subject of administrative responsibility.

Officials should be held administratively liable for administrative offenses related to non-compliance with the established rules and regulations in the field of management, state and public order, protection of the natural environment, public health and other rules included in their official duties.

*The most important normative legal act on the organization of the civil service* is the Constitution of the Republic of Uzbekistan. Section V of the Constitution, entitled "Organization of state power", based on the principle of separation of powers, defines the basic rules for the organization of public civil service in Uzbekistan. [6]

According to the Decree of the President of the Republic of Uzbekistan dated February 7, 2017 No4947 "On the Action Strategy for further development of the Republic of Uzbekistan", the Action Strategy for the five priority areas of development of the Republic of Uzbekistan for 2017-2021 is a new step. In the implementation of its first direction "Improvement of state and society building", measures to improve public administration, first of all, civil service reform, reduction of public administration in the economy, modern forms of mutually beneficial cooperation between public and private sectors, e-government planned to implement. According to the decree, the basic principles of the organization and functioning of the civil service, the formation of the civil service, the transition to the civil service, the transition to service and resignation, the regulation of guarantees in this regard. [7]

Also, the Decree No5185 "On approval of the Concept of administrative reform in the Republic of Uzbekistan", signed by the President of the Republic of Uzbekistan on September 8, 2017, identified six main areas of public administration reform. One of them is the formation of an effective system of professional public services. According to him, the organization of the civil service, including the legal status, classification of civil servants; transparent mechanisms of recruitment (on a competitive basis), the formation of a reserve of personnel, the transfer of service, ensuring compliance with ethical standards. [8]

In order to systematize the tasks provided for in the Action Strategy and the Concept of Administrative Reforms and their implementation in practice, on October 3, 2019 the Decree of the President of the Republic of Uzbekistan No 5843 "Priority measures to radically improve personnel policy and civil service in the Republic of Uzbekistan" was adopted. [9] In our opinion, this decree covers a number of important aspects of the organization of the civil service:

First, the civil service in Uzbekistan is functionally divided into the state special service and the state civil service.

Second, the Agency for the Development of Public Service under the President of the Republic of Uzbekistan was established, which is responsible for implementing a unified state policy in the field of personnel management and human resource development in government agencies and organizations. The main tasks, functions and activities of the Agency are defined in the Regulations approved by the Presidential Decree No 4472 "On measures to organize the activities of the Agency for the Development of Public Service under the President of the Republic of Uzbekistan." [10]

Third, a program of measures has been developed in three areas to radically improve personnel policy and the civil service system in the Republic of Uzbekistan. The program includes the development of conceptual framework of personnel policy and the civil service system, improving the regulatory framework of the system, capacity building of the civil service, the development and adoption of a number of regulations, as well as some features of the system. implies improvement.

Fourth, the introduction of the principle of meritocracy and the "career model" in the system was established in order to create a transparent mechanism for entry into the civil service and career advancement.

Fifth, it is planned to develop a draft presidential decree approving the state register of civil service positions. The classification of civil servants' positions according to their powers (political, administrative and technical) and their levels (national, republican, regional and district) is one of the main shortcomings in this area. In particular, the Decree of the President of the Republic of Uzbekistan dated December 9, 2003 No3358 "On improving the system of public administration of the Republic", the Ministers of the Republic of Uzbekistan, although the register of positions is not in terms of civil service positions.[11] In accordance with the Resolution of the Cabinet of Ministers of the Republic of Uzbekistan No 339 of July 3, 1997 "On the establishment of a twenty percent increase in salaries of civil servants" lists of civil servants serving in public administration bodies and organizations are provided. [12]

The issue of ethics of civil servants also plays an important role in the organization of the civil service. This issue is reflected in the Resolution of the Cabinet of Ministers of the Republic of Uzbekistan dated March 2, 2016 No 62 "On approval of the Code of Ethics for employees of public administration and local executive authorities." This decision means that all civil servants must follow the rules of ethics in the course of their employment. Thus, civil servants conduct their professional activities on the principles of justice, ensuring the rights and freedoms of citizens, a serious approach to the duties of the service, not putting the interests of the state and society above their own interests, not to allow corruption. The constant adherence of civil servants to the rules of etiquette is important in that they are given special consideration in appointments to positions during their professional careers. [13]



In conclusion, although the civil service is regulated by a number of normative and legal acts due to the nature of labor, responsibility and organization, the lack of a single law remains the most pressing problem in public civil service legislation. Therefore, the adoption of the Law "On Civil Service" and its distinction from the special service due to the formation of a clear register of civil servants, a clear definition of the rights and obligations of civil servants based on the register of positions, the transition to a unified system of remuneration. The solution of topical issues such as is the most important factor in the legislation in this area.

#### REFERENCES:

1. Labor Code of the Republic of Uzbekistan // <https://lex.uz/docs/142859>
2. Civil service. Textbook / Azizov H., Yuldashev A., Asadov Sh., Hayitov H., Karimov D., Bekchanov D., Atajanova D., Yuldasheva F. - T.: Tafakkur qanoti, 2019. - P. 52.
3. Hojiev E., Hojiev T. Administrative law. –T.: “Science and technology”, 2008. - P. 241.
4. Code of the Republic of Uzbekistan on administrative responsibility // <http://lex.uz/docs/97664>
5. Mirboboev B., Husanov O., Begmatov A. Organizational and legal issues of civil service organization in Uzbekistan. “Akademiya” Publishing House, Tashkent, 2005. - P.117.
6. Constitution of the Republic of Uzbekistan. - T.: Uzbekistan, 2019. - 77 p.
7. Decree of the President of the Republic of Uzbekistan. On the Action Strategy for further development of the Republic of Uzbekistan // <http://lex.uz/docs/3107036>
8. Decree of the President of the Republic of Uzbekistan. About approval of the Concept of administrative reforms in the Republic of Uzbekistan // <http://lex.uz/docs/3331174>
9. Decree of the President of the Republic of Uzbekistan. On priority measures to radically improve personnel policy and the civil service system in the Republic of Uzbekistan // <http://lex.uz/docs/4549998>
10. Resolution of the President of the Republic of Uzbekistan. On measures to organize the activities of the Agency for the Development of Public Service under the President of the Republic of Uzbekistan // <http://lex.uz/docs/4552053>
11. Decree of the President of the Republic of Uzbekistan. On improving the system of public administration of the Republic // <https://lex.uz/docs/173163>
12. Resolution of the Cabinet of Ministers of the Republic of Uzbekistan. About establishment of a twenty percent increase in salaries of civil servants  
// [https://lex.uz/pages/forpda.aspx?lact\\_id=1191841](https://lex.uz/pages/forpda.aspx?lact_id=1191841)
13. Resolution of the Cabinet of Ministers of the Republic of Uzbekistan. About approval of Standard rules of ethics of employees of public administration bodies and local executive bodies // <https://lex.uz/docs/2911869>

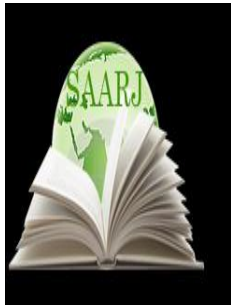

**ACADEMICIA**  
**An International**  
**Multidisciplinary**  
**Research Journal**  
 (Double Blind Refereed & Peer Reviewed Journal)

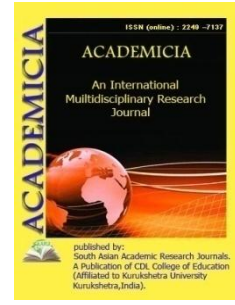

**DOI: 10.5958/2249-7137.2021.01205.2**

**NEW WORLD ORDER AND INDIA, S POLICY TOWARD PROTECTION  
 OF HUMAN RIGHTS IN AFGHANISTAN**

**Sendhil kumar\***

\*Research Scholar,  
 Centre for South Asian Studies,  
 Pondicherry University, INDIA  
 Email id: Senthilkumarpu@gmail.com

**ABSTRACT**

*The traditional attitude of India's social reformer, political leader, current politicians, diplomatic and policy makers are having the habits of cooperating to international order, if it seems fair and applicable to world justices. India have been participating in so many world affairs with material assistances as part and parcel of human rights protector than any other country in the contemporary history with the permission of powerful countries. Very notably, since dawn of 2001 as focus light of south Asia peace as well as Afghanistan peace even after death of Taliban rule in Kabul. India interest sprang at high level to strengthen Afghanistan political institutions with goal to protect human rights. Since soviet invasion in 1979 to 1989, there were sporadic chaos, commotion and bomb blast due to supper power politics, rivalry and regional countries politics. This had created so many economic damages, unrest and human rights lost. After end of Russia invasion Taliban ruled Kabul again about ten years with so many human rights violations as unanswerably as unaccountably. Therefore, as big power of south Asia India could not have prevented and involved in Afghanistan for protection human rights against Talban rule unless U.S bring new anti –terrorism law as a new world order. So, after initiated new world order by U.S as to destroy terrorist has been as most useful to India in number of ways such as ,rapprochement with Muslim people ,protecting human rights ,gaining good name from the Afghanistan people and fortifying India's growing power beyond the South Asia.*

**KEYWORD:** *New World Order, US Policy, India's Policy, Afghan Human Rights, Terrorism And Afghanistan Peace*

## INTRODUCTION

### What is new world order?

So many world order have emerged from birth of politics to development of politics, all these orders are seeming as a new world order as per the situation of ancient period ,and medieval period toward protect citizens from natural hazards ,drought ,famine and poverty along with making unusual law for the public safe and happy purpose. The chief aim of this order is to attract the world people attention by showing its special output for world order that will emerge according the world bad or good situation for make a smooth atmosphere where human being could be live at congenial way in the civil society .Additionally, we can mean this law as a growing crops according to season for full fill the farmers needs, like this new world order would be good for people peaceful life by creating something and destroying something.

### What is Aim of this order?

Emergence of new world order with the help of USA in this modern period being much more helpful to solve so many global facing problems such as climate changes ,financial crisis ,inflation ,terrorism ,insurgency and outlaw group atrocities in the world countries .In this way ,anti-terrorism policies of the world powerful countries in Afghanistan attached with new world order for establish a tranquil atmosphere in nook and corner of the world .In Afghanistan, Taliban and war lord motivated terrorist out fits are posing a grave threat to several countries in south Asia and central Asia as continuous annoy as restless disturbances to world countries peace . To contain and control all this anti-social elements, U.S.A enacted anti-terrorism policy at the cost of its three fold country budget expenditure for kill the villain of world peace.

### Birth of New World Order

September 9/11 attacks on (WTC) organizationby Taliban has let to think about to terminate and enact unanimously anti-terrorism law along with world countries approval and united nation authority support. The interest of U.S.A about this policy is to dismantle terrorism networks and its whereabouts across the world. This would be applicable on those who support, finance, train and accommodate terrorism in the nook and corner of the world as unanswerably .Indeed, this policy has gathered world attention based on its aim to establish peace and prosperity.At the same time this order should be analyzed whether it is good policy or not .For this, people across the world had been raised several questions that why U.S.A have not been taken same action when several countries were attacked by Taliban .So finally people perceived this policy asU.S.A self-centered policy than world welfare. Additionally world people accepted this policy with aim to no longer terrorism should be in the world even though this policy was attribution ofU.S.A self-protecting policy and world peace making policy.

### Assessing of Anti-Terrorism law

People got panic globally with compassion about world trade centre attacks (W.T.C) which was orchestrated by Taliban on 9/11 for revenge USA involvement in gulf countries. Anti-terrorism law came out with aim to control war, violence and terrorism in the Afghanistan and rest of countries. Simultaneously, people of rest of countries contemplated when America sought world community support for crush down terrorism that why not U.S.A bothered about when so many poor countries are affected by Taliban and its duty ended merely at expressing condolence through the television and mass media. Collectively, U.S. Aposition was as a spectator of over other

countries attacks by terrorism and other internal problems .This silent spectator attitude of USA has forced itself to initiate an anti-terrorism policy with self-centered attitude when its World Trade Center was attacked .Therefore, its true angry broken out when its people killed in WTC incident and why did not come out a true angry when Indian parliament was attacked by Taliban team. So, its policy has given more weightier to its internal development than world peaceful development when we look at its policies.

### **Influence of New World Order on Human Rights Protection**

Every bad policy reaches its goal by crossing so many good polices in this way, America brought out anti-terrorism policy which reached its good goal by killing lacks of people in Afghanistan. Its policy was welcomed by so many leaders despite its policy was concerned to fulfill its country interest rather than to protect world justice .Anyhow ,since its policy was seemed to protect human rights in Afghanistan from children to adult it was accepted by world community for the purpose of establish conducive development in Afghanistan. America compensation and assistance to Afghanistan for restore its war made damages has been protecting still so many citizenlife in so many welfare policy ways under the objective of anti-terrorism policy since 2001-2014. In spite of USA has involved in anti-terrorism activities in Afghanistan, its war oriented compensation service has been helping to Afghanistan immensely in following way such as: protection of human rights ,establishing good livelihood sources ,workable situations ,earning atmosphere and business starting opportunities. Totally, all its policies have been satisfying Afghans civics needs.

### **Emergency of Terrorism**

The world has undergone the hardship of the colonial and imperialism dominations .By which, so many country started so many revolutions and independent struggle through the positive, passive and bloody ways. In fact ,these struggle emerged as per situation and atmosphere of those who lived in those days for get freedom from the colonial country .This movements and struggles are instructed to today school going generations as a subject of freedom movements mixed with violent revolution and nonviolent revolution for enable them to understand old colonial administration .Therefore today generation are revising and reading to get wider insight about initiate new methods and tools to revenge or control those country which wants to dominate other country on the name of super power .This modern policy of particular affected countries are named as terrorism as a policy to achieve quickly what does or do they want .Therefore collectively ,terrorism is also a good policy to a particular group or country for protect them from future attacks or invasion of mighty powers and its main theme of ideas are motivations of freedom fighters of particular religion and country.

### **Containing Terrorism**

Why do world people or community coined bloody or unexpected causalities is known as terrorism because which does not have an ethical principle regarding to world welfare and people life .Its action and outcome would be resulting at much more agony ,panic ,eternal fear and devastation of total human being life and assets in particular region of their unlike people or country .Indeed ,how do people call terrorism is most fear full one is based on its consequence of intolerable ,unacceptable ,un-accommodative , ferocious and heart rending outcome of its activities . .Its threatening attitude through bomb and explosive devises have caused ever remaining fear and injuries at the heart of leaders and common people in the South Asia, Central

Asia, Middle east .After plausible and blatant evidence seen by the world community that terrorism is a tools of some organized people or group to castigate and punish its opponent country in terms of politics, economics and social aspects. Therefore, world countries got together to crush down terrorism birth and remains in the world for the cause common people peaceful life.

### **Advantage of New world order**

Although this new world order implemented by super power along with fifty percentage of self-centered order and fifty percentage of human rights protection interest,it was heralded by the world people since this policy is being so important to protect human rights in Afghanistan and to destroy terrorism network. In fact, this policy was impossible to enforce by all other countries previously except U.S.A though so many countries are affected by terrorism. Therefore, America adventurous anti-terrorism policy has been most wanted and relevant actions at present days and it has destroyed the cruel terrorism networks in Afghanistan.

### **America contribution**

After 9/11 incident ,U.S.A goal was to destroy terrorism for world welfare ,in this regard it has done so many rehabilitation and restructuring works inAfghanistana as a humanitarian work of its war made damages in Afghanistan such as:Deployed more than one lack NATO troops for ensure internal afghan peace

- Established hospital ,clinic and sent doctors
- Allotted abundant money for develop Afghanistan education
- Sought Britain ,France ,Japan ,Germany and India help to reconstruct Afghanistan
- Trained afghan military and Afghan National police
- Offered much more military vehicles and airplane and helicopters for its security after its withdrawal
- More NGO have been inducted in Afghanistan for effective social reconstruction
- Provided plenty of facilities to develop hydropower project, science and technology
- Committed in renovation public schools ,civics needs ,security ,business ,livelihood and agriculture
- Arranged necessary facilities for women's developments such as freedom and liberty without fear
- Focusing state wise developments
- Focusing human resource developments ,employment opportunities and entrepreneur atmosphere
- Paying attention at child nutrition development, school feeding programme and dress .Like this plethora of welfare policies regarding to Afghan reconstruction activities by the U.S.A have been don just for fill up the gap of its war damaged infrastructure and shows itself that it is obviously accountable not only for destroy but also to renovate and restructure entire Afghanistan entity with full brightness.

### **What is India Policy?**

India policy in Afghanistan is so many in the area of politics ,economics ,defense ,agriculture ,science and technology ,culture ,telecommunication ,education ,urban development ,and human resource development .All these policies were established through the memorandum of understanding between India and Afghanistan for ensure that India is fluctuations to take part in Afghanistan internal reconstruction programme as a great democratic neighborwith peace laden approach for the welfare of Afghanistan people. Still now India's humanitarian assistances to Afghanistan reached about 2 billion as a great partner as a marvelous regional player from south Asia continent .Its financial assistances secured fifth international donoramong the more than 140 countries which are contributed to the Afghanistan development .This policy has not been doneby India alone, it is done together with world community which are still pertinent for establish a durable peace in Afghanistan

### **What is aim of India's policy?**

India's policy in Afghanistanprimarily was considered as a pro neighbor policy with aim to make peaceful South Asia as well as Central Asia through the strengthening a strong Afghanistan along with cemented infrastructure .India has never involved in Afghanistan reconstruction activities contrary to other country policy or against other country interest or demonstrate its power in SouthAsia through the Afghanistan reconstruction policy. So, its policy is never aimed at countering, control, contain and collide any other country. Therefore, India's policy in Afghanistan is primarily to promote them from the long mourningand weepingsituation to long mesmerism and well-beingsituation based on international humanitarian law .Because, their laughing life will influence positively to make conducive south Asia atmosphere, at the same time their unlaughing situation will influence negatively on both South Asia and India peace and prosperity.

### **What is outcome of India'spolicy?**

Definitely no country could do something to some country without expectation that is either financial or non-financial aspect, in this way India's reconstruction policy in Afghanistan is to stop terrorismattacks in India and pullAfghanistan to India's side for its peaceful future life .This policy created a new theory that is finance giving and peace buying. This India'sattitude is inevitable and obligatory one presently for protect its country and peoples as per its geography location and enemy plane, is waiting to do much more detrimental activities in future .The input of India'sreconstruction policy is to mitigate and allay the Islamic people tension and ill will on India's which rose due to various reason of India- Pakistanconflict, separation and Hindu – Muslimdissimilarity in the India. Thereby ,frequent terrorism attacks on India is due to unbridled angry of Muslim people on India which could be solved only through the soft policy than hard policy .Because ,Muslims are most blessed people in the world with identity of poor ,self-employed ,illiteracy ,entrepreneurs without government support and upper people domination on-Muslim people .Their emotions are true and valuable which should be solved so smoothly through the international negotiations without hurt their heart.

### **Impact of India's policy on Afghan human rights protection**

Its policy has been influencing toward secure human rights in Afghanistan even still now after math of September 9/11.How doe human rights are protected through India's policy? For instance,

people are having their basic inherent rights along with constitutional security and guarantee, at most of occasions their rights are violated by so many reason and at so many situation in the world politics due to power sharing problems, power showing game and power encroaching attitudes. This unpredictable socio, economic and political oriented problems at international and domestic levels have been causing so many resentments among the citizens like war, resurgence ,infiltration ,terrorism ,ethnic conflicts ,inter-community ,caste and political riots .Therefore in this category Afghanistan faced manifold socio ,economic damages by terrorism ,external power intervention and ethnic conflict. By which Afghanistan government could not able to give primary civics needs to its citizens for maintain and run their life according to other country citizen life style .To fill up this expectation of them, September 9/11 made a lucky chance to Afghanistan for draw world assistances. In which India helped more to Afghanistan for protect basic human rights such as school feeding programme ,fellowship to college students ,computer skills training to afghans ,educational exchanging programme ,cultural exchanging programme with fellowship ,self-help group training ,medical facilities ,offered 100 buss ,vocational training, urban and rural development ,toilet construction and Indira Gandhi child hospital and so many administrative training to afghans officials .Therefore, all these human being benefiting polices of India's since 2001-2010 have been immensely protecting human rights by not giving chance to get it violated by any other bad reasons in Afghanistan.

## CONCLUSION

India policy really have made so happy Afghanistan people by its marvelous humanitarian assistances, it has eradicated Afghanistan socio-economic and political defects for Afghanistan entire society benefits as well as developments .The reason for India policy has been so famous in Afghanistan is due to USA brought out Anti-terrorism law as a new world order.This law emboldened India to cooperate with world countries for controlterrorism with all moral supports to Afghanistan. In future, India will get benefit from Afghanistan and Afghanistan will get support from India by both country mutual understanding for develop and recalibrate their national agenda as well as all relevant sources to strengthen socioe-conomic and political developments.However all, success and developments came to both India and Afghanistan through USA Anti-terrorism policy in Afghanistan .Therefore America toiled much more than others to create an affable climate in Afghanistan as well as between India and Afghanistanso, both country should not create gab and give gab as commemoration of USA created relations for South Asia Regional Integrity.

## REFERENCES

1. AU Asif (January1, 2002). "New Phase in Indo-Afghan Relations." *Mill Gazette*, <http://www.millgazette.com/Archives/01012002/0101200223.htm> (accessed June 11, 2010).
2. C. Raja Mohan (2006) "India and the Balance of Power." *Foreign Affairs* 85, no. 4, 17–34.
3. Communiqué of "Afghanistan: The London Conference": Afghan Leadership, Regional Cooperation, International Partnership, 5–6, [http://www.isaf.nato.int/images/stories/File/factsheets/Documents\\_London%20Conference%20on%20Afghanistan.pdf](http://www.isaf.nato.int/images/stories/File/factsheets/Documents_London%20Conference%20on%20Afghanistan.pdf)
4. Devin T Hagerty (1991). "India's Regional Security Doctrine," *Asian Survey* 31, no. 4 351–63; MacDonald, *Indo-U.S. Military Relationship*.
5. De Young "Obama to Explore New Approach in Afghanistan War."

6. Embassy of India (2010). *Information on Hijacked Indian Airlines Flight IC-814*, [http://www.indianembassy.org/archive/IC\\_814.htm#Identity%20of%20hijackers](http://www.indianembassy.org/archive/IC_814.htm#Identity%20of%20hijackers).
7. For details, see the various Government of India Ministry of External Affairs, Annual Reports, <http://meaindia.nic.in/secframe.php?sec=ar>.
8. Government of India (2000-2001) "Ministry of External Affairs, *Ministry of External Affairs Annual Report*" (New Delhi: Ministry of External Affairs, 2001), <http://meaindia.nic.in/>.
9. Juli MacDonald, *Indo-U.S. Military Relationship: Expectations and Perceptions* (Falls Church: Booz Allen Hamilton, 2002)
10. Praveen Swami (2003) "Terrorism in Jammu and Kashmir in theory and practice," *India Review* 2, no. 3 55–88.
11. Robert Matthews and Fionnuala Ní Éigearthaigh (2009) "The Afghanistan Crisis: Regional and International Dimensions" FRIDE Conference Report 10.
12. S. Frederick Starr (March 2005) "A 'Great Central Asia Partnership' for Afghanistan and Its Neighbors," Silk Road Paper, Central Asia-Caucasus Institute.
13. See Olivier Roy (1990). *Islam and Resistance in Afghanistan* (Cambridge: Cambridge University Press,
14. See Fahmida Ashraf (2007) "India-Afghanistan Relations: Post-9/11," *Strategic Studies* 27, no. 2).
15. "Taliban Threatens Retaliation If Iran Strikes," CNN.com, September 15, 1998,
16. "Obama looks to regional allies to stabilize Afghanistan" (January 20, 2009) AFP.
17. The genesis of the term "AfPak" is usefully described in "Team Obama Scuttles the Term 'AfPak'," *foreignpolicyForeignPolicyMagazine, TheCable*, anuary20,2010, [http://thecable.foreignpolicy.com/posts/2010/01/20/team\\_obama\\_scuttles\\_the\\_term\\_Afpak](http://thecable.foreignpolicy.com/posts/2010/01/20/team_obama_scuttles_the_term_Afpak).
18. The White House (March 27, 2009) "Remarks by the President on a New Strategy for Afghanistan and Pakistan", <http://www.whitehouse.gov/the-press-office/remarks-president-a-new-strategy-afghanistan-and-pakistan>.
19. Transcript of remarks by General David H (January 8, 2009)" Petraeus at "Passing the Baton: Foreign Policy Challenges and Opportunities Facing the New Administration" United States Institute of Peace, 25–28.



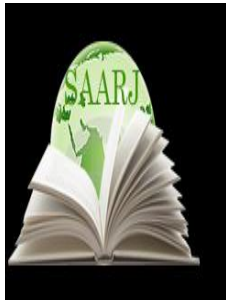

**ACADEMICIA**  
**An International**  
**Multidisciplinary**  
**Research Journal**  
**(Double Blind Refereed & Peer Reviewed Journal)**

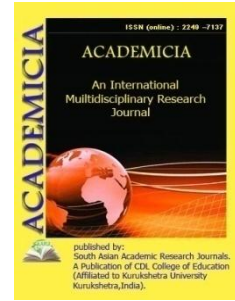

**DOI: 10.5958/2249-7137.2021.01200.3**

**READING CHARACTERISTICS AS A TYPE OF SPEECH ACTIVITY**

**Kholmatova Shakhnoza Muminova\***

\*Senior Lecturer,  
Tashkent State University of Economics,  
UZBEKISTAN

Email id: kholmatova\_1973@mail.ru

**ABSTRACT**

*This article examines the role and significance of reading. As it is known, practical language proficiency is primarily the ability of the student to use the acquired skills in the Russian language in their activities. Reading contributes to the improvement of other types of speech activity and the preservation of knowledge of the language being studied, in particular speaking skills.*

**KEYWORDS:** *Reading, Oral Speech, Enrichment, Text, Speech Development, Retelling, Practical Significance, Assimilation, Perception, Communication.*

**INTRODUCTION**

Communication between people occurs in two ways: by direct exchange of thoughts (oral speech) and indirectly-through a book (writing, reading).

Every year, despite the widespread use of radio and television, the flow of information through the book increases, and the problem of mastering reading as a source of information, a means of educating and training qualified specialists for the national economy becomes of great importance.

As it is known, practical language proficiency is primarily the ability of the student to use the acquired skills in the Russian language in their activities. In comparison with oral speech and writing, the use of reading in practical activities has a number of advantages. Oral communication in Russian is limited due to the lack of a specific language environment, and then reading becomes an important source of information, a means of communication, as well as further development and improvement of the individual. Proficiency in reading is a necessary condition for obtaining a specialty in professional colleges and universities.

Reading contributes to the improvement of other types of speech activity and the preservation of knowledge of the language being studied, in particular speaking skills. In the process of reading, the vocabulary is enriched and fixed, pronouncing skills are practiced, and the possibility of probabilistic forecasting is developed. No wonder in one of his lectures L. V. Shcherba said that the knowledge of the language is kilometers of lines read.

In recent years, in the national groups of universities, teachers in the classroom have begun to pay great attention to the development of oral speech skills. In this regard, reading has become considered as a means of teaching speaking, translation, and retelling, and has lost its significance. This methodological orientation of many teachers has led to the fact that most students of national groups do not have sufficient skills of fluent reading in Russian by the end of their studies.

Reading in a national group is the goal and means of teaching the Russian language. In the first case, it is considered, first of all, as a type of speech activity. In the second - as a means of forming skills and abilities in other types of speech activity, mastering lexical and grammatical material. When teaching, it is important to distinguish between these two concepts – reading as the goal of learning and reading as a means of teaching the Russian language. Tasks that are most often offered to students in textbooks, teaching aids and in the classroom (read and retell the text; read, answer the questions; make a plan; find certain words, sentences, etc.), serve only as a means of teaching oral speech, in particular retelling, mastering lexical and grammatical material, and not as a means of teaching reading as a type of speech activity.

In order for learning to read to be a learning of speech activity, the following requirements must be met.

In real life, we read about ourselves in our native language, and this type of reading helps us to extract the necessary information. Reading aloud performs another communicative function – it helps to convey the received information to the listener. In real communication, it is limited, so it can hardly be the goal of studying in universities.

The reading should be informative. A person in real life reads newspapers, magazines, books in order to learn something new, to get this or that information. The process of reading is very time-consuming, and reading the text, just like that, without receiving information, is naturally impractical. When reading a certain text, there are many difficulties, so students perceive repeated reading without setting a communicative task as an exercise with language material, and not as a type of speech activity aimed at obtaining information.

Thus, the teaching of reading should be structured in such a way that students perceive it as a real activity that has practical significance. This is achieved by being able to read a new text and understand its content, especially if it contains interesting information. Satisfaction with the results, the achieved success convince students of the practical usefulness of this type of work and make them treat reading as a real activity. Students, when transmitting basic information, should be able to formalize it in a certain way in accordance with the norms of the language.

For this reason, it is not recommended to familiarize students with the content of the text in advance. The first text should be read by students, not the teacher, in order to independently carry out the mental work associated with understanding the content.

As for the teacher's exemplary reading, it is necessary only for practicing the reading technique, correctly pronouncing certain difficult words and sentences. It is impractical to give a sample of reading an entire text, since the text contains a large number of different difficulties (both pronounceable and semantic), for example: pronouncing words, setting accents (verbal, phrasal, logical), finding intonation structures, determining the lexical meanings of words and phrases, understanding the content and meaning of the whole text, etc. it is impossible even for an experienced reader to remember all this and then correctly reproduce it in the process of their own reading, so students, listening to the teacher, focus their attention only on understanding the content, and the sample of correct reading remains outside of their attention and, thus, does not contribute to the formation of students' skills of correct reading. Exemplary reading, if it also takes place with closed books, forms students' listening skills, that is, the perception of speech by ear, rather than the skills of reading techniques and understanding, the formation of which is based on visual perception of the text and their own reading.

Students throughout the years of study should feel their progress, that is necessary to ensure the development of reading skills.

Reading, like any activity, is purposeful and motivated. The purpose of reading is to obtain information, the motive is to satisfy the need for information. The result of the reader can be positive and can be negative. If the reading mechanisms are not sufficiently formed, the result will be negative, the reader will not be able to understand the text, extract the necessary information. Work on overcoming technical difficulties in the reading process, that is, improving the reading technique, occurs at all stages of learning, but it is important to build this work so that students gradually increase the speed of reading, the volume and complexity of texts, and the speed of understanding. If there is no dynamic of skills, then the difficulties of the text become insurmountable and students will not be able to achieve the necessary results, that is, to understand the text, so the interest in reading, and at the same time in the Russian language weakens. This attitude to reading is observed among students when the volume of texts for reading increases, and the language capabilities of students remain limited. This leads to a gap between the effort expended (deciphering the text) and the results obtained (reading comprehension).

Before describing the methodology of teaching reading as a type of speech activity, consider the reading process itself, its components.

#### **REFERENCES:**

1. L. V. Shcherba. Selected works on the Russian language. - Publishing house "Flint" - Moscow: 2016
2. Kostomarov V. G. Russian language among other languages of the world. - Moscow: Prosveshchenie, 1975.
3. Kholmatova Sh. M., Abduganieva Sh. M. - The use of video materials in teaching a foreign language. Collection of articles. Materials of the international scientific and practical conference "Maktabgacha talim muassasalarida umumtalim maktablarida va oliy talim muassasalarida chet tillar shkitishning uzviyligi" - Andijan State University. -2020.
4. Skalkin V. L. Typical communicative situation as a structural and thematic basis for teaching oral foreign language speech//Russian language abroad. -1979. No. 5. - p. - 9-15.

5. Kholmatova Sh. M. Practical approach in teaching business Russian speech in economic universities. Proceedings of Ingenious Global Thoughts an International Multidisciplinary Scientific Conference Hosted from San Jose, California November 29th, 2020 <https://conferencepublication.com>

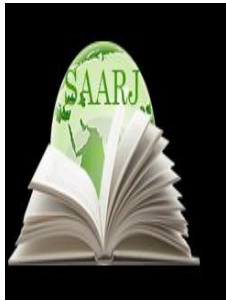

**ACADEMICIA**  
**An International**  
**Multidisciplinary**  
**Research Journal**  
 (Double Blind Refereed & Peer Reviewed Journal)

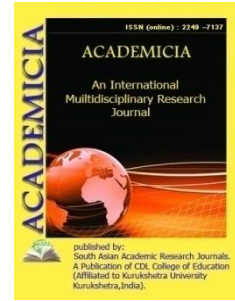

**DOI: 10.5958/2249-7137.2021.01201.5**

## DEVELOPING INTERCULTURAL COMPETENCE OF PUPILS USING AUTHENTIC MATERIALS

**Ostonov Utkir Yangiboyevich\***; **Uralova Charos G'anisherovna\*\***;  
**Babayeva Dilbar Xabibjanovna\*\*\***

\*Senior Teacher,  
 Samarkand Institute of Economics and service,  
 UZBEKISTAN  
 Email id: vatkan77@mail.ru

\*\*Student of Samarkand State Institute of Foreign Languages,  
 UZBEKISTAN  
 Email id: charosuralova99@gmail.com

\*\*\*PhD Teacher,  
 Samarkand State Medical Institute,  
 UZBEKISTAN

### ABSTRACT

*This article discusses the importance of computer in teaching pupils, materials and methods of intercultural communicative competence and also teaching aids for the development of ICC. Consequently, foreign language teachers are often confused and do not know which aspects of culture to teach, what materials to use and what teaching techniques to use with the aim of developing intercultural communicative competences of their learners. They vary from culture to culture and can cause great misunderstandings if perceived or performed inappropriately. There are a lot of materials that could be used in teaching culture. Several English language textbooks offer materials developing ICC in separate parts called cultural pages. Furthermore, English language teachers can develop their creativity when designing and adapting material to promote more learning of the target language and its use.*

**KEYWORDS:** *CEFR, ICC, Computer Science, Global Economy, Technology.*

## INTRODUCTION

Authentic materials are believed to be the best types of materials for developing intercultural communicative competences of foreign language learners. Authentic materials bridge the gap between the classroom and the outside world and they bring reality to the classroom. Authentic materials are those which were not created or edited for language learners, consequently most everyday objects in the target language qualify as authentic materials. Exposure to the authentic materials allows language learners to make contact with the real-life language, customs and way of life of the target culture. Using authentic materials in teaching culture is a great motivational factor and it helps learners to recognize that there is a community of users who live their lives in this other language. Authentic materials include audio, visual and printed materials. This paper discusses and gives examples of activities how to use authentic materials in developing socio-cultural knowledge, sociolinguistic competences, pragmatic competences and non-verbal communication. The CEFR, which serves as the base document for developing national curricula, also emphasizes development of ICC. However, the CEFR does not elaborate on the development of ICC for each level of proficiency. The CEFR only describes the competences in general, and the aspects of ICC are only included in individual competences and therefore the connection with ICC is not immediately obvious. Consequently, foreign language teachers are often confused and do not know which aspects of culture to teach, what materials to use and what teaching techniques to use with the aim of developing intercultural communicative competences of their learners. Based on CEFR, general and communicative competences connected to culture have been excerpted and summarized and put into clear diagrams, which can serve as a basis for cultural teaching. In the component of socio cultural knowledge the empirical knowledge relating to day-to-day living, shared values, beliefs, history and taboos of social groups is considered to be essential to intercultural communication. Existential competence is considered to be culture related as it includes the sum of personal characteristics, personality traits, attitudes, self-image and one's view of others. Skills of cultural awareness, to see contrast between own and target culture and ability to overcome stereotypes are important components of ICC. Sociolinguistic competences refer to linguistic markers of social conventions use and choice of greetings, address forms, turn taking, rules of politeness, register differences. Pragmatic competences are concerned with the functional use of the language. The cultural component is very important here, as it includes suggestions, requests, introductions, invitations, correct use of please and thank you, etc. Non-verbal communication is an important part of intercultural communication. Paralinguistic features, such as gestures, facial expressions, eye contact, body contact, proxemics; extra-linguistic speech sounds for expressing silence, happiness, disgust, approval, disapproval, and prosodic features such as loudness, pitch of the voice are very delicate features in intercultural communication. They vary from culture to culture and can cause great misunderstandings if perceived or performed inappropriately. There are a lot of materials that could be used in teaching culture. Several English language textbooks offer materials developing ICC in separate parts called cultural pages. However, it is often difficult to convince English teachers that the teaching of culture is not a secondary goal. Culture is an inseparable part of foreign language teaching, because language without culture is a set of symbols which can be misinterpreted, if they are not understood in the right cultural context. Nowadays, authors of English language textbooks are aware of the necessity to develop ICC of learners and are trying to make more effort to create culturally relevant texts, recordings and activities. However, materials in English language textbooks are adapted materials, which have

great advantages, but also disadvantages. One of the greatest advantages is that they are designed according to the pedagogical and psychological characteristics of the learners. They are created for a particular age group, language proficiency and suitable topic, and they are easier to use for foreign language teachers. The greatest disadvantage of adapted materials is that information can be quickly out of date, e.g. when teaching popular arts, which are popular and motivational topics for young learners. Textbooks often use fabricated texts travel stories or visits by families to foreign countries and these have a tendency to feel forced and irrelevant. Another disadvantage is that adapted materials do not always use real everyday language, nor portray real picture of foreign cultures. Adapted materials are limited to texts, pictures, audio and video recordings authentic materials offer more resources. The Intercultural Communicative Competence allows individuals to relate with the world around them, by being aware of their own cultural identity, appreciating other people's cultural differences and being able to express themselves accurately in another language. Unfortunately, this capacity is overlooked in our English teaching settings. This project aimed to foster the Intercultural communicative competence through the implementation and adaptation of materials for cultural awareness with eleventh graders at a public school. In this qualitative action research three instruments were used to collect the data during the implementation of the worksheets with cultural content, a survey, artifacts and teacher's journal. The results of the intervention showed that the inclusion of cultural topics as well as the variety of activities made the materials appealing for students, which led to an innovation in the classroom that fostered learning in a meaningful way.

In today's digital world, computer science is a critical field of study that offers a limitless amount of opportunities for both academic and technological growth. Since the invention of the internet, the development of new computing technologies has steadily increased, leading to fundamental change in the way we live and work. It is hard to imagine a life without computers, laptops, mobiles and tablets, but without computer science, that is exactly what we would have. As computing technologies continue to rapidly expand and evolve, why are many schools still reluctant to harness the countless benefits of teaching computer science? Taking basic knowledge as well as skills to operate computers to perform better jobs. Computer education is all about extending to its various branches of study in different sectors. Computer, along with internet facility is the most powerful device that children can use to learn new abilities in education. Computer plays a significant role in each n every field of life. They help us in several ways. For example, they find applications in medicine, industrial process, aviation industry, making bills in various big shops, creating presentation slides in application software for making delivering lectures in colleges, universities and a lot more. In short, not only in just one, but the Computer plays an all-rounder role in the field of education of students. Innovation in computer technology has a profound impact on education. It forms a part of the school curriculum as it is an essential part of every individual today. Computer education in schools plays a major noteworthy role in the career development of young children. Being actively used in various educational institutes like schools, college's big universities, computers are used to aid the learning process of students. Professors in college's teachers in schools take help of audio visual techniques to prepare lesson plans for children<sup>1</sup>. For this, they use Microsoft power point to prepare electronic presentations about their lectures. These electronic presentations can be shown on multimedia and sound projectors in classrooms. It is an interesting and simple method to learn for students. Multimedia presentations are easy to deliver for teachers also as these presentations spare a great deal of time and effort. Computers can be used for online education research. With

the help of the internet, students can find useful information about their projects, assignments and also can take useful help from other researchers as they organize their research materials in computers. In computer based training, various educational programs are prepared or set up with the assistance of expert educators and audio-visual media help. These educational programs are generally set up in the shape of lectures on a specific topic are given on CDs. Students can learn when they wish at their homes. Immense storage is yet another main great characteristic of a computer. Students and teachers can download and store a lot of educational materials, books, presentations, address notes, question papers, and so on in computers. Students can find many different ways to solve a certain problem given to them. Through computer, they can interact with people having same decisions. Speed is the fundamental attributes of a computer. We can easily find information with just a single touch of a button. One of the primary uses of computers in education is the access to the internet for information search about any topic. Appealing and better introduction presentation of data through applications programming software like microsoft PowerPoint to introductions for creating splendid presentations for notes. Another main advantage of using computers in the education field is the improvement in the quality of teaching-learning process and communication between students and teachers. For this, they use microsoft powerpoint to prepare electronic presentations about their lectures. Computer revolutionizes the way of study while making education smoother and quicker. It also connects us to different sources, which show us different ways to understand a particular topic or idea. In general, a computer has helped the education world and also has changed the way we learn. The kids of today they tap, swipe and pinch their way through the world. But unless we give them tools to build with computers, we are raising only consumers instead of creators. Through her book, children learn technology through play, and understand the curriculum of coding through the eyes of a six year old. Her goal in working with children, encouraging them to dream and imagine the possibilities of what they could create using computers, comes with the moment when a kid realizes the world is definitely not ready yet. A really awesome way of making the world more ready is by building technology, and that each one of us can be a part of that change. In front of the monitor, moments become hours, appearing often reproaches from parents, like why to play in place to learn. Software manufacturers have tried to combine this two sides and so was both computer aided. Whether for websites or the products distributed on CD, as example this work. Students who use computer for learning at home, achieved higher scores than other children, is because lessons at the computer completes teacher explanations with multimedia elements and virtual experiments. In this case students understand and retain easier difficult topics from books. The role of computer in teaching activities is becoming more important because world is in a continuous and rapid modernization. The computer plays an important role in teaching and learning process. We live in a world where changes are made with high steps, and we must keep up with them<sup>2</sup>. The computer can be used in teaching-learning of play form, drawing the children. Computer use in school has and will have a great role in the presentations of lessons, and for communication and information. A test conducted by electronic means has various advantages among direct monitoring by the teacher in a virtual class, the results can be stored in databases is different draw conclusions on the evolution of each particular student and his performances can be available to test different data can be accessed repeatedly, leading to an adaptable and flexible learning and assessment, as part of a complex mechanism of the educational process. Computer training is the way in which the interaction of teaching and learning, between teacher and students, is the means of this computer. Integrating computers in



teaching refers to how information and tasks contained in software work is articulated with other sequences of training and responding to objectives pursued by the teacher. Proper handling of the computer itself can be done by teachers or by students, depending on the task of learning content and specific situation in which the learning. If we know how to weave the traditional with the modern lesson, if we managed to make students to participate in their training, if they educate students who will know how to find certain truths, proves that the methods used by us in the educational process were most suitable, we chose the best way. Using the computer as a tool in teaching school subjects lead to the development of critical thinking, allowing students to demonstrate spontaneous. Satisfaction of the highlights is the talent to make their own creation.

There are a lot of materials that could be used in teaching culture. Several English language textbooks offer materials developing language. However, it is often difficult to convince English teachers that the teaching of culture is not a secondary goal. Culture is an inseparable part of foreign language, because language without culture is a set of symbols which can be misinterpreted, if they are not understood in the right cultural context. Nowadays, authors of English language textbooks are aware of the necessity to develop of learners and are trying to make more effort to create culturally relevant texts, recordings and activities. However, materials in English language textbooks are adapted materials, which have great advantages, but also disadvantages. One of the greatest advantages is that they are designed according to the pedagogical and psychological characteristics of the learners. They are created for a particular age group, language proficiency and suitable topic, and they are easier to use for foreign language teachers. The greatest disadvantage of adapted materials is that information can be quickly out of date. when teaching popular arts, which are popular and motivational topics for young learners. Textbooks often use fabricated and these have a tendency to feel forced and irrelevant. Another disadvantage is that adapted materials do not always use real everyday language, nor portray real picture of foreign cultures.<sup>3</sup> Adapted materials are limited to texts, pictures, audio and video recordings. Authentic materials are with no doubt the best materials for teaching cultural aspects, as they bridge the gap between the classroom and the outside world and they bring reality to the classroom. The use of authentic materials in EFL classrooms may be useful for teachers and students to develop not only grammatical skills but also to reinforce students' ability to understand and contextualize the language used in the classroom and the language people use in other social contexts. Furthermore, English language teachers can develop their creativity when designing and adapting material to promote more learning of the target language and its use. For the development of this project, authentic materials are taken as the material that is not designed for teaching purposes, it means that the material utilized is not commercially produced to teach a target language itself, which can include EFL textbooks, audiotapes, workbooks, worksheets. Furthermore, the students participating in the study had the opportunity to share what they had learnt from those tasks with their classmates. These students designed and used posters, brochures, and videos for sharing what they had learnt from the tasks developed. There are several differences between authentic materials and no authentic materials in terms of spoken language. For example, conversations recorded for language texts often have a slow pace, have particular structures which recur with obtrusive frequency, and have very distinct turn-taking of speakers. Also, hesitations are often missing, and sentences are very well-formed with few if any mistakes. In other words, what the language learners hear in class is different from the language in other social contexts. In one of the semi-structured interviews, for instance, the participating students claimed feeling nervous when speaking in English due to

feeling afraid of making mistakes or misusing the grammar rules. In many cases, the language heard in EFL classrooms is a stilted use of spoken English; the real objective of teaching this language is lost because of a need to teach specific language points in a method that some teachers may feel would be more understandable for learners. Authentic materials as spoken or written language data that have been produced in the course of genuine communication, and not specifically written for purposes of language teaching. In fact, in his teaching practices, he encourages students to bring into the classroom their own samples of authentic language data from real world contexts outside of the classroom. In this sense, the use of authentic materials to address cultural topics in an EFL classroom allows students to practice real language, to listen to different accents, understand their classmates, and make themselves understood. Authentic materials focus mainly on contents and meaning and not on linguistic forms and structures. Authentic materials do not replace textbooks, but could be very beneficial additional materials or a substitution for certain texts that might not be well suited for the specific classroom. Most everyday objects in the target language qualify as authentic materials. Authentic materials are those which were not created or edited for language learners. Exposure to the authentic materials allows language learners to make contact with the real-life language, which can be a great motivational factor and it helps them to recognize that there is a community of users who live their lives in this other language. Authentic materials include audio, visual and printed materials. There is a great choice of authentic materials, which could be used in teaching culture in foreign language lessons, but teachers need to pay a lot of attention in choosing appropriate materials. Teachers should set up criteria for selecting materials, which would suit the specific groups of learners. The materials should fulfill the requirements of the curriculum topics, interest of learners, usefulness, language level, age and background knowledge of learners. The authentic materials need to be culturally appropriate, but at the same time comprehensible for learners of English as a foreign language. It needs to be kept in mind, that authentic materials are based on native speakers' culture, which might appear alien or inappropriate to language learners. There are several steps in using authentic materials in teaching English. The first step is to identify learners' needs and goals for learning target language and culture. Learners should be invited to participate in the process of choosing authentic materials, for example they are asked to bring recipes, newspapers, labels and other non-school materials to the classroom<sup>4</sup>. Learners might consider these materials inappropriate for school, based on their earlier academic experiences. Teachers should discuss with learners the aim and rationale for using authentic and their connection with target culture. Teachers and learners could become partners in collecting materials. Authentic materials are easily and inexpensively obtainable. Especially the internet is a rich source of all kinds of materials. The authentic materials should be suitable in content interesting and relevant, exploitability the way authentic materials could be used and comprehensibility appropriate level of language. Benefits of authentic materials in developing intercultural communicative competences are immense. They remind learners that there is a real world community that functions exclusively through the use of the target language. Authentic materials help learners to use language in real life like situations. Learners are exposed to the real use of language and they are immersed into the real world of the target culture while they are in the classroom. Authentic materials, especially texts, videos, songs need to be actual, as they are culturally sensitive and can become quickly out of date. They can be used for all language levels, from basic to advanced, but need to be carefully chosen. Finally, they have a positive effect on learner motivation as they provide real cultural information and exposure to real language. For

example, it is more beneficial to use a current newspaper to search for relevant and up to date weather forecast, than to use an out dated text for searching nouns or verbs which is a typical school based approach. Authentic materials are exciting to use, but it is inevitable that we might face some problems. Certainly, there are disadvantages with authentic materials. First of all they are very difficult and time consuming to choose culturally appropriate, up to date and comprehensible materials. Real life language is often difficult to understand, as it uses dialect words, idioms, complex language structures. Language can be culturally biased for certain groups of people and learners might have problems decoding the language. Unsympathetically used can cause frustration with the language learners. Listening to authentic language can also cause problems, as there are many different dialects and accents. Although, there are some disadvantages with using authentic materials, but there are still many more advantages, especially with developing intercultural communicative competences of learners. In fact, it is hardly possible to develop ICC without using authentic materials, particularly the sociolinguistic, pragmatic and non verbal competences.

To be more practical and specific, several activities using authentic materials with the aim of developing intercultural communicative competences are listed here. A controversial view of authentic tasks by noting that there is probably no such thing as real task authenticity since classrooms are, by nature artificial. However, it is the relationship between the learner and the input text, and the learner's response to it, that should be characterized as authentic, rather than the input text itself. Thus in foreign language learning contexts, where exposure to the language being learned is scarce, English language teachers should create paces within the classrooms with the objective of making students have access to authentic tasks that permit them to study the language structure and to focus on more than one skill at the same time.

It was common to assign pedagogical tasks to students to grade them about a single grammatical structure and almost always by using only one skill per task, as a result, students came to believe that the English language was something they learned by pieces and not being able to use it to know or talk about their own culture and others. Thus, there was an imperative need to implement tasks which would facilitate learners to meaningfully and purposefully use English within varied contexts and contents, valuing these rather than merely grammar structures.

Teachers should develop materials because it is like embarking upon a fascinating task that allows your imagination to fly and go far beyond your capabilities. It could also be living an enjoyable and rewarding experience that implies careful thought, fondness, inspiration, originality and the occasion for you and your students to develop both personally and professionally. This is basically an invitation for us, teachers to rely on our own capacities to be innovators in the classroom, to love our labor, and to find inspiration on everything we see to transform our labor into a tool to boost learning as well as to develop ourselves as people and professionals. Being able to design materials is an aspect that leads us teachers to reflect upon our own teaching practices, finding ways to adjust them in order to innovate as well as influence our contexts.<sup>5</sup> Moreover, materials development guides us teachers to select proper materials that meet the objectives of our classes and gives us self-confidence in the processes we carry out in the classroom. Teachers become innovation leaders in our own classrooms by means of teacher developed materials that are the result of teachers' reflection on the learning process and the appreciation of the EFL setting. This helps us to realize that students are integral human beings that have different learning styles and rhythms, abilities, interests, experiences and knowledge of

their own. Thus, we are able to make decisions to readjust our practice to meet students' needs and make them feel motivated and engaged in their own learning process and not frustrated in their language acquisition. Furthermore, teachers have to consider our learners needs, expectations, contexts, learning styles and multiple intelligences. Moreover, the way the input is presented has to be catchy and easily understood by the students; the activities have to be designed in a way that students find them challenging but not frustrating, and also meaningful and relevant to their lives. In other words, teacher developed materials are the best way in which we can put our creativity, commitment and knowledge in-action at the service of our learners since we understand that it is our responsibility to create proper learning environments that can benefit them. Consequently, our practice can address all of our students' dimensions as human beings because we have the option to put different strategies into practice to reach realistic goals in our courses within specific contexts. One way to define realistic goals that we need to consider at the moment of applying teacher developed materials is through syllabus design. Firstly, language focus in which the author gives many syllabi possibilities depending on how language teaching is perceived Structural, Situational, Theme based, Functional, Competency based, Task based, Content based and Skill based. Secondly, learning and the learner focus that implies the perspectives of the students in terms of learning strategies that are known as the steps to guide them, the interpersonal skills that rely on interactions as a learning booster, and finally, the affective goals that imply students' attitudes towards learning and the target language and its culture. Thirdly, social context that deals with aspects such as socio linguistic proper use of language depending on the situations, socio political critical thinking and effective participation in the society and socio cultural cultural understanding in terms of identity, customs and behavior. The experience of learning another language is more than simply the acquisition of an alternative means of expression. It involves a process of acculturation, akin to the effort required of the traveler, striving to come to terms with different social structures, different assumptions and different expectations. In this sense, learning another language entails being sensitive to a different culture which means understanding other perspectives, customs and world visions; and finally, adapting oneself to them. Therefore, all the theory that has been addressed so far made me aware of the necessity of designing materials as a way to innovate in the classroom. One way to reach these innovations is by using materials that give students opportunities to acquire that sensitiveness to cultural differences. Based on the aforementioned assumptions, I will describe what materials for cultural awareness, as one of my main constructs, entails. The experience of learning another language is more than simply the acquisition of an alternative means of expression. It involves a process of acculturation, akin to the effort required of the traveler, striving to come to terms with different social structures, different assumptions and different expectations. In this sense, learning another language entails being sensitive to a different culture which means understanding other perspectives, customs and world visions, and finally, adapting oneself to them. Therefore, all the theory that has been addressed so far made me aware of the necessity of designing materials as a way to innovate in the classroom. One way to reach these innovations is by using materials that give students opportunities to acquire that sensitiveness to cultural differences<sup>6</sup>. Based on the aforementioned assumptions, I will describe what materials for cultural awareness, as one of my main constructs, entails. As a starting point, it is important to define Materials as anything used by teachers or learners to facilitate the learning of a language. Materials could obviously include cassettes, videos, CD Roms, DVD's, dictionaries, grammar books, readers, workbooks, photocopied exercises, all kinds of realia, lectures and talks by guest

speakers, Internet sources, and so on. This spectrum of teaching resources has indeed opened up to other types of materials contrasting with the old idea that language teaching materials were just the course books. Materials as the center of instruction and one of the most important influences on what goes on in the classroom. Undoubtedly, this definition represents a great responsibility on the part of the teachers who must seriously consider what materials to use in their classrooms. Another basic and very essential concept that calls out for definition is materials development. As anything which is done by writers, teachers or learners to provide sources of language input and to exploit those sources in ways which maximize the likelihood of intake, in other words the supplying of information about or experience of the language in ways designed to promote language learning. To the previous definition I would add that materials development encompasses any kind of activity or exercise games, role plays, readings, problem solving situations, group discussion. totally developed from raw texts, with or without pedagogical purposes, for the students' level and created to address a section of the course content, that seems to be weak or lack further development or practice. materials development ranges from creating a short grammar exercise to writing a complete textbook. Some teachers may question the need to develop or adapt teaching materials if everything they need is already in a textbook elaborated by people who really know. Being this a very valid opinion, it is necessary to analyze the positive and negative aspects of using a textbook, and from there, discuss the need to develop and adapt materials. Books provide a grammatical and functional framework from within we could work. It is a nonsense to argue that this framework is never the same from one group to another even though the ultimate, specific uses two groups may make of language may differ. The framework is as much a result of the language itself as it is of the learner's needs. Almost always a textbook can be found which will provide the core language which is necessary and useful for a group whose needs may at first seem unique.

Nowadays the world experiences significant changes. Global economy has influenced the way countries establish and maintain relationships. Advances in technology have enabled people to be in touch and communicate in real time despite the geographical distances. Furthermore, in the last two decades people have been able to mobilize more easily around the world. All these changes have encouraged socio-cultural encounters between individuals of different cultural backgrounds. This is the picture of societies today. There are no boundaries for intercultural encounters. Today, societies are multicultural entities where individuals display and share multiple identities. These identities bind them to particular social groups and their cultural practices. It is clear that in multicultural societies language becomes not only the means of reference but also the instrument that carries cultural meanings that help to maintain a speaker's sense of belonging to particular social groups. To understand clearly what ICC means, it is necessary to think of a communicative situation in which people from different cultures or backgrounds- interact and bring to the situation their knowledge, their awareness of similarities and differences, their beliefs, their attitudes, their behaviours, their skills and their languages to negotiate meanings and establish effective interpersonal relationship<sup>7</sup>. It is clear that in this process none of the interlocutors are tabula rasas. Materials could serve as the auxiliary means to promote mutual understandings between people and cultures as well as powerful tools to deal with cultural diversity. In a like manner, materials might contribute to broaden students' perceptions about cultures and empower them to develop social behaviours such as tolerance and respect towards diversity. Through materials students are aware of how other people do things differently. How people live and behave in different ways. Also they can develop positive social

attitudes towards difference. These are fundamental behaviours individuals require for the development of ICC.

It is true that materials are culturally loaded and are influenced by social context. Of interest here is to mention that despite innovative ideas of how to bring cultural explanations to the classroom, course books stay with the idea of language training. In some ELT course books iconic, tourist brochure images of material that is more representative of the multicultural diversity of contemporary. The idea of language training remains but the new texts and visuals are just contextual backdrops to language tasks.<sup>8</sup> Additionally, the majority of course books are designed to function in as diverse a market as possible, materials design is rarely capable of encompassing the learner's cultural identity as part of the learning process. At most, learners may be called upon to comment on superficial differences at the level of observable behaviours. Clearly, cultural information in course books is still treated incidentally or even worse it is treated as additional information. Students are not required to compare cultural similarities and differences, or integrate new information to their scheme of thought, or to relate their experiences with the experiences of others. In conclusion, the subculture of the language learner and the small culture of the classroom tend not to be addressed. Although it is mentioned some foundation principles of ICC, we need to know which specific principles are linked to the purpose of developing materials for ICC. These can be grouped in three main categories which are related to whether materials allow learners to have intercultural experiences. Materials for ICC should promote among other things:

- An experiential learning
- A structured approach to intercultural learning
- An intercultural learning linked to a language learning

Intercultural learning implies experiential learning. It is not sufficient to read books or to listen to lectures about other cultures. It is necessary to be confronted with new unknown situations, to experience insecurity, fear, rejection as well as security, trust and sympathy, and to deal with the subject of culture on an emotional level. In fact, this is one of the main characteristics of the text driven approach for materials development learners experience texts emotionally. Generally texts, in this approach, are characterised as cultural artifacts, a piece of literature, an article, a song etc, which enable learners to acquire a language. The approach of learning experientially is linked to the left and right hemispheres of our brains. The left hemisphere is concerned with learning that is analytical, rational, intellectual and numerical, whereas the right hemisphere deals with the experiential, the visual, the imaginative, the intuitive, the spatial. Since culture is reflected in both parts of our personality, materials should address both parts to guarantee an intercultural learning experience.

A triangular didactic involves a three point relationship you, me and a common theme or project that is pursued jointly. Working together on a specific project makes cultural differences and cultural conflicts visible. Intercultural learning means how to deal with these differences and conflicts when doing a common task. We can have a list of projects but, of course, they change according to the curriculum and the school. It could be something of general concern, like environmental issues, nuclear energy, European integration, etc. Or, It could be related to politics, economy, society or the culture of the countries, such as comparisons of the educational systems, political decision-making processes, lifestyles, etc. It could also be related to specific

subjects like history, science, business. The idea of the projects is that pupils will be learning together and learning from each other. Finally, we have to say that language learning is an essential element of intercultural learning. In bicultural or multicultural classroom situations, a major emphasis is put on the minority cultural language groups to learn the teaching language, which is normally the language of the majority culture or language group. Ideally, teaching would be done bilingually.

#### REFERENCES:

1. Alptekin C. Towards intercultural communicative competence in ELT. *ELT Journal*, 2002, 56 (1), P. 46–54.
2. Anderson C. Phillipson's children. *Language and intercultural communication*, 3(1), 2003, P.81-94.
3. Bredella L., Christ H. Didaktik des Fremdverstehens – Ein Forschungsprogramm im Rahmen der Graduiertenförderungen. *Aglistik*, 5 (2), 2005, P. 3–16.
4. Brumfit C. British Studies: an educational perspective. In: S. Bassnett (Ed.), *Studying British Cultures. An Introduction*. – London: Routledge, 1997. – P. 39–53.
5. Buttjes D. Culture in German foreign language teaching: making use of an ambiguous past. In D. Buttjes and M. Byram (Eds.), *Mediating languages and cultures*. – Clevedon: Multilingual Matters, 1990. – P. 3–16.
6. Byram M., Flemming M. *Language learning in intercultural perspective*. – Cambridge: Cambridge University Press, 1998. – 236 p.
7. Canale M., Swain M. Theoretical bases of communicative approaches to second language teaching and testing. *Applied Linguistics*, 1980, 1. – P. 1–47.
8. Gray J. The global coursebook in English language teaching. In D. Block and D. Cameron (Eds.), *Globalization & language teaching*. – London: Routledge, 2002. – P.151–167.
9. Gray R., Stockwell G. Using computer mediated communication for language and culture acquisition. *On-CALL* 12 (3), 1998. – 10 p. Retrieved 17 August, 2003
10. Kramer J. Area studies. In M. Byram (Ed.), *Routledge encyclopaedia of language teaching and learning*. – London: Routledge, 2000. – P. 41–48.



**ACADEMICIA**  
**An International  
 Multidisciplinary  
 Research Journal**  
 (Double Blind Refereed & Peer Reviewed Journal)

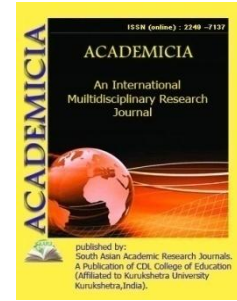

**DOI: 10.5958/2249-7137.2021.01202.7**

## THE IMPORTANCE OF MARKETING ACTIVITIES IN PLACEMENT TOOLS

**Salimova Sarvinov Fazliddin kizi\***

Master's student,  
 Department of Tourism and Hotel business,  
 Bukhara State University, Bukhara, UZBEKISTAN

### ABSTRACT

*The article scientifically proves the importance of marketing activities in and how important it is in hotel operations, with a systematic approach by the consumer and the manufacturer, as well as the need to segment the service market in the development of marketing strategies. Because customer loyalty is important, salespeople and executives spend a lot of time and resources to increase brand awareness and create consistent, interrelated campaigns. Offering hotel accommodation to a large number of customers is gradually becoming a thing of the past. It is necessary to clearly define the type of goods and services to meet the needs of any narrow category of travelers.*

**KEYWORDS:** *Marketing, Marketing Of Placement Tools, Market Segmentation.*

### INTRODUCTION

In the twentieth century, the use of marketing in almost all industries and sectors of many countries has increased. Tourism also has economic and social potential and plays an important role in a market economy. Today, the tourism industry is a lucrative industry. There are many opportunities for tourism in Uzbekistan. In this regard, President Shavkat Mirziyoyev said in his address to the Oliy Majlis on December 28, 2018, "Tourism in our country is often limited to our ancient cities, historical and cultural monuments. However, the unique nature of our country, national reserves, mountainous areas have great potential for tourism development. In particular, the development of medical tourism, pilgrimage tourism and ecotourism will give a great impetus not only to the development of the economy, but also the social sphere.

This, in turn, will help improve the living standards of the population. The opportunities in the tourism industry are huge. In the context of foreign standards, the tourism environment is rapidly evolving and the services they provide are based on well-developed marketing activities. It is



very important to form marketing activities in the means of placement, which is the main infrastructure of tourism. However, the number of placement facilities across the country was 1,188 in 2020, 1,128 in 2019, and 914 in 2018. It can be seen that the number of residential buildings increased by 214 in 2019 compared to 2018, and by 60 in 2020 compared to 2019 (Figure 1).

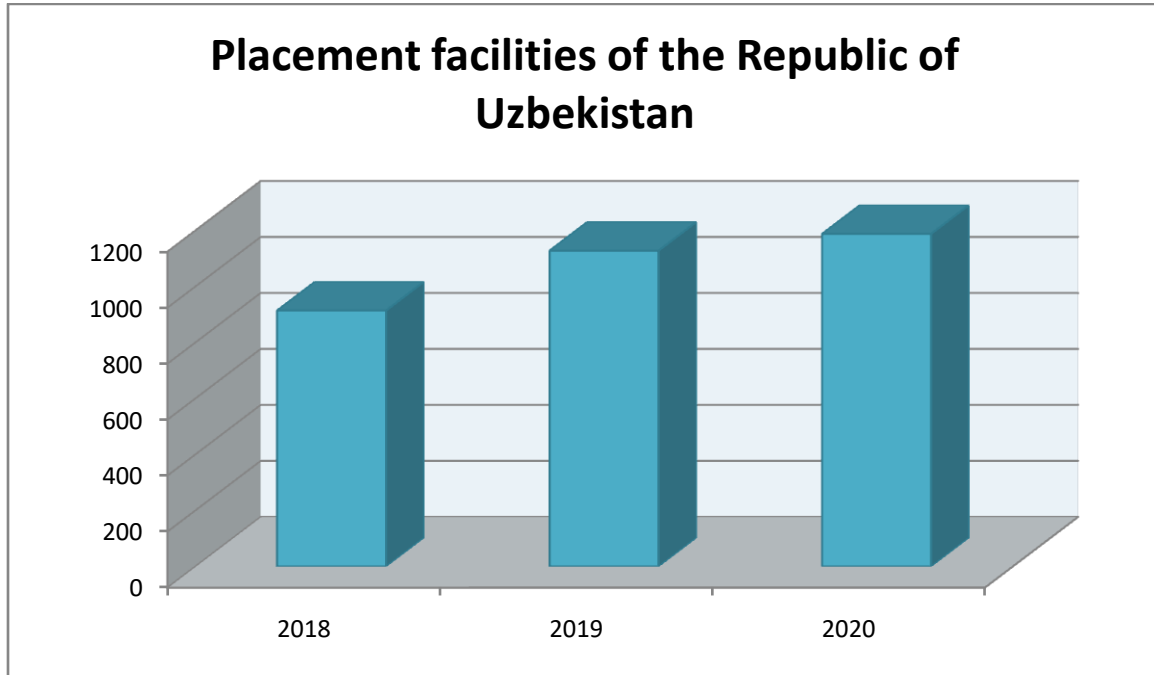

**Figure 1. Placement facilities of the Republic of Uzbekistan over the years<sup>1</sup>**

These figures undoubtedly testify to the rapid growth and development of the hospitality industry. So it is indispensable to conduct marketing activities in order to achieve strong competitiveness in the placement vehicle business.

## REFERENCES AND METHODOLOGY

Marketing is an important element in running any business. Although this has been proven to be an essential factor in determining the success of any hotel unit, it is a commonly accepted occurrence.

The term "marketing" originated in the American economic literature in the nineteenth and early twentieth century's, and is derived from the English word "market", which literally means to "trade in the market"<sup>2</sup>. The term marketing is interpreted differently in different sources. In defining this word, we think it is impossible not to turn to Philip Kotler, the American scientist who is the father of marketing. He defined the term: "Marketing is a customer-oriented business approach. This client should always be the focus of the whole organization"<sup>3</sup>. According to him, the company should focus not only on profit, but also on meeting the needs of the customer, offering him quality goods and services.

British scholars – David Bowie, Francis Buttle, Maureen Brookes, Anastasia Mariussen cited the descriptions of two marketing organizations in the book Hospitality Marketing. These are the

American Marketing Association (AMA) and the British Marketing Charter Institute (CIM). They cite the following definitions of marketing:

“Marketing is a set of institutions and processes for creating, delivering, and sharing offers that are valuable to customers, clients, partners, and society as a whole. (AMA)

Marketing is a management process that is responsible for identifying, forecasting, and profiting customer needs. (CIM)

The AMA definition emphasizes the importance of value creation. It has value when customers use or consume a product or service. This is called usage value. Food in a restaurant or hotel doesn't matter as long as consumers don't use or consume it. The CIM definition emphasizes the importance of customer satisfaction. The common requirement of every customer to combine the two definitions is to feel the value”<sup>4</sup>, - they define in this way.

Marketing includes different types of activities:

1. Disclosure of the wishes and needs of the consumer.

Successful companies constantly monitor their guests and strive to improve service capabilities.

When given the opportunity, guests are willing to tell themselves exactly what is appropriate and what needs to be improved in the service. It is important for leaders to learn to listen to their guests and do what they recommend.

2. Creating a set of goods and services that meet the desires and needs.

Every year new goods and services are created and enter the market. Only in recent years have the hotel business, “apartment” class hotels, hostels and many other types of hotels emerged. Studying the market requirements leads to offering consumers a variety of hotel services.

3. Marketing of goods and services and sale of created goods and services in order to create an acceptable level of profitability of the enterprise.

It takes a lot of strength, ingenuity and ingenuity to be successful. The key to success is based on conveying relevant customer information and provoking his or her response through promotional publications filled with various commercial offers, which, at best, can lead to the purchase of company services.

The final step in marketing is to create an acceptable level of revenue. This is exactly what everyone strives to achieve, but only successful companies achieve it<sup>5</sup>.

Modern marketing is not only one of the tasks of a business, but also its philosophy, type of thinking, way of creating and understanding a business. A marketing tool should never be used to deceive a customer or damage a company's reputation. Marketing is the creation of a combination of goods and services that provide the customer with the desired value, motivating them to purchase those goods and services and meeting his or her real needs.

Marketing in the service sector has its own characteristics compared to other commercial activities.

The highest priority of the placement tools marketing concept is to meet the wishes and needs of the customers. The management of placement tools focuses on meeting customer needs rather

than focusing on profit first, achieving more financially rewarding results, and then providing excellent customer service.

## THE RESULTS

To understand the importance of marketing activities in placement tools, it is necessary to approach it from different angles: by the manufacturer and the customer (Figure 2).

**Figure 2. Placement marketing<sup>6</sup>**

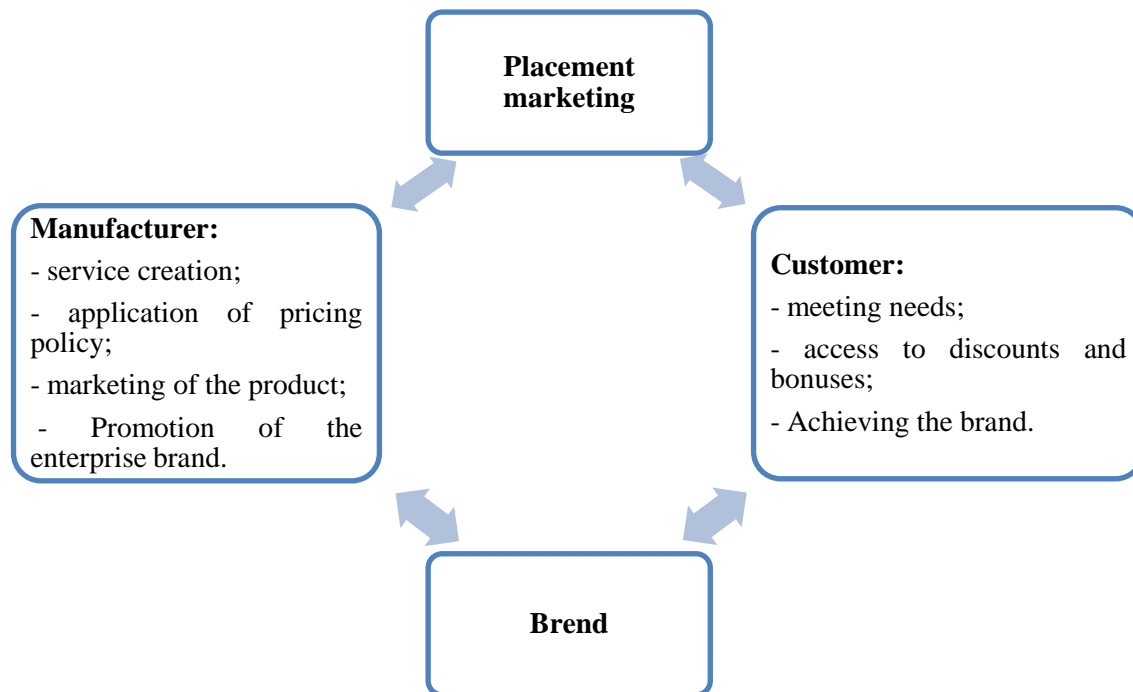

Of course, in order to fully cover the marketing of accommodation facilities, it requires a systematic study from the point of view of the manufacturer (i.e. hotel and other accommodation facilities) and the customer. At first glance, their goals may seem different, but from a single brand perspective, their goals are similar. Because the hotel wants to create its own brand and be known all over the world, and the customer wants to spend the night in this hotel, using the services of this famous brand. In short, placement marketing means meeting the customer's needs, offering discounts and bonuses through the manufacturer's creation of services, application of pricing policies, product launches and brand promotion, as well as motivation to achieve the brand.

So, it is very important to create a strong marketing strategy, build a brand, attract new customers and maintain loyalty in the placement tools. Because customer loyalty is important, salespeople and executives spend a lot of time and resources to increase brand awareness and create consistent, interrelated campaigns. These marketing efforts typically include print and digital pledges designed to attract old visitors as well as new customers<sup>7</sup>.

Deployment tools play a vital role in the study of marketing activities, deep market segmentation, comprehensive customer service and sales promotion.

Market segmentation involves dividing the entire potential market into smaller, more uniform sectors. Offering hotel accommodation to a large number of customers is gradually becoming a thing of the past. It is necessary to clearly define the type of goods and services to meet the needs of any narrow category of travelers.

Depending on the specific needs of consumers, the hotel industry can be divided into segments: full boarding for business travelers, economy-class service, apartment service, high-class economy-class service, resort service, city in the center and on its edges, service along highways, and so on.

Deployment tools need to create their own service strategy to meet the specific needs of the market that has chosen a particular segment.

The hotel market segmentation is traditionally based on the following variables:

- Demographic (age, gender, income, level of education);
- Behavioral (frequent, infrequent, rare trips);
- Price (high, medium and low cost of a set of services);
- Psychographic (lifestyle, behavior, level requirements convenience).

## CONCLUSION

Thus, understanding the importance of marketing in placement tools can help you stand out and stand out in a competitive job market. Any business can offer the best product in the market, but without good marketing activities it will not bring the required return on investment because it is marketing that informs potential customers about the product or service.

## REFERENCES

1. Address of the President of the Republic of Uzbekistan Shavkat Mirziyoyev to the Oliy Majlis. "Xalq so'zi" newspaper, December 28, 2018.
2. Dzhandzhugazova E.A., (2003) Textbook. manual for students of higher educational institutions. - M.: Publishing Center "Academy", - 224 p.
3. Dzhardemov D.D., (2020). The use of marketing in the hospitality industry. // Marketing, advertising and PR "Young Scientist". No. 18 (308). May 181-184p.
4. Philip Kotler, John Bowen, James Makenz.(2012) Marketing. Hospitality. Tourism: A textbook for students, translated from English - 4th edition. Rev. and add. -M.: UNIT-DANA, 1071p.
5. Olimovich, D. I., Bakhtiyorovich, T. M., & Salimovna, N. G. (2020). Improving of personnel training in hotel bussines. *Academy*, (2 (53)).
6. Арипова, М. С., & Рузиев, С. С. (2020). Организационная структура ресторанов. *Вопросы науки и образования*, (6), 90.
7. Umedovna, T. K., & Oktyamovna, A. S. (2021). PLANNING AND MANAGEMENT OF GASTRONOMY TOURISM IN THE TERRITORY. *ResearchJet Journal of Analysis and Inventions*, 2(04), 237-242.

8. Davronov, I. O. (2019). Innovative ways of improving excursion service around the touristic destinations. *Мировая наука*, (4), 508-510.
9. Samatovich, R. S. (2021). Importance of Marketing in Tourism and Hotel Industry. *International Journal of Business, Technology and Organizational Behavior (IJBTOB)*, 1(2), 79-84.
10. Olimovich, D. I., Temirkulovich, U. J., & Bakhodirovna, M. M. (2020). Mechanisms of improving staff training. *Academy*, (2 (53)).
11. Kayumovich, K. O., Annamuradovna, F. S., Alimovich, F. E., Alisherovna, D. N., & Olimovich, D. I. (2020). Opportunity of digital marketing in tourism sphere. *International Journal of Psychosocial Rehabilitation*, 24(8).
12. Olimovich, D. I., Samatovich, R. S., Farmanovna, E. A., Khabibulayevna, K. S., & Saymurodovich, N. Z. (2020). The economic impact of innovations in tourism and hospitality. *Journal of Critical Reviews*, 7(9), 258-262.
13. Nurov, Z. S., Khamroyeva, F. K., & Kadirova, D. R. (2021, March). Development of domestic tourism as a priority of the economy. In *E-Conference Globe* (pp. 271-275).
14. Alimovich, F. E., Habibulloevna, K. S., & Bahodirovna, D. N. (2020). Central features of halal tourism and halal food. *Academy*, (3 (54)).
15. Olimovich, D. I., & Khudoynazarovich, S. A. (2020). The cost-effectiveness of improving the quality of hotel services. *Academy*, (4 (55)).
16. Samatovich, R. S., Olimovich, D. I., & Jafarbekovna, K. N. (2020). Functional improvement of hotel staff as a key to develop the quality of services in bukhara hotels. *Proceeding of The ICECRS*, 6.
17. Davronov, I. O., & Ismatillayeva, S. S. (2019). The role of innovative technologies for improving economy of hotels.
18. Sharifovich, Y. K. (2021). Ways to Improve Information and Consulting Services in the Field of Tourism. *International Journal of Business, Technology and Organizational Behavior (IJBTOB)*, 1(2), 98-104
19. Olimovich, D. I. (2020). The impact of innovative technologies for improving economy of hotels. *Asian Journal of Multidimensional Research (AJMR)*, 9(5), 194-201
20. Kodirovna, B. S., Atoevna, T. S., & Oktyamovna, A. S. (2020). Main features of advertising in tourism. *Economics*, (4 (47)).
21. OLIMOVICH, D. I., BAXTIYOROVICH, T. M., & CHORIEVICH, B. A. Description of Technological Processes in Restaurant Services. *JournalNX*, 6(05), 248-252.
22. Oktyamovna, A. S., Atoevna, T. S., & Kodirovna, B. S. (2020). The role of animator to the development of tourism animation activities. *Academy*, (12 (63)).
23. Atoevna, T. S., Kodirovna, B. S., & Oktyamovna, A. S. (2020). Features and methods of formation of the cost of tour packages. *Academy*, (12 (63)).

24. Bakhtiyarovich, T. M., Fakhriiddinovna, D. Y., & Temirkuliyevich, U. J. (2020). THE ROLE OF NATIONAL TOURISM RESOURCES IN THE DEVELOPMENT OF DOMESTIC TOURISM. *Economics*, (4 (47)).
25. <https://turgostinica.ru/obschie-predstavleniya-o-marketinge-gostinichnich-uslug/1-obzor-marketingovoy-deyatelnosti.html>
26. <https://uzbektourism.uz/uz/research>



**ACADEMICIA**  
**An International**  
**Multidisciplinary**  
**Research Journal**  
 (Double Blind Refereed & Peer Reviewed Journal)

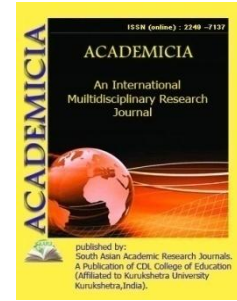

**DOI: 10.5958/2249-7137.2021.01203.9**

## IMPORTANCE OF ENTREPRENEURSHIP DEVELOPMENT IN TOURISM INDUSTRY (BUKHARA REGION)

**Umirov Jasur Temirkulovich\***

\*Lecturer,

Department of Tourism and Hotel management  
 Bukhara state university, Bukhara, UZBEKISTAN  
 Email id: umirovjasur011@gmail.com

### ABSTRACT

*This article describes features and development of entrepreneurship in tourism industry. The business environment is a general environment that is manifested as a result of business. Entrepreneurship is another major source of employment in tourism. At present, great attention is paid to the development of entrepreneurship in our country. There are many aspects to consider when developing a business in tourism. The reform of the system will create many new jobs and develop the tourism industry. Today, tourism is one of the fastest growing sectors in the world economy. In our country, the attention to this area is growing from year to year. Therefore, the formation of a tourist market in our country is very important. The second aspect of the efficient use of tourist resources is the formation of the tourism market.*

**KEYWORDS:** *Tourism, Hotel Industry, Products, Marketing, Entrepreneurship, Services, Destinations, Employees*

### INTRODUCTION

An important issue today is the development of the economy, increasing incomes and improving the socio-economic situation. Today, more than 60% of the population of the Republic lives in rural areas. Therefore, the creation of new jobs in rural areas with a large labor force, the expansion of opportunities in the service sector is a key factor in the well-being of the population. In addition, the development of tourism in rural areas is one of the tasks before us. Karakol is a beautiful place with a beautiful nature, created in the desert for thousands of years. Its beautiful nature, deserts and lush green meadows attract everyone. The fact that astrakhan leather is of great interest to foreign tourists in particular is a great reason for its further development. Karakol sheep are bred all over the world and it is impossible to grow high-quality

skins from them. This requires good climatic conditions, grass and sunlight. Demand for high-quality Uzbek karakul and its products is growing in the world market. The fact that it is widely and effectively used in the creation of high-quality hats, tops, interiors and other works of art for man testifies to the great importance of this industry in attracting international tourists. For centuries, various fur products have attracted the attention of mankind. It is known from history that human beings have been using skin for a long time before they started using fire. By the time primitive humans began to use leather and fur, fire had not yet been invented. Naturally, at that time fur was not yet sewn from karakul, it was simply used as a simple fur. At present, the industry is closely linked with a number of other sectors, especially tourism. Tourists visiting our country are very interested in hats made of astrakhan leather. Our local artisans have treated the leather so well that not every tourist who sees it can leave without buying a hat or cap. The unique patterns and beauty of Karakol leather have always been used as a comfortable, high artistic and aesthetic garment. has become a unique commodity that traders carry around the world in caravans.

## **MATERIALS AND METHODS**

Today, tourism has become one of the most lucrative businesses in the world. It is an integral part of a market economy and has become a rapidly growing industry in many countries around the world. Tourism is closely linked with the world economy's transport, communications, trade, agriculture, and consumer goods industries, and has a place in the world economy. Tourism is one of the main sectors of the economy of the republic, including agriculture, industry, transport and other macroeconomic sectors has enough resources to take its rightful place.

Our country is a leader in Central Asia in terms of tourism development. The country is rich in historical, archeological, architectural, cultural, agricultural and other tourist resources. In addition, the unique and beautiful nature of our country, mountains and valleys, rivers, deserts and various landscapes are the main recreational resources. Tourism, which is a young industry in our country, is developing rapidly today. This means that many jobs can be created. It also allows the countryside to become more beautiful.

Currently, the share of economically active population in the tourism sector in the country is very small. The participation of the rural population in this regard is generally low. Our goal is to create new tourist areas using the recreational and natural resources of rural areas and attract the rural population to tourism in the development of domestic tourism. The experience of developed countries shows that the existence of attractive areas alone is not enough for the development of tourism. Adequate development of local tourism infrastructure is also an important issue. The role of domestic tourism in the region is also important, and it is important to earn income from local tourism, meet the needs of the local population, provide services to them, and develop opportunities to provide jobs for the unemployed.

Currently, in the world experience, the form of agro tourism is widely developed. Agro tourism is one of the brightest types of tourism in our country. Because our country has an agro-industrial economy, the bulk of the population is engaged in agriculture, in addition, our country is rich in recreational resources, and we can develop recreational activities in many areas. Financial resources are essential for countries in transition to a market economy.



---

## RESULTS AND DISCUSSIONS

It has its own characteristics of the development of agritourism. These are:

- Accommodation and meals in rural areas are 2-2.5 times cheaper than in urban areas;
- ecological cleanliness of rural areas;
- Availability of ecologically clean food;
- as an object of ethnographic tourism, the preservation of national identity in rural areas, etc.

As for rural tourism, in the early twentieth century, the aristocrats of St. Petersburg, as well as those who put themselves in their shoes, could not afford to spend their holidays in Baden-Baden. Such people live in Martishkino (southern part of St. Petersburg), which was considered a resort area at that time, or 30 km from the Finnish capital. They rented cheap country houses for recreation in Terioko, a road to the United States. Because there was no need to issue foreign passports. The tenants of such country houses were mostly intellectuals.

Holidays are very exciting for any city dweller, whether in the countryside or in the yard. That's the decent thing to do, and it should end there. Field yards or other places have always been rented for recreation in places that have been trusted and inspected for many years. The peculiarity of rural tourism is that, for example, in the agrarian regions of Sicily, the excess labor force can send poor tourists or students to work without pay, for shelter and food. That such a "vacationer" could find the money to go back. Along the way, you can spend a day or two swimming on the beaches, visiting museums, monuments and more. Today, rural tourism is a lucrative industry and has a special place in the world tourism market. While rural tourism cannot compete with large volumes such as seaside resorts, it does play a role in tourism. Special attention should be paid to its study and development. There is no rural tourism in the country. It has a future due to the small population in the village, the purity of nature, the environmental friendliness. In fact, it is cheaper to be a tourist in the countryside than in the resort areas or popular tourist centers. Not everyone can relax in expensive tourist centers, so the development of rural tourism is of great importance.

Rural tourism is carried out in the following cases:

- In rural areas, regardless of the amount of money available to certain categories of people, for example, according to family traditions;
- on the advice of a doctor to conduct rehabilitation in rural climates;
- Proximity to nature, the purpose of spending more time in the fresh air;
- for the possibility of eating environmentally friendly and inexpensive products;
- There are real opportunities for employment in agriculture;
- not to travel thousands of kilometers to find what you need for life;

Rural tourism is a unique feature of other areas of tourism, providing tourists with a unique opportunity to get acquainted with the local traditions of the local community, as well as improve living conditions and sources of income for rural families in remote areas of the country, as well as preserve national and cultural heritage. is distinguished by According to the analysis of international experience in the field of tourism, the focus on the development of rural tourism is

given by locals in rural areas to rent hotels for tourists to spend the night, organize dining and entertainment programs, provide guidance services, handicrafts. increases opportunities for additional income through the manufacture and sale of goods.

## CONCLUSION

The dedication of local tour operators to attract tourists to their villages, to bring tourists to the development of their people and state, to create jobs, to strengthen the tourist resources of their country, to bring currency into the country and to pay taxes on this income. they deserve to be taxed. In general, tourists in rural areas are much cheaper than in sanatoriums or popular tourist centers. Not everyone can relax in expensive tourist centers, so the development of rural tourism is of great importance.

## REFERENCES

1. McGehee, N. G., & Kim, K. (2004). Motivation for agri-tourism entrepreneurship. *Journaloftravelresearch*, 43(2), 161-170.
2. Olimovich, D. I. (2015). Tourism potential of Uzbekistan. *LucrărileSeminaruluiGeografic" DimitrieCantemir"*, 40, 125-130.
3. Sharifovich, Y. K. (2021). Ways to Improve Information and Consulting Services in the Field of Tourism. *InternationalJournalofBusiness, TechnologyandOrganizationalBehavior (IJBTOB)*, 1(2), 98-104
4. Olimovich, D. I., Bakhtiyorovich, T. M., &Salimovna, N. G. (2020). Improving of personnel training in hotel bussines. *Academy*, (2 (53)).
5. Zhao, W., Ritchie, J. B., &Echtner, C. M. (2011). Social capital and tourism entrepreneurship. *AnnalsofTourismResearch*, 38(4), 1570-1593.
6. Olimovich, D. I., Khabibovna, K. M., & Alimovich, F. E. (2020). Innovative ways of reducing tourism seasonality of tourist areas. *Достижениянаукииобразования*, (1 (55)).
7. Арипова, М. С., &Рузиев, С. С. (2020). Организационная структура ресторанов. *Вопросы науки и образования*, (6), 90.
8. Olimovich, D. I., Kudratovna, F. S., &Sayfitdinovich, I. B. (2020). The importance of marketing analysis for predicting the prospects of restaurants in Bukhara hotels. *Economics*, (1 (44)).
9. Szivas, E. (2001). Entrance into tourism entrepreneurship: a UK case study. *Tourismandhospitalityresearch*, 3(2), 163-172.
10. Olimovich, D. I., Khabibovna, K. M., &Samadovich, R. S. (2020). Improving tourist season in Bukhara region. *Вестникнаукииобразования*, (1-2 (79)).
11. Umedovna, T. K., &Oktyamovna, A. S. (2021). PLANNING AND MANAGEMENT OF GASTRONOMY TOURISM IN THE TERRITORY. *ResearchJetJournalofAnalysisandInventions*, 2(04), 237-242.
12. Davronov, I. O. (2019). Innovative ways of improving excursion service around the touristic destinations. *Мироваянаука*, (4), 508-510.
13. Ateljevic, J., & Li, L. (2009). Tourism entrepreneurship—concepts and issues. *Tourismandentrepreneurship*, 10e32.
14. Olimovich, D. I., Temirkulovich, U. J., &Bakhodirovna, M. M. (2020). Mechanisms of improving staff training. *Academy*, (2 (53)).

15. Kayumovich, K. O., Annamuradovna, F. S., Alimovich, F. E., Alisherovna, D. N., & Olimovich, D. I. (2020). Opportunity of digital marketing in tourism sphere. *International Journal of Psychosocial Rehabilitation*, 24(8).
16. Olimovich, D. I., Samatovich, R. S., Farmanovna, E. A., Khabibulayevna, K. S., & Saymurodovich, N. Z. (2020). The economic impact of innovations in tourism and hospitality. *Journal of Critical Reviews*, 7(9), 258-262.
17. Nurov, Z. S., Khamroyeva, F. K., & Kadirova, D. R. (2021, March). Development of domestic tourism as a priority of the economy. In *E-Conference Globe* (pp. 271-275).
18. Alimovich, F. E., Habibulloevna, K. S., & Bahodirovna, D. N. (2020). Central features of halal tourism and halal food. *Academy*, (3 (54)).
19. Olimovich, D. I., & Khudoynazarovich, S. A. (2020). The cost-effectiveness of improving the quality of hotel services. *Academy*, (4 (55)).
20. Samatovich, R. S., Olimovich, D. I., & Jafarbekovna, K. N. (2020). Functional improvement of hotel staff as a key to develop the quality of services in bukhara hotels. *Proceeding of The ICECRS*, 6.
21. Davronov, I. O., & Ismatillayeva, S. S. (2019). The role of innovative technologies for improving economy of hotels.
22. Fatillovayevna, R. G., & Bahriddinovna, U. D. (2021). THE ECONOMIC IMPORTANCE OF NATIONAL CRAFTS IN THE DEVELOPMENT OF TOURISM. *Academy*, (1 (64)), 52-54.
23. Olimovich, D. I. (2020). The impact of innovative technologies for improving economy of hotels. *Asian Journal of Multidimensional Research (AJMR)*, 9(5), 194-201.
24. Ateljevic, I., & Doorne, S. (2000). 'Staying within the fence': Lifestyle entrepreneurship in tourism. *Journal of Sustainable Tourism*, 8(5), 378-392.
25. Olimovich, D. I. (2020). Role of investment in tourism development. *Academy*, (5 (56)).
26. Samatovich, R. S. (2021). Importance of Marketing in Tourism and Hotel Industry. *International Journal of Business, Technology and Organizational Behavior (IJBTOB)*, 1(2), 79-84.
27. OLIMOVICH, D. I., BAXTIYOROVICH, T. M., & CHORIEVICH, B. A. Description of Technological Processes in Restaurant Services. *Journal NX*, 6(05), 248-252.
28. Lordkipanidze, M., Brezet, H., & Backman, M. (2005). The entrepreneurship factor in sustainable tourism development. *Journal of Cleaner Production*, 13(8), 787-798.
29. Bakhtiyarovich, T. M., Fakhriddinovna, D. Y., & Temirkuliyevich, U. J. (2020). THE ROLE OF NATIONAL TOURISM RESOURCES IN THE DEVELOPMENT OF DOMESTIC TOURISM. *Economics*, (4 (47)).



DOI: **10.5958/2249-7137.2021.01204.0**

## DEVELOPMENT OF COGNITIVE ACTIVITY IN FUTURE TEACHERS

**Yuldasheva Malohat Erkinovna\***

\*Teacher,  
Department of interdepartmental pedagogy and psychology,  
Kokand State Pedagogical Institute,  
UZBEKISTAN

### ABSTRACT

*This article provides a pedagogical basis for the professional training of future teachers and their learning activities, and describes the methods and techniques for the development of learning activities. The main criteria for professional training are the practical training of the future specialist and the acquisition of knowledge, skills and abilities in the field of specialization, the level of adaptation to the requirements of professional activity. The works of medieval thinkers who lived and worked in the Near and Middle East emphasize the importance of the type, principle, structure, and criteria of scientific knowledge in relation to human mental development and perfection.*

**KEYWORDS:** *Pedagogical, Specialization, Perfection*

### INTRODUCTION

Social, didactic, active, professional, axiological, acmeological, creative, reflexive, cognitive activity, traditional education, skills, abilities, etc. From the first years of independence of Uzbekistan, the first President Islam Karimov objectively analyzed the achievements and shortcomings in the education system and proved the need for radical reforms in training. Also, I.A. In his speech, Karimov stressed the social necessity of this issue, saying, "It is necessary to implement a series of comprehensive measures to ensure the entry of talented young people into science. In this regard, it is necessary to radically reform the activities of universities, and even general education schools," he said. Indeed, the solution of these issues is aimed at radically reforming the existing education system in the country, the formation of a highly spiritual person through the formation of a system of continuing education. Therefore, the role of higher education institutions in educating a harmoniously developed person, forming him as a specialist, gaining a worthy professional and social status in society is great. Quality-monitoring of the

system of modernization of higher education institutions and their educational process, training of pedagogical specialists increase, modern professional knowledge, skills and abilities of future teachers arming them with acmeological motivation for professional activity formation of professional training of pedagogical specialists is one of the important tasks in the process.

he experience of developed countries, in particular, the United Kingdom, Australia, Switzerland, Germany, Malaysia, Canada in the training of specialists shows that the main task of vocational education is to develop students' intellect and logical thinking based on the specifics of the chosen specialty. On the basis of this task, the professional training of students will be provided. The main criteria for professional training are the practical training of the future specialist and the acquisition of knowledge, skills and abilities in the field of specialization, the level of adaptation to the requirements of professional activity. These factors, which determine the effectiveness of the process, are reflected in the system of training of junior specialists in the context of the "National Training Program". creates the need for fundamental research to improve the content of vocational training by ensuring its practical implementation. It is known that for thousands of years in Eastern pedagogy, the issues of career choice, career guidance, vocational education have been combined with mysticism. The Qur'an, which has been an important source in the formation of the spirituality of our people In the hadiths, as well as the great thinkers Muhammad Ismail al-Bukhari, Muhammad Isa al-Termizi, Mahmud Qashqari, Abu Nasr al-Farabi, Yusuf Khos Hajib, Hussein VoizKashifi, Amir Temur, AlisherNavoi expressed in the form of rare ideas in the scientific heritage. Thus, finding solutions to didactic problems in pedagogical technology is an important step in the implementation of the national program. If the educator has in his hands the students who are thirsty for knowledge, the program, textbooks and manuals in accordance with the purpose of science, he can successfully carry out the didactic process. can effectively and consistently introduce new pedagogical technologies into practice, effectively using organizational forms of cognitive activity. Thus, as a result of these ideas, theoretical analysis and generalization of the results of observations and empirical analysis obtained in the process of scientific and pedagogical research, it was found that the effectiveness of the process of professional adaptation of future teachers is based on the following factors:

- Motivational factor - aspects characterized by the level of awareness of future teachers about the chosen profession and its essence, professional orientation and motives for choosing a profession;
- Social factor - the existing social environment in society and the social prestige of the profession, as well as the development of professional and social norms by students, the application of social experience in the system of personal and professional institutions;
- informational-meaningful - a set of socio-theoretical, pedagogical-psychological and special-methodological knowledge, skills and abilities necessary for the successful acquisition of a factor-selected field of professional activity;
- Activity factor - the motivation to apply the acquired special professional knowledge, skills and abilities in specific situations and situations, self-analysis and development;
- Organizational and methodological factor - innovative types of education: person-centered, differentiated education, interactive education, collaborative education, software education, problem-based learning, game technology, modular lim, independent study and effective use of

others in the educational process; teacher and student interaction; students' ability to learn independently, students' creative approaches to learning, the formation of independent thinking skills; the establishment of an informed creative environment; healthy competition; objective assessment of students' learning activities;

- Didactic factor (tools) - the availability of specially equipped (computerized) classrooms; educational resources (improved curricula, lecture notes, electronic textbooks, teaching and methodical manuals, electronic developments, graphic organizers, audit tools), teaching equipment and tools, information technology. Based on these factors and the current requirements of the labor market for the training of teachers, it is clear that the content of the formation of professional flexibility in future teachers is directly determined by their physiological, psychological, social and organizational adaptation. Socio-theoretical training of students of pedagogical higher education institutions is influenced by motivational and social factors, the content of which includes information, knowledge, the basics of science, which are acquired in the field of general education.

Pedagogical and psychological training of students is based on the principles of the educational process, the documents that illuminate the content and essence of education, forms, methods and means of teaching, as well as knowledge of the age and individual characteristics of the student and their psychological state. Is determined by the level of professional knowledge, skills and abilities in the acquisition. The skills of practical adaptation of future teachers to the professional activity will be formed on the basis of direct special-methodical training. In this case, the correct design and implementation of the educational process of the student, the organization and management of the activities of teachers and students, the correct orientation of students' learning activities, teaching, the level of mastery of skills in the effective use of forms, methods and tools of control and evaluation in the field of science, training and subject are described as key components. To be included in the process of professional adaptation of future teachers one of the modern requirements is the ability to actively master and implement these innovations. Innovative training is one of the criteria of professional training determined by the formation of an axiological, acmeological, creative, reflexive approach to pedagogical activity, the creation of an environment of creative cooperation in education, the introduction of innovative technologies in the teaching process, active motivation for innovative activities. is considered. Another important consideration is the process of professional development of future teachers aspect is the professional knowledge, skills and in the areas mentioned above is the definition of a set of necessary conditions for the acquisition of skills and their full implementation in practice. Because a comfortable and goal-oriented pedagogical environment allows the process to achieve the desired result relieves the earliest sources on student learning and its nature date back to antiquity. It has been known since ancient times that students' cognitive activity helps them to delve deeper into the essence of things, processes and events, and strengthens memory. The works of medieval thinkers who lived and worked in the Near and Middle East emphasize the importance of the type, principle, structure, and criteria of scientific knowledge in relation to human mental development and perfection. Al-Khwarizmi clearly distinguished between cognition through emotion and cognition through "logical reasoning": emotion is a "small" property, and "logic" is the study of essence, and they are interrelated. In order for the learning process to be productive and efficient, students must have a certain level of cognitive activity. Education should be both a goal and a tool for students to develop their learning. Therefore, the

school is tasked with educating an active, creatively inquisitive person. Therefore, the development of cognitive activity is necessary not only for the successful completion of educational tasks, but also for the fulfillment of educational tasks, which should develop students' mental abilities, respect and enthusiasm for work. The problem of developing cognitive activity is related to the development and application of specific methods and techniques. According to P.D. Zubenko, who observed the work of future teachers in a special experiment, the development of students' mental activity depends in many ways on teaching aids. However, the organization of cognitive activities alone does not provide a complete solution to the problem. In recent years, it has been proven wrong to divide teaching into active and passive methods.

In traditional education, the teacher explains the material, poses a problem, finds a solution, and the student repeats the teacher's actions. In this method of teaching, the teacher is active, and students are limited to performing the role of a weak performer. A number of studies have been conducted to improve traditional approaches. A.J. Attokurova, S.Yu. Kutlimuradova, M.I. Enekeev, S. Kariev in their research agreed that the cognitive activity of students can be developed through independent work. The urgency of the problem of developing students' cognitive activity is due, firstly, to the lack of consensus among pedagogical scholars on the definition of this topic, and secondly, to the fact that methods of development are also interpreted differently in the scientific and methodological literature. The analysis of the above scientific research shows that there are three main directions of the problem: The first direction is to accelerate learning to a certain extent by performing exercises and practices that determine the knowledge of more students. The second direction in the concept of developing students' cognitive activity is related to the formation and development of cognitive activity, which focuses on such qualities as activity, independence, initiative, creative activity and independent learning. The third direction is to create the necessary conditions for the development of cognitive activity. In our opinion, these directions in the concept of the development of cognitive activity do not negate each other, but are inextricably linked. However, because all three areas of the problem are so broad and multifaceted, researching them should be a priority, identifying the main areas in which students will develop their learning. Modern didactics uses the achievements of educational psychology in the study of students' cognitive activity. Depending on the age and content of the educational material, the specificity of this activity establishes the psychological laws of the educational process, considers the individual and typical characteristics of students in cognitive activities.

#### **LIST OF USED LITERATURE**

1. Karimov I.A. High spirituality is an invincible force. - T .: Spirituality, 2008.
2. Azizxodjaeva N.N. Pedagogical technologies and pedagogical skills. - T .: Finance, 2003. B–84
3. Tolipov O'.Q. Pedagogical technologies for the development of general labor and professional skills in the system of higher pedagogical education / Monograph. - T .: Fan, 2004. B –73-80.
4. Rahimov B.X. Formation of professional and cultural relations in future teachers .: Ped. fan. nom. ... Diss. - T .: 2002. B - 61-67.

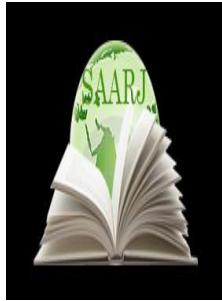

**ACADEMICIA**  
**An International**  
**Multidisciplinary**  
**Research Journal**  
 (Double Blind Refereed & Peer Reviewed Journal)



**DOI: 10.5958/2249-7137.2021.01117.4**

**ISAJAN SULTAN'S CHARACTER CREATION SKILLS**

**Gayrat Kenjabaevich Urazbaev\***

\*Assistant,  
 Department of "Uzbek Language and Literature",  
 Karakalpak State University,  
 UZBEKISTAN

**ABSTRACT**

*Talented writer Isajon Sultan has complementary characters in every story, short story and novel. These heroes in a sense demand a national character. The article focuses on character creation skills in this process. The nature and spiritual world of the characters in the writer's stories were looked at.*

**KEYWORDS:** *Character, Portrait, Plot, Composition, Image, Style, Skill, Poetics.*

**INTRODUCTION**

A comprehensive and in-depth study of aspects of the national mentality in the creation of a work of art by a writer requires a laborious and complex process. Each artist illuminates the elements of the national language at a unique level. The great Greek genius Aristotle: "As for the characters, they have four goals. First, and most importantly: the hero must be noble. As we have said before, a person acquires character if he pursues a purpose in his words and deeds. If a person has good goals, his character will also be good. It can be present in anyone: a woman or even a slave may be good, the former (worse than a man) may be worse, and the slave may be worse than him. Second, the characters must be unique: the character is masculine, but masculinity and strength do not befit a woman: this is not to say that they are absolutely different, as described above, and that they should be described as good or handsome. Fourth, the characters must be consistent: even if the person portrayed is inconsistent, all the actions of that character may be inconsistent" [1, p. 44].

**THE MAIN FINDINGS AND RESULTS**

Apparently, the works of Isajon Sultan contain dozens of complementary characters that grow from story to story, from story to novel. This is the image of a woman. When describing the character of the women of our working people, the writer always takes into account two aspects.



The first is to describe the shifts in the social life of an ordinary peasant woman, while the second is to depict the fate of wise housewives who have not seen the light in hard working conditions. These are the Mother of the Stranger in “Munojot”, Rano in “Onaizorim”, Dilorom in “Ozod”, Bibi Salima in “Bibi Salima”, Zulayho in “Yusuf and Zulayho”, and the mother in “Qismat”. All four elements of character creation that Aristotle emphasizes require the strengths and weaknesses of the female race, her aspirations, her civic duty, her role in the family, in social life.

In the author's stories and narratives, we examine in part the artistic evolution of the characters. In particular, we see the tragic images in the story “Onaizorim” as a writer depicting the brutal realistic scenes of life, moving away from the lyro-romantic style typical of the early works of Isajon Sultan. It should be noted that the realistic style was chosen exactly in accordance with the concept of the story. The author's portrayal of tragedies not only through the depiction of two-sided plates, but also through the artistic depiction of the fate of the protagonists and the tragic complications that remain a painful point in his heart, ensured that the work was convincing and educated. The literary language in the story requires extremely simple and logical thinking. The writer used every word effectively, in which the laws of language took on a high meaning. The use of idioms typical of rural life served to increase the appeal of the story.

*“Ota xastalanibytibqoldi.*

*Kuzkelganedi. The leaves of the quince are golden, reddish-gold, the leaves of the grass are pale greenish-yellow, and the leaves are pale green. The weather began. In the morning, the meadows were covered with dew, and the gray soil of the fields was darker than mine.*

*– Nimabo'ldisizga? – dediona.*

*– Bilmadim, – dedi otaihrab. – Shu, biqinimsanchiydi. Anchadanberisanchib-sanchibqo'yardi, o'tibketar deb yuraveribman, endikuchayibketdi.*

*- Voyo'lmasam, nimaqilamiz?*

*– Maqsuddo'xtirnichaqiraqol, – dediota.*

*Ona qo'shninikigachiqibketdi. U erdan “Maqsuddo'xtirnikigaboribkeling, bolam, akangiznimazasiqochibqoldi”, deganieshitildi.*

*Ra'nootasiningyonida ne qilarinibilmayo'tirardi. Birnima deb ko'ngliniko'targisikelardi, o'ylabturib-turib, axiyri:*

*– Choy damlabkelaymi, ota? – debso'radi.*

*Otaningatrofitirishlargato'lako'zidailiqifodapaydobo'ldi.*

*"Jonimqizim", dedi ovozi allanechuko'zgarib. Yana birnimalardemoqchibo'libjimqoldi, o'ylariko'zlaridan bilinardi. Harholda, suyib-alqabanchagaplaraytgisikelganbo'lishimumkin. Keyinqiynalibroqbiriyutindi-da:*

*– Mayli, qizim, – dedi.*

*Ra'nootaningaytaolmagangaplarinitushungandayedi.*

*O'shamahaldanimalardegisikelganekanulkangavdalibarvastabukishining?*

*Qalbsezib-*

*tug'yonko'tarar, o'ziniotabag'rigaotgisi, to'yib-to'yibyuzlariniishqagisi, yanaallaqanchanoma'lumistaklarborvahammasiqzningotagaulkanmehridanbinobo'lmoqdaedi.*

*Lekin, ota ham birnimademadi, qiz ham. Ra'noayvongabordi-da, choy damlashgatutindi* [2, p. 69].

*“My father fell ill.*

*Autumn had come. The leaves of the quince were golden, the poplars were golden red, the long leaves of the grass were pale yellow and green, and the stream was green. Criteria began to fly in the air. In the morning the meadows were soaked with dew, and the gray soil of the fields was darkened by moisture.*

*“What happened to you?” He said to her.*

*“I don't know,” said Father Ihrab. “That's my shoulder.” It had been stinging for a long time, I was walking past it, and now it was getting stronger.*

*“What are we going to do if I don't die?”*

*“Call the doctor, Maqsud,” said the father.*

*The mother went out to her neighbor. From there, he was told, “Go to Maqsud's doctor. My son, your brother has lost his appetite.”*

*Ranowas sitting next to her father, not knowing what to do. He wanted to cheer her up, but then he thought:*

*“Shall I have some tea, Dad?” He asked.*

*A warm expression appeared in his father's eyes, full of tears.*

*“My dear daughter,” his voice changed. He was silent, trying to say something else; his thoughts were clear in his eyes. In any case, the lover may have wanted to say more. Then he swallowed harder:*

*“All right, girl,” he said.*

*Ranoseemed to understand what her father could not say. What did he mean at that moment by the huge body of this man? His heart was pounding, he was throwing himself into his father's arms, his face was full of greed, there were some more unknown desires, and it was all built on the girl's great love for her father.*

*But neither the father nor the daughter said anything. Ranowent to the porch and started making tea.”*

There is Uzbek sorrow, pain and grief in the relationship between a father and a daughter who have reached the end of their lives. The landscape in the picture is in harmony with the rush of autumn, reflected in the writer's sharp eyes, like the shedding of leaves. Behi - symbol! The author's goal is to point out the image of the Father in the story of the dying quince tree, the calm and greenery of the waters, the gray, darkening of the soil from moisture. On the one hand, the fate of the father, who is growing from illness and pain, creates a deep chasm in the heart of the spotless and sincere Rano .**“Jonimqizim”, dediovoziallanechuko'zgarib. Yana birnimalardemoqchibo'libjimqoldi, o'ylariko'zlaridanbilinaredi**” – “My dear daughter,” he

said, his voice changing a little. He was silent, trying to say something else; his thoughts were visible in his eyes.” The father's last wish, but also his farewell, evokes a feeling of sadness in the student's heart. It is not difficult to understand the concept embedded in the architecture of the story in a short dialogical dialogue by Isajon Sultan. Because, *“Muallifchekinishi – buijodkorningfalsafy, lirik, avtobiografikvaboshqayo'nalishdagimulohazalariifodasibo'lib, ularbirorpersonajyokitimsollaro'rtasidagimunobabatniizohlashgaqaratilmaydi.*

*Muallifchekinishiasarkompozisiyasidabo'lishishartemas, lekinasardabundaychekinisho'rinqo'llanilganbo'lsa, u kattaahamiyatkasbetadivaalbatta, alohidatahlilgatortilganimaq'ul”* [3, p. 235] - The author's retreat is an expression of the artist's philosophical, lyrical, autobiographical, and other thoughts, which are not intended to explain the relationship between any character or emblem. The author's retreat does not have to be in the composition of the work, but if such a retreat is used appropriately in the work, it is of great importance and, of course, it is desirable to draw a separate analysis”.

The author pays special attention to the author's retreat in many of his works. This is called his style of expressing reality. Style is a special concept! It has a special place in the nature of every literary genre. However, it is commendable that the simple style of the writer's style depicts the realities of rural life from today's level. The dynamic growth and change of the characters unfolds from work to work. Rano's diligence, his habit of doing any work diligently, his ability to swallow his sufferings and tears, have become an integral part of the writer's creative concept. It should be noted that the adaptation to destiny, the desire for desires and inclinations remain nourished by national mental characteristics:

*“Saharlabqushuyqusidaxiyolko'ziilinganRa'nonixolasidahlizdanovozberibuyg'otdi.*

*“Tur, qizbo'lmayqol, hovlilarnisupur, ishlaringniqil”, dedipichirlab.*

*Ra'noo'rnidanturdi. Ohorlikelinlikliboslarinikiydi, u liboslaro'zigayarashdimi-yo'qmi, oynagatuzukroqqarayolmadixam, ammo rang-barangligi, islarivayangiligiyoqaredi.*

*Tashqarichiqarkan, u ham pichirlab, xoladan:*

*– Supurgiqaydaekan? – deyasoradi.*

*– Hammasinitopibqo'yganman, – dedixola. – Men ham chiqaman, bo'laqol.*

*Hovlikengginaedi. To'yo'tgach, qolganqavmuqarindoshhammayoqnisaranjomlabketishganekan. Birchetdadasta-dastapiyolayulaganlarturar, rayhonlarostidaRa'noyangisupurginiko'rdi. Xolasidanminnatdorbo'lib, hovlisupurishgatutindi. Ko'chaeshikoldiniikkitarafdagiqo'shnilarningdarvozaxonasigachasupuribbordi, suvlarsepdi, keyinqaytibkirib, nonushtatayyorladi, buoradaqaynota-qaynona ham turishdi. Birchetgaqumg'ondasuv ham isitibqo'yganedi, qaynotakelinigaqaramasdan, boribtahoratiniolibkeldi. U kelgunigaqadarRa'noshoshilibularyotganuygakirib, joynamoziniqiblagato'g'rilabsoldi”* [2, p. 77].

*“In the morning, Rano's aunt, who was dreaming in a bird's sleep, woke her up by shouting from the hallway.*

*“Get up, don't be a girl, sweep the yard, do your work,” he whispered.*

*Ranostood up. He wore a heavy bridal gown, and he couldn't look in the mirror to see if it suited him, but he liked the variety, the smell, and the novelty.*

*When he came out, he whispered to his aunt:*

*“Where's the broom?” He asked.*

*“I've found them all,” said the aunt. “I'll go out, too.”*

*The yard was spacious. After the wedding, the rest of the people and relatives took care of the cabbage. On one side stood piles of bowls and bowls, and under the basil Ranosaw a new broom. Thanks to her aunt, she started sweeping the yard. The street swept the front door to the neighbors' gates on both sides, sprinkled water, then went back in and made breakfast, while the in-laws also stood. Aside from the sand, the water was also heated, and the father-in-law went and brought his ablution, in spite of his daughter-in-law. Before he arrived, Rano hurried into the house where they were sleeping and turned his prayer towards the qibla”.*

Our national way of life is interpreted on the basis of simple communication. There are no dreams in the heart of the newlyweds, which is torn between life and imagination. Family Relationships and Upbringing Rano is a symbol of goodness in nature. It is the chain between reality and the writer's creative intent that ensures that Rano's character emerges in all its complexity. At a glance, the writer gives the impression that he is describing the fate of an ordinary person. But at its core lies the destiny of the nation, the attitudes of society, the dreams of the family, and the goals of parents. “... when studying the text of a work of art, taking into account the interdependence of all the elements in it allows us to come to the right scientific conclusions. In this context, the study of the relationship between plot and psychologism in the novel also makes it possible to clarify the individual style and skill of a particular writer. While the plot depicts the chain of events, changes in space and time of the characters, their lives in alternating situations and situations with the help of artistic psychologism, the psychological world, emotions and experiences of the literary hero are reflected in the plot reality. While the events described by the writer constitute the subject world of the work, the depiction of the psyche of the characters is the beginning of the novel, which constitutes the artistic psychology” [4, p. 123]. Character is the psyche of the writer's primary ideological and artistic credo.

Norwegian thinker Johan Borgen writes about the complex processes of creative psychology: “Man's memories of the past are never preserved as a whole, but are blinking in the form of a subtle gesture, an abstract feeling, or an object, and are absorbed into a stream of uncontrolled imagination” [5, p. 156]. According to him, artistic creation is the ability to absorb the rays of abstract emotions, to express them in words. Creativity is a multi-stage phenomenon. Undoubtedly, this process, which Borgen envisioned, also belongs not to the sample of world literature encountered, but to the highest stage of artistic creation. In Isajon Sultan's story “Onaizorim” the literary language is more pronounced when it uses the dialect and the simple way of speaking instead. That is, as the protagonist individualizes his speech, the essence is embodied in a unique way. Not the unusual features of the language, but the light and simple words of the epic infuse universal problems:

*“Sovchilaryanakelishdi. Endiulargaberiladiganjavobaniqedi.*

*– Sahar kelibko'changiznisupuribketaydesam, zamonboshqa, ammo shuqizingizuchunilbo'yiharkunisupurishgayamroziman, – deyaavradikuyovningammasi, semizxotin.*

*O'zamma-xolalari ham shundaedilar.*

*– Sizdayxushmuomala, harnarsanio'ylabishtutadiganoilagabermasak, kimgayamberardik, – dediona. – Qoshimniostida, kiprigimniustidaavaylabo'stirganqizimgao'zimdan ham afzalono'lasiz-ku, sizniyam, avlod-ajdodingizni ham yaxshibilaman.*

*Bu birishora, zamiridao'ksikroqhayiqishsezilar, ya'ni, berishgaberarmizu ammo shunchayilzahmatlarbilankattaqilganqizimgao'zbolangizdayqararmikansizdeganilg'ar-ilg'anmasbiro'tinch ham boredi. Non sindirildi, oqlikberildi. Kelganlarningerkaklarigabelbog', ayollarigaro'mol, dasturxonlariga non vaqand-qurssolindi. Sovchilarxushhol, yuz-ko'zlarisevinchumannuniyatdanporlab, xayr-xo'shlashibjo'nashdi. “Xudoxohlasa, endiqarindoshbo'ldik”, deyishdiketaroldidan. “Oqlik ham berildi, endibuyog'ito'y, qizo'lgur”, dedioxolasi, Ra'nonibiqininichimdib, sevib-suyib.*

*“Hoy qiz, endiko'chagachiqqaningdaqarindosh-urug'laridanbirontasio'tibqolsaqochgin, – dediona. – Yo'lingo'shatomongatushsa, u ko'chadanyurmagin.*

*Gapirishsagapirmaysan, ko'rishamandesayuqochganiilojinqolmasa, ergaqarabturasan.*

*Elningko'zisendabo'ladi, bularningbariseninghayo-odobingniko'rsatadigannarsalar, hushyorbo'lasan”.*

*Qo'ni-qo'shnilar – keng-mo'lguldorko'ylakkiyganshaddod-shaddodxotinlarko'rpa-to'shakqaviganichiqishdi.*

*Qoqergakattakonpalossolindi. Qo'shnilar u yoq-buyoqdangaplashib, to'shakqaviredilar” [2, p. 78].*

*“The bridesmaids are here again,” he said. Now the answer to them was clear.*

*“If I want to sweep the streets in the morning, the time is different, but I agree to sweep for your daughter every day of the year,” said the groom's aunt, the fat woman.*

*So were their aunts.*

*“If we didn't give it to a family as polite and thoughtful as you, we would give it to someone,” said the mother. “You will be a better mother to my daughter, whom I have carefully raised under my eyebrows and above my eyelashes, and I know you and your descendants well.”*

*It was a sign that there was a deeper urge to give, but there was also an unmistakable urge to look at my daughter, whom we had raised with so many years of hard work, as your own child. The bread was broken, whitened. The men were given belts, the women with handkerchiefs, and bread and sugar. The bridesmaids said good-bye, their faces shining with joy and good-bye. “God willing, we are now relatives,” they said before leaving. “Whiteness has been given, now it's a fat wedding, girl,” said her aunt, pinching Rano's shoulder and kissing her.*

*“Daughter, when you go out, runs away if any of your relatives pass by,” said the mother. “If you go that way, don't walk down that street.”*

*If they talk, you don't talk, I'll see you, and if you can't escape, you look at the ground.*

*You will have the eyes of the people, all these things that show your modesty, you will be vigilant. ”*

*Neighbors - squeamish women in loose-fitting floral dresses - came out to make the beds.*

*A large carpet was placed on the bare ground. Neighbors were talking here and there, and the bed was crumbling”.*

It is not a change in the fate of the hero, but the revelation of it through the characters is the most basic feature of Isajon Sultan's style. After all, the writer does not polish the existing rules in the discussion, but seeks to keep them natural. This leads to how skillfully he has to use his language. In this film, the writer describes the rituals of Rano's wedding. The protagonist was able to skillfully weld the psyche of the image based on the demonstration of intellect. In the background, the story unfolds in a more vivid way. Consequently, destiny was giving happiness to a girl named Rano. Living happily with this happiness makes the girl's dreams even more abundant. But he had no idea what life would be like after marriage. This is also a testament to the writer's aggressive style.

### CONCLUSION

The conclusion is that he sought to reinterpret the discipline of art not only in the story but also in the novels. In particular, the novel “Ozod” reveals the inner secrets of the human will in the story “Onaizorim” - the national language and spiritual closeness. The images of Rano and Dilorom, Bibi Salima, and Ona (mother) are complementary characters.

There is a certain connection between the character in the story and the character in the story. There are different ways and means of creating a character. Each writer is defined as an individual, possessing a new image style. However, this laborious process does not always bring good luck to the writer. Characters similar to each other undermine the poetic integrity of the work. Therefore, it is important to carefully study the many theories of character creation from a global perspective. It is better not to deviate from tradition in the illumination of national identity, in the depiction of the psyche of sincere people. A national character is created on the border of tradition and non-tradition. After all, the writer was formed in the midst of this complex creative process. Eternal themes such as the color of the valley, kindness and forgiveness in human nature, cruelty and love are an integral part of renewed artistic thinking.

### REFERENCES

- 1) Aristotle. AkhlokiKabir. – Tashkent. “YangiAsrAvlodi”. 2018. – p. 43
- 2) Isajon Sulton. (2015). *Onaizorim*. Narratives and short stories – Tashkent. “Sharq”. – pp. 69, 71, 78
- 3) Yuldashev Q. (2016). *Fundamentals of artistic analysis*. – Tashkent: “Kamalak”. – p. 235.
- 4) Botirova Sh. (2019). *Artistic psychologism in Ulugbek Hamdam's novels*. Philological Diss. – Karshi: – p. 123.
- 5) YukhanBorgen. (2001). *What does it mean to be a writer?* World Literature. Issue 2. – p. 156.
- 6) Khudoyorovich, K. K., Rasuljanovna, I. N., Khalmuratovna, R. Z., & Eshkobilovna, K. D. (2020). The Issues of Word Choice in Fiction Translation. *International Journal of Psychosocial Rehabilitation*, 24(04).



**ACADEMICIA**  
**An International**  
**Multidisciplinary**  
**Research Journal**  
 (Double Blind Refereed & Peer Reviewed Journal)

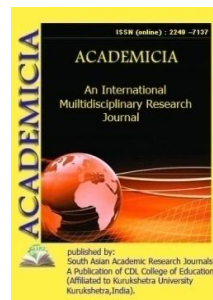

**DOI: 10.5958/2249-7137.2021.01118.6**

## AGROTECHNICS OF GROWING RE-PLANTED BEAN VARIETIES

**Guliston Abdalova\*; Jasurbek Tajiyev\*\*; Sherali Odinayev\*\*\***

\*Candidate of Agricultural Sciences,  
 Tashkent State Agrarian University, Tashkent, UZBEKISTAN  
 Email id: 1963gulistan@mail.ru

\*\*1-year student at Master's Degree  
 Tashkent State Agrarian University, Tashkent, UZBEKISTAN

\*\*\*1-year student at Master's Degree  
 Tashkent State Agrarian University, Tashkent, UZBEKISTAN

### ABSTRACT

*This article provides information about agro technology of fertile cultivation of Rovot, Productive varieties of beans, which are grown as a secondary crop in the typical gray soils of Tashkent region. In the experiment, local white beans, Rovot, Makhsuldor varieties are grown. Irrigation is carried out in the order of soil moisture 70-70-60%, 65-65-60% relative to limited field moisture capacity. In the foothills and irrigated areas, groundwater is saturated mainly by surface water. The water resources of rivers and groundwater are interconnected. Excessive use of groundwater will reduce river flow.*

**KEYWORDS:** *Typical Gray Soil, Fertigation, Black Polyethylene Film, Rovot, Productive Bean Varieties*

### INTRODUCTION

**Relevance and necessity of the topic** The world's oceans, groundwater, glaciers, soil moisture, river water, atmospheric vapors, and the hydrosphere, according to some estimates, have 145,4327.2 thousand km of stable water resources. Theoretically, water resources are inexhaustible, because when these resources are used wisely, water resources are constantly renewed. However, in many countries, the problem of water scarcity arose in the late 20th century due to the increasing use of water resources for agricultural, industrial, communal and other purposes, as well as the pollution of water sources by discharging wastewater into rivers and lakes. In the foothills and irrigated areas, groundwater is saturated mainly by surface water.

The water resources of rivers and groundwater are interconnected. Excessive use of groundwater will reduce river flow. In the irrigated agricultural regions of Central Asia, the annual water resources are 114 km, including 74.7 km in the Amudarya (along with Zarafshan and Kashkadarya), 39 km in the Syrdarya, and 2.4 km in the Tajan and Murgab. Although water resources are geographically unevenly formed in the mountains, they are used by a wide range of irrigation canals, mainly in the plains.

**The main purpose of the study.** In the conditions of typical irrigated gray soils of Tashkent region, beans are irrigated by simple tillage and black polyethylene film between the rows, fertilization of organic fertilizers in different norms and proportions, ie dissolved in water. To study the effect of application on plant growth and productivity.

**The main objectives of the study:**

- Improving the elements of irrigation technology by applying mulching between rows of beans with black polyethylene film;
- To determine the effectiveness of the application of organic fertilizers in water, ie fertilization, using a simple furrow and irrigation with a black polyethylene film between the rows;
- Mulching of beans between rows with black polyethylene film to obtain a fertile layer of soil and prevent the leaching of nutrients;
- Improving the efficiency of irrigation by mulching between rows of beans with black polyethylene film;
- Achieving to saving of water and resource by mulching between rows of beans with black polyethylene film;
- Achieving a rich and high yield.

**The object** of the study was the second crop of beans "Rovot", "Mahsuldor".

Field experiments will be conducted in 2021 on the Small Experimental Farm of TashDAU. The mechanical composition of the soil of the experimental field is heavy sand, typical gray, groundwater is located 15 m below, and is irrigated from the old. The experiment is performed in the following system

Before plowing, the norm of local fertilizers is 5-10 tons per hectare. Irrigation is carried out by flexible pipes instead of ditches, with black polyethylene film between the rows. In the experiment, local white beans, Rovot, Makhsuldor varieties are grown. Irrigation is carried out in the order of soil moisture 70-70-60%, 65-65-60% relative to limited field moisture capacity. The experiment consists of 5 variants, each delyanka area is 280 m<sup>2</sup>, placed in three rows, one tier.

Beans are a widely grown crop. Yields decrease when planted in bulk. Row spacing can vary from 50 to 70 cm. 300-400 thousand bushes per hectare provide high yields.

On irrigated lands in Uzbekistan, beans are grown mainly in rows with a spacing of 60 cm. Beans are also planted at 45.70 row spacing. In the experiments conducted at Samarkand Institute of Agriculture, the average yield of beans when planted in the scheme 60x15x6 was 20.9 s / ha, when planted between rows 45x15x6, the grain yield decreased by 18.6 - 17.3 s / ha.



Numerous experiments show that in the conditions of beans in Uzbekistan the yield is highest when the sowing rate of 60 cm between rows is 70-75 kg / ha. Reducing the sowing rate by 70 kg or 120 kg per hectare led to a decrease in grain yield.

The convenience of sowing between rows is 60 cm. The main crop in the Republic is cotton, which is often planted at 60 cm between rows. Therefore, the techniques used in the cultivation of cotton can be easily used in the cultivation of beans.

Bean seeds are sown to a depth of 4-5 cm. If the mechanical composition of the soil is sand, the planting depth is increased by 6-8 cm. Throwing seeds too deep will reduce field germination and cause many seeds to rot. Sowing is carried out on seeders SPCH-6, SPCH-8A, SST-12A. When using beet seeder SST-12A, an additional section STYA-31000 is installed. STVX-4 or SON-2,8 vegetable seeders can also be used for sowing seeds.

## CONCLUSION

For the cultivation of ecologically clean products from water-scarce, arid and eroded, prone to irrigated areas of the country, using organic fertilizers and water-saving technologies, high-yield agro-technology of "Rovot", "Productive" bean varieties will be developed. As a result of scientific research, the positive effects of legumes on the agrochemical and agrophysical properties of soil due to biological nitrogen and organic matter left in the soil are studied.

## REFERENCES

1. Bezborodov Y.G., Esanbekov M.Y. Temperaturniy rejim mulchirovannogo solomoy oroshaemogo tipichnogo serozema [Temperature regime of irrigated typical gray soil mulched with straw]. «Innovatsionnye texnologii v melioratsii». Sbornik materialov mejdunarodnoy nauchno-prakticheskoy konferentsiya (Kostyakovskie chteniya). - Moskva, 2011. S. 214-217.
2. Bezborodov G.A., Bezborodov A.G., Bezborodov Y.G., Kamilov B.S., Esanbekov M.Y. «Qator uzunligi bo`ylab tuproqni bir xil namlantirish usuli [The same method of moistening the soil along the length of the row]». O`zbekiston Respublikasi Intelektual Mulki agentligining ixtirolik patenti. – IAP 04404. Toshkent, 2009. 109-112 betlar.
3. Abdug`aniev H. Agrar soha uchun ilg`or texnologiyalar [Advanced technologies for the agricultural sector]. // Ro`znoma Qishloq hayoti. – Toshkent, 2015 28-may., - №64 (8457). – b. 2.
4. Mednis M.P. «Rejim orosheniya xlopchatnika [Irrigation regime for cotton]» Tashkent, 1973 g. Uslubiy qo`llanma. O`zPITI, 2007y
5. Mirzaev SH. «Tejamkor texnologiya [Economical technology]» «O`zbekiston qishloq xo`jaligi» №4, 2006 y. 30 bet.
6. Mirzajanov K.M., Shadmanov J.K., Isaev S.X. Ekinlarni sug`orish uchun suv rezervi [Water reserve for irrigation] // Vodo- resursoberegayumie agrotexnologii v Respublike: Tez. dokl. mejd. nauch. prak. konf. 5-6 dekabrya 2008. - Tashkent, 2008. - str. 86-89 betlar.



**ACADEMICIA**  
**An International**  
**Multidisciplinary**  
**Research Journal**  
 (Double Blind Refereed & Peer Reviewed Journal)



**DOI: 10.5958/2249-7137.2021.01119.8**

## IMPROVEMENT OF COTTON NUTRITION PROCEDURE AND IRRIGATION TECHNOLOGIES

**Guliston Nuranovna Abdalova\***; **Jamoliddin Saporboyugli Eshonkulov\*\***;  
**Sarvar Olimugli Sulaymonov\*\*\***, **Fazilat Marufqizi Abdullayeva\*\*\*\***

\*Candidate of Agricultural Sciences

Tashkent State Agrarian University, Tashkent, UZBEKISTAN

Email id: 1963gulistan@mail.ru

\*\*Assistant

Tashkent State Agrarian University, Tashkent, UZBEKISTAN

Email id: 1992.jamoliddin@mail.ru

\*\*\*2-Year Student.

Tashkent State Agrarian University, Tashkent, UZBEKISTAN

\*\*\*\*4-Year Student.

Tashkent State Agrarian University, Tashkent, UZBEKISTAN

### ABSTRACT

*This article presents the results of research- fertilization by laying a black polyethylene film between the rows of cotton and field experiments on irrigation technologies conducted in the conditions of typical gray soils of Tashkent region. In order to save water in the irrigation of cotton and other crops, mulching between rows with black polyethylene film and straw and the introduction of irrigation technology using flexible artificial pipes is highly effective. The plant thrives only when the soil moisture is moderate. This can be achieved by improving irrigation techniques and technologies. In field experiments, the timing and rate of cotton irrigation were determined by soil moisture. It was found that the seasonal water norm saved an average of 1,095 m<sup>3</sup> or 27.3% of irrigation water per hectare in the variants irrigated between rows with black polyethylene film compared to the options irrigated by conventional irrigation.*

**KEYWORDS:** *Typical Gray Soils, Cotton, Navruz Variety, Feeding, Irrigation Regimes.*

## INTRODUCTION

**Relevance of the topic.** Creation and maintenance of fast-ripening, high-yielding and high-fiber cotton varieties, resistant to various stressors in the development and widespread introduction of optimal agrotechnologies for the further development of cotton growing.

One of the important measures in the system of agro-technologies of cotton cultivation is irrigation and feeding with mineral fertilizers and tillage. Saving available resources through minimal tillage of the soil, the source of mineral fertilizers and irrigation water resources is scarce today and their rational use is becoming a requirement of the times.

When cotton is fed with mineral fertilizers from the growing season, part of the fertilizer is blown into the air, part is washed away by sewage, and the efficiency of assimilation by the plant is very low. In world agricultural practice, the use of mineral fertilizers in water methods is widely used in crop nutrition, which is considered effective. In recent years in our country there is a problem of water shortage in the irrigation of agricultural crops, in particular, cotton and cottonseed.

At present, when there is a shortage of available water resources, it is advisable to reduce the wasteful use of irrigation water as much as possible when calculating the seasonal water norm in cotton. This can be achieved through the direct application of water and resource-saving technologies and their further improvement.

In order to save water in the irrigation of cotton and other crops, mulching between rows with black polyethylene film and straw and the introduction of irrigation technology using flexible artificial pipes is highly effective. When cotton is mulched between rows, the physical evaporation of soil moisture is reduced, soil washing is prevented, and when water is distributed to the field through flexible artificial pipes, water wastage is eliminated through ditches.

Mulching between rows can achieve two most important efficiencies: it saves irrigation water and increases the yield of crops grown between rows. Improving the elements of irrigation technology through cotton sowing, mulching between rows using local mulch materials is one of the ways to save water and protect the soil.

**The main purpose of the study.** To study the effect of application of mineral fertilizers in different norms and proportions, ie on plant growth and development and cotton yield, along with irrigation of cotton under typical gray soils through a simple furrow and between rows with black polyethylene film.

**Research results.** Field experiments were conducted in 2015-2017 on the area of 1.1 ha on the №86 contour at the Akkavak experimental site of Institute of Cotton Breeding, Seed Production and Cultivation Agrotechnology. The mechanical composition of the soil of the experimental field is heavy sand, typical gray, the groundwater is located 15 m below, and it has been irrigated for a long time. The experiment was conducted in the following system. In the experiment, a promising medium-fiber cotton variety "Navruz" was planted. Irrigation was carried out in the order of 70-70-60% relative to the soil moisture limited field moisture capacity. The experiment consisted of 9 options, each delyanka area was 240 m<sup>2</sup>, placed in three tiers, one tier. All observational measurements and analyzes in the research were carried out on the basis of the methodical manual "Methods of field experiments with cottonseeds in the conditions of cultivation" adopted by Institute of Cotton Breeding, Seed Production and Cultivation

Agrotechnology (Former UzPITI), agro-technical measures were carried out in the order adopted by the farm.

On April 25, 2017, cotton was sown in the experimental field at the rate of 60 kg per hectare of hairy seeds of medium-fiber Navruz variety. Germination of seedlings averaged 8–12 days after sowing. During the season with mineral fertilizers were fed in accordance with the experimental system at a rate of 240 kg of nitrogen, 175 kg of phosphorus and 100 kg / ha of potassium. Depending on the weed experimental options, 3 manual mowings and 2 weeding were performed. In 2017, 20% of ENTO Suchio chemical treatment against aphids and thrips was used at 300 g / ha, Omayd against spider mite at 100 g / ha and sulfur powder during weeding and flowering.

Irrigation in the experimental field was carried out in accordance with the experimental system on the basis of the work program, pre-irrigation soil moisture in the order of 70-70-60% relative to the limited field moisture capacity. At the same time during the season in all variants of the experiment watered 6 times.

Intercropping of cotton was carried out only in the variants irrigated by simple sowing, and this was 4 times during the growing season. Mulching of black polyethylene film between the rows was carried out during the cotton weeding (26.06). The cotton was spun twice by hand and defoliated once in September. The cotton crop was harvested by hand in two harvests.

Today, when there is a shortage of water, the role of irrigation in the production of high and high quality crops from cotton and other agricultural crops is invaluable. Delayed and poor quality irrigation in the care of agricultural crops not only reduces yields, but also has a negative impact on crop quality.

The plant thrives only when the soil moisture is moderate. This can be achieved by improving irrigation techniques and technologies. In field experiments, the timing and rate of cotton irrigation were determined by soil moisture. Prior to each irrigation, soil samples were taken from every 0–10 cm layer to a depth of 0–100 cm and determined using the thermostat weighing method. Water consumption for each irrigation was measured using a 900-degree Thomson water meter. During the application period, pre-irrigation soil moisture in all irrigation methods of cotton was carried out in the order of 70-70-60% relative to limited field moisture capacity.

According to the results, the typical gray soils of Tashkent region were irrigated 6 times at the rate of 602-980 m<sup>3</sup> per hectare during the period of validity in 1,2,4,5 and 7,8 variants irrigated by ordinary furrow, the average seasonal water norm was 4075 m<sup>3</sup> per hectare. In variants 3,6 and 9, irrigated with black polyethylene film between rows, it was observed that cotton was irrigated 6 times at an average rate of 500-590 m<sup>3</sup> per hectare during growth and the seasonal water norm was 2980 m<sup>3</sup> per hectare on average.

The calculated layer of soil moisture before irrigation was calculated as 70-100-70 cm in accordance with the phases of growth and development of cotton in options 1,2,4,5, and 7,8, while in options 3,6 and 9 the calculated layer was calculated as 50-50- Formed a layer of 50 cm. In the variants mulched with black polyethylene film between the rows, irrigation was carried out less frequently. It was found that the seasonal water norm saved an average of 1,095 m<sup>3</sup> or 27.3% of irrigation water per hectare in the variants irrigated between rows with black polyethylene film compared to the options irrigated by conventional irrigation.

## CONCLUSIONS

At the beginning of the cotton growing season, the average content of humus in the 0-30 cm driving layer of the soil is 0.146%, total nitrogen and phosphorus content is 0.047-0.128% and nitrate content is 0.84 mg / kg, mobile forms of phosphorus and potassium average 20.3-312 mg / kg. In the 30-50 cm layer, these values are proportional to the average humus content of 0.108.3%, total nitrogen and phosphorus content of 0.031-0.087% and nitrate content of 0.51 mg / kg, mobile forms of phosphorus and potassium averaged 17.4-288. mg / kg. It can be concluded that humus and nitrate are low in mobile phosphorus and medium in mobile potassium.

In the 1,2,4,5 and 7,8 variants irrigated by the normal field, the norm was 595-1010 m<sup>3</sup> per hectare 6 times during the period of operation, the average seasonal water norm was 4200 m<sup>3</sup> per hectare. In variants 3,6 and 9, irrigated with black polyethylene film between rows, it was observed that cotton was irrigated 6 times at an average rate of 450-750 m<sup>3</sup> per hectare during growth and the seasonal water norm was 3300 m<sup>3</sup> per hectare on average.

## REFERENCES:

1. Shamsiev A.S., Bezborodov A.G. Vliyaniye antropogennix i biosfernix faktorov na uglekislotniy balans i vodopotrebleniye v kottonatnitskoy tseluloznoy promyshlennosti [Influence of anthropogenic and biospheric factors on carbon dioxide balance and water consumption in cotton]. Toshkent-2015
2. G.A. Bezborodov - «Primeneniye solomiv kachestve organicheskogo udobreniya i depressora isparennyav lagivoroshayemom zemledelii [The use of straw as an organic fertilizer and depressant of moisture evaporation in irrigated agriculture]» Xalqaro ilmiy-amaliy konferensiyama'ruzalari asosidagi maqolalar to'plami. Toshkent 2007 y. 9-13 betlar.
3. G.A. Bezborodov - "Sovershenstvovanie orositelnoy seti i tekhniki polivax v lopchatnikav predgornoy zone Uzbekistana [Improvement of the irrigation network and cotton irrigation technique in the foothill zone of Uzbekistan]" dissertation for the degree of Doctor of Technical Sciences on the topic. Toshkent, 1994.
4. Kamilov B.S., Xasanov M.M. Tomchilatib sug'orish usulining g'oh' zahosildorligiga ta'siri [Effect of drip irrigation method on cotton yield] // Problemi v xlopkovodstve i perspektivnie puti ixresheniya: Tez. dokl. mejd. nauch. prak. konf. 2-3 dekabrya 2009. - Tashkent, 2009. - str. 338-339
5. J.X. Axmedov, A.E. Avliyoqulov, A. Nuriddinov, M. Xasanov, A. Baxromov - Promising variety of cotton "Navruz" and agro-techniques for its cultivation. Scientific and practical bases of increasing soil fertility (part 2) Collection of articles based on reports of the international scientific-practical conference. Toshkent, 2007 y., 160-161 betlar.

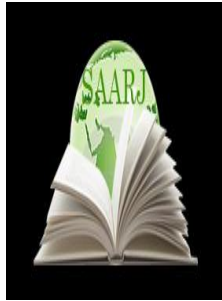

**ACADEMICIA**  
**An International  
 Multidisciplinary  
 Research Journal**  
 (Double Blind Refereed & Peer Reviewed Journal)

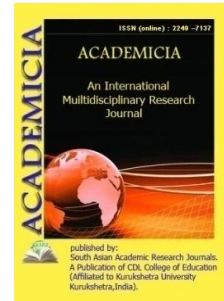

**DOI: 10.5958/2249-7137.2021.01120.4**

**EFFECTIVE USE OF FUNGICIDES AGAINST  
 THE FILLOSTIKTOZNOY P YATNISTOSTYU APPLE LEAVES UNDER  
 FERGHANA VALLEY**

**Mirzaitova M.K\*; Siddikova N.K\*\***

\*Assistant,  
 Andijan Institute of Agriculture and Agrotechnology,  
 UZBEKISTAN

\*\*Senior Lecturer,  
 Andijan Institute of Agriculture and Agrotechnology,  
 UZBEKISTAN

**ABSTRACT**

*The article presents the results of research and experience carried out in the conditions of the Ferghana Valley on the identification of the biological effectiveness of chemicals against £ illostiktoz fruit crops , which is caused by imperfect fungi of the genus Phyllosticta . As a result of the disease (scab of apple and pear trees, powdery mildew, moniliosis stone and pome rocks, leaf rolling, klyasterosporioz apricot, grape powdery mildew, anthracnose, etc.) each year occur in our gardens.*

**KEYWORDS:** *Apple Tree, Cultivar, Jeromin, Red Chief, Red Dilishes Phyllostic Spotting, Fungicide, Hebenapl 40% , Triskabol76 % , Effective Use*

**INTRODUCTION**

The agriculture of Uzbekistan has been tasked with significantly expanding the area under orchards and vineyards. Agriculture produces basic food products as well as raw materials for food and other industries. The main task of the agro-industrial complex is to improve the quality of products, eliminate its losses at all stages of production, transportation and storage.

Since 2014, the area allotted for gardens has been expanding in Uzbekistan, intensive gardens have been created on an area of 5.6 thousand hectares. Gardens on an area of 4.1 thousand hectares and vineyards on an area of 6 thousand hectares were reconstructed. 410 hectares were developed for greenhouses.

In recent years, despite the lack of water supply, thanks to the efforts and labor of our farmers, a good harvest has been obtained and harvested. In particular, for 9 months this year, 6.7 million tons of vegetables (111% compared to 2013), 1.9 million tons of potatoes (111%), 1.2 million tons of melons and gourds (109 %), 1.7 million tons of fruits (115%) and 991.6 thousand tons of grapes (109%).

Gardening in the structure of agriculture in our Republic is traditionally considered one of the main and profitable areas. The fruits grown here are known in the world and are of good quality and high taste.

One of the most important tasks for improving the quality and quantity of fruits facing gardeners is to reduce losses from harmful organisms, in particular from the development of various plant diseases, the causative agents of which can be fungal, bacterial, viral, phytoplasmic organisms and nematodes.

Favorable climatic conditions of Uzbekistan for the development of plants are also favorable for the preservation and development of pathogens of various diseases. As a result of the disease (scab of apple and pear trees, powdery mildew, moniliosis stone and pome rocks, leaf rolling, klyasterosporioz apricot, grape powdery mildew, anthracnose, etc.) each year occur in our gardens. Therefore, in the absence of protective measures, we lose a significant part of the potential yield.

The main emphasis in solving these problems is given to chemical plant protection, on the one hand, this method is the most effective and easy to use, but it carries many negative aspects. First, the constant use of the chemical method, including non-selective drugs, leads to environmental pollution, toxic effects on other living organisms, including humans.

Preventive and agrotechnical measures carried out correctly and on time against plant diseases have a positive effect on reducing the population of pathogens, however, with a massive and strong development of diseases, they are not enough. In this connection, expanding the range of fungicides approved for use in Uzbekistan and their effective use is an important task in horticulture.

One of the most widespread and harmful disease in pome fruit crops in orchards Uzbekistan is n yatnistost apple leaves or F illostiktoz fruit crops .

Fillostiktoz fruit crops - a disease which is caused by imperfect fungi of the genus *Phyllosticta* . They form mottles characteristic of certain types of fungi.

On the apple tree, the most often isolated - *Phyllosticta mali* Pr . et Del . , *Phyllosticta briardi* Sacc . On pear and apple - *Phyllosticta pirina* Sacc . On quince - *Phyllosticta cedoniae* Sacc . \_ \_ \_ \_

The infection is widespread, but it manifests itself periodically, mainly in foci.

Defeat the first symptoms of phyllostictosis often appear in late May - early June. By the middle of summer, a strong progression of the disease is noticeable. Pathogens affect mainly the leaves of the apple tree, less often quince and pear. On the leaf blades, the formation of necrotic, in most round, brownish spots is observed. In some cases, lesions appear on the fruits of the apple tree in the form of medium-sized brown, slightly deepened dry specks, with a diameter of 5 mm to 8 mm.

The causative agents of the infection are fungi of the genus *Phyllosticta*, in some cases forming the teleomorphic (marsupial) stage - *Mycosphaerella spp.* Most often, *Phyllosticta mali* Pr. et Del. ;

*Phyllosticta briardi* Sacc. ; *Phyllosticta pirina* Sacc. ; *Phyllosticta cydoniae* Sacc. . . . .

*Phyllosticta mali* Pr. et Del. - affects the leaves of the apple tree, forms small rounded spots, at first brownish, later gray with a dark brown border. *Phyllosticta briardi* Sacc. - affects the leaves of the apple tree, forms light yellow rounded or somewhat angular spots, without a border, up to 5 mm in diameter. *Phyllosticta pirina* Sacc. - affects pear leaves, is less often noted on an apple tree, forms round or irregular spots, merging with each other. A characteristic symptom of the disease is the formation of black pycnidia with colorless unicellular pycnosporos on the spots, differing in shape and size depending on the type of fungus. *Phyllosticta mali* Pr. et Del. - ovoid or oval pycnosporos. Disease-causing pathogens overwinter in the form of pycnidia on fallen leaves. Sometimes they form perithecia, in which bags with ascospores are formed (teleomorphic stage). Often the disease develops against the background of necrotic lesions caused by various reasons, including improper use of pesticides, necrotic spots of the causative agent of black cancer (apple tree), and others. . . . .

Warm, rainy weather contributes to the development of infection. In conditions of high humidity, pycnidia swell and release pycnosporos, which leave the place of maturation with a mucous mass of a ribbon-like, wriggling shape. Some pycnosporos are carried by wind, rain and insects, fall on leaves, germinate and form new areas of infection.

Fungicides registered in Uzbekistan against diseases of fruit crops occupy an important place in agricultural practice, however, it is of great importance that the country has a sufficiently wide range of highly effective and modern fungicides with different active ingredients, so that agricultural workers have the opportunity to provide the population with high-quality fruits and vegetables.

Fungicide Hebenepl 40% SK. experienced in the areas, planted apple varieties in Zheromin, Red Chief, Red Dilishes in farmer's ozyaystvAndijan and Ferghana regions. The zone is located in a mountainous farming area. The gardens were laid out 10 years ago.

The treatments were carried out using a motorized knapsack sprayer with a calculated flow rate of the working fluid of 1000 l / ha. The experiments were laid in the morning hours, from 8 to 10 o'clock, when the air temperature did not exceed 26 ° C and the wind speed was 1 m / s.

To account for the intensity of disease - scab applied scale Anpilogova (Giants et al., 1980), where the calculated percentage of diseased leaves (rating 0 - lesion otsutviem; 1 point - struck to 1/5 the entire area or plants to 10% of the surface sheet 2 - affected up to 1/3 of the plant area or up to 25% of the leaf; 3 - affected up to 2/3 of the plant surface or up to 50% of the leaf surface; 4 - more than 2/3 of the plant or more than 50% of the leaf surface are affected), for moniliosis - 100 fruits for each point of 4-point scales according to the formula:

$$R = \sum (AB_1 + AB_2 + AB_3 + AB_4) / K$$

Where, R is the intensity of the disease,

A is the number of plants; B<sub>1</sub>; B<sub>2</sub>; B<sub>3</sub>; B<sub>4</sub> - points from 1 to 4.



$\sum (AB)$  - the sum of the products of the number of plants by the corresponding score

K - the highest score of the scale of accounting for the intensity of the lesion

The report shows the average values of the data for 10 trees

To calculate the biological effectiveness Hebenepl 40% SK . the treatment against leaf spot was carried out starting from the appearance of spots on the leaves (Khasanov et al., 2010).

Testing of the drug, conducting accounting and processing of digital material was carried out in accordance with the "Methodological instructions ..." of the State Chemical Commission of the Republic of Uzbekistan (2004). To determine the infection of oidium leaves and shoots, the scale recommended for taking into account the development of oidium on vine leaves was used according to A.E. Chumakov , I.I.Minkevich , T.I. Zakharova , 1973 (Zakharenko, Chenkin , 1985).

$$C = \frac{R_k - R_o}{P_k} \times 100$$

where: C - biological efficiency,%;  $P_k$  - indicator of the development of the disease under control;  $R_o$  is an indicator of the development of the disease in the experimental site (in the experiment), in terms of 15, 30 or 45 days, point.

Testing, subsequent accounting and calculations of biological effectiveness were carried out in accordance with the "Methodological instructions ..." (2004), approved by the State Chemical Commission of RUz .

Experience scheme:

- 1) Hebenepl 40% SK . - 0.55 l / ha
- 2) Hebenapl 40% drymatter - 0.754 l / ha
- 3) Triskabol 76% dg - 0.3 l / ha (reference)
- 4) Control - noprocessing

Fungicide Hebenepl 40% SK . It was tested against the disease on apple n leaf spot, causing enormous damage to fruit growing in Uzbekistan.

The tests were carried out against the background of infection with n leaf spot of apple trees at the level of 6.9-12.8%.

The final analysis showed that when the fungicide Hebenapl was treated with 40% d.c. at a rate of 0.55 l / ha against leaf blight on apple trees, the biological efficiency was 83.8%.

The biological efficacy of the fungicide Hebenepl 40% s.k.v flow rate 0 75 l / ha against disease n yatnistost leaves on apple was 91.5%.

The biological efficacy of the reference drug Triskabol is 76% SDG. was perceptibly high for all counting periods and amounted to 88.9 % on leaves, respectively (Table 1).

**TABLE 1 THE BIOLOGICAL EFFECTIVENESS OF THE FUNGICIDE HEBENAPL IS 40% DRY MATTER . AGAINST DISEASE SPOTTING OF APPLE TREES (PRODUCTION EXPERIENCE, FERGANA REGION, KUVA DISTRICT, "ROHATOI" FARM**

No.	Variants	Consumption rate of the drug, kg, l / ha	Leaves		
			Damage ,%	Disease development,%	Biological efficiency,%
1	Hebenepl40%sk	0, 55	12.8	6.1	83.8
2	Hebenepl 40% sk .	0, 75	6.9	3.2	91.5
3	Triskabol 76% dg	0.3	11.0	4.2	88.9
4	Control (noprocessing)	-	37.8	17.4	-

Thus, a fungicide Hebenepl 40% SK . is highly effective when applied against diseases n leaf spot in on apple a flow rate 0, 55 0, 75 l / ha, in connection with which the drug must be included in the "List ..." to combat these diseases in gardens.

#### LIST OF USED LITERATURE

1. Velikanov L.L., Sidorova I.I., Uspenskaya G.D. Field practice in the ecology of mushrooms and lichens. –M., Publishing house of Moscow State University . 1980-111 p.
2. Dementyeva M.I., Vygonsky M.I. Diseases of fruits, vegetables and potatoes during storage. M., Agropromizdat . 1988.-231
3. Kazenas L.D. Diseases of wild fruit and berry plants. - Alma-ata ,Kainar, 1971-143
4. Ciba catalog - Geigy . Your consultant on means of protecting agricultural crops from diseases, pests and weeds, 2000 - 84 p.
5. Kolesov D.A. Protection of fruit and berry crops from diseases and pests. Voronezh, Socium, 2010 - 25 p.
6. Pidoplichko N.M. Parasitic fungi of cultivated plants. Determinant. T.2. Unfinished mushrooms . - Kiev, Naukova Dumka, 1977 - 300 p.
7. Trisvyatsky L.A., Lesik B.V., Kurdina V.N. Storage and technology of agricultural products - M., Kolos, 1983 -383 p.
8. Kamroev A.Sh., AzimovZh.A.,Niyozov T.B. wa b.The garden, the vines pests, diseases and the system of combating them . Toshkent : "Fan", 1995, 160 b. (Pests and diseases of fruit trees and vineyards and control measures).
9. Hasanov BA, Ochilov RO Holmurodov EA, Gulmurod RA. Diseases and control of fruit and walnut trees, citrus, berry bushes and vines. Toshkent : " OfficePrint ", 2010, 310 b. + 62 b. rangli tasvir . (Diseases of fruit, nut-bearing, citrus, berry crops and vineyards and measures to combat them).
10. Mirzaitova , M.K., Siddikova , n. K., & Abdullaeva , G. D. K. (2019). Moniliosis on stone fruit crops. *Bulletin of Science and Education* , (24-3 (78)).

11. Kamiljanovna , s. N., Kamilov , s. G., & Kamiljanovna , m. M. (2020). Fusarium oxysporum and dealing with them. *Palarch's journal of archeology of egypt / egyptology* , 17 (6), 3658-3662.
12. Mirzaitova , M.K., Karimov, Fr. K., & Davlatova , f. A. (2020). Shaftolida kang tarkalangan zamburuli casalliklardan biri - clasterosporium disease . *Life sciences and agriculture* , (2-2).
13. Sotvoldiev , sh., & Mirzaitova , M. (2019). Phytopathogenic fungi. In *research in natural sciences and engineering: interdisciplinary dialogue and integration* ( pp . 40-42).
14. Hoshimova , S. , & Mirzaitova , M. (2019). Venturia inaequales - apple tree disease. In *research in natural sciences and engineering: interdisciplinary dialogue and integration* ( pp . 43-45).

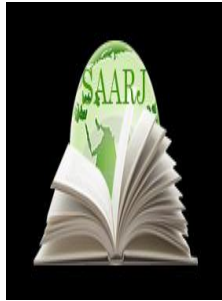

**ACADEMICIA**  
**An International**  
**Multidisciplinary**  
**Research Journal**  
 (Double Blind Refereed & Peer Reviewed Journal)



**DOI: 10.5958/2249-7137.2021.01121.6**

## THE IMPORTANCE OF TEACHING ENGLISH TO CHILDREN IN PRESCHOOL EDUCATIONAL INSTITUTIONS

**Sayyora Yuldashovna Pulatova\***

\*Senior Teacher,  
Termez State University,  
UZBEKISTAN

### ABSTRACT

*This article deals with the process of teaching of foreign languages, especially English, in preschools on the basis of innovative advanced methods. The views of methodologists about the game is discussed as well. Description of games of an interactive nature that motivate the child to successfully master the English language is considered too.*

**KEYWORDS:** *Foreign Languages, Preschool Education, Modern Educational Programs, English, Speech Exercises, Healthy Development, Orally, Knowledge, Young Learners, Pronunciation.*

### INTRODUCTION

I.A.Karimov's book "High spirituality is an invincible force" states: "Education is inseparable from upbringing, and upbringing is inseparable from education - this is the Eastern outlook, the Eastern philosophy of life." [1].

At present time in the field of preschool education, home-based kindergartens and a network of "kindergarten-school" are developing as well. From this point it is known in Uzbekistan there are many groups that teach children foreign languages, choreography, fine and musical arts, rhythmic and artistic gymnastics, computer literacy.

In particular, in 2014, a program called "We are friends with the English language"[ 5] to teach the first English lessons to children in preschool education was developed and delivered to all institutions. Today, there are more than 4,833 English language clubs in preschools in the country[4].

To create conditions for the comprehensive intellectual, moral, aesthetic and physical development of children, on the initiative of President Shavkat Mirziyoyev, a resolution was

adopted on measures to further improve the system of preschool education in 2017-2021. Implementation of the decision as one of the main priorities of state policy will provide an integral and step-by-step development path for further reform of the system of continuing education of the republic[7].

Therefore in accordance with the decree of September 30 2017 year “On measures to radically improve the management of the preschool education system” and the resolution “On the organization of the Ministry of Preschool Education of the Republic of Uzbekistan” created a new system in this area.

- Further improvement of the preschool education system;
- strengthening the material and technical base;
- expansion of the network of preschool educational institutions;
- provision of qualified teaching staff;
- radically improve the level of preparation of children for school education
- introduction of modern educational programs and technologies in the educational process;

According to Methodists, teachers’ assessments and support are very important for preschools. It is required from English language teachers to have skill, strong knowledge, potential and patience. They must be fluent in English and psychologically able to communicate with children as well. Doubtless, it is the task of the educator to be able to engage young learners through didactic games, to organize the game properly and to develop the skills of collaboration[3].

Today the main purpose of teaching English in preschools is to teach this language orally for children of preparatory age. This ensures that children learn English perfectly and prepare them successfully for school. Therefore, in the process of teaching children English, it is advisable to collect language materials that are familiar to them, in consideration of their psychological aspects, through the active learning we can involve children’s attention.

In order to achieve this process we should to provide environments that appeal to all their senses, including visual, auditory, kinesthetic and tactile. Learning such activities is possible to realize through chants, songs, rhymes, dances, games, videos and others.

For example, following the opinions of instructors when learning a new word in class, children might first: hear the word in songs or chants; repeat the word in singing alone or they can recognize some letters and produce the new words.

It is important to note, that play is a very significant part of what life means to children at the stage of their development. Teachers should promote learning English through play as much as possible. The most exciting ways children learn are the games with flashcards, competitions, races that encourage active learning and help to develop social skills.

Obviously, the language materials taught in this task are carried out through games, songs, poems and drawings that are interesting for children’s parents will have to learn to talk about their professions, about themselves and their families, to do speech exercises, to sing poems and sing. In this way, conducting English lessons has an effective impact on the healthy development and upbringing of children. Wherein, we shouldn’t forget about the creativity and imagination that

are part of their learning process controlled by the teacher. And we should allow them to go further and use their own idea[6].

Mentioned above, a form of effective teaching of preschool children is play. According to T.L. Alekseeva, a well-known Russian English teacher and methodologist considered that in order to participate in games in English classes for children, the teacher must be able to organize various games and arouse children's desire to express themselves in English, or at least how to speak English. During the game, children will need to be polite to each other in pairs or group games, thank each other for their participation in the game, help each other in situations or when necessary, and teach solidarity. These games have a positive effect on the psyche and upbringing of children[2].

These are forms of greeting, farewell, and apology (Good morning, Good afternoon, Good evening, Good night, Good bye, Excuse me): words like thank you, please, sorry, sorry (Thank you, please, I am sorry,). As children memorize these words, they can then use these words in active play in everyday life[4].

It is fair to say that the use of common games between English and American children in English lessons is similar to our own children's play. Thus, they develop a sense of goodwill towards all the children of the planet and the similarities of the children of the world. It means that developing social skills is also very important while learning language. Because children need to learn to socialize with each other, showing some important values as respect and sharing[2].

In this way, children participate in games with great interest and like to pronounce words. For example, to pronounce the words "a cat" and "a map" clearly, the children are encouraged to pronounce them clearly 2 or 3 times after the word, and then the sequence continues in the same way. We can control the movement of the tongue, lips, etc. when they pronounce a word only after showing them the movements of the tongue and lips. We encourage them to imitate and pronounce it later. Only our pronunciation, ways of using the organs of speech, and the formation of the desired sounds can be a shining example.

## CONCLUSION

In conclusion, it should be noted that the appropriate organization of English lessons in preschool education helps to fulfill educational tasks and prepare children for school. Through the playing games, children learn language and it is impossible to develop or expand their vocabulary. We must take into account that all over the world, learning foreign languages, especially English, is one of the great important strategy to our children.

## REFERENCES

1. Karimov I. A. Yuksak ma'naviyat- yengilmas kuch. T.: Manaviyat, 2008, -P.176.
2. Alekseeva T.L. Eksperimentalnoe obuchenie angliyskomu yazyku v detskom sadu. (Statya), Zhurnal: Inostrannye yazyki v shkole №5-1989., P.9.
3. Moydinova E.K.-Maktabgacha ta'lim muassasalarida ingliz tilini o'rgatish xususiyatlari, Toshkent – 2016, P.45.
4. Pulatova S.Yu. Saydullaeva G.X. – Texnologiya obucheniya leksiki angliyskogo yazyka v doshkolnyx uchrejeniyax. Priorities of preschool education: problems, solutions and

prospects., Volume of the Republican scientific-practical conference, April 10-12, 2017, Termez-2017. P. 55.

5. Pulatova S.Yu., Gerasimova S.S. (2020) Philadelphia, USA . About the role of games in teaching English Language to preschoolers. Theoretical & Applied Science. Issue 05. Volume. 85, P. 910-912. Available at: [http://T-Science\\_org](http://T-Science_org).

6. [www.uzedu.uz](http://www.uzedu.uz) Roundtable on "A new approach to the introduction of quality preschool education.", Press release, February 12-13, 2014. Ministry of Public Education., Information Service. 1.2 p.

7. <http://president.uz/uz/lists/view/1162>

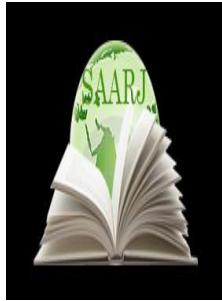

**ACADEMICIA**  
**An International  
 Multidisciplinary  
 Research Journal**  
 (Double Blind Refereed & Peer Reviewed Journal)



**DOI: 10.5958/2249-7137.2021.01122.8**

## GENDEROLOGICAL CHARACTERISTICS OF UZBEK NICKNAMES

**Shahnoza Ubaydullaevna Nizamova\***

\*Researcher,  
 Kokand State Pedagogical Institute,  
 UZBEKISTAN

### ABSTRACT

*The article distinguishes the anthroponymic meaning of Uzbek nicknames specific to women (denoting a female person), lexical, nominative-motivational basis, and ethnographic features associated with the naming of the Uzbek people.*

**KEYWORDS:** *Nickname, Anthroponymy, Genealogical Nature, Ethnography, Lexical Basis.*

### INTRODUCTION

Nicknames, like other anthroponymic units, are of a genealogical nature. Nicknames perform differential and genealogical functions by referring to the gender of the owner of the name. In female-specific nicknames, this function is clearly observed. Female nicknames are characterized by their anthroponymic meaning (representing a female person), lexical, nominative-motivational basis, based on ethnographic traditions associated with the naming of the Uzbek people. For example, *Uvaysiy*, *Nodirabegim*, *Anbar atin*, *Dilshod Barno*, *Khoki* (*Uvaysiy's* daughter *Quyoshkhan*), *Tamarakhonim*, *Zulfiya*, *Aydin*, *Olmos*.

### THE MAIN FINDINGS AND RESULTS

Female nicknames in the Uzbek language can be grouped according to the creative direction of the authors as follows:

1. Nicknames of female poets and writers: *Uvaysiy*, *Nodirabegim*, *Anbar otin*, *DilshodBarno*, *Zulfiya*, *Aydin* (*ManzuraSobirova*), *Onagul*(*EnakhonSidikova*), *Olmos*, *Dilbarbonu*(*DilbarHaydarova*), *Khayola*(*RuqiyaGozieva*), *Farida Afroz*(*Butaeva*), *ZulfiyaKuroloykizi* (*ZulfiyaYuldasheva*).
2. Nicknames of female singers, dancers and actors: *Tamarakhonim* (*Tamara ArtyomovnaPetrosyan*, singer and dancer, choreographer, one of the founders of Uzbek professional dance, People's Artist of Uzbekistan), *Rayhona* (*GanievaRayhon*, singer),



*SevaraNazarkhan* (NazarkhanovaSevaraAnvarjanovna, singer), *Dilso'z* (JumaniyozovaGuzal, singer), *Kaniza* (AhmedovaShahrizodaFarhodovna, singer), *Shahzoda* (MusaevaZilolaBahodirovna, singer, winner of the Medal of Fame), *Ojiza* (OnabibiOtajonova) [1,364].

3. Nicknames of female journalists: *Nozimakhanim* (first female journalist) [2,219], like *Nodira Said Ahmad kizi*. Some of the pseudonyms are poetic, writer, translator, journalist and scholar: *Zulfiya* (poet, journalist, translator, public figure), *SalomatVafo* (journalist, translator, writer and poet), *GulbahorSaidGhani* (SaidganievaGulbahor, teacher and poet, scholar), *Lola* (Yuldasheva Lola, singer, composer and actress), *MohinurMuhammadjonkizi* (poet, translator).

In Uzbek anthroponymy, the nickname of ancestors is also used as a sign of respect. For example, *Kaniza* is the nickname of the singer AhmedovaShahrizodaFarhodovna (28.04.1985 - Fergana region, Kokand, singer). Shahrizada took the pseudonym of her grandmother [3].

Most of the nicknames for creative and artistic Uzbek women are derived from their first and last names and are called first names. Nicknames are formed on the basis of abbreviating the original name or surname of the artist and artist: *Zulfiya* (ZulfiyaIsrailova), *Nazira As-Salom* (SalomovaNazira), *Nodira Said Ahmad kizi*, *Malika Mirzokizi* (Mirzaeva Malika), *MatlubaDehqonkizi* (AhmedovaMatlubaDehqonqizi), *MohinurMuhammadjonkizi*, *Muhabbat Ibrahim kizi*, *MahliyoOmon* (RahmonberdievaMahliyoOmonjonqizi).

Nicknames of female artists and artists in the Uzbek language can be grouped according to the nominative-motivational and lexical basis as follows:

1. Nicknames based on words denoting such a sign as great, great: *Muazzam* (MuazzamhonMirsaidkizi (second half of the XIX century, Khojand - 1917, Jizzakh) - poet, *Kutlug* (ShermuhammedovaMuborak).

2. Celestial bodies: planets, stars Nicknames with lexical bases: *Mushtariy* (Saodat (1810/11, Kokand -?) - Poet, *ZuhroYulduzi* (BarakaevaYulduz) - poet. Each of these nicknames has its own lexical and spiritual features. For example, the poet *Mushtari* created written poetic samples of folk oral epics. Her real name was Saodat and she chose the nickname *Mushtari*. *Mushtari* is Arabic and the name of the planet Jupiter:Also means "customer". The poet dreamed of becoming famous from the planet and chose such a nickname. Hilol (KarshievaKamola; 1968, Samarkand) is a poet [5.78].

3. Nicknames based on words denoting the sign of beauty, charm, charm and radiance: *Layli* (Layli - the most beautiful of women), *Barno* (daughter of DilshodRahimqul Sufi), *Bonu* (Samar MawlawiSirojikizi; poet, enlightener), *Anbar* (Anbar otin; poet), *Aydin* (ManzuraSobirova; writer, playwright). Each of these nicknames has a certain anthroponymic meaning. For example, the word *Bonu* was the lexical basis for the nickname of the daughter of *Samar MawlawiSiroji*. The word *Bonu* is Arabic and literally means "ruler, mother, lord, noble, beloved wife, lovable, beloved" [6:73]. The poet chose the nickname *Bonu* because of her positive qualities and her desire to be a sofa.

4. Precious mines, nicknames on which words denoting metal are based: Like *Maadan* (18th-19th centuries). Odina Muhammad sang her own ghazals. He chose the nickname *Maadan* (metal, original stone; mining, treasure) in his dream of being as unique, stately, and as beautiful as pearls. [7.82]

5. Words denoting the sign of grief, anduh are lexically derived nicknames: such as *Mahzuna* (Mehriban Mullah Boshmankizi; approx. 1811, Kokand -?). Historically and etymologically, the Arabic word mahzuna, which is the lexical basis of the nickname, means “treasure, sad, sorrowful, and miserable”. The poet chose this nickname because she lived a sad, miserable life.

6. Nicknames that have a lexical basis for words that express a secret, secret, mysterious character: *Mahfiy* (Zebunnisobegim nickname), *Maknuna* (Mohlar mother Rahmonquli paternal daughter).

In anthroponymy, names are divided into two groups according to their linguistic connotations: male names, such as female names. Typically, the names of men and women in the language differ in nominative-motivational, lexical-semantic, structural features.

There is an interesting situation among the nicknames of women creators and artists in the Uzbek language. Nicknames of some female artists are formed from lexical units based on men's names: *Mavloniy* (MashhuraEgamovna), *Yolkin* (SaodatRakhmonova, poet), *Erkin* (Mahbuba Rahim qizi, poet), *Khaniy* (Rohilahon; XVIII-XIX centuries), and Kokand poet).

We pay attention to the lexical and semantic features of these nicknames: *Mavloniy* (MashhuraEgamovna (1934.4.12, Tashkent) - microbiologist, Academician of the Academy of Sciences of Uzbekistan (1989), Honored Scientist of Uzbekistan (1994), Doctor of Biological Sciences (1971), Industry in Uzbekistan He was the founder of microbiology. He created the first collection of industrial microorganisms in Central Asia.

The word *yolkin* (SaodatRakhmonova), which is the lexical basis of the nickname, means “a flame rising from a burning object; light, ray, radiance, beam” and is observed more as a masculine noun.

In some cases, male poets and writers use female nicknames for specific purposes: *Gulyor*, *Dumbulnisa* (additional nicknames of Abdullah Qahhor) *Mukhtaram*, *Nozik* (Muhammad NematullaqaziSharafiddinogli; poet and tazkiranavis), *Iroda* (SadriddinSaidmurodov (Aini), Sura) Abdulla Avloni), *Maknun* (MullaErnazar, poet), *Mehri* (HojimuinShukrullaev). The lexical bases of these nicknames are widely used as women's names and also spiritually reflect the characteristics of the female gender: The lexical basis of the nickname Dilbar (Ghulam Shadiy, poet) –*Dilbar*. The word is Persian and means “pleasant, endearing, charming, bewitching; beautiful, handsome; beloved” and is often used as a female name in the variants *Dilbar*, *Dilbaroy*, *Dilbarkhan*, *Dilbarbonu*[9,112].

Abdullah Qadiri's humorous nickname *Dumbulnisa* consists of the lexical units' *dumbul* and *niso*. The nickname *dumbul* (f. Immature grain, dukkak) is based on the portable meaning of “foolish, stupid, demented” [10,661], and the anthroponymic meaning of “stupid, abnormal, demented woman or woman; girl” is an abbreviated form of *Mehri's* nickname Mehriniso. Meaning women's sunshine or women's most kind, compassionate. If the author's goal is only to conceal his name, if he wants readers to imagine it as it is not in reality, then he has continued on the path of mystery: a woman takes a man's name or a man takes a man's name [10:8].

## CONCLUSION

The analysis shows that the analysis of linguistic features of onomastic units, including nicknames, including lexical-semantic, nominational-motivational, functional-semantic,

methodological, structural and structural features, reveals the personal life, past, creative concept, dreams and goals of creation and art. is important and essential in learning.

#### REFERENCES

- [1] *National Encyclopedia of Uzbekistan*. – Tashkent: National Encyclopedia of Uzbekistan, 2004. Vol 9.
- [2] Jalilov T. (1970). *Uzbek poets*. – Tashkent: Ghafur Ghulom Publishing House of Fiction.
- [3] <https://uz.wikipedia.org/wiki/Kaniza>
- [4] Xudoyberdiev A. (2021). *Masterpieces of Dormon*. – Tashkent: Music.
- [5] Begmatov E. (2016). *Uzbek names*. III edition – Tashkent: National Encyclopedia of Uzbekistan.
- [6] Erkinov S. and others. (1982). *The Call of the Ages*. – Tashkent: Literature and Art Publishing House.
- [7] Annotated dictionary of AlisherNavoi's works. Volume 2. – Tashkent: Fan, 1983.
- [8] Begmatov E. (1998). *Uzbek names (14600 name comments)*. – Tashkent: National Encyclopedia of Uzbekistan.
- [9] *Annotated dictionary of the Uzbek language*. – Tashkent: National Encyclopedia of Uzbekistan, 2006. Vol 1.
- [10] Kolosova S. (2009). *Encyclopedic dictionary of pseudonyms*. –Moscow.



**ACADEMICIA**  
**An International**  
**Multidisciplinary**  
**Research Journal**  
 (Double Blind Refereed & Peer Reviewed Journal)



**DOI: 10.5958/2249-7137.2021.01123.X**

**DYNAMICS OF JOURNALISTIC CONTENT: CHANGES IN FORM AND CONTENT**

**Sohiba Mullaeva\***

\*PhD Student,  
 Uzbekistan University of Journalism and Mass Communications,  
 UZBEKISTAN  
 Email id: smullayeva@mail.ru

**ABSTRACT**

*This article analyzes the stages of development of journalistic content, changes in form and content as a result of the influence of social life and the audience. As a result of the revolutionary events of the seventeenth and eighteenth centuries, monopoly power in a number of countries was abolished and replaced by new and more advanced regimes. Not everything is written in detail here, but the traditions of written journalism are highlighted: that is, “nothing has been said to the government about the facts”. A journalist who creates media content should use the same, understandable methods of expression. It should be borne in mind that the modern audience is busy and needs a lot of speed.*

**KEYWORDS:** *Content, Text, Genre, Format, Journalism, Media Convergence, Convergence Editorial, Audience.*

**INTRODUCTION**

No matter what direction the media operates, a journalist works with content. The core of any content is text. In addition to being a representative of a print or online publication, a TV and radio journalist also displays a certain portion of his or her talent and skills through text.

In the period from the emergence of journalism to the present day, the text, which is an important expression of content, and the demand and approach to it are constantly changing and evolving.

According to Professor Fayzulla Muminov, the first need for information exchange arose due to the coordination of the management of the upper classes in the Roman Empire. Extensive political information exchanges focused more on economic, personal, domestic, and perceptual goals than political movements. Messages about government decisions on gypsum boards are

also briefly written on it. Not everything is written in detail here, but the traditions of written journalism are highlighted: that is, “nothing has been said to the government about the facts”. It was not until the 15th century that gypsum boards began to be replaced by lightweight, convenient, and fast-replicating paper sheets [1, pp. 428-429].

## THE MAIN FINDINGS AND RESULTS

It follows that there is a view that the first appearances of journalistic content informing people first appeared in the form of text before the fifteenth century. The texts in them are also simple and created from the point of view of the authorities. The first appearances of the diary occurred even before antiquity. But they were not recognized as a newspaper.

While the first buds of journalism were written on plaster tablets issued by the Roman Emperor Julius Caesar in the first century BC, the Capital News, which later appeared in China in the eighth century, was recognized as its first stage. The invention of the printing press by Johann Guttenberg of Germany in the mid-16th century was the second stage in the development of world journalism. By this time, the structure and level of the texts had begun to change [2, p. 7]. They were dominated by the informative function of more text.

The development of the press has made newspapers a lucrative business. The press, which was published under the domination of individual journalism in the world, called this period authoritarian. As a result of the revolutionary events of the seventeenth and eighteenth centuries, monopoly power in a number of countries was abolished and replaced by new and more advanced regimes. This fourth stage paved the way for the formation of social opinion, along with the transformation of economic interest into journalism [2, p. 7]. It can be said that the peculiarities of the period in which social opinion was formed were reflected in the textual form of journalistic content in the press.

There are different views on the origin and scientific study of the journalistic text. In particular, some scholars link its emergence to the creation of the alphabet [1, pp. 428-435]. They say that if the alphabet had not been created, people would not have been able to successfully exchange information with each other. It is also emphasized that the invention of paper, paint and technical equipment has a special significance and place in the formation of the journalistic text.

Commenting on the requirements for a journalistic text, American journalist Lauren Kessler writes: “The three rules of the text are clarity, brevity and fluency. First of all, the creator must ensure that the text he creates is understandable to the reader (audience). Each artist achieves a clear, fluent and understandable text through a unique word choice style. The right choice will help to fulfill these three requirements. There can be no ambiguity, unnecessary sentences, and inaccuracies in the written speech in the pamphlet. To achieve a clear goal, the artist must work on himself, practice, be diligent and have a deep knowledge of grammar. It is clear that a journalistic text must first be understandable to the audience with its accuracy and fluency. A journalist creates this content with his skill and literacy.

When it comes to a journalistic text, it is important to focus on form and content. Because the growth dynamics of the text did not go unnoticed in its form and genre characteristics.

“The word “genre” means “type” in French”. Genres are a stable form of journalistic work. They are necessary for the journalist to choose the look that suits his material, to show the events in a certain way, if necessary, to know what information is offered to him, depending on the nature of the genre. If it is news, then the essence of the event is given first, then the details are written. In the report, the journalist, as a witness to the event, also allows the viewer to become a participant in it [2, p. 356].

In Russian journalism, the genre is seen as a sign of identity. According to the Russian scientist G. Lazutina, the genre is a concept of the theory of creativity, expressing the peculiarities of a particular type of creativity. That’s why he always defines this type of creation by his name [3].

According to him, the “National Encyclopedia of Uzbekistan” contains only information about the genres of literature, fine arts and music. There is no mention of publicists or journalism [4, p. 14]. The Annotated Dictionary of the Uzbek Language also describes the genre based on the nature of works of art. For example, “GENRE (fr. Genre - gender, species) is a type of work of art that has its own characteristics in terms of plot and style. *Lyric genre. Humorous genre. Song genre* and etc.” [5, pp. 553-554].

By the end of the twentieth century and the beginning of the twenty-first century, with the rapid penetration of the Internet into our lives, the function and content of the text, which is the basis of journalistic material, has expanded dramatically. Now the term content is being applied to it.

Journalistic content is the structure of information in the media, which expresses certain content in the coverage of events in social life. It provides for the authors to reflect the real reality in a specific way (analysis-based criticism), regardless of what elements (facts and evidence, comments and interpretations), what means (picture, infographic, diagram, sound, image) are used. Also, the concept of “content” means multi-topic on the Internet, and even in specialized publications is divided into sub-topics [6, p. 23].

Traditional marketers have been using content effectively for many years to provide information about products and enhance the reputation of their product. Taking advantage of technological advances in transport and communications, business owners began to use marketing techniques in content creation by the end of the 19th century. From this point on, content acts as a bridge in their communication with their customers. In particular, in 1732, Benjamin Franklin published *The Almanac of Poor Richard* to promote his printing business [7, pp. 71-145].

In 1895, John Deere founded a publication dedicated to animal husbandry, in which he created content that taught farmers how to be more profitable. The publication is still available today, with an estimated 1.5 million copies in 12 languages in 40 countries [8].

During this period, the American company Kellogg began to produce sweet porridge, which has a positive effect on the physical development of children. The marketers of this company publish advertisements tailored to their audiences, thus laying the foundation for the concepts of target audience, target marketing. Also during this time, infographics also emerged as a means of promoting the brand and reminding the audience.

The term *content analysis* was first used in journalism in the late 19th and early 20th centuries by American journalists B. Matthew, A. Tenny, D. Speed, and D. Uipkins [9].

In the 1930s, U.S. sociologists used the method of content analysis in social research. Since that time, the term content has become an object of study in psychology and sociology. The reason is that the text is used as a method of identifying and evaluating the specific features of the media (such as video and radio broadcasts, interviews, answers to open-ended questions) to determine the character and relationships of the media. In psychology, the method of content analysis is used to obtain specific information from the answers given to several categories.

The object of the content analysis method is various printed publications, radio and television broadcasts, films, advertisements, documents, public speeches or questionnaires. This method was first used in journalism and literary criticism. Developed by American sociologists H. Lassuel and B. Berelson, this method was introduced into politics and propaganda in the 1930s. This method was especially useful in propaganda work during the Second World War.

If journalism initially served as an informant and auxiliary in the management of society, over time it can be seen that it has also become the object of marketing. Now journalism has begun to manifest itself through the influence on the minds of the people.

Since 1990, with the advent of computers and the Internet in our lives, a new era has begun for marketers: websites and blogs have flourished, and various companies have begun to communicate with their audiences via email. At the same time, traditional media such as newspapers, magazines, radio and television began to lose their market power. Internet content marketing has become the main form and tool of the information market. This can be seen when companies start advertising and selling their products digitally. The fact that this trend, which began with the advent of the Internet, has become much stronger today is evidenced by the fact that advertising is more effective on online platforms, social networks.

In the above facts and opinions, we have considered that content is the object of study not only in journalism but also in various other fields. Now let's talk about media content that is specific to journalism.

With the transformation of journalistic text into media content, the concept of genre has also begun to shrink. According to some researchers, the processes of media development, convergence and interactivity have not lost the importance of information, analytical and artistic-publicist genres in journalism. Due to the creative activity and mobility of journalists, journalistic creativity has adapted to the modern segment: with the development of convergent editions, newspapers and magazines, the content of the journalistic text and the professional activity of journalists creating it have changed in many ways.

In addition, the intensity of today's information flow and the demand for fast delivery of media products has also softened the concept of the genre. Because journalists, no matter what style and form, try to convey the information at hand quickly. For this reason, the concept of genre has become one of the most controversial topics in journalism. Given the integration of genres, some scholars' predictions that they will disappear over time are also not absent.

Candidate of Philological Sciences, Associate Professor Nazira Toshpulatova argues that with the disappearance of the genre, there should be a form in journalism. "From the outside, the form of the work seems to need no theory or definition. But since form has a certain appearance and meaning, it is a stable concept ..." [11, p. 24]. In his opinion, a journalist should think about what the work he is preparing will be, where to start, what information to bring to the forefront, how

to draw conclusions, how to cover a process or reality. Their arrangement itself emphasizes that it requires a certain form in relation to the text.

The concept of format has also been added to the concept of genre, which is developing on an equal footing with journalism. When it comes to genre, this issue has received little attention from theorists. But as the concepts of genre and format became mutually exclusive in the practice of journalism, controversial topics began to emerge. The format has dramatically expanded its scope of meaning and has begun to squeeze out other concepts, including genre.

They point to the development process of the computer as a simple reason for this process.

It should be noted that even though it has been a long time since the first buds of newspapers and journalistic texts appeared, debates over genre and text have been heated, and even modern views on the need to abandon the genre have prevailed in the national press; there were no striking changes in the form and style of the journalistic text. However, with the development of the media, the demand of the audience has also changed. As a result, the old, traditionally prepared journalistic material did not interest the readers. They want interesting information that can be quickly and easily assimilated. This has highlighted how relevant and important multimedia is.

According to Nazira Toshpulatova, Candidate of Philological Sciences, Associate Professor, digital technologies and audiovisual media are multimedia in the structure of the media. Using its capabilities, media texts are becoming an important trend in the preparation of interesting, vital and lively events (using pictures, videos, audio texts) of life events, in accordance with the level of acceptance of the audience. In such conditions, the development of creative potential of journalists, the improvement of their professional skills, the formation of the ability to prepare journalistic material is one of the most pressing issues in the science of journalism [12, p. 107].

Some research also mentions the emotions that media content evokes. Observers say media content varies by nature. However, in this sense, topics such as individualized violence have a special place in terms of the level of impact.

For example, the constant display of police serials, crime scenes, bloody scenes, and detective material can lead to aggression and, worst of all, a sense of violence in the audience. That's why modern journalists are required to know in advance how media will affect their audience in the process of creating content. Because the problem is manifested in the one-sided interpretation of reality, and in parallel, young people indulge in virtual war games, genocide-based entertainment, blockbusters, commercials, and so on. What we have listed exacerbates the occurrence of violence and aggressive behavior in young people. The reason is that they conclude that violence is the only right way and means to find a solution to conflict situations under the influence of such media texts. Therefore, for example, journalists who make a documentary about a tragic event or a conflict between states will have to choose the middle ground and show both the situation of the victims and the aspirations of those who are trying to resolve the conflict peacefully [13, pp. 24-25].

In fact, people watch TV together, chat with friends in chat, play interactive games with each other, and even go to the movies is a team event. And when there are no others around, we usually turn to the media. Through the media, people's sense of unity is strengthened. And conversely, the overall media experience can also cause problems. Interests, friends, styles and



aspirations bring us closer to people with similar passions; at the same time, media choice differentiates us from people who consume media content of a completely different content and category. The Internet has changed the way we participate in media use. In the world of the Internet and games, young people are actively leading. The virtual, interactive world is more likely to be more efficient than traditional media [14, p. 366].

Therefore, the journalist must take into account that the audience consists of different layers. The audience is made up of people of different ages, groups, strata, genders, and accordingly their interests are different. A journalist who creates media content should use the same, understandable methods of expression. It should be borne in mind that the modern audience is busy and needs a lot of speed. It is also a constant requirement to pay attention to the grammatical correctness of the text.

While the content of media content is one side, another important aspect of it is the issue of conveying this information to the audience through multimedia tools. This is because the convergence processes in the media and the integration of genres remain a topical issue in the era. Although most scientific studies acknowledge the convergence of all aspects of the media in the process of media convergence, some scholars disagree. This has also had an impact on media content creation approaches.

In particular, in the components of the media system, for example, in the press, radio, television, the Internet, in the process of delivering material to the audience in the same editorial office can be a combination of different methods, but not their form. There is no process of merging the forms of means such as text (newspapers and magazines), visual (television), audio (radio) and interactive hypertext (internet), on the contrary, the process of their separation is intensifying. That is why the newspaper's website is based on the principle of "one edition - two editions". Although one person works in the "two editions" [15, p. 15].

The opinion of most researchers also confirms that today's trends, along with the forms of information transmission, have also changed the information-consuming society, i.e. the audience. Now the members of the society not only receive information through the media, but also directly participate in this process. This is changing the nature and functions of modern journalism [16, p. 108].

As mentioned above, today the audience's influence on media content is growing. Through interactivity, they are not only communicated, but groups within the audience interact with each other. Today's audience not only has the opportunity to express their views on journalistic material, but also to independently create content (text, audio, video) and send it to the media site. Proof of this can be seen in the fact that content created by information consumers on sites is given a wide space.

Russian scientist Ekaterina Baranova described the unique values of media content in a cooperative way in her research.

Old content values	New content values
Content is created based on the personal factor of news selection	Content is created according to the wishes of the audience

Content is created by professional journalists	The influence of users on media content is growing, and the medical content prepared by them plays a key role
The latest news will be published in newspapers and audiovisual in the media	The latest news will appear in digital media, appearing on social networking pages. Takes on a more multimedia tone.
Public content aimed at a general audience	Specialized content aimed at certain groups in the audience
Plenty of political news and information in content intended for the public	Leading by regional and local data that serves the interests of a narrow audience
Distribution of media content through newspapers, radio and TV	Transfer of media content through various media platforms (Internet media, various mobile versions, etc.)
A business model based primarily on the number of advertisements and circulation	Cross-media advertising is a business model based on the use of crowdsourcing resources by the number of subscribers [17, p. 29]

## CONCLUSION

On the Internet, too, the content is presented in a concise, concise and interesting style, compared to printed publications, enriched with multimedia and presented quickly. The audience prefers websites and messengers, first of all, because they provide fast information, and secondly, because they are interesting and easy to digest, and because they use the Internet mainly through mobile phones, that is, they receive information over the phone.

These two situations have created a huge gap between print media and the audience. To remove it, every convergent editor must first fully understand what the media convergence process is and its modern requirements. In addition, the media needs to present content in line with changes and new trends in its creation and transmission. That is, they should treat their media content as a product on the counter.

## REFERENCES

- [1] Mo'minov F. (2019). *Pre-journalism views in antiquity. Theory, history and development of journalism*. – Tashkent: “Uzbekistan”. – pp. 428-429.
- [2] Kozokboev T., Khudoykulov M. (2018). *Introduction to Journalism*. – Tashkent: "Economics and Finance". – p. 7.
- [3] G.V. Lazutina. *Genre and format in the terminology of modern journalism. Moscow University Bulletin Series* 10. 2010.
- [4] Saidov H. (2019). *Information genres in journalism. Genres and Skills Issues in Print Media*, Vol. “Uzbekistan”. – Tashkent: – p. 14.
- [5] *Annotated dictionary of the Uzbek language: more than 8000 words and phrases*. J.P.E-M / Tarir Board: T.Mirzaev (leader) and others; Institute of Language and Literature of the Academy

of Sciences of the Republic of Uzbekistan. – Tashkent: “National Encyclopedia of Uzbekistan” State Scientific Publishing House, 2002. - pp. 553-554.

[6] Muratova N. (2019). *Online journalism: theory and practice*. – Tashkent: “Qaqnus media”. – p. 23.

[7] Claudia Hilker. (2017). *Content-Marketing-Strategien // Content Marketing in der Praxis*. — Wiesbaden: Springer Fachmedien Wiesbaden. — pp. 71–145.

[8] Smythe, Brig. Michael, (born 30 April 1948), *Clerk to the Vintners' Company, 1997–2012 // Who's Who*. — Oxford University Press, 2007-12-01.

[9] <https://psyfactor.org/>

[10] <https://www.examen.ru/>

[11] QurbonN. (2019). *Analyticaljournalism. Studyguide*. - Tashkent “Bayoz”, 2019. – p. 24.

[12] Toshpolatova N. (2019). *Commentary and skill*. Genres and Skills Issues in Print Media, Vol. "Uzbekistan". – Tashkent: – p. 107.

[13] Mamatova Ya., Sulaymonova S. (2015). *Uzbekistan on the path of media education development*. – Tashkent: “Extremum-press”. – pp. 24-25.

[14] Nurmatov A. (2019). *Commentary and skill*. Genres and Skills Issues in Print Media, 5 vols. "Uzbekistan". – Tashkent: – p. 366.

[15] Nurmatov A. (2020). *The phenomenon of convergence in journalism*. Proceedings of the Republican scientific-practical conference “Problems of modern print media: international and national experience”. – Tashkent: – p. 15.

[16] Toshpolatova N. (2019). *Commentary and skill*. Genres and Skills Issues in Print Media, Vol. "Uzbekistan". – Tashkent: – p. 108.

[17] Baranova E.A. (2018). *Media convergence as a system-forming factor in the transformation of the media institute*. – Moscow: – p. 29.

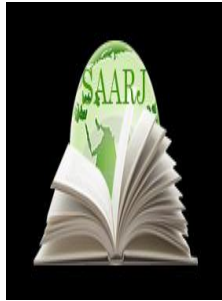

**ACADEMICIA**  
**An International  
 Multidisciplinary  
 Research Journal**  
 (Double Blind Refereed & Peer Reviewed Journal)



**DOI: 10.5958/2249-7137.2021.01124.1**

**IN THE SYSTEM OF PROFESSIONAL QUALIFICATION OF A  
 MILITARY PEDAGOGUE - PSYCHOLOGICAL PROTECTION**

**Sukhrob Rustamjonovich Sadriddinov\***

\*Department of educational and psychological support of service activities,  
 University of Public Security of the Republic of UZBEKISTAN  
 Email id: Suxrob15155@mail.ru

**ABSTRACT**

*Psychological protection is a condition for psychological discomfort of a person and is divided into basic and acquired psychological protection types. Psychological protection is a form of behavior that defines the essence of the subject's psychological culture and life experience. Theoretical psychological protection is divided into two types: basic psychological protection and acquired (secondary) psychological protection. The main objective of psychological protection is to eliminate psychological discomfort expressed in a person. It can be constructively or destructively described.*

**KEYWORDS:** *Maturity, Physical Perfection, Spiritual Maturity, Psychological Maturity, Psychological Protection, Gender Distinction, Cognitive Behavior, Psychological Discomfort, Need, Experience, Situation, Coping Behavior.*

**INTRODUCTION**

There are protections that can be applied by a person in maintaining public order and in a situation of conflict. The inspector of prevention should understand these psychological protections when working with people.

Mechanisms of protection by the person can be constructive (reasonable) or descriptive (unreasonable).

In the process of entering into a relationship, there is a need to protect against stress (tension), conflict (conflict).

On Ontogenesis, each person uses the individual technology to perceive, process, and transmit information by means of the sensory organs, to make it into a cognitive or multidimensional knowledge. This process is automated, becoming individual cognitive. Cognitive style, also

expressed in the dynamics of individual consciousness and unconsciousness, appears in the form of a psychological complex in the form of self-assessment in the form of "I" and "I am-not" in the form of an attitude of the environment, self-awareness. According to the expression, consciousness is divided into social, political, legal, ethical, artistic, religious, ecological types. For example, ethical consciousness is the type of consciousness that is well-known in the community of people, that is, the good and evil, the white and the black. Ethical consciousness regulates relationships in norms, traditions, traditions, procedures, and guiding styles in different activities. Artistic consciousness reveals the social existence and its beauty. An important aspect of artistic consciousness is art, and it is manifested in the cultures of culture, perception, and culture of self-expression, which provides the individual with the ability to cultivate, cultivate and harmonize cultural attributes.

Psychological protection may be the cause of social disarray as a result of a combination of elements in the psychological protection mechanism, with the aim of ensuring the adaptation of the spiritual world to the social environment in terms of its functionality, psychological protection, complicated structure, and manifested in the behavior patterns of a person in a simple and superior order. Theoretical psychological protection is divided into two types: basic psychological protection and acquired (secondary) psychological protection. The main objective of psychological protection is to eliminate psychological discomfort expressed in a person. It can be constructively or destructively described. In our opinion, the constructive expression of psychological protection is based on a person's psychological culture and experience. At the same time, the protection is broken down into simple and high-ranking ones, and their connecting point is to eliminate the psychological discomfort that arose.

Psychological protection is divided into aggressive and positive forms of expression, which includes the protection of emotions, needs and interests from internal and external threats. Psychological protection at individual level means a special regulated system that minimizes the impact of internal and external threats, balancing current psychological state, providing psychological stability. "Tahdid" is derived from Arabic, which means "intimidation", "hurry". In this context there are internal threats, anxiety, fear, negative emotions, personal incompetence, and so on. External threats include various forms of discrimination, neglect of individual values, open aggression, and so on.

In the psychology dictionary, psychological protection has been shown to be a quality that changes the system of interpersonal relationships, in a broader sense, the emergence of a negation, a "lie" created to eliminate discomfort, and the different attitudes that appear in the form of changing behavior. In our view, the main task of psychological protection is to provide the person with the ability to "absorb" the level of consciousness of the person from the negative, ie psychological traumatic information. The right mind is expressed in intellectual activity of a person and, with perception of new impressions, his experiences, emotional assessment of the current situation, reflect the world. Consciousness, the subjective image of the world, the essence of the subject, ie the venue of the subject, is a manifestation of the existence of the "beginning" of man. Task of the consciousness is to eliminate conflicts (dislikes). It is understood that in the consciousness of the person others and his place existence is reflected. The surrounding area is clearly perceived. A person's subjective life is connected with a world of perceiving and consciousness, and he / she can perceive the nature of dangers and threats, the dynamics of social relationships, and distinguish safe and destructive points. It is the mind of the individual that he

seeks ways to get rid of the dangers and threats. In this process, consciousness is a form of self-consciousness, and social consciousness is functional to distinguish risk from the point of view of its functionality.

On Ontogenesis, each person uses the individual technology to perceive, process, and transmit information by means of the sensory organs, to make it into a cognitive or multidimensional knowledge. This process is automated, becoming individual cognitive style. Cognitive style, also expressed in the dynamics of individual consciousness and unconsciousness, appears in the form of a psychological complex in the form of self-assessment in the form of "I" and "I am-not" in the form of an attitude of the environment, self-awareness. According to the expression, consciousness is divided into social, political, legal, ethical, artistic, religious, ecological types. For example, ethical consciousness is the type of consciousness that is well-known in the community of people, that is, the good and evil, the white and the black. Ethical consciousness regulates relationships in norms, traditions, traditions, procedures, and guiding styles in different activities. Artistic consciousness reveals the social existence and its beauty. An important aspect of artistic consciousness is art, and it is manifested in the cultures of culture, perception, and culture of self-expression, which provides the individual with the ability to cultivate, cultivate and harmonize cultural attributes. Consequently, constructive psychological protection defines the essence of events and processes that are of cultural importance. D. Dotsenko knows that "the main aspect of psychological protection isto ensure that the person does not get introduced". The introduction is a testimony given by the views, motives and other ideas created within the person's internal world (in the subject of psychology, the concept of prism is used). Because external reasons are based on the foundations of internal conditions, academician S.Rubinstein states that "external influences give rise as one or another psychic result."

Pedagogical activity is a type of work that has a high social cultural significance. Because any existing profession (sector) is a result of pedagogical activity. Teachers, law enforcement officers, military personnel, economists and lawyers, engineers and programmers, artistic professionals (painters, sculptors, writers, composers, etc.), even professions which are acquired in a short period of time (hairdressers, stylists, etc.) is a successful outcome of pedagogical work. Therefore, in the professionalism (by Klimov) system, the pedagogical activity relates to the working group "Subject"–"Subject". Pedagogical work differs from other types of activities with high stressogenicity. If we choose successful pedagogical activities as educated professions, the pedagogue will not only provide information, but also educate students about the world outlook, the positive "I" and the self-expression. In this process, each subject will have to take account of his individuality. If we study this process in a systematic way, we need to demonstrate a constructive internal and constructive external psychological protection of the teacher to succeed. Considering that Russian physician, Doctor of Medical Sciences V.Delaryu, is used to describe "the concept of psychological protection, psychological discomfort". At the same time, psychological protection is a basic component (component) of pedagogue's component, more precisely psychological component, and is a basic basis for successful professional activity. Therefore, the concept of psychological protection can be regarded as a complex of processes and mechanisms for protecting the subject from negative influences. Although Belorussian scientist A.Krot expressed his attitude, "Psychological protection is a means to eliminate conflicts between mind, ignorance and reality," the author seems to have ignored the existence of a type of internal and external psychological protection. Theoretically, psychological protection

is distinguished for its purpose in terms of its internal and external psychological protection. The purpose of internal psychological protection is to maintain the internal stability of the subject and to ensure a positive state. The goal of external psychological protection is to maintain a social norm and acceptable social distance from the subject of the relationship between the "Subject" and the "Subject" – "I" and the "I" - to ensure the positive position of the subject. In this way, a stable positive psychological state is provided.

As a subject of psychological protection, the subject can be selected as motivational (desire, motivation) and cognitive (outlook, attitudes) and patterns of behavior (manifestation, ability, behavior, or manner of behavior), contrary to psychological protection. On the one hand, it helps the inner person, that is, to adapt the "spiritual I" to the "physical I", and, on the other hand, affects the human being with the outside world. That's why the mechanism of psychological protection is being studied on the basis of various scientific doctrines. Russian scientists R. Granovskaya and I. Nikolskaya, studying the expression of psychological protection in children, have pointed out to the psychological protection mechanism that "understanding the intrapsychical adaptation of the perceived level of personality perception of the information being perceived by the person." In Maturity psychology, It is well-known from "The psychological laws of the younger stages of maternity" that in complex operations, all psychological processes take place with all their functions. That is, emotion, thinking, imagination, attention, memory and perception are the "creator" of psychological protection. Therefore, when detecting psychological traumatic or psychological well-being, the protection mechanism acts as a filter. As a result, disruptive information is denied, negative aspects are reversed or replaced with optimal information type. In this way, the spiritual state is conditioned by the specific type of social adaptation. Analysis of scientific sources shows that there is no single model of psychological protection mechanism and is individually expressed in each subject. In our opinion, this will be conditioned by the specific factors such as ethnomadiality, social maturity, experience of the subject, satisfaction of needs, culture, and type of higher nervous system. Because it is a psychological self-defense behavior. Therefore, someone with a psychological defense is weak, one is strongly exposed. The poor psychological protection does not have the ability to fully protect the subject's mind from the discouraging information. Stronger psychological protection can protect the mind by "cleansing" (filtering) any information that is susceptible to the subconscious. V. Dolgova and O. Kondratieva noted that in this context, "it is necessary to distinguish between normal psychological protection and pathological psychological protection (in assessing the psychological protection model - S.S.)". When normal psychological protection fulfills a prophylactic function, the pathological psychiatric disorder causes disintegration. Therefore, there are various samples of the classification of the psychological protection mechanism. As one of the first in psychology, A. Freud performed his classification and showed psychological protection as a threat to the "I" and the occurrence of ontogenesis. A. According to Freud, the norm of maturation depends on the process and direction of the protection. Theoretical and Comparative Analysis shows that A. Freud's recommended psychological protection mechanism was theoretical basis for modern classifications of psychological protection mechanisms, such as primary and secondary, primitive and advanced, adaptive and non-adaptive, adequate and inexpedient, effective and disadvantaged.

P.Cramer studied the ontogenesis of psychological protection and divided them into types of psychological protection, primitive (normal) and higher. Primitive psychological protection (denier, compression, regression, swap) has been demonstrated by the use of motor and sensor mechanisms to monitor the use of the child in conflict situations to ease the emotional state. Social development norms and behaviors are largely dependent on the expression of higher psychological protection and are expressed in the management of conflict situations.

A.Freud refused to perform the logical classification of the psychological protection mechanism, showing ten types of protection (compression, regression, reactive formation, isolation, projection, injection, self-defeating, transference, and sublimation). In his opinion, except for the sublimation of the psychological protection mechanism, play a negative role for a mentally healthy person. The use of a psychological protection mechanism can not eliminate the conflict, the state of fear remains, and ultimately, the outcome of the disease remains high.

According to L.Grebennikov, "psychological protection mechanisms are, by nature, unreasonable and should not be left to their senses".

A psychologically healthy person defines and protects his / her defenses in the process of perfection. It develops the mechanism of psychological protection and recognizes automatic protection beforehand. The definition defines the essence of psychological protection. Thus, reflexive control of psychological protection is a prerequisite for the transition to constructive protection of the destructive psychological protection mechanism. A. Nalchadjyan treats three types of socio-psychological adaptation as normal, deviant and pathologic, and "psychological protection mechanism ensures the socio-psychological adaptation of individual". This, in turn, suggests that adaptation is normative, if used in the context of a psychological trauma, with a normal psychological protection mechanism. That is, in the context of the requirements of the norms of the society, behavior patterns and attitudes are expressed in definite patterns. M. Mkrtychyan, who learned how to manifest a psychological protection mechanism in the situation of frustration, says that "in this case, not only the individual, but also one of the leading, role-playing, systematizing roles in regulating and responding to the situation as a response to the situation." such as. The author's attitude, in turn, indicates that the expression of the defense complex influences the person's experience, values, attitudes (rules). Effective psychological protection eliminates the conflict without the frustrator's passive protection, and eliminates the conflict.

The psychological protection mechanism is related to the age-related development of a person and the relevance of cognitive processes, R.Plutchic's classification of psychological protection is based on criteria such as primitive maturity. Ontogenetically, the first is the protection that comes from perceptive processes (intuition, attention, perception). R.Plutchik has denied this group, has made projection, regressions, and similarities. The people who use them are distinguished by their emotional and inaccessibility. Subsequently, memory-based protection types such as squeezing and forgetting occur. Practicing these protection mechanisms is based on the memory of information. Relatively complex types of protection is replacement, compensation and rationalization. They are shaped by the development of imagination and thinking and provide information processing and re-evaluation. Based on the analysis of the sources learned, the functional level of analysis can be summarized as a functional description of basic psychological protection mechanisms (Table 1). Denial is an ontogenetically first-described and simple defense mechanism that acts as a cleansing tool for perceptions. At the same time, unacceptable



information is not perceived. The adaptation of these categories is passive, constructive. However, the projection is characterized by some special complexity. It keeps the person in touch with people around him and his / her negative attitudes and observes the existence of negative attitudes in people around him, and then sees the reason for not accepting them.

On the base, on the content of the projection, the projection is divided into attributive, rationalistic, complimentary, symyalable, and the psychological protection mechanism is characteristic of the types of individuals active in social adaptation. In this category of people, low constructivity is observed.

Regressions, in order to avoid fear of self-doubt and failure, return to a feeling of relative perfection and satisfaction. This protection mechanism is characterized by an active adaptive level of clarity and low level of constructiveness.

In order to avoid anger, subjugation goes down from the tension to the relatively weak living or lifeless object, sometimes in the nervous position. There are two types of things, such as changing the subject and changing the need. The swap has active and passive forms, used by those of different types, and their constructiveness is moderately expressed.

Compression is used to preserve the feel of the fear, and is used in unusual cases for positive perception. The real stimulus and all the related objects and factors are collapsed, resulting in fear. The level of adaptability is used by those who are passive, and the degree of constructiveness is typically expressed moderately.

Rationalization relates to the relief from frustrations that emerged from the early years of adulthood and the aggression of peers. In any case, the level of adaptiveness was passive, simplifying the exercise of subjective control

Compensation is an ontogenetically last protection type and has a complex cognitive structure. It is used for the protection of painful feelings and is used by different types of people, with a high level of adactivity.

Hypercompensation is applied at the ideal level of compensation and can be used by all audiences regardless of individuality, and the level of constructiveness is high.

Special mechanisms of psychological protection are the basis of interpersonal psychological protection in the form of basic protection. For the first time E. Dotsenko, later G. Grachev, V.Shtroo and others have studied psychologically, interpreting the psychological protection of interpersonal relationships as follows:

1. Adequate - compliance of the psychological protection with the cause of the threat;
2. Effective - the aim of psychological protection is to eliminate the risks;
3. peculiarity - the content and essence of the psychological protection used in the particular case;
4. Provision of constructive and psychological protection to ensure maturation, positive stability in relations.

#### **Individual Criteria:**

1. flexibility of psychological protection (not to use only one or two psychological mechanisms);

2. Optimal application of the psychological protection mechanism.

**Criteria:**

1. To have a well-grounded understanding of behaviors and actions in applying the psychological protection mechanism;
2. non-protection against adaptive actions;
3. abandoning psychological protection to alleviate the situation.

Thus, the expression of the psychological protection mechanism depends on the availability of resources and the sources of psychological protection are: cognitive block, confidence in diverse areas: professional, intellectual, household problems, relationships with close people, internal locus control;

The emotional block is characterized by the identification of the identity,

The behavioral block is expressed in the use of effective coping strategies.

Based on the analysis of scientific sources on the study of the mechanism of psychological protection and psychological protection, the mechanism of psychological protection can be described as follows:

**first of all**, can be constructive and destructive in terms of expression of the psychological protection mechanism. The essence of the mechanism of psychological protection defines the individual's social maturity, experience and psychological literacy;

**Secondly**, the mechanism of psychological protection has individual meaning and protects the mind from psychological traumatic information and ensures moral and psychological stability;

**Thirdly**, the use of the constructive psychological protection mechanism is used at the level of awareness, is controlled by rhexese and provides psychological and social adaptation of the psychological state to the real environment;

**Fourthly**, it implements the functions of psychological protection, such as enjoying the individual's social and personal life, protection from external psychological discomfort and interpersonal relationships from external psychological influences.

**REFERENCES:**

1. Granovskaya R. M. Aktualnost issledovaniya psihologicheskoy zashchity // Vestnik Baltiyskoy akademii. 1998. Vyp. 18. - S. 47-51.
2. Dotsenko E. L. Psychology manipulation: phenomena, mechanics and zashchita. - M.: Rech, 2004. - S. 104.
3. Kirshbaum E. I., Eremeeva A. I. Psihologicheskoy zashchita. - M.: Smysl, 2000. - S. 81.
4. Psychology. Slovar / Pod red. Petrovskogo A.V., Yaroshevskogo M.G. - M.: Politizdat, 1990. - S. 121.
5. Rubinstein S. L. Bytie i soznanie. - M.: Academia nauk, 1957. - S.231.
6. Samarov R., Sadriddinov S. Psychological Assistance: Scientific Problems and Approaches // Socio-humanitarian sciences in education system. 2014, 3rd issue. Pages 74-80.

7. Slovar inostrannyx slov (Okolo 10 000 Slov). - SPb. OOO Victoria plyus. 2010. - S.248.
8. System analysis: theory and practice (in the case of pedagogical activity) / Monograph, Samarov R. and so on. - Tashkent: Literature sparks, 2017. - 14 - 15 pages.
9. Tulupeva T.V. Психологическая защита и особенности личности в роуны ранне Юнтусы. - SPb .: SPbGU, 2000. - S. 72-78.
10. Dotsenko E.L. Psychology manipulation: phenomena, mechanics and zashchita. - SPb: Rech, 2004. - 304 p.
11. Grachev G.V. Информационно-психологическая безопасность личности // Dis. ... doctor psychologist. nauk - M., - 456 h.

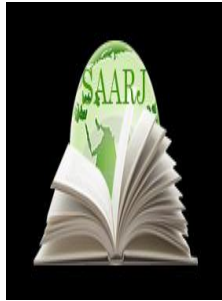

**ACADEMICIA**  
**An International**  
**Multidisciplinary**  
**Research Journal**  
 (Double Blind Refereed & Peer Reviewed Journal)



**DOI: 10.5958/2249-7137.2021.01125.3**

**REVIEW OF ABDULLA KADIRI'S POETICS IN THE NOVEL "DAYS GONE BY" IN RUSSIAN TRANSLATIONS**

**Tulkin Khayriddinovich Saydaliev\***; **Elmirza Temirovich Erkaev\*\***;  
**Dilshod Mamadiyarovich Djuraev\*\*\***; **Islombek Khasanboy ugli Khasanov\*\*\*\***

\*Associate Professor,  
 Candidate of Philological Sciences,  
 Military Technical Institute of the National Guard,  
 Republic of UZBEKISTAN

\*\*Senior Lecturer,  
 Candidate of Pedagogical Sciences,  
 Military Technical Institute of the National Guard,  
 Republic of UZBEKISTAN

\*\*\*Doctor of Philosophy in Pedagogical Sciences (PhD),  
 Military Technical Institute of the National Guard,  
 Republic of UZBEKISTAN

\*\*\*\*Teacher,  
 Military Technical Institute of the National Guard,  
 Republic of UZBEKISTAN

**ABSTRACT**

*It is no exaggeration to say that Abdullah Kadiri is a master of magic words, an incomparable creator of Uzbek literature in the field of artistic mastery. It is natural that this event will be of interest to other representatives of the literature. Therefore, representatives of other languages made a serious effort to translate this work into their own language. The novel was first translated into Russian and then into other languages. It is natural that the translators (L.Bat, V.Smironova and M.Safarov) who translated the work into Russian were able to use the novel's art to some extent.*

**KEYWORDS:** *Novel, Artistry, Translator, Adequate Translation, Original, Retranslation, Classic Literature, Historic Novel, Free Translation.*

## INTRODUCTION

### THE MAIN FINDINGS AND RESEARCH

Frankly, the novel “Days Gone By” is a work that has revolutionized world literature in general. Unlike the French, English, German, Russian and Spanish novel schools, he is one of the founders of the Uzbek school of novels. That's probably why the novel attracted so much attention as it saw the face of the world. But because of the dictatorial regime, the work was repressed like the author. First, the author was physically exterminated on October 4, 1938, and then the book was also banned. Therefore, the work was translated into Russian only in the late fifties of last century. These translations were made by Russian translators Lydia Bat and Vera Smirnova based on literal translation. It should be noted that the book was based on the edition with certain abbreviations. It is true that in 1956, despite the fact that Abdullah Kadiri was justified as a person and a creator, the ideological pressure of the dictatorial regime was still very strong. Sarvar Azimov, a well-known Uzbek writer and secretary of the Writers' Union at the time, deliberately shortened the section on freedom, liberty and nationalism, explaining: “In any case, the work must be published and returned to the people.” As I said above, the dictatorial system strictly controlled the work and could not have been otherwise. Some of our own writers were generally opposed to reprinting the novel. In fact, we grew up reading this abbreviated version of “Days Gone By.” But there seemed to be some flaws in the play. Russian translators, in turn, unknowingly translated the work on the basis of direct word-for-word translation. This process took place in the second half of the twentieth century, and in the new century Muhammadnodir Safarov, a translator who knew the original language, translated the work into Russian. The article compares these translations with the original language and analyzes the advantages and disadvantages. As the author draws the heroes of the work, he shows them before our eyes with special affection. When you read the work, you feel as if you have seen the heroes. Abdullah Kadiri's artistic skills are also embodied in this. Here is a description of Yusufbek Haji, the father of Azizbek, the governor of Tashkent, and his adviser Otabek, in the chapter "A young man worthy of a khan's daughter":

**Original:** “...Azizbekning Turkiston xonlig'ining eng zolim va mustabid sanalg'an beklarining biri va uning o'z qaramog'ida bo'lg'an Toshkand aholisiga qilg'an zulmlari Farg'onaga doston, ammo Akram hojining bu savoli Azizbekning eng yaqini bo'lg'an bir kishining o'g'lini sinab ko'rishlik uchun edi. Bu sinash natijasi Akram hojining taajubini ortdirdi va buning sirrini bilishka qiziqsindi:

- Otangiz Azizbekning mushoviri ekan, - dedi Akram hoji, - nima uchun uni bir oz bo'lsa ham yo'lg'a solmaydir? ”

- Kechiringiz amak, - deb Otabek kulimsiradi, - siz otamning mushovirlig'ini boshkacharak onglag'ang'a o'xshadingiz... Bizning beklarga hukm vaqtida ham mushovir bo'lmoq imkonsiz narsadir. Otam Azizbekning mushoviri va yaqini musohibi sanalsa xam lekin bu juz'iy ishlardagindadir, buning uchun sizga bir misol keltiray, bu ish shu yaqin oralardag'ina bo'ldi: Toshkanddagi jum'alik gap majlislaridan birida bir kishi Azizbekni maxtar va bu maxtovga qarshi ikkinchisi “nega muncha maxtaysan, Azizbekning, asli bir bachcha-da” der. Ularning bu muzokaralarini chetda eshitib turgan huftyalardan biri bu so'zni Azizbekning qulog'iga yetkuzar. Ertasiga Azizbek mazkur ikki kishini o'z huzuriga oldirib maxtovchig'a ulug' mansab ato qilar va ikkinchisini o'limga buyurar... Bu hukm majlisida hozir turgan otam mahkumning

*gunohini so'rag'anida Azizbek jallodga baqirar: "Tezroq olib chiq!" Otam tag'in qullik qilg'anida jallodga bakirar: "qo'lindag'ini bo'shatib, o'rniga hojini olib chiq" – Mana ko'rdingizmi, otamning qadru qiymatini... "[1, p. 15].*

**Original:** *"...Azizbek's cruelty to the people of Tashkent, one of the most tyrannical and tyrannical princes of the Turkestan khanate, and to the people of Tashkent under his control, is epic to Fergana, but Akram Haji's question was to test the son of Azizbek's closest friend. The result of this test increased Akram Haji's surprise and he was curious to know the secret:*

*- "Your father is Azizbek's adviser," – said Haji Akram, "why doesn't he guide him a little?"*

*- "I'm sorry, uncle," – said Atabek with a smile, "but you seem to have misunderstood my father's advice... It is impossible for our princes to be counselors even at the time of judgment. Although my father is considered Azizbek's adviser and close interlocutor, but this is only a minor matter, let me give you an example. This happened just recently: at one of the Friday speeches in Tashkent, one person praised Azizbek and the other one said, "Why are you praising him so much? In fact, Azizbek is just a kid." One of the secret agents, who overhears their talks, tells it to Azizbek. The next day, Azizbek calls the two men, gives one of them a prestigious job, and orders the other to be executed... When my father, who was present at the trial, asked about the convict's guilt, Azizbek shouted at the executioner: "Take him out as soon as possible!" When my father was enslaved again, he shouted at the executioner: "Release your hand and take the pilgrim instead." You can see my father's dignity..."*

**Translation by L. Bat:** *До Ферганы давно уже дошла молва о том, как тиранит Азизбек населения Ташкента. Он снискал себе славу самого жестокого деспота в Туркестанском ханстве. Акрам-хаджи нарочно задал этот вопрос Атабеку: он хотел испытать его. Интерес присутствующих к молодому гостю еще больше возрос.*

*- Ваш отец – советник Азизбека. Почему бы ему не наставить его на правильный путь?*

*Атабек улыбнулся.*

*- Простите, господин мой, вы, видно, не совсем ясно представляете себе положение моего отца. . . Наши беки, принимая важное решение, не слушают своих советников. Хотя Азизбек часто беседует с моим отцом и даже совещается с ним, но только по мелким незначительным поводам. Расскажу один случай, чтобы вам стало понятно. Недавно на какой-то пирушке один человек начал хвалить Азизбека, собеседник заспорил с ним: "Что ты его превозносишь ведь он просто бача". Тут же оказался доносчик, который поспешил довести эти слова до ушей Азизбека. На следующий день Азизбек вызвал к себе спорщиков. Тому, кто хвалил его, он дал высокую должность, другого же приказал казнить. Мой отец присутствовал при этом и попросил смягчить столь жестокое наказание. Тогда Азизбек крикнул палачу: "Веди быстрее" Отец снова начал просить, но Азизбек сказал еще решительнее: "Ах, так! Брось этого! И веди самого хаджи!" Вот как он считается с отцом! ... "[2, p. 35]*

**Translation by L. Bat:** *The rumor has long reached Fergana that Azizbek is tyrannizing the population of Tashkent. He earned himself the fame of the cruelest despot in the Turkestan Khanate. Akram-haji deliberately posed this question to Atabek: he wanted to test him. The interest in young man of those present grew even more*

- *“Your father is Azizbek’s advisor. Why doesn’t he guide him on the right path?”*

*Atabek smiled.*

- *“Forgive me, my lord, you do not seem to have a very clear idea of my father’s position... Our princes, making an important decision, do not listen to their advisers. Although Azizbek often talks with my father and even confers with him, but only on minor insignificant occasions. I will tell you one case to make it clear to you. Recently, at some revelry, one person began to praise Azizbek, the interlocutor argued with him: “Why do you extol him, because he’s just kid”. There appeared an informer who hastened to bring these words to Azizbek’s ears. The next day, Azizbek summoned the debaters. To the one who praised him, he gave a high position, while the other he ordered to be executed. My father was present at this and asked to mitigate such a cruel punishment. Then Azizbek shouted to the executioner: “Take him away faster!” Father again began asking, but Azizbek said even more resolutely: “Ah, so! Let him free! And take the Haji himself!” That’s show here reckons with his father!...”*

**Translation by M. Safarov:** *“...Азизбек снискал себе славу одного из самых злобных угнетателей – тиранов в туркестанских ханствах, о его жестокости к населению Ташкента в Фергане давно ходили легенды, однако же Акрам-хаджи, адресованный сыну наиболее приближённого к Азизбеку человека, был дан неспроста, а для проверки Атабека. Услышанное ещё более изумило Акрам-хаджи, и он не преминул проявить интерес к причине такого отношения:*

- *Раз ваш отец является советником Азизбека, - развивал мысль Акрам-хаджи, - отчего бы ему хоть изредка не наставлять бека на правильный путь?*

- *Прошу прощения уважаемый, - улыбнулся Атабек, - видимо, у вас нет достаточно ясного представления о должности моего отца... Исполнять роль советника при вынесении нашими беками какого-либо решения – есть задача невозможная. Хотя мой отец является советником Азизбека, да к тому же ещё ближайшим собеседником, однако прислушивается он к советам моего отца лишь по вопросам не имеющим особого значения. Позвольте, приведу вам один пример, имевший место совсем недавно: на одной из частных пятничных пирушек один человек начал восхвалять Азизбека, на что другой возразил: “И чего это ты расхваливаешь его? Азизбек всего лишь бача”. Эти слова были немедленно донесены до ушей Азизбека находившемся неподалёку тайным доносчиком. На следующий день Азизбек вызвал к себе этих двоих, восхвалявшему была дарована высокая должность, второй же приговорён к казни... Мой отец, присутствовавший при вынесении приговора, обратился к Азизбеку с просьбой разъяснить ему вину приговорённого, на что ответом был лишь окрик Азизбека, обращённый к палачу: “Выводи скорее!” А когда мой отец повторил свою просьбу, Азизбек “пошутил”: “Может быть заменить преступника на самого хаджи?” [3, p.16]*

**Translation by M. Safarov:** *“...Azizbek earned himself the fame of one of the most vicious oppressors - tyrants in the Turkestan khanates, there were legends about his cruelty to the population of Tashkent in Fergana, but Akram-haji, addressed to the son of the person closest to Azizbek, was given for a reason – to test Atabek. What he heard amazed Akram-haji even more, and he did not fail to show interest in the reason for this attitude:*

*“Since your father is Azizbek’s advisor,” Akram-hajji developed the thought, “why would he, at least from time to time, instruct the prince on the right path?”*

*- “I beg your pardon, dear,” - Atabek smiled, - “apparently, you do not have a clear enough idea of the position of my father...” To play the role of an adviser when our princes make any decision is an impossible task. Although my father is Azizbek’s advisor, and besides, he is also the closest interlocutor, but he listens to the advice of my father only on issues of little importance. Let me give you one example that took place quite recently: at one of the private Friday parties, one person began to praise Azizbek, to which another objected: “And why are you praising him? Azizbek is just a kid.” These words were immediately conveyed to Azizbek’s ears by a secret informant who was nearby. The next day, Azizbek summoned these two to him, the one who praised was given a high position, the second was sentenced to death ... My father, who was present at the sentencing, turned to Azizbek with a request to explain to him the guilt of the condemned man, to which Azizbek’s shout, addressed to the executioner, was only answered: “Get out soon! And when my father repeated his request, Azizbek “joked”: “Maybe replace the criminal with the hajji himself?”*

Analyzing this passage, we found that translators have chosen different paths in translating the passage. **Original:** *“... Azizbekning Turkiston xonlig’ining eng zolim va mustabid sanalg’an beklarining biri va uning o’z qaramog’ida bo’lg’an Toshkand aholisiga qilg’an zulmlari Farg’onaga doston, ammo Akram hojining bu savoli Azizbekning eng yaqini bo’lg’an bir kishining o’g’lini sinab ko’rishlik uchun edi. Bu sinash natijasi Akram hojining taajubini ortdirdi va buning sirrini bilishka qiziqsindi:...”* – *“... Azizbek’s cruelty to the people of Tashkent, one of the most tyrannical and tyrannical princes of the Turkestan khanate, and to the people of Tashkent under his control, is epic to Fergana, but Akram Haji’s question was to test the son of Azizbek’s closest friend. The result of this test increased Akram Haji’s astonishment and he was curious to know the secret: ...”* The first paragraph of the passage consists of 49 words, so how did the translators translate it into Russian. **Translation by L. Bat:** *“...До Ферганы давно уже дошла молва о том, как тиранит Азизбек населения Ташкента. Он снискал себе славу самого жестокого деспота в Туркестанском ханстве. Акрам-хаджи нарочно задал этот вопрос Атабеку: он хотел испытать его. Интерес присутствующих к молодому гостю еще больше возрос”...* - *“... The rumor has long reached Fergana that Azizbek is tyrannizing the population of Tashkent. He earned himself the fame of the cruelest despot in the Turkestan Khanate. Akram-haji deliberately asked this question to Atabek: he wanted to test him. The interest of those present in the young guest increased even more”...*

The Russian translator translated the paragraph using fewer words than the original language, only 42 words.

**Translation by M. Safarov:** *“...Азизбек снискал себе славу одного из самых злых угнетателей – тиранов в туркестанских ханствах, о его жестокости к населению Ташкента в Фергане давно ходили легенды, однако же вопрос Акрам-хаджи, адресованный сыну наиболее приближённого к Азизбеку человека, был дан неспроста, а для проверки Атабека. Услышанное ещё более изумило Акрам-хаджи, и он не преминул проявить интерес к причине такого отношения:”...*

**Translation by M. Safarov:** *“... Azizbek earned himself the fame of one of the most vicious oppressors - tyrants in the Turkestan khanates, legends have long circulated about his cruelty to*



*the population of Tashkent in Fergana, however, the question of Akram-haji, addressed to the son of the person closest to Azizbek, was given for a reason, and to check Atabek. Akram-haji was even more amazed by what he heard, and he did not fail to show interest in the reason for such an attitude: "...*

A translator who knows the original language translated this paragraph with 56 words. I think the translator who translated on the basis of the tag has had some success. However, Akrom replaced Haji's interest with the interest of the members of the assembly: "...*Интерес присутствующих к молодому гостю еще больше возрос*"... - "... *The interest of those present to the young guest has increased even more*" ...This is not the case in reality. The translator, who knew the original language, performed the translation while preserving the content of the paragraphs as much as possible, but the content remained under the pile of words. We must not forget that, as the Russian thinker F. M. Dostoevsky said: "In literary translation, one word should be superfluous and one word should not be less." [4, p. 75] Continuing my point, there are some shortcomings in Atabek's address to Haji Akram in the passage as well. For example, if the sentence is "*Kechiringiz amak...*" – "*Excuse me, uncle ...*" L. Bat translates as: "...*Простите, господин мой...*" - "... *Excuse me, my lord ...*", M. Safarov translates it as: "...*Прошу прощения уважаемый...*" - "... *I beg your pardon, dear ...*" Atabek is the son of a man of his own position in society; he never addresses his interlocutor as "*mening janobim*" – "*my lord.*" At this point, I think the second translation is more appropriate. The sentence at the end of this passage was mistranslated by both translators. Atabek says that his father has no dignity for Azizbek, but we do not see it in the translation: Original: "... *Mana ko'rdingizmi, otamning qadru qiymatini...*" - "... *See my father's dignity...*" **L. Bat translates it as:** "...*Вот как он считается с отцом! ...*" - "... *See how he reckons with my father!*" In Safarov's translation, this sentence does not exist at all. Such inconsistencies in the translation undermine the artistry of the work being translated. Circumstances that give aesthetic pleasure in the language of the original remain abstract to the Russian reader. The simple word "*mushovir*" – "*consultant*" has some meaning, and Abdullah Kadiri could easily be called a "*maslahatchi*" – "*advisor.*" But in Russian they gave it with the word "*советник*" (advisor). At the same time, translators must understand that the author uses the word in an archaic sense, giving it a national color and the spirit of the period. Speaking in Atabek's language, Abdullah Kadiri masterfully painted portraits of the heroes on small plates. We will see how cruel Azizbek is and how noble Yusufbek Haji is.

The place and role the development of the plot in the work, and the course of events is incomparable. At the end of our article we quote from a letter written by Kumush's mother to Oftoboyim:

**Original:** "...*O'tkan xatlarimda kundashim bilan mirosamiz kelishmay turganini kulguluk tarzida yozgan edim. Nafsilarimizda ersa, oramiz juda buzilg'an, men oshal vaqtlarda chin kundashlik to'nini kiygan edim. Zaynabning bitmas xusumati esa g'olibo manim ikki qatlig'im oshkor bo'lg'an kundan boshlandi. Sizning boshingizdan kundashlik savdosi o'tmagan bo'lsa ham tushunsangiz kerak: Biz ikav agar qo'yib bersalar guyo bir-birimizni yeb-ichmakchi edik... U kunlardagi holimdan o'zimga endi xisob berishka ham uyalaman... Yaxshiki, bizning mojarolardan qayin otam juda siyrak xabardor bo'ldi. Shundog' xam bo'lsa bu janjallar goxo uning qulog'ig'a yetib qolar va biz ikki yov uning oldig'a chaqirilib nasihatini eshitar va lekin yana yomonlig'imizdan qolmas edik. Siz ranjisangiz xam aytay: qayin otamni o'z dadamdan xam yaxshi ko'raman. Bu yaxshi ko'rishim kuyavingizning dadasi bo'lg'ani uchun emas, balki*

*uning nur ichiga cho‘milg‘andek bo‘lib ko‘ringan siymosini, “oyim” deb xitob qilg‘andagi muloyim, beozor va muassir so‘zini yaxshi ko‘raman. Ul nasixat uchun og‘iz ochsa vujudim erib ketkadek va bir turluk uxlab huzurlang‘andek, Qisqasi, Zaynab bilan janjallashishning o‘zi bir huzur... Siz manim telba so‘zlarimdan achchig‘lanmang. Agar bu gapimning to‘g‘rilig‘ini bilmakchi bo‘lsangiz, Toshkand kelingiz-da, qayin otamning nasixatini o‘z qulog‘ingiz bilan eshiting-da, unday keyin so‘zimga qiymat bering...” [5, p. 293]*

**Original:** “... *In my previous letters, I jokingly wrote that my legacy and my diary do not match. As for our souls, we are very corrupt, I used to wear a real robe in those days. Zaynab's endless animosity began on the day the winner was revealed. Even if you haven't had a daily sale, you probably understand: We were going to eat and drink each other if they let us go ... I'm not ashamed to give an account of myself in those days ... Fortunately, my father-in-law was rarely aware of our conflicts. Even so, these quarrels would sometimes reach his ears, and we, the two enemies, would be summoned to him and hear his advice, but we would not be spared again. If you are upset, I will say that I love my father-in-law more than my own father. This is not because I love your son-in-law, but because I love his image, which seems to be bathed in light, and his gentle, gentle, and gentle words when he calls her “mother” In short, arguing with Zaynab is a pleasure, as if my body melts and I fall asleep for a while ... Do not be offended by my mad words. If you want to know the truth of this statement, come to Tashkent, listen to my father-in-law's advice with your own ears, and then value my word ...*”

**Translation by V. Smirnova:** “... *Я подшучивала в предыдущих письмах над моими распрями с соперницей. Но говорить по правде, наши отношения совсем испортились, я очень невзлюбила ее. А она особенно возненавидела меня с тех пор, как узнала о моей беременности. У вас-то не было никогда соперницы, но вы, наверное, поймете, что мы готовы были съесть друг друга. Теперь мне даже стыдно бывает вспомнить, как мы ссорились иногда больше ничего. Хорошо, еще, что свекор не всегда узнавал о наших ссорах. Но бывали случаи, когда до него доходили сведения об этом. Тогда он вызывал нас обеих, мы выслушивали его наставления, но не переставали быть врагами. Может, я обижу вас, но все же скажу, что люблю свекра больше родного отца, и не за то, что он отец вашего зятя, а за доброе сердце, за ласковое ко мне отношение - он зовет меня «красавица», - за необходимые убедительные назидания. Когда он говорит со мной, я испытываю истинное удовольствие. Ссориться с Зайнаб - иногда тоже удовольствие, а слушать после этого наставления свекра - удовольствие вдвойне. Пусть вас не смущают эти безумные слова. Вы все поймете, когда приедете в Ташкент и своими ушами услышите речи моего свекра...” [6, p. 359]*

**Translation by V. Smirnova:** “... *I used to make fun of my quarrels with my rival in previous letters. But to tell the truth, our relationship has completely deteriorated, I really disliked her. And she especially hated me since she found out about my pregnancy. You have never had a rival, but you will probably understand that we were ready to eat each other. Now I am even ashamed to remember how we quarreled sometimes nothing else. It's good, also, that the father-in-law did not always find out about our quarrels. But there were times when information about this reached him. Then he called us both, we listened to his instructions, but did not cease to be enemies. Maybe I will offend you, but nevertheless I will say that I love my father-in-law more than my own father, and not because he is the father of your son-in-law, but for his kind heart, for his affectionate attitude towards me - he calls me “beauty” - for inoffensive convincing*

*edifications. When he speaks to me, I feel real pleasure. Quarreling with Zainab is sometimes also a pleasure, and listening to the father-in-law's instructions after this is a double pleasure. Don't be confused by these crazy words. You will understand everything when you arrive in Tashkent and hear with your own ears the speech of my father-in-law ...”*

**Translation M. Safarov:** “...Я подшучивала в предыдущих письмах над моими распрями с соперницей. Но говоря по правде, наши отношения совсем испортились, я очень невзлюбила ее. А она особенно возненавидела меня с тех пор, как узнала о моей беременности. У вас-то не было никогда соперницы, но вы, наверное, поймете, что мы готовы были съесть друг друга. Теперь мне даже стыдно бывает вспомнить, как мы сильно ссорились иногда. Хорошо еще, что свекор не всегда узнавал о наших ссорах. Но бывали случаи, когда до него доходили слухи об этом. Тогда он вызывал нас обеих, мы выслушивали его наставления, но непереставали быть врагами. Может, я обижу вас, но все же скажу, что люблю свекра больше родного отца, и не за то, что он отец вашего зятя, а за доброе сердце, за ласковое ко мне отношение - он зовет меня «айм», «милая», за необходимые убедительные назидания. Когда он говорит со мной, я испытываю истинное наслаждение, словно просыпаюсь после благотворного сна. Одним словом, сама ссора с Зайнаб – одно удовольствие, а после этого сесть напротив свекра и слушать его наставления - удовольствие вдвойне. Пусть вас не смущают эти безумные слова. Вы сами все поймете, когда приедете в Ташкент, своими ушами услышите речи моего свекра и оцените мои впечатления...” [7, p.402]

**Translation M. Safarov:** “... I used to make fun of my quarrels with my rival in previous letters. But to tell the truth, our relationship has completely deteriorated, I really disliked her. And she especially hated me since she found out about my pregnancy. You have never had a rival, but you will probably understand that we were ready to eat each other. Now I am even ashamed to remember how much we quarreled sometimes. It's good that the father-in-law did not always find out about our quarrels. But there were times when he heard rumors about it. Then he called us both, we listened to his instructions, but did not cease to be enemies. Maybe I will offend you, but still I will say that I love my father-in-law more than my own father, and not because he is the father of your son-in-law, but for his kind heart, for his affectionate attitude towards me - he calls me “aim”, “dear”, for offensive persuasive edification. When he speaks to me, I experience true pleasure, as if waking up after a wholesome sleep. In a word, the very quarrel with Zainab is a pleasure, and after that it is doubly pleasure to sit down in front of the father-in-law and listen to his instructions. Don't be confused by these crazy words. You yourself will understand everything when you arrive in Tashkent, hear my father-in-law's speeches with your own ears and appreciate my impressions ...”

As you read the letter, you discover the inner world of Kumush, its unique world. There is no artistic mastery in the original, no beauty in the translations. Writing about his father-in-law Yusufbek Haji, Kumush describes his image as follows: Original: “... Siz ranjisangiz xam aytay: qayin otamni o'z dadamdan xam yaxshi ko'raman. Bu yaxshi ko'rishim kuyavingizning dadasi bo'lg'ani uchun emas, balki uning nur ichiga cho'milg'andek bo'lib ko'ringan siymosini, “oyim” deb xitob qilg'andagi muloyim, beozor va muassir so'zini yaxshi ko'raman. Ul nasixat uchun og'iz ochsa vujudim erib ketkadek va bir turluk uxlab huzurlang'andek, Qisqasi, Zaynab bilan janjallashishning o'zi bir huzur...” – “If you are upset, let me tell you: I love my father-in-law more than my own father. This is not because I love your son-in-law, but because I love his

*image, which seems to be bathed in light, and his gentle, gentle, and gentle words when he calls her “mother.” In short, it is a pleasure to quarrel with Zaynab, as if my body melted when I opened my mouth for advice and I fell asleep.”*

**Translation V. Smirnova:** “...*Может, я обижу вас, но все же скажу, что люблю свекра больше родного отца, и не за то, что он отец вашего зятя, а за доброе сердце, за ласковое ко мне отношение - он зовет меня «красавица», - за необходимые убедительные назидания. Когда он говорит со мной, я испытываю истинное удовольствие. Ссориться с Зайнаб - иногда тоже удовольствие, а слушать после этого наставления свекра - удовольствие вдвойне...*”

**Translation V. Smirnova:** “... *Maybe I will offend you, but still I will say that I love my father-in-law more than my own father, and not because he is the father of your son-in-law, but for his kind heart, for his affectionate attitude towards me - he calls me “beauty”, - for offensive persuasive edification. When he speaks to me, I feel real pleasure. Quarreling with Zainab is sometimes also a pleasure, and listening to the father-in-law’s instructions after this is a double pleasure ...*”

**Translation M. Safarov:** “... *Может, я обижу вас, но все же скажу, что люблю свекра больше родного отца, и не за то, что он отец вашего зятя, а за доброе сердце, за ласковое ко мне отношение - он зовет меня «аим», «милая», за необходимые убедительные назидания. Когда он говорит со мной, я испытываю истинное наслаждение, словно просыпаюсь после благотворного сна. Одним словом, сама ссора с Зайнаб - одно удовольствие, а после этого сесть напротив свекра и слушать его наставления - удовольствие вдвойне...*”

**Translation M. Safarov:** “... *Maybe I will offend you, but still I will say that I love my father-in-law more than my own father, and not because he is the father of your son-in-law, but for his kind heart, for his affectionate attitude towards me - he calls me “aim”, “dear”, for inoffensive persuasive edification. When he speaks to me, I experience true delight, as if waking up after a wholesome sleep. In a word, the very quarrel with Zainab is a pleasure, and after that it is doubly pleasure to sit opposite the father-in-law and listen to his instructions ...*”

There are also a number of shortcomings in the translation of these passages. Most importantly, the translators either did not understand the author’s assessment of Yusufbek Haji from the Silver language, or it was overlooked: Original: “...*balki uning nur ichiga cho ‘milg’andek bo ‘lib ko ‘ringan siymosini, “oyim” deb xitob qilg ‘andagi muloyim, beozor va muassir so ‘zini yaxshi ko ‘raman...*” – “... *maybe I like her image, which looks like she’s bathed in light, and her gentle words when she calls me “aim”...*”, translation by V. Smirnova: “...*, азадоброе сердце, заласковое отношение - он зовет меня «красавица», - за необходимые убедительные назидания...*” – “... *but for a kind heart, for an affectionate attitude towards me – he calls me “beauty”, – for inoffensive convincing edifications ...*”, translation by M. Safarov: “...*азадоброе сердце, заласковое отношение - он зовет меня «аим», «милая», за необходимые убедительные назидания...*” – “... *but for a kind heart, for a gentle attitude towards me – he calls me “aim”, “dear”, for inoffensive convincing edification ...*” In general, the main content of the letter, “... *uning nur ichiga cho ‘milg’andek bo ‘lib ko ‘ringan siymosini...*” – “... *his image, which seemed to be bathed in light ...*” was not reflected in both translations. The emotional and culmination point of the letter was this sentence. It would be

appropriate to translate this sentence as follows: “... за его омытый лучами образ...” – “...for his image washed by rays ...” Unfortunately, neither the translators nor the translator of the original language have been able to come up with this beautiful and beautiful description.

## CONCLUSION

Studies show that when translating the text of a classic work, it is necessary to pay attention to even the smallest details of the original, because those small details are important in revealing the character of the protagonist. Also, it should be noted that prose translations are no exception, as there have been changes and losses in poetic translation [8, p. 73].

**РЕЗЮМЕ.** Мақолада Абдулла Қодирийнинг «Ўткан кунлар» романидан олинган аслият парчаси мутаржимлар Л. Бать ва М. Сафаровнинг русча таржималари билан чоғиштирилиб, унда ижодкорнинг поэтикаси ва бадиий маҳорати қай даражада инъикос топганлиги тўғрисида фикр билдирилган.

**РЕЗЮМЕ.** В статье сравниваются русские переводы отрывка из произведения Абдуллы Кадыри «Минувшие дни», выполненные Л. Бать и М. Сафаровым с оригиналом текста и говорится насколько отражены в них поэтика и художественнон мастерство писателя.

**RESUME.** The article deals with the comparisions of Russian translations of the novel «Bygone days», written by Abdulla Kodiriy done by L. Bat and M.Safarov and the Russian translation in reviewed article it reflects the cultural wealth of the author.

## REFERENCES

- [1] Abdullah Kadiri (1992). “Days Gone By”. “Scorpion from the Altar” – Tashkent:Publishing and Printing Association named after G. Gulom, p. 522.
- [2] Abdulla Kadyri (1958). “Days Gone By,”Tashkent:State publishing house of fiction UzSSR, p. 371
- [3] Abdulla Kadyri (2009). *Days Gone By*. Tahekent: The main editorial office of the publishing and printing joint-stock company “Shark”, p.422.
- [4] V.Fyodorov (1952). *Introduction to the theory of translation*. Moscow:p.305.
- [5] Etkind E.G. (1967). Moscow-Leningrad:Poetry and translation. Publishing house: “Soviet writer,”p.250.
- [6] Ismatullayeva, N. R. (2020). Probability Prediction Strategy In Simultaneous Interpretation. *CURRENT RESEARCH JOURNAL OF PHILOLOGICAL SCIENCES*, 1(01), 1-6.

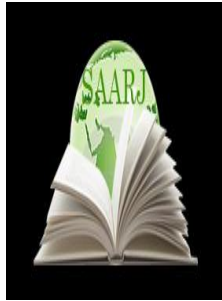

**ACADEMICIA**  
**An International  
 Multidisciplinary  
 Research Journal**  
 (Double Blind Refereed & Peer Reviewed Journal)

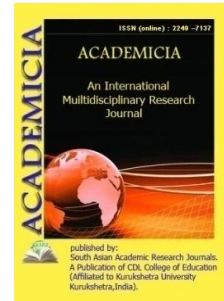

**DOI: 10.5958/2249-7137.2021.01126.5**

## THE AMBIGUITY OF TURKISH WORDS THAT EXPRESS THINGS AND EVENTS IN THE EPIC “MALIKA AYYOR”

**Umarov I\***

\*Teacher,  
 Doctor of Philosophy in Philology (PhD),  
 Jizzakh State Pedagogical Institute,  
 UZBEKISTAN

### ABSTRACT

*The article deals with the issue of ambiguity in the Turkish words that express things and events in the text of the epic “Malika Ayyor”, and almost 52% of such words in the text of the epic belong to the category of nouns. It has been established that these nouns have different appearances from the historical and etymological point of view.*

**KEYWORDS:** *Epic, Text, Turkish Layer, Bakhshi Poet, Epic Hero, Ancient Turkic Language, Historical Work, Turkish Words, Lexeme.*

### INTRODUCTION

Polysemy plays a significant role in any language. Linguistic richness is measured not only by words and phrases, but also by the lexical meanings of words. The ambiguity of words - the phenomenon of polysemy has its place in the richness of language [1, p. 3]. No matter how diverse the individual semantics of a polysemous word may be, they are always grouped around a single semantic basis. Secondary meanings are recognized as a further development of the primary meaning [2, pp. 39-50]. Polysemy is one of the linguistic phenomena related to the semantic structure of a word. Polysemy occurs in almost all word groups [3, p. 209]. Based on the same principles, we have tried to study semantically, lexically-grammatically and genealogically from the polysemous words in the words that express things and events used in the text of the epic “Malika Ayyor”. Our research in this regard has shown that ambiguity is most active within the noun phrase.

## THE MAIN FINDINGS AND RESULTS

The astronomer “*er*”, which signifies the chief semaphore of “the third planet after the sun” (Explanatory Dictionary of Uzbek language, 2, 14), was used in four senses in ancient written monuments (OTD, 257). In the language of Navoi's works, this name lexeme is used in six senses (Explanatory dictionary of the language of Alisher Navoi's works, I, 524-525). In the lexicon of the poet's historical works, it is acknowledged that this term served to express four meanings in one hundred and eighteen places [4, p, 153]. In the modern Uzbek literary language, the lexeme “*er*” is found to occur in eleven senses (Explanatory Dictionary of Uzbek language, 2, 14). In the epic we have studied, the activity of the use of this lexeme is much higher and has the following meanings:

1. In the meaning of “the surface on which things stand, the surface on which living organisms live (in relation to a person or other thing)”: *Izlasang, topmaysanerningustidan* (8) - If you search, you will not find on the earth; *Borareringaytginnenga, sendushman* (22) - Go tell your husband, you are the enemy;

2. In the meaning “A certain part of the earth's surface; place, territory”: *...ostigamingandirG'irotni, harergaborsatopadiMurodni* (16) - ... rides under Girat, wherever he goes he finds Murad; *Enditavakkal, ovloqerdabungama'lumqilayinbir, — deb Avazxonozinimalumqilib, birso'zqilibturibdi* (23) - Now, let me tell you about it in the wilderness, in the wilderness”, said Avazkhan, introducing himself;

3. In the meaning of “A place occupied by something; space”: *G'irotniSoqigaberib, qirqeshiklichillaxonasigakirib, ko'krugininamergaberibxafabo'libyotdi* (10) - Giving his giraffe to Soki, he entered his forty-door children's house, lay his chest in the damp ground, and lay down in sorrow; *Qaradi: ikkiyog'ichimerniomochdaytilgan, soqolmurtio'sibketgan* (21) - He looked: his two legs were plowing the grass like a plow, and his beard was growing;

4. In the sense of “a short time before the start of a particular task (saddle)”: *Soqiotniyalang'ochlab, qashlab, egarlabberayin deb turganeri* (13) - Her husband, who was about to strip the horse naked, snort, and saddle it;

5. In the meaning of “territory, place belonging to a particular country or state”: “*Bu erdaqulaygatushirolmadik, birorerdaqulaygatushirsak, o'zibilanbirgabo'lsak deb: — Avazxon, boradiganeringyaqinmi, uzoqmi? Biz ham birgaboribkelsak, — dedi* (19) - “We couldn't get comfortable here, we wanted to get comfortable somewhere, to be with him: - Avazkhan, is your husband near or far?” If we go together, he said;

6. In the meaning of “a part, place, and point, place of an object or member”: *Avazxonko'nqlinixushlab, dimog'ichoqbo'lib, u eridan, bueridanushlab, Gulqizoyimningko'nqlinixushlab, o'tiraberdi*(54) - Avazkhan was happy, he was happy, he was happy, he was happy, he was happy, he was happy, he was happy, he was happy, he was happy, he was happy, he was happy;

7. To underestimate - in the sense of “humiliation, insult”: *Xoldar mahram o'nyigitmanquvonib. Ergauribqo'shadiharbirso'ziga* (207) - Holder rejoiced at the ten young men. Every word that hits the ground;

8. *Underground* - in the meaning of “wherever”: *Erostitadushmantanichirisin* (110) - Let the enemy rot under the ground; *Erostitagushibketsakkerak-da* (46) - Although we must go underground;

9. *Earth* - in the meaning of “the whole world, the universe”: *Qizil dev aytdi: — O'jiyanim! Bizlarkunbotishbilan kun chiqarni, eryuziniqolmayuchamiz* (58) - The red giant said, “Oh, nephew!” We fly with the rising of the sun at sunset, without leaving the earth; *Eryuzindajumlao'tganvalilar* (72) - Governors who passed sentence on earth;

10. *To put on the ground* - in the sense of “everyone's words and advice are the same”: *Avazxonuchchovichinorningoldidako'pso'zlnarnigaplashib, maslahatnibirergaqo'yib: - Eybolam, gapdannimachiqadi, yo'lyurmoqa'loroqdedi* (66) - The Avazkhan trio spoke many words in front of the plane tree and put the advice together: - My son, it is better to walk than to talk;

11. *Staying on the ground* - in the sense of “not leaving his head on the ground or alienating”: *Pastkiko'shkigaetib, “Mardningboshierdaqolmasin”, Avazjonningboshinitizzasigaolib “qaysimamlakatdankelding?”— debso'rab, birso'zdedi* (51) - Reaching the lower mansion, he said, “Let not the head of the man remain on the ground”. He brought Avazjon's head to his knees and asked, “What country are you from?” - he asked and said a word;

12. The lexeme of “er” in the text of the epic expresses such relations as time, place, cause, when it serves as an auxiliary in the form of direction, place-time, exit, future tense: *Devlarbuerdayo'qedi* (54) - The giants were not here; *Manzilishuerdanetmishyillikyo'lkeladi* (58) - The address comes seventy years from here; *ShundaXadichaTillaqizdanbuso'znieshitib, erdanTemirtaktopganquldaybo'lib, chopiborqasigaqaytaberdi* (108) - When Khadijah heard this from Tillaqiz, she ran back like a slave who has found iron on the ground.

Another polysemous lexeme, the blood lexeme, which means “the fluid tissue of the body that moves continuously within a closed system of heart and blood vessels,” is also actively used in the text of the epic. In the language of Navoi's works, it is recognized in linguistics that the term is used in two senses (Explanatory dictionary of the language of AlisherNavoi's works, IV, 63), as well as in the lexicon of the poet's historical works in the sense of “blood”, “revenge, blood revenge” [4, p. 153]. In the epic we studied, it was found that this lexeme was used in the following senses:

1. In the meaning of “faded”: *Bu devlarniko'rib, merganlarningrangi-tusiuchib, qoniqochib, mazasiketibqoldi* (41) - Seeing these giants, the snipers flew in color, bled, and lost their taste;

2. In the meaning of “to weep bitterly”: *Qonyig'latibbumanzilda. Sen ketarsanbiznitashlab. Ayroliqo'tigadog'lab. Biz qolamizqonlaryig'lab* (120) - Blood crying at this address. You leave us. Spotted on the grass. We remain weeping blood;

3. In the meaning of “Sacrificing war, fighting; to sacrifice a person in this way”: *G'ayratbilanqonto'kishmoqlozimdi(r)* (131) - Blood must be shed with zeal; *Otqo'yibdushmanustiga. Qaramaybaland-pastiga. Qonto'kilibshuzamonda* (141) - Put the horse on the enemy. Despite the ups and downs. Bloodshed at this time;

4. In the meaning of “To be in great distress; to be bloodthirsty”: *Yodimizgasizniolsak. Biz yig'larmizqonyutib* (120) - If we remember you. We weep and swallow blood;



5. In the meaning of “fading color, loss of redness”: “*Qonisuyuq, rangidaqoniyo'q, ko'ziolayganyomonyigitekan*”, *deb devlarqo'rqibturibdi* (42) - The giants are afraid, “He is a bad guy with thin blood, no blood in his complexion, and his eyes are wide open”.

**Polysemy in words in the Turkish layer**

*Lexeme “er-earth”*

*Lexeme “qon - blood”*

1.	Explanatory dictionary of Uzbek language , 2, 14.: 11 meanings	1.	Explanatory dictionary of Uzbek language, 5, 328.: 4 meanings
2.	OTD (Old Turkish Dictionary, 257): 4 ra meanings	2.	OTD (Old Turkish Dictionary, 464): 4 meanings
3.	Explanatory dictionary of the language of AlisherNavoi's works, I, 524-525.: 6 meanings	3.	Explanatory dictionary of the language of AlisherNavoi's works, IV, 63.: 2 meanings
4.	ANTA.: 4 meanings	4.	ANTA.: 2 meanings
	Used in the epic “ <i>Malika Ayyor</i> ” in 12 meanings:		Used in the epic “ <i>Malika Ayyor</i> ” in 5 meanings:
1.	“Surface, level (in relation to a person or thing)”	1.	“Faded”
2.	“Part of the earth's surface; place, territory”	2.	"Crushing and burning"
3.	“Occupied place, place; space ”	3.	“Sacrificing people”
4.	"Short time before the action"	4.	"Sorrow is suffering, blood is blood"
5.	“Country, place”	5.	“The color fades, the redness disappears”
6.	“Part, place, point of something”		
7.	<i>To underestimate</i> – “degrading”		
8.	<i>Underground</i> – “Wherever”		
9.	<i>Earth</i> – “The whole world, the universe”		
10.	To put on the ground– “the word, the advice is the same”		
11.	<i>To stay on the ground</i> – “not to		

	alienate”			
12.	“In terms of agreements, it means relations such as time, place, reason”.			

**Table 3. Polysemous representation of earth and blood lexemes**

The lexeme of speech, which has its own sound shell, an independent lexical meaning (Explanatory dictionary of Uzbek language, 3, 608), is also actively used in the epic and expresses the following meanings:

1. In the meaning of “sentence, word, speech”: *Ota, eshitmeningaytganso'zimni* (12) - Father, hear what I say; *Aytganso'zimolendiBo'zo'g'lon* (12) - Take what I say now, bully;
2. In the meaning of “narrating certain information”: *Ana shunda Parizod Go'ro'g'lidanbuso'zni eshitib, o'sganelini, sog'u-so'lini, sha'n-shavkatini, manzil-joyini Go'ro'g'ligabayonberib, birso'z deb turibdi...*(8) - When Parizod heard this word from Gorogly, he told Gorogly about his upbringing, health, honor, and address, and said a word ...;
3. In the meaning of “dialogue or consultation, communication”: *Shunda Go'ro'g'libek Avazxondanbuso'zni eshitib: — Avazo'g'lim, buso'znibejoyaytding. Bu aytganso'zingko'pyomonbo'ldi, endiharnimabo'lsa, bormasangbo'lmaydi* (12) - Then Goroglybek heard this word from Avazkhan: - My son Avaz, you said this word in vain. What you said was so bad, now that whatever it is, you have to go;
4. Topromise - in the sense of “to allow or not to speak”: *So'zbergandirmerganlargajodugar. So'zbermasa, merganlardanimabor* (202) - The sorcerer promised the snipers. What does the sniper have if he does not promise?;
5. To stutter –in the meaning of “To say or not to say something; to speak or not to speak”: *Diqqatbo'libyotgan Avazjon Gulzamonga So'y lamadi ham, qaramadi ham, so'zqotmadi ham* (49) - The attentive Avazjon did not speak, look, or speak to Gulzamon; *Shunda Qosimshohqalandarlarga qarab: - qaysi shahardankeldinglar? - debso'rab, so'zqotib, birso'z dedi:* (91) - Then Kasimshah looked at the potters and said: - What city are you from?, - he asked, stiffening his words and saying a word;
6. Proverb, a word of wisdom; as an example of the phrase: “*Piyodaqo'noq - yaxshiqo'noq*”, *deganso'zbor* (84) - There is a saying, “A guest on foot is a good guest”; “*Ertilaganerdaaziz*”, *deganso'zbor* (184) - There is a saying, “Saint wherever he wants”.

## CONCLUSION

It is noted that the *word* lexeme had one meaning in the ancient Turkic language (OTD, 511), and in Navoi's works it served to express four meanings (Explanatory dictionary of the language of Alisher Navoi's works, III, 137). It has been established that in the modern Uzbek literary language the word lexeme is used to express eight semantics (Explanatory dictionary of Uzbek language, 3, 608). It is clear from the above analysis that in the text of the epic studied, this term served to express the six semas.

**REFERENCES**

- [1] Mirtojiev M. (1975). *Polysemy in the Uzbek language*. – Tashkent: Fan. –p. 3.
- [2] Budagov R.A. (1958). *An introduction to the science of language*. - Moscow: Uchpedgiz. – pp. 39-50.
- [3] *Lexicology of the Uzbek language*. –Tashkent: Fan, 1981. – p.209.
- [4] Abduvalieva D. (2016). *Vocabulary of historical works of AlisherNavoi*. – Tashkent: Fan. – pp. 51, 55 p.
- [5] Rasuljanovna, I. N. (2019). The phenomenon of lacunarity as the linguacultural issue. *Prospectsofworld science-2019*, 226.
- [6] *Explanatory dictionary of the Uzbek language*. - Tashkent: National Encyclopedia of Uzbekistan, 2006-2008.



**ACADEMICIA**  
**An International**  
**Multidisciplinary**  
**Research Journal**  
 (Double Blind Refereed & Peer Reviewed Journal)

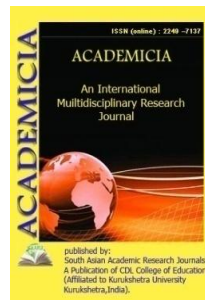

DOI: **10.5958/2249-7137.2021.01207.6**

**PROPERTY OF GRAMMATICAL MEANINGS OF ADVERBS IN  
 DIFFERENT SYSTEM LANGUAGES**

**Patila Mendirmanovna Zheenalieva\*;**  
**Kanymzhan Turdumamatovna Turgunbaeva\*\*;**  
**Nasiba Sayidmahamadovna Sayidirakhimova\*\*\***

Senior Lecturer,  
 Osh State University, Osh, Kyrgyzstan,  
 UZBEKISTAN

\*\*Associate Professor,  
 Osh Technological University, Osh, Kyrgyzstan,  
 UZBEKISTAN

\*\*\*Associate Professor,  
 International Islamic Academy of Uzbekistan  
 Republic of Uzbekistan. Tashkent, UZBEKISTAN  
 Email id: sayidirahimova@navoiy-uni.uz

**ABSTRACT**

*The article examines the similarity of an adverb and a verb in their functional and semantic planes, characterized by the fact that the semantics of both the verb and the adverb is homogeneous, both denote signs and properties of the grammatical plan; the meaning of the verb depends on the meaning of the noun; meaning of an adverb from the meaning of a verb. This means that the difference between the grammatical meanings of an adverb and a verb is determined by the fact that the meaning of the verb is procedural, and the meaning of the adverb is not procedural, but a sign of quality. In addition, the meaning of the verb in relation to the object, the phenomenon is immediate, i.e. through the meanings of the verb.*

**KEYWORDS:** *Functionality, Semantics, Grammatical Plan, Processuality, Verb, Sign, Meaning, System Of Parts Of Speech, Signs Of Property.*

## INTRODUCTION

During the functioning of grammatical meanings, oriented towards sequential logical subordination, the grammatical meaning of a noun is characterized as a hegemonic, basic, leading meaning in relation to the grammatical meanings of other other significant parts of speech in the general system of parts of speech. The functioning of the grammatical meanings of the adjective, verb and adverb is carried out under the influence of the grammatical meaning of the noun.

It was said above that the presence and implementation of the grammatical meaning of an adverb is determined in relation to the grammatical meanings of the verb (mainly) and the adjective (in some cases). If there is no verb and adjective and their grammatical meanings, then there is no adverb and its grammatical meaning, this is typical for adverbs and their grammatical meanings of all languages of the world, not only Tajik and Uzbek.

### Main body

The meaning of a feature, quality and properties is equated to the meaning of objectivity, processuality in the semantic system of the grammatical plan of parts of speech. The meaning of a trait, quality, and property is understood in a narrow and broad sense. In the broad sense, the meaning of a trait, quality, and property covers almost all the tiers of a language, except for its phonetic and phonological tier. So, for example, words like *yakhshi* (хороший // ое // ая), *юмшоқ* (мягкое // ая // бй), *ўртача* (средний // яя // ее), *иссиқ* (жаркий // ая // ое), *совуқ* (холодный // ая // ое) refer to the lexical tiers of the language and denote the signs, properties or qualities of a certain object or phenomenon. The derivatives *ейишли* (съедобный // ая // ое), *болалик* (детство), *хийлакор* (хитрец), *эзма* (болтун), *учирма* (слеток) are derived words, the morphemic-word-forming meaning of which is characterized by the meaning of the attribute, quality and properties of certain concepts that are associated with the word-forming function of the affixes -ли, -лик, -чор, -ма.

The syntactic values of the predicate, the definition, and the circumstance also belong to the general system of values of the attribute, quality, and property, which are considered in syntax as the grammatical values of its separate categories – the categories of the definition, the circumstance, and the predicate, which are semantically in the same general group with respect to their common, invariant meaning – the meaning of the attribute, quality, and property.

So, the grammatical meaning of a trait, quality, and property in a broad sense has the character of isolation, universality, and it is not limited in terms of a particular specific level (tier) of the language.

The grammatical meaning of a trait, quality, and property in a narrow sense is specific, not universal. It refers only to the semantic plan of a certain level of the language, usually it is characteristic of the content plan of lexical units of one or two lexical-grammatical categories of the general system of parts of speech. The meanings of the trait, properties and qualities characteristic of adjectives and adverbs belong to the group of their narrow understanding. It should be noted that, in turn, the meaning of the attribute, qualities and properties peculiar to individual lexical and grammatical categories (categories) of words is an abstract complex ideal semantic unit. The abstractness and complexity of this ideal semantic unit is determined in relation to their relation to what phenomena of the language and why it is related to them. It is natural that certain concepts of the meanings of a trait, quality, and property have a direct

connection with objects and phenomena of the objective world, and the relation of some does not have a direct connection with them, their relation is mediated, non-objective.

The relationship of these concepts with objects and phenomena is carried out through the processes of real action and the state of the objects and phenomena of the world around us. The meaning of a trait, quality, and property that is directly related to objects and phenomena is the grammatical meaning of an adjective. The second group of meanings-the meaning of a feature, quality, and property that are not directly related to objects and phenomena-is the grammatical meaning of an adverb. From the point of view of the commonality of the grammatical meanings of the adjective and adverb, these two lexico-grammatical categories, that is, parts of speech, are close in relation to each other. Despite this, there are significant differences between these lexicon-grammatical categories (parts of speech), which are determined by the fact that the adjective is a lexical-semantic group of predicative lexical units with the meanings of a non-procedural attribute of an object (E.M.Wolf); an adverb is a set of lexical units, in the functioning of which the attributive qualities of predicative meanings are realized (I.I.Meshchaninov), as well as lexical and grammatical groups of words (N.M.Vasilyeva). All lexical units that make up the lexico-grammatical category of adverbs are characterized by the same grammatical features and grammatical meanings, in which the procedural features of a particular character are displayed. The meaning of this symbol is sometimes expressed using lexical units and other parts of speech, for example, nouns and verbs, but they are not categorical, not isosemic to their meanings and differ from their own categorical meanings.

The property of lexico-grammatical meanings of an adverb is characterized by the fact that these meanings are farthest from the reality of lexico-grammatical meanings, for example, of an adjective and a verb, although they, together with the lexico-grammatical meaning of an adverb, are at the same stage of the semantic plan of significant parts of speech [5,6,7].

Avrorin, regarding the meaning of adverbs, emphasizes that adverbs are combined into one part of speech, primarily on the basis of the unity of their most general categorical meaning: they are all specially designed to denote certain signs of actions and qualities. But this is not enough. The same signs of actions can be indicated by some forms of names and verb words. A distinctive feature of the semantics of adverbs is that they, in comparison with other parts of speech that can denote similar concepts, have a more abstract, generalized meaning devoid of real concreteness.[1]

Differences between scientists are also observed in the linguistic description of parts of speech. Some linguists call them lexical categories of words (because parts of speech are formed as lexical groups of words), other linguists call them grammatical classes of words (because parts of speech are formed based on the grammatical features of words, because in fact they are grammatical phenomena). In some sources, parts of speech are considered as lexical and grammatical groups of words (since the lexical and grammatical meanings of words exist in words simultaneously, synchronously and syncretically). [2,8] Parts of speech are large groups of words in which each lexico-grammatical category is formed on the basis of the unity of grammatical meanings and their formal means, which gives rise to the definition of parts of speech as the largest morphological category. In particular, a noun is a morphological category that combines lexical units with a common meaning of objectivity; an adjective is a morphological category whose lexical units are combined with a common meaning of a feature, quality, and property of an object or phenomenon. In turn, the verb is characterized by the largest

grammatical category, the system of which consists of lexical units with a general meaning of processality, etc. [2,3,4].

Thus, it is clear how important parts of speech are in the morphological system of language, because the term morphology primarily refers to the system of parts of speech. When choosing each part of speech, the grammatical meaning of the word and their formal meanings are taken as a basis. When highlighting certain parts of speech, one cannot rely only on the formal means of lexical units. Or one-way is the method of classifying a dictionary to parts of speech, based on the real lexical characteristics of lexical units.

Elements of the structure of one part of speech are interconnected with elements of another part of speech, a set of structural elements and their interconnection constitutes the entire system of language, because language is a system of systems.

## CONCLUSIONS

From this point of view, if we approach the question of an adverb, we should say that the values of the signs of a trait contain a system of grammatical meanings of the adverb. The grammatical meaning of an adverb is outside the system of formalization. However, the units of this lexicogrammatical category have a peculiar grammatical form. The proper morphological features of an adverb are the absence of inflection affixes in it and the presence of proper affixes of adverb formation (affixes of word formation).

## REFERENCES

1. Avrorin V.A. Nanai grammar. – Moskva, - Leningrad, 1961. -P. 177. Golovin B.N. Introduction to linguistics– Moskva: Higher. shk. 1983. -P. 112.
2. Saiidyrakhimova, DS. Zhakypova DM. General Theoretical in synchronikal typological learning of english adverbs. International Scientific Journal Theoretical & Applied Science. - Philadelphia, USA, №2 (58), 2016. P. 16-19.
3. Sayidirahimova, N.S. (2020). General Theoretical Aspects In Synchronical Typological Learning Of English Adverbs (Adverb Goals) // Published in International Journal of Research Available at <https://edupediapublications.org/journals>. Available online: <http://edupediapublications.org/journals/index.php/IJR/> P. - Indiya., 2020. P. 384-398.
4. Sayidirahimova, N.S (2020). Semantic classification of the syntax antonyms of uzbek language // International Scientific Journal Theoretical & Applied Science. -Philadelphia, USA, 2020. P. 671-673.
5. Sayyidrakhimova Dilfuza Sayidmakhamajanovna, Kadenova Zhannat Toktomamatovna, Sayidirakhimova Nasiba Sayidmahamadovna, Abdyrakmanova Gulsun Mamatovna. Formation and development of the theory of speech parts of unchangeable words in languages of different grammatical structure. EPRA International Journal of Multidisciplinary Research (IJMR) - Peer Reviewed Journal Volume: 6 | Issue: 12 |December 2020 || Journal DOI: 10.36713/epra2013 || SJIF Impact Factor: 7.032 ||ISI Value: 1.188. P.62-65.
6. Saiidyrakhimova, DS. Zhakypova DM. Adverbs and its interpretation in the Tajik language. International Scientific Journal Theoretical & Applied Science. -Philadelphia, USA, №5 (61), 2018. P. 53-55.

7. Sayidirakhimova, DS.Kabulova, US. Sayidirahimova, N.S. Tadjibayeva, MA. Problem of adverbs synchronical-typological investigation of grammatical categories in unrelated languages. International Journal of Research in Economics and Social Sciences(IJRESS). Available online at: <http://euroasiapub.org> Vol. 10 Issue 11, Nvember- 2020. ISSN: 2249-7382 | Impact Factor: 7.077| (An open access scholarly, peer-reviewed, interdisciplinary, monthly, and fully refereed journal.) P.81-89.
8. Sayidirahimova, N.S. (2020) General Theoretical Aspects In Synchronical Typological Learning Of English Adverbs (Adverb Goals). International Journal of Research Available at <https://edupediapublications.org/journals>. Available online: <http://edupediapublications.org/journals/index.php/IJR/> R. - Indiya., 2020. P. 384-398.





**ACADEMICIA**  
**An International**  
**Multidisciplinary**  
**Research Journal**  
 (Double Blind Refereed & Peer Reviewed Journal)



DOI: **10.5958/2249-7137.2021.01208.8**

## THEORETICAL FOUNDATIONS OF COLORING IN THE ORGANIZATION OF FINE ARTS CLASSES

**Botir Boltabaevich Baymetov\***; **Shoxidahon Odiljonovna Botirova\*\***

\*Professor,  
 Chirchik State Pedagogical Institute,  
 Tashkent, UZBEKISTAN  
 Email id: bbb19532506@gmail.com

\*\*Master Student,  
 Namangan State University,  
 UZBEKISTAN

### ABSTRACT

*The article is devoted to the phenomena of the formation and distribution of color in nature, its role in the creation of works of art by ancient scientists and artists, the use of color science in the creation of works of art by great artist theorists. The future artist is also focused on teaching teachers how colors change under the influence of the environment, how to prepare and use paints.*

**KEYWORDS:** *Color, Painting, Fine Arts, Color, Gamma, Color Range.*

### INTRODUCTION

It is known that the course of painting fundamentals is aimed at the best development of knowledge, skills and abilities of future professionals in the field of painting. The basis of painting is the science of color. The future artist will teach teachers examples of the formation and distribution of colors in nature, how they change under the influence of the environment, and how to prepare and use paints.

In ancient Central Asia, the doctrine of color has developed since ancient times in connection with book miniatures, painting, painting paintings and panels on the walls. Because the art of painting required the ability to choose colors and prepare them. Therefore, each student first learned the secrets of color preparation and the chemical processes involved in this work.

### **The main findings and results**

The phenomena of how colors form and spread in nature have long attracted the attention of scientists and artists. The great Renaissance painters and theorists Leon Batista Alberti, Leonardo da Vinci, and others wrote about the properties of color in their paintings. Well-known scientists Newton, Lomonosov, Helmholtz studied the essence of colors on a scientific basis.

If Newton studied colors from the point of view of physics, German poet and art historian IV Goethe was more interested in the effect of colors on the human body in his book *The Doctrine of Colors*, Goethe wrote about the use of warm (yellow-red) colors to evoke a sense of well-being.

In the XX century, the German naturalist G.L. Helmholtz, one of the European scientists, made an important innovation in the theory of color science. Based on many years of experience, it has been shown that chromatic colors should be categorized based on three main characteristics - color tone (name), color saturation, and saturation.

Japanese scientists have always taken the study of color problems seriously. At the Tokyo Institute of Color, which is still the only one in the world, color is studied in detail - a natural phenomenon that affects the human heart.

The symbol that represents the name of a color, that is, one of which is called red, the other blue, the third purple, and so on, is called a color tone.

When we add a little gray to a chromatic color, its brilliance decreases and it becomes dimmer. This indicates a low saturation of the color, i.e. a decrease in the content of pure dye. So, when we say color saturation, we need to understand its level of color, its purity, compared to gray.

From the above, it is clear that chromatic colors differ from each other in three main properties — color tone (color itself), color saturation, and saturation. If we look closely at the spectrum, we notice signs of similarity between the red and purple colors at its very edges. When two colors are combined, red is formed between them, and when the spectrum is connected by placing the resulting color between red and purple, it is called a range of colors.

Colors range from red, reddish-orange, yellow-yellow-green, green-quality blue, air-color, blue-air color, blue, blue-purple, various shades of red.

There can be a lot of color tones in the color range. But our eyes are able to distinguish about 150 of them. The order in which the colors are arranged around the circle is kept certain.

If the color range is divided into two equal parts, in the first half there are red, orange, yellow-green (pistachio) colors, and in the second half there are green air colors, turquoise, blue, purple. The first half of the circle is warm colors and the second half is cool colors. The reason for this name is that the reds are reminiscent of fire, hot iron, coal, the color of air is blue, and the blues are reminiscent of ice and water. This difference is relative, and any warm color may appear cooler next to a warmer color than itself, and conversely, a cold color may appear warmer next to a cooler color than itself.

In 1676, Isaac Newton used a three-dimensional prism to absorb white sunlight into the color spectrum. There were all colors in this spectrum except red. Newton conducted his experiment as follows; when sunlight falls on the prism through a narrow beam, the white light in the prism is

associated with separate spectral colors. The continuous colored ribbon started with red and ended with ink through orange, yellow, green, and blue. If this image was then passed through a condenser lens, the sum of all the colors would again give a white color. There are other physical ways of creating colors, such as fluorescence, polarization, diffraction, and interference.

If we divide the spectrum into 2 parts, for example red, orange, yellow and green-blue-ink, and we collect each of these groups with a special lens. As a result we get 2 mixed colors, this color mixture also gives the result a white color. This is the sum of the two colors, called the complementary color. If we remove 1 color from the spectrum, for example, green and the remaining colors using the lens, i.e. red, orange, blue and ink, then the color mixture we get will be red, i.e. an additional color will be created relative to the removed green.

If we remove the color yellow, the remaining colors in it - red, orange, green, blue, and ink - give us an ink color, which is an additional color to yellow. Each color is called an additional color relative to the remaining color mixture of the spectrum. In this color mix we can see the remaining ranges in its composition. In this case, the eye is different from the musical ear in that it can distinguish sound from any chord. Different colors are created by light waves. These waves consist of specific electromagnetic forces.

Each color spectrum is characterized by its own wavelength. There is no color in the light waves. Color appears only with the perception of these waves by the human eye and consciousness. It is not yet fully known how man can distinguish these waves. The main issue here is to determine the body (general) or (solid) color of the object.

If we put a filter that transmits red and a filter that transmits green in front of an arc lamp, then both filters together give black or dark.

In addition to its specific colors, red absorbs spectral rays in that range. The green filter captures all colors except green.

Thus no light is transmitted. And we get the darkness. According to physical experience, the absorption of colors is called separating colors.

The colors of objects appear mainly in the process of wave absorption. The red vessel appears to be red because it absorbs all the light rays and reflects the physical color. When we say "this container is red", the molecular composition on the surface of the container absorbs all types of light from red.

The container itself has no color, but the color appears as a result of light. If the red paper is illuminated with a green light, the paper will appear black to us. Because there is no light in green that responds to red all dyes in a color image can be spotted or pigmented. In the process of mixing these self-absorbing dyes, it is recommended to follow the rule of separation.

The harmony of different colors in works of fine art, the interdependence between beautiful color combinations, the leading color in a work of art is called *calorie*.

Color mixtures play an important role in painting. Colors are close in color blend together.

When colors are mixed through mutual hues, they show a distinct resonance and quality changes are noticeable. The color that deviates from the overall color looks inappropriately alien, and the fine art undermines the integrity of the work. A work of fine art is created by mixing all the

colors together. It is not possible to change, reduce or enlarge any piece of color in terms of brightness or brightness without damaging the integrity of the work.

Color reveals to us the rich, colorful beauty of the universe. It helps artists express the mood of the image.

The coloring can be calm, enjoyable, anxious, frustrating, as well as marrow and cold, bright and muffled. The paintings of great artists and masters in the past allow us to observe the development of color in some of the following periods. The concept of color was formed and developed in the late fifteenth century. The first changes from it began to appear at the end of the century. Artists of this period divided the colors into semi-streams, smoothing the colors without adding them separately. This is exacerbated by the Constable, especially the Impressionists. The scientific works of the Russian art critic B. Vipper are dedicated to the history of painting.

In the XV century in the paintings of Italian, French, German artists, paints existed independently of each other. As you watch Bernard Dürer's "Portrait of Oswald Krel," notice that the background of the work remains bright red or light red in both light and shadow. The artist depicts it as if he is filling things and objects the bodies of the heroes are not immersed in the surrounding space, but are embodied on an indistinct brown, red background.

Color and shape blend into one whole, leaving the paint indistinguishable from the light and space. The period from bell to titsen and tinturettu is the period when the original color is transformed into hues.

In the sixteenth century, while color represented life in general in works of fine art, their coverage increased exponentially. New reflections began to appear; The dry valley is very bright-red, warm-green, brown-yellow, light blue, blue, on bicycles - unobtrusive swells around black, gray, white-pink and so on.

Rembrandt limits its palette to dark colors, but in it the color has a new liveliness and mysterious properties.

Renaissance painters, such as Titian, use color as a reflection of real life. In the Baroque period, color is involved in many aspects as an element that performs aesthetic functions in painting fantasy.

Master artists of the past have used beautiful, colorful combinations, color combinations, and intricate techniques to express their work. They used strong color and color contrasts.

Therefore, they used the underestimation method to achieve the desired color tones.

By the XVIII century, color-related aesthetic games began to take on a more antique and intricate tone. The artists applied subtle shades of a single color to the human figure, hair, and clothing white, light yellow, light brown came to the fore.

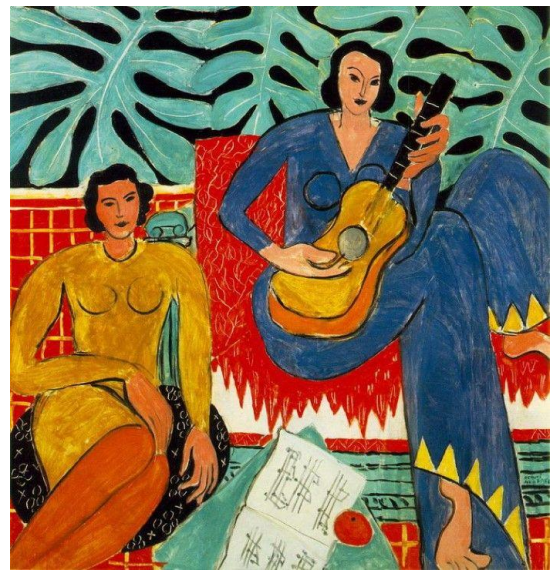

The struggle of different ideas, the contradictions between color and shape, dates back to the nineteenth century. During this period, color became the main source of optical research. Nineteenth-century painters, especially the Impressionist groups, mastered the art of distinguishing bright from free color and expressing the scattering of sunlight. They paid more attention to color contrast by using impressions of color optical combinations and began to use pure dyes.

Henri Matisse, Paul Gauguin, Van Gogh will have large contours with clear contours and resonance. Matisse had its own palette - a set of colors - in the realm of original paints. He discovered that the cut-out pieces from a painting were placed in certain planes, without any auxiliary images, in the grease method of the paintings. Matisse's paper stickers are a whole in terms of color, making it very easy to turn them (tapestry) into a carpet image, fabric color print, and book decorations.

In Gauguin's works, color does not perform pictorial functions, but is in an ornamental, symbolic direction, where red sand, pink grass, and blue trees can be seen.

Van Gogh's works featured beautiful contrasting color complexes. But here the dyes are not decorative, but psychological factors and moods.



Sensing and perceiving color is a very important skill. I.Repin, V.Surikov, K.Korovin, M.Vrubel, F.Maliavin, U.Tansiqbayev, Sh.Abdurashidov and others are among the colorful artists.

Repin ages serve as a free expression of color, with the first colors — gold, yellow, and red.

V. Surikov's favorite color was blue, with cool blue colors. Many of his works are depicted in silver color.

M. Vrubel is illuminated in gray-blue, and most of F. Maliavi's works are bright red.

Often, color serves as a primary vehicle in reflecting nationalism, naturalness, human qualities, and household items.

In this regard, we are talking about the concept of "national color". The works of Ch. Akhmarov, R. Kent, M. Saryan are examples of this. Each artist has his own color, as evidenced by the general palette of works of fine art he worked on.

## CONCLUSION

In conclusion, the art of painting is the art of combining color and light. When working on works of art, it is important to consider the effects of colors on each other and describe them on the basis of color harmony.

It is important that the right combination of colors found in the image, along with the understanding of beauty, also creates the basis for the development of knowledge of the beauty of fine art.

Artists focus on applied art and color combinations, while at the same time being able to focus the original colors of things and objects in symbolic directions. The color harmony in the pattern is achieved using all the elements, color contrasts and tone polishes.

The color chosen, its pictorial parts, rhythmic arrangements, what it is intended for and what it is made of are always taken into account when performing decorative-decorative works.

In the design direction, the relationship of color and shape, the purpose for which it is, the brightness, the attractiveness are of great importance.

## REFERENCES

1. Boltaboevich, B. B. (2020). Formation of the skills of portraying the future teacher of fine arts in pencil drawing. *ACADEMICIA: An International Multidisciplinary Research Journal*, 10(5), 1122-1127.
2. Baymetov, B. B., & Muratov, K. K. (2020). Self Sketches as a Tool in the Professional Training of a Future Artist-Teacher. *SolidStateTechnology*, 224-231.
3. Байметов, Б. Б. (2016). История развития изобразительного искусства Узбекистана. *Наука, образование и культура*, (1 (4)).
4. Baymetov, B. B., & Sharipjonov, M. S. O. (2020). Development Of Students' Descriptive Competencies In Pencil Drawing Practice. *The American Journal of Social Science and Education Innovations*, 2(08), 261-267.
5. Байметов Ботир Болтабаевич. Актуальные вопросы подготовки педагогических кадров республике Узбекистан. *Международный научный журнал «ВЕСТНИК НАУКИ»* 2020/10. Том 1. 10 (31). Страницы 5-9.
6. Boltaboevich, B. B., & Ogiloy, K. (2008). Master of historical portrait genre, a teacher who created a school in the field of fine arts people's artist of uzbekistan professor malik nabiev (1906-2008).
7. Болтабаевич Ботир Байметов. San'atshunoslik fakulyetlarida talabalarga qalamtasvir mashg'ulotlarini o'tishning nazariy asoslari. *Материалы конференции Science and Education*. 2020/5. Том 2. Номер No. 3. Страницы-406-409.
8. Байметов, Б. Б., Собиров, С. Т., & Исмаев, У. Ш. (2019). Проблемы профессионально-педагогической подготовки учителей изобразительного искусства. *Вестник науки*, 1(7), 63-66.
9. Байметов Ботир Болтабаевич. Тасвирий санъатдан бўлажак рассом-ўқитувчиларни касбий тайёрлашда композиция фанининг назарияси ва методикаси. *Science and education journal*. 2020/4. Стр. 461-467
10. Байметов, Б. Б., Султанов, Х. Э., & Муратов, Х. Х. (2019). Психологические основы активизации творческих способностей студентов в процессе практических занятий. *Вестник науки*, 1(7), 67-71.

11. Байметов, Б. Б., Султанов, Х. Э., Муратов, Х. Х., & Сабиров, С. Т. (2018). Научнотеоретические аспекты формирования композиционных способностей у студентов на занятиях по живописи. In Современная научная мысль (pp. 83-94).
12. Baymetov, B. B. (2020). Development Of The Ability To See And Represent The Form Remotely In The Process Of Teaching Students To Portray A Creature In Higher Pedagogical Education. The American Journal of Applied sciences, 2(10), 154-159.
13. Botir Boltabaevich Baymetov. Development Of The Ability To See And Represent The Form Remotely In The Process Of Teaching Students To Portray A Creature In Higher Pedagogical Education. 2020/10 Журнал. The USA Journals. Том 2. Страницы- 154-159
14. Botir Boltabaevich Baymetov, Ulfat Shuxratovich Ismatov. Pedagogika oliy ta'lim muassasalarida talabalarini bosh namunasini tasvirlashga o'rgatish orqali tyexnik mahoratlarini takomillashtirish Science and education journal. 2020/8. Стр. 476-485
15. Botir Boltabayevich Baymetov. Technologies Of Moving Images Of People From Different Views In Fine Arts Lessons. The American Journal of Social Science and Education Innovations. The American Journal of Social Science and Education Innovations (ISSN – 2689-100x) Published: January 31, 2021. Стр. 463-468
16. BB Baymetov. Inson qomatining turli ko'rinish va holatlaridan qisqa muddatli tasvirlaridan bajarish myetodikasi. "Science and Education" Scientific Journal January 2021 / Volume 2 Issue. 357-365
17. Botir Boltabaevich Baymetov. Oliy pedagogik ta'limda bo'lajak tasviriy san'at o'qituvchilarining ijodiy qobiliyatlarini shakllantirishning ba'zi masalalari. academic research in educational sciences volume 2 | issue 1 | 2021. 277-283 бетлар.
18. BB Baymetov, XX Muratov. Tasviriy san'atdan amaliy mashg'ulotlarida talabalarning tasvirlash mahoratlarini takomillashtirish texnologiyalari. Science and Education, 2021. 349-354 бетлар.
19. Мукаддам Тожикузикази Хамрокулова, Рашид Неъматович Зульфиев, Ботир Болтабаевич Байметов. Теория и практика преподавания академического рисунка в подготовке будущего художника педагога. Science and education scientific journal. 2020/12. Том 1. Номер 9. стр 364-372.
20. Botir Boltabaevich Baymetov. Art Of Modern Uzbekistan: The History Of Its Development During The Years Of Independence. The American Journal of Social Science and Education Innovations. 2020/10. 125-132.
21. B.B. Boltaboevich. Methods of portraiture in the process of making sketches and drawings of the human face in higher pedagogical education. International Journal of Psychosocial Rehabilitation, 2020. Том 24. Номер 5. Страницы 6408-6415.
22. Botir Boltabayevich Baymetov. Technologies Of Moving Images Of People From Different Views In Fine Arts Lessons. The American Journal of Social Science and Education Innovations. 2021/1. The American Journal of Social Science and Education Innovations (ISSN – 2689-100x) Published: January 31, 2021. том 3. номер 1. Страницы 463-468.

23. BB Baymetov. Inson qomatining turli koʻrinish va holatlaridan qisqa muddatli tasvirlaridan bajarish myetodikasi "Science and Education" Scientific Journal January 2021 / Volume 2 Issue 1. 357-365.
24. BB Baymetov, XX Muratov. Tasviriy sanʼatdan amaliy mashgʻulotlarida talabalarning e-ISSN : 2620 3502 p-ISSN : 2615 3785 International Journal on Integrated Education Volume 4, Issue 3, March 2021 | 66 tasvirlash mahoratlarini takomillashtirish texnologiyalari. Science and Education, 2021. 349- 356.
25. Botir Boltabaevich Baymetov Xusan Xolmuratovich Muratov. Methods Of Teaching Students To Do Sketches In Independent Learning. 2020/12. The American Journal of Social Science and Education Innovations. 2. Номер 12. Страницы 8-13
26. Ulfat Shuxratovich Ismatov Botir Boltabaevich Baymetov. Pedagogika oliy taʼlim muassasalarida talabalarini bosh namunasini tasvirlashga oʻrgatish orqali tyexnik mahoratlarini takomillashtirish. 2020/11. "Science and Education" Scientific Journal November 2020 / Volume 1 Issue 8 Страницы 476-484
27. Laylo Mirsoatova, Botir Boltabayevich Baymetov. Oliy pyedagogik taʼlimda inson qomatini tasvirlashning nazariyasi va myetodikasi. 2020/11 "Science and Education" Scientific Journal November 2020 / Volume 1 Issue 8. Страницы 467-475
28. Botir Boltabaevich Baymetov, Ulfat Shuhratovich Ismatov. Development of competencies of future fine art teachers in description of nature in graphic materials. 2020. ACADEMICIA: An International Multidisciplinary Research Journal. том 10. Номер 11. Страницы 864-871.
29. Botir Boltabaevich Baymetov. Creativity Of The Outstanding Artist-Miniaturist Kamaledin Behzad (1455-1536). international scientific and current research conferences "science and innovation in the xxi century: crucial issues, discoveries and achievements" Doi - <https://doi.org/10.37547/iscreintconf03 2021/2/19>. Pages: 67-71. Hungary, Europe
30. BB Baymetov, D Omonov. Talabalarga shakllarni masofadan koʻrish va tasvirlashga oʻrgatish jarayonida pyerspyektiva qonunlaridan foydalanish malakalarini shakllantirish. Science and Education 2 (4), 615-623
31. Pardaboy Khudoiberganov Botir Boltabayevich Baimetov. Use The Theoretical Foundations Of Color Science In Teaching Students To Work With Educational Productions From Painting. The American Journal of Social Science and Education ... The American Journal of Social Science and Education Innovations 3 (3), 330-337





**ACADEMICIA**  
**An International**  
**Multidisciplinary**  
**Research Journal**  
(Double Blind Refereed & Peer Reviewed Journal)



DOI: **10.5958/2249-7137.2021.01211.8**

## **THE USE OF MODULAR LEARNING TECHNOLOGY IN TEACHING PRIMARY SCHOOL STUDENTS TO THINK INDEPENDENTLY**

**Marguba Mirqobilovna Mirqosimova\***

\*Professor of the Islamic Academy,  
UZBEKISTAN

### **ABSTRACT**

*In fact, modern pedagogical technologies increase the productivity of the educational process, shape the independent thinking process of students, increase the enthusiasm and interest in knowledge in students, and strengthen the acquisition of knowledge, the formation of skills and skills of free use of them in practice. Teaching students to think independently is a process that is not carried out in one day or one hour of classes, but is carried out gradually over the years under the influence of various factors. This article discusses the use of modular learning technology in teaching primary school students to think independently.*

**KEYWORDS:** *Modular Learning Technology, Independent Thinking, Teaching, Primary School Students, Formation Of Skills.*

### **INTRODUCTION**

The use of modular educational technology in teaching primary school students to think independently, preparing them for the implementation of modern pedagogical technologies is one of the important requirements of today's primary education. Modern pedagogical technologies, firstly, allow students to learn knowledge, skills and abilities easily and with interest, and secondly, help the teacher to grow both professionally and spiritually. When does a student begin to think independently? The question naturally arises. First, it is necessary to know the stages of formation of the human thought process. The process of human thinking is formed in the process of observing life, people, relationships between them, nature through the senses. From the moment a child is born, he begins to see, observe and absorb life, adult activities, events and phenomena in nature, and as a result, he develops imagination and speech. At the same time, the child acquires a lot of imagination based on the information collected through the senses, and tries to understand it. So they have a lot of questions. For example, *what is in the*

*sky? Why is a day and a night? Why do birds fly? Why am I small? Why are the colors different? Why is it raining and snowing? What about clouds? and so on.*

A mother told of her three-and-a-half-year-old son: "One day my son asked me this question:

*- Mother, why are our noses different? Mine is flat, yours is upright, my sister's is different? Not knowing what to say,*

*"That's the way it is, son," I said.*

*"Who made it, the doctors?" Do they cut and paste?*

*"No, boy, God made it."*

*"How does God do it?"*

*So my son beat me in question and answer. I didn't know what to explain. I tried to distract my child. My son kept asking questions.*

Indeed, children constantly ask their parents questions in their preschool years. Answering the child's questions patiently helps him/her to think, to understand events, and to develop his/her speech. In preparation for school, a child's speech is formed at the level of reading and understanding people's interactions with adults. He can understand what he has heard and seen. He can express information in a certain order, use mental operations appropriately. (Compares, clarifies, groups them, tries to draw valid conclusions).

The level of thinking of a preschool child improves in the educational process at school. The role of the teacher in the development of students' thinking is invaluable. The teacher needs to make students active participants in the learning process. It is especially important to teach students to think about what they are learning and to express themselves freely. The use of pedagogical technologies in the educational process is very effective. The student actively participates in the lesson, which is based on pedagogical technologies, and interacts freely with the teacher and peers. In particular, person-centered technology makes students the subject of the learning process and allows students to think freely about the material. The role of modular learning technology in this area is invaluable. The use of didactic games in the educational process is also very effective. Didactic games help children develop reading skills. There can be no real mental development without games. The game sparks students' interest and curiosity. Students facilitate the acquisition of knowledge, learn to interact with a variety of subjects, and develop a culture of communication through games. It is important that in the process of didactic games the child develops self-confidence, learns to move freely, to express themselves freely, to express independent thoughts. For example, in the game "Find the mistake in the picture" the child observes the picture independently. If a picture of a winter landscape shows a tree in bloom, the child will find it independently. The games such as "can't be", "find the error in the text" games, rebuses, and puzzles stimulate students' thinking and teach them to think independently. Exercises to work on the picture in the textbook also teach students to think independently. The child expresses his / her attitude to the picture, actively participates in questions and answers, and when given a task to write a story based on a picture, he / she writes a story based on his / her imagination. There are many opportunities to teach a child to think independently in elementary school, and it makes good use of it wisely. Guiding students to work on a text is one of the most effective ways to teach them to think independently.

Textbooks for primary school should also encourage students to think independently through exercises, questions, and assignments at the end of the text. For example, "Who is reciting the poem?", "How can you add to the poem?", "Do you want to be friends with the protagonist of the story (or fairy tale)?", "What advice would you give to the protagonist of the story?" , "Do you want to be in a fairy tale?", "Who do you want to be in it?". Questions such as "Divide the text into parts and put a title to each part", "Make a text plan with the help of the teacher", "Re-narrate the text according to the plan", "Re-narrate by changing the characters in the text" and so on assignments serve to develop students' thinking and independent thinking.

## **MATERIALS AND METHODS**

### *Current status of the use of modular learning technologies in primary education*

To increase the activity of teachers in the use of modular learning technology and, conversely, to identify the reasons that hinder it, to look for more effective ways to work on the basis of the use of modular learning technology. The information gathered on these issues will help the school teacher to enrich the pedagogical activity with elements of the use of modular educational technology and to identify a number of measures that will help it to be effective. An in-depth study of the specifics, differences in structure, and character traits of experienced teachers based on the use of modular learning technology. When evaluating the performance of teachers with the skills to use modular learning technologies, a positive description will undoubtedly prevail. Young teachers consider the specific features of the use of modular educational technology in the methodological support of pedagogical activity, the correct application of psychological and pedagogical knowledge. Experienced teachers emphasize the importance of using modular teaching technology in their work, which can be understood through in-depth analysis of the pedagogical situation, along with methodological support.

Working on the use of modular learning technology, methodological support is paramount, and the importance of knowing, explaining, communicating, and engaging students in modular learning technology is highly valued. Skilled teachers have a slightly different situation. They consider the reasons for success to be: the ability to use modular learning technology, regular self-study, problem-solving based on modular learning technology, and research on professional development. They prioritize the use of modular learning technology, which is one of the foundations of pedagogical skills and need to work on themselves on a regular basis.

The study of the peculiarities of the organization of pedagogical activity of skilled teachers on the basis of the use of modular educational technology has yielded the following results:

- a) compare the methodological skills of experienced teachers;
- b) be able to intelligently analyze the pedagogical situation;
- c) specificity in the use of modular technology.

In this context, we have identified differences in understanding the nature of the use of modular learning technology, its sources of development, its causes, and the factors that contribute to or hinder the use of modular learning technology. In order to make the comparison more effective, we had to conduct an initial selection in a group of experienced teachers. For comparison, we selected only those that were rated "based on the use of modular learning technology" and "generally based on the use of modular learning technology."

Comparing teachers who have a lot of experience with experienced teachers and who have achieved high results in this area, by identifying the differences between them, which of them has the highest pedagogical skills, the work of educators who have earned the title of a skilled teacher an in-depth analysis of its specific features was made possible. In addition, the specificity of the scope of attitudes of skilled teachers stems from a clear perception (lat. perception) of their inner state of mind and actions, a clear knowledge of their own personality and the personality of the student. The results show that the teacher's organization of the educational process on the basis of the use of modular learning technology depends in many respects on his self-reliance, knowledge, good knowledge of pedagogical features and the teacher's modular learning technology.

*The essence and description of the concept of modular training.*

The term "modular teaching" is related to the international concept - module ("module", from the Latin word "modulus" - means a norm, a measure.) The module divides the subject studied in the educational process into specific parts and creates a clear system of its study. A single meaning of a module is a node consisting of closely related elements that can function. In this sense, it is understood as the main tool of modular learning, as a complete block of information.

A module is a fundamental concept of a science: a specific process or law, a section, a specific major topic, a group of interrelated concepts.

A module is a logically complete learning material based on developed principles that are designed to help students master one or more concepts.

A module is a purposeful functional network that combines learning content and learning technology in a highly integrated system [Kaldibekova, 2006].

A module is a logically complete piece of learning material that compulsorily monitors students' knowledge and skills [Stolerenko, 2003].

A module is a logically defined piece of learning information that has some kind of logical integrity and completeness, synchronized with knowledge control.

By module we mean a didactic unit of learning material that logically completes and perfectly illustrates important aspects of the objects, with a clear goal in mind for a particular subject [Nuriddinov, 2002].

Modular learning is a logically defined part of educational information that has some kind of logical integrity and completeness, coordinated with knowledge control [Stolerenko, 2003].

An educational module is a meaningful part of a course of study, along with relevant teaching materials.

Curriculum module - instructions for studying the timing of each assignment, methods of control and accounting, study of teaching materials (paragraph, topic, section, subject, integrated course). In a more simple and unique way, the training module reflects the topics (sections) of the usual curriculum, along with more reasonable forms and methods of learning it [Podlasiy, 2002]. Modular learning is one of the most promising systems of learning because it is best adapted to the assimilation system of the human brain. The modular system of education was first officially discussed in 1972 at the UNESCO World Conference in Tokyo. Modular learning

technology is based on the general theory of functional systems, neurophysiology of thinking, pedagogy and psychology.

Modular teaching provides a comprehensive solution to the following modern problems of pedagogical education:

- module - optimization and systematization of activity-based learning content to ensure the flexibility and flexibility of programs;
- individualization of teaching;
- Monitoring the effectiveness of training at the level of practical training and assessment of observable actions.

There are two approaches to modern theory and practice of modular teaching: the science approach and the system approach.

The effectiveness of teaching is enhanced when the module program is provided to the student as a textbook for independent reading for continuous use during the reading of the block of learning material included in the curriculum.

The structure of the module manual reflects the following design requirements and rules:

- An integrated goal included in the quality classifications (personal and cognitive) as a result of modular reading.
- Clarification of the purpose in the "learning elements" of the subject given in the educational standard.
- study of the module, programs and recommendations on technological methods.
- Clarification of goals in the final control tasks on the standards and criteria of mastery levels.
- Standards for the organization of self-control and mutual control.

Features of the implementation and design of modular technology in the classroom.

## **RESULTS AND DISCUSSIONS**

The organization of educational activities on the basis of separate modules in the educational process creates great opportunities for the student to acquire independent, planned knowledge and self-development as a subject of educational activities. Applying modular technology to practice requires the teacher to be familiar with the principles of modular learning:

### **Principles of modular education**

Modular learning technology is developed and implemented in accordance with the accepted principles of teaching. The following principles form the basis of modular learning technology:

**1. Principle of activity:** This principle means that the modules are formed in accordance with the content of the activity of the specialist.

According to this principle, modules can be based on a science-based approach or a systematic approach. Modular learning technology requires a science-based approach to building modules as a result of curriculum and program analysis. In the systemic activity approach, a block of modules is formed based on the analysis of the professional activity of the specialist.

**2. Equality, the principle of equality.** This principle determines the nature of the subject-subject relationship between teacher and student.

This suggests that modular learning technology belongs to the category of person-centered technologies. The modular learning technology is adapted to the individual psychological characteristics of the individual.

**3. The principle of system quantization.** This principle is based on the requirements of the theory of information compression, the concept of pedagogical knowledge, theories of enlargement of didactic units. In addition, this principle requires consideration of the following psychological and pedagogical laws:

- A large amount of learning material is remembered with difficulty and reluctance;
- Abbreviated learning material in a particular system is easier to master;
- Highlighting key elements in the learning material has a positive effect on memory.
- The basis of the teaching material should be scientific and fundamental.
- The principle of system quantization is achieved by building the appropriate structure of educational information in a module.
- The module can generally consist of the following elements:
  - historical - is a brief description of the history of the problem, theorem, problem, concept;
  - problematic - the formation of this problem;
  - systematic - this is a systematic representation of the content of the module;
  - Activation is the identification of key phrases and actions needed to master a new learning material;
  - Theoretical - this is the main educational material, which - didactic goals, problem statement, hypothesis (hypothesis), ways to solve the problem;
  - experimental - is the description of experimental material (learning experience, work, etc.);
  - Generalization - is the generalization of the image and module content of the problem solution;
  - Application - the development of new methods of action and a system of issues for the practical application of the studied material;
  - Errors - to identify, identify the causes of mistakes of the student in the study of the content of the module, and to show ways to correct them;
  - Connection - to show that the passed module is connected with other modules, including related disciplines;
  - Deepening - providing highly complex learning materials for gifted students;
  - Testing - monitoring and evaluation of students' mastery of the content of the module by means of tests.

It is important to understand the practical significance of the module during the lessons, the relevance of the content of the module to other modules, the analysis of the same mistakes of students in the study of this module.

4. **The principle of motivation.** The essence of this principle is to stimulate the learning process of the student. This is the basic rule.

The tasks of the historical and problematic elements of the module are to arouse interest in the learning material of the module, to stimulate learning, to encourage active creative thinking during the lessons.

5. **The principle of modularity.** This principle is the basis for the individualization of teaching.

First, the dynamic structure of the module allows the content of science to be presented in three ways:

- full;
- abbreviated;
- Deepened.

The choice of this or that type of teaching is left to the student.

Second, modularity is reflected in the mastery of the content of the module, as well as in the variety of methods and forms. These can be active forms and methods of teaching (dialogue, independent reading, reading and simulation games, etc.), as well as problem-based lectures, seminars, consultations.

Third, modularity is provided in the step-by-step acquisition of new material, meaning that teaching in each subject and in each module is oriented from simple to complex.

Fourth, due to the flexibility of the learning elements included in the module, it is possible to regularly update the learning material.

6. **The problem principle.** This principle allows you to increase the effectiveness of the learning material, as it focuses on problem situations and practice. During the lesson, a hypothesis is made, its validity is demonstrated, and the problem is solved. First of all, this is what interests the reader, it stimulates creative thinking and activity.

7. **The principle of cognitive visualization.** This principle stems from the psychological and pedagogical laws, according to which educational exhibitions increase the productivity of learning only if they perform the function of painting, as well as cognitive function.

That is why cognitive graphics is a new problem area in the theory of artificial intelligence, where complex objects are represented in the form of computer images. The structure of the module consists of colorful, cognitive-graphic learning elements (picture block). Images are therefore a key element of the module. This is:

First, it develops the student's ability to see and think in space, which means that the learning process is enriched by the rich possibilities of the brain's right hemisphere.

Second, a picture that clearly illustrates the content of the learning material helps the student to form systematic knowledge.

Thirdly, color pictures increase the effectiveness of the reception and recall of educational information material, as well as serve as a means of aesthetic education of students.

Learning is like using two mechanisms of thinking: one is symbolic and the other is geometric (algebraic). Visual information is more important and effective than verbal information. The ability of the visual cortex to receive information is much higher than that of the auditory cortex. This, in turn, allows the visual system to transmit about 90 percent of the information a person receives. In addition, visual information is provided at the same time. Therefore, it takes less time to receive and remember information than verbal information. When visual information is used, the formation of imagination is on average 5-6 times faster than verbal. Human exposure to visual information is much higher than to verbal information. In most cases, he misses the last one. Repetition of visual information is easier and more accurate. People have more confidence in visual information than in verbal information. That is why it is said, "It is better to see once than to hear a hundred times."

## CONCLUSION

We conclude that the following results can be achieved when using modular learning technology to teach elementary students to think independently:

1. The possibility of modular learning - "dosing" of the material, combining it with the individual characteristics and abilities of students, special selection of material, the combination of information-cognitive and educational tasks, the principle of compulsory assessment, a great contribution to it. The provision of flexibility, flexibility, diversity allows for a high level of organization of professional practice and the approximate introduction of bachelor students to the cultural and socio-pedagogical reality.

2. Modular teaching provides an opportunity to comprehensively address the following modern issues of pedagogical education:

- module - optimization and systematization of activity-based learning content to ensure the flexibility and flexibility of programs;
- individualization of teaching.

## REFERENCES:

1. Kaldibekova A.S. Modular learning technology and its features. // Collection of scientific-methodical 24 chapters. CH.6. - p. 45.
2. Stolerenko L. D. Pedagogy. - Rostov-on-Don: Phoenix, 2003. - p. 274.
3. Nuriddinov B.S. The use of active teaching methods in professional development teachers of vocational education: candidate of pedagogical sciences. ... diss. Abstract of thesis. - T., 2002. - p.13.
4. Stolerenko L. D. Pedagogy. - Rostov-on-Don: Phoenix, 2003. -- p. 58.
5. Selevko G.K. Pedagogical technologies based on didactic and methodological improvement. - M.: Research Institute of School Technologies, 2005. -p. 58.
6. Podlasiy I.P. Pedagogy. - M.: Higher education, 2006. -- p. 379.



8. Avliyakov N.X., Musayeva N.N. Modular technologies for teaching professional subjects in vocational colleges. Study guide. - T.: Yangi asr avlodi, - 2003. – p.88
9. Azizxodjayeva N.N. Pedagogicheskiye tekhnologii i pedagogicheskoye masterstvo. - Tashkent: Finance, 2002.
10. Belouxin D.A. The basis of personality-oriented pedagogy. -M.: Voronezh, 1997. – p.92
11. Bepalko V.P. Slagayemiye pedagogicheskoy tekhnologii. - M: Nauka, 1989. – p.192
12. Bondarevskaya, Ye.V. Gumanitarnaya paradigma lichnostno-oriyentirovannogo obrazovaniya // Pedagogika. - 1997. - №4. - p.11-14.
13. Borodina N.V., Samoylova Ye.S. Modular technology in professional education: Texbook. - Yekaterinburg.: UGPPU, 1998. –p.27
14. Davletshin, M.G. Module technology training. - T: TGPU, 2000.
15. Nishonaliyev, U.N. Modulniye pedagogicheskiye tekhnologii.- Professionalnoye obrazovaniye. M: 2002. - № 14. - p. 10-12.

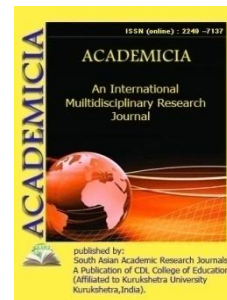
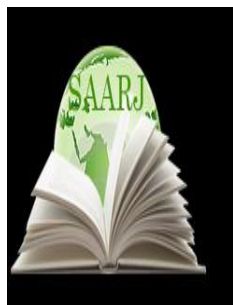

DOI: **10.5958/2249-7137.2021.01212.X**

## PROVERBS AND THEIR MORPHOLOGICAL SYSTEM

Nargiza Rustamovna Umarova\*; Odina Uktamovna Kholmatova\*\*

\*Associate Professor,  
Department of Linguistics, Fergana State University,  
UZBEKISTAN

\*\*Independent Researcher,  
Fergana State University, UZBEKISTAN

### ABSTRACT

*This article discusses the proverbs as paremic units, their features, differences from related phenomena, the study of Uzbek folk proverbs and morphological system. The environment is a complex object of perception for human beings. A nation's way of life cannot understand the diversity of the surrounding reality throughout its life, adapt to it, and develop acceptable ways of living. So at this time wisdom was used in its own sense, it was considered a parable. Over time, as a result of idiomization, it became a proverb. Therefore, "some parables will be changed into a proverb when time goes"(B.Saatov) [15: 7]. Although both mosquitoes and ants are insects, we can see that there is a positive evaluation of ants and a negative evaluation of mosquitoes.*

**KEYWORDS:** *Paremic Units, Proverb, Parable (Saying), Phrase, Lexical System, Conversion, Valence*

### INTRODUCTION

Proverbs that have been attracting the attention of scholars for many years have been studied as the object of study of folklore and ethnography, in linguistics by scientists such as Sh.Rahmatullaev [1], Ya.Pinkhasov [2], G.Salomov [3], Q.Samadov [4], Sh.Shorahmedov [5], H.Abdurahmonov [6], M.Sadriddinova [7]. H. Abdurahmanov's doctoral dissertation is aimed at covering the syntactic structure, morphological and some spiritual and methodological features of proverbs and sayings in the Uzbek language [8:20]. The lexical features of folk proverbs and sayings have been studied comparatively by M. Sadriddinova in the lexical scope of literary languages and dialects.

## MATERIALS AND METHODS

Recently, folk proverbs have been widely covered in many works on the language and style of the works of writers and poets in Uzbek linguistics. In this regard, the scholars such as A.Rustamov, H.Sulaymon, Sh.Shomaksudov, Sh.Shorahmedov H.Berdiyev, R.Rasulov, M.Abdurahimov, R.Jumaniyozov, A.Kholmukhamedov [9], V.Abdullaev, H.Doniyorov, S. Mirzaev [10: 122], S.Askarov [11: 19-22], A.Jurahanov [12: 52-55], M.Tuychiev [13: 84-87], M.Hakimov [14: 176] can be mentioned.

A synonymous dictionary of folk proverbs in Uzbek linguistics was compiled by B. Juraeva [15]. This dictionary was compiled on the basis of synonyms of ordered paremic units, can be considered as a prelude to lexicographic works to be created in this direction.

The environment is a complex object of perception for human beings. A nation's way of life cannot understand the diversity of the surrounding reality throughout its life, adapt to it, and develop acceptable ways of living. Proverbs, which convey all the achievements of man and nature, the relationship between man and society, as well as a unique means of self-understanding, culturally define, summarize, and record all the information necessary for human life.

In the Uzbek language, wise sayings are generally called proverbs [16: 5], however, more than a dozen terms are used to express this concept such as: "*maqol, matal, masal, naql, hikmat, tanbeh, Zarbulmasal, hikmatli maqol, xalq iborasi, xalq so'zi, donishmandlar so'zi, donolar so'zi, yaxshilar so'zi, burungilar so'zi, ulusning so'zi, avomunnos masali, hikmatli so'z*" which convey the meaning of proverb, parable or sayings [17: 6]. Folk wisdom is part of a system that is completely dependent on man, his choices and his values, what man considers being the norm for himself [18: 180].

The terms proverb and parable are almost indistinguishable in the scientific literature. Even though in some sources they are distinguished as types of paremas, it is possible to find places where the interpretation of proverbial and parable terms is confused [17:12]. In classical literature, the term "*maqol*" (proverb) refers to the concepts of word, speech, [19: 234], and the term "*masal*" (parable) is used to express the concept of proverb [19: 237]. For example, in a text that uses proverbs in classical poetry, combinations such as *masaldurkim, masalkim, masal budur* mean proverb. In his famous work *Zarbulmasal* of Gulkhani used the term "*masal*" (parable) in the sense of a proverb, so historically the term parable can be understood as the equivalent of a proverb.

In linguistics, it is expedient to limit proverbs and sayings by meaning, as they differ from each other in the nature of the expression of the message conveyed.

If the medium of communication in speech is a proverb, then the parable is used as a means of conveying this information in vivid symbols, proving it. The different situations are described figuratively and their didactic nature goes unnoticed in proverbs. Proverbs, on the other hand, have an educational aspect, and most such units differ from proverbs in that they express the content of advice, commands, and insights. For example:

Maqol (proverb): "*yirtiq uyni el topar, yolg'on so'zni chin topar*" yoki "*maddohning va'ziga ishonma, g'olibning – so'ziga*".

Matal (parable): *"uyida chaksa uni yo'q, tom boshida qo'sh tandir"*.

Proverbs are short, concise folk sayings that are used in a sharp, figurative sense, expressing a grammatically complete idea. Parables, on the other hand, are short, concise folk sayings that express a grammatically complete idea, used only in its own sense - in the true sense. The main difference between proverbs and parables is that proverbs have an idiomatic figurative meaning, and parables do not have this feature, but are used only in the correct sense [15].

## RESULTS AND DISCUSSIONS

As in society, when several units are used side by side, as in language, they can be in interaction with each other, and as a result of this attitude, one can observe silks towards each other. In the Explanatory Dictionary of Uzbek folk proverbs define the proverb *"qarg'a qarg'aning ko'zini cho'qimaydi"*, which was presented in the F.Makrobiy's "Grammar": *"qarg'a-quzg'unlar odamning yo biror hayvonning ochiq erda qolib ketgan murdasini qo'rib qolsa, avval uning ko'zini cho'qib erkan-da, keyin go'shtini eya boshlar ekan. Ammo tirik qarg'a va quzg'un o'lik qarg'a va quzg'unning ko'zini cho'qimas ekan"* (meaning: If the crow or raven sees a died body of a man, or an animal, which has remained in the open ground, they first drown his eyes, and then begin to eat his meat. But, when the crow or the raven is dead, and the eyes of the crow or the raven's is not be crowned" [20:321]. So at this time wisdom was used in its own sense, it was considered a parable. Over time, as a result of idiomization, it became a proverb. Therefore, "some parables will be changed into a proverb when time goes"(B.Saatov) [15: 7]. Another situation is that some proverbs have changed lexical composition and new variants have appeared. For instance, the proverb *"mushk isi yashursa bo'lmas"* used in the works of Navoi, has used now as *"kasalni yashirsang, isitmasi oshkor qiladi" shaklida qo'llanadi"* [21:20].

The language units called proverbial-type paremas also exist separately, reflecting the characteristics of proverbs and parables. The features of such expressions are that some of them are used in their own sense, while the other part has a figurative meaning: *"Oltinning yaxshisi – yantoq, xotinning yaxshisi – qalmoq"*.

In proverbs, *oq, qora, ola, qizil, sariq, ko'k*, (white, black, purple, red, yellow, blue) which represent the color; *keng, tor, uzoq, yaqin, olis, engil, og'ir* (broad, narrow, long, close, distant, light, heavy) to represent size and character; *aqli, dono, ahmoq, nodon, epchil, chaqqon, chiroyli, xunuk, do'st, dushman, xom, semiz, oriq, baxil, saxiy, bemor, kasal, sog'* (smart, wise, foolish, ignorant, agile, agile, beautiful, ugly, friend, foe, raw, fat, thin, stingy, generous, sick, sick, healthy) to represent size and character; lexical units such as *"kar, ko'r, kal, soqov"* (deaf, blind, deaf, dumb) were used to represent physical defect of the category of quality. For example: *"Kal o'zini ovutar, qo'ltig'ini sovutar"*.

Qualitative lexemes as a person, animal, plant, status sign specify the meaning of the noun lexeme: *zo'r, qimmat, bilimli, bilimsiz, yaxshi, yomon, to'g'ri, olim, zolim, mehnatsiz, ilmsiz, ilmli, bedov, kuchli, tekin, bop, tikansiz, mashaqqatsiz, ulug', olchi, yalangoyoq, quruq, jafoli, vafoli, xor, hunarli, do'st, dushman*. (excellent, expensive, knowledgeable, ignorant, good, bad, right, scientist, tyrant, hardworking, ignorant, knowledgeable, strong, free, bop, thornless, effortless, great, cherry, barefoot, dry, cruel, faithful, crafty, friend, enemy).

In proverbs composed with the adjectives, character-traits and signs of physical defect appear as basic lexemes. This feature occurs in exchange for most conversions. For example: *Kalning nimasi bor – temir tarog'i, ko'rning nimasi bor – eski tayog'i*.

The following words can be used as the most commonly used verbs in proverbs: *yemoq, kelmoq, qaramoq, yo'rg'alamoq, yurmoq, o'tirmoq, bermoq, olmoq, tortmoq, ko'rinmoq, ko'rmoq(harakat fe'llari); o'ylamoq, bilmoq, bilmoq, o'rganmoq (tafakkur fe'llari); yig'lamoq, sasimoq, yog'moq, o'lmoq(holat fe'llari); so'ylamoq, so'ramoq, maqtamoq, demoq, o'qimoq(nutq fe'llari); bosmoq, ekmoq, sug'ormoq, o'rmoq, tutmoq, eshitmoq, ayamoq,saqlamoq, siylamoq, yuvmoq, cho'zmoq, o'lchamoq, yashamoq (mashg'ullik fe'llari. Masalan: nomard yovga yalinar,mard kuchiga suyanar.*

The grammatical basis of a sentence is a set of verbs in folk proverbs. In this case, the verbs serve to syntactically form the sentence. In proverbs, verbs are mainly devoted to the cut function. Adjective and action noun forms adapt the verb to the syntactic function of other word groups. The relative forms of the verb, on the other hand, are very few.

The use of numbers, rhymes, and pronouns in proverbs is quite limited. A number leads in proverbs. This remains due to the polysemantic nature of a number. One and two lexemes serve to form proverbs in the context of comparison. In proverbs where one number is used, the numbers such as “*uch, etti, qirq, yuz, ming, tuman*” (three, seven, forty, one hundred, thousand, much) are also used. There are also examples where some proverb components are selected only from a number of word groups. In this case, the phenomenon of conversion can be observed: *Birniki – mingga, mingniki – tumanga*.

The proverb “*bir pashshag'a olamda etkurma zarar hargiz*” (meaning: *Never harm a fly in the universe*) from Navoi's byte has been transformed in Mashrab's work. Let's compare... “*Bas kishiga tekmasun xavfu xatar, mo'rg'a ozor bermas yaxshilar*”.(Meaning: *So it's better not to hurt anyone, not to hurt*)

If we semantically compare the proverbs used by both poets, both variants of folk wisdom differ according to the shades of meaning. Although both mosquitoes and ants are insects, we can see that there is a positive evaluation of ants and a negative evaluation of mosquitoes. If we analyze it from the point of view of this relationship, it is not difficult to see that the byte, which is the product of Navoi's, has a significant role, as it should not offend not only the harmless, but also the mosquito. This shows that we can achieve the disclosure of the semantic aspects of a literary text through the most delicate linguistic analysis.

The proverb “*Qizni kim sevmas, qimizni kim ichmas; kelin ketag'on bo'ldi, ovul kezag'on bo'ldi*” has long been considered the beauty of language, as an example of folk wisdom, such as the bride was gone, the village was gone.

## CONCLUSION

The compact size and meaning is a product of the people's spirituality and intelligence. The use of proverbs in speech, first of all, leads to the enrichment of content, increasing the impact, and on the other hand, ensures the popularity of speech.

**REFERENCES:**

1. Rahmatullaev Sh. Nutqimiz ko'rki. –Tashkent: Fan, 1970.
2. Pinxasov Ya. On the phraseology of the Uzbek language. –Tashkent: Fan, 1957.
3. Salomov /. Language and translation. –Tashkent: Fan, 1966.
4. Samadov Q. Oybek's language skills. –Tashkent: Fan, 1981.
5. Shorahmedov Sh. On the emergence of proverbs // "Uzbek language and literature". 1971, issue 4. - p.31-34.
6. Abdurakhmonov H. Syntactic features of Uzbek folk proverbs. AKD. –Tashkent: Publishing house of the Academy of Sciences of the Uzbek SSR, 1964.
7. Sadriddinova M. Vocabulary Uzbek proverbs and sayings. AKD. –Tashkent, 1985. –20
8. Abdurakhmanov Kh. Features of the syntax of Uzbek oral folk art. ADD. - Tashkent, 1977. -- 48
9. Rahmatullaev Sh. Nutqimiz ko'rki. T., 1970; Rustamov A. Word for word. - T., 1987.
10. Abdullaev V., Doniyorov X., Mirzaev S. The story of brave people // Sharq Yulduzi, 1960. – № 2. - p.115-122.
11. Askarov S. Some issues of folklore in Qadiri's works // Uzbek language and literature, 197. - №1 issue. - 19-22.
12. Jo'raxonov A. Muqimi's skill in using folk proverbs // Uzbek language and literature, 1974. – № 4. –p. 52-55.
13. Tuychiev M. The use of folk proverbs and sayings in the novel "Shinelli years". Research on Uzbek phraseology. SamDPI works. - Samarkand, 1971. - p. 84-87.
14. Hakimov M. Writer and the language. - Tashkent: Fan, 1971. - p. 176.
15. Jo'raeva B. A brief synonymous dictionary of Uzbek folk proverbs. –T. : Fan, 2006.
16. Uzbek folk proverbs. –T., 1981.– p.5.
17. Berdiyev H., Rasulov R. Paremiological dictionary of the Uzbek language. - T. : Teacher, 1984. - p.6.
18. Khairullina D.D., Khuzina E.A. Ethical assessment in proverbs and sayings (based on the material of the English, Russian and Tatar languages). // In the world of scientific discoveries, No. 5-3 (41), 2013. - p. 180.
19. Berdaq Yusuf. Dictionary of Classical Literary Works. - T., 2010. - p.234.
20. Shomaqsudov Sh., Shorahmedov Sh. Annotated dictionary of Uzbek proverbs. Why do we say that. - Toshkent, 1988. - p. 321.
21. Umarova N Alisher Navoi - master of artistic expression. - Fergana, 2010.
22. Umarova N. Semantic and stylistic features of Uzbek folk proverbs based on phytonims. International scientific journal ""Scientist of the XXI century". Moscow. 2016, issue 7. - p.47-50.



**ACADEMICIA**  
**An International**  
**Multidisciplinary**  
**Research Journal**  
 (Double Blind Refereed & Peer Reviewed Journal)

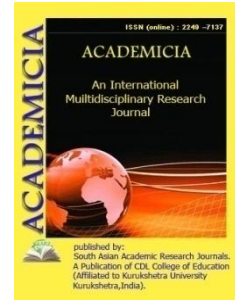

**DOI: 10.5958/2249-7137.2021.01206.4**

## INDIA NEEDS TO FOLLOW A COMPREHENSIVE POLICY TOWARD PROTECT SECULARISM: A CRITICAL ANALYSIS

**D. Sendhil kumar\***

\*Research Scholar

UMISARC, Centre for South Asian Studies,  
 Pondicherry University, INDIA

### ABSTRACT

*Ideology of Secularism was framed by India's freedom fighters and legislators based on the location, structure and types of India's culture and religion for protect multi –people interests. Basically, India is a country where diversified people are living with diversified interest and happiness .The government and its policy should be guardian of all religion without creating stumbling blocks to interest and welfare any religion habits, customs and convention .Because, once this formula was broken by an any anti-social elements or wrong government policy it would be highly and deadly dangerous to secularism and India's integrity. To avoid these kinds of forth coming dangerous of anti-secularism activities from the any community and political parties, the government needs to adhere strictly a common wheel polices and approaches irrespective of the caste, class and religion .The vision of India's ancestor on secularism is to make a pivotal parts of India's government that should be looked frequently by the ruler and administrator to ensure the integrity of India and protect secular identity of various people. This type of oversee attitudes of ruler and administrator makes people to feel that they are part and parcel of multi religious country of India without socio ,economic and political draw backs . In India there are lot of anti –secularism and minority violence are increasing from the government side instead of arising from the people side .In old days policies were legislated for integrate people interest for maintain ideology of secularism. The present government is treating and enacting policy against the secularism and minority communities on account of minority people could not do any think against majority community. Therefore this study has been focusing on importance of secularism for the integration of India's in future as well as at present and suggests to accommodate minorities' interests and stop killing them in India.*

---

**KEYWORDS:** *Anti-Secularism Policy, Anti-Minority Attacks, Human Rights Violations And Breaking The Islamic Community Relations.*

---

## INTRODUCTION

The core principle of the secularism in India is to accommodate the multicultural, ritual, interest, caste and religion along with elaborated policy for enable all people to grow on equilibrium platform irrespective of socio, economic and political differences and status. There are happening so many atrocities and gruesome events in India against secularism ideology with aim to split multicultural integrity .In which the innocent and minority people have been suffering much more as unanswerably by anti-people attacks of the government and polices since 2014 to 2015.This is very ruthless activities of ruling government over the minority development and life in India. In ancient days politics were run by the ruler toward defeat the enemy and exploit other country resources ,this barbarian ruling culture was vanished and changed after people and world community woke up to know their rights for get freedom and run independent life in the civil society of the world .

People awareness let to disappear the inter country war and exploitations of other country resources. Now India's ruling party and upper community people forcing entire multicultural people to go to above said ancient social status by iron control , armed attacks and political pressure over the minority to keep salve to dominant community and submissive to their arrogant political activities. In fact ,the minority People were cheated by the political party bearers and leaders to attain the political power by the duplicate political manifesto .Due to this ruling party pressures and atrocity minority people liked an alternative ruling party in India but they don't know that elected alternative party known as upper caste people will enslave them under the majority community to their political ambitions or crush down them to follow upper people food habits by beating ,killing and humiliating .

These inhuman activities and polices have been practiced by the ruling government along with inclination to enslave minorities like ancient civil setup for keep them at upper caste control and arms .Since beginning of the new government to rule over the India from 2014-2015 ,its ant-secularism and anti-minority policy have been affecting the minority people from basic life to politics .The policy of today government absolutely seeming to be inciting communal violence through the their caste party bearers .Their attitudes are focused at preventing the life growth of minority people ,motivating inter community caste feelings and fights in each villages of India. All these ruthless politics and policy of the majority community have been destroying the minority life that they got after 69 years through the hard labors from the slavery setup society of India's .All this causes made them to understand so much about the ruling government activities of community breaking, disturbing people peace and escalating communal violence as minority people could not develop and progress.

The gruesome policies and caste based activities of the majority over the minority are being as a serious threat and panic to be daily life of minority people in India as well as India development .the majority community activities have been resulting at serious destruction way minority people like rapping girls ,making nude minority girls ,giving corporal punishment unless they obey to their local politics ,chopping minority people regarding to lower people love over upper people to show their mighty and showing of bravery affecting attitudes over on the minority community in nuke and corner of the India's villages .For all these their frivolous and fearless



activities have been tolerated by the minority community and Islamic people since they are as powerless, propriety less and socially feeble community .

Still from the central to state the minority people have been attacked by the ruling party on account of caste and food habits differences .No political leader from the central and state have never raised their voice to protect them in India .Because, all major political party leaders of India's are belongs to upper caste people who have no sympathy or courtesy on this issues. Majority people like to rule the minority people through their violence. Their political agenda is not to let other for live or use political benefits and economic advantages than keeping slave other caste people and preaching their caste principles to rest of people in India.

### **Improper policy impinging on minority community life**

Now days India's policies are toward disturb, disintegrate and destroy the minority community people life and development all these policies were disrespected by the like Muslim, Dalit,Sikh, Tribal and fisherman community. Through their arrogant policy they would like to reinstate ancient slavery system omitting all the modernly emerged developments .Except all other community in India the minority people alone have been creeping toward socio-economic and political development after 69 years while rest of community and caste in India have attained socio-economic and political status before 1947.

Indeed ,the inapt policy of the present government shows its intolerance over the minority community developments in terms of social ,economic and political institutions .Generally, the ratio of the minority community people in India constitutes more than 65 percentage unless their cooperation India could not have become as a shining country and protected secularism ideology .So ,the minority people hard work at agriculture land alone have made India as shinning country and kept majority people at sophisticated life since the minority people do not have a respectable social status and money power to rule the people .None of policy of the so many government in India do not keep survive the minority people as happily as stress free .In fact the ruling community have been living at the sweat of the minority hard labor and they tasted their daily enjoyment of socio-economic and political benefits through the minority community traditional bondage works to India's developments .

So, based on this horrible and heart renting minority socio-economic and political position ,the present government needless to do service to them but it may be calm not disturbing ,infuriating ,inciting communal violence and inter caste fight at the India's villages .Because ,the minority people have felt now only that their untouchable fight was over with majority community in India after long decades, reversely to this, the present government perpetuating the same fight has to come to be soil of the India for break the multicultural unity and integrity .Indeed ,past two years the minority people are facing so many consequence of the intercaste, fight ,love issues ,honor killing and power sharing at government places .

All these incident took place duet to present government policy motivation and the higher caste people dominating policy counseling's to India's officers (the times of India 5 Oct, 2015). This kinds of unsecular policy of India's upper community people and government highly attempts to break the secularism and makes the minority to feel as an unattached with secularism ideology. In fact, the government irrational polices has paved way to divide India as two parts in future, one minority and other majority .This two elements will be fighting as an endless to share social benefits and show their superior power.The secularism would be broken in future .So ,this is a

blatant prediction of the present government policy and attitude .All these incidents have been as a continuous phenomenon against minority people since India's independence. So, government controversial anti-minority polices and arrogant activities are needs to be stop by good policy makers based on the view to protect secularism for protect the multicultural identity of India's society.

### **Partial religious policy affects Islamic people**

In the world ,the same community does not have relation with same community because lack of continuity , In India Islamic religion is only one community which is having universal relations in all countries of the world .The reactions of anywhere Islamic attacks will be creating worldwide Islamic conflict with apposite religion and ruler .In this perspective the present government have legislated a new law (prevention of cow eating )in India .It affects largely Islamic livelihood and habits of personal , and individual life style. Some of religious fanatics and ant-minority groups have attacked a Muslim family in Bisad village near Dadri, Uttar Pradesh an account of they had cow meat at their home .Same attack was done on another Muslim family in which family head Akhlaq was killed by the ruling party mob in New Delhi on September 2015 an account of that family have had beef. Succeeding other attacks was orchestrated by the religious fanatic mobs in Anrapradessh ,a boy was brought to the public street by the group of mob and tipped him at drainage channels asking to say (harijairam ,harijairam), its meaning is to convert Muslims to Hindu religion forcibly by the Hindu higher caste people Indeed .All these brutal and anti-minority attacks have been splitting the unity of secularism, psychologically makes people distress ,makes resentments among the minority people toward revolution and shows ruling party majority and mighty.

### **Attacks on Indian Islamic community affects India –Afghanistan relations**

After 1955,India –Afghanistan relations met large gab in terms of socio ,economic and politics due to several reasons of geopolitics ,religious politics ,allied politics and power politics .Since 1947 on wards two partners are being mismatch to the all the aspects of smooth relation for maintain a friendly relations in south Asia .How did come gab ?and how do they feel about India relations over the Islamic community is known very clearly to be all the academicians and rulers ?.In fact, the reason for Pakistan separation ,often terrorismattacks,severalHindu partial and brutal attacks over the Islamic people in India have created Islamic angry and aversion on India .All these notorious activities of the India's political power holder have let to segregate Islamic people themselves from the India's Hindu politics. They perceived that Hindu religion is an incompatible to Islamic and minority community. The sporadic Hindu domination attacks on minority socioeconomic and political platform and Demolition of babri masjid On December 6, 1992 created a strong scornful aversion among the Islamic people over Hindu culture setup. Still the Islamic angry on India's arrogant Hindu political ruler and follower have been continuous process through the terrorism. (The Hindu, 2009). It is true that this kinds of majority attacks over the minority has affected not only Islamic community but also affected all the minority people sentiments and dignity on terms of human rights aspects.

Indeed ,all these bitterness and inconsolable situation of the minority community came to be an end slightly in 2001 through the international community support for establish a friendly relations with Afghanistan after so many years .Unfortunately Taliban attacks on (WTC)world trade Centre in USA have offered good opportunities to India for project its long fostered

relations with Afghanistan through its reconstruction activities in Afghanistan .When two partners relation do not come to be a well-established relations ,the Hindu domination over the Islamic people like attacking ,speaking sarcastically, killing beef eater and prohibition of beef eating habits have created a serious and dreadful Islamic provocation and gap between the two nation .This attitudes of majority Hindu people probably will push two country to go back to old days severe conflict situation(The Hindu,2015).Therefore, it is better to enact a new law to protect minorities in India unless secularism would be meaningless than being as a namesake ideology of India's constitution.

### **India needs to accommodate minority dignity**

Obviously it is not only would be enough incorporation of secularism principle at the preamble of India's constitution and it has to make an effective law for protection and accommodate of minority welfare and social security .Because ,India's constitution makers selected secularism to accommodate and facilitate different religion irrespective of caste ,color ,race and religion bias .Actually the main aim of secularism is to make people share ,participate ,practice and perform their interest in the Indian soil system despite every person attached with some religion and caste .So ,this kinds of India's policy was known widely as just an eyewash ideology .Truly, itsaim is to protect multicultural entity of India ,being as fence to prevent religious ,caste and community oriented conflict and fights in India. In fact ,the Indian government alone says that secularism is for protect inter community people and multicultural people interests in India but the same government and ruler are ruining, provoking ,inciting and instructing to their party cadres to create anti-secularism activities against the minority people in India for the vote bank purpose ,power sustaining purpose and nurture Hinduism ideology .The chief purpose of this contemporary caste oriented violence of the majority people over the minority is to make slave them under the umbrella of Hinduism principles .Therefore ,government or policy makers are obviously needs to focus on this issue to protect the thirsty of secularism and minority life.

### **India needs to transplantations its anti-social elements**

As never before in the Indian history or in the world history the minority people have been killing by the majority people of India for their political power and social status .The majority community defined as power holder ,prosperity holder ,being dominant in each village affairs ,caste differentiations and attacking minority in a sympathy less way for demonstrate their altogether mighty in the Indian social setup toward keep salve others and rule over-all these activities of majority ruler affects India's economic growth ,splits secularism ,disintegrate people fondness and create communal violence .

Thereby, India's appearance in abroad has been humiliated by the international community when India's leaders travel to foreign visits for make an agreement's and MOU in the fields of education ,security ,and economical. Indeed, no foreign policy or domestic policy of an any country would not be effective , it would be collapsed by its unethical appearance in the international scenario and in domestic scenario ( The Guardian ,2015) .As reflection of this study , Pakistan launching continuous cross border terrorism and bomb attacks on an important monuments and entity of India's due to majority people wrong role toward ban of beef eating and attacks Muslim people in the different state of India's.

### Needs minority support for India's developments

It would not be fruitful unless Indian government seek minority support despite it embraces aboard country economic cooperation .The unhappy conditions of minoritylike ,crying, women's raping ,preventing minority people love by killing ,discriminating Dalit's ,Muslims , tribal and spoiling minority community people life ineducation institutions have been asgreat stumbling blocks to India's foreign policy as well as India's integrations. Because ,minority community in India's Hindu systems have been facing so many torture and inhuman practices by the majority community in terms of socio-economic and political patterns .Thereby ,the minority people are segregated ,isolated and discriminated from the Hindu social setup despite they are found as an archipelago of India's social setup by working restless ,facing endless poverty and suffering from homeless .For the smart development of India's future as well as at present ,the today government have to accommodate the minority in the gamut of socio,-economic and political development as equilibrium as equity.

### CONCLUSION

If there is a garbage inside of home it will not be clean, as it a country could not develop or shine internally and externally toward soft development and hard development having huge internal problems. So, since the minority is having continuous relation over all the world, the majority attacks and discrimination over the minority are provoking common people and tarnishing India's image externally. Frequent caste based discrimination and attacks on the minority people in India have made an irreparable stumbling blocks to its country integration, secularism and foreign policy. Among the minority community, the Islamic community in India having relation internationally as flora as fawna ,the ratio of Islamic population in India is in second place next o Indonesia and its neighborly countries like Afghanistan , Pakistan and Bangladesh .It has been main source of India's security and prosperity .Any disturbances and discrimination on Islamic people will hurt the India's relations with Afghanistan ,Pakistan and Bangladesh in terms of security ,economic ,culture and politics . Therefore, India sincerely needs to stop its political oriented communal violence, it hast to punish the anti-social elements of ruling community over the minority attacks, it should not intervene at secular and multicultural affairs of diversity people of India's community. Therefore ,India needs to regulate its arrogant caste splitting politics than showing much more interest toward foster majority community in all the vital fields for rule successively constricting the minority people .Therefore, India needs to enforce a special law for protect minority community from the torture ,attacks ,violence and socio economic discrimination of the majority community in India.

### REFERENCES

F.India. (May 22, 2015) Can't survive without eating beef? Go to Pakistan, says Union Minister Mukhtar Abbas Naqvi

India real time. (Oct 9, 2015) Narendra Modi Tells Indians Not to Listen to Politicians (Including Him) If They Use Hate Speech,

The Hindu. (May 2, 2015)Live chat: Debate on beef ban,

The times of India. (Oct, 2015) HasLalu Prasad Yadav's beef remark given BJP a Mohan Bhagwat moment?

IBN Live. (Nov 03, 2015).BJP leader who threatened Karnataka CM over eating beef arrested, Siddaramaiah says 'not scared of any threat,

IBN Live. (Nov 03, 2015) Karnataka CM's 'neck will be on the line' if he eats beef, dares BJP leader, |

Daily open to opinion. (30-09-2015) How Hindus killed a Muslim over beef and murdered India's secularism,

The guardian. (October 2015) Brother of Indian man murdered for eating beef calls for calm.

International Business time. (May 22, 2015) Dying Without Eating Beef'? Go to Pakistan, Says Union Minister and BJP Leader Mukhtar Abbas Naqvi.

The news Minuets. (October 21, 2015) Not Seeking Beef Ban, Hindus Suppressed Here: Kerala BJP Chief.

Dawn. (30, 2015) Indian man beaten to death, son injured over beef eating 'rumours.'

Digvijaya Singh. (March 2015) .Holy Cow-Beef and Indian Political Games,

Los Angeles time. (April 06, 2003).The World India's Leader in a Beef over Dietary Insult,|

Jerrol. (November 15th 2015). In Maharashtra's beef ban shows how politicians manipulate Hindu sentiments around cow slaughter, Sunday,

India TV. (November 15, 2015). I haven't had beef, But I will eat, who are you to question: Siddaramaiah,

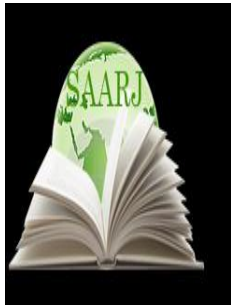

**ACADEMICIA**  
**An International  
 Multidisciplinary  
 Research Journal**  
 (Double Blind Refereed & Peer Reviewed Journal)

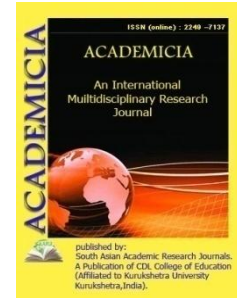

**DOI: 10.5958/2249-7137.2021.01210.6**

## CHALLENGES AND IMPORTANCE OF CENTRALIZATION AND DECENTRALIZATION OF LOCAL PUBLIC AUTHORITIES

**Mardonov Aziz Botirovich\***

\*Master of Public Administration Law of Tashkent State Law University,  
 Republic of UZBEKISTAN

### ABSTRACT

*Local public authorities (in the Republic of Uzbekistan) are local government bodies. They resolve all issues of local significance within their competence, reconcile the national interests with the interests of the citizens living in the area, and ensure the implementation of decisions of higher state bodies as an integral part of a single state authority. After gaining independence, Uzbekistan, based on long historical experience and national traditions, studied the positive aspects of the experience of advanced countries and radically reformed its public institutions created the system. A number of laws and official documents have been adopted in the field of forming the system of local government. Among them are the Constitution of the Republic of Uzbekistan (December 8, 1992), the Law "On local government" (September 2, 1993), the Law "On elections to regional, district and city councils of people's deputies" (May 5, 1994.) play an important role.*

**KEYWORDS:** *Local Public Authorities, Decentralization, Cautious Decentralization, Reform, Public Administration, Laws.*

### INTRODUCTION

Chapter 20 of the Constitution of the Republic of Uzbekistan stipulates that local public authorities o. The constitutional and legal basis of its activity is reflected (Articles 99-104). In these articles local public authorities. The system, the position, the functions, the order of the structure are enshrined in the constitution. The Constitution strengthened the two-tier system of local representative bodies (ie, district and city councils of people's deputies - the lower level; regional and Tashkent city councils of people's deputies - the upper level), and this was reflected in the law on local government. Local public authorities ensuring law and order and security of citizens, economic, social and cultural development of the regions; formation and execution of the local budget, establishment of local taxes, fees, creation of extra-budgetary funds;

management of local utilities; environmental protection; ensuring the registration of civil status acts; adopts normative acts and exercises other powers that do not contradict the Constitution and laws of the Republic of Uzbekistan.

Implements the laws of the Republic of Uzbekistan, presidential decrees, decisions of the highest bodies of state power, directs the activities of lower councils of people's deputies, participates in the discussion of issues of republican and local authority. It is divided into 2: local representative bodies and local executive bodies. Local representative bodies operate on a collegiate basis. The main organizational and legal form of work of the local council is a session. All branches of local representative bodies are formed through elections. The law provides for the election of representative bodies with comprehensive knowledge, experience, broad, independent thinking, and the functioning of these bodies. On December 25, 1994 and December 5, 1999, local elections were held in Uzbekistan. Local executive bodies - khokimiyats are headed by khokims of regions, districts and cities, and they act on the principle of monopoly. Authorities consist of departments, divisions and subdivisions, the structure, organization and activity of which are determined by the relevant regulations approved by the Cabinet of Ministers of the Republic of Uzbekistan.

The structure and staff of the executive bodies of the regions and the city of Tashkent shall be determined and changed by the governor in coordination with the Cabinet of Ministers of the Republic of Uzbekistan within the budget approved by the relevant Council of People's Deputies. Structure and staffing of district, city executive authorities and executive bodies of the Republic of Karakalpakstan Local state authorities regulated by the law on in accordance with the legal documents regulating the relations of the Councils of People's Deputies and the governor, an advisory council under the governors was established to consult on important issues and problems in the region. However, the formation of such advisory councils does not undermine the principle of monopoly in the activities of the governor. The heads of the branches of the executive branch shall be appointed and dismissed at the sessions of the relevant councils of people's deputies in agreement with the higher bodies of state administration and on the recommendation of the governor. Documents adopted by local representative bodies and governors must not contradict the constitution and laws. Citizens, public associations, enterprises, institutions and organizations can appeal to the court against the documents adopted by the governor.

Since 2016, Uzbekistan has been actively taking steps to gradually decentralize public administration, however, there are a number of systemic problems along the way. Since the first days of independence, Uzbekistan has paid attention to the issue of gradual decentralization of the public administration system. Especially after 2016, this direction was identified as one of the priorities in the strategy of actions for the development of the republic approved in 2017. The importance of the phased decentralization of public administration was identified among the approved main directions and tasks of the administrative reform of public administration. [1] Cautious decentralization

The reforms carried out in the period from 2016 to 2020 in this direction demonstrate that Uzbekistan is still trying to carefully implement administrative and fiscal decentralization, while maintaining the status quo on the issue of political decentralization. The following decisions should be noted, which were aimed at strengthening local government agencies: Strengthening the financial independence of the regions, supporting the growth of the revenue base of local

budgets, and increasing the powers of local authorities to formulate priority expenditures at the level of oblasts, cities, and regions. At the first stage, the country's leadership decided to conduct an experiment with the local budgets of the city of Tashkent and its districts. Thus, on June 7, 2017, Presidential Decree No. UP-5075 "On measures to expand the powers of local government bodies in the formation of local budgets" and Resolution No. PP-3042 "On expanding the powers of local government bodies and increasing their responsibility for the formation of revenues of local budgets".[2]

According to the above legal acts, a number of receipts as a flat tax on certain types of entrepreneurial activity, property tax and land tax from individuals and legal entities, a single tax payment for micro firms and small enterprises to the revenues of regional budgets. As well as tax for the use of water resources, tax on the consumption of gasoline, diesel fuel and gas, as well as other fees were redistributed in full or in part in favor of the city budget of Tashkent and local budgets of its districts.[3]

Already at the end of 2018, it was decided to extend this practice to other regions of the republic. It was decided, in addition to the above types of taxes and fees, to the regional budgets to transfer part of the most important receipts in the form of taxes on personal income and value added tax, as well as fully receipts from the excise tax on alcoholic beverages, beer, retail sales of gasoline, diesel fuel and gas.[4]

However, unfortunately, the increase in the volume of revenues of local budgets is not always associated with a parallel increase in the level of accountability of local authorities and the introduction of a transparent system for their spending. In many cases, additional revenues are used only to strengthen the material and technical base of local khokimiyats [ local administration – ed.], and not to develop social infrastructure. Transfer of decision-making powers from central government bodies to local authorities and increasing their responsibility for the socio-economic development of regions, cities, and districts.

At the end of 2018, local authorities were also transferred from the republican budget to local funding for a number of state-funded organizations. For example, financial departments / sectors of khokimiyats, departments of justice, territorial plant quarantine inspectorates, information and library centers, territorial departments of state financial control and treasury, museums and theaters of regional significance, as well as departments / sectors of the off-budget Pension Fund.[5] Along with this, in order to activate the independent activity of local kengashs of people's deputies, it was decided to form separate secretariats that will provide organizational, technical and other services for the activities of local deputies.[6] Strengthening the financial independence of the regions, supporting the growth of the revenue base of local budgets, and increasing the powers of local authorities to formulate priority expenditures at the level of oblasts, cities, and regions.

#### Challenges in implementing decentralization measures

Despite the measures taken to increase the responsibility and importance of local authorities, there are a number of systemic problems on the path of the decentralization policy in Uzbekistan: While there have been some changes in the legislation, the fundamental legal act regulating the activities of local authorities, the Law on State Power in Localities, is still being implemented in the outdated version, approved in 1993. [7]



Back in May 2019, it was reported about the development of this legislative act in a new edition, but so far it has not been adopted. According to this project, it was proposed to expand the powers of khokims on the ground, including in their list the coordination of the activities of territorial law enforcement agencies in matters of ensuring the observance of public order, the safety of citizens, the protection of their rights, freedoms and health, the prevention of offenses, compliance with the passport and visa regime, the social rehabilitation of persons who committed offenses of law. [9]

Obviously, it is necessary to adopt this normative legal act in a new edition in accordance with modern realities and within the framework of a cardinal transformation of the public administration system in accordance with the launched administrative reform. Along with this, the approval of the Strategy for the consistent decentralization of public administration with the indication of specific terms for each stage of the transfer of powers from central bodies to local authorities, increasing the independence of local authorities, their financial support, high responsibility, and transparent accountability.

In recent years, the powers of local authorities, especially khokims and khokimiyats, have significantly expanded. Currently, according to the legislation, they perform about 300 tasks and functions, while 175 of them are not included in the main competence of khokims and duplicate the functions of other departments. [10]

Decentralization in the country is developing according to the type of deconcentration, when the powers transferred from the center are consolidated in the hands of the local khokim. Effective decentralization requires greater involvement of non-governmental organizations in the work of local authorities. The transfer of certain functions and the involvement of NGOs to address pressing socio-economic issues in the field of protecting the rights of persons with disabilities, youth, supporting vulnerable groups of the population, as well as education could relieve local executive structures. It would also help to improve the targeting of government support and the role of civil society in resolving significant local issues.

The concept of decentralization implies a gradual decrease in the role of the central government. However, in recent years, there has been a tendency towards an increase in the number of central administrative structures and their staff headcount. Compared to 2016, the number of ministries was increased from 14 to 22 units, state committees from 8 to 10, agencies from 6 to 7, committees from 2 to 4, inspections from 7 to 8. In this vein, currently, khokims of the regions, cities and districts can have up to eight assistants on various issues compared to three to six assistants at the beginning of 2016.

To sum up, it should be noted that the decentralization of public administration is often perceived only as a simple strengthening of the powers of local authorities. In fact, effective decentralization is possible with thoughtful allocation, rather than division of overall responsibility between central and local governments. Effective decentralization implies the creation of a new model of relationship between the central government and local authorities, based on closer cooperation and a strategic role of central government. At the same time, many cases in Uzbekistan demonstrate that the expanded financial independence of local authorities at the current stage of development and, considering the existing gaps in the legislation, is detrimental to ensuring financial discipline and financial stability of the regions.

**REFERENCES:**

1. Decree of the President of the Republic of Uzbekistan No. UP-5185 “On approval of the Concept of administrative reform in the Republic of Uzbekistan” dated September 8, 2017 <https://lex.uz/docs/3331176>
- [2] An experiment with the local budget will be carried out in Tashkent. // Information and legal portal “Norma”, June 21, 2017 [https://www.norma.uz/novoe\\_v\\_zakonodatelstve/v\\_tashkente\\_provedut\\_eksperiment\\_s\\_mestny\\_m\\_byudjetom](https://www.norma.uz/novoe_v_zakonodatelstve/v_tashkente_provedut_eksperiment_s_mestny_m_byudjetom)
- [3] Decree of the President of the Republic of Uzbekistan No. UP-5075 “On measures to expand the powers of local government bodies in the formation of local budgets” dated June 7, 2017 <https://www.lex.uz/docs/3232503>
- [4] Resolution of the President of the Republic of Uzbekistan No. PP-4086 “On the forecast of the main macroeconomic indicators and parameters of the state budget of the Republic of Uzbekistan for 2019 and budget guidelines for 2020-2021” dated December 26, 2018 <https://lex.uz/docs/4131693#4134663>
- [5] The President assigned additional responsibilities to the khokims. IA “Sputnik Uzbekistan”, April 14, 2020. <https://uz.sputniknews.ru/society/20200414/13924070/Prezident-vozlozhil-na-khokimov-dopolnitelnuyu-otvetstvennost.html>
- [6] Law of the Republic of Uzbekistan No. 3PY-636 “On Amendments to Certain Legislative Acts of the Republic of Uzbekistan in Connection with Improving the Activities of Kengashes of People’s Deputies” dated September 14, 2020 <https://www.lex.uz/acts/4996187>
- [7] Law of the Republic of Uzbekistan No. 913-XII “On local government power” dated September 2, 1993 <https://lex.uz/docs/112168#120911>
- [8] The law on state power at the local level will be adopted in a new edition. // IA “Gazeta.uz”, May 24, 2019. <https://www.gazeta.uz/ru/2019/05/24/project/>
- [9] Draft Law of the Republic of Uzbekistan “On Amendments and Additions to the Law of the Republic of Uzbekistan” On State Power in Localities “dated May 20, 2019 <https://regulation.gov.uz/ru/document/3518>
- [10] The powers of the khokims will be revised. // IA “Gazeta.uz”, January 24, 2020. <http://www.gazeta.uz/ru/2020>
- [11] O'zME. The first volume. Tashkent, 2000
- [12] Data from the National Encyclopedia of Uzbekistan (2000-2005).

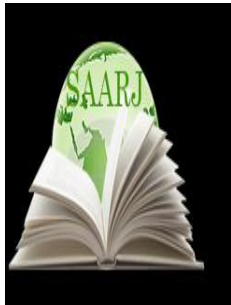

**ACADEMICIA**  
**An International**  
**Multidisciplinary**  
**Research Journal**  
 (Double Blind Refereed & Peer Reviewed Journal)

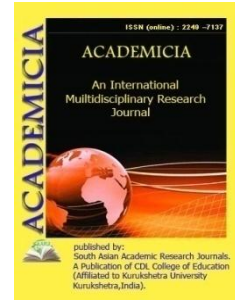

**DOI: 10.5958/2249-7137.2021.01209.X**

## THE PROBLEMS OF CONVERGENCE AND DIVERGENCE IN PRESENT DAY LINGUISTICS

**Kuldashev Akram Makhmudovich\*; Kuldasheva Shakhnoza Akramovna\*\***

\*Associate Professor,  
 State World Languages University,  
 UZBEKISTAN  
 Email id: akramkuldashev@gmail.com

\*\*Senior Lecturer,  
 State World Languages University,  
 UZBEKISTAN  
 Email id: skuldasheva@mail.ru

### ABSTRACT

*Present Day linguistics is rich in tendencies and schools. Formation and development of the anthropological paradigm and its leading position promised much to explain the problems related to how languages change, why do the languages change, what are the main causes of language changes, what is the role of internal and extralinguistic factors in language change? Convergence and Divergence are two main mutually related terms denoting the process of language development from two different angles. The author states, that there are two aspects of convergence: a) glottogonic, dealing with the formation and development of the language; b) structural-diachronic aspect, dealing with diachronical aspect of linguistic structures. Glottogonic convergence is the formation and development of the common structural features in the genetically related or non-related languages as a result of the long-termed and intensive contacts. The author points out, that the linguists distinguish two types of convergence: a) contact-based convergence; b) substratum-based convergence. The closing part of the article deals with the lexical, morphological and phonological types of divergence and convergence as illustrated with the materials from the ancient Germanic languages and the corresponding forms in Gothic, Scandinavian, Latin and common Indo-European.*

**KEYWORD:** *Convergence, Divergence, Convergent Features, Divergent Features, Integration, Differentiation, Linguo-Genetic Investigations, Structural Aspect, Diachronic Aspect, Substratum, Diphthongization, Assimilation, Glottochronology, Language Change, Language Development.*

## INTRODUCTION

Linguistics of the latest decades is marked by the expansion of the new terms to linguistics which earlier belonged to different branches of science, like philosophy, physics, biology, psychology, etc.

Webster's Dictionary gave the following definitions to the terms under discussion:

**“Divergence** – 1. A receding from each other in moving from a common center, the opposite of *convergence*. 2. Disagreement, deviation, from a standard.” [WNED, p. 295]

**“Convergence** – 1. Act or state of converging; also, a degree or point of convergence. 2. Tendency to grow alike; development of similarities in form, habits.” [WNED, p. 222]

A. Ushakov's Dictionary of Modern Russian gives the following definition to the word “divergence”:

**“Divergence** [fr. divergence] – Deviation in features, becoming different. Differences observed in features or qualities are called divergence.” [Ushakov, Vol. I, p. 707]

**“Convergent** – becoming alike as a result of convergence.” [Ushakov, Vol. I, p. 1432]

**“Convergence** – [from Latin “convergeus” - corresponding] scientific term.

– Correspondence of the features of the objects which are not related to each other; becoming alike;

- similarity of some features of the objects not on the basis of their genetical relationship but as a result of some other factors (in biology)”;

- The process when the ace of eyelids comes near when a man looks at a very close object. [Ushakov, Vol. I, p. 1432]

In one of the encyclopaedic dictionaries we find the following definition to the word “convergence”.

1. Formation and development of similar features in genetically different organisms on the basis of the similarity of the place of living and mode of life. Convergence can explain similarity between the body of the shark (fish) and dolphin (mammal), as well as between American cactuses and Afrikan molochais.

2. The direction of the ace of eyelids to the object. [Encyclopaedic dictionary, p. 276]

And now let's analyse the definitions given in the latest editions of that dictionary.

**“Convergent zones** – the zones in the world oceans when the upper currents get together and the water descends. Usually convergent zones are formed when the warm and cold currents meet. The waters going down are enriched by the oxygen of the lower layers of the ocean. According to their size Southern Sub Polar zone is distinguished from others and it forms a belt around the planet between the 50°-60° of the southern latitude.” [Encyclopaedic dictionary, p. 616]

The theory of Convergence is one of the concepts in European and American politology.

In the Penguin dictionary of Science [1978] we find the following definition to the term convergence.

“**Convergence** – Coming to a point...” [p. 89]

To the word “**divergent**” we find the definition – “Going away in different directions from a common path or point.” [p. 115]

**Convergence** – (from Latin Convergo – coming near to, becoming alike). This term is used in biology to denote the process of appearing and development of the similar features as a result of the common location and conditions of life. It is explained by common trends of natural-selection. [p. 616]

In Ethnography this term is used to denote the phenomena which earlier were not found in definite cultures but later appeared in them as a result of different causes. [ED, p. 616]

In linguistics **convergence** is used to denote the formation and development of different structural elements of languages and the languages proper in the process of their historical development. [ED, p. 616]

In geography we use the term “**divergence zones**”. In geography there is a term “**divergence**” which is used to denote the scalar field indicating the density of the Vector field  $a(P)$ . It is marked by the abbreviation  $\text{div } a$ . [ED, p. 616]

The term “divergence” was introduced to the science by Ch. Darwin to explain the differences in the features of the primary organisms which came from one origin as a result of evolution.

In linguistics the term divergence is used to indicate the following phenomena:

- 1) The variants of a linguistic unit (generally the variants of a phoneme) become independent units as a result of the loss of the conditions determining the variation of the units.
- 2) A language unit, for example, a phoneme becomes different in its phonetic representation.
- 3) Variants or dialects of a language develop in the direction forming a new variety or a separate language. [LED, p. 136]

Convergence is an integration or correspondence of two or more essences. There are two aspects of convergence:

- **glottogonic** – dealing with the formation and development of the language;
- **structural-diachronic aspect** – dealing with the diachronical aspect of linguistic structures.

Glottogonic convergence is the formation and development of the common structural changes in the genetically related or non-related languages as a result of the long-termed and intensive contacts. This can happen with the languages which developed from common substratum. In this case scholars differ two types of convergence:

- 1) contact-based convergence
- 2) substratum-based convergence.

These two types of convergence may correspond or coincide. Convergence may include different levels of the language (for example lexical level, morphological level) as well as the entire language. The area where convergence is observed is called convergent zone.

The terms convergence and divergence may sometimes be replaced by other terms having close or similar meanings. For example, some linguists use the terms “Integration” for convergence and the term “differentiation” for the term divergence.<sup>1</sup>

There are two tendencies in the process of a **language development**:

- 1) **Integration** (convergence). In integration dialects or develop towards obtaining common features in phonetic, grammatical structures and vocabulary.
- 2) **Differentiation** (or divergence). In differentiation dialects or languages develop towards obtaining different features in phonetic, grammatical structures and vocabulary to form new languages.

There are two types of factors of language change:

- 1) **Extra linguistic factors**. Extra linguistic factors of language change include a) Geographical factors, b) Social factors, c) Temporal factors.

- 2) **Intra linguistic factors**:

Intra linguistic factors of language change include:

- **Phonetic changes**. Phonetic changes include all kinds of changes taking place in the phonetic structure of a language like consonant and vowel changes.
- **Spelling changes**. Spelling changes include all changes taking place in the writing of words in different varieties of the language, like *honour – honor, colour – color*, etc.
- **Grammatical changes**. Grammatical changes include all changes taking place in the grammatical structure of the language; like using one form instead of another: *have got – have, in the street – on the street*, etc.
- **Lexical changes**. Lexical changes include all changes taking place in the vocabulary of the language. They are: *widening, narrowing, metaphorical use, connotative use, occasionalisms*, etc.
- **Stylistic changes**. Stylistic changes include all changes within the frames of stylistics that is the use of the word of one style can be used in the other style, thus becoming a stylistically marked form.

Convergence and Divergence are closely related to the process of language change. We can frankly say that they make the language change to be systematic. For example:

Any lexical change, can it be the word formation or borrowing may correspond to the general trend of the developments of the word-stock. Then, we observe Integration. If the borrowed word wouldn't correspond to the general trend of the development of the vocabulary it'll be a divergence. For example, the word “*paynet*” was borrowed from English into Uzbek and it has become an Uzbek word which Uzbek speakers pronounce as [pai'net]. In Uzbekistan even the people who know English, and can use English for their general and specific purposes pronounce the word as [pai'net] not as [pei'net]. And if a person pronounces the word correctly, that is as

[ˈpeiˈnet] the people look at him in queer way and correct him as if he is correcting an illiterate person. This kind of “modified”, “spelling based” pronunciation coincides with the Uzbek way of pronouncing words. In linguistics this process is called “**hypercorrection**” or correcting on the basis of a wrong variant.

Integration and Differentiation are also observed in the diachronic processes of inflectional Change, like leveling and the loss of inflections. For example: OIcel and ONorw “*steinn*” (stone) corresponds to Old Swed., Old Dan. “*stēn*”, OIcel., ONorw “*-auga*” (eye) corresponds to OSwed. “*ogha*”; ODan. “*oghe*”, OIcel, ONorw “*lauss*” (untied) corresponds to OSwed, ODan “*lōs*”; OIcel “*eyrir*” (a name of a monet) ONorw “*øyrir*” – OSwed, ODan “*øre*”; OIcel. “*heyra*”, ONorw “*hoyra*” (to hear), OSwed “*hōra*”, ODan “*høre*”, etc.

In diphthongization of “*ě*” we observe divergence of phonemes in North Germanic languages.

OIcel, ONorw “*ek*” (I) – OSwed, O Dan “*iak*”; OIcel, ONorw “*stela*” (to steal) – OSwed “*stia’la*”, ODan “*stia’le*”.

In west Scandinavian languages a special type of breaking can be named as a source for divergence, where diphthongization of “*y*” to “*iu*” (y>iu) before **ngw**, **nkw**, **ggw** become different in neighbouring languages.

For example: OIcel “*syngva*” (to sing) – OSwed “*siunga*”; ODan “*siunge*”; OIcel “*syug*”, OSwed, ODan “*siung*”; OIcel “*søkkva*” (to lower) OSwed: “*siunka*”; ODan: “*sinke*”; OIcel “*tyggva*” (to chew), OSwed: “*tiugga*”; ODan: “*tiugge*”, etc.

A case of divergence we observe when East Scandinavian languages preserved the phoneme “*v*” before “*re*” which was lost in West Scandinavian languages. For example, OIcel “*reiðr*” (angry) – OSwed: “*vredner*”, OIcel “*reka*” (drive) – OSwed “*vræka*”, OIcel “*riða*” (turn) – OSwed. “*vriða*”.

As we see languages are rich in such processes. Let’s analyse some other phonemes of IE origin and see how they developed in Germanic languages:

**IE e > Germ i:** Lat. *fēro* > Goth *bairau*, *baira*, *bairip*; OE: *bēran*; OHG: *bīru*, *birit* (to bear).

**IE o > Germ. a:** Lat. *octo* > Goth. *ahtau*; OScan: *ātta*; OE: *eahta*; OFriz: *achto*; OHG: *ahto* (eight).

**IE ə > Germ. a:** Lat.: *pater* > Goth.: *fadar*; OScan: *faper*; OE *fæder*; OHG: *fater*.

**a > e:** Goth. “*harj*” is “army” – OFris.: *here*.

**ā > ē:** OE *dǣd* (dead) – OFris.: *dēd*.

**ō > ē:** Goth. *dōmjan* (to judge) – OFris. *dēma*.

**u > y > e:** OHG: *kuri* (choice) – OFris. – *kere*.

**au > e:** Goth. *hausjau* (to hear) – OFris.: *hēra*.

**ē > a:** Goth. *tēkan* (to take) – OScand: *taka*.

Goth. *lētān* (to let) – OE *lǣtan*.

**ā > ə:** Lat. *scabō* (to make) > Goth. *skapiau*.

The exact determination of the time of these and other changes depends on many factors, such as, for example, differences in the judgements of contacts, differences in the material selected from within a family, etc.

Thus the divergence times revealed by the glottochronological method are not at all accepted, since the use of this method has not been generally recognized. Beyond this, we may consider comparable those divergence times in which we have a good deal of confidence, and our degree of confidence must depend upon the circumstances. We can be more confident in divergence times that are confirmed by evidence from other sources.

As we see linguists of the present time, as well as the linguists of the XIX-XX centuries could not explain the causes of the first and second Consonant Shift in Germanic languages, also the Change of the Stress system, Assimilation in the sphere of vowels, Rhotacism, Ablaut, etc. using traditional methods and procedures of the Historical-Comparative method, founded by B. Delbrucke, H. Paul, K. Brugmann, K. Osthoff, F. Kluge, A. Meillet, H. Hirt, R. Prokosh, H. Krahe, W. Streitberg, A. Noreen, E. Benveniste, Y. Kurilovica and many others as well as we can mention the theories put forward and developed by the great Russian comparativists, like V.M. Jirmunsky, E.A. Makayev, M.M. Guchman, G.S. Schur, V.M. Serebrennikov, S.D. Katznelson, G.S. Klychkov and others who lived in the XX th century.

We think that those problems, related to divergence and convergence mentioned above can be solved successfully if we apply the principles, theory and procedures of analysis of the linguistic data, as well as the cause and the results of convergence and divergence in Germanic languages.

## REFERENCES

1. Swadesh M. Lexicostatistic dating of prehistoric ethnic contacts. - Proceedings of the American Philosophical society, v. 96, p. 420-470, 2004.
2. Makayev E. A. Struktura slova v germanskikh yazikah. M., Nauka, 1974, 340 p. (in Russian)
3. Jimunsky V.M. an Introduction to the Historical – Comparative study of Germanic languages. Moscow-1963. 590 p.
4. Klimov G.A., Gamkrelidze V.A. Indoyevropeitsy, Indoevropskiy yazik, Moskva, Nauke, 1990, In two volumes. (in Russian)
5. Prokosh E. A Comparative Germanic Grammar. Philadelphia, 1939, 380 p.
6. Gak V.A. Vvedeniye v romanskuyu filologiyu. Moskva, Visshaya Schkola, 1986, 200 p. (in Russian)
7. Kuldashev A.M. An Introduction to Germanic Phylology, Tashkent, 2010, 148 p.

## LIST OF THE DICTIONARIES

1. Webster's New International Dictionary. N-Y., 2006, 3240 p.
2. Ushakov A. Slovar sovremennogo russkogo yazika. M., 1976-1980, in 4 volumes. (in Russian)
3. Uvarov N.G. Dictionary of Scientific Terms. Oxford, 1996, 500 p.
4. Dictionary of linguistic terms. (ed. By V.N. Yartseva), M., RL, 2001, 860 p. (in Russian)



**List of the abbreviations used**

**GL** – Germanic languages

**OE** – Old English

**ODan.** – Old Danish

**OG** – Old Germanic

**OHG** – Old High German

**OSw/OSwed.** – Old Swedish

**OIcel.** - Old Icelandic

**ONorw.** – Old Norwegian

**LED** - Dictionary of linguistic terms

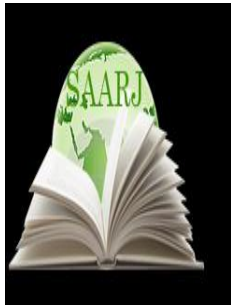

**ACADEMICIA**  
**An International  
 Multidisciplinary  
 Research Journal**  
 (Double Blind Refereed & Peer Reviewed Journal)



**DOI: 10.5958/2249-7137.2021.01127.7**

**INNOVATIVE APPROACH AND STATE TRAINING PROGRAM "FIRST STEP" IN THE IMPLEMENTATION OF THE PROCESS OF PRESCHOOL EDUCATION AND TRAINING**

**Olimov Kakhramon Tanzilovich\*; Turdieva Mokhira Jurakulovna\*\***

\*Professor,  
 Bukhara State University,  
 UZBEKISTAN

\*\*Lecturer,  
 Department of Preschool Education,  
 Bukhara State University, UZBEKISTAN  
 Email id: mohira.turdiyeva@bk.ru

**ABSTRACT**

*The article examines the existing problems in the preschool education system, ongoing reforms aimed at solving these problems, and the importance of the state program "First Step". The advantages of organizing classes based on interactive methods in PEO are shown.*

**KEYWORDS:** *Preschool Education, Preschool Age, Reforms, Education, Continuous Education, Pedagogical Process, Science, Interactive.*

**INTRODUCTION**

It cannot be exaggerated to say that the system of preschool education is the most important period of the most important link in the formation of personality. Because, although this age of upbringing coincides with a short opportunity of a person's life, during this period the child will understand and learn many percent of what he has learned all his life. This period serves as the foundation for future life.

So, what are the problems in this system, which deals with the education and training of the child in an important period of his life, and how are they solved? What news is being watched in the industry? What to expect from the reforms?

At this educational stage, which is considered important in the life of the child, there are several issues that need to be solved and found a solution. Including:

- \* Full coverage of preschool children in preschool institutions;
- \* To organize the educational process in preschool institutions in a way that can meet the modern requirements;
- to ensure the passage of training in an interactive way, interesting.

The field of preschool education is the primary component of the system of continuous education, which in all respects plays an important role in the preparation of a healthy and harmonious person for school. Therefore, systematic work is being carried out in our country to further develop this sphere, to create all conditions for our children. At the same time, the contribution of not only the state, but also non-state educational institutions to the coverage of children in preschool institutions is significantly increasing.

In general, it is noteworthy that since the establishment of this ministry, preschool education institutions have increased from 5 211 to 8 104 units, the level of coverage of children from 27.7% to 61.8%.

The pedagogical process aimed at ensuring the comprehensive development of preschool children should be simple, suitable for age groups and colorful. The successful implementation of educational and educational work will depend on the correct Organization of the pedagogical process in pre-school educational institutions, each type of activity. Defining the worldview of children in all aspects, both physical and spiritual, as well as spiritual formation and development issues as the main goal in the lessons is considered one of the main tasks facing the current educators.

Sufficient material, technical and methodological and methodological assistance is provided by state organizations to educators in the implementation of these tasks. For example, the program "first step" for the new pre-school education sector, which is being implemented since 2018, is based on state requirements and all preschool institutions in the Republic are introduced to this program. The package of documents, which includes the state and program requirements, has been delivered to Mus in all regions. In addition, for the first time in Uzbekistan, thematic planning programs were distributed to everyone.

The basic principle of this program, which is called the "first step", is the first steps of young children who are already involved in the educational process.

The main tasks of the program " first step" :

- To determine the requirements for the development, content and quality of education and training of preschool children;
- To provide education to children on the basis of national, universal and spiritual values, to introduce effective forms and methods of development;
- Implementation of pedagogical and modern information and communication technologies in the educational process;
- to ensure effective integration of Education, Science and production for the purpose of targeted and quality training of personnel.

In general, it has been shown that state students should develop small and school-age children in five directions.

---

The main area of development of children	Areas of small scale development
1. Physical development and formation of a healthy lifestyle	<ul style="list-style-type: none"> <li>➤ the major motorist interest</li> <li>➤ fine motor oil</li> <li>➤ sensamatarika application</li> <li>➤ healthy lifestyle and safety</li> </ul>
2. Socio-emotional development	<ul style="list-style-type: none"> <li>➤ The concept of "I"</li> <li>➤ Emotions and their management</li> <li>➤ socialization,</li> <li>➤ Communication with adults and peers</li> </ul>
3 Speech, communication, reading and writing skills	<ul style="list-style-type: none"> <li>➤ speaking and speaking</li> <li>➤ reading skills</li> <li>➤ tiny fingers motorikasi of fingers</li> </ul>
4. Development of cognition process	<ul style="list-style-type: none"> <li>➤ intellectual-cognitive skills</li> <li>➤ elementary mathematical skills</li> <li>➤ research-cognitive and effective reflexive activity</li> </ul>
5. Creative development	<ul style="list-style-type: none"> <li>➤ the artistic challenge of imagining the world</li> <li>➤ creative abilities-artistic artistic talent</li> </ul>

Tirib it develops five directions, the child 4 to compensation:

- \* The sphere of "physical development and formation of a healthy lifestyle" competences;
- \* To the sphere of" socio-emotional development " competences;
- \* Competences in the field of" speech, communication, reading and writing skills";
- \* To the sphere of" development of the cognitive process " compensation;
- The sphere of "creative development" will have compensations, that is, they are motivated to go to the 1st grade and are ready for school education.

The process of acquiring knowledge on the basis of the program lies in the development of games through. In children, such concepts as knowledge acquisition, creativity, social orientation develop, a healthy lifestyle is brought up, and they begin to understand how to behave in a social environment. Educating preschool children as inquisitive, active, initiative, free-thinking, observant, healthy is an important task facing parents and educators. The organization of classes based on advanced pedagogical technologies, specific to the modern requirements, using all-round methods of activity of children-interactive methods, is considered to be a very effective factor.

Interest, attention and demand for increasing the effectiveness of education using interactive methods, innovative pedagogical and information technologies in the educational process are increasing day by day.

The significant aspect of the use of pedagogical technologies in the process of education is the breadth of the possibility of carrying out the education that develops the individual.

When modern technologies are used, educators should pay attention to the fact that they seek the knowledge they possess, independently study and analyze it, and even draw conclusions

themselves. The pedagogue creates conditions for the development, formation, acquisition and training of knowledge of the individual and team in this process.

- ✓ At the present stage of development of the educational system, intensive changes are taking place in preschool education, which is considered its first tier, and they are manifested in the following:
- ✓ the basis of pre-school education institutions ' activities is being improved;
- ✓ up to now, educational institutions are moving to new types of financial and economic activity schools; a network of non-public pre-school educational institutions is being introduced; advanced technologies of education are being introduced; improving the system of professional development of employees; alternative forms of preschool education institutions on the basis of term groups are being introduced (on the basis of the "Ilm Road" short-term program) ; investment projects with the participation of financial institutions are being implemented; innovation and experience-testing works in preschool education institutions are being significantly improved.

Today, the rational use of new pedagogical technologies in pre-school education creates favorable conditions for linking education to education, integrating both in terms of structure and content, embodying educational activities, sending them to independent thinking. The lessons conducted on the basis of pedagogical technology become spiritually mature, harmonious personalities, thinking independently of the younger generation. Therefore, in the educational process in educational institutions, the importance and role of modern teaching methods-interactive methods, innovative technologies - can not be overemphasized.

Innovation (English innovation - introduction of innovation) - means changing the internal structure of the system. Innovation is of urgent importance and new approaches formed in one system.

Pedagogical technology is implemented on the basis of a systematic approach to education, and attention is paid to the age, spirit, outlook, knowledge, level of activity, purpose, direction, content, forms, methods of education and training of the educator. The organizer of this process of the educator, the basis of his activity as a creative person, is his knowledge and skills, the ability to influence the interest and aspiration of the child using technical means, the support of methods that serve the child Faux, the ability to achieve guaranteed results.

In conclusion, a number of reforms are being carried out in the pre-school education system, which is aimed at serving the interests of children and teachers, as well as improving the quality of preschool education.

The basis of all things in the state educational program" first step "and the varativ programs" the way of knowledge " is a social approach, that is, in the center of attention - the child and his interests stand. Pedagogical parents, pedagogical content, the child himself and, of course, social partners, such as society and the state, should organize a social environment.

The fact that the interactive techniques used by the educator in the course of the lessons are not only to increase the interest of the children, but also to the extent that they meet their needs, constitute an important basis for improving the quality of preschool education.

**USED LITERATURE:**

1. Turdieva M. J. The essence of organizing the process of preschool education and education on the basis of an individual approach //International Engineering Journal For Research & Development. – 2021. – T. 6. – №. SP. – C. 3-3.
2. Turdieva M.J. The Role of the ‘First Step’ State Curriculum in the Preschool Education Sistem. INTERNATIONAL JOURNAL OF MULTIDISCIPLINARY RESEARCH AND ANALYSIS. Volime 04 Issue 02 February 2021. Page №.-202-204.
3. Gafurova D. K. Formation of fluid speech in preschoolers //International Engineering Journal For Research & Development. – T. 6. – №. 1. – C. 5-5.
4. Concept of development of preschool education system of the Republic of Uzbekistan until 2030. T.:2019 year.
5. MirziyoyevCityM. The decision on measures to further improve the system of preschool education in 2017-2020. T.: 2016 y. 26 December.
6. The state educational program “first step” of the preschool institution. T.: 2018 y.

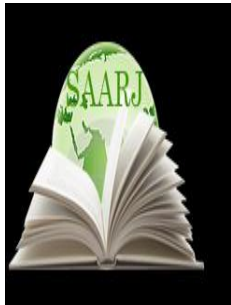

**ACADEMICIA**  
**An International  
 Multidisciplinary  
 Research Journal**  
 (Double Blind Refereed & Peer Reviewed Journal)

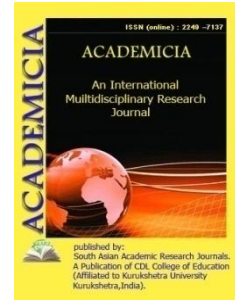

**DOI: 10.5958/2249-7137.2021.01128.9**

## CALCULATION OF THE PAYBACK PERIOD FOR THE INTRODUCTION OF REACTIVE POWER SOURCES INTO POWER SUPPLY SYSTEMS

**A.B.Abubakirov\***; **I.K.Gayipov\*\***; **A.J.Sultanov\*\*\***; **Sh.B.Kuatova\*\*\*\***

<sup>1,4</sup>*Karakalpak State University named after Berdaq,*  
 UZBEKISTAN

Email id: aziz1306@mail.ru

### ABSTRACT

*At present, the sources of reactive power are widely used in telecommunication facilities that have windings (electric motors, transformers, etc.) in the design. To manage these sources, necessary to introduce new technical means and elements, including microprocessor blocks. Combined control of reactive power sources and voltage regulation with the help of a microprocessor-based unit of electric receivers of telecommunication objects turns out to be technical and economical not only for reactive power sources, but also for lowering transformers of the power supply system.*

**KEYWORDS:** *Compensation, Electric Motors, Transformers, Reactive Power, Microprocessor Control Units, Active Power, Connection, Voltages.*

### INTRODUCTION

Receivers and converters of electrical energy, which have windings in their construction (power converters, transformers, electric motors, etc.), consume not only active power, but also reactive power. When electricity is transmitted through the electrical networks of the power supply system (PSS) of reactive power (RP), they generate losses of active power, for which the consumer pays. An alternative to an additional payment for electricity is the installation of reactive power sources (RPS) in the electrical network [1-2].

At most facilities with high-voltage electrical equipment, reactive loads are compensated by overexcitation of existing synchronous compensators (SC) with high voltage (6-10 kV) or by placing in the power grid of PSS capacitor installations - high-voltage (WCD) and low (NCB) voltage [3-11].

As shown by the analysis, the loss of electricity in the UK, due to the generation of PM by them, is minimal in the operation of electric receivers with a small consumption of PM. The growth of PM output is accompanied by a sharp increase in electricity losses, which primarily heat SK units. Studies have also shown that the use of any power, as well as high-voltage CS with a power below 1,600 kW, is uneconomical in low-voltage systems [3, 6,7].

It should be noted that even with excess PM of high-power high-voltage CCs and generators that allows to observe contractual parameters with the electricity supplier, the consumer is not immune from unjustified losses of the latter. The remark is typical especially for electrical loads with extended high voltage electrical networks and a large number of reducing power transformers (T) 10 (6) / 0.4 kV of PSS objects.

### MAIN PART

As experience of operation of electric networks and electric receivers of objects of PSS has shown, cosine capacitor installations for them are more widespread RPS. The power of a reactive power source is proportional to the square of the voltage, frequency and its capacitance [2-14]:

$$Q_k = U^2 \cdot \omega \cdot C, \quad (1)$$

where:  $Q_k$  - reactive power of the condenser unit;

$U$  - voltage of the electrical network TK;

$\omega$  - angular frequency;

C-capacity of the condenser unit.

The use of embedded microcomputers in the block of microprocessor combined automatic control of reactive power sources makes it possible to reduce damage from damage to electrical and electrical equipment and to improve the quality of generated electricity.

Connection of capacitor installations for compensation of reactive power at different voltages of PSS objects is shown in Fig.1.

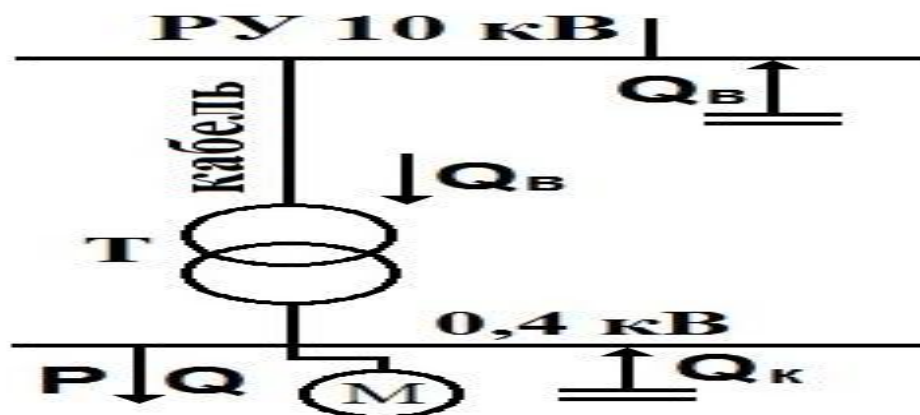

Fig.1. Scheme of capacitor installations for compensation of reactive power at different voltage levels of electrical networks.



For an example we will determine the additional losses of active power  $\Delta P$  in T and cable lines of PSS with a length of 400 m with a cross section of 50 mm<sup>2</sup>.

Suppose, before the installation of the NSC at the PSS site, there were loads: load factor, time of maximum power losses:  $\tau = 5000$  h.

After the installation of the NSC, the load of the PSS facility will have the following values:

The current flowing through the electrical networks of the PSS facility is determined as follows:

$$I_1 = \frac{S_1}{U\sqrt{3}} = \frac{860}{(10,5 \cdot 1,73)} = 47 \text{ A}; \quad (2)$$

$$I_2 = \frac{S_2}{U\sqrt{3}} = \frac{707}{(10,5 \cdot 1,73)} = 39 \text{ A}. \quad (3)$$

Additional power losses in the HV cable:

$$\Delta P_K = 3R_K(I_1^2 - I_2^2) = 3 \cdot 0,248(47^2 - 39^2) = 0,52 \text{ кВт}. \quad (4)$$

Additional power losses in T of the PSS object depend on its load losses:

$$\Delta P_T = \Delta P_{K3}(K_{31}^2 - K_{32}^2) = 10,6(0,862 - 0,7072) = 2,54 \text{ кВт}. \quad (5)$$

Total power loss:

$$\Delta P = \Delta P_K + \Delta P_T = 0,52 \text{ кВт} + 2,54 \text{ кВт} = 3,06 \text{ кВт}. \quad (6)$$

The energy savings for PSS facilities for the year will be:

$$\Delta \mathcal{E} = \Delta P \cdot \tau = 3,06 \cdot 5000 = 15300 \text{ кВт} \cdot \text{ч}. \quad (7)$$

The increase in the capacity of T and the cable lines of PSS objects can be taken into account with corresponding shares of their cost.

For power transformer TC:

$$\Delta K_T = K_T(S_1 - S_2)/S_1 = 500000 \cdot (860 - 707)/860 = 88953 \text{ руб}. \quad (8)$$

For cables with a long-lasting current

$$I_D = 130 \text{ A};$$

$$\Delta K_K = K_K(I_1 - I_2)/I_1 = 62000 \cdot (47 - 39)/130 = 3815 \text{ руб}. \quad (9)$$

Payback period of the NCB:

$$T_{OK} = (K_{KV} - \Delta K_T)/(C_{cp} \cdot \Delta \mathcal{E}) = (160000 - 88953 - 3815)/(0,77 \cdot 15300) = 5,7 \text{ года}. \quad (10)$$

The indicator of the effectiveness of this measure is determined as follows:

$$ПЭФФ = \left( \frac{T_{OK \text{ НОПМ}} - T_{OK}}{T_{OK \text{ НОПМ}}} \right) \cdot 100\% = \left( \frac{8 - 5,7}{8} \right) \cdot 100\% = 28,75\%. \quad (11)$$

## CONCLUSION

1. The specific value of the WKB is half that of the NCB. However, the constant component of costs for WKB is higher due to the greater cost of connecting them to the electrical networks of PSS objects.
2. Parameters of the regulated NCU - the number and power of the control stages, the power of the unregulated part - are determined by the daily schedule of consumption of PM by electric receivers.
3. Combined control of reactive power sources and voltage regulation with the help of IRM proves to be effective only for NKR, included behind the large inductive resistance of step-down transformers of PSS objects.
4. To change the voltage by one percent of the nominal value, it is necessary to change the PM after transformer, behind the transformer, behind the cable line length, behind the cable line length.

As shown by the conducted studies, the proposed method of selection and application of reactive power sources and microprocessor combined control allows them to reduce by 28.7% the payback period of the implemented technology and the elements of electricity consumption management and to increase the efficiency of energy saving measures implemented in the PSS objects.

## LITERATURE

1. I.Kh.Siddikov, M.A.Anarbaev, A.A.Abdumalikov, A.B.Abubakirov, M.T.Maxsudov, I.M.Xonturaev. «Modelling of transducers of nonsymmetrical signals of electrical nets» // International Conference On Information Science And Communications Technologies Applications, Trends And Opportunities // Publication Year: 2019, Page(s): 1–6. <http://WWW.ICISCT2019.Org>
2. I.Siddikov, Kh.Sattarov, A.B.Abubakirov, M.Anarbaev, I.Khonturaev, M.Maxsudov. «Research of transforming circuits of electromagnets sensor with distributed parameters» // 10 th International Symposium on intelgent Manufacturing and Service Systems. 9-11 September 2019. Sakarya. Turkey. c.831-837.
3. A.B.Abubakirov. «Research of the electromagnetic transducers for control of current of three phases nets»// European science review, Scientific journal № 5–6 Виенна, Австрия. 2018. с 269-273.
4. I.X.Siddikov, A.B.Abubakirov, A.J.Allanazarova, R.M.Tanatarov, Sh.B.Kuatova // Modeling the secondary strengthening process and the sensor of multiphase primary currents of reactive power of renewable electro energy supply // Solid State Technology, Volume: 63 Issue: 6, Publication Year: 2020, pp: 13143-13148.
5. Abubakirov A.B., Yo'ldashev A.A., Baymuratov I.Q., Sharipov M.T., Utemisov A.D. «Study of conversion circuits and design of the electromagnetic primary current and voltage transducer of monitoring and control systems» // EPRA International Journal of Research and Development. Volume: 5 India. 2020. - C. 214-218. (SJIF Impact Factor: 6.260| ISI I.F.Value:1.241| Journal DOI: 10.36713/epra2016 ISSN: 2455-7838(Online)).

6. N. Juraeva, O.Nazarov, S.Urolov, A.Djalilov. Intellectual system for water flow and water level control in water management/1st International Conference on Energetics Civil and Agricultural Engineering 2020 October 14th – 16th 2020, Tashkent, Uzbekistan. IOP Conf. Series: Earth and Environmental Science 614 (2020) 012044.
7. Баратов Р.Ж., Чуллиев Я.Э., Джалилов А.У. Low power smart system development for water flow measurement and level controls in open canals// International Journal of Advanced Research in Science, Engineering and technology. – India, 2019. – Vol.6. Issue 12 – pp. 12240-12246. <http://www.ijarset.com/upload/2019/december/55-rbatov-80.pdf>.  
<http://www.ijarset.com/volume-6-issue-12.html>.
8. Аллаев К.Р. Энергетика мира и Узбекистана. – Ташкент: Молия. -2007. – 388 с.
9. Аллаев К.Р., Сиддиқов И.Х., Холиддинов И.Х., Абдуманнонов А.А., Хасанов М.Ю. Алгоритм расчёта сверхнормативного технологического расхода электроэнергии // Государственное патентное ведомство РУз. Свидетельства № 20140089, 17.12.2014 г.
10. Бороденко В.А. Ресурсосбережение как главный принцип создания устройств автоматики энергосистем // Вестник НИА РК. М., – 2006. -№2.12 с.
11. Положение о порядке организации работ по компенсации реактивной мощности // Тешабаев Б.М., Юсупалиев М.М, Салиев А.Г., Сиддиқов И.Х., Умаров Ф.У. / УТВ. N 1864 от 10.10.2008. Минюст. РУз. Ташкент, ГИ Уздавэнергонадзора. - 2008. – 24 с.
12. Krontiris E., Hanitch R., Paralika M., Rampias I., Stathais E., Nabe A., Kadirov T.M., Siddikov I.Kh., Energy Management raining in Uzbekistan // ThefinalreportoftheProjectECTJEP-10328 – 97. TU - Berlin (Germany), TEI -Athens (Athens, Greece),TashGTU (Tashkent, Uzbekistan), 1997-2001. – 234 p.

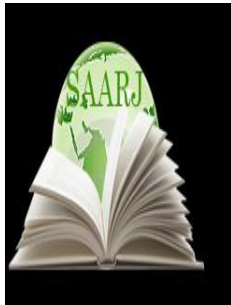

**ACADEMICIA**  
**An International**  
**Multidisciplinary**  
**Research Journal**  
 (Double Blind Refereed & Peer Reviewed Journal)



**DOI: 10.5958/2249-7137.2021.01129.0**

## THE LINGUOCULTURAL ANALYSIS OF ROBERT BURNS' AND BERDACH'S WORKS ON THE THEME OF "FREEDOM"

**Toleubaeva Aliya Ondasinovna\* ; Atanazarova Dilnaz Bakhtiyarqizi\*\***

\*Assistant teacher,  
 Karakalpak State University,  
 UZBEKISTAN

\*\*1<sup>st</sup> year student  
 Karakalpak State University,  
 UZBEKISTAN

### ABSTRACT

*Robert Burns and Berdach are widely renowned in literature due to their unrepeatable poetry of English and Karakalpak languages .Both of them are great poets who are loved by their nation for their remarkable works. The study proposes to compare the views of these two poets in the theme of "Freedom". Despite the fact that they belong to different religions, cultures, centuries and countries, there are striking similarities in their conspicuous works.*

**KEYWORDS:** *Robert Burns, Berdach, Freedom, Liberty, Honesty, Justice, Poetry*

### INTRODUCTION

Robert Burns is a National Bard, the Ploughman Scottish poet and lyricist. He was born on January 25, 1759 in Ayrshire, Scotland. He is the best known of the poets who have written in the Scots language, although much of his writing is in English and a light Scots dialect, accessible to an audience beyond Scotland. He wrote his first poem when he was 15 years old. It was "Handsome Nell". Its subject is Nell Klipatrick who is the daughter of the village Blacksmith. He describes circumstances in his first poem in an autobiographical letter to Dr. John Moore, a doctor and writer with whom he corresponded. He also wrote in standard English. His notable works are: "Tam O'Shanter", "Auld LaungSyne", "To a mouse".

Berdach is a Karakalpak classic poet of the 19<sup>th</sup> century. He was born in 1827, Muynak, Karakalpakstan. His father was a fisherman. When Berdach was 10 years old, his parents died and he was brought up by his relatives. He wrote his first poems "O'gizim" and "Shig'irim" when he was 10. These poems were about agriculture. He is famous for his epic

poem ‘Shejire’. He studied in Karakumlyshan madrasah but he couldn’t continue his study because of poverty. He lived in poverty and described it in his poem “Jaz keler me? (when will summer come)?”:

“Tamag’imjoqisherge,  
 Ko’ligimjoqko’sherge,  
 To’segimjoqto’serge  
 Biz sorli’gajazkelerme ?  
 Ko’silipjataru’yimjoq,  
 Iyinge tartar kiyimjoq  
 Toqlardanbizgebuyimjoq  
 Men sorlig’ajazkelerme ?[1,166 p]

In this poem he describes that he doesn’t have any home to live, food to eat and clothes to wear. He compares “summer” to “happy days” for him and his nation.

### **The main themes of the poetry of poets and how they are described through stylistic devices**

We can see a lot of revolutionary-democratic motives in Berdach’s works. Of course, it is due to the social, financial and political conditions of Karakalpaks at those times. In the XVII-XVIII centuries, Karakalpaks lived in the downstreams of Syr Darya river. As a result of different historical processes, they settled in Khorezm in the middle of the XVIII century. Khiva Khanate completely conquered them in the XIX century, the century Berdach lived. The later life of Karakalpaks was dependent on Khiva Khanate. Khiva Khanate oppressed them, demanded high amounts of taxes. Berdach described it in his poem “Saliq”:

Biltirg’idanbiyiljaman,  
 Qalayqalayboldi zaman,  
 G’aripqaserqalmayaman,  
 On tilladankeldisaliq.  
 O’ndiredi ash xaliqtan  
 Jetimjilaydisonliqtan  
 Bay amanqaldisaliqtan  
 Dohmetboldiusisaliq,-[1,48 p]

In this poem he describes that only poor people payed the taxes, not the rich. By this, the poet tries to emphasize the inequality between the rich and poor. Also the amount of tax was higher than the past years and it was very difficult for the people to pay it. In the poem “Bolg’anemes” the poet uses metaphoric lines to emphasize his difficulties in life that he didn’t have any freedom to write his right thoughts due to the khans:

Gu’lboldinguljaynamadim,

Oyshilboldimoylamadim,  
 Bu'lbilboldimsayramadim,  
 Hadiyseazbolg'anemes[1,162 p]

At those times ,the khans made poets write poems about khans with respect.Otherwise ,it would be even worse for poets .This is illustrated in this poem with the idiom “tastaytunekkejoliqtim”(left in the darkness).He compares the poor to the rich by using metaphor:”lashing'aqurg'an tor boldi ,tordiheshkimu'zgenemes”.

The same meaning is illustrated in Robert Burns’ “Is there for honest poverty?” poem which describes the social inequality in the XVIII century:

Is there for honest poverty,  
 That hangs his head and all that,  
 The cowards slave ,we pass him by,  
 We dare be poor for all that,  
 For all that and all that,  
 The rank is but the guinea’s stamp,  
 The man’s the gold for all that[3,259 p]

The poet tries to describe that the value of human’s life is not measured with wealth or money by using metaphors in the last two lines.

Then let us pray that come it may,  
 That sense and worth over all the earth,  
 Shall take the prize and all that,  
 For all that and all that,  
 That man to man the world over,  
 Shall brothers be for all that.[3,259 p]

In these verse,the poet hopes that one day all people will be equal and they will be as brothers for each other.He hopes for bright future.

Despite the fact that the main theme of Robert Burns’poems is love,we can find some poems about justice and liberty in the poem “The slave’s lament”,he tries to show the inequality ,especially slavery.He compares slavery to liberty :

The burden I must bear while the cruel scourge I fear,  
 In the lands of Virginia-ginia,O  
 And I think on friends most dear  
 With bitter,bitter tear,  
 And Alas I’m weary,weary,O.[3,732 p]

In this poem the narrator is the slave himself. He shows his emotions. One important thing, it is revealed to the slave's past: he had a lot of friends when he was free, and now he is a slave and his friends make him afraid. It is described with the epithet "bitter tears" in the fourth line of the poem.

All things considered, the world-renowned poets from different countries and cultures, Robert Burns and Berdach have left conspicuous works including similar emotions of freedom. Even though they wrote in different languages, they both illustrated the idea of freedom and justice in their masterpieces.

**REFERENCE:**

1. Berdaq "Shig'armalartoplami" .No'kis –Ilim-2018
2. Najim Dawqaraev "Berdaqshayir "Qaraqalpaq Mamleketbaspasi -1950
3. Robert Burns "Poems" Poemhunter.com-The world's poetry archive-2004
4. O'Hagan "The people's poet" The Guardian ,19 January 2008

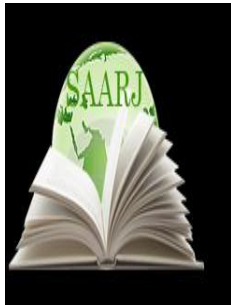

**ACADEMICIA**  
**An International**  
**Multidisciplinary**  
**Research Journal**  
 (Double Blind Refereed & Peer Reviewed Journal)

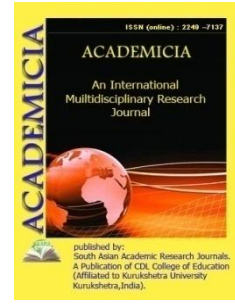

**DOI: 10.5958/2249-7137.2021.01130.7**

## PHONETIC INTERFERENCE OF VOWEL PHONEMES IN UZBEK- RUSSIAN AND UZBEK-GERMAN BILINGUALISM

**Askarova Shakhnoza Ismailovna\***

\*Basic Doctoral Student,  
 Fergana State University, UZBEKISTAN  
 Email id: askarovasch@gmail.com

### ABSTRACT

*The article examines the issues of phonetic interference in Uzbek-Russian and Uzbek-German bilingualism, as well as identifying the features of phonetic interference in the speech of Uzbek speaking students in the process of acquiring Russian and German. **The purpose** of this work is to identify the features of bilingualism, phonetic interference of the vowel sounds of Uzbek, Russian and German languages. It is established that the Uzbek language has a greater impact on the German language system in the learning process than the Russian language. The Uzbek language, as a system mastered in a natural environment, affects the process of mastering all subsequent language systems. The phonetic interference of the Russian and German languages is most clearly expressed in the pronunciation of phonemes and intonation, and this is primarily due to the methods of mastering these languages. **Materials and methods.** The material for this study was linguistic scientific articles, abstracts and monographs. The study of Russian and German languages usually occurs at a conscious age, so the simple imitation that begins the development of the native language is replaced by the identification of language systems. In the course of studying the problem of phonetic interference, a descriptive method of vowel phonemes in the Uzbek, Russian and German languages was used, which makes it possible to understand and generalize the corresponding theoretical material. **Results.** The results of the study are as follows: to explore the manifestations of phonetic interference in Uzbek-German and Uzbek-Russian bilingualism, which are most displayed in phonetics, grammar and vocabulary. At the same time, the first foreign language begins to have a great influence on the second. The degree of interference of languages largely depends on the contact of languages and the level of linguistic competence of individuals. Improving the language competence of a bilingual is an effective way to prevent interference. To reduce the degree of influence of languages on each*



other, the ability of individuals to switch language codes should also be developed. Universal errors arising at the point of the largest approximation of languages are adjusted by the targeted fixing of the foreign language material. **Conclusion.** The manifestations of sound (phonetic and phonological), spelling, grammatical (morphological, syntactic and punctuation), lexical-semantic, stylistic and, finally, intra-linguistic interference must be distinguished from the phenomena of language switching, in which a language change occurs. Interference is a characteristic process of a bilingual situation. Features of these stages can be influenced by both internal and external factors. It is necessary to observe the influence of extra-linguistic situations on bilingual speech.

**KEYWORDS:** *Language Contacts, Bilingualism, Multilingualism, Interference, Vowel Sound, Language System, Phonetic Interference.*

## INTRODUCTION

Bilingualism as a result of language contacts, which are inevitable in the world of globalization, is of absolute interest along with other linguistic results, such as language borrowing, language change, language mixing and interference phenomena that naturally follow it. The characteristics of the communicative scopes and forms of language existence, within which language contacts take place, their intensity and regularity, turn out to be the most important aspects in the analysis of cases of deviation from the norms of each of the languages involved in the contact situation, and are manifested in the speech of bilinguals as a result of their acquaintance with in more than one language. In connection with the contacting of languages, one can observe changes in the system of phonemes L1, L2 or L1, L2, L3, manifested in the form of changes in the implementation of certain phonemes or the phonological system as a whole, as well as violations of the differentiation of significant features in contacting languages, leading to confusion, non-discrimination or rethinking linguistic facts. The linguacultural situation is often characterized by an active non-equilibrium Uzbek-Russian and Uzbek-German bilingualism, the main feature of which is its diglossic-bilingual nature.

Bilingualism or multilingualism and linguistic contact are prerequisites for the manifestation of linguistic interference, which can become the beginning of borrowing, transfer, from one language to another, or fusion (convergence) of certain elements of the contacting languages. The problems of bilingualism, multilingualism and the influence of languages on each other have attracted the attention of researchers for a long time. In the multilingual regions of the Republic of Uzbekistan, there is a diffuse nature of linguistic processes in combination of the spoken language with the literary language, which creates problems for the bilingualism as a linguistic personality in linguacultural identification.

With regular language contact and bilingualism, the phenomenon of *interference* occurs. In linguistics, the problem of interference is considered within the framework of linguistic contacts and interference is understood as a violation by a bilingual (a person who speaks two languages) of the norms and rules of the ratio of two contacting languages. [1]

Interference problems have worried many linguists. For the first time, the idea of the mutual influence of languages on each other was put forward by the Russian-Polish linguist I.A. Baudouin de Courtenay. By interference, the scientist understood the convergent restructuring of

languages in the course of contacts. It should be remembered that at that time the term "interference" was not yet widespread. The main idea of I.A. Baudouin de Courtenay was that as a result of the mutual influence of languages on each other, not only the borrowing of individual linguistic units occurs, but also the convergence of languages as a whole [6,317].

The term "interference" comes from the Latin words "inter" (between) and "ferens" / "ferentis" (carrier, carrying). It first appeared in the fields of physics, chemistry and biology, and then was borrowed into the field of linguistics. This phenomenon is studied in linguistics, sociolinguistics, psychology and psycholinguistics and can manifest itself in both oral and written speech. [2]

According to the theory of such linguists as W. Weinreich, I.A. Zimnyaya, A.A. Leont'ev interference is the replacement of the system of rules of the target language with another, built under the influence of the system of rules of the native or previously studied language [3,4,5]. Moreover, the interference arising from the negative impact of the native language and the first foreign language on the studied third language in bilingualism covers all linguistic levels of the language.

There are three main forms of interference. We are talking about phonetic, grammatical and lexical-semantic interference. The problem of phonetic phenomena, respectively, the interference becomes especially relevant in connection with the question of acceptance or non-acceptance of specific phonetic phenomena. Determining phonetic hindrances, their causes and impact on communication are important tasks for phonetics researchers, teachers and students working in the field of German as a foreign language. This applies in particular to phonetic phenomena in the comparative analysis of the German and the native language. The article discusses phonetic interference from the native language (in our case, Uzbek) to the target languages (Russian and German).

In the sound systems of the Uzbek, German and Russian languages, there is a significant range of articulatory and acoustic phenomena that do not coincide with each other. This leads to an emphasis in bilingual pronunciation. To eliminate the emphasis, it is necessary to refer to the data of the acoustical-articulatory features of phonemes, which deals with the phonological system of a non-native language, to master syntagmatic and paradigmatic patterns in order to understand the similarities and differences of the Uzbek, Russian and German language systems.

The system of German vocalism has 18 vowel phonemes, three times more units than Uzbek and Russian. This is due to the presence in it, firstly, of long and short vowel phonemes and, secondly, labialized front vowels. These two features of the sound system of the German language, as well as the hard onset of vowels at the beginning of words and morphemes, which has a delimiting meaning in the flow of German speech, have a constant interfering effect on the pronunciation of the Uzbek and the Russian speaker in German. The timbre of vowel sounds depends more on the position of the tongue, soft palate and lips.

In the conditions of Uzbek-German and Uzbek-Russian bilingualism, there are many obstacles, that is, the phenomenon of interference in the phonetic system of these languages. To overcome obstacles in mastering a non-native language, Uzbek students need to study phonetics by comparing the sounds of vowel and consonant phonemes. The characteristic of vowels is related to the type of syllable. German vowels: [i:], [ɪ], [y:], [ʏ:], [u:], [ʊ], [ɛ:], [ɛ̃:], [z], [ø] [œ], [o:], [ɔ], [a:], [a], [ə], [R], [ao]. The sounds of the Russian language are divided into vowels and consonants. The vowel sound consists only of the voice. The consonant sound consists of voice

and noise or only noise. In Russian there are 6 vowel sounds: [a], [o], [e], [y], [and], [s]. Uzbek vowels: [i], [e], [a], [u], [u], [o].

According to the movement of the tongue along the vertical, or according to the degree of rise of the tongue, according to the degree of approach to the palate during the formation of sound, all vowels are divided into sounds of the upper, middle and lower ascents. According to the movement of the tongue horizontally, or at the place where the tongue rises during the formation of sound, the vowels are divided into vowels of the front, middle and back rows. If the vowel sounds of German are I - [i:], [ɪ], E - [e:], [ɛ:], [e], U- [u], [Y], O - [o:], A - [a] of the upper ascent, then in the Uzbek language the vowel sounds of the upper row include [and], [a], [e], in Russian the upper one is [and], [s], [y], the middle one is [e], [o], lower - [a]. Thus, the lower ascent of vowels in German includes [o:], [o], [a:], [i:], [i], and in Uzbek, the vowels [u], [a], [about].

The phoneme [and] of the Russian language is the sound of the front row, high rise, non-diphthong, non-labialized. In the Uzbek language, the vowel phoneme [and], possessing the same specific features, differs significantly from the analogous Russian phoneme. There are two variants of the phoneme in the Uzbek language: anterior [i] and posterior [s]. In terms of its articulation characteristics, Uzbek [and] occupies an intermediate position between the front and rear sounds, that is, it is the sound in between the Russian [and] and [s]. A great difficulty in mastering Russian pronunciation is the vowel sound [s], which is absent in Uzbek and German vocalism. Even if students begin to distinguish by ear the sounds [and] - [s] articulation of the vowel [s], that is, the upper rise of the middle part of the back of the tongue, not accompanied by labialization, is not given to them for a long time. Compared to the vowel [and], the main articulatory movement of the vowel [s] is the backward movement of the tongue. But Uzbek students tend to replace the desired articulation with the familiar one. The vowel sound [s] is found in the Uzbek language mainly in borrowed words from the Russian language, for example: cheese, exhibition. In articulation, this vowel differs from the vowel [s] existing in the Uzbek lexicon, by raising the tongue, by a narrow back row, by touching the sides of the tongue to the hard palate. In the spoken process, this sound is almost distorted and faces assimilative conversion, since Uzbeks do not have an articulatory skill for the vowel [s] [9,65].

According to the theory of academician V.V. Reshetova: "If the more posterior shade of the phoneme [u] = [b] is characterized by us as acoustically close to [s] but Russian [s] is not identical [7,138].

If mistakes in bilingual speech are associated with the use of German labialized vowels of the front row, then a methodical technique should be deliberate stretching of the lips, although in Russian when pronouncing [s] the lips are neutral, In the position of the end of a word under stress, for example, in the words: mountains, you, walls, tables, carpets, writing, etc. - sometimes there is a diphthong pronunciation [s] with s-shaped or u-shaped shades at the end of the sound. This discontinuity in sound is the result of an inability to fix the vowel line or rise [s].

Unlike Uzbek and Russian vowels, German vowels are divided into short (with a minimum duration), long and semi-long. Longitude and brevity of sounds perform a meaningful function. For example, the difference in the sense of sentences is determined only by the duration of the vowel in the words: Städte (long sound - "cities") and Stätte (short sound - "place.")

Wirbesuchtergern die Städte. - We enjoyed visiting cities. WirbesuchtergerndieseStätte . - We visited these places with pleasure. ") [8, 6].

The vowel sounds of the German language form pairs "long vowel" - "short vowel". The difference leads in most cases to the emergence of differences, called qualitative. The difference in their articulation depends on how wide the mouth is when pronouncing the vowels. At the beginning of a word or root of a word, German vowels should be pronounced with a so-called hard attack. A hard seizure is the result of the rapid opening of tightly closed vocal cords and is perceived in the stream of speech as a light clicking sound. Thanks to a firm fit, words beginning with a vowel do not merge with the previous word into one sound group when pronounced. Thus, we see some differences in the phenomenon characteristic only of the phonetic system of the German language, which shows a significant difference from the systems of the Uzbek and Russian languages, compare: bu \_ uskun. This \_ setting (continuous pronunciation). diese Anlage (non-fusion due to hard attack).

When pronouncing German vowels, tension of the entire vocal apparatus is necessary, ensuring the preservation of the homogeneity of the sound throughout its sound. In the Uzbek and Russian languages, when pronouncing vowels, the vocal apparatus is not tense, which leads to non-uniformity of the sound of vowels (sliding). Compare: [to: t] tot - dead [that] - that. In German, primarily [o:] and [e:], they retain their sound in unstressed syllables, while in Uzbek and Russian they often change completely, for example: [fo · ne · tik] Phonetik - [fanetics] - phonetics [me · te · o: r] Meteor - [mitior] - meteor. In German, unlike Uzbek and Russian, all vowels are pronounced in unstressed syllables cleanly, clearly and clearly. In Russian, vowel sounds, especially [o], in unstressed syllables are pronounced very vaguely, like a cross between [a] and [o]; Wed the Russian word "professor" and the German word Professor [pro · ' feso: r]. Often, not only beginners but also advanced Uzbek learners of Russian are unable to pronounce some Russian sounds correctly. For beginners to study the Russian language of foreigners, the difficulty in studying the Russian alphabet and Russian phonetics lies in the fact that almost all letters of the Russian alphabet can denote several different sounds, for example: the letter E can denote the sounds [e], [ye], [and], and sometimes even the letter - E - can denote the sound [s] (after the consonants w, w, c without stress: price, wife). As shown above, the Russian language is written in Cyrillic. The Russian alphabet has 33 letters and, therefore, more than the Uzbek and German alphabets. Some Russian letters resemble Latin letters used to write Uzbek and German languages, for example A / a, O / o, K / k, but Sh / w, Y / s are not displayed from the Latin font. On the other hand, Russian language does not know some Latin letters, as well as the rewriting of the German language (W / w, Ä / ä, Ö / ö, Ü / ü, Z / z, etc.). This poses a challenge for Uzbek German learners as well as German teachers to cope with sounds they are unfamiliar with. It is especially difficult to formulate front round vowels such as Ö or Ü. With interference, not only phonology is important, but also the implementation of sounds in the speech process.

Summing up, it should be noted that a comparative analysis of the phonological units of the Uzbek, Russian and German languages gives grounds for the assertion that the interference in Russian and German speech of Uzbeks at the phonetic level is caused by: a) the presence of the law of vowel harmony in the Uzbek language; b) the presence in the Uzbek language of sounds that are close, but different in their articulation from the sounds of the Russian and German languages; d) the presence in the Uzbek language of sounds that have no analogy in the sound composition of the Russian and German languages. A characteristic feature of the interference in

Russian and German speech of Uzbek students can be considered that phonetic interference is observed in the forms of external and internal, direct and indirect interference. In some cases, interference manifests itself in a combined way as indirect and intra-lingual and can cover several linguistic levels.

In the similarities and differences in the phonetic structure of the Uzbek, Russian and German languages, we see the basis for determining the specifics of the interference in the Uzbek-German and Uzbek-Russian bilingualism in the Russian and German speech of Uzbek students.

In the course of the study, it was established that it was necessary to create textbooks and teaching aids for the phonetic - practical course of the Uzbek-Russian and Uzbek-German languages, including special exercises to overcome the interfering influence of the native language on non-native languages in the context of bilingualism.

#### **LITERATURE:**

1. Alimov V.V. Translation theory. Translation in the field of professional communication. - M., 2005. -- 232 p.
2. V. V. Adamchik The latest dictionary of foreign words and expressions. - Minsk: Modern Literature, 2006. -- 976 p.
3. Weinreich U. Monolingualism and multilingualism. Language contacts. New in foreign linguistics. - M.: Progress, 1972. - pp. 25-60.
4. Winter IA Psychology of teaching a foreign language. - M.: Russian language, 1989. -- 223 p.
5. Leontiev A.A. Some problems of teaching Russian as a foreign language. - Moscow: Moscow State University, 1970. -- 88 p.
6. Baudouin de Courtenay I.A. Phonology. Selected Works on General Linguistics. - M.: Publishing house of the Academy of Sciences of the USSR, 1963. - p. 253-361.
7. Reshetov V.V. Uzbek language. Part I. Introduction. Phonetic. - Tashkent, 1959.
8. Rozhkova G.V. Introductory-corrective phonetic course of the German language. Moscow State University., 2001.
9. Mirtozhiev M. M. Phonetics of Uzbek language / M. M. Mirtozhiev. -Toshkent: Fan, 2013.- 424 p.

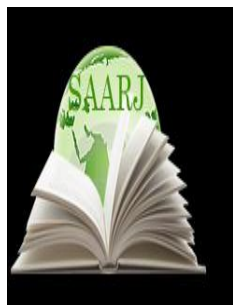

**ACADEMICIA**  
**An International  
 Multidisciplinary  
 Research Journal**  
 (Double Blind Refereed & Peer Reviewed Journal)

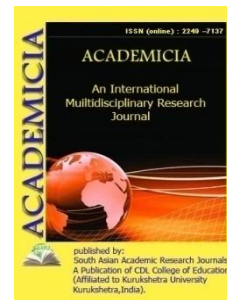

**DOI: 10.5958/2249-7137.2021.01131.9**

## FEATURES OF THE LIFESTYLE OF AQUATIC MOLLUSCS OF CENTRAL ASIA

**Davronov Barno Orziyevich\***

\*PhD, Department of Zoology and Physiology,  
 Faculty of Natural Sciences, Karshi State University,  
 UZBEKISTAN  
 Email id: davronov-68@mail.ru

### ABSTRACT

*This article presents the results of a study of the lifestyle of aquatic mollusks and the ecological group of Central Asia. In the considered ecological groupings, the composition of species is very often relative, since some of the representatives of these groups can inhabit adjacent biotopes. A striking example of this is the views of the Galbas.str section. Among the small reservoirs there are both flowing (springs, streams, rivers, canals) and standing (ponds, haus, saz, swamps, reservoirs, medium-sized lakes). These bodies of water differ in origin, position above sea level, content of organic matter in them, salinity, turbidity, temperature, etc.*

**KEYWORDS:** *Central Asia, Molluscs Ecological Group, Stagnophiles, Rheophiles, Telmatophiles,*

### INTRODUCTION

Central Asia, despite the aridity of this region, has a complex hydrographic network, including numerous and varied water bodies. It is based on rivers, mainly of glacial feeding - Syr Darya, Amu Darya and others. Among the small reservoirs there are both flowing (springs, streams, rivers, canals) and standing (ponds, haus, saz, swamps, reservoirs, medium-sized lakes). These bodies of water differ in origin, position above sea level, content of organic matter in them, salinity, turbidity, temperature, etc. For each of the listed types of water bodies, certain ecological groups of mollusks are characteristic (Zhadin, 1933, 1940, 1950a, b, 1952; Izzatullaev 1981, 1982, a, b, 1983).

Molluscs that live in rivers, streams, springs, warm springs, and the surf zone of lakes are classified as rheophiles. The ecological group of inhabitants of stagnant reservoirs is made up of stagnophiles.

Molluscs - rheophiles (inhabitants of moving waters) in the reservoirs of Central Asia with respect to the biotopes inhabited by them are divided into the following groups; lithoreophiles (inhabitants of a solid substrate) - *Dreissenapolyomorpha aralensis*, *D.p.obtusicarinata*; phytophils (inhabitants of thickets) - *Lymnaea auricularia*, *L.psilia*, *Hippeutis diaphanella* and *H.euphaea*; peloreophiles (inhabitants of the silted bottom) - *Theodoxus pallasi*, *Cinnapiscinalis*, *Pisidum amnicum*, *Corbicula cor*, *C.fluminalis*, *C.purpurea*, *Corbicula ferghanensis*, *C.tibetensis*, *Colletopterumbactadrianum*, *C.cyreumsogdianibba*, *S. puerorum*; crenophiles (inhabitants of springs) - representatives of the genera *Bucharamnicola*, *Turkmenamnicola*, *Valvatamnicola*, *Martensamnicola*, as well as species *Alloocinmacaspica*, *Karinarella minima*, *K.likharevi*; thermocrenophiles (inhabitants of warm springs) - *Melanoides kairanensis*, *M.pamiricus*, *M.shahdaraensis*; thermocrenophile-phytophile-*Lymnaea alticola*.

In addition to these clearly demarcated groups, there are ecological groups that form on silty-sandy soils - *Pelopsammophiles* (Neizvenova-Zhadina, 1937; Zhadin 1940). These include 6 species of *Melanopsis* and some other groups.

Stagnophiles, in turn, are subdivided into lake dwellers (limnophiles), puddles (telmatophiles), and swamp dwellers (eleophiles). Limnophils, depending on the substrate, are subdivided into ecological groups: phytophils, lithophiles, pelophiles, pelo-psammophiles. The most typical representatives of the latter in the water bodies of Central Asia are inhabitants of fresh waters (*Euglesa conica*, *E. feroense*, *E. fedderseni*, *E. zugmayeri*, *E. borealis*, some representatives of the genus *Odhneripisidium*) and brackish waters of 6 species of the genus *Caspihydrobia* *Peudocaspia issykulensis*; : *Cinnagafurovi*, *C.depressa*, *C.klinensis*, *Anisus centralis*, *Musculium hungaricum*, *Colletopterum ponderosum*, some species of the genera *Euglesa* and *Odhneripisidium*, phytophilam: *Cinnastolickiana*, *Boreolonacaerulans*, *Digonistomakashmirensis*, *crematorium* a *Dreissenacaspiapallasi* belongs to the brackish water pelolimnophiles. In the reservoirs of Central Asia there is an acclimatizer of brackish waters - pelo-psammolimnophil - *Adacnacolorata*. Telmatophiles, inhabitants of puddles, are unequal, and therefore they are divided into inhabitants of periodic water bodies (*Cinnina umbilicata*, *Lymnaea aberlani*, *L.iliensis*, *L.saridalensis*, *L.terebrabolotensis*, *Aplexahypnorum*) and drying up water bodies. Of the Central Asian mollusks, only *Lymnaea kazakensis* and *Planorbis stenostoma* belong to this group. These groups of reservoirs differ in that in the former the bottom is covered with moisture-loving vegetation and they dry out for a period of 1 to 3 months, in the latter the bottom is bare clay and dry up for a period of more than 4 months.

It should be noted separately phytophils - inhabitants of thickets of rivers and stagnant water bodies - *Lymnaea stagnalis*, *L.fragilis*, *Costatella acuta*, *C.integra*, *Planorbis planorbis* and 5 species of the genus *Anisus*.

In the considered ecological groupings, the composition of species is very often relative, since some of the representatives of these groups can inhabit adjacent biotopes. A striking example of this is the views of the *Galbas.str* section. (subgenus *Galba*) which include: *Lymnaea truncatula*, *L.gaupili*, *L.oblonga*, *L.subangulata*, *L.thiesseae*, *L.shirazensis*, forming a special group of madicol mollusks that inhabit wet surfaces (i.e. wet walls and slopes) ... These species can also be found in drying up water bodies and in springs (in the latter, wet surfaces are very common), as well as at the water edge of large water bodies. The species of the section *Montigalba* (*L.tengriana*, *L.almaatina*, *L.bowelli*) live in springs and are thus limnocrenophilous.

*L. lagotis* is an inhabitant of semi-permanent water bodies (i.e., drying up for a period of 20 days-1 month - according to Klimovich's classification). *Planorbisplanorbis*, *Pl.sieversi*, *Pl.tangitarenensis* and usually live there (they are all found in permanent water bodies). Semi-permanent water bodies, in contrast to periodic ones, are characterized by overgrowth with coastal aquatic vegetation.

From small bivalve molluscs - *Pisidumammicum* can live on sandy and silty soils of rivers and lakes. Typical eurybionts are phytophils - *Lymneasubdisjuncta*, *L. bactriana*, *L.fontinalis* and telmatophiles - *L. lagotis*, *Anisusladacensis*, *Planorbisplanorbis*, etc.

Thus, in the water bodies of the studied territories, aquatic mollusks of Central Asia are represented by various (6) ecological groups, the leading place among which is occupied by phytophils-9 (30.00%) species, crenophiles-5 (16.67%), pelolimnophiles-3 (10 %), pelosammolimnophiles (6-66%), telmatophiles-1 (3.33%) and madicol-3 species (3.33%).

Distribution of ecological groups of aquatic molluscs in the river basins of Central Asia.

№	Types of molluscs	AmuDarya	Syrdarya	Environmentalgroups
1.	<i>Cincinnagafurovi</i>	+		Pelolimnophil
2.	<i>C. pisinalis</i>		+	Peloriophilus
3.	<i>Caspiohydrobiaelongata</i>	+		Pelo- psammolimnophilbrackishw ater
4.	<i>Kainarella minima</i>	+		Thermocrenophile
5.	<i>K. likharevi</i>		+	Crenophilus
6.	<i>Bucharamnicolabucharica</i>	+		Crenophilus
7.	<i>Martensamnicolabrevicula</i>	+	+	Crenophilus
8.	<i>M.hissarica</i>	+	+	Crenophilus
9.	<i>Lymneastagnalis</i>	+	+	Phytophil
10.	<i>L.gaupili</i>	+		
11.	<i>L.truncatula</i>	+	+	Madicol
12.	<i>L.subangulata</i>	+	+	Madicol
13.	<i>L.bowelli</i>	+	+	Limno-crenophilus
14.	<i>L.hookeri</i>	+	+	Telmatophilus
15.	<i>L.auricularia</i>	+	+	Phytophil
16.	<i>L.bactriana</i>	+	+	Phytophil
17.	<i>L.alticola</i>	+	+	CrenophileandThermocreno phile
18.	<i>L.subdisjuncta</i>	+	+	PhytophiltoPelolymnophil
19.	<i>Costatellaacuta</i>	+	+	Phytophil
20.	<i>C.integra</i>	+	+	Phytophil
21.	<i>Planorbisplanorbis</i>	+	+	Phytophil
22.	<i>Anisusacronuicus</i>	+	+	Phytophil
23.	<i>A.conveniusculus</i>	+	+	Phytophil
24.	<i>Sinlanodontagibba</i>		+	Peloriophilus
25.	<i>Colletopterumbactrianum</i>		+	Peloreophilus
26.	<i>C.sogdianum</i>	+	+	Peloreophilus



27.	<i>C.kokandicum</i>		+	Pelolimnophil
28.	<i>Corbicula cor</i>	+		Peloreophilus
29.	<i>C.purpurea</i>	+	+	Peloreophilus
30.	<i>Corbiculinaferghanensis</i>	+	+	Peloreophilus

Due to the variety of types of water bodies, we will analyze the malacofauna of each type separately. Moreover, all reservoirs of Central Asia can be divided into 2 categories: natural and artificial. The first category includes streams and rivers; springs; warm and hot springs; fresh, brackish and salty lakes; carp swamps and swamps, puddles (temporary reservoirs); to the second-ditches; artificial reservoirs-haus, ponds (including ribovodny ponds); rice fields; main and shallow irrigation, drainage and discharge canals; reservoirs.

## LITERATURE

1. Zhadin VI Freshwater mollusks of the USSR-Lensnabtekhizdat, 1933.-232s.
2. Zhadin VI Fauna of rivers and reservoirs // Tr. In-ta.-L. : Publishing house Zool. Institute of the USSR Academy of Sciences, 1940-T.5, issue. 3-4.-991s.
3. Izzatullaev Z. Bivalve mollusks of the family of Central Asia // Zool. Journal-1980 a. T. 59, no. 8, pp. 1130-1136.
4. Izzatullaev Z. Mollusks of aquatic ecosystems of Central Asia // Toshkent monograph Lessonpress 2018.
5. Izzatullaev Z. Ecological grouping of freshwater mollusks of Central Asia // Mollusks. Systematics, ecology of distribution patterns. L.: Science, 1983-p. 132-135- (Author's abstract of reports. Sat.7). :

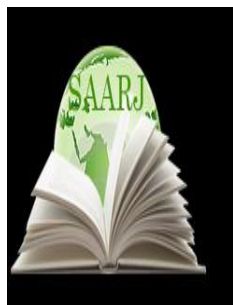

**ACADEMICIA**  
**An International**  
**Multidisciplinary**  
**Research Journal**  
 (Double Blind Refereed & Peer Reviewed Journal)

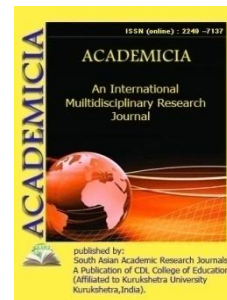

**DOI: 10.5958/2249-7137.2021.01132.0**

## LINGUISTIC FEATURES OF UZBEK AND FRENCH WORDS WITH THE WORD "TOUR"

**Hamzayev Hasan Rajabboyevich\*; Miyassarov Eldor Amanovich\*\***

\*Lecturer,

Department of French Language and Literature,  
 Karshi State University, UZBEKISTAN  
 Email id: kkhazayev@yahoo.com

\*\*Lecturer,

Department of French Language and Literature,  
 Karshi State University, UZBEKISTAN  
 Email id: miyassarov.eldor@mail.ru

### ABSTRACT

*Today, the development of tourism in the Republic of Uzbekistan is growing from year to year, due to the fact that in our article the tourism industry is one of the fastest growing. The use of terms entering this field from the point of view of this field forces them to be studied carefully. We will consider them on the example of Uzbek and French, as well as on the example of words with the word "tour" in the field of tourism.*

**KEYWORDS:** *Tour, Tourism, Tornado, Tourist Turpolisiya, Turfirma, Turpaket, Turmarket, Turmarshurt, Tur-Farm.*

### INTRODUCTION

Tourism is one of the fastest growing industries. The use of terms entering this field from the point of view of this field forces them to be studied carefully. We can see this in the example of the Uzbek and French languages, as well as in the field of tourism with the word "tour".

As a field develops in the world, new words begin to enter that field. It follows that the introduction of a new word means the addition of terms related to the same field. This means that the field of tourism, which we have chosen as the basis of our research, is also one of the areas that is developing from year to year, and new terms are entering the field. From this point of view, the accidental entry of terms in any field of human professional activity is not a mere process. Any set of terms, even if not structured without additions, is structurally related and has

a unique structure. The terms are not randomly grouped, but grouped based on the systematic nature of the science, the knowledge they serve.

This article is about words made with the word "tour". The word "tour" comes from the Latin word "turno" which means to wrap, to turn, and in French the word "tour" means to turn, turn, turn, and again it is The type is a strong tower. It is a special high place built to watch the cities, castles and shahristans from the enemy's attack. It is noteworthy that the lexical meaning of the word is reflected in the fact that the towers are usually circular. It is also used in dance as a term for rotational movement; If we understand a tour as a journey to a specific destination and return to one's destination, in French the word also means: for example; grand tour - a journey of rich people with their families all over Europe; tour de concert (tour de concert) concert tour is a type of travel in which artists and composers travel in different countries within the same music. In addition, the word "tour" reflects the stages of selection in sports competitions. For example, the Tour de France is a bicycle race that has been held in France for many years.

Any word sign (including and a term of a particular language has a national-cultural identity, which does not mean that there is any special cultural component in its semantics: any element of the content plan in oral speech (denotative, emotional, linguistic and empirical) may have cultural specificity. However, the national specificity of a terminological (primarily non-equivalent) dictionary may be explicit or minimal because only ma There is a peculiar systemic connection of the verbal sign in a certain national language. This phenomenon is undoubtedly peculiar to tourism terminology.

The Uzbek language also has new words (neologisms) formed by the word "tur". The word tour actually means organizing excursions for tourists in a specific direction, with a set of services and a definite duration. It is noteworthy that the words formed by the word "tour" are not translated into Uzbek, but are directly assimilated. For example, the word tourism is a mastered word formed by adding a suffix -izm to the word "tour". This means that a person leaves his / her place of permanent residence for a period of one year without engaging in paid activities at the place (country) where he / she is going for professional, health or other purposes.

A tourist is a person who has a pre-planned purpose and desire to travel to certain places, or a person who crosses the border for a period of not less than 24 hours and not more than 6 months in order to satisfy his interests. Tourist police is a word formed by adding the word "police" to the word "tour" and is responsible for the safety of tourists in special clothing. There is no exact alternative to this word in Uzbek; travel agency - a manufacturing company that organizes and offers travel in cooperation with different countries; tour operator - a person who organizes a trip for tourists and is directly responsible for this trip; tour package (travel product) - a travel bag provided to tourists, which includes the cost of transportation to hotels, restaurant and kitchen services, a list of travel destinations, health insurance and other services; travel agent - a person who establishes contacts with other foreign travel agencies, sells them travel packages (travel products) and advertises and offers travel products; Tour route - a place where tourists can travel, historical monuments and modern buildings and other tourist attractions.

The word tour can be followed by other words. For example, the word business tour can be a type of trip or fam-tour, fam-travel related to the professional activity of the tourist, and it is a privileged tourism, organized to introduce a tourist destination or center of a particular country,

and This tourism industry can be called advertising tourism, and there are many similar examples.

In general, the terms of tourism, which are included in the Uzbek language dictionary, are important because they are not translated into Uzbek, as such terms are important because they lose their translation properties when translated.

#### **LIST OF USED LITERATURE**

1. Vinogradova L. Terminology turizmaangliyskogoirusskogoyazykov v synchronnomidiachronnomaspektax: avtoref. diss.kand.filol.nauk. - Veliky Novgorod, 2011.
2. "Terminology of international tourism in modern Russian"
3. Alkudax Amdjad Kasim Mohammad Candidate of Science, Abstract, 2020

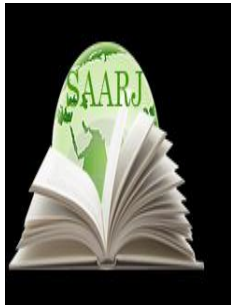

**ACADEMICIA**  
**An International**  
**Multidisciplinary**  
**Research Journal**  
 (Double Blind Refereed & Peer Reviewed Journal)

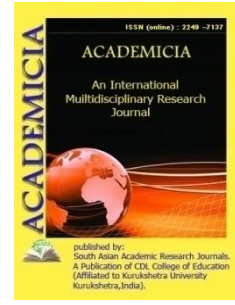

**DOI: 10.5958/2249-7137.2021.01133.2**

**MODERN METHODS FOR DIAGNOSING THE FUNCTION OF  
 EXTERNAL RESPIRATION IN CHILDREN WITH  
 BRONCHIAL ASTHMA**

**Barno Turdikhodjaevna Khalmatova\*<sup>\*</sup>; Gulnoza Aloyevna Tashmatova\*\*<sup>\*\*</sup>;  
 Nargis Khayrullayevna Mirsalikhova\*\*\*<sup>\*\*\*</sup>**

\*DSc, Professor,  
 Department of Children's Diseases,  
 Tashkent Medical Academy, UZBEKISTAN

\*\*Senior Lecturer,  
 Department of Children's Diseases,  
 Tashkent Medical Academy, UZBEKISTAN

\*\*\*Associate Professor,  
 Department of Children's Diseases,  
 Tashkent Medical Academy, UZBEKISTAN

**ABSTRACT**

*The aim of the study was to study the validity of spirometry and bodyplethysmography methods for assessing the functional state of the bronchopulmonary system in children with bronchial asthma. Materials and methods. 62 children were examined, among them 27 children with a diagnosis of moderate bronchial asthma and 35 children are conditionally healthy children. All patients underwent a comprehensive study of respiratory function indicators in compliance with research standards. Results. When analyzing the FEV1 / FVC index, which characterizes the presence of bronchial obstruction, it was found that in the group of children with BA it was 69.6%, while in the control group it was 97.53%. The analysis of the results of bodyplethysmography showed an increase in ROL up to 117.2% (p < 0.005) in children with bronchial asthma, relative to children in the control group (96.9%). Conclusions. Revealed a significant increase in ROL relative to the control group. Based on this, to clarify the presence of disturbances in external respiration and pathology of small bronchi in children with bronchial asthma, a more in-depth examination, in particular, bodyplethysmography, is required.*

---

**KEYWORDS:** *Asthma, Diagnostics, Bodyplethysmography, Spirometry, Children.*

---

## INTRODUCTION

Bronchial asthma (BA) is one of the most common diseases in all age groups, including children [1]. According to the WHO, the prevalence of asthma has reached the level of 5% among adults and 10% among the child population of the planet [3,5,6]. Bronchial asthma develops more often among preschool children (80%), often the first attacks occur already in the first year of life [4]. Recently, practical doctors have been paying great attention to assessing the functional state of the lungs. Respiratory function (RPF) indicators are important both for diagnosing, determining the severity of the disease, and for choosing treatment programs. Dynamic monitoring of patients with recurrent respiratory function studies allow you to make changes to the treatment, to predict the course and even the outcome of respiratory diseases in children. The main task of the study of the function of external respiration in most patients is to establish disorders of the ventilation capacity of the lungs, among which obstructive ones predominate, i.e. caused by changes in the passage of air through the tracheobronchial tree [6,10]. Less commonly, restrictive or restrictive disorders are diagnosed due to changes in the elasticity of the lung tissue. Unlike adults, the growth and development of bronchopulmonary structures continues in childhood [8,10]. This explains the fact that even in the presence of chronic diseases of the respiratory system, due to the high compensatory capabilities, pulmonary dysfunctions are often absent.

Children suffering from bronchial asthma often have normal functional parameters, not only during remission, but even in the stage of exacerbation of the disease [2,4]. The most complete characterization of the ventilation capacity of the lungs is possible when examining the structure of the total lung capacity. The method of body plethysmography, simultaneously with the study of the total lung capacity (TLC), makes it possible to assess bronchial resistance, which is sufficient to diagnose the nature and degree of disorders.

In recent years, the understanding of the processes occurring in the airways of a patient with asthma has been supplemented by information about the role of small airways in the development of bronchial inflammation. Inflammation in the small bronchi in bronchial asthma leads to an increase in peripheral resistance, the appearance of nocturnal symptoms of asthma, repeated exacerbations, the formation of "air traps", despite ICS therapy [7]. In patients with mild BA compared with healthy children, the resistance in the small bronchi is 7 times higher, although the indicators of pulmonary function are within the normal range. [8].

**The aim of study** of the validity of spirometry and bodyplethysmography methods for assessing the functional state of the bronchopulmonary system in children with bronchial asthma.

## MATERIALS AND METHODS

In total, a comprehensive assessment of the state of the bronchopulmonary system was carried out in 62 children aged 12 to 18 years. Among them there are 27 children diagnosed with moderate bronchial asthma. The comparison group included "conditionally healthy" children of the same age and sex (n = 35). The diagnosis of BA was established in accordance with the International Consensus on Diagnosis and Treatment of BA (GINA, 2014, 2018). Among the surveyed children, 40.3% (n = 25) were girls, 59.6% (n = 37) were boys (Table 1). The average age of the surveyed was  $15.27 \pm 7.69$  years. The length of the illness averaged  $3 \pm 1.1$ .

**TABLE NO1 INDICATORS OF BA PATIENTS INCLUDED IN THE STUDY**

No	Number of patients, n = 62	
1	Average age in years	
		14,21±1,9
2	Sex	boys
		girls
		37 (59,6%)
		25(40,3% )
3	Diagnosed with BA	
	"Conditionally healthy"	
		27 (43,5%)
		35 (56,4%)

Of the functional tests, spirometry was performed using a Microlab apparatus (England). The parameters of the forced expiratory volume in 1 second (FEV1), forced vital capacity (FVC) and the FEV1 / FVC ratio were assessed after the test with a bronchodilator (MDI Salbutamol, 200 µg). For the purpose of a more in-depth examination, bodyplethysmography was performed using the "Master Screen Body" apparatus (Jaeger, Germany). Statistical analysis was performed using the STATISTICA 10 software.

## RESULTS AND DISCUSSION

The FEV1 value in children with asthma was 92.4%, in children in the control group - 100.2%. When analyzing the FEV1 / FVC index, which characterizes the presence of bronchial obstruction, it was found that in the group of children with BA it was 69.6%, while in the control group it was 97.53%. When spirometry was performed in children with BA after inhalation of 200 µg of salbutamol, the FEV1 level was 101.2% and was comparable to the values of children in the control group. The FEV2 / FVC indicator was within the normal range and amounted to 70.3% in the group of children with BA and 95.2% in the group of "conditionally healthy" children.

To monitor the effectiveness of the treatment in order to prevent exacerbations and prevent the progression of the disease, it is very important to timely identify changes in bronchial patency using modern diagnostic methods. The variety of available equipment for studying the parameters of external respiration raises the question of choosing high-quality devices that meet modern standards and are reliable in operation. For doctors working with children, these requirements are supplemented by taking into account the age characteristics of their patients. To date, a research method that meets all these requirements is a bodyplethysmograph.

We carried out an additional examination to identify pathological abnormalities in volumetric parameters in children with BA using the bodyplethysmography method. The indices of intrathoracic pressure and residual lung capacity corresponded to normal values and did not differ statistically significantly in the study groups. A significant difference was obtained in the indicator of residual lung volume (ROL), which allows assessing the presence of pathology in the small airways (PSA) [4]. As you know, bronchial asthma of any severity is characterized by an inflammatory process in the respiratory tract, which develops as a result of a complex interaction of genetic factors and environmental factors [6]. In our study, we obtained a statistically significant increase in ROL up to 117.2% ( $p < 0.005$ ) in children with bronchial asthma, relative to children in the control group (96.9%). Despite the fact that similar indicators were obtained by the spirometry method, in children of the main group, after taking salbutamol, ROL was within the reference values, the revealed significant difference in the direction of

increasing this criterion in patients with BA indicates the presence of a pathological process in the small bronchi.

## CONCLUSIONS

Considering the above data, it can be concluded that in children with controlled bronchial asthma, when determining the lung function by spirometry, obstructive disorders are not detected, although the FEV1 and FEV1 / FVC indicators are statistically lower than in the group of healthy children. Revealed a significant increase in ROL relative to the control group. Based on this, to clarify the presence of disturbances in external respiration and pathology of small bronchi in children with bronchial asthma, a more in-depth examination, in particular, bodyplethysmography, is required.

## REFERENCE

1. Andreyeva A. O., Topalov F. S. Bodipletizmografiyakametoddiagnostikinarusheniyfunktsiidykhaniya u detey s bronkhial'noyastmoy //III International Scientific and Practical Conference" Methodology of Modern Research"(March 29, 2017, Dubai, UAE). – P. 23.
2. Ernu B., Zhob A. Vliyaniye obshchego osteopaticheskogo lecheniya na funktsiyu vneshnego dykhaniya detey, stradayushchikh astmoy //Rossiyskiy osteopaticheskoy zhurnal. – 2020. – №. 3. – S. 137-145.
3. Geppe N. A. idr. Bronkhofonograficheskoyeissledovaniyelegkikh u bol'nykhbronkhial'noyastmoyrannegovozrasta //Pul'monologiya. – 2020. – №. 3. – P. 38-41.
4. Khalmatova B. T. et al. Influence Of Ecological Factors On The Development And Progress Of Bronchial Asthma In Children //European Journal of Molecular & Clinical Medicine. – 2021. – T. 7. – №. 8. – C. 4374-4377.
5. Lebedenko A. A. idr. Bodipletizmografiyakametoddiagnostikinarusheniyfunktsiidykhaniya u detey s bronkhial'noyastmoy //International Scientific and Practical Conference World science. – ROST, 2017. – T. 6. – №. 4. – P. 23-25.
6. Lukina O.F. Sovremennyyemetodyissledovaniyafunktsiilegkikh u detey – ZH.Lechashchiyvrach -2003 №3
7. Mineyeva Ye. Ye. i dr. Funktsional'noyesostoyaniyemalykhdykhatel'nykhputey u patsiyentov s bronkhial'noyastmoy, assotsirovannoy s ozhireniyem //Terapevticheskiyarkhiv. – 2019. – T. 91. – №. 1.
8. Mirrakhimova M. KH., Khalmatova B. T., Toshmatova G. A. Bronkhial'nayaastma u detey: sovremennyyvzglyadnaproblemu. – 2019.
9. Neklyudova G. V., Chernyak A. V., Kevorkova M. S. Parametryfunktsiivneshnegodykhaniya: sravneniyedvukhbodipletizmografov //Prakticheskayapul'monologiya. – 2019. – №. 2.
10. Toshmatova G. A., Shakarova M. S. Q. Meaning Of Respiratory Mycoplasma Infection In Children With Bronchial Asthma //The American Journal of Medical Sciences and Pharmaceutical Research. – 2020. – T. 2. – №. 12. – C. 47-54.



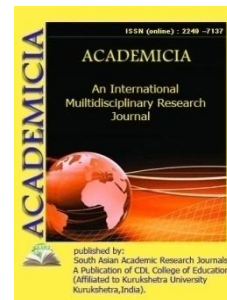

DOI: **10.5958/2249-7137.2021.01134.4**

## TO STUDY THE FREQUENCY OF PARASITOSIS AMONG CHILDREN WITH ALLERGIC DISEASES

**Kasimova M.B\***; **Mirrakhimova M.Kh\*\***; **Yakhyayeva K. Z\*\*\***

\*Senior Lecturer,  
Tashkent State Dental Institute,  
Tashkent, UZBEKISTAN

\*\*DSC, Docent of the Department of Children's Diseases,  
Tashkent Medical Academy, UZBEKISTAN  
Email id: mmh.20@mail.ru,

\*\*\*Docent of the Department of Children's Diseases,  
Tashkent Medical Academy,  
UZBEKISTAN

### ABSTRACT

*The presence of parasitic invasion (PI) affects not only the prevalence of allergic diseases in the population, but also the severity of the clinical manifestations of the disease. The maximum detect ability of parasitic invasions is observed in children under 6–11 years of age, nematodes prevail in boys, and giardiasis occurs with the same frequency in boys and girls [7]. In patients with allergic rhinitis, giardiasis was also significantly more often detected - 24 children (80.0%), 5 children suffered from ascariasis (16.7%), one child had a combined parasitic invasion (3.3%). Thus, the studied samples of children were comparable in gender, age and living conditions. The main group consisted of 100 patients with bronchial asthma (37%), 100 (37%) - with allergic rhinitis, 70 (25.9%) - with atopic dermatitis.*

**KEYWORDS:** Prevalence, Nematodes, Prevail

### INTRODUCTION

The growing prevalence of allergic diseases (AD) is a serious medical and social problem in all countries the world [5,9,10]. In the world, according to epidemiological studies, the prevalence of AD is from 15 to 35%, while children most often suffer [4]. At its core, ADs not only have a

hereditary predisposition, but belong to multifactorial diseases [1,8], while the modifying role is played by the invasion of helminths and lamblia [2,6].

The prevalence of helminth-protozoal infections is also quite high: at present, about 500 species of helminths parasitizing humans have been registered in the world [1, 10]. The presence of parasitic invasion (PI) affects not only the prevalence of allergic diseases in the population, but also the severity of the clinical manifestations of the disease. The pathological effect of all parasites (P) is due to the modulating effect on the human immune system [6,9]. According to many researchers, the processes characteristic of allergic reactions: blood eosinophilia, overproduction of immunoglobulin E (IgE), release of mediators by mast cells, mucus hyper secretion, interleukin synthesis are a protective reaction and a manifestation of the body's mobilization in the fight against parasites [3,4]. On the one hand, the data of numerous experimental studies demonstrate an inverse relationship between the presence of parasitic invasion and the activity of the inflammatory process in allergic diseases [2]. On the other hand, parasites and their metabolic products are allergens, cause inflammatory changes, have a sensitizing effect, which initiates the development of chronic allergic diseases such as urticaria (C), atopic dermatitis (AD), bronchial asthma (BA) [3,5]. According to some authors, the evolutionary phenomenon of an allergic reaction was formed exclusively due to the molecular similarity of antigens of parasites and antigens entering the body from the outside (dust, pollen, food), which determines the development of nonspecific sensitization in the infected [4]. In this regard, it is extremely important to determine the role of parasitosis in the formation of allergic diseases, to assess objective allergy diagnostics in the combined course of allergic diseases and parasitic invasions in children, to optimize their treatment, and to increase the effectiveness of controlling risk factors.

**Purpose of work.** Determine the frequency of occurrence of parasitosis among the observed children with allergic diseases.

**Research results.** At the initial stage of the study, we conducted a comparative study of the frequency of occurrence of parasitosis in samples of children with allergic diseases, as well as children without allergic diseases. The study involved 300 children aged 2 to 16 years, inclusive:

- The main group: children with allergic diseases (n = 270, average age  $6.14 \pm 0.13$  years);
- Control group: children without allergic diseases (n = 30, average age  $6.41 \pm 0.21$  years).

According to a few studies, there is a relationship between the risk of parasitic diseases and the sex and age of the child, as well as dependence on living conditions. It has been shown that the prevalence of parasitosis is observed among urban residents than among the rural population [1].

The maximum detect ability of parasitic invasions is observed in children under 6–11 years of age, nematodes prevail in boys, and giardiasis occurs with the same frequency in boys and girls [7]. In this regard, we compared the children of the studied samples by gender, age and living conditions. Among the patients of the main group, there were more urban residents (151 children, 55.9%) than the rural population (119 patients, 44.1%). The same tendency was observed in children of the control group - 20 (67%) and 10 (33%), respectively ( $p = 0.52$ ).

So, among the children we studied, the largest proportion were boys: 149 (55.1%) in the main group and 18 (60.0%) in the control group ( $p = 0.121$ ). When comparing patients in the study samples by age the sign also did not reveal statistically significant differences. In the main group

of the studied children prevailed 4–7 years old (36.0%), in the control group: 4–7 (34.2%) and 8–12 (35.1%) years old. The smallest number of patients was at the age from 13 to 16 years, both in the main (15.0%) and in the control group (11.0%), ( $p = 0.124$ ). Thus, the studied samples of children were comparable in gender, age and living conditions. The main group consisted of 100 patients with bronchial asthma (37%), 100 (37%) - with allergic rhinitis, 70 (25.9%) - with atopic dermatitis. All children with bronchial asthma were diagnosed with an atopic form of the disease; by severity, 45 children had mild intermittent (45.0%), 32 (32.0%) - mild persistent, 21 (21.0%) moderate persistent and 2 children (2.0%) - severe persistent asthma. Intermittent AR occurred in 25 patients (25.0%), persistent - in 75 patients (75.0%). BP of mild, moderate, and severe severity was detected in 32.0–63.5–4.5% of patients, respectively. The presence of concomitant allergic diseases was detected in 181 patients, which amounted to 67.0%. Among comorbid pathologies, allergic rhinitis was most often recorded - 53 patients (19.6%), less often atopic dermatitis - 31 (11.4%). The control group consisted of 30 children without allergic diseases. According to the results of parasitological examination, among the studied children with allergic diseases, parasitic invasion was detected in 98 people, which amounted to 36.2%. Among the patients of the control group, helminthiasis and giardiasis were diagnosed only in 4 children (13.3%), ( $p = 0.000001$ ). Thus, the results of the study showed that the frequency of occurrence of parasitosis in the samples of children comparable in gender, age and living conditions is 2.7 times higher among patients with allergic diseases, compared with children without allergic pathology.

The most frequent clinical signs of parasitosis were: allergic syndrome (75.6%); dyspeptic (44.7%) and abdominal pain syndrome (35.6%); asthenoneurotic syndrome (21.4%); syndromes of damage to the gastrointestinal tract and hepatobiliary system: reactive changes in the liver and pancreas (38.9%), biliary dyskinesia (30.7%), cholecystocholangitis (8.1%), hepatosplenomegaly (10.4%), increased aspartate aminotransferase (18.1%), dysproteinemia (6.2%), hypersalivation (5.8%); anemic syndrome (18.0%); polylymphadenopathy syndrome (4.3%), body weight deficiency syndrome (18.5%), blood eosinophilia (59.9%).

In the structure of parasitic invasions in children with AD ( $n = 98$ ), giardiasis was most often recorded - 54% (53 patients), less often ascariasis - 38% (38 people), opisthorchiasis - 6.1% (6 children) and toxocariasis 1.0% (1 child). Moreover, 7 patients (7.1%) were found to have combined parasitic invasion. Among the combined invasions were identified: ascariasis + giardiasis (2 children), ascariasis + toxocariasis (1 patient), ascariasis + opisthorchiasis (2 children), giardiasis + opisthorchiasis (2 patients). The results of the study for enterobiasis, trichinosis, toxoplasmosis and echinococcosis in all children were negative. The lack of positive results of parasitological examination for enterobiasis, according to our data, was due to the timely detection and treatment of patients with this helminthiasis. According to the results of our study, the highest incidence of parasitoses was recorded in children of early, primary, and senior school age (45.3, 46.3 and 52.4%, respectively). The smallest number of parasitic infestations was found in children aged 4–7 years (33.7%). In the structure of parasitosis, the share of giardiasis among young children was 92.6% (25 patients), among preschoolers - 56.7% (17 people), among children of primary school age - 76.5% (26 people), which corresponds to the world data. Statistics [7]. Among parasitic invasions in patients aged 13–18 years, helminthiasis (ascariasis, opisthorchiasis, toxocariasis) prevailed - 77.3% (17 people), the proportion of giardiasis was only 22.7% (5 children). Parasitosis was more common among children with

atopic dermatitis(42.9%) and bronchial asthma (40.0%), somewhat less frequently in patients with allergic rhinitis - 35.3%. The highest percentage of positive results of parasitological examination was noted among patients with acute allergic urticaria - 22 people, which amounted to 68.8%. Among children with bronchial asthma, giardiasis - 73.4% (22 patients), less often ascariasis (6 children, 20.0%), opisthorchiasis(1 patient, 3.3%) and combined invasion (1 child, 3.3%).

In patients with allergic rhinitis, giardiasis was also significantly more often detected - 24 children(80.0%), 5 children suffered from ascariasis (16.7%), one child had a combined parasitic invasion (3.3%). In children with atopic dermatitis, the most common cases were giardiasis (66.7%), less often ascariasis (5 people, 16.7%), opisthorchiasis (4 children, 13.3%) and concomitant invasion (1 patient, 3.3%). Among children with acute allergic urticaria, giardiasis was equally common (8 people, 33.4%), ascariasis and opisthorchiasis - 6 patients each (25.0%), respectively. Two children were diagnosed with toxocariasis (8.3%) and two (8.3%) - combined invasion.

## FINDINGS

Thus, it can be assumed that in the pathogenesis of chronic allergic diseases, such as atopic dermatitis, allergic rhinitis and bronchial asthma, invasion by lamblia plays a key role, and both giardiasis and helminthiasis are alikely cause of acute allergic urticaria.

## LIST OF REFERENCES

1. Allergology and immunology / under the general. ed. A. A. Baranova,(revision 2014) / ed. A.S. Belevsky. - M.: Russian Respiratory Society, 2015.- 150 p.
2. Degarege, A. Association between intestinal helminth infections and underweight among school children in TikurWuha Elementary School, Northwestern Ethiopia /A. Degarege, B. Erko // J. Infect. Public Health. – 2013. – Vol.6,№ 2. – P. 125–33.
3. Global strategy for the treatment and prevention of bronchial asthmaHalafli, H.N. Influence of intestinal parasitoses on the health status of children //Fundamental research. - 2013. - No. 9. - P. 156-162.
4. Mirrakhimova M. X. et al /Antileukotriene Drugs in The Treatment of Atopic Dermatitis in Children. International Journal of Pharmaceutical Research |Jan - Mar 2021|Vol 13 | Issue 1: 2117-2121
5. Nishonboyeva N. Yu. et al.Digestive organs status in children with atopic dermatitis /Journal of Critical Reviews, 2020.7/5. 678-679
6. Heppe. // Pediatrics. Journal them. G. N. Speransky - 2012. - T. 91. –No. 3. - P. 76–92.
7. Geppe, N.A. Relevance of the Problem of Bronchial Asthma in Children.R.M. Khaitova. - M.: Union of Pediatricians of Russia, 2008 - 248 p.
8. S.A. Ibragimova et al /Comordid course of atopic dermatitis with bronchial asthma in children: frequency, clinical and allergological characteristics - Journal of Critical Reviews, 2020.7/17.2317-2321
9. WAO White book on Allergy. – 2011-2012. – P. 13
10. Zakirova U.I. et al /Analysis of The Prevalence of Bronchial Asthma in Children in Outpatient Clinics. International Journal of Pharmaceutical Research | Oct - Dec 2020 | Vol 12 | Issue 4: 759-765

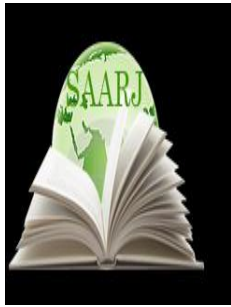

**ACADEMICIA**  
**An International  
 Multidisciplinary  
 Research Journal**  
 (Double Blind Refereed & Peer Reviewed Journal)

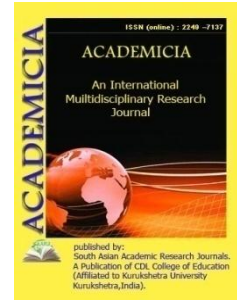

**DOI: 10.5958/2249-7137.2021.01135.6**

## FIND THE LENGTHS OF TWO TRAJECTORIES THAT DIVIDE AN ARBITRARY TRIANGLE INTO THREE EQUAL ANGLES

**Norkoziev Navruzбек Noralioglu\***

\*Mathematics Teacher,  
 56th comprehensive school of Sherabaddistrict of Surkhandarya region,  
 UZBEKISTAN  
 Email id: navruzbeknorqoziyev@mail.ru

### ABSTRACT

*In this paper, the angle of a triangle can be divided into 3 equal parts, and it is given to find 2 tresektrissa of different lengths coming out of one angle.*

**KEYWORDS:** Triangle, Angle, Triangle Surface, Bisector Ratio, Sin a Cos 2 a, Sin2 a, Triangle Ratio And Sides Ratio.

### INTRODUCTION

If we are given two sides of an arbitrary triangle ABC and one angle between them. Find two tresektrissa  $l_1$  and  $l_2$  that divide one of the angles of the triangle into three equal parts.

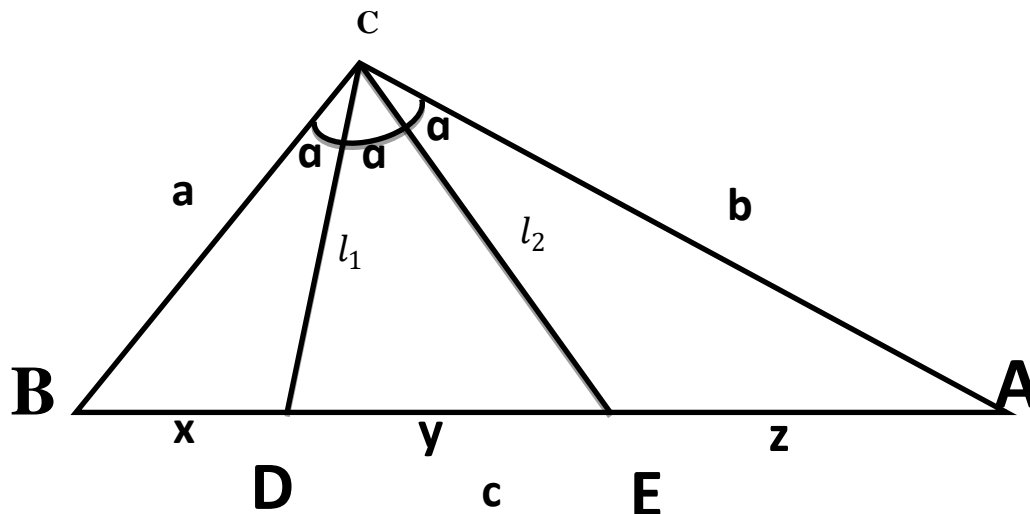

The sides of a triangle  $BC=a$ ,  $AC= b$ ,  $AB=c$  sides and  $\angle BCA=3\alpha$  let's say. Here are two bicycles  $AB$  side  $x$ ,  $y$  and  $z$  to lengths.  $AB=c= x+y+z$  get. Triangle  $BCE$  Let us give this formula when the angle of a triangle is equal to two.

$$\frac{a}{x} = \frac{l_2}{y}$$

Triangle  $DAC$  and for these formulas,  $l_1$  va  $l_2$  Let's simplify them.

$$\frac{l_1}{y} = \frac{b}{z}$$

$$l_1 = \frac{b^y}{z} l_2 = a \frac{y}{x}$$

Now we find that  $x$ ,  $y$ , and  $z$  are the sides of  $a$  and  $b$  and the  $3\alpha$  between them. To do this, we need this formula. The side of a triangle has the same proportion as the opposite side of the straight line from the end of the triangle..

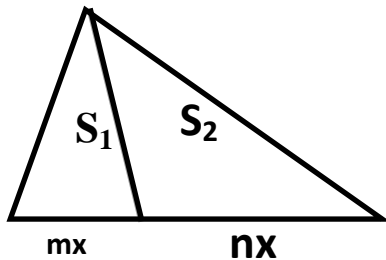

$\frac{S_1}{S_2} = \frac{m}{n}$  So based on this formula we get the ratio of the triangles  $BCD$  and  $CAD$ .

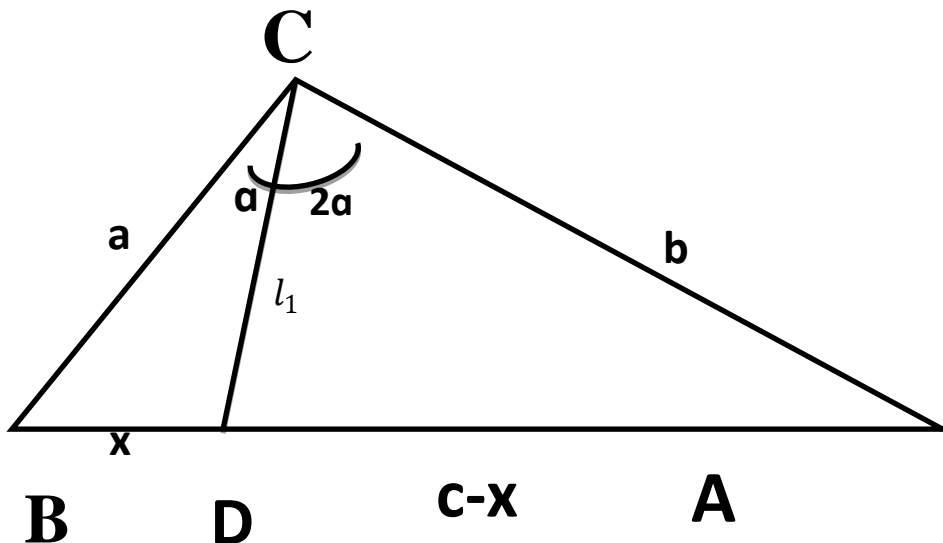

$$\frac{S_{BDC}}{S_{CDA}} = \frac{x}{c-x}$$

Now we write this on the surfaces of a triangle, come to the following formula, and simplify it by finding the  $x$  by shortening the denominator.

$$\frac{\frac{1}{2} a l_1 \sin \alpha}{\frac{1}{2} l_1 b \sin 2\alpha} = \frac{x}{c-x} \frac{a \sin \alpha}{2 b \sin \alpha \cos \alpha} = \frac{x}{c-x} \frac{a}{2 b \cos \alpha} = \frac{x}{c-x}$$

$$a (c-x) = 2b x \cos \alpha \qquad ac - ax = 2bxcos \alpha$$

$$ac = ax + 2bx \cos a \quad x(a + 2b \cos a) = ac$$

$$x = \frac{ac}{a + 2b \cos a}$$

So we found x and now we can find z in the same way.

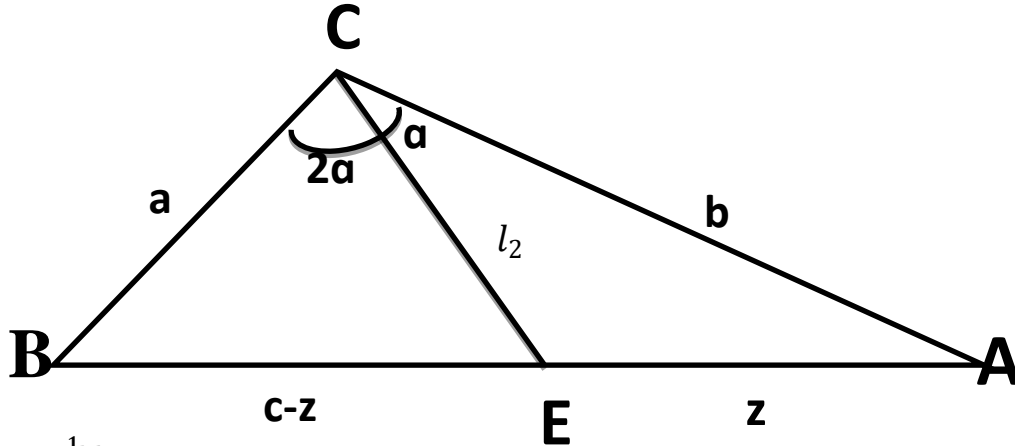

$$\frac{S_{CEA}}{S_{BCE}} = \frac{z}{c-z} \frac{\frac{1}{2}bl_2 \sin a}{\frac{1}{2}al_2 \sin 2a} = \frac{z}{c-z} \frac{b}{2a \cos a} = \frac{z}{c-z}$$

$$b(c-z) = 2a z \cos a \quad bc - bz = 2az \cos a$$

$$z = \frac{bc}{b + 2a \cos a}$$

So we found z, now we just have to find y. For this  $y = c - (x + z)$  we use.

$$y = c - x - z$$

$$y = c - \frac{ac}{a + 2b \cos a} - \frac{bc}{b + 2a \cos a} \quad y = c \left( 1 - \frac{a}{a + 2b \cos a} - \frac{b}{b + 2a \cos a} \right)$$

$$y = c \left( \frac{(a + 2b \cos a)(b + 2a \cos a) - a(b + 2a \cos a) - b(a + 2b \cos a)}{(a + 2b \cos a)(b + 2a \cos a)} \right)$$

Now we can just simplify the image by opening the parentheses and narrowing down the similar terms.

$$y = c \left( \frac{ab + 2a^2 \cos a + 2b^2 \cos a + 4ab \cos^2 a - ab - 2a^2 \cos a - ab - 2b^2 \cos a}{(a + 2b \cos a)(b + 2a \cos a)} \right)$$

$$y = c \left( \frac{4ab \cos^2 a - ab}{(a + 2b \cos a)(b + 2a \cos a)} \right) \quad y = \frac{abc(4 \cos^2 a - 1)}{(a + 2b \cos a)(b + 2a \cos a)}$$

So we found x, y, and z by the sides a, b, and the angle  $\cos a$

$l_1$  and  $l_2$  by shortening similar terms by placing them in place to find them

$l_1$  and  $l_2$  we can find.

$$l_1 = b \frac{y}{z} l_2 = a \frac{y}{x}$$

$$l_1 = b \frac{\frac{abc(4 \cos^2 a - 1)}{(a + 2b \cos a)(b + 2a \cos a)}}{\frac{bc}{b + 2a \cos a}} l_2 = \frac{ab(4 \cos^2 a - 1)}{a + 2b \cos a}$$

$$l_2 = a \frac{\frac{abc(4 \cos^2 a - 1)}{(a+2bc \cos a)(b+2a \cos a)}}{\frac{ac}{a+2bc \cos a}} \quad l_2 = \frac{ab(4 \cos^2 a - 1)}{b+2a \cos a}$$

So we have found  $l_1$  and  $l_2$ , now that we are working on examples of these formulas and checking that the faces of the three triangles separated by these tressektrissa must be equal to the faces of the common triangles.

Example 1: If the sides of a triangle are 5cm, 6cm and the angle between them is given by  $10^\circ$ , and find the angular tressektrissa that divide this angle into three equal parts.

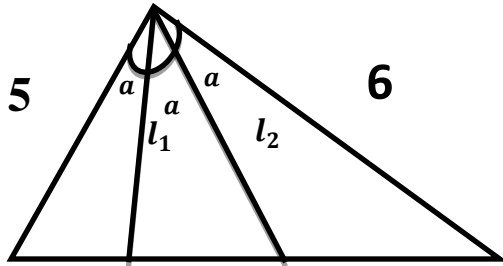

$$a=5 \quad b=6 \quad 3\alpha = 10 \text{ equal .}$$

The face of a triangle

$$S = \frac{1}{2} \cdot 5 \cdot 6 \sin 10^\circ = \\ = 15 \sin 10^\circ$$

$$l_1 = \frac{ab(4 \cos^2 a - 1)}{a+2bc \cos a} = \frac{5 \cdot 6(4 \cos^2 \frac{10}{3} - 1)}{5+12 \cos \frac{10}{3}} = \frac{30(4 \cos^2 \frac{10}{3} - 1)}{5+12 \cos \frac{10}{3}}$$

$$l_2 = \frac{ab(4 \cos^2 a - 1)}{b+2a \cos a} = \frac{30(4 \cos^2 \frac{10}{3} - 1)}{6+10 \cos \frac{10}{3}}$$

Now let's use these tressektrissa to check that the sum of the three triangles is equal to the total area of the triangle.

$$15 \sin 10^\circ = S_1 + S_2 + S_3 \quad S_1 = \frac{1}{2} a l_1 \sin \frac{10}{3} \quad S_2 = \frac{1}{2} l_1 l_2 \sin \frac{10}{3} \quad S_3 = \frac{1}{2} b l_2 \sin \frac{10}{3}$$

$$S = \frac{1}{2} \cdot 5 \cdot \frac{30(4 \cos^2 \frac{10}{3} - 1)}{5+12 \cos \frac{10}{3}} \sin \frac{10}{3} + \frac{1}{2} \cdot \frac{30(4 \cos^2 \frac{10}{3} - 1)}{5+12 \cos \frac{10}{3}} \cdot \frac{30(4 \cos^2 \frac{10}{3} - 1)}{6+10 \cos \frac{10}{3}} \sin \frac{10}{3} +$$

$$+ \frac{1}{2} \cdot 6 \cdot \frac{30(4 \cos^2 \frac{10}{3} - 1)}{6+10 \cos \frac{10}{3}} \sin \frac{10}{3}$$

Andy  $\frac{1}{2} \cdot 30 \cdot \sin \frac{10}{3} \cdot (4 \cos^2 \frac{10}{3} - 1)$  out of parentheses.

$$S = 15 \cdot \sin \frac{10}{3} \cdot (4 \cos^2 \frac{10}{3} - 1) \left( \frac{5}{5+12 \cos \frac{10}{3}} + \frac{30(4 \cos^2 \frac{10}{3} - 1)}{(5+12 \cos \frac{10}{3})(6+10 \cos \frac{10}{3})} + \frac{6}{6+10 \cos \frac{10}{3}} \right)$$

$$S = 15 \cdot \sin \frac{10}{3} \cdot (4 \cos^2 \frac{10}{3} - 1) \left( \frac{5(6+10 \cos \frac{10}{3}) + 30(4 \cos^2 \frac{10}{3} - 1) + 6(5+12 \cos \frac{10}{3})}{(5+12 \cos \frac{10}{3})(6+10 \cos \frac{10}{3})} \right)$$

$$S = 15 \cdot \sin \frac{10}{3} \cdot (4 \cos^2 \frac{10}{3} - 1) \left( \frac{30+50 \cos \frac{10}{3} + 120 \cos^2 \frac{10}{3} - 30 + 30 + 72 \cos \frac{10}{3}}{30+50 \cos \frac{10}{3} + 72 \cos^2 \frac{10}{3} + 120 \cos^2 \frac{10}{3}} \right)$$



$$S=15 \cdot \sin \frac{10}{3} \cdot (4 \cos^2 \frac{10}{3} - 1) \left( \frac{120 \cos^2 \frac{10}{3} + 122 \cos \frac{10}{3} + 30}{120 \cos^2 \frac{10}{3} + 122 \cos \frac{10}{3} + 30} \right) = 15 \cdot \sin \frac{10}{3} \cdot (4 \cos^2 \frac{10}{3} - 1) \cdot 1$$

Now let's add an extra formula here.

$$\begin{aligned} \sin 3a &= \sin (2a + a) = \sin 2a \cdot \cos a + \sin a \cdot \cos 2a = 2 \sin a \cdot \cos a \cdot \cos a + \sin a \cdot (2 \cos^2 a - 1) = \\ &= 2 \sin a \cdot \cos^2 a + 2 \sin a \cdot \cos^2 a - \sin a = 4 \sin a \cdot \cos^2 a - \sin a = \\ &= \sin a (4 \cos^2 a - 1) \end{aligned}$$

$$\sin \frac{10}{3} \cdot (4 \cos^2 \frac{10}{3} - 1) = \sin 3 \cdot \frac{10}{3} = \sin 10^\circ$$

$S = 15 \sin 10^\circ$  proved to be equal.

For example -2 :If the catheter of a right triangle  $AC=5$  smandhypotenuse

$AB=10$  smis equal to,  $C$  find the tresektrissa that divide the angle into three equal angles?

$$\text{Ergo } BC = \sqrt{10^2 - 5^2} = \sqrt{75} = 5\sqrt{3}$$

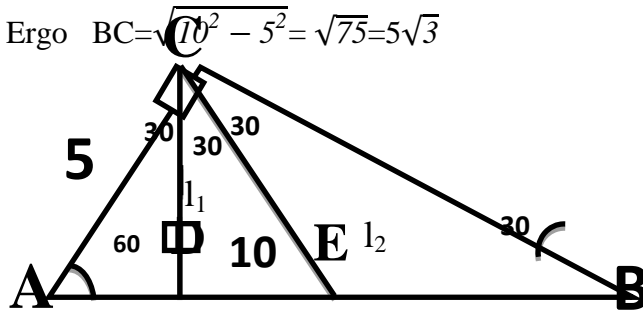

$$\begin{aligned} \sin B &= \frac{5}{10} \sin B = \frac{1}{2} \angle B = 30^\circ, \\ \angle A &= 60^\circ \text{ equally} \end{aligned}$$

Ergo  $\angle A = \angle E$  from equality  $AC = CE = l_2 = 5$  it turns out that,

$\sin B = \frac{l_1}{BC}$  which is derived from the triangular CDB and is calculated by putting it in place  $l_1$  let's find  $l_1 = BC \cdot \sin B = 5\sqrt{3} \cdot \sin 30^\circ = \frac{5\sqrt{3}}{2}$  equality arises. Now created in the beginning  $l_1$  and  $l_2$  let's recalculate and check for equality. Here  $\alpha = 30^\circ$  equal.

$$l_1 = \frac{ab(4 \cos^2 a - 1)}{a + 2b \cos a} = \frac{5 \cdot 5\sqrt{3}(4 \cos^2 30^\circ - 1)}{5 + 2 \cdot 5\sqrt{3} \cos 30^\circ} = \frac{25\sqrt{3}(4 \cdot \frac{3}{4} - 1)}{5 + 10\sqrt{3} \cdot \frac{\sqrt{3}}{2}} = \frac{50\sqrt{3}}{20} = \frac{5\sqrt{3}}{2}$$

$$l_2 = \frac{ab(4 \cos^2 a - 1)}{b + 2a \cos a} = \frac{5 \cdot 5\sqrt{3}(4 \cos^2 30^\circ - 1)}{5\sqrt{3} + 2 \cdot 5 \cos 30^\circ} = \frac{25\sqrt{3}(4 \cdot \frac{3}{4} - 1)}{5\sqrt{3} + 5\sqrt{3}} = \frac{50\sqrt{3}}{10\sqrt{3}} = 5$$

It follows that the formulas we have created are correct.

## REFERENCES

1. Geometry book for secondary school grades 8 Author: A.A. Rahimqoriyev, M.A. To'xtahodjoyeva. Tashkent -2019.
2. Geometry book for secondary school grades 9 Author: B Haydarov, E Sariqov, A Qo'shqorov. Tashkent -2019. 147-paje.

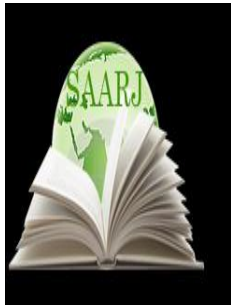

**ACADEMICIA**  
**An International**  
**Multidisciplinary**  
**Research Journal**  
 (Double Blind Refereed & Peer Reviewed Journal)

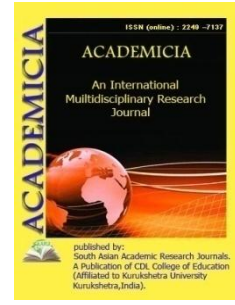

**DOI: 10.5958/2249-7137.2021.01136.8**

## THE IMPORTANT ROLE OF GYMNASTICS IN THE LIVES OF GIRLS

**Asadova Shahlo Tulaboyevna\***

\*Teacher of school,  
Tashkent, UZBEKISTAN

### ABSTRACT

*This article identified the real reasons why you should enroll your daughter in gymnastics classes. The benefits of Gymnastics classes in girls life were discussed in this work. As far as I am concerned gymnastics is one way to help make that happen. I think the fact that it's largely a female sport, makes gyms an ideal place for little girls to start to learn self-confidence as they exercise their bodies. Children and adolescents between the age of 6 and 17 should get 60 minutes or more of physical activity a day. And as part of their 60 minutes of physical activity a day, they should include muscle and bone strengthening activities at least three days a week.*

**KEYWORDS:** *Flexibility, Physically And Mentally Healthy, Sports, Activities, Gymnastics Classes*

### INTRODUCTION

It is fact that we all want to help our daughters grow up to be physically and mentally healthy and to give them greater odds of success later in life. In this article I'm going to tell you the benefits of gymnastics: how gymnastics positively impacts young girls and the some real reasons you should enroll your daughter in gymnastics. I work at school №223 as a physical training teacher and I have my lovely girl pupils, I will want to do everything possible to make sure they are strong, confident, healthy women when they grow up. As far as I am concerned gymnastics is one way to help make that happen. I think the fact that it's largely a female sport, makes gyms an ideal place for little girls to start to learn self-confidence as they exercise their bodies. And as they grow up, become teenagers on a gymnastics team with girl friends that empower and root for one another.

#### **1. Gymnastics will help to make your daughter strong.**

Swinging on the bars and learning skills like cartwheels that require her to support her own body weight build strength from an early age. It's important to teach our girls when they are young

that not only is being strong good for the body, but it's important in life. Strong girls are healthy, pretty girls.

## **2. Gymnastics will increase your daughter's flexibility.**

Every gymnastics class begins with a warm-up that includes stretching and splits, and then throughout the rest of the class gymnasts learn and practice skills that require them to use their flexibility. According to statistics "Better flexibility may improve your performance in physical activities or decrease your risk of injuries by helping your joints move through their full range of motion and enabling your muscles to work most effectively". So, better flexibility will decrease the risk of your daughter getting injured from gymnastics or any other physical activity she does.

## **3. Gymnastics will keep her fit and help her develop the habit of staying active.**

We know that young people need to be more active and fit. It's such a problem in some countries that they try to solve the epidemic of childhood obesity. Children and adolescents between the age of 6 and 17 should get 60 minutes or more of physical activity a day. And as part of their 60 minutes of physical activity a day, they should include muscle and bone strengthening activities at least three days a week. Gymnastics is one of the most diverse sports in terms of the types of exercises and muscles it develops. Gymnastics works to enhance a gymnast's strength, flexibility, speed, balance and coordination. For example, the vault develops speed and power, bars is an endurance event and beam improves a gymnast's flexibility and balance. Having this flexibility and strength (especially core strength) skill set base as a teenager will prepare girls for yoga, pilates and other cardio exercise classes as young adults. Knowing they can take exercise classes like this without excessively struggling will help them maintain their healthy exercise habits while working or going to school.

## **4. Gymnastics will make your daughter a well-rounded athlete, and teach her skills that will enhance other sports.**

Gymnasts are flexible, agile and strong, with coordination, balance and flexibility. These are important traits in gymnastics and in other sports. For example, learning how to run fast for the vault would be important in not only track and field, but basketball or valley ball. Balance and flexibility are useful if she ever wants to join a dance team. And gymnastics skills such as tumbling skills and jumps are an important part of cheerleading. Wouldn't it be great if when your daughter's in high-school or middle school and she wants to try out for the cheerleading team, she had a decent shot? Taking gymnastics classes as a young girl will teach her skills that will help her participate in gymnastics, cheerleading or other sports if she wants to.

## **5. Gymnastics will teach your daughter balance.**

What better tool for learning balance than the balance beam? Learning to walk on a low beam first and then a high beam will teach balance at a young age. And this balance will help your gymnast learn how to ride a bike. Gymnasts learn to not only balance on their feet, but on their hands. A handstand is the ultimate balance skill, learning to control your body in order to hold yourself up on your hands.

## **6. Gymnastics will teach your daughter to fall, helping to prevent her from getting injured in other sports or activities later in life.**

One of the first things on the agenda in any beginner gymnastics class is to learn how to fall safely. Falling and putting your arms behind you is one of the first things gymnasts are taught not to do, as this is an easy way to break your arms. It's easier and safer to learn how to fall correctly in a gymnastics gym because of the many mats and foam pits to use when doing falling drills. Learning how to fall young will become instinctual and protect her from unnecessary injuries later in life.

### **7. Gymnastics will help her develop hand-eye and foot-eye coordination.**

Kids aren't just born with good body awareness and hand-eye, foot-eye coordination. Gymnastics is a great way for kids to learn how to make their body do what their brain is telling them to. Crawling through the pit, swinging from the bars, jumping on the trampoline, learning how to roll on floor mats—all of these exercises help kids learn how to move their body.

### **REFERENCE:**

1. AMERICAN ANOREXIA/BULIMIA ASSOCIATION INC. Beware the shrinking Olympic gymnast. American Anorexia/Bulimia Association, Inc. Newsletter Spring: 8, 1994.
2. ANDERSEN, A. E. Eating disorders in males: a special case? In: Eating, body weight and performance in athletes, edited by K. D. Brownell, Rodin, J., and Wilmore, J. H. Philadelphia, PA: Lea &Febiger, 1992, p. 172-188.
3. BAILEY, B., AND N. DUKE. The bail-out system. In: NAGWS Guide Gymnastics, edited by M. B. Alphin, and Grace, C. Washington, DC: AAHPER, 1980, p. 26-31.
4. BALE, P., AND J. GOODWAY. Performance variables associated with the competitive gymnast. Sports Med. 10(3): 139-145, 1990.

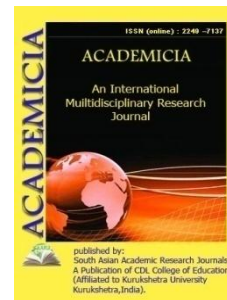
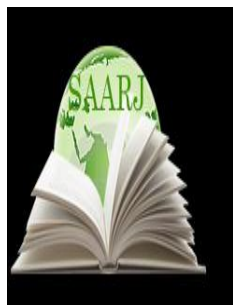

DOI: **10.5958/2249-7137.2021.01146.0**

## PREPARING STUDENTS FOR RESEARCH ACTIVITIES BASED ON PROJECT TECHNOLOGY

**G.S. Ergasheva\***; **M. A. Sultanova\*\***

\*Associate Professor,  
Doctor of Pedagogical Sciences,  
Department of Biology TSPU named after Nizami,  
UZBEKISTAN

\*\*Master of the I course of the Specialty,  
"The Method of Teaching Accurate and Natural Sciences,  
UZBEKISTAN

### ABSTRACT

*The article highlights the use of design technology in the classroom, with the aim of preparing students for research activities in biology. The ways of developing the research competence of future specialists in the preparation of professional activities are grounded. The set of interrelated components (organizational, content, activity, evaluative and productive), focused on the development of personal intellectual qualities in the course of students' scientific activities in the educational process of studying biology, has been substantiated.*

**KEYWORDS:** *Technology Design, Biology, Research Activities, Students, Specialist, Training, Informatization, Research Competence.*

### INTRODUCTION

The development of modern society is characterized by ever-increasing dynamism, penetration to new levels of knowledge of nature, changes in social structure and the emergence of qualitatively new types of activity in previously unknown areas. In these conditions, the ability and desire to independently search for the necessary information, mastering the fundamental knowledge that constitute the theoretical foundations of professional activity, the ability to create and implement new strategies of conduct and activity becomes especially important for a modern specialist.

The current stage of development of society poses a number of fundamentally new problems for the education system, caused by political, socio-economic, ideological and other factors, among

which the need to improve the quality and accessibility of education should be emphasized. Increasing academic mobility, integration into the global scientific and educational space, creating economically optimal educational systems, increasing the level of university corporatism and strengthening ties between different levels of education.

The next challenge of the era was the reform of higher education, which implies a transition to a two-stage system of education: bachelor's and master's degrees, introducing a "commercial note" into the activities of universities. In this regard, the goals and content of education are being revised, the expectations and requirements of students for the educational process are changing, universities themselves are critically rethinking the key areas of their activities. Obviously, only highly qualified teachers who need to update theoretical and practical knowledge in connection with a fundamental change in modern approaches to solving professional problems can achieve these goals and fulfill the assigned tasks [1, 5].

As a key trend leading to a significant change in the principles and methods of organizing research and educational activities of universities, it is necessary to highlight the growing role of the project approach to university management [2, 8].

In science, a lot of attention is currently paid to the problems of the development of a creative personality. The share of concepts and curricula that set the main goals for the development of research competence, which presupposes the development of creativity, cognitive activity and curiosity, the global research attitude as a personality trait, and the development of research strategies in conditions of novelty and uncertainty, is increasing.

In recent years, a number of innovative teaching technologies have been developed in pedagogy, corresponding forms, methods and means that have great potential in the development of the research culture of students. Among them, such teaching technologies as problem-modular training and concentrated training, a fan of special methods and techniques aimed at developing students' creativity (brainstorming, bending, synectics, etc.).

This includes the technology of project-based teaching, which has great opportunities in the development of the personality of students, including research competencies. The actualization of the ideas of project-based education is currently due, among other things, to social changes that take place in social development.

The use of project methods involves the use of a wide range of problematic, research, search methods, focused clearly on the real practical result, significant for each student participating in the development of the project, as well as the holistic development of the problem, taking into account various factors, conditions for its solution and the implementation of the results [3.93 ].

Project education teaches the development of a project attitude towards the world, one's own life, allows to combine educational, research and quasi-professional activities of future specialists.

Research goals: to develop a model of the step-by-step use of project-based teaching technology for the formation of students' research competence based on theoretical ideas about the essence and content of research competence, the internal capabilities of this technology, the conditions for its combination with the requirements of problem-based, modular, concentrated learning technologies. The model provides for the consistent implementation by students in the learning process of projects corresponding to situational activity, focused on the formation of positive motivation for research activities.

Object of research: to develop and substantiate the use and condition of formation in order to prepare the research activities of students in the process of project learning.

**Research methods:** During the research, a theoretical method was applied (analysis, content analysis, synthesis, modeling, abstraction and definition, generalization); empirical method (test, pedagogical observation, expert assessment, study of normative documents, comparison, characterization, self-analysis of subjects of participants in the educational process); social methods (questioning, blitz poll, conversation).

Scientific research is as follows. The composition and structure of the model of research competence of the individual have been determined.

The set of interrelated components (organizational, content, activity, evaluative and productive), focused on the development of personal intellectual qualities in the course of students' scientific activities in the educational process of studying biology, has been substantiated. The effectiveness of the development of scientific activity of students: the criterion of effectiveness (provision of organizational and pedagogical conditions) is determined by the dynamics of creative development, manifested at a limited, acceptable and optimal levels.

The didactic means and conditions for the implementation of the developmental possibilities of project training are revealed, depending on the types of training (theoretical, practical).

In the process of theoretical training, they are: strengthening the research potential of tasks and assignments by giving them a problematic character; a consistent increase in the proportion and interdisciplinary nature of students' independent project activities; immersion of students in situations as close as possible to the real conditions of professional activity.

The formation of students' research competence in project-based learning will be effective if:

- to identify the composition of the structure, functions and basic properties of research competence, considered as the ultimate goal of the project learning process;
- to consider the formation of the research competence of students as a continuous step-by-step process from encouraging students to research activities to active creativity in educational and research work;
- selection and structuring of project assignments based on real professional problems;
- forms and methods of project training implementation ensure students' immersion in a situation as close as possible to the real conditions of professional activity.

In conclusion, we note that an integrated approach to the organization of scientific work in the university provides for systematic work on the development of creative abilities students, involving them in a variety of forms of research activities, equipping students with scientific research methods, increasing their mental culture. The development of a student's personality will be successful if cognitive and scientific activities are motivated; create creative teams with taking into account scientific interests, abilities and student opportunities; provide a research base; create situations of success when implemented into practice scientific results; encourage creative activity and independence of researchers in solving scientific problems.

Thus, scientific work is an integral part of the educational process of students. Students master the skills of creative, search work, learn to pose and solve actual tasks, master in practice

methods of experimental research work. The results of scientific research make it possible to identify the most promising young scientists for further teaching them in graduate school.

Conclusions on the content, structure and levels of research activities in biology. An applied-theoretical model of the formation of students' research competence in the context of project-based learning, which provides for the gradual complication of projects, an increase in the degree of productivity of dominant activities, an increase in their share of the interdisciplinary nature of independent activities.

## LITERATURE

1. Organization of research and expert -consulting project activities of management faculties (universities). 5th International Summer School / Ed. T.V. Zaitseva.–M .: Publishing house of Moscow University, 2012.–160 p.
2. Molchanova O.P. Research project as a promising form of organizing scientific and educational activities of the Faculty of Management // Organization of research and expert-consulting project activities of management faculties (universities). 5th International Summer School / Ed. T.V. Zaitseva.–M .: Publishing house of Moscow University, 2012.–
3. Pankratova O.P. Pedagogical technologies in the development of students and their preparation for research activities // Bulletin of the Stavropol State University. 72/2011.–S. 91-95.



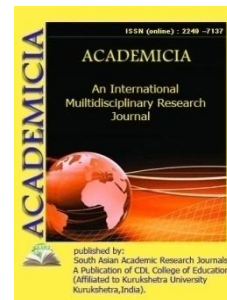

DOI: **10.5958/2249-7137.2021.01145.9**

## BIO ECOLOGICAL PROPERTIES OF IRIS PSEUDACORUS L

**Savutova Malohat Erkinovna\***

\*Magistr of Urgench State University,  
UZBEKISTAN

Email id: s\_malohat1978@mail.ru

### ABSTRACT

*The article describes bioecological features, morphological structure, distribution in nature, vegetation period and methods of reproduction of *Iris pseudacorus* L. The links of the rhizome of the current year are covered with leaf sheaths and the remnants of dead leaves of the generation of the last year, from below they bear a beard of adventitious roots, which die off every year. The complete absence of watering causes a slight decrease in morphometric indicators and almost excludes self-seeding, however, flowering and ripening of seeds, in this case, occurs annually. Thus, we have established the duration of the pregenerative period of ontogeny of *I. pseudacorus* under the conditions of the steppe zone culture (3 years) and the period of decorativeness of individuals (5–7 years).*

**KEYWORDS:** *Iris, Irispseudacorus L., In-Situ, Ex-Situ, Bioecological Features, Morphologi. Vegetation Period, Introduction.*

### INTRODUCTION

Despite the intensive efforts made in the world over the past twenty years, the process of loss of global biological diversity continues. Sustainable management of biological resources and their rational use requires urgent and decisive measures to conserve individual species and ecosystems. For this, at the national and international levels, it is necessary to strengthen the capacity in the field of study, systematic observation of biological diversity, to develop effective national measures to protect ecosystems in situ, to protect biological and genetic resources ex-situ and to improve the functioning of ecosystems [1].

Conservation and sustainable use of flora and fauna in Uzbekistan is one of the priority areas of state environmental policy. Effective protection of biodiversity components is inextricably linked with the degree of their knowledge. However, the degree of floristic knowledge of a number of

regions of Uzbekistan is insufficient. Since the publication of the last volume of "Flora of Uzbekistan", there has been no purposeful work to record new data.

*I. pseudacorus* was introduced by seeds obtained by delectus exchange in 2001 from France. In nature, it grows in swamps, along the banks and shallow waters of rivers and lakes in Atlantic and Central Europe, the Caucasus, Western Siberia, the Mediterranean and Asia Minor, while the rhizome is usually submerged in water, leaves and flower stalks are above the water (Fedchenko, 1935; Encyclopedia ... , 2017). However, when cultivated in arid conditions [7].

The history of introduction of 44 species of the genus *Iris* growing in Russia is analyzed. Chronology of introduction is given for 20 of them.

All species of the genus *Iris* L. of the flora of Russia are of interest for introduction and selection, almost all of them are grown in gardens; most of them have been tested with positive results. At the beginning, the introduction of irises into cultivation was of a collection nature (as for most other plants) and was aimed at both acquaintance with the diversity of natural forms and the initial testing of plants. Little is known about the history of the introduction of irises in Russia [2]. The purpose of this work is to give a brief summary of the history of the introduction of species of this genus. Some information about the cultivation of plants in the pre-Petrine period can be found in documents that speak of the state of vegetable gardens or gardens in which medicinal or any outlandish plants were grown, as well as in the analysis of lists of plants for medicinal gardens and orchards.

*Iris pseudacorus*, yellow flag, yellow iris or water flag is a species of flowering plants in the Iridaceae family. It is indigenous to Europe, West Asia, and Northwest Africa. Its specific epithet *pseudacorus* means "false calamus", referring to the similarity of its leaves to those of *Acorus calamus* (sweet flag), as they have a noticeably veined middle of the rib and sword-like shape. However, these two plants are not related [5].

This herbaceous flowering perennial plant grows to 100–150 cm (39–59 in) or the rare 2 m (6 ft 7 in) tall, with erect leaves up to 90 cm (35 in) long and 3 cm (1.2 in) wide. The flowers are bright yellow, 7–10 cm (2.8–3.9 in) in diameter, with a typical iris shape. The fruit is a dry boll 4–7 cm (1.6–2.8 in) long, containing numerous pale brown seeds.

Under open-field culture, *I. pseudacorus* is a perennial summer-green herbaceous short-rhizome-brush-root friable bunchy, sympodially growing, vegetatively sedentary polycarpic with a semi-rosette upright shoot. Leaves are light green, xiphoid, 2.5–3.2 cm wide, 47–75 cm long. Peduncle 50–70 cm tall, leafy, with 2–4 lateral branches each bearing 2–3 golden yellow flowers about 7 cm in diameter, 4 cm high. The fruit is a lower syncarpous three-nested capsule up to 8 cm long, the seeds are mostly semicircular, flattened, coffee-brown.

The rhizome is plagiotropic, reddish-pink on the cross section, consists of strongly thickened and shortened annual growths (links) 5–8 cm long and 2.5–3.5 cm in diameter. The links of the rhizome of the current year are covered with leaf sheaths and the remnants of dead leaves of the generation of the last year, from below they bear a beard of adventitious roots, which die off every year. The plagiotropic rhizome determines the loose bush type of branching, but in the arid conditions of Uzbekistan, the links of the *I. pseudacorus* rhizome are close together, as a result of which the plant approaches the dense bush type. By the nature of phenological development in the annual cycle, *I. pseudacorus* belongs to the spring-summer autumn-green species of late

spring-early summer flowering. The growing season begins after thawing of the soil, ends in early November. Blooms in May for 10 days.

The beginning of the growing season of *I. pseudacorus* is due to a thermal factor combined with a temporary factor, namely, an indicator of average daily air temperatures over a certain period of time. We consider the sum of average daily temperatures for the decade preceding the noted phenodate to be such a defining indicator. The lower limit that determines the beginning of the growing season of *I. pseudacorus* is the point of stable transition of average daily air temperatures through the + 10 ° C mark (while the sum of temperatures for the previous decade is at least + 100 ° C). A short-term increase in air temperature (less than a week), even significant, does not lead to the activation of growth processes.

*I. pseudacorus* grows best in very humid conditions and is often found in wetlands where it tolerates immersion in water, low pH, and anoxic soils. The plant spreads rapidly both due to rhizomes and due to water-dispersed seeds. It fills the same niche as *Typha* and often grows with it, albeit usually in shallower water. Although it is primarily an aquatic or marginal plant, the rhizomes can withstand prolonged dry conditions.

The large stands of *I. pseudacorus* in western Scotland are a very important feeding and breeding environment for the endangered corncrake.

*I. pseudacorus* is one of two species of irises native to the United Kingdom, the other is *Iris foetidissima* (fetid iris) [5].

*Iris pseudacorus* L. 1753, Sp. Pl. : 38. Described from Europe. For the first time in Russia, it was mentioned in culture in 1755 in the botanical garden of the Medical Academy in Moscow. In the same place since 1781 in P. Demidov's garden and near Moscow, in Gorenki since 1812. In the Pomological Garden of Regel and Kesselring in 1876-1917. live plants and seeds were offered for sale.

*Iris austrotschatkalica* Tojibaev, F. Karim. & Turgunov. The new species was first collected in 2010 in the low mountains of the Southern Chatkal (Uzbek part of the Chatkal Range). "Western Tien Shan. Southern slopes of the Chatkal ridge. Mount Ungor Tepa, 3 km north of the village of Poromon. Rocky slopes, 1200 m above sea level F.I. Karimov, M.D. Turgunov. TASH, iso - ALTB. The plants were planted at the collection site of the Botanical Garden of the Institute of the Gene Pool of Plant and Animal World of the Academy of Sciences of the Republic of Uzbekistan (Tashkent)" [3, 30].

Thus, we have established the duration of the pregenerative period of ontogeny of *I. pseudacorus* under the conditions of the steppe zone culture (3 years) and the period of decorativeness of individuals (5–7 years). These data, together with data on seed productivity, will allow organizing the process of seed reproduction of this species and predicting the long-term existence of exposures with its participation.

To obtain a relatively small amount of planting material, *I. pseudacorus* should be propagated vegetatively - by dividing the rhizomes of virginal or generative individuals according to the number of fans in early spring (April - early May) or in larger fragments during summer-autumn dormancy (August - September).

The complete absence of watering causes a slight decrease in morphometric indicators and almost excludes self-seeding, however, flowering and ripening of seeds, in this case, occurs annually. Based on the research carried out, *I. pseudacorus* is recommended by us as a stable and unpretentious plant for wide use in green construction in Uzbekistan - for reservoirs, mixborders, rockeries and gravel gardens, as well as for cutting. In landscape-type expositions, it is well combined with cornflower, willow-leafed grass, Siberian iris, small-flowered large-flowered petals, middle bell, chalcidony lychnis, oriental poppy and other tall perennials.

#### LITERATURE

1. The official UN website - [http://www.un.org/ru/documents/-decl\\_conv/conventions/agenda21\\_ch15.shtml](http://www.un.org/ru/documents/-decl_conv/conventions/agenda21_ch15.shtml).
2. Pavlova M.A. The results of the introduction of *Iris pseudacorus* L. in the Donetsk Botanical Garden // Hortus bot. 2018.Vol. 13, 2018, pp. 279 - 290, URL: <http://hb.karelia.ru/journal/article.php?id=4362>.
3. Karimov F.I. Monocotyledonous geophytes of the Fergana Valley .Abstract dissertation.Doctor of Biological Sciences, Tashkent-2016:76p.
4. Kryukova AV, Abramova LM On the biology of a rare species of the Republic of Bashkortostan *Iris pseudacorus* L. in nature and introduction // Scientific Bulletin of Belgorod State University. Ser. Natural Sciences.2014. No. 17 (188).Issue 28. S. 32-34.
5. *Iris pseudacorus* – Wikipedia // [Iris pseudacorus - Wikipedia](#).
6. Academy of Sciences of the USSR, 1935. T. IV. P. 518.Shaibakov AF, Mironova LN Experience in the introduction of rare species of iris in the flora of Bashkortostan // Byul. bot. garden of the Saratov State University. Biology. 2008. S. 175-182.
7. Encyclopedia of ornamental garden plants; [http://flower.onego.ru/voda/iris\\_pse.html](http://flower.onego.ru/voda/iris_pse.html) (date of treatment 03/02/2017).

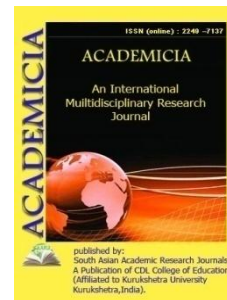
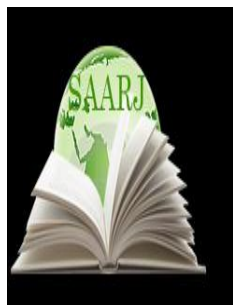

DOI: **10.5958/2249-7137.2021.01144.7**

## POSSIBILITIES OF THE CREDIT-MODULAR SYSTEM IN TEACHER EDUCATION

**Ibaidullaeva Balkhash Rahmatullakizi\***

\*Master's Degree,  
Tashkent Pedagogical University named after Nizami,  
UZBEKISTAN

### ABSTRACT

*The article reveals the essence, functions and possibilities of the content of the credit-modular system in pedagogical education. Many people believe that the education system of Uzbekistan was formed in conditions of information deficit and limited opportunities for access to information. Therefore, the activity of a teacher in universities was reduced, first of all, to informational, or better to say informative, functions. This is based on an average school year of approximately 40 weeks. The number of ECTS credits per academic discipline is determined by dividing the total hours planned for studying the discipline by the credit price (rounded to 0.5 credits).*

**KEYWORDS:** *Credit Modular System, Credit-Modular System, Educational Process, Information Support, Function, Opportunity*

### INTRODUCTION

The Cabinet of Ministers adopted Resolution No. 824 of December 31, 2020 “On measures to improve the system of organizing the educational process in higher educational institutions”[1].

According to the decree, starting from the 2020/2021 academic year, the educational process in higher educational institutions is gradually transferred to a credit-modular system. The document approved the Regulation on the implementation of the credit-modular system in the educational process of universities.

A credit-modular system for organizing the educational process is a model for organizing the educational process, which is based on the combination of modular learning technologies and credit or credit educational units. Organization and implementation of the educational process is

a multifaceted and complex system of action and interaction. Attention in the credit-modular system is focused on two of its characteristics:

- On independent work of students;
- On the maintenance of the credit-modular system of organizing the educational process and the rating system for assessing the educational achievements of students.

Many people believe that the education system of Uzbekistan was formed in conditions of information deficit and limited opportunities for access to information. Therefore, the activity of a teacher in universities was reduced, first of all, to informational, or better to say informative, functions. The teacher played the role of the most important source of information. Since the student is the object of the educational process and at the same time the object of perception and assimilation of information, the planning of the educational process was carried out in such a way that the bulk of the work fell on classroom teaching. The current state of the development of information support opens up ample opportunities for access to information sources and therefore partially confuses the emphasis in planning the educational process towards independent work. The credit-modular system, as an integral attribute of the Bologna Declaration, is provided with two main functions:

1. Promoting student and faculty mobility and facilitating transitions from one university to another.
2. A clear definition of the scope of the work carried out by the student, taking into account all types of educational and scientific activities. The amount of credits determines what a student is capable of, who studies in one or another program.

### **THE MAIN FINDINGS AND RESULTS**

The introduction of a credit-modular system is an important factor in stimulating the effective work of the teacher and student. Modules are designed as systems of educational elements, united by the sign of compliance with a certain object of professional activity.

The latter is considered as a certain amount of educational information, which has an independent logical structure and content, which makes it possible to operate with this information in the process of the student's mental activity. The modular organization of the content of an academic discipline is less for everything a mechanical transfer of sections of the program to educational modules, since it requires deep analytical and logical work on the semantic content of the discipline, its structuring as a system, and not an arbitrary conglomerate of scientific information. With a credit-modular system of organizing the educational process, the content of the discipline is divided into meaningful modules (2-4 modules per semester), that is, the academic discipline is formed as a system of meaningful modules. The second condition for the implementation of the modular principle of organizing the content of an academic discipline is the ability to identify general cross-cutting ideas of professional activity, to the disclosure and assimilation of which each module is aimed.

For a student - a future specialist - it is important not only to comprehend and assimilate information, but also to master the ways of its practical application and decision-making. Under such conditions, the particle of direct, outside the applied information is reduced and the use of interactive forms and methods of students' work under the guidance of a teacher (tutor) and full-

fledged independent work in laboratories, reading rooms, at the objects of future professional activity, which is especially important for the distance education system, expands. The creation of a credit system should facilitate comparison of completed courses and maximize student mobility.

Credit is a conventional unit of measurement of a student's workload when studying a particular curriculum or a separate discipline (course) performed by a student during education. Credit is the minimum unit that is accurately documented, often means training for a week (the amount of classroom and independent student work). The system of credits is understood as a systemic definition of all the main aspects of the organization of the educational process based on the use of a credit unit (credit) as a measure of the labor intensity of educational work, expressing the totality of all components related to the organization of the educational process. For the first time, loans were introduced at US universities at the turn of the 18th and 19th centuries. Within the framework of the liberalization of university education that began during this period. The establishment of quantitative equivalents of the content of education and the degree of mastering of educational programs through credit units made it possible to provide students with the opportunity to independently plan the educational process make fundamental changes to the systems for monitoring and assessing the quality of the educational process, created conditions for improving educational technologies. The most acceptable of the credit systems that existed in Europe at the time of the signing of the Bologna Declaration was the ECTS system (European Credit Transfer System).

In the course of the pedagogical experiment, which was carried out by leading higher educational institutions, in Uzbekistan, the amount of ECTS credit was set - 36 academic hours and the annual student workload was set - 60 ECTS credits. This is based on an average school year of approximately 40 weeks. The number of ECTS credits per academic discipline is determined by dividing the total hours planned for studying the discipline by the credit price (rounded to 0.5 credits). For example, if 108 hours are allocated to study a discipline, then this corresponds to three credits. In this case, the discipline is formed from three modules. It is most convenient to determine the share of each discipline in the total workload by the number of classroom hours and proportionally distribute 30 credits earned per semester between the disciplines studied in this semester.

It is recommended to convert the study load into credits by mathematically dividing the total (classroom and independent) study load in the semester by a factor of 36 (36 hours of the total load). A bachelor during his studies must collect at least 180 credits (three years in accordance with the norm of 60 credits) or at least 240 credits (4 years); a master's degree must have earned at least 300 credits in total. This implies the dependence of the period of study for a master's degree on the duration of study for a bachelor's degree.

Advantages of the modular system:

- 1). Clear structure of the training course, orderliness;
- 2). Ability to track links between elements;
- 3). Visibility, awareness of perspective;
- 4). Individual approach to training the student;

Flexibility of the information presented;

5). Developing students' productive thinking;

6). Multifunctionality;

7). Possibility of self-control of the student's learning and the teacher's own activities;

8). Lack of severe stress among students,

9). The student himself operates with educational content, which leads to a conscious and deeper assimilation of the material [2].

## CONCLUSION

Preliminary results of the work of the credit-modular training system: 1. Promotes optimal planning of the content and methodological support of disciplines, taking into account the final results 2. Liberalizes the educational process and orientates it towards the student, stimulating his independent work. 3. Stimulates the improvement of the process of assessing the quality of mastering educational programs. 4. Improves the quality of the educational process and organizational and administrative work.

## REFERENCES

1. [https://www.norma.uz/novoe\\_v\\_zakonodatelstve/v\\_vysshih\\_obrazovatelnyh\\_uchrejdaniyah\\_-\\_kreditno-modulnaya\\_sistema](https://www.norma.uz/novoe_v_zakonodatelstve/v_vysshih_obrazovatelnyh_uchrejdaniyah_-_kreditno-modulnaya_sistema).

2. А.В. Балмуханова Модульное обучение в системе кредитных зачетных единиц: проблемы и перспективы // <https://docplayer.ru/35201416>.

3. Кредитно - модульная система. Ее достоинства и недостатки — Студопедия ([studopedia.ru](http://studopedia.ru))



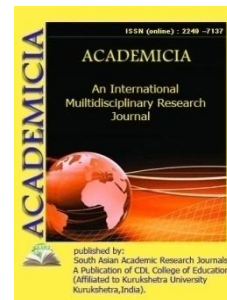

DOI: **10.5958/2249-7137.2021.01143.5**

## USE OF EXPERIMENTAL PLANNING METHODOLOGY TO STUDY THE FINAL DISTILLATION OF VEGETABLE OILS

**Khabbirov Fakhriiddin Yusupovich\***

\*Doctor of Philosophy (PhD) Technical Sciences  
Bukhara Engineering Technological Institute,  
Bukhara, UZBEKISTAN  
Email id: faxrilo@mail.ru

### ABSTRACT

*Today in the world there is a high growth in the production of vegetable oil, which is one of the leading in the food production industry. Final distillation in an extraction system in vegetable oil plants is one of the most complex and energy intensive processes. Therefore, the introduction of intensive methods necessary for the production of vegetable oils, the creation of modern equipment and technology is of scientific and practical importance [1]*

**KEYWORDS:** *Distillation, Extraction, Preliminary*

### INTRODUCTION

Distillation is the process of heat treatment of a solution of oil in a solvent. It consists in transferring the solvent into a vaporous state, removing vapors and their condensation. The solvent should be removed from the oil as completely as possible at the lowest temperatures in the shortest possible time. Distillation is carried out in two periods: preliminary and final distillation.

In the first period, evaporation is carried out, which obeys all the known laws of this process and can be carried out both at atmospheric pressure and under vacuum. During this period, the miscella must reach such a concentration that the boiling point does not exceed 100°C.

In the second period, hot water vapor is additionally applied, therefore, the laws of the process are different. The system will consist of three components: solvent, oil, water, which represent three phases: two liquid (miscella, water) and one vapor - solvent. According to the phase rule, such a system has two degrees of freedom. This means that without disturbing the equilibrium, you can change two parameters, in this case - the total pressure and the concentration of miscella.

Usually the process of distillation of vegetable oils is carried out in the modes of spraying, flowing down and lifting in a film and distillation in a layer.

During spray distillation, the miscella exits the nozzle in the form of a jet, which is crushed into droplets. The interface between the liquid and gaseous phases significantly increases, which increases the productivity of the process and reduces its duration. According to hydrodynamic changes in the liquid phase, three periods are conventionally distinguished: the formation of individual drops, the development of turbulence within individual drops and the attenuation of this process. In the gas phase, the state and properties of the vapors are the same at any point due to mixing.

For preliminary distillation by spraying, only one period is characteristic-boiling; in final spray distillation, usually both boiling and evaporation.

Distillation is divided into falling film distillation and rising film. Film distillation by steam flow, so called "reverse flow". Film thickness is determined by the physical properties of the miscella, surface properties, its location, and distillation conditions. Removal of the solvent from the film is basically the same as from the free surface [2,3,4].

The presence or absence of heating of the surface on which the film is formed is of great importance. If the surface is heated, then evaporation occurs more intensively due to an additional heat source and changes in the mechanism of mass transfer on the heated surface.

Distillation in a bed is used for high concentrations of miscella (80 ... 85%). The solvent is removed by evaporation from the miscella bed. To intensify the process, a vacuum is used, and the micelle layer is bubbled with live steam. When using gasolines, distillation in the bed is a necessary stage in the final distillation; when switching to a low-boiling chemically homogeneous solvent (hexane), distillation in the bed can be excluded [9].

In low concentrations of vegetable oils in miscella, under normal conditions, the solvent is evaporated.

To lower the temperature in the distillation process and speed up the process, vacuum stripping of the solvent is used, as well as with water vapor.

In the world's industrial plants for the production of vegetable oil, miscella is carried out in two - and three-stage schemes.

The three-stage distillation unit consists of two film distillers operating in series at atmospheric pressure at temperatures of 80-90<sup>0</sup>C and a final distiller operating in a vacuum mode, in which the residual pressure in the apparatus is 0.04 ... 0.06 MPa at a temperature of 110-120<sup>0</sup>C.

The distillation method for purifying vegetable oils in a vacuum is based on the difference in vapor pressures and evaporation rates of the main component - oil and impurities contained in it. Vegetable oils are considered to be non-volatile up to a temperature of 225<sup>0</sup>C [5].

As mentioned above, in distillation, an important issue is the handling of heat-sensitive substances. In this case, it is necessary to use a vacuum, which allows the process to be carried out at sufficiently low temperatures. It is also necessary to ensure a short-term stay of the material in the heated zone. These requirements are met when distillation is carried out in a thin

film of the substance. A very thin film flows along the heated surface and is at the distillation temperature for only a few seconds.

Experimental research is widely used at all stages of development, production and operation of various technical objects, in particular, the development of equipment for the oil processing industry. When creating devices for carrying out technological processes, the main costs fall on their introduction into production and testing. The theory of experiment planning formulates techniques and methods for the optimal organization of research work.

Mastering the fundamentals of the theory of experiment and practical techniques of its use increases the efficiency of the researcher's work, allows solving many practically important research problems at the lowest cost, such as building a mathematical model of objects from experimental data and optimizing processes.

To improve the process and apparatus for the final distillation of vegetable oil miscella on the basis of multi-stage cutting, we used the method of planning experiments [6,7,8].

### Methods

Calculations of the coefficients of the process equation based on the results of the implementation of the PFE2 plan are presented in the table.

The main task, given  $y_i$ , is to predict  $y$ . To do this, first you need to find the type of connection between  $y_i$  and  $y$ .

If the values of  $y_i$  and  $y$  are given in the following table, then the type of relationship can be determined, i.e. linear or non-linear.

**TABLE1 INCOMPLETE PLAN OF THE PFE 2<sup>3</sup> PLANNING MATRIX**

№	Maincolumns			Processoutput			
	Z1	Z2	Z3	Y1	Y2	Y3	Y
1	-	-	-	100	10	0,00495	36,66831667
2	-	+	-	107	17	0,00636	41,33545333
3	+	-	-	114	24	0,00778	46,00259333
4	+	+	-	121	31	0,00919	50,66973
5	-	-	+	128	38	0,01061	55,33687
6	-	+	+	135	45	0,01202	60,00400667
7	+	-	+	142	52	0,01344	64,67114667
8	+	+	+	150	60	0,01485	70,00495

Then we find by what law  $Y$  and  $y$  are connected.

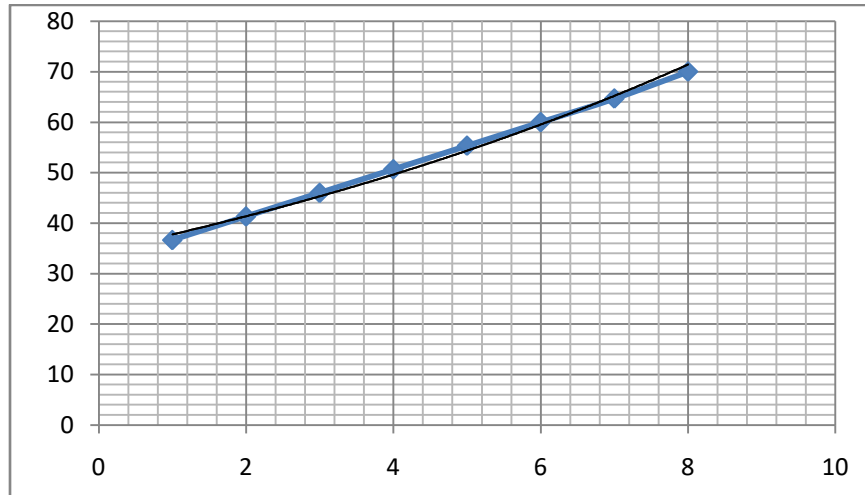

It can be seen from the graph that the connection can be taken as linear. The task is aimed at finding the coefficients  $b_0$ ,  $b_1$ ,  $b_2$ ,  $b_3$ . The determination of the coefficients is possible by the method of the smallest squares, i.e.

## RESULTS AND DISCUSSION

$$F(y) = \sum_{i=1}^n (Y_i - b_0 - b_1 \cdot Y_1 - b_2 \cdot Y_2 - b_3 \cdot Y_3)^2 \Rightarrow \min$$

If derivatives  $b_0$ ,  $b_1$ ,  $b_2$ ,  $b_3$  equate to zero, then we get the following system of equations, i.e.

$$\begin{cases} \sum y_i = N \cdot b_0 + b_1 \cdot \sum y_1 + b_2 \cdot \sum x_2 + b_3 \cdot \sum x_3 \\ \sum y_i \cdot x_1 = b_0 \cdot \sum x_1 + b_1 \cdot \sum x_1^2 + b_2 \cdot \sum x_1 \cdot x_2 + b_3 \cdot \sum x_1 \cdot x_3 \\ \sum y_i \cdot x_2 = b_0 \cdot \sum x_2 + b_1 \cdot \sum x_1 \cdot x_2 + b_2 \cdot \sum x_2^2 + b_3 \cdot \sum x_2 \cdot x_3 \\ \sum y_i \cdot x_3 = b_0 \cdot \sum x_3 + b_1 \cdot \sum x_1 \cdot x_3 + b_2 \cdot \sum x_2 \cdot x_3 + b_3 \cdot \sum x_3^2 \end{cases}$$

Having compiled a system of the given values in the table, we find the coefficients  $b_0$ ,  $b_1$ ,  $b_2$ ,  $b_3$ .

$$b_0 = 127,55; b_1 = -0,082; b_2 = 0,342; b_3 = -17,835$$

This means that the process we are examining is described by the following model.

$$y = 127,55 - 0,082 \cdot x_1 - 0,342 \cdot x_2 - 17,835 \cdot x_3$$

## CONCLUSION

We calculate the coefficients of the equation based on the average results ( $y$ ), using the appropriate formulas:

$$b_0 = \frac{\sum Y}{N} = \frac{(36,66831667 + 41,33545333 + 46,00259333 + 50,66973 + 55,33687 + 60,00400667 + 64,67114667 + 70,00495)}{8} = 53,08663333;$$

$$b_1 = \sum Z1_i/N = (-36,66831667 - 41,33545333 + 46,00259333 + 50,66973 - 55,33687 - 60,00400667 + 64,67114667 + 70,00495)/8 = 4,750471667;$$

$$b_2 = \sum Z2_i/N = (-36,66831667 + 41,33545333 - 46,00259333 + 50,66973 - 55,33687 + 60,00400667 - 64,67114667 + 70,00495)/8 = 2,416901667;$$

$$b_3 = \sum Z3_i/N = (-36,66831667 - 41,33545333 - 46,00259333 - 50,66973 + 55,33687 + 60,00400667 + 64,67114667 + 70,00495)/8 = 9,41761.$$

Therefore, the equation of the process will have the form:

$$y = 53,09 + 4.75 * Z1 + 2.42 * Z2 + 9.418 * Z3.$$

We determine the significance of the coefficients of the equation, for which we calculate the average variance for the entire experiment:

$$S_2(y) = (100 - 36,66831667)^2 + (10 - 36,66831667)^2 + (0,00495 - 36,66831667)^2 + (107 - 41,33545333)^2 + (17 - 41,33545333)^2 + (0,00636 - 41,33545333)^2 + (114 - 46,00259333)^2 + (24 - 46,00259333)^2 + (0,00778 - 46,00259333)^2 + (121 - 50,66973)^2 + (31 - 50,66973)^2 + (0,00919 - 50,66973)^2 + (128 - 55,33687)^2 + (38 - 55,33687)^2 + (0,01061 - 55,33687)^2 + (135 - 60,00400667)^2 + (45 - 60,00400667)^2 + (0,01202 - 60,00400667)^2 + (142 - 64,67114667)^2 + (52 - 64,67114667)^2 + (0,01344 - 64,67114667)^2 + (150 - 70,00495)^2 + (60 - 70,00495)^2 + (0,01485 - 70,00495)^2;$$

$$S_2(y) = 45891,51;$$

$$S_2(b_i) = 45891,51 / 8^3 = 956,0732215;$$

$$S(b_i) = 30,92043372.$$

Student's test for each coefficient  $q=5\%$ ,  $N=16$

$$t_1 = 0,625 / 30,92043372 = 0,020213171$$

$$t_3 = 13,125 / 30,92043372 = 0,424476581$$

$$t_2 = 4,375 / 30,92043372 = 0,141492194$$

$$t_{kp} = 2,12$$

Significant coefficients turned out to be  $b_0=53,08663333$ ;  $b_3=9,41761$  which we include in the regression equation:  $y^{\wedge} = 53,08663333 + 9,41761 * Z3$ .

Checking the adequacy of the model

Using the regression equation, we calculate the value of  $y$  for each point of the matrix design:

$$y1^{\wedge} = y2^{\wedge} = y3^{\wedge} = y4^{\wedge} = 53,08663333 - 9,41761 = 43,66902;$$

$$y5^{\wedge} = y6^{\wedge} = y7^{\wedge} = y8^{\wedge} = 53,08663333 + 9,41761 = 62,50424.$$

$$Sa\partial^2 = (43,66902 - 36,66831667)^2 + (43,66902 - 41,33545333)^2 + (43,66902 - 46,00259333)^2 / (8 - 2) + (43,66902 - 50,66973)^2 + (62,50424 - 55,33687)^2 + (62,50424 - 60,00400667)^2 + (62,50424 - 64,67114667)^2 / (8 - 2) + (62,50424 - 70,00495)^2 / (8 - 2) = 172,1546$$

Calculating the F-ratio:

$$F = Sa\partial^2 / S_2(y) \text{ или } S_2(y) / Sa\partial^2 = 45891,51 / 172,1546 = 266,5715$$

Determined by the table (Appendix 3)  $F_{krend} f1 = 6 = 8 - 2$

$$f2 = 8(3 - 1) = 16:$$

$Fkr=2,74$ .

Adequacy hypothesis is accepted.

### RECOMMENDATIONS

1. M. S. Narziev, O. R. Abdurakhmanov, F. Y. Khabibov, Karimova, D. sh. Investigation of flow hydrodynamic structures in the final distillation of a cotton miccella. "Problems and prospects of development of innovative cooperation in research and training." Bukhara. 2017.- Pp. 52-53
2. MS Narziev, FY Habibov. Definition of optimal technological parameters in the process of final distillation // "Problems of the development of innovation in higher education and the integration of entrepreneurship". Volume II.17-19 April, 2019.-Bukhara. -96-98 p.
3. Narziev MS, Abdurakhmanov OR, Khabibov F.Yu. Systematic analysis of the technological process of the final distillation of cotton oil mica. "Scientific and Technical Jurisprudence" Science and Technology Development". № 3. 2017. C.3-7.
4. M.S. Narziev, F.Yu. Gabibov, D.S. Karimova Development of a control system for the final distillation of cottonseed oil miscella based on an adequate mathematical model // International Scientific and Practical Conference "Integration of modern scientific research into the development of society" ... 28-29 December, 2016. Kemerovo. - S.41-44.
5. F.Yu. Khabibov, M.S. Narziyev/ A study of the process of the final distillation of cottonseed oil on the computer model». Scientific and technical journal "news of science of Kazakhstan" 2019, no. 2. Almaty 2019-P. 157-167.
6. F.Yu. Khabibov. Development of a hierarchical structure of systemic thinking of the process of final distillation of cottonseed miscella. "Development of science and technology". Bukhara. 2019. No. 5.- P.189-193.
7. F.Yu. Khabibov. A Study Of The Process Of The Final Distillation Of Cottonseed Oil On The Computer Model. The American Journal of Applied Sciences, Published: September 30, 2020, Pages: 233-243 IMPACT FACTOR 2020: 5. 276. The USA Journals, USA.
8. F.Yu. Khabibov, M.S. Narziyev, M.A. Abdullayeva "Optimization Of The Final Distillation Process By Multi-Stage Atomization Of Vegetable Oil Miscella" The American Journal of Applied Sciences, (ISSN – 2689-0992) Published: September 30, 2020, Pages: 255-262. IMPACT FACTOR 2020: 5. 276, The USA Journals, USA
9. Т.В. Вобликова, Процессы и аппараты пищевых производств: Учебное пособие / Т.В. Вобликова, С.Н. Шлыковидр. - СПб.: Лань, 2016. - С.102-108.
10. D.Yu. Slabodchikov. Intensification of the process of evaporation of volatile fractions from miscella in final stills with steam nozzles. Saint Petersburg. Dissertation for the degree of candidate of technical sciences. 2002 - S. 10-11.



**ACADEMICIA**  
**An International**  
**Multidisciplinary**  
**Research Journal**  
 (Double Blind Refereed & Peer Reviewed Journal)

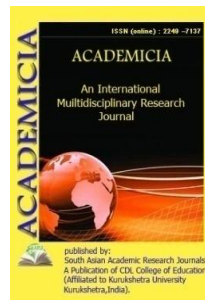

**DOI: 10.5958/2249-7137.2021.01219.2**

**ALISHER NAVOI TRADITION IN THE WORK OF MUZZAMKHAN**

**Saydalieva Nasiba Farhodovna\***

\*Head of the Department of Languages,  
 Candidate of Philological Sciences,  
 SEIS Academic Lyceum,  
 UZBEKISTAN

**ABSTRACT**

*Tradition and skill are one of the factors that determine the longevity of literature. There is a creator of every age who has matured, intellectual qualities, who follows the creations of his predecessors, continues their most advanced traditions and strives to express himself, to have his say. Muazzamkhan's work is not without its events.*

**KEYWORDS:** *Sufism, Boda (Wine), Literature, Lyrical Heritage, Aesthetic Thinking.*

**INTRODUCTION**

As he grew up in a creative environment, it has been repeatedly acknowledged in scientific studies that from an early age he was well acquainted with classical poetry of the East, in particular, Uzbek and Persian-Tajik literature. Muazzamkhan's poetry is saturated with the Eastern style of aesthetic thinking. In it we meet the traditions used by a number of artists such as Rumi and Alisher Navoi, Fuzuli and Mashrab, Nodira and Uvaysi. As a mature poet of his time, Muazzamkhan creatively used these traditions, combined them with the problems of his time, tried to seal the sorrow in a unique way.

When we compare Muazzamkhan's poetry with the works of other poets, this originality becomes even more vivid.

Relying on the active participation of Muazzamkhan in his creative research, especially Alisher Navoi, the teacher diligently and lovingly studies the lyrical heritage. For example, in the poet's ghazal "Every Hour":

The doctors said: "that the cure for estrangement is to die.

That's why I'm sick every hour

(Tabiblar aytdi: hijron dardini dorusi o‘lmakdur,  
Aning-chun men bo‘libmen hajr ila bemor har soat)

This poet close to Alisher Navoi's lines:

If a person is suffering from separation,

His treatment will be either wine, or merging, doctor.

(Chorasi yo bodadur, yo vasl, yo marg, ey tabib,

Har kishikim topsa hijron dardidin bemorlig‘)

According to the sufism, "boda" (wine), "vasl" (merging), "Hijron" (estrangement) , "yor"(sweetheart) are concepts with symbolic meanings. Boda-the dream of the love of Allah, to achieve Vasl(merging), to become unique to the land of Allah. It is known that according to the sufism the ways to reach the will of Allah are different. For example, May, death, loss of consciousness can be avoided with Allah. Because to be born apart from Allah is to strive for the vision; Jalaliddin Rumi says:

Mo baroi vasl kardan omadem,

No baroi vasl kardan omadem

Alisher Navoi's byte talks about different ways to achieve this goal. According to the poet, this can be achieved only through death. Hijran is life. That is, man is separated from Allah while he is alive. In mysticism, death is a return to Allah. The representation of the verses of the Qur'an in afaq and anfus is interpreted as "death" and death is divided into general and specific. The first is the death of lusts and lusts. The second is to look at the whole being from the point of view of Truth, to attain monotheism. According to Junaid Baghdadi, "Sufism is that God will kill you and resurrect you. Therefore, the wisdom of resurrection with Allah is at the heart of "dying before death." In Alisher Navoi's verse, this is the philosophy of "dying before death", killing the lust and lust while still alive. Muazzamkhan, on the other hand, speaks of the only way to attain the guardianship of Allah.

Alisher Navoi is a poet who raised Uzbek mystical poetry to the highest level. Navoi's poetry is characterized by a deep, complex artistic philosophy, the richness of the image, the richness of the images, and at the same time, his poetry is so close to real life. Muazzamkhan's above lines are a simpler, more concise continuation of Navoi's creative traditions.

In Alisher Navoi, the cure for hajj is either boda, or vasl, or death, while in Muazzamkhan it is concluded that "the cure for hijrah is death." Without using the symbols of boda and visol, Muazzamkhan expresses his feelings in a special way in the second line, saying, "Because I am a patient with estrangement every hour." Muazzamkhan's:

I couldn't sleep on the night of your estrangement,

So tears flowed to my yellow face.

(Sani shomi firoqingda ko‘zimga kelmadi uyqu,

Aning uchun oqar xunob sariq ruxsor uza har su),

– Alisher Navoi's ghazal, which begins with:



Her promise of coming tonight that cypress-like belle didn't keep,  
 Looking forward to seeing her till early dawn I couldn't sleep.  
 I could've died of ghastly boredom but the stunner didn't come,  
 Feeling every moment nervous on my tiptoe I did creep

The same is true here: the situation expressed in both bytes is unique. Navoi's lyrical protagonist received, but his unfaithfulness condemned him to staying up all night. In Muazzamkhan, however, a general expression of estrangement is given. In this sense, time is clear and limited in Navoi's ghazal, and more general in Muazzamkhan.

Alisher Navoi wrote in one of his ghazals: These thoughts of the great poet may seem pessimistic to some. But according to Navoi, this mood purifies the heart, motivates a person to perfection. Muazzamkhan is also derived from this meaning in the above verse. The second verse of the verse makes it clear that this world is a test for the believer.

In terms of mystical terms, this world is a "dungeon". The dungeon is also used in the sense of body. That is, the fact that the soul entered the body from its celestial expanses like a narrow cage was likened to falling into a dungeon, and the word "prison" thus acquired a metaphorical meaning.

If they throw a scoundrel at you, and the arrow of slander pierces  
 your bosom like a pike, be patient.

(Sen sano et ta'na toshi gar yog'ilsa boshingga,

Tuhmat o'qi teshsa bag'ring misli paykon g'am yema.)

In the Muazzamkhan's poetry, inverted symbols to the "people of purity", "wisdom of the mind" are often encountered. These are: "kajrav" (crooked), "ignorant", "unscrupulous", "brave", and others. No matter how many "reproach stones", "the arrow of slander", that is, strangers from "wisdom of the righteous", your face before God is bright, - the poet appeals to him. Their schemings are not worth the grief.

Come, Muazzam, if you have hashed with a tesha, you will be the ground.

If they gossip, be silent and do not grieve.

(Kel, Muazzam, sen zamin bo'l, tesha birlan chopsalar,

Qil sukut gar qilsa dashnomi farovon g'am yema).

Attention is paid to the fact that the whole Gazelle is aimed at opening a poetic idea - the mood of a "stranger". The feedback around the same mood develops gradually and creates a distinctive set. Apparently, in Majestic poetry, internal activity is strong, and in this aspect it manifests itself one of the most remarkable features of Eastern poetry.

## REFERENCES

1. O`zME. The first volume. Tashkent, 2000
2. Jalolov T. Uzbek poets. T. G. Ghulam Literature and Art Publishing House, .1980, 193 -p.

3. I.Suvonqulov. Poet Muazzamkhan (drawings of his life and work), New Age Generation, 2005 28-34-p
4. M.Kodirova. The fate of man and the people in the works of Uzbek poets of the XIX century. T. Science, 1977,. 50 p

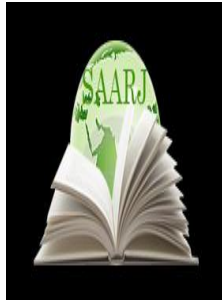

**ACADEMICIA**  
**An International  
 Multidisciplinary  
 Research Journal**  
 (Double Blind Refereed & Peer Reviewed Journal)



**DOI: 10.5958/2249-7137.2021.01220.9**

## THE MAIN MORPHOLOGICAL FEATURES OF PHRASEOLOGY

**Farhodova Maftuna Qudrat qizi\*; Karimboyeva Nodira\*\***

<sup>1,2</sup>Student,

Faculty of Foreign Philology,  
 Urgench State University, UZBEKISTAN

### ABSTRACT

*This article discusses the origins of phraseology, its different aspects with phraseological units and idioms. Phraseology (Greek phrasis - expression, expression and ... logy) - 1) a branch of linguistics that examines the phraseological structure of a language (phraseology) in its current state and historical development; 2) a set of phraseologies in a particular language.*

**KEYWORDS:** *Phraseology, Phraseological Units, Idioms, Phraseological Compounds, Lexicalization.*

### INTRODUCTION

Phraseological unit, or phrasema, is very much in terms of the origin of the phrase although ancient, the history of the science of phraseology (phraseology) spans several hundred years. Researchers have been working with phraseological units in Russian linguistics since the 18th century. In particular, MV Lomonosov, drawing up a plan of a dictionary of the Russian literary language, emphasized that, in addition to words, "folk (Russian) proverbs", "phrases" and "idiomatisms" should be expressed. By the 1960s and 1980s, phraseology had grown as rapidly in Uzbek linguistics as it had in foreign linguistics.

Phraseology (Greek phrasis - expression, expression and ... logy) - 1) a branch of linguistics that examines the phraseological structure of a language (phraseology) in its current state and historical development; 2) a set of phraseologies in a particular language.

As a branch of linguistics, the main focus of phraseology is on the study of the nature of phraseology and their categorical features, as well as on the laws of the use of phraseology in speech. The most important problem of phraseology is to distinguish phraseological units from those that are formed in speech (that is, not previously prepared), and on this basis to identify the features of phraseological units.

As a branch of linguistics, the main focus of phraseology is on the study of the nature of phraseology and their categorical features, as well as on the laws of the use of phraseology in speech. The most important problem of phraseology is to distinguish phraseological units from those that are formed in speech (that is, not previously prepared), and on this basis to identify the features of phraseological units.

Research in the field of phraseology in Uzbek linguistics began in the 50s of the last century. To date, phraseology has been studied from different angles (Sh. Rakhmatullayev, B. Yuldashev, A. Mamatov and others), several dictionaries on F. have been compiled (Sh. Rakhmatullayev, M. Sodikova), from writers Abdulla Qodiriy, Abdulla Qahhor, Hamid Olimjon, Aydin, The phraseological structure of Said Ahmad's works has been studied. In the 70s and 80s, SamSU had a center for the coordination of phraseological research and the production of special collections.

Phraseology is one of the branches of linguistics. Phraseology is derived from Latin, praxis means expression, logos means doctrine.

Phraseological unit is a fixed combination of two or more words in a language, which has a figurative meaning, the meaning of which is equal to one word.

Phraseologisms are stable combinations of figurative meanings that have a semantic integrity and consist of a stable relationship of two or more words before the speech process, ready to be introduced into the speech.

The part of language that studies expressions is called phraseology, and the set of expressions is called phraseology.

For example, sticking out the tongue, dropping a watermelon under the armpit, cracking the skin, and so on. . .

The term "semantics" is also used as a synonym for the term "semantics". Just as words cannot exist without meaning, so lexicology and semantics cannot exist without each other.

Lexicology is the study of the entire vocabulary of a language. It identifies historical changes in the structure of the lexicon, a variety of words borrowed from other languages, archaisms, neologisms, literary lexicon, slang, regional, dialectal terminology, specialization and other lexically divided words based on clear principles. considers different lexical categories and types.

The object of study of semantics is not lexical meaning in general, but lexical meaning. Semantics studies the lexicon of a language from a specific point of view, that is, from the point of view of meaning. So while the whole lexicon is studied by lexicology, semantics is a specific part of it and it is subordinate to lexicology.

Semasiology studies the spiritual side of lexical units and solves problems related to the nature of lexical meaning, types, laws of development of word meaning, different classifications of word meaning change. In traditional linguistics of the nineteenth century, the main task of semantic research was to study the types and causes of semantic changes specific to individual words and FBs. One of the most pressing problems in the history of language in the early twentieth century was the study of the structure of language as a system and the interdependence of specific semantic elements in language.

The lexical-semantic level covers all aspects of the semantic relations inherent in lexical units, the specificity of their diversity, their interaction with each other and with other elements of the system other than language (lexical paradigm). semantic diversity of specific features - conditions and forms of lexical expression (lexical syntagmatics). As the name implies, the term "lexical-semantic" suggests that it explores two different natures of the system. First, lexical semantics differs from grammatical semantics in the semantic boundaries of language. Second, using this system, word semantics can be broken down as a lexical element.

The language system, dictionary structure and lexical-semantic systems play an important role in distinguishing the set of nominative tools that make up the lexical system from the vocabulary. They represent the result of a complex interrelationship between a word and its meanings and the generalization of these results. Such interaction takes place in two areas of language: nominative-classification and lexical.

Idioms. The word idiom comes from the Greek word meaning "peculiar," "peculiar." Accordingly, idioms are also a form of phraseology and 'lexicalized' words. Therefore, when it comes to idioms, they are not considered as the fourth type of phraseology, along with phraseological complexes, phraseological integrity and phraseological compounds, nor as a separate linguistic unit. The reason for this is that while idioms are similar to phraseologies in terms of figurative meaning, sometimes they are also expressed in such a meaning not in the form of association, but within a single word.

Apparently, the term idiom includes both individual words and word associations. This is because the meaning of the term idiom can be limited to a range of phraseological connotations, but if this classification takes into account phraseological compounds based on only one word in a figurative sense, idioms can again be divided from stable associations into a single word. pulls towards.

The conclusion is that idiomatic words are similar to phraseological expressions in terms of their semantic development, especially phraseological confusions (in terms of equivalence to a word), but in idioms they are not portable with a primary meaning. The distance between the no and the distance from each other is stronger than in the expressions.

It is well-known that phraseological units give speech meaning, essence, validity, imagery and clarity. These features of phraseology are clearly preserved even in the style of speech, which does not involve any artistic image. Only in the artistic interpretation is the expressive nature of the phraseology more vivid, and in the hands of the writer the FBs serve as the main tool that can clearly express the culture, spirituality, intellectual potential of the protagonist.

Phraseology is the youngest branch of linguistics and gained the attention of linguists only in the 1960s. It was originally developed as a separate linguistics department by Russian linguists E.D. Polivanov and B. A. Larrin studied, and later V.V. Vinogradov, A.V. Linguists such as Kunin and Smirnitsky have worked on various internal issues. In general, the first researcher in the field of phraseology was the French-Swiss scientist Charles Balli. The development of phraseology as a separate science can be historically divided into three stages:

Covers the period from the middle of the XVIII century to the 30s of the XX century, the period of phraseological research MN Lomonosov, A.A. Potebnya, F.F. Fortunatov, A.A. In connection with the scientific activity of chess players;

30s-50s of the twentieth century E.D. Polivanov, V.V. Vinogradov, S.I. Abakumov, G.K. The period created by linguists such as Damilov, AI Yefimov, AY Rozhansky;

Continues from the 60s of the twentieth century to the present day. This period is characterized by the use of various methods in phraseological research, the rapid development of the field of phraseology and the development of many phraseologists.

Although phraseology is recognized as a separate discipline from the point of view of modern linguistics, it is developing in direct connection with lexicology, grammar, stylistics, phonetics, history of language, history of philosophical sciences, logic and geography.

#### **REFERENCES**

1. Sh.Rahmatullaev. Some Uzbek phraseology issues, Tashkent, 1966, pp. 9-58.
2. Sh.Rahmatullaev. The beauty of our speech, Tashkent, 1970, pp. 5-43
3. U. Tursunov and others. Modern Uzbek literary language, Tashkent, 1992, 55-126-p
4. Modern Uzbek, Tashkent, 1957, pp. 152-181.
5. A.Mamatov. Fundamentals of the formation of phraseology, Tashkent, 1996, 5-48-p

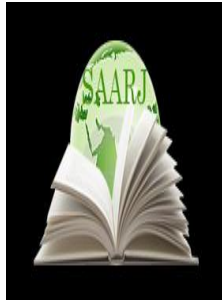

**ACADEMICIA**  
**An International**  
**Multidisciplinary**  
**Research Journal**  
 (Double Blind Refereed & Peer Reviewed Journal)



**DOI: 10.5958/2249-7137.2021.01221.0**

## EXPRESSION OF TEMPORALITY IN GERMAN AND KARAKALPAK LANGUAGES

**Sapargul Tursinbaevna Bainiyazova\*; Azat Tursinbaevich Bainiyazov\*\***

\*Assistant Teacher,  
 Department of Foreign Languages  
 Nukus State Pedagogical Institute named after Azhiniyaz,  
 UZBEKISTAN  
 Email id: sapargul.bainiyazova@bk.ru

\*\*Assistant Teacher,  
 Department of Foreign Languages  
 Karakalpak State University named after Berdakh,  
 UZBEKISTAN

### ABSTRACT

*This article discusses the comparative study of the expression of the meaning of temporality in German and Karakalpak languages, as well as the opinion of well - noun linguists on the comparative study of the expression of the meaning of temporality. The authors compare the expression of temporality in German and Karakalpak languages and gives examples.*

**KEYWORDS:** *Comparisons, Temporality, Adverbs, Comparison, Expressions, Similarity, Multi-System Languages, Cognition, Resistance, Research, Interactions, Combination, Relation, Analysis, Method.*

### INTRODUCTION

In connection with the increasing role of the study of foreign languages, there is a need for a more in-depth study of them. But, as you know, mastering the grammatical structure of a foreign language, in particular, in German, presents certain difficulties for students of national schools. This is due to the fact that students are faced with completely different grammatical phenomena than in their native language, in addition to that, there is a wide interest in the problems of comparative - typological study of languages of different systems.

R. Y. Barsuk explains the widespread of the comparative study of languages different systems in our country by five reasons (conditions) [1, 535-536].

In recent decades, we are very much faced with questions about the causes and similarities and differences in the structure of the language and in the evolutionary process from this or another soil. Comparisons of languages of this kind serve as the basis for extensive linguistic generalizations.

The importance of the comparative study of languages was pointed out by many scientists, including Academician L.V. Shcherba. He wrote: "The resistance of one language to another on the basis of comparisons, how the same thought in different languages is expressed in different ways and makes a person more attentive to the subtle nuances of thought and feeling"[2, 54].

Paying great attention to the comparison and comparative study of languages, V. I. Yartseva writes: Comparison always inevitably includes the knowledge of the studied material. Even in studies aiming at describing a language as a closed system with plans lying outside of it, as is the case, for example, when comparing the plane of expression and the plane of content. Therefore, comparison can be considered the most universal way of studying the material of a language. And this is quite reasonable, since the comparative method has not only theoretical, but also practical significance. Practical benefits are great for both translators and methodologists. The materials of these studies can contribute to improving the grammatical characteristics of words in bilingual dictionaries, improving the quality of illustrative examples in them, as well as being used by the authors of textbooks and teaching aids [3, 190].

Comparative study of the German and Karakalpak languages was obtained not only as a method in the development of linguistic science, but it equally benefits in the practice of teaching the German language in the national school, in improving the teaching methods of this discipline, in the development of translation. It should be stated that the comparative study of languages of different systems has now received its independent development. This method is constantly developing and improving with each new theoretical work, although some problems associated with the comparative method have not yet been finally solved.

The comparative method is a set of research techniques used to identify common and specific features in the studied languages, as well as the results of their interaction. Despite the importance of comparative study of German and Karakalpak languages, this problem has not yet been fully resolved. Expressions of temporal meaning in languages of different systems are of particular interest in terms of our research.

Temporal relations are widely used in all languages, including comparative German and Karakalpak. They are expressed in different ways, namely in different parts of speech. Both the German and the Karakalpak languages have a number of adverbs that express temporal relationships.

These adverbs are in German: heute, morgen, früh, spät, jetzt, sofort, abends, morgens, täglich, and jährlich.

Below we provide examples.

Und wir haben das bis heute nicht gewußt! ( Usbekische Sauber Märchen Churram Rachimov).

Am nächsten Morgen ging er damit zu dem Mann und sagte zu ihm: „ keine andere soll meine Gemahlin werden als die, anderen Fuß dieser goldene Schuh paßt „ . (Brüder Grimm. Aschenputtel und andere Märchen).



Sie gingen die ganze Nacht und noch einen Tag von Morgen bis Abend, aber sie kamen aus dem Wald nicht heraus und waren so hungrig. (Brüder Grimm. Aschenputtel und andere Märchen).

Früh morgens mußte Gretel heraus, den Kessel mit Wasser aufhängen und Feuer anzünden. (Brüder Grimm. Aschenputtel und andere Märchen)

Eines Abends gab es ein fruchtbares Umwetter; es blitzte und donnerte

Der Regen floss in Strömen, es war ganz schrecklich! (Nach dem Hans Christian Andersen. Märchen).

Abends legte es sich zu gewöhnlicher Zeit mit seiner Frau zu Bett: als sie glaubte, er sei eingeschlafen, stand sie auf, öffnete die Tür legte sich wieder. (Brüder Grimm. Aschenputtel und andere Märchen).

Clerfayt stand auf „Ich fahre jetzt ins Hotel. Wo können wir zusammen zu Abend essen?“, (Erich Maria Remarque. Der Himmel kennt keine Günstlinge).

„Wenn du erst Ministerpräsident bist, ist es zu spät“. (Erich Maria Remarque. Der Himmel kennt keine Günstlinge).

Eine Stunde später saß der Wagen fest. (Erich Maria Remarque. Der Himmel kennt keine Günstlinge).

In the Karakalpak language, the adverb: хәзир, бүгін, ертең, кеше, ерте, алдын, бурын etc. express this attitude.

-Маратсендаладакүтетур, Гүлзархәзиркийинипизиңненшығады, – деди. (Т. Қайыпбергенов. Уйқысызтүнлер)

ЕртеңинеМаратқакелдим. (Т. Қайыпбергенов. Уйқысызтүнлер).

Кеше кеште ол мени излеп емлеуғанаға келген екен. (Т. Қайыпбергенов. Уйқысызтүнлер).

Бурынғы өткен заманда бир бай болыпты. (Карл Райхель. Қарақалпақ халық ертеклери).

Our data on the comparison of sentences with adverbs in the German and Karakalpak languages show that the dialects of the Karakalpak language mainly correspond to the German dialects.

The German dialect hier, depending on the content of the structure of speech, can be transmitted: бунда, усында, hier - булжерде, täglich – күнсайынхәркүни.

Schon damals hatte Clerfayt gedacht.(Erich Maria Remarque. Der Himmel kennt keine Günstlinge).

Morgen beginnt für uns ein schweres und gefährvolles Leben (Erich Maria Remarque Der Himmel kennt keine Günstlinge)

A comparative study of the expression of the meaning of temporality in the German and Karakalpak languages comes to the following conclusion: This question is of interest because it has not been developed in a typological sense. Temporality is one of the most used linguistic phenomena not only in our comparable languages, but in all languages of the world.

Expressions of temporality in adverbs are characteristic for the German language as well as for the Karakalpak language. An analysis of our examples taken from the German and Karakalpak languages shows that the expression of the meaning of temporality in adverbs reveals a complete similarity rather than a difference in these languages.

### LITERATURE

1. Barsuk R.Yu. The main problems of teaching foreign languages in the national school; Baku 1969 from 535 - 536
2. Shcherba L.V. Selected works on the Russian language, L. 1957, p. 54.
3. Yartseva V.N. Comparative - typological research in the field of syntax. L. 1973. P.190
4. Erich Maria Remarque. Der Himmel kennt keine Günstlinge A.S.T. 2018
5. Usbekische Sauber Märchen. Gabriele Keller, Churram Rachimov T. 2018.
6. Brüdern Grimm. Aschenputtel und andere Märchen. Inter Nationes B. 1990.
7. Hans Christian Andersen. Märchen. S-P 2007
8. T. Kayipbergenov. Uykysyz Tunler. N. 1987.
9. Karl Reichel. Qaraqalpaq xalıq ertekleri. N. 1991.

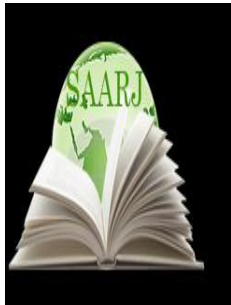

**ACADEMICIA**  
**An International  
 Multidisciplinary  
 Research Journal**  
 (Double Blind Refereed & Peer Reviewed Journal)

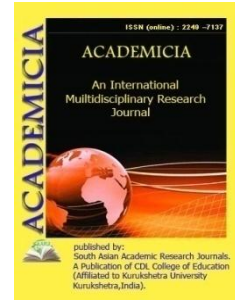

**DOI: 10.5958/2249-7137.2021.01223.4**

## EMERGENCE OF WOMEN ENTREPRENEURSHIP VENTURES IN INDIA

**Ms. Santika Timungpi\*; Dr. A. Ibemcha Chanu\*\***

\*Research Scholar,  
 Department of Commerce, Assam University Diphu Campus,  
 INDIA

Email id: santika.timungpi@gmail.com

\*\*Assistant Professor (Sr)  
 Department of Commerce, Assam University Diphu Campus,  
 INDIA

Email id: ibemchac6@gmail.com

### ABSTRACT

*Change in the Indian business environment because of globalisation has brought many advantages for those women who want to become entrepreneurs. The basic objectives of the paper are to find out the nature of women entrepreneurship ventures in India and examine the motivational factors of women entrepreneurs. Since India is a land of diverse culture, it is assumed that nature of women entrepreneurship ventures differ from place to place. The study is descriptive in nature and based on in-depth review of literature. The studies which have been published in various academic journals and articles in books on various aspects of women entrepreneurship in India during 1996 to 2016 have been considered.*

**KEYWORDS:** *Women Entrepreneurship, Diverse Culture, Globalisation, Motivational Factors.*

### INTRODUCTION

The population census 2011 clearly depicts that almost half of the total population of India is women. Since time immemorial women have been playing different roles in not only in the economic development of the country but also change in the social system. However, their contribution in the economic development is being hardly recognized in male dominated society like India. Until and unless women's unpaid work is recognized, efforts towards building a gender balance in society cannot be achieved (Islam, M.Aminul, n.d.). It is clearly depicted in

many studies that there are a good number of successful women entrepreneurs which makes the country feeling proud. There is an emergence of new class of women entrepreneurship in the country after 1991. This phase may be considered as a paradigm ship in the women entrepreneurship development in India.

According to Ahmad Ansari & Danish (2016), the work participation of women in India is the lowest in comparison to other countries. Women work participation in India has got momentum recently as the percentage of work participation went up from 14.2% in 1970-71 to 31.6% in 2010-2011. The expansion of job market which have been brought by neo-liberal -economic system along with aggressive entrepreneurship training programmes conducted by various promoting agencies, women of India have started participating in entrepreneurial activities. However, there are certain issues which need to examine that in which type of entrepreneurship ventures do women involve and are the types of women entrepreneurship ventures same in all the parts of the country.

The paper is presented in different sub heads and divided into five parts-the first part of the paper gives an outline of the paper including introduction, relevance of the study, objective of the study & preposition. The second part presents the research designs which have been followed and the third part deals with the review of literature and research gap. The fourth part presents the findings which are followed by conclusion & suggestions in the last part.

### **Relevance of the study:**

India is a male dominated society where women are considered as economically weak and socially dependent on male members. Empowering a woman is one of the prime factors that can help in achieving social harmony. A society cannot be termed as developed unless the participation of women in every walk of life is not fairly represented. In this regard, the participation of women in the field of entrepreneurship is positive trend in every society.. The introduction of MSMED Act, 2006 can also be considered as an important step by Government of India towards the development of MSME in India. The Act has introduced various schemes which provide skill training for needy women to make economically independent. It is evident from various studies that there is ever increasing trend in the involvement of women in entrepreneurial activities. According to Ghani, Kerr and O'Connell (2012) women owned business ownership share in India increased from 26% in 2000 to 37% in 2005.

Over the years women have made great strides in many areas with notable progress in reducing gender gap. Women are shifting themselves from traditional activities to modern activities. This paper looks at the literature to examine the nature of business run by the women entrepreneurs in India and to determine the various motivational factors of women in joining entrepreneurial activities. It is hoped that it will be useful to the policy makers and fellow researchers who are undertaking studies in this area.

### **Objective of the Study:**

1. To find out the nature of women entrepreneurship venture in India.
2. To examine the motivational factors behind the women entrepreneurship venture in India.

**Preposition:**

- i. Since India is a home of diverse culture, women who hail from different regions of the country operate different form of entrepreneurship ventures.
- ii. Economic condition of the family like poverty motivates women of India to start entrepreneurship ventures and hence, the majority of women entrepreneurship are not innovative ventures.

**Research Methodology:**

It is a descriptive research in nature and based on secondary data. An in-depth review of literature has been conducted in order to study the different dimensions in women entrepreneurship development in India. The studies which had been conducted and published during 1996 to 2016 have been reviewed for the present study. All the studies have been collected from journals, published books, and article. In this paper, India is divided into five zones they are: North (Uttar Pradesh, Himachal Pradesh, Haryana, Uttaranchal, Jammu & Kashmir and Punjab) South (Andra Pradesh, Karnataka, Tamil Nadu, Telengana and Kerela) East(- West Bengal, Orissa, Bihar and Jharkhand), West (Rajasthan, Gujarat, Goa, Maharastra, Madhya Pradesh and Chattisgarh), North-East (Sikkim, Assam, Arunachal Pradesh, Nagaland, Manipur, Tripura, Mizoram and Meghalaya). The findings are presented with the help of tabulation.

**Review of Literature:**

In this section, the literatures are reviewed under two heads which are nature of women entrepreneurship and motivational factors. According to MSMED Act, 2006 whether male or female enterprises are categorised into three types: (i) Micro, (ii) Small and (iii) Medium Enterprises and they are defined on the basis of the investment in plant and machinery (for manufacturing enterprises) or in equipment (in case of enterprises providing/rendering of services).

**(i) On the nature of women entrepreneurship venture:**

Many argue that women enterprises of India are micro, small and medium in nature. It is seen in the studies of Mishra, Dr.S.P. (1996), Samani, Veena S. (2008), Jyoti, Jeevan & Sharma, Jyoti (2011), Rai, Usha Kiran & Srivastava, Monica (2011), Das, Malika (2012), Sharma, Dr.Ajay; *et.al.*, (2012), Palaniappan, G.; *et.al.*, (2012), Kalayani P.R., Dr.Brinda & Kumar M., Dr.Dileep (2012), Pandey, Dr. Vivekanand (2013), Kurbah, Sairabell (2013), Kaushik, Sanjay (2013), Vijayakumar, Dr. A. & Jayachitra, S., (2013), Agarwal, Reena (2014), Chanu, Yumlembam Linthoi & Chanu, Dr. Ayekpam I. (2014), Murugesan, G, (2014), Chakraborty, Dipanjan & Barman, Dr. Ratan (2014), P.C., Sushail & Kamaludheen, K.M. (2015), Hameed, Dr. Syed Abdul (2015), Raval, Harishkumar M. & Swami, Leelaben M (2015), Ansari, Danish Ahmad (2016).

Women entrepreneurs of India also own manufacturing and service enterprises. This is revealed in the studies of Mishra, Dr.S.P. (1996), Rani, Lalitha (1996), Jesurajan, S.Vargheese Antony & Gnanadhas, Dr.M.Edwin (2011), Palaniappan, G.; *et.al.*, (2012), Chanu, Dr.Ayekpam I.& Teronpi, Monalisha (2012), Mehta, Dr.Pallavi (2013), Mukherjee, Sujata (2015).

There are also co-operative enterprises which women entrepreneurs have ventured recently in India. The studies conducted by Datta, Runita Bhatt & Gailey, Robert (2012), Levaku, Rajani (2014), Nanjappa, Dr.Chi & Nithya, K. (2015), Sudan, Falendra Kumar & Singh, Ishita (2015) clearly reveal it.

(ii) **Review of Motivating factors:**

Motivation is one of the most important factors effecting human behaviour. It can also change a performance of a person. Hence women entrepreneurs are also the outcome of motivation. Many studies reveal that there are various factors which motivate women to become entrepreneur. They are push factor, pull factor, internal factor, external factor, economic factor, social factor and psychological factors. The motivating factors behind women entrepreneurs are revealed from the studies of Dasgupta, B. (2004), Suganthi, J. (2009), Katoch, Sumita;*et.al.*, (2010), Goyal, Meenu & Prakash, Jai (2011), Jyoti, Jeevan & Sharma, Jyoti (2011), Jesuranjan, S.Vargheese Antony & G., Dr.M. Edwin (2011), Sorokhaibam, Dr. Robita and Laishram, Nandita, (2011), Rai, Usha Kiran & Srivastava, Monica (2011), Vatharkar, Poonam, (2012), Chanu, Dr.A.Ibemcha & Terangpi, Monalisha (2012), Kalayani P.R., Dr.Brinda & Kumar M., Dr.Dileep (2012), Babu, B.Dili & Rathnakumari, Prof.S. (2013), Bordoloi, Anjan Kumar & Machey, Ashwini, (2013), Mehta, Dr.Pallavi (2013), Sharma, Yogita (2013), Chakraborty, Dipanjan & Barman, Dr.Ratan (2014), Roy, Sujit & Manna, Samita (2014), P.C., Sushail & Kamaludheen KM, Muhameed (2015), Patel, Palak & Merja, Jay (2015), Bhuvaneshwari, P.Devi & Annapoorani, R (2015), Sharma, Jitendra K. & Gwal, Anant (2015), Reddy, K. Bhavika (2015), Srivivasu, b & Ratra, kanika (2015), Mukherjee, Sujata (2015), Rich, Ella (2015), Jha, Srabani (2015), Raval, Harishkumar M. & Swami, Leelaben M (2015), Baruah, Hemen Kumar & Bhorali, Devdas (2016), Yasmin, M. Shapna & Prathiba, Dr.N. (2016), Patel, Dr.C.K. & Desai, Shri P.K. (2016).

Push factors are those factors where behaviour of an individual forces themselves to complete in order to satisfy a financial need due to family circumstance or achieve a goal and Pull factors refer to the urge in women to undertake ventures with an inclination to start business (Jesurajan, S.Vargheese Antony & Gnanadhas, Dr.M.Edwin,2011)

According to Cohoon, et.al.,(2010), Jesurajan, S.Vargheese Antony & Gnanadhas, Dr.Edwin (2011), Revathi, D.Shanthi & Krishnan, Dr.Jayashree (2011), Datta, Punita Bhatt & Gailey, Robert (2012), Panchal, Rekha & Dua, Kavita (2013), Kaushik, Sanjay (2013), Pandey, Dr.Vivekanand (2013), Balhara, Shruti & Singh, Ajmer (2015) the factors which motivates women to become entrepreneurs are social factor, economic factor and psychological factors.

**FINDINGS:**

**A. Types Of Women Entrepreneurship Ventures in India**

There are different types of women entrepreneurship ventures in India. According to the nature of investment, there are three types of ventures. They are micro, small and medium enterprises. According to the types of products there are two types of ventures. They are service and manufacturing enterprises. Partnership and Co-operative form of enterprises is also another venture which is found in Indian context. A comparative picture on different nature and types of women entrepreneurship venture in different regions of the country are shown in Table 1.

**TABLE 1. TYPES OF WOMEN ENTREPRENEURSHIP VENTURES IN DIFFERENT REGIONS OF THE COUNTRY**

Different type of enterprises	NORTH	SOUTH	EAST	WEST	NORTH-EAST
	YES/NO	YES/NO	YES/NO	YES/NO	YES/NO
Micro enterprise	√	√	√	√	√
Small enterprise	√	√	√	√	√
Medium enterprise	√	√	√	√	√
Large enterprise	√	√	√	√	X
Cottage enterprise	√	√	√	√	√
Sole-proprietorship	√	√	√	√	√
Partnership	√	√	√	√	X
Co-operative enterprise	√	√	√	√	√
Manufacturing enterprise	√	√	√	√	√
Service enterprise	√	√	√	√	√
Organised enterprise	√	√	√	√	√
Unorganised enterprise	√	√	√	√	√
Innovative	√	√	√	√	√
Imitative	X	√	X	X	X
Fabian	X	X	X	X	X
Drone	X	X	X	X	X

Source: Compiled from the Review of literature

Table 1 clearly indicates that there are different types of women entrepreneurship ventures in India. These types of ventures vary from place to place. It is seen that Micro, Small, Medium, Cottage, Sole-Proprietorship, Co-operative, Manufacturing, Service, Organised, Unorganised and Innovative enterprises are found in all the parts of India. Though large and Partnership form of enterprises are found in North, South, East and West India, these are not found in North-East India. The Imitative enterprise is found only in South India. Fabian and Drone enterprises are not seen any parts of India, whereas, innovative entrepreneurship ventures are found in all the parts of the country.

### **B. Motivating Factors Of Women Entrepreneurs in India**

Women in India have taken up entrepreneurial activities because of different reasons. These reasons are also known as motivational factors. The factors are depicted in the following table 2.

**TABLE 2. MOTIVATING FACTORS OF WOMEN ENTREPRENEURS IN INDIA**

Different	Motivational factors
Push factor	Poor income, unemployment, hereditary occupation, economic survival, family compulsion and trust upon them, need for additional income, need for money, desire for good life, no other alternative job, responsibilities to continue business, sudden fall in family income, death of earning member, inadequate income of family, family support, insufficient family income, difficulty in finding work and a need for flexible work schedule, economic difficulties & challenging, to secure self-employment, to fulfil the ambition of self/ parents/ spouse, shoulder one's responsibility.
PULL FACTORS	urge to do something new, education and qualification, role model to others, success stories of others, government policies, need to be their own boss, better work life, ambition, economic independence & challenge, economic status and interest, market potential, family background, feel proud to be entrepreneur, mental satisfaction, need for independence, ease to start business, existing business environment, to gain social recognition, entrepreneurial desire and desire for wealth, co-operation and support of family members and a strong network of contacts, self-achievement, self-perception, self-esteem, entrepreneurial intensity, to produce new products, self-realization/ awakening, competence in managing business, accessibility to information, government concession, threat of losing job, Entrepreneurship development programmes,
ECONOMIC FACTOR	Financial support from Government and other financial agencies, awareness about the loan scheme, profitability of business, to make use of idle funds.
SOCIAL FACTOR	Moral support of family, recognition given by the society, to achieve higher status in the society, to do social work.
PSYCHOLOGICAL FACTOR	Urge for learning, not afraid of failures and business risk, do not get discourage easily, high self esteem, self confidence & self perception, satisfaction with business earning, satisfied with family support, satisfied with workers, innovative instincts.

Source: compiled from the review of literature.

The findings of an in depth review of literature with regard to the motivational factors of women entrepreneurs in India clearly indicates that different factors motivate Indian women to join entrepreneurship. Different authors have considered the factors as push factors, pull factors, social factors, economic factors and psychological factors. It is also clearly revealed from the findings that not only the economic factors (poverty) but also different factors like psychological factors play an important role to bring the women in entrepreneurial race. Hence, the proposition which has been developed for the present paper is not supported by the findings, hence, it is rejected. However, empirical study is called for to test it.



---

**CONCLUSION AND SUGGESSTION:**

Various studies on women entrepreneurship have revealed that women play an important role in the economic development of the country. There are instances in the country where women have excelled in the field of entrepreneurship and effectively leading big corporate houses. The leadership qualities in women need to be harness. The government of India has lately introduced many schemes to promote start-up particularly among women but it is also painful fact that government sponsored schemes have not penetrated to all sections of the society in equal manner. In most of the cases illiteracy, remoteness of the place and lack of capital are the hindrance for women to choose entrepreneurship. It is therefore imperative to have a greater knowledge about the motivations among the women that will push them to pursue entrepreneurial activities. Our policies must ensure a good platform and atmosphere in terms of social and financial security (access to financial institution) for women to allow them to participate in the growth story of modern India. To conclude, in the words of former President APJ Abdul Kalam “Empowering women is a prerequisite for creating a good nation, when women are empowered, society with stability is assured.” Hence, women entrepreneurship development is required to bring women empowerment in India.

**REFERENCES:**

- Agarwal, Reena, (2014), ‘Opportunity recognition and growth dynamics of an MSME unit-A case of women entrepreneurship in India,’ *Journal of women’s entrepreneurship & Education*, issue 3-4, pg. 83-94.
- Ansari, Danish Ahmad, (2016), ‘Women entrepreneurship in India, *AEIJST*, Vol.4, issue 4.
- Babu, B.Dilli & Rathnakumari, Prof. S, (2013), ‘Motivational Factors Influence of Entrepreneurs Towards Entrepreneurship: A Study of Chittoor District In Andhra Pradesh’ *Peripex, Indian Journal of Research*, Vol. 2 No. 2.
- Balhara, Shruti & Singh, Ajmer, (2015), ‘Women Entrepreneurship: A Big Motivation,’ *Business and Economic Research*, vol.5, no.2.
- Barman, Dr. R., & Chakraborty, Dipanjan, (2014), ‘A Study on Impact of Motivational Factors On The Growth Of The Rural Entrepreneurs Of Assam’, *IOSR Journal Of Business And Management*, Vol. 16.
- Baruah, Hemen Kumar & Bhorali, Devdas (2016), ‘Problems of women entrepreneurs in a tribal area a study of udalguri district of BTAD Assam,’ retrieved from [http://shodhganga.inflibnet.ac.in/bitstream/10603/114439/14/14 chapter%204.pdf](http://shodhganga.inflibnet.ac.in/bitstream/10603/114439/14/14%20chapter%204.pdf) accessed on 23/04/2017.
- Bhuvaneshwari, P.Devi & Annapoorani, R., (2015), ‘Dalit Women Empowerment through Entrepreneurship: A case study of Coimbatore District,’ *Entrepreneurship Development Institute of India*.
- Bordoloi, Anjan Kumar & Machey, Ashwini, (2013), women entrepreneurship in Assam: the motivational factors underpinning and the operational problems, *ZENITH international journal of business economics & management research*, VOL.3 (12).

- Chanu, Dr.Ayekpam Ibemcha & Terangpi, Monalisha, (2012), 'Women entrepreneurship development in Tribal areas of Assam- An alternative approach towards poverty alleviation, *The Utkal Business Review(Journal of Business Studies)*, vol.26, pg 270-277.
- Chanu, Yumlembam Linthoi & Chanu, Dr.Ayekpam Ibemcha, (2014), 'women Entrepreneurs of Manipur after MSME Act 2006, An analysis, *Journal of Entrepreneurship and management*, vol.3, issue 2, Pp.32-38, ISSN 2277-6850.
- Cohoon, *et.al.*, (2010), ' The Anatomy of an Entrepreneur – Are Successful Women Entrepreneur Different from Men? Kauffman, *the Foundation of Entrepreneurship*.
- Das, Madhumita, 'Problems and Prospects of women entrepreneurs in India,' retrieved from [http://www.academia.edu/1381411/PROBLEMS\\_AND\\_PROSPECTS\\_OF\\_WOMEN\\_ENTREPRENURS\\_IN\\_INDIA](http://www.academia.edu/1381411/PROBLEMS_AND_PROSPECTS_OF_WOMEN_ENTREPRENURS_IN_INDIA) accessed on 27/04/2017.
- Das, Mallika, (2012), 'Women Entrepreneurs from India: Problems, Motivations and Success factors,' retrieved from <http://www.tandfonline.com/doi/abs/10.1080/08276331.2000.10593294> accessed on 27/04/2017.
- Dasgupta, B., (2004), 'Entrepreneurial Motivation – A Comparative Study Of Male and Female Entrepreneurs,' *Research Paper presented at National Seminar on Women Entrepreneurship- A need for Training and Curriculum Development held by Development of Home Science Extension & Communication*.
- Data, Punita Bhatt & Gailey, Robert, (2012), 'Empowering women through social entrepreneurship: A case study of a women's co-operative in India,' *Entrepreneurship Theory and practice*, vol.36, issue 3.
- D'Cruz, N.K., (2003), 'Constraints on women entrepreneurship development in Kerela: An analysis of familial, social and psychological dimensions. Thiruvanthapuram India, *Centre for Development Studies*.
- Ghani, B, *et.al.*, (2012), 'Local Industrial structure and female entrepreneurship in India,' *Journal of Economic Geography*.
- Goyal, Meenu & Prakash, Jai, (2011), 'Women Entrepreneurship in India- Problems and Prospects, *International Journal of Multidisciplinary Research*, vol.1, issue 5.
- Hamed, Dr.Syed Abdul (2015), 'A study on the problem and prospects of women entrepreneurs in India,' *International Journal of Economic Business Review*, vol.3 issue 7.
- Jesuranjan, S.Vargheese Antony & G., Dr.M. Edwin (2011),, 'A study on the factors motivating women to become entrepreneurs in Tirunelveli District', *Asian Journal of Business and Economics*, Vol. 1 no. 1.
- Jha, Srabani, (2015), 'Women entrepreneurship in West Bengal; Problems and motivation, *Eleventh Biennial Conference on entrepreneurship*.
- Jyoti, Jeevan & Sharma, Jyoti (2011), 'Factors affecting orientation and satisfaction of women entrepreneurs in rural India,' *Annals of innovation & Entrepreneurship*.

- Kaushik, Sanjay, (2013), 'Challenges Faced by Women Entrepreneurs in India,' *International Journal of Management and Social Science Research*, vol.2 no. 2.
- Kalayani P.R., Dr. Brinda & Kumar M., Dr. Dileep,(2012), Motivational factors, entrepreneurship and education: study with reference to women in SMEs, *Far East Journal of Psychology and Business*, Vol 3 no 3,
- Katoch, Sumita, *et.al.*, (2010), 'A study of motivational factors for women entrepreneurs of Ludhiana city,' *Agricultural Research Communication Centre*.
- Kaushik, Sanjay, (2013), 'Challenges faced by Women entrepreneurs in India,' *International Journal of Management and Social Sciences Research*, vol.2, no.2.
- Krishnamoorthy, V. And Balasubramani, R,(2014), Motivational factors among women entrepreneurs and their entrepreneurial success, *International Journal of Management Research and Business Strategy*, Vol.3 no. 2.
- Kurbah, Sairabell, (2013), Role of women entrepreneurs in the economic development of Meghalaya: A North Eastern state India, *International Journal of engineering, business and enterprise application*.
- Lalitha, Rani, (1996), 'Women entrepreneurship: A case study of Visakhapatnam city,' *APH Publishing corporation New Delhi*.
- Levaku, Rajani,(2014), Women entrepreneurship through Self Help Group in YSR district, India, *Journal of Women Entrepreneurship and Education*, issue 1-2.
- Mehta, Dr.Pallavi, (2013), 'Women entrepreneurship; Purpose, problems & prospects: A study of Udaipur District,' *Pacific Business Review international*, vol.5 issue11.
- Mishra, Dr.S.P., (1996), ' Factors Affecting Women Entrepreneurship in Small and Cottage Industries,' *International Labour Organisation*.
- Mukherjee, S., (2006), what motivates women entrepreneurs: Factors influencing their motivations, *ICFAI Journal of Entrepreneurship*, Vol. 3, no.4.
- Mukherjee, Sujata, (2015), 'Women entrepreneurship Development in India: Contributing and inhibiting factors, *Eleventh Biennial Conference on entrepreneurship*.
- Muregesan, G., (2014), 'Problems & Prospects of women entrepreneurs in India,' *Journal of Business Management & Social Sciences Research*, vol.3 no.11.
- Nanjappa, Dr.Chi & Nithya, K. (2015), 'Perception of Self Help Group Women towards Entrepreneurship: A Study in Karur,' *Primax International Journal of Commerce and Management Research*.
- Palaniappan, G., *et.al.*, (2012), 'A study on problem and prospects of women entrepreneurs with special reference to Erode district,' *International Journal of Physical and Social Science*, vol.2 issue 3.
- Panchal, Rekha & Dua, Kavita, (2013), 'A study on motivational Factors for becoming the women entrepreneurs in Haryana(India), *International Monthly Referred Journal of Research in Management and Technology*, vol. 11.

- 
- Pandey, Dr.Vivekanand, (2013), 'Factors influencing entrepreneurial motivations on women entrepreneurs,' *BVIMSR's Journal of Management Research*, vol.5, issue 2.
  - Patel, Dr.C.K. & Desai, Shri P.K. (2016), 'Women Entrepreneurship Development, Constraints & Problems of Women Entrepreneurs in India,' *Indian Journal of Technical Education*.
  - Patel, Palak & Merja, Jay, (2015), 'Women Entrepreneurship: Engage-Inspire-Transform,' *Eleventh Biennial conference on Entrepreneurship*.
  - P.C., Suhail & Kamaludhun, K.M.(2015), 'Development of Women Entrepreneurship in India,' *Primax International Journal of Commerce and Management Research*.
  - Rai, Usha Kiran & Srivastava, Monica,(2011) Women entrepreneurs their aspiration and motives: An empirical study of Varanasi District, *Journal of Entrepreneurship Development*, Vol. 8 no. 2,
  - Raval, Harishkumar M & Swami, Leelaben M (2015), 'Role of social and economic factors in rural women entrepreneurship development,' retrived from [http://shodhganga.inflibnet.ac.in/bitstream/10603/105413/9/09\\_chapter%2004.pdf](http://shodhganga.inflibnet.ac.in/bitstream/10603/105413/9/09_chapter%2004.pdf) accessed on 23/04/2017.
  - Reddy, K. Bhavika, (2015), 'Women entrepreneurs in India: An Empirical analysis of motivations, success factors and problems,' *Eleventh Biennial Conference on entrepreneurship*.
  - Revathi, D.Shanthi & Krishnan, Dr.Jayashree, (2011), 'Success & growth of women entrepreneurs in their development: An empirical study with reference to Chennai city,' *International Journal of Management research and development*, vol.1 no.2.
  - Rich, Ella, (2015), 5 motivational factors that drive people towards entrepreneurship, retriverd from <http://wealthygorilla.com/5-motivational-factors-that-drive-people-towards-entrepreneurship/>, accessed on 02/08/2016.
  - Roy, Sujit & Manna, Samita, (2014), 'Women in entrepreneurship: Issues of motivation and choice of Business,' *Journal of Entrepreneurship & Management*, Vol. 3, issue 2.
  - Samani, Veena S., (2008), 'A study of women entrepreneurs engaged in food processing,' thesis Ph.D, Saurashtra University.
  - Sharma, Dr.Ajay, *et.al.*, (2012), 'Micro Enterprise and Rural Women Entrepreneurship: Way for Economic Empowerment,' *A Journal of Economics & Management*, Vol.1 Issue 6.
  - Sharma, Jitendra K. & Gwal, Anant (2015), 'A Study of Enterprising Spirit of women in Madhya Pradesh,' *Eleventh Biennial Conference on entrepreneurship*.
  - Sharma, Priyanka,(2013), 'Women entrepreneurship development in India,' *Global Journal of Management and Business Studies*, vol.3 pg. 371-376.
  - Sharma, Ms Yogita (2013), 'Women Entrepreneurs in India,' *Journal of Business and Management*, vol.15 issue 3.

- 
- Sorokhaibam, Dr. Robita and Laishram, Nandita, (2011), Women Entrepreneurship in Manipur North-East India, *Interdisciplinary Journal of Research in Business*, Vol.1, Issue 5.
  - Srivivasu, B. & Ratra, Kanika, (2015), 'Women entrepreneurs in small business: A case of Delhi, *Eleventh Biennial Conference on entrepreneurship*.
  - Sudan, Falendra Kumar & Singh, Ishita, (2015), 'Women Entrepreneurship through self-help group credit programme: Evidence from Jammu & Kashmir,' *Eleventh Biennial conference on Entrepreneurship*.
  - Suganthi, J., (2009), 'Influence of motivational factors on women entrepreneurs on SMEs,' *Asia Pacific Business Review*, vol.5, issue 1.
  - V., Krishnamoorthy and R., Balasurramani,(2014), 'Motivational Factors among Women Entrepreneurs and Their Entrepreneurial Success: A Study, *International Journal of Management Research and Business Strategy*, Vol3, No, 2.
  - Vatharkar, Poonam, (2012), A study of constraints and motivating factors for Indian women entrepreneurs in small scale, *the 2012 International conference on business and management*, 473-489.
  - Vijayakumar, Dr.A. & Jayachitra, S., (2013), 'Women entrepreneurs in India- Emerging issues and challenges, *International Journal of Development Research*, vol.3, no.4, pg 12-17.
  - Yadav, Vanita & Unni, Jeemol, (2016), 'Women entrepreneurship: Research Review and future direction,' *Journal of Global Entrepreneurship Research*.
  - Yasmin, M.Shapna & Pratibha, Dr.N., (2016), 'Motivational factors of women entrepreneurs,' *International Contemporary Research Journal in Management and Social Science*, vol.2, issue 2.

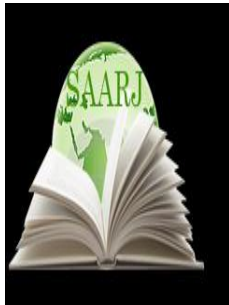

DOI: [10.5958/2249-7137.2021.01217.9](https://doi.org/10.5958/2249-7137.2021.01217.9)

## CRITERIA FOR THE FORMATION OF INNOVATIVE THINKING AND SOCIAL CONSCIOUSNESS IN YOUNG PEOPLE

Rajabboev Jurabek\*

\*Student,

Department of National Idea,  
Fundamentals of Spirituality and Legal Education,  
Urgench State University, Urgench, UZBEKISTAN  
Email id: sv997710@gmail.com

### ABSTRACT

*This article analyzes the issues of innovative consciousness and thinking of young people. It has been scientifically discussed that innovative thinking is an important factor in the innovative activity of young people.*

**KEYWORDS:** *Innovation, Creation, Creativity, Superior, Modern Education, Cognitive, Processes, Harmonious View, A Dynamic Features, Technical Research.*

### INTRODUCTION

A thirst for innovation, research and creativity is a human trait. It is this feature that motivates a person to look at himself as a subject of social existence and social relations. Doctor of Philosophy S.Norkulov writes: "Interest in knowing the world is unique for human. Due to the nature of the generalization of epistemological experiments and their use in changing the environment, man is the subject of social historical processes, created by civilization. These processes are related to mentality, consciousness, cognition, the pursuit of knowledge"[1]. The researcher reveals the laws of individual mentality and the transformation of consciousness into social mentality and consciousness, the first of which, no matter how important, becomes a product of "necessity" implied by N.A. Berdyaev through deterministic factors, especially social demands, the needs of society. To sum up, man's thirst for innovation, creation, and creativity is not just an individual phenomenon; they are related to social necessity. Here the demands of social development have a deterministic effect.

## **MATERIALS AND METHODS**

It should not be forgotten that there are also internal deterministic factors of creation. When it comes to creative mentality, this inner determinism is often referred. Internal deterministic factors include creative psychological phenomena such as ability, inspiration, the pain of thinking and creating, the desire to change the environment, the desire to further beautify and humanize, the ideal formed in the mind. These phenomena play a leading role in the lives of young people, especially in their imaginations. Eighty-two percent of our respondents consider it is a positive fact that the President and the government support the interest of young people in innovation and innovative research, and are ready to take advantage of these opportunities as much as possible. 78% of them emphasize that, schools, educational institutions and family institutions require young people to grow up as creative people, in this regard, first of all, parents help a lot, the spiritual and moral environment in the family, noble qualities, mutual support, altruism, respect to elderly people and traditions of honoring the little, spiritual support, encouragement.

69% of respondents say that family and school play an important role in a person's love for creativity, 51% say that the influence of friends is leading, 32% say that colleagues and classmates, and 21% say that special cultural and spiritual events of books and youth associations. At the same time, almost 94% of respondent youth express interest in this or that type of creative activity. It is true that among them artistic creation is in the lead (78%), young people interested in scientific and technical creativity are only about 3%. We specifically studied the answers of young people interested in scientific and technical creativity to our other questions. We found that in the family of these young people, either their father or brother was engaged in scientific and technical creativity. Among them are a few young people who are influenced by friends or others. It follows that the desire to engage in scientific and technical creativity is aroused by adults in the family. While the interest of young people in scientific and technical creativity is not formed by itself, the influence of external deterministic factors - family, friends - is in the forefront. The influence of special education and educational institutions is an axiom.

## **RESULTS AND DISCUSSION**

Youth is a formative stage of interest in the world, life, understanding them. There is no denying that there are innate abilities. For example, the famous composer Mozart wrote opera at the age of 4, the Russian composer Prokofiev at the age of 9, and Mendelssohn at the age of 14[2]. It is known that Alisher Navoi memorized Farid-ud-Din Attar's Mantiq ut-tayr at a young age, and that Beruni and Ibn Sina were interested in science from a young age and had unique abilities [3]. The abilities in these individuals have, of course, become a unique reality, perfected by external deterministic influences. It would have been impossible for these geniuses to reach the level of maturity if they had not worked on themselves, if they had not turned research into a way of life and thinking. Admittedly, sometimes there are exceptions in nature. For example, a 16-year-old boy comes to the famous Burdenko Research Institute. During the analysis, it is determined that the brain does not show any performance symptoms. Examination revealed that the young man had no right brain and the left side was insignificantly preserved. Nevertheless, the young man lived an active life, studied well, played sports, and was far superior to his peers in intellectual terms. This anomalous phenomenon surprised everyone [4]. This exception is not a simple natural phenomenon. Experts say that the human brain is 35 km long, has the ability to

send information to itself. There are enough prodigies who can memorize the whole pamphlet at once, write it fluently in both hands, memorize up to thirty numbers, and recite them in sequence at once. This means that a person, especially young people, can be taught the type of creation they want. Modern education, pedagogy is based on this principle. The above answers of our respondents also confirm this opinion. Innovation cannot be limited to the type of scientific and technical creation; it applies to all aspects and directions of human activity and interests. Therefore, in the literature there are such terms as "social innovation", "legal innovation", "agro-innovation", "and aesthetic innovation", "management innovation", "pedagogical innovation". Sometimes it is associated with scientific and technical research, innovation, it is considered that the introduction of scientific and technical innovations in the field, technological modernization. Replacement of production processes and services with modern equipment is interpreted as an innovation. In this interpretation, innovation is likened to any kind of innovation. In our opinion, it is appropriate to know it as a type of creative activity aimed at turning the field, object, process in an essentially new direction. The dynamic features and requirements of social existence, the development of society are one of the external determinants influencing innovative mentality.

In general, the cognitive phenomena that take place in the human mind and thinking are due to the influence of these determinants. "Social development affects people's thinking and consciousness through ambivalent events such as stable and changeable consequences and results, evolution and involution, revolutionary and counterrevolutionary, perceptual and coincidence, forcing them to live under the influence of certain ideas, views and spiritual values. In this case, social development comes as a product of certain ideas, views and spiritual values" [5] these contradictions of social existence are reflected in innovative mentality and research. Intuitive knowledge or inspiration in the field of creation is not always a perceived reality. Or the invention of a new technology may not always be of revolutionary significance. But every novelty, something of innovation, must in some way improve the function of the object. Only in this way does innovation meet the requirements of social existence, the development of society. Innovative mentality can be seen as a manifestation of social consciousness.

The fact that innovative mentality is a social being, derived from the demands of society, shows that it is in common with the social consciousness. True, this commonality is not absolute; they have their own characteristics, functional features. Cognitive processes related to social consciousness are also observed in innovative thinking. S.Norkulov sees the peculiarities of this process in the following: "Social consciousness is a simple sensory phenomenon, not an experience, it is a subjective reality based on scientific analysis of the external world, society and its immanent laws, political, economic, spiritual, cultural processes, life experiences, and the relationship between person and society, man and being .

## CONCLUSION

The nature of social consciousness in relation to social being requires an approach to human cognitive-sensory experiences in accordance with the laws and requirements of this being, the study of transformational changes in consciousness in terms of those laws and requirements, a harmonious view of endotransformation and exotransformation processes"[6].

To sum up, the connection between the requirements of social existence and innovative research is manifested in human sensory, cognitive experiences; the wavy, fluctuating course of these experiences is associated with fluctuation processes in this connection.



**REFERENCES**

1. Norqulov S. Transformation processes in civil society and social consciousness - Tashkent: Navruz, 2015. 33 p.
2. Peshkova V. The Phenomenon of Genius - Rostov on Don, Phoenix, 2006 - P.7.
3. Qayumov A. Works. 3 vols. Tashkent: Classic word 2009. pp. 106-107; Qayumov A. Works 9 volumes. Tashkent: Classic word, 2010. 64-65, 298-299-p.
4. Nerve cells are still restored // Arguments and Facts, 2015, no. 5.
5. Norqulov S. Transformation processes in civil society and social consciousness - Tashkent: Navruz, 2015. 186 p.
6. Norqulov S. Transformation processes in civil society and social consciousness - Tashkent: Navruz, 2015. 186 p.

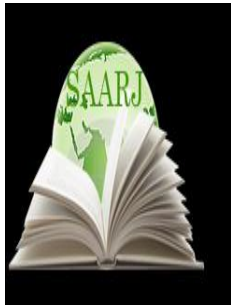

**ACADEMICIA**  
**An International**  
**Multidisciplinary**  
**Research Journal**  
 (Double Blind Refereed & Peer Reviewed Journal)



**DOI: 10.5958/2249-7137.2021.01141.1**

**THE MAIN DIRECTIONS OF PREVENTION OF ADHESIONS IN  
 ABDOMINAL AND THORACIC SURGERY**

**Eshonxodjaev Otabek Djuraevich\*;  
 Dusiyarov Muxammad Mukumboevich\*\*;  
 Sherbekov Ulugbek Axrorovich\*\*\*;  
 Xujabaev Safarboy Tuxtaevich\*\*\*\*;  
 Sherkulov Kodir Usmonkulovich\*\*\*\*\***

\*DSc, State Institution,

"Republican Specialized Scientific-Practical Medical Center of Surgery named after,  
 academician, V. Vakhidov", Samarkand State Medical Institute,  
 UZBEKISTAN

\*\*Assistant, State Institution,

"Republican Specialized Scientific-Practical Medical Center of Surgery named after,  
 academician, V.Vakhidov", Samarkand State Medical Institute,  
 UZBEKISTAN

\*\*\*PhD, State institution,

"Republican Specialized Scientific-Practical Medical Center of Surgery named after,  
 academician V. Vakhidov" Samarkand State Medical Institute,  
 UZBEKISTAN

\*\*\*\*PhD, State institution,

"Republican Specialized Scientific-Practical Medical Center of surgery named after  
 academician, V.Vakhidov" Samarkand State Medical Institute,  
 UZBEKISTAN

\*\*\*\*\*Assistant, State institution,

"Republican Specialized Scientific-Practical Medical Center of surgery named after,  
 academician V.Vakhidov" Samarkand State Medical Institute,  
 UZBEKISTAN

**ABSTRACT**

*The article presents a review of the literature on the main areas of prevention of the most common complication of abdominal and thoracic surgery - the adhesions. It is noted that adhesion processes have different clinical significance in the chest and abdominal cavities. At the same time, the experience of studying the causes of adhesion in the abdominal cavity can*

*serve as a foundation for further research on pleural adhesions. The key factor determining the pathogenesis of adhesion formation and its prevention is fibrinolysis. There have been several studies on this issue. Their results are promising, but most of them are contradictory and have been carried out in experimental models.*

**KEYWORDS:** *Abdominal And Thoracic Surgery, Postoperative Adhesion, Anti-Adhesion Coatings.*

## INTRODUCTION

Postoperative adhesions are a pathological condition that occurs in more than 90% of patients who underwent abdominal surgery and in 45-70% after thoracic surgery, and remains one of the most difficult problems in general surgical practice [5, 26]. Indirectly, the frequency of lesions of the pleural sheets by the adhesive process can be judged by the detection of pleural adhesions at autopsy, which, according to different authors, range from 48 to 80.5%. In a significant proportion of cases, pleural adhesions found at autopsy are an accidental finding and are asymptomatic [7].

Consideration of the influence of the adhesion process on the further course of the disease, and, therefore, the issue of management tactics (prevention and dissection of adhesions or stimulation of their formation) is reduced to solving the following main tactical points: the pathological process that led to adhesion formation; topography of adhesions; massive adhesions and the associated respiratory dysfunction.

According to most authors, the adhesive process in the pleural cavity is fundamentally different from that in the abdominal cavity and is of a compensatory and adaptive nature [2, 8]. In this connection, the attitude to adhesion formation in the pleural cavity cannot be considered unequivocally as a negative phenomenon, since in some cases (chest trauma, residual pleural cavity, spontaneous pneumothorax, etc.), adhesion stimulation may be a necessary component of treatment.

The available literature data indicate a high level of incidence of postoperative adhesive disease, while the mechanisms of adhesion formation are not fully understood [13]. The frequency of relaparotomy, according to various literature data, is estimated at 63% -97%. Repeated surgical interventions are more time-consuming and technically difficult, which, in turn, creates a potential risk of damage to vital structures. Approximately 1/3 of patients who undergo abdominal surgery are re-admitted within 10 years after surgery to address a problem directly caused by adhesions or complicated by adhesions, leading to serious clinical problems such as chronic pain, infertility and intestinal obstruction. More than 20% of all readmissions are noted within the first year after primary surgery [9].

Until now, a number of methods and anti-adhesive coatings have been developed, which have been successfully used in experimental studies. Their role is to activate fibrinolysis, hinder coagulation, reduce the inflammatory response, inhibit collagen synthesis, or create a barrier between adjacent wound surfaces. These prevention strategies can be divided into four categories: general principles, surgical techniques, mechanical barriers and chemicals [1, 23, 26].

As you know, some basic surgical principles must be followed in all abdominal surgeries. These principles are close to the Halsted Principles (W.S. Halsted 1852-1922), the first surgeon to

recognize the importance of these measures. Injury to the peritoneum should be avoided through careful tissue handling, careful hemostasis, continuous irrigation and avoidance of unnecessary drying out, ineffective use of foreign bodies, and suturing or clamping of tissue. The use of thin and biocompatible sutures, atraumatic instruments and starch-free gloves is also recommended. Starchy gloves are a significant risk factor for postoperative adhesions. Several experimental studies have shown that the use of gloves with powdered starch during laparotomy is associated with an increased risk of extensive postoperative peritoneal adhesions [23, 26]. However, recent evidence suggests that, in the absence of additional peritoneal trauma, foreign bodies are an infrequent cause of adhesion induction [16].

Certain intraoperative techniques should be employed, such as avoiding unnecessary pleural dissection or avoiding peritoneal closure. Many experimental studies have shown that non-closure of the peritoneum is associated with a decrease in the formation of peritoneal adhesion [18].

W.J. Brokelman et al. (2006) showed in a prospective study that there is no difference in the concentration of tPA antigen, tPA activity, uPA antigen or PAI-1 in abdominal biopsies taken at the beginning compared to the end of the laparoscopic procedure, regardless of whether high intra-abdominal pressure is created or light activity. In contrast, some studies have not reported a difference between both surgical approaches [10].

The role of CO<sub>2</sub>-pneumoperitoneum in adhesion formation after laparoscopic surgery has been reported [4]. It is known that, during laparoscopic surgery, CO<sub>2</sub>-pneumoperitoneum itself has a real effect on the peritoneum. It has been demonstrated that adhesion formation increases with the duration of the CO<sub>2</sub>-pneumoperitoneum and the insufflation pressure. Indeed, long-term laparoscopic surgery requires long-term and large volumetric gas insufflation, raising concerns about the adverse consequences of long-term gas insufflation. The standard CO<sub>2</sub> used in modern laparoscopic practice is cold dry CO<sub>2</sub>, which is not physiologic to normal abdominal conditions.

C.R. Molinas et al. (2001) demonstrated that CO<sub>2</sub>-pneumoperitoneum increases postoperative peritoneal adhesions depending on time and pressure, and that this increase decreases with the addition of 2-4% oxygen, which indicates peritoneal hypoxia as a driving mechanism. It is assumed that with a decrease in fibrinolytic activity, the process of adhesion formation no longer depends on the surgical approach, but develops on its own [27].

A multicenter, randomized, blind, controlled trial (2017) analyzed the short-term results of using an auto-linked polysaccharide (ACL) gel - a gel with hyaluronic acid. The use of ACL-hyaluronic acid gel showed a significant reduction in the frequency of intra-abdominal adhesions (13% versus 30.6% in the control group).

In a study by E. Aysan et al. (2020) prevention of postoperative adhesions was carried out using glycerol [6]. Previously, S. Mortier et al. (2005) reported that glycerol increases the efficiency of peritoneal dialysis and provides a protective effect on the peritoneal surface [28].

Glycerin is a viscous liquid alcohol with a molecular weight of 92.09 daltons [6]. It is soluble in water and alcohols, but not in liquid hydrocarbons. Glycerin is one of the most abundant molecules in living organisms and is also a central component of lipids. Adipose tissue is composed of one glycerol molecule combined with three fatty acid molecules.

In their early publications, E. Aysan et al. noted that 1% glycerol solution used in the process of mechanical separation of the healing surfaces of the peritoneum from the surrounding tissues is effective for the prevention of adhesions [6].

Aysan E, et al. (2020) increased the viscosity (3%) of glycerin in order to extend the absorption time and reveal a longer mechanical separation effect [6]. The authors studied the effect of a new composition of a solution of 3% glycerin and 3% sodium pentaborate on the prevention of adhesions, creating a synergistic effect; as a result, the frequency of postoperative adhesions was statistically reduced. According to the macromolecular structure, when injected into tissues or spaces in the body, absorption of glycerol through capillaries is difficult. Thus, glycerol remains in the injection site for a long period of time [29]. Consistent with the anti-inflammatory activity of sodium pentaborate in accelerating wound healing, there was less inflammation and fewer adhesive molecules were obtained with faster wound healing. Meanwhile, 3% glycerin provides effective mechanical separation around the wound healing environment. This synergistic activity revealed less PPA formation.

The positive effect of various boron compounds on the wound healing process has been demonstrated earlier [20]. In in-vitro and in-vivo studies, sodium pentaborate has been shown to have anti-inflammatory effects through cell proliferation and migration, and growth factor expression pathways, accelerate healing in various wound models [12].

Liquids such as crystalloids, dextran, hyaluronic acid, and icodextrin have been used to prevent adhesion. They separate damaged surfaces using "hydroflating", but their effectiveness is controversial. Crystalloids such as saline and Ringer's lactate are used in large quantities, but are rapidly absorbed. The most commonly used hypertonic solution was 32% dextran-70, but it was abandoned due to serious complications [Watson 2000]. Other liquid barriers that have the advantage of a longer residence time in the abdominal cavity such as hyaluronic acid (Sepracoat®, Genzyme Corporation, Cambridge, MA, USA), cross-linked hyaluronic acid (Intergel® Hyalobarrier gel; Baxter, Pisa), Italy) and Icodextrin (Adept®, Baxter Healthcare Corporation, Deerfield, Illinois, USA) has shown promising results in experimental and clinical studies. Brown et al. (2007) demonstrated that Adept is a safe and effective means of reducing adhesion in laparoscopy [11].

There are non-absorbable and bio-absorbent films, gels, or hard anti-adhesion membranes. The most commonly used mechanical barriers are oxidized regenerated cellulose (Interceed®; Johnson & Johnson Medical, Arlington, TX, USA), expanded polytetrafluoroethylene (Preclude Peritoneal Membrane®; WL Gore and Associates Inc., Flagstaff, Arizona, USA), hyaluronic acid- carboxymethyl cellulose (Seprafilm®; Genzyme Biosurgery, Cambridge, MA, United States) and polyethylene glycol (SprayGel®; Confluent Surgical Inc., Waltham, MA, United States).

The most widely studied bioabsorbable films are Seprafilm and Interceed. Seprafilm is absorbed within 7 days and excreted from the body within 28 days. Prospective randomized controlled trials have shown that Seprafilm is effective in reducing the incidence and severity of postoperative adhesions. However, Seprafilm can cause significant disruption of anastomoses and should not be used in cases of anastomosis [15, 24]. Other experimental studies have shown that covering lesions of the parietal peritoneum with microsurgical autologous peritoneal grafts can completely prevent the formation of severe peritoneal adhesion. However, the advantage of

the synthetic barrier is that the material does not need to be obtained surgically and can be cut to dimensions outside the abdominal cavity and then applied without sutures [34].

Chemical agents such as non-steroidal anti-inflammatory drugs (NSAIDs), corticosteroids, calcium channel blockers, histamine antagonists, antibiotics, fibrinolytic agents, anticoagulants, antioxidants, hormones, vitamins, colchicines, and selective immunosuppressants, prevent persistent fibroblastin formation [3] ...

NSAIDs reduce peritoneal adhesion in some animal models by inhibiting the synthesis of prostaglandin and thromboxane. They reduce vascular permeability, plasmin inhibitors, platelet aggregation and coagulation, and improve macrophage function.

In known studies, postoperative administration of anti-inflammatory drugs at the site of injury reduced the formation of postoperative adhesions in two animal models. An experimental rat model was used to investigate the efficacy of nimesulide, a selective cyclooxygenase-2 inhibitor, in preventing adhesion formation. Preoperative intramuscular or postoperative intraperitoneal injection of nimesulide into the injury site reduced the formation of postoperative adhesion [29, 33]. Typically, some anti-inflammatory drugs may be effective in preventing adhesions, but there is no clinically relevant evidence from any published study to recommend their use in humans for this purpose, and some side effects remain to be seen.

Corticosteroid therapy reduces vascular permeability and release of cytokines and chemotactic factors, and decreases peritoneal adhesion formation in some animal models. However, corticosteroids have side effects such as immunosuppression and delayed wound healing.

Kirdak et al. (2008) investigated the effectiveness of different doses of methylprednisolone in the prevention of experimentally induced peritoneal adhesions in rats. They found that there was no difference in the effectiveness of different doses of topically administered methylprednisolone in preventing peritoneal adhesion formation, and, furthermore, steroids did not prevent the development of peritoneal adhesion [22].

The positive effect of progesterone is known in a slight decrease in adhesion, formed after a small injury to the peritoneum. In addition, it was shown that neither estrogen nor gonadotropin-releasing hormone prevented adhesion formation [30].

The use of anticoagulants to prevent abdominal adhesions has been enthusiastically described in the scientific literature. Several studies are known using heparin or dicumarol, which prevent adhesion by increasing fibrinolysis and serinesterase activity [31, 33, 35]. However, their effectiveness in reducing adhesion formation, whether administered alone or in combination with an additional agent, has not been demonstrated in clinical trials.

M. Kement et al. (2011) evaluated low molecular weight heparin at a dose of 66 IU / kg every 12 hours for five days in an experiment undergoing laparotomy of horses, and there was no positive effect on postoperative complications or survival [21]. No favorable results have been obtained in humans. The recommended dose of heparin remains controversial. One recommendation is 20-150 IU / kg every 6-12 hours for two to five days. Although no intraperitoneal studies have been performed, 30,000 IU of heparin diluted in saline is commonly used and is informally called effective.

Fibrinolytic agents, such as recombinant tPA, when applied topically, reduce adhesion in animal models. However, these fibrinolytic agents can cause hemorrhagic complications [36]. Three different drugs, tPA (Actilyse®; Boehringer Ingelheim International GmbH, Ingelheim am Rhein, Germany), fondaparinux (Arixtra®; GlaxoSmithKline, France) and activated drotrecogin alpha (Xigris®; Ellie Lilly & Co., DSM Pharmaceuticals, Inc. Greenville, North Carolina, USA), which affect the coagulation process at different stages, were studied for their effectiveness in preventing the formation of intraperitoneal adhesion in rats. All three agents were effective in preventing adhesions when compared with the control group. However, activated Drotrecogin-alpha appeared to be most effective except where clinical applicability was considered, in which case fondaparinux appeared to have the greatest benefit. However, further studies have shown that all of these approaches can have only limited success, prevent the lack of safety, efficacy and many adverse effects without eliminating the problem of postoperative formation of peritoneal adhesion [30].

Vitamin E is the most studied vitamin in adhesion prevention. In vitro studies have shown that vitamin E has antioxidant, anti-inflammatory, anticoagulant and anti-fibroblastic effects and reduces collagen production. It has been found to be effective in reducing the formation of adhesion by some authors [36]. Research has shown that intraperitoneal vitamin E is as effective as the carboxymethylcellulose membrane in preventing postoperative adhesions. In contrast, the same effect was not achieved after intramuscular administration. A significant difference was found between intraperitoneal and intramuscular administration of vitamin E [36].

Today, prophylactic agents that have a certain value are viscous solutions of high molecular weight polymers, such as solutions of 1% carboxymethyl cellulose (CMC), hyaluronate and CMC bioabsorbable membranes, heparin and peritoneal lavage [19].

Viscous CMC solutions have lubricating properties, reduce trauma during processing and serve as barriers to serous surfaces. CMC demonstrates variable efficiency in rats and rabbits [19]. Despite low efficacy, intraperitoneal use of 1% CMC does not appear to affect anastomosis or surgical incision healing and doubles survival [29]. The use of a CMC solution is recommended at the beginning of the operation and whenever it is necessary to lubricate the serous surfaces, reducing tissue damage from surgical trauma [29]. Oxidative stress plays an important role in the mechanism of adhesion formation, mainly due to suppression of the fibrinolytic activity of mesothelial cells. Antioxidants used intraperitoneally reduce oxidative stress and increase fibrinolytic activity. N-acetyl-cysteine (NAC) is an antioxidant that acts on the synthesis of intracellular glutathione and is believed to inhibit adhesion through active cellular mechanisms of inflammation and angiogenesis. Seeking an evaluation of clinical use, S. MacKinnon et al. [25] used fucoidan in 33 colic underwent laparotomy. Fucoidan (PERIDAN concentrate) (50 ml) was mixed in 5 L of Ringer's lactate solution (LRS) or plasmolyte solution and 500 ml LRS or 1 L of plasmolyte. The solution was mixed and administered until the abdominal cavity was closed. In recent studies, a new hydrogel, poly- $\epsilon$ -caprolactone-poly-ethylene glycol (PCEC), has demonstrated the potential to prevent postoperative adhesions in rats [17]. PCEC is thermosensitive and at body temperature the solution containing the micelles turns into a hydrogel. PCEC is biodegradable and has low toxicity in vitro and in vivo [17]. Much more interest has been directed to the use of drugs such as angiotensin II receptor blockers (ARA-II) and HMG-CoA reductase inhibitors (statins) [14]. ARA-II decreases the levels of TGF- $\beta$ , and atorvastatin increases the profibrinolytic environment in the peritoneum, which leads to

inhibition of adhesions. P. Dinarvand et al. (2013) compared the use of losartan (1.5 and 10 mg / kg), atorvastatin (1.20 and 30 mg / kg), losartan (10 mg / kg) and atorvastatin (20 mg / kg) and sodium hyaluronate / carboxymethylcellulose ( HA / CMC) intraperitoneally to 90 male mice. After 7 days, the degree of adhesions was assessed, and the simultaneous intraperitoneal administration of losartan and atorvastatin resulted in a much greater reduction in adhesions compared to that in the HA / CMC group [14].

The results of a study by Z. Song et al. (2019) on the use of Xanthan gum XG polymer anti-adhesion coating with different concentrations (from 0.5% to 2%) and molecular weight (Mw)  $2.5 \times 10^6$  Da -  $6.9 \times 10^6$  Da showed that XG has an anti-adhesive effect in the abdominal rat cavities. The 1% high Mw XG gel ( $6.9 \times 10^6$  Da) was more effective in preventing adhesions compared to the commercially available gel (1.2% sodium hyaluronate). Histological and cytotoxic evaluation demonstrated that the XG gel showed no side effects during wound healing and had no in vitro cytotoxicity for L929 cells [30].

L.X. Lin et al. (2017) synthesized a gelatin hydrogel - cross-linking carbodiimide-modified chitosan hydrogel (cd-CS-gelatin). The results of an experimental study showed that the hydrogel solidified within 3 minutes after mixing the reagents. Caecum-abdominal adhesion was observed in all rats without anti-adhesion treatment. The use of cd-CS-gelatin significantly reduced the adhesion level from 100% to 50%, compared to liquid chitosan (only up to 88%). The decrease in adhesion tensile strength also showed that cd-CS gelatin was more effective than chitosan fluid in reducing postoperative intra-abdominal adhesion formation [23].

Summarizing the conducted literature review, the following conclusions can be drawn: Postoperative adhesion formation is the most common complication of abdominal and thoracic surgery. The adhesion process as a complication of the effect on the mesothelium is most fully studied, both clinically and experimentally, in relation to the abdominal cavity. Relatively recently, adhesive complications have become the subject of study of the consequences of injuries and surgical interventions on the organs of the chest. It should be taken into account that although the processes of adhesion have different clinical significance in the chest and abdominal cavities, the experience of studying the causes of adhesion in the abdominal cavity can serve as the foundation for further research on pleural adhesions. Fibrinolysis is a key factor in the pathogenesis of adhesion formation and its prevention. There have been several studies on this issue.

Their results are promising, but most of them are contradictory and have been carried out in experimental models. Despite the long-term existence of the problem, issues related to the prevention of adhesions and the treatment of adhesive disease are among the still unsolved problems of thoracoabdominal surgery. In the current state of scientific knowledge, preclinical or clinical studies are still needed to evaluate the effectiveness of several proposed strategies for the prevention of postoperative adhesions. The literature actively discusses the development of a universal scheme for the classification of adhesions, as well as a predictive assessment system for identifying patients with a high risk of postoperative adhesions, which is necessary to determine the indications for the use of anti-adhesive coatings. In the future, anti-adhesion agents and anti-adhesion measures will become increasingly important. Thus, a review of published studies devoted to the problem of abdominal and pleural adhesions shows the need for further experimental and clinical studies to find and develop new preventive measures, anti-adhesion coatings and a comparative analysis of their effectiveness.



**LITERATURE:**

1. Boyko V.V., Taraban I.A., Groma V.G. Modern aspects of prevention and treatment of patients with peritoneal adhesive disease and its complications. Kharkiv surgical school. 2013 (2): 122-128.
2. Kalashnikov A.V., Dvoretzkaya Yu.A. Comparative morphological analysis of intraperitoneal and interpleural adhesions. Journal of Anatomy and Histopathology. 2016; 51: 26-31.
3. Manukhin IB, Kolesov AA, Bekmurzieva LK, Petrovich E. Clinical evaluation of the use of enzyme-linked immunosorbent therapy in the complex prevention of adhesions after surgical interventions on the ovaries and fallopian tubes. Cathedra. 2013; 72: 70-73.
4. Mikhin I.V., Beburishvili A.G., Akinchits A.N., Kremer P.B. Staged laparoscopic adhesiolysis using anti-adhesion barrier agents. Endoscopic Surgery. 2010; 1: 20-24.
5. Ahmed M, Saka H, Ali Mohammadien H, et al. Safety and complications of Medical Thoracoscopy. Adv Med2016;2016:3794-91.
6. Aysan E, Sahin F, Catal R, Javadov M, Cumbul A. Effects of Glycerol and Sodium Pentaborate Formulation on Prevention of Postoperative Peritoneal Adhesion Formation. Obstet Gynecol Int. 2020;2020:3679585.
7. Banka R, Terrington D, Mishra EK. Management of Septated Malignant Pleural Effusions. Curr Pulmonol Rep. 2018;7(1):1-5. doi:10.1007/s13665-018-0194-3
8. Baxter J, Lima TA, Huneke R, et al. The efficacy of hydrogel foams in talc Pleurodesis. J Cardiothorac Surg. 2020;15(1):58. Published 2020 Apr 15. doi:10.1186/s13019-020-01098-y
9. Bhatnagar R, Corcoran JP, Maldonado F, et al. Advanced medical interventions in pleural disease. Eur Respir Rev2016;25:199-213.
10. Brokelman WJ, Holmdahl L, Bergström M, Falk P, Klinkenbijnl JH, Reijnen MM. Peritoneal fibrinolytic response to various aspects of laparoscopic surgery: a randomized trial. J Surg Res 2006; 136: 309-313
11. Brown CB, Luciano AA, Martin D, Peers E, Scrimgeour A, diZerega GS. Adept (icodextrin 4% solution) reduces adhesions after laparoscopic surgery for adhesiolysis: a double-blind, randomized, controlled study. Fertil Steril 2007; 88: 1413-1426
12. Claunch K. and P. Mueller, "Treating intra-abdominal adhesions: the surgeon's dilemma," Equine Veterinary Education, vol. 24, no. 11, pp. 552–555, 2012.
13. De Wilde RL, Brolmann H, Koninckx PR, Lundorff P, Lower AM, Wattiez A, et al. Prevention of adhesions in gynaecological surgery: the 2012 European field guideline. Gynecol Surg 2012;9:365-8.
14. Dinarvand P., S. Farhadian, E. Seyedjafari et al., "Novel approach to reduce postsurgical adhesions to a minimum: administration of losartan plus atorvastatin intraperitoneally," Journal of Surgical Research, vol. 181, no. 1, pp. 91–98, 2013.
15. Ersoy E, Ozturk V, Yazgan A, Ozdogan M, Gundogdu H. Comparison of the two types of bioresorbable barriers to prevent intra-abdominal adhesions in rats. J Gastrointest Surg 2009; 13: 282-286

- 16.** Fiorelli A, Odierna I, Scarano D, et al. Combined intrapleural and intrabronchial injection of fibrin glue for closing alveolar pleural fistula: a case report. *J Cardiothorac Surg.* 2019;14(1):171. Published 2019 Sep 18. doi:10.1186/s13019-019-0987-7
- 17.** Gao X. and X. Deng, “Novel thermosensitive hydrogel for preventing formation of abdominal adhesions,” *International Journal of Nanomedicine*, vol. 8, pp. 2453–2463, 2013.
- 18.** Kanai E, Matsutani N, Aso T, Yamamoto Y, Sakai T. Long-term effects of pleural defect repair using sheet materials in a canine model. *Gen Thorac Cardiovasc Surg.* 2020;68(6):615-622. doi:10.1007/s11748-019-01270-9
- 19.** Kawai N, Suzuki S, Ouji Y, et al. Effect of covering with cross-linked gelatin glue on tissue regeneration in a rat lung injury model. *Interact Cardiovasc Thorac Surg.* 2019;29(1):1-7. doi:10.1093/icvts/ivy297
- 20.** Kelmer G., “Update on Recent Advances in Equine Abdominal Surgery,” *Veterinary Clinics of North America*, vol. 25, no. 2, pp. 271–282, 2009.
- 21.** Kement M., Censur Z., Oncel M., Buyukokuroglu M. E., and Gezen F. C. Heparin for adhesion prevention: comparison of three different dosages with Seprafilm in a murine model. *International Journal of Surgery*, vol. 9, no. 3, pp. 225–228, 2011.
- 22.** Kirdak T, Uysal E, Korun N. [Assessment of effectiveness of different doses of methylprednisolone on intraabdominal adhesion prevention]. *Ulus Travma Acil Cerrahi Derg* 2008; 14: 188-191
- 23.** Lin LX, Luo JW, Yuan F, et al. In situ cross-linking carbodiimide-modified chitosan hydrogel for postoperative adhesion prevention in a rat model. *Mater Sci Eng C Mater Biol Appl.* 2017;81:380-385. doi:10.1016/j.msec.2017.07.024
- 24.** Lim R, Morrill JM, Lynch RC, Reed KL, Gower AC, Leeman SE, Stucchi AF, Becker JM. Practical limitations of bioresorbable membranes in the prevention of intra-abdominal adhesions. *J Gastrointest Surg* 2009; 13: 35-41; discussion 41-42
- 25.** Mackinnon S., L. L. Southwood, S. Mattson et al., “Multicenter prospective study on the use of intraperitoneal PERIDAN concentrate adhesion reduction device in horses: 33 cases (2008-2011),” *American Association of Equine Practitioners*, 2013.
- 26.** Moris D, Chakedis J, Rahnemai-Azar AA, et al. Postoperative Abdominal Adhesions: Clinical Significance and Advances in Prevention and Management. *J Gastrointest Surg.* 2017;21(10):1713-1722.
- 27.** Molinas CR, Mynbaev O, Pauwels A, Novak P, Koninckx PR. Peritoneal mesothelial hypoxia during pneumoperitoneum is a cofactor in adhesion formation in a laparoscopic mouse model. *Fertil Steril* 2001; 76: 560-567
- 28.** Mortier S., Faict D., Gericke M.L.N., and A. De Vriese, Effects of new peritoneal dialysis solutions on leukocyte recruitment in the rat peritoneal membrane. *Nephron Experimental Nephrology*, vol. 101, no. 4. 139–145, 2005.
- 29.** Ozerhan IH, Urkan M, Meral UM, Unlu A, Ersoz N, Demirag F. et al. Comparison of the effects of Mitomycin-C and sodium hyaluronate/carboxymethylcellulose [NH/CMC] (Seprafilm) on abdominal adhesions. *Springerplus.* 2016;5:846.

- 30.** Song Z, Zhang Y, Shao H, et al. Effect of xanthan gum on the prevention of intra-abdominal adhesion in rats. *Int J Biol Macromol.* 2019;126:531-538.
- 31.** Sumi Y, Yamashita K, Kanemitsu K, Yamamoto M, Kanaji S, Imanishi T. et al. Simple and Easy Technique for the Placement of Seprafilm During Laparoscopic Surgery. *Indian J Surg.* 2015;77:1462–5.
- 32.** Tsuruta A, Itoh T, Hirai T, Nakamura M. Multi-layered intra-abdominal adhesion prophylaxis following laparoscopic colorectal surgery. *Surg Endosc.* 2015;29:1400–5.
- 33.** Tamura M, Matsumoto I, Saito D, et al. Dynamic chest radiography: Novel and less-invasive imaging approach for preoperative assessments of pleural invasion and adhesion. *Radiol Case Rep.* 2020;15(6):702-704.
- 34.** Ten Broek RPG, Stommel MWJ, Strik C, van Laarhoven CJHM, Keus F, van Goor H. Benefits and harms of adhesion barriers for abdominal surgery: a systematic review and meta-analysis. *Lancet.* 2014;383(9911):48-59.
- 35.** Uemura A, Nakata M, Goya S, Fukayama T, Tanaka R. Effective new membrane for preventing postthoracotomy pleural adhesion by surface water induction technology. *PLoS One.* 2017;12:e0179815.
- 37.** Yasukawa M, Taiji R, Marugami N, et al. Preoperative Detection of Pleural Adhesions Using Ultrasonography for Ipsilateral Secondary Thoracic Surgery Patients. *Anticancer Res.* 2019;39(8):4249-4252.

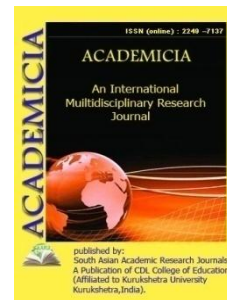
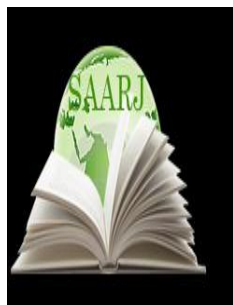

DOI: **10.5958/2249-7137.2021.01140.X**

## THE IMAGE OF A BIRD IN THE WORKS OF ALISHER NAVOI

**Mohira Islomova\***

\*Teacher,

Department of interfaculty Foreign Languages of Fergana State University,  
Fergana, UZBEKISTAN

### ABSTRACT

*This article deals with the ideas put forward in the world and Uzbek literature through the image of a bird, the artistic interpretation of lyrical experiences. In particular, social events expressed through the image of a bird are interpreted and studied in the works of Alisher Navoi. The image of the bird Simurg, popular among people in the form of a state bird, a bird of happiness, a nightingale, first appeared in Eastern literature in Firdavsi's "Shohnoma". Although his name is not mentioned in Abu Ali ibn Sina's Book of Birds, Simurg refers to the king of birds.*

**KEYWORDS:** *Reality, Belief, Imagination, Epic Image, Lyrical Expression, Idea, Literary, Tradition, Features*

### INTRODUCTION

Imagining, describing reality through the images of birds, searching for solutions to problems is one of the ancient features of human beings. Birds were formed on the basis of primitive concepts in the history of world thinking, primarily based on the religious-philosophical, mythological-mythological concepts. There is a fact that Prophet Solomon knew the language of birds and was able to subdue them to his rule is a clear proof the existing in the religious books.

These include the Phoenix in the west, the legendary bird **Qaqnus** in the East, the **Jarptitsa** in the Slavs, **Turan**, and **Humo** in Iran, and **the Semurg** (sometimes called Anqa) deified by our ancestors. In Uzbek folk tales such as "Kenja botir", "Guliqahqah", "Qora holli ot" there are scenes about birds that save and protect the hero. The image of the bird Simurg, popular among people in the form of a state bird, a bird of happiness, a nightingale, first appeared in Eastern literature in Firdavsi's "Shohnoma". Although his name is not mentioned in Abu Ali ibn Sina's Book of Birds, Simurg refers to the king of birds. In the ancient East, the legendary bird that sponsors the protagonist in legends, fairy tales and epics, Anqa is embodied in the work of Imam al-Ghazali in his work "Risalat-ut tayr" as a mystical symbol of Allah.

## MATERIALS AND METHODS

The works of the famous American naturalist Seton Thompson, the English writer Jack London, the masterpiece of the ancient Indian epic "Kalila and Dimna" (original name "Panchatantra"), the epic "Lison-ut tayr" by Alisher Navoi, "Zarbulmasal" by Muhammad Sharif Gulkhani, the details of the image of birds in world and Uzbek folk tales have been the subject of various studies, and research is still ongoing.

Regardless of the different styles, worldviews, attitudes, positions, views of different peoples of the world in the creation of the image of birds, at the heart of the reality they write, figurative images are the human person and his character, spirituality, spiritual world. In particular, the great Uzbek poet and thinker Alisher Navoi, although using a unique method of choosing the plot and composition, draws spiritual-enlightenment, moral-philosophical conclusions from the fate of the hero, who represents a certain environment in the formation of personality and character, analysis of events and the problems tried to find solutions.

Alisher Navoi is shown not only in his literary works, but also in his scientific works as a scholar of the world of birds. In particular, in the work "Muhokamat-ul lug'atayn" ("Discussion of two languages"), comparing the possibilities of the Turkic (Uzbek) language with the Persian-Tajik language, proves the lexical richness of his native language in the example of birds. *"Va qushlarki, anda muqarrar va mashhur ilbosun (yovvoyi) o'rdakdur. Va sort (fors) el ilbosunni xud bilmas. Tag'i turk o'rdakning erkagin "so'na" va tishisin (urg'ochisini) "bo'rchin" der. Va sort munga ham ot qo'ymaydur. Va nar va moda ikkalasini ham "murg'obi" (suv qushi) der. Va o'rdakning anvoi bilur Qushchilar qoshida, masalan, jo'rka va erka, suqtur va olmabosh, chokirqanot va temirqanot, aldaldag'a va alapaka, bog'chol va bu yo'sunluq derlarkim, etmish xil bo'lurkim, sort borisin murg'obi deb qo'ya qoladi.*[1.115]

Alisher Navoi in his work "Lison-ut tayr" artistically described the problem of nature and divinity with a human-being. The author expresses his views figuratively through the language, deeds and adventures of more than thirty birds, such as Hudhud (popishak), Parrot and Peacock. The scientists V. Zohidov and Sh. Sharipov have done significant research in their time and presented their findings. In any case, the epic "Lison-ut tayr", a collection of symbols and images of birds, has a special place in the author's work as a work that summarizes the advanced philosophical and mystical views put forward throughout the creative career of the great thinker.

## RESULTS AND DISCUSSIONS

In the lyrical heritage of Alisher Navoi, the image and image of birds are widely used. Here are some characteristic examples of them. The deaths of his close friends Abdurahman Jami, Said Hasan Ardasher, Pahlavon Muhammad and others have strengthened the poet's feelings of loneliness and sadness.

*Ey Navoiy, uhti bulbullar xazonda bog'din,*

*Men qanotsiz QUSH masallik aylab afg'on qolmisham.*

*Meaning: O, Navoi feels downhearted like a wingless bird.*

It is known that the main part of the samples of Eastern classical lyric poetry, in particular, consists of poems on the theme of love. Through such poems, the authors tried to express themselves artistically, from personal experiences to major historical and social events. While

addressing topics such as complaints about emigration, grievances, aggression and threats from rivals, the author has often focused on figurative imagery, impressive logos. Among such images and lyrical images is the image of a bird. For example, in one of Alisher Navoi's famous poems, the image of a bird falling in love is also referred to as a bird:

*Jahdim andoqdur etishgaymen deb vaslig'a bot*

*Kim, qabul etmon og'ir deb chiqsa egnimdin qanot.* [1. 75]

Here, the lyrical protagonist exaggerates that I am so in love with my friend that I will give it up, even if I have wings like birds, so that they do not weigh me down on the road.

Human life is fleeting, say the wise. It is the dream of the wise not to miss an opportunity, to rely on good and noble deeds, to make a good name. Alisher Navoi expressed similar ideas through various figurative expressions. In particular, views on the transience of life are lyrically expressed through the image of birds:

*Dahr bo'stonida qilmoq sayr aylab hoyu huy*

*Harza kezmaktur hayotning qushlarini urkutib.* [1. 55]

If we consider the short-lived world as empty, to miss an opportunity with various pleasures is to frighten the birds of life, to miss precious moments, says the poet.

The image of a bird also helps in the lyrical expression of the lover's heart tied to the yoke:

*Ko'ngul qushidur oning zulfi tobdori bila*

*Chibinki bog'liq erur Ankabut tori bila.* [1. 553]

The children turn on the lights in the dark of night, their eyes blinded by the light, and the wild birds, which have lost consciousness, catch them when they hit the lamp. This real and vital event, in which the image of a bird is involved, is compared to the actions of a spouse to win the heart of a lover:

*Hajr aro ul sho'x ko'nglum sayd etar ruxsor ochib,*

*Tifl oqshom QUSH tutarg'a Ravshan etgandek charog'.* [1.298]

When we learned the four devons of Alisher Navoi's "Khazoin-ul maoniy" turn by turn, according to our calculations, the number of bytes depicting the image of Bulbul in the devon of the poet "Gharoyib-us sig'ar" is forty. In the devon "Navodir-ush Shabab" this image consists of 28. We also came across this image in the 13th place in the devon Badoe'ul Vasat and in the 27th place in the devon Favoyid-ul Kibar.

In Khazayn-ul-Maoniy, we found the image of Bulbul (nightingale) in 122nd place. The great poet sometimes uses the term "Andalib" instead of "Bulbul"(nightingale). The word andalib, according to our observations, was used only in a few places. These are: 1). In the 330th ghazal of the devon Navodir-ush Shabab. 2). It is found in the 26th, 159th and 445th ghazals of the devon Favoyid-ul-Kibar. The remaining 118 bytes were used as Bulbul (nightingale). It is noteworthy that even if the poet refers to this image in more than a hundred places, the content of one byte does not duplicate the other, neither in character nor in meaning.

**CONCLUSION**

Every writer is a son of his time. First of all, he breathes with the environment in which he lives, is influenced by the events of life, writes them down, expresses his worldview, position, and attitude. Birds, on the other hand, are an integral part of the environment that surrounds every writer. Therefore, our approach from this point of view will be useful in analyzing the aesthetic ideals, ideological and philosophical conclusions, artistic skills of the poet.

**REFERENCES:**

1. Alisher Navoi. Khazayn-ul-Maoniy. 20 volumes. Volumes 2-6.
2. Alisher Navoi. Lison-ut tayr. Tashkent. 1989
3. Alisher Navoi. Muhokamat-ul lug'atayn. Works. . Volume 14 Tashkent. 1967.
4. Kalila and Dimna. Translator S. G'anieva. Tashkent. 1966

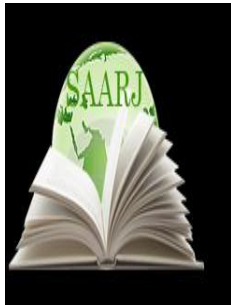

**ACADEMICIA**  
**An International**  
**Multidisciplinary**  
**Research Journal**  
 (Double Blind Refereed & Peer Reviewed Journal)



**DOI: 10.5958/2249-7137.2021.01139.3**

**FOLKLORE AS A CRITERION OF SPIRITUAL AND MORAL  
 DEVELOPMENT IN THE FORMATION OF THE PERSONALITY OF  
 PRESCHOOL CHILDREN**

**Dilfuza Abdurahimova\***

\*(DSc) Professor,  
 Doctor of Pedagogical Sciences,  
 Department of "Humanities" of the Academy of the Armed Forces,  
 Republic of UZBEKISTAN

**ABSTRACT**

*This article deals with upbringing a young generation on the basis of a comprehensive, harmonious, healthy lifestyle as one of the pressing challenges of today, and the use of rich, national, cultural, historical traditions, customs, and universal values and moral and ethical standards in the upbringing of young people.*

**KEYWORDS:** *Adolescence, Healthy Living, National, Cultural, Customs, Universal Values, Spiritual, Moral, Educational, Historical, Spiritual Heritage, Belief.*

**INTRODUCTION**

Every nation across the world has its own national religion and values, and on the basis of these values in different socio-economic systems emerge genres of folklore in a new form and content, expressing the desires, joys and concerns of the people. As long as there is a nation, members of that nation are used to create, reflect their heart, love and life experiences in their oral and written work. The patterns created by the people determine the place of this nation and the people in the spiritual development of society.

In the era of globalization and technology, the spiritual and moral upbringing of the individual, especially preschool children is the main criterion of state policy. To approach the development of a person correctly, it is necessary to know the nature of the person, his structure, his behavior and the means of influencing him.



---

## MATERIALS AND METHODS

One of the features of the process of spiritual and moral education in the system of preschool education is a pedagogical process organized for the purposeful formation of the personality of preschool children in the process of spiritual and moral education, which allows regular and systematic influence on the individual. Indeed, the process of spiritual and moral upbringing involves two interrelated activities, in which the child's spiritual consciousness is formed, emotions are developed, and moral habits necessary for social life and serving social relations are formed. In the process of upbringing, to develop not only the consciousness but also the feelings of the child, in order to develop their moral skills and habits that meet the moral requirements of society, the consciousness of preschool children (during lessons) and will (outside activities) in the process of managing behavior) is systematically and systematically affected. In the process of shaping the spirituality of preschool children, it becomes difficult to achieve the goal if any of these (consciousness, emotions, will) are ignored. Therefore, spiritual and moral education is called a consistent and complex process.

Another feature of the spiritual and moral education of preschool children is the multifaceted process of education, which is organized on the basis of internal and external (subjective and objective) factors that serve to illuminate the essence of the educational process. Subjective factors express the inner needs, interests, life relationships of the individual, and objective factors create the conditions for a person to live, form, positively solve life problems.

The most important goal of modern preschool education is to bring up, socially and pedagogically support the spiritually and morally mature, physically healthy, responsible, creative, enterprising, harmoniously developed citizen of the Republic of Uzbekistan. This is reflected in the "Concept of continuous Spiritual Education" adopted by the president of the Republic of Uzbekistan with the aim of ensuring the implementation of the resolution No. PD-4307 "On additional measures to improve the effectiveness of spiritual and educational work" on May 3, 2019 as well as educating young people to independent life as active citizens.

The fifth chapter of the concept provides for the implementation of continuous spiritual education in the system of preschool education, the development of positive behavioral motives of children from this period on the theme of "Uzbekistan is my homeland!" to form of a sense of respect for the symbols of the state, and moral qualities such as courage, enthusiasm, national pride, determination, entrepreneurship, shame, contentment, diligence, and using fairy tales, myths, legends, epic, proverbs on the theme "child is dear, manners are more dear to him" focused on the formation of spirituality and moral qualities of children, the development and implementation of specific methodological developments for educators of preschools and parents of children has been identified as one of the important tasks of today.

## RESULTS AND DISCUSSIONS

Today, the increasing incidence of preschool education as a part of spiritual and moral education and its components is caused by a number of factors that are observed worldwide:

- the growth of the requirements for the level of spiritual and moral upbringing of specialists in the field of preschool education for successful activity in the social space in a changing, multifunctional, modern environment with a high rate of development;
- professionalism for progress in all spheres of public life and moral foundations of

communicative processes; excessive and diverse cultural and artistic realities, at the same time developing in harmony with continuous flow of information, increasing demand for preschool education, their uniqueness and versatility;

- the ineffectiveness of the process of teaching high samples of spiritual and moral education to children of preschool age through samples of folk oral creativity, inconsistency of reflections, views on the line of striving for perfection as a specialist and a person;
- the need to establish, manage, support the process of spiritual and moral education of the growing younger generation in such conditions is realized through certain factors

The analysis of these factors shows that in moral education of preschool children, it is necessary to use more extensive samples of folklore of the people.

Fiction in the historical genre, which is an integral part of spiritual culture, reflects the past, sorrows, joys of the nation and the way of thinking. While the predominance of the ideas of love and mutual compassion in the works of this genre has a positive significance in the life of the nation, the predominance of inhuman ideas, superficial coverage of the past leads the nation to ignorance and self-delusion. There are priorities in the spiritual and moral education of preschool children and increase its effectiveness, and ensuring, developing and improving their solutions is an important factor in educating a spiritually and physically healthy generation. These priorities can be classified as follows.

- Ensuring continuity in the spiritual and moral education of preschool children;
- to inculcate the essence of universal and national values in the content of preschool education, taking into account the age characteristics of children;
- taking into account the world best practices in the field of preschool education, study and wide implementation of ideas specific to the mentality of our country;
- to achieve the improvement of the content of preschool education plans, curricula and methodological manuals in accordance with the requirements of the period, in accordance with our national values;
- organization of pre-school educational process on the basis of new educational-methodical complexes and innovative educational technologies based on our national values;
- extensive use of the rich spiritual heritage, intellectual potential and universal values of the people in ensuring the effectiveness of the preschool education system;
- creation of a new concept of cooperation between the organization of preschool education and all social institutions of society in the upbringing of a spiritually and morally harmoniously developed generation.

Spiritual and moral upbringing of preschool children, pedagogical study of educational results is an important criterion in the upbringing of a spiritually and physically healthy, perfect person.

## CONCLUSION

In short, to create a special program of pedagogical and psychological study of the spiritual and moral, harmoniously developed generation and its results are based on today's requirements; determine the methodological basis; determination of the content and principles of our national

values, including the examples of folklore; selection of effective methods; analysis, drawing conclusions, clearly defining ways of making recommendations is one of the current problems facing the science of preschool education pedagogy.

**REFERENCES:**

1. Resolution of the President of the Republic of Uzbekistan No PD-4307 “On additional measures to increase the effectiveness of spiritual and educational work” on May 3, 2019
2. Atadjanova Sh. Pedagogical bases of use of national values in patriotic upbringing of teenagers in a family: the candidate of pedagogical sciences dis. Tashkent : TDPU, 2001.p.117
3. Bulatov S. Theory and methods of using examples of folklore in the training of junior specialists. - T .: Economy-Finance, 2014 –p.70
4. Geldieva A.N. National culture and personality.–T.:Uzbekistan, 1993 p.26 - 27

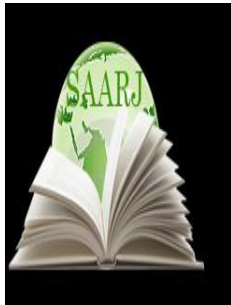

**ACADEMICIA**  
**An International  
 Multidisciplinary  
 Research Journal**  
 (Double Blind Refereed & Peer Reviewed Journal)



**DOI: 10.5958/2249-7137.2021.01138.1**

**THE ROLE OF CHASHMAI AYUB BUKHARA WATER SUPPLY  
 MUSEUM AND SOME ANCIENT WATER STRUCTURES IN THE  
 FORMATION OF HYDRO LOGICAL OUTLOOK OF YOUNG PEOPLE**

**Yozil Qosimovich Hayitov\*; Malika Olimjonovna Rajabova\*\*;  
 Iroda Ahmadali kizi Ramazonova\*\*\***

<sup>1,3</sup>Bukhara State University,  
 UZBEKISTAN

**ABSTRACT**

*The article highlights the current role of the Chashmai Ayub Water Supply Museum and some ancient waterworks in increasing the knowledge of young people about water science and the prospects for their effective use in the future.*

**KEYWORDS:** *Chashmai Ayub, Fountain, Baths, Cistern, Sewer, Ditch, Canal, Groundwater, Depth, Water Volume, Ditch, Mesh, Ditch.*

**INTRODUCTION**

**Relevance:** It is no secret that water resources are limited around the world today. It is no coincidence that 2003 was declared the Year of Freshwater by the United Nations and March 22 is International Water Day.

Due to the development of irrigation and population in Central Asia, including Uzbekistan, there is already a shortage of water resources. The adoption of the law "On water and water use" on May 6, 1993 in our independent land is a clear proof of our opinion.

It is very difficult to imagine life without water. Water is the source of life not only for humanity, but for all beings. Therefore, water should be used in moderation. Everyone, whether a child or an adult, should treat water wisely. Therefore, the study of the Chashmai Ayub Bukhara Water Supply Museum and ancient waterworks plays an important role in developing the worldview of our youth in water science.

**Goals and objectives:** In order to achieve our goal, we have studied some ancient waterworks and the Chashmai Ayub Bukhara Water Supply Museum as objects. The following tasks were performed to achieve the goal:

- to get acquainted with the relevant literature on the subject;
- Collection and analysis of data related to the object of study;
- To acquaint young people with some ancient waterworks and the Museum of
- Water Supply Chashmai Ayub Bukhara;
- To study the history of the Chashmai Ayub Water Supply Museum;
- Classification of some ancient water structures (ditch, ditch, meshkob, sardoba);
- Geographical forecasting of the practical significance of the Chashmai Ayub Bukhara Water Supply Museum in the future.



**Figure 1. The spring is a unique monument of Ayub-Bukhara**

**Brief classification of Chashmai Ayub water supply museum.** The fountain of Job is sometimes called the tomb, in fact it is the place where Job walked. Apparently, the veneration of the prophet Job originated in pre-Islamic times in connection with the worship of water. The construction of the building will take several stages.



**Figure 2. Exterior of Chashmai Ayub Water Supply Museum**

It is believed that its ancient part dates back to the XII century. At the same time, the date 1380 or 1384/5 is engraved on the surviving tombstone (which caused the inscription to be read differently because it was not well preserved) - this is the reign of Amir Temur, and later appeared the roof, dated 16th century. The building has six rooms, inside of which there is a sacred spring, behind which there is a large altar mosque.

Chashmai believes that the construction of the tomb of Job dates back to the XII century. According to legend, one of the prophets in the Bible, Ayub (Iov), hit the ground with his stick while passing through this arid part of Bukhara, and as a result, a pure, healing spring of water appeared here. In the 14th century, Khorezmian masters, brought by Amir Temur in one of his marches, built a building on a spring and a well, and gave a conical shape to the cone-shaped dome on the high traction device in the well, which is typical for Khorezm.

Chashmai Ayub is a spring in Bukhara, or a well. It is said that Ayub was called "the spring of the Prophet Ayub" because he was cured of this water. Chashmai Mayib was phonetically changed to Chashmai Ayub. In the Fergana valley, the spring of Hazrat Ayub was mentioned by the Arab geographers as Muqaddas. This spring in the Kosonsoy valley is still called by the same name.

Geographical analysis of the architecture of Chashmai Ayub. The building of the shrine is rectangular (19x26) and consists of 4 rooms stretching from west to east. Each room is covered with different domes. . Initially, the oldest room was a square (4.5x4.5 m) well.



**Figure 3.** Chashmai Job well.

Legend has it that this room was built by Arslankhan at the same time as the Minaret Kalon and the Mosque of Prayer. On both sides of it there was a mountain room (4.5x4.5 m) with two doors for pilgrims, which served as a roof. On the wall of the shrine with a double dome and a front roof, according to the order of Amir Temur, in 1379 it was written that a large room with a domed dome and a corridor with towers in the corners were built. The old part of the building remained inside.



**Figure 3. Interior of Chashmai Ayub Water Supply Museum.**

On the left hand side of the entrance to the Chashmai Ayub Water Supply Museum there is a map of the pools in Bukhara in the early twentieth century, photos of the ancient main settlements of Bukhara, such as Bolo Hovuz, Labi Hovuz (Figure 5).



**Figure 5. Bukhara in the early twentieth century map of pools in the city.**

Various utensils used in the previous period add to the beauty of the museum. In addition, the map of the baths in Bukhara in the late XIX and early XX centuries is reflected (Fig. 6). Baths are one of the proud places of Bukhara. At the beginning of the XX century in Bukhara there were 20 baths. Most of these baths were built in the XVI-XVII centuries and have not changed their shape. Bukhara baths are a unique place for residents and traders and visitors. The baths were built on the ground, and over the years and centuries, more than half of them have remained underground. The baths were operated in exchange for well water. These structures are similar in construction and differ from each other only in the number of rooms.



**Figure 6. Late XIX - early centuries XX Map of baths in Bukhara.**

Room 1 leads to the dressing room, then through the low and narrow corridor to the next room (basement) to the foot-washing room. It was followed by a domed, central room (miyonsaray), from which it was possible to move to a room with hot water (hot room), a room with cold water (ugly room) and a special room (vabjibixona). In addition, the site provides insights into the Bukhara sardobas, their importance, maps of the depletion of the Aral Sea, and the causes. The word sardoba is derived from the Forstil words sard - cold and ob - water. Sardoba is a domed monumental structure divided into two parts: the underground part is designed for water collection and storage, and the above part is built in the form of a round dome. Sardoba is a domed cistern for water buried deep in the ground. Construction began on caravan routes, usually from the X century. The water in such cisterns was cool even in the hottest time of the year. Irrespective of the size of the cisterns, they were up to 15 meters in diameter and 10-15 meters deep. The cisterns are filled with rain and melted snow, and sometimes with streams and canals, which are partially built in the way of underground canals-sewers. Most cisterns had one hatch for water. The Bukhara sardobas were distinguished by two hatches, but several hatches were installed around the Abdullah sardoba.

In Uzbekistan, the main building material for the cistern is high-quality and durable bricks of flat, rectangular shape. For centuries, cisterns have served as a guaranteed source of fresh water and storage in Central Asia. Their appearance is in the form of a dome made of bricks, with holes in the bottom. Through them through the wells or other underground tanks are passed radial ditches, which pay for the water of the barren during the rainy season. Due to the manuscripts of tourists, a detailed description of the cisterns has been preserved. "Half the distance between Malik and Mirza Rabot, on the side of the road, is a tall round domed building. At the top of the dome there is a round hole.

The descending path behind the steep gate leads into this circular building; The seven apex holes are symmetrical around a thick wall. The building is astonishingly strong, especially in the horizontal arrangement of flat square bricks in innumerable circular rows from the bottom of its magnificent dome to its highest point, so that each brick in the top row is inside the dome in



relation to the bricks below. the side is slightly bulging; In general, this dome looks like an overturned round amphitheater stairs. This unique way of building a building, no matter how primitive it may seem, amazes with its durability. Such desert buildings are known as "sardoba".

Under a high, stone dome the size of a few sarjins, a traveler who is tired of walking in the heat of summer, always in the shade and coolness, finds great comfort here, and in the bitter winter serves as a shelter from snowstorms. As you enter the building, you will see that its openings are three feet (1 foot = 2,134 m) from the bottom of the building, which is made of stone "from the outside to the level of the surrounding soil", so the hall itself is dug into the ground. seems to be warm.



**Figure 7. Sardoba.**

This explains the need to have two or three raised forts under each cistern. In the spring, when the snow begins to melt, all the surrounding water flows towards the cistern and passes through its holes. That's why they tried to build such basins on steep slopes.

Koriz - (Persian) underground structure for the collection of groundwater and its discharge to the surface, used for water supply and irrigation. Koriz is widespread in the Middle East, Southeast Asia. Occurs in mountainous and foothill areas of Central Asia. About 200 sewers have been dug near Ashgabat, Turkmenistan, Bukhara, Samarkand and Navai regions of Uzbekistan. Until the 1920s, sewage was used to irrigate crops in Central Asia. Excavation of the trench required a clear definition of changes in groundwater levels and the slope of the terrain. This was done with the help of special tools (astrolabe, waterpass). Once the sewer route was determined, wells were dug every 5-40 meters along this route. The depth of the wells ranged from 14-15 meters, sometimes up to 60-70 meters. The wells are connected to each other by a solder (tunnel) that connects to the aquifer. Lahim is 1.5 meters high and 1 meter wide, its walls are reinforced with wood or stone, and its length is up to several kilometers, depending on the slope.

Canal (waterway). Canal, irrigation canal - a specially dug waterway, the main part of the irrigation system. Depending on the function of the canals, the main (rivers, reservoirs, water flows from irrigated lands to irrigated lands);

- distributor (distributes water from main canals to districts or farms);
- farm (water flowing through the inter-district or inter-farm canal to the irrigated lands of the farm), temporary (ditch), which serves for the distribution of water to the owners. The canal starts from the water intake facilities. Through the intake facilities, the water flows into the canal itself, or is pumped through the pumping station (machine channels). The canal can be excavated or lifted. Usually its cross section is trapezoidal. In some cases, the canal itself is made of concrete or reinforced concrete, nowadays prefabricated reinforced concrete structures are widely used.

**Shohrud canal.** One of the canals supplying water to Bukhara. Shahrud, or rather the Shaharrud canal. Sometimes it is written as Shohrud - "king's arig"; The city of Rudi Bukhara - before the "city of Bukhara" was called Rudi Zar. Originally, Rudi Zar was mentioned in the works of Arab geographers (10th century) as Nahri Zar.

The city of Bukhara is located not far from the left tributary of the Zarafshan River. This river used to supply water to the fields and the city. The Shohrud (Rudizar) canal was dug in ancient times from the river to the city. The Shohrud canal is the main source of water for several canals in the city and more than 80 Bukhara pools. Bridges have been built across the canal everywhere in the city. Currently, most of the canal goes underground. Only a small part flows under the open sky as before. The canal flows from east to west in the southern part of Bukhara.

A ditch on the outskirts of the city of Zakhkash-Bukhara. A ditch with draining water. Zovur, zagor was actually called a flood. In the Middle Ages, moist soil was called zagor. In the following centuries, the term zakhkash began to be used instead of zagkash.

Mesh, mesh - a narrow bag with a sewn-on leather. Mesh has long been known, mainly liquids (water, milk, molasses, koumiss, etc.) Used for transportation and storage, chalop preparation and other purposes. Widespread among the peoples of the East, Central Asia and Siberia. From ancient times, the East, especially in the army of the Turkic-Mongol peoples, was used effectively during military operations, such as crossing deep rivers, making sal. In the past, in Mesh, a person who made a living by transporting water from water sources (pools, ditches, wells, etc.) to houses, guzars, teahouses, caravanserais was called a meshkob or meshkobchi.

Sharkhpalak - 1) a structure that flows much lower than the irrigated land and lifts water from streams; A large wheel with a blade on which the buckets are mounted. The size of the wheel diameter depends on the size of the river or ditch, the amount of water flowing. The number of buckets depends on the diameter of the wheel.

The flowing water affects the impellers and turns the wheel so that the buckets are filled with water. Charkhpalak is one of the oldest water structures. The first wheels appeared in 4-3 thousand years BC.

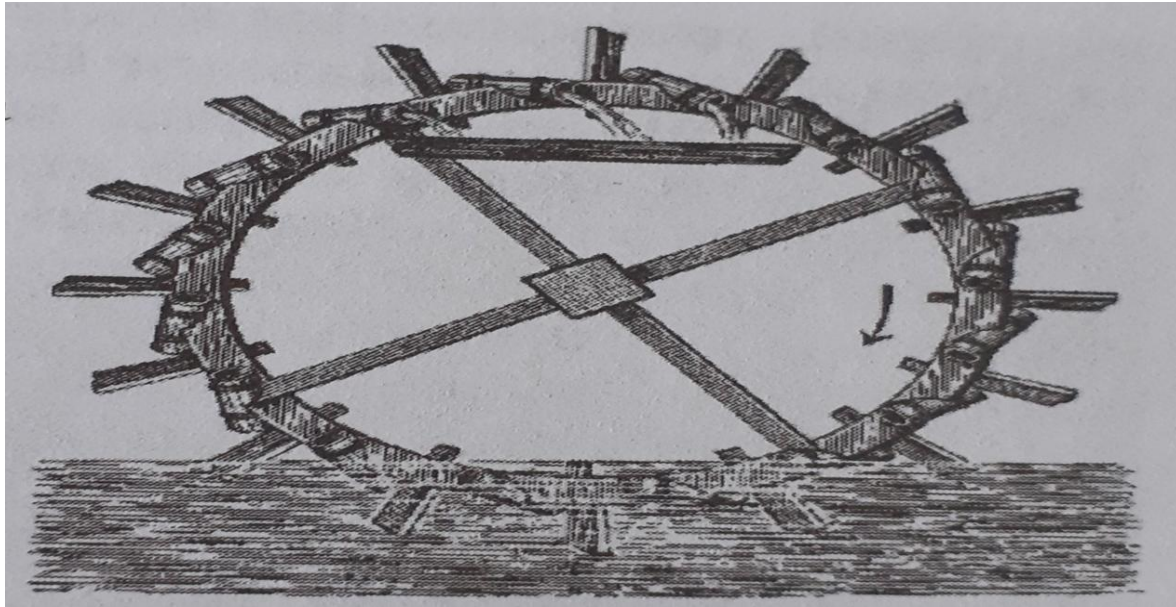

**Figure 8. Charxpalak.**

In ancient times, in the territory of Uzbekistan, the pump was the main means of drainage. With the advent of pumps in the XIX century, the need for wheelbarrows decreased, but in some places it is still used (Figure 8);

2) cultural and recreational facilities to be installed in parks and playgrounds, a large-diameter wheel on which the seats can be hung in a circular motion. Such a wheel is driven by an engine. Careful and rational approach to water, saving every drop of water, eliminating waste, improving water supply to the population of Uzbekistan for the production of consumer and non-consumable products in all sectors of the economy provides the required amount of water. Especially today, ancient waterworks are widely used as water-saving technologies in agriculture and various sectors of the economy.

#### **Suggestions and recommendations:**

- So have more opinions about the sights of Bukhara;
- To have more opinions about the sights of Bukhara;
- Reproduction of various types of trees around the building in the organization of domestic and foreign tourism;
- relocation of the adjacent market area to the interior;
- more trips to this place in the formation of the hydrological outlook of young people;
- to instill in our youth the idea that every drop of water is a source of life;
- to feel that the improvement of water ecology is in the hands of young people.

#### **CONCLUSION**

In conclusion, we hope that the Chashmai Ayub Museum of Water Supply and the ancient waterworks will serve as a program for the development of the hydrological outlook of students.

We must preserve historical buildings, including water structures, as the apple of our eye for future generations.

#### REFERENCES:

1. Y.K. Khayitov, N.A. Toshbekov., Efficient Use Of Collector-Drainage Networks (On The Example Of Bukhara Region). The American Journal of Agriculture and Biomedical Engineering, 3(02), 10-15.
2. Y.K. Khayitov, N.A. Toshbekov., T.A. Zhumaeva., Criteria and scales of the secondary use of collector-drainage waters (on the example of the Bukhara oasis). Bulletin of the Karakalpak branch of the Academy of Sciences of the Republic of Uzbekistan 2019 55-58
3. 3. Suv O`zbekiston kelajagi uchun muhim hayotiy resurs. O`zbekiston nashriyoti, Toshkent- 2007. 59-66-betlar.
4. Y.K. Khayitov, N.A. Toshbekov., T. A. Zhumaeva., Hydrological Assessment Of The Meliorative Condition Of Collector Drink Water In Bukhara Region. Nature **The USA Journals Volume 03 Issue 02-2021** and Science. MARSLAND PRESS. Volume 18 - Number 4 (Cumulated No. 157), April 25, 2020.99-101.
5. Y.K. Khayitov, N.A. Toshbekov., T. A. Zhumaeva., EFFICIENT USE OF WATER RESOURCES OF THE AMU-BUKHARA CANAL. ACADEMIK. An International multidisciplinary Research Journal 05/30/2020, 15-18.
6. Y.K. Khayitov, N.A. Toshbekov., T. A. Zhumaeva., The Formation of Water Collector-Resources Drainage Network of Zarafshan Oasis and the Questions of Recycling. TEST Engineering & Management. May-June 2020 ISSN: 0193-4120 Page No. 27380 - 27385.
7. Buxoro sharq durdonasi."Sharq" nashriyot-matbaa konsernining bosh tahririyati. Toshkent-1997. 96-97-bet, 105 –bet.
8. A.A. Azimov. O`zbekistonda suvdan foydalanish an`analari va zamonaviy yondashuvlar. "Fan va texnologiya" nashriyoti, Toshkent -2015. 73-75- betlar.
9. 9. Abu Bakr Muhammad ibn Ja`far Narshaxiy. Buxoro tarixi. Toshkent "Sharq mash`ali" jurnaliga ilova "Sharq bayozi" 1993. 35 - bet.
10. O`zbekiston milliy ensiklopediyasi 4-son."O`zbekiston milliy ensiklopediyasi". Davlat ilmiy nashriyoti. Toshkent. 2002 –yil. 623-bet.
11. O`zbekiston milliy ensiklopediyasi 9-son."O`zbekiston milliy ensiklopediyasi". Davlat ilmiy nashriyoti .Toshkent.2005 –yil. 575-bet, 579-bet.
12. Qorayev Suyun. O`zbekiston viloyatlari toponimlari. "O`zbekiston milliy ensiklopediyasi" Davlat ilmiy nashriyoti, 2005. 52-65-betlar.
13. meros.uz. <https://meros.uz> Chashmai – Ayub maqbarasi.
14. <https://parstoday.com> Chashmai Ayub maqbarasi.( SURATLAR ) – Parstoday
15. Atoeva Mehriniso Farhodovna, Eshmirzaeva Matluba Abdishukurovna. (2021). Application Of The Law Of Conservation Of Energy In
16. Economics. The American Journal of Applied Sciences, 3(01), 93-103.

17. Zebiniso ATOYEVA, The use of innovative pedagogical technologies in mathematics in secondary schools. Жамият ва инновациялар – Общество и инновации – Society and innovations Journal home page: <https://inscience.uz/index.php/socinov/index/>
18. Rahima Safarova, Characteristics of teaching physics in medical institutes, Жамият ва инновациялар – Общество и инновации – Society and innovations. Journal home page: <https://inscience.uz/index.php/socinov/index>.
19. Safarova Rakhima Sattor kizi, PREPARING STUDENTS FOR USE OF SCHOOL PHYSICAL EXPERIMENT IN THE PROCESS OF TEACHING PHYSICS, European Journal of Research and Reflection in Educational Sciences Vol. 8 No. 9, 2020 ISSN 2056-5852.
20. Атоева М.Ф. Периодичность обучения физике. Аспирант и соискатель.
21. Москва, 2010. – №6. – С. 41-43.
22. М.Ф. Атоева. Interdisciplinary relations in physics course at specialized secondary education. The Way of Science. – Volgograd, 2016. – №9 (31). – P.22-24.
23. М.Ф. Атоева. The significance of periodicity at teaching physics. The Way of Science. – Volgograd, 2016. – № 10 (32). – P.62-64.
24. Атоева М.Ф. Эффективность обучения электродинамике на основе технологии периодичности. The Way of Science. – Volgograd, 2016. – № 10 (32). – P.65-66.
25. М.Ф. Атоева. Use of Periodicity in Teaching Physics. Eastern European Scientific Journal. – Düsseldorf-Germany, 2017. № 4. –P. 35-39.
26. М.Ф. Атоева. Didactic foundations of inter-media relations in the training of university students. International Scientific Journal. **Theoretical & Applied Science**. p-ISSN: 2308-4944 (print) e-ISSN: 2409-0085 (online). **Year: 2020 Issue: 06 Volume: 86**, P. 124.
27. М.Ф. Атоева, R. Safarova. Pedagogical integration as a means of forming professionally important qualities among students of a medical university. *Academicia*. ISSN: 2249-7137 Vol. 10, Issue 8, August 2020. Impact Factor: SJIF 2020 = 7.13 **ACADEMICIA: An International Multidisciplinary Research Journal** <https://saarj.com>.
28. М.Ф. Атоева. Pedagogical Tests As An Element Of Types Of Pedagogical Technologies. The American Journal of Applied Sciences, 2(09), (TAJAS) SJIF-5.276 DOI-10.37547/tajas Volume 2 Issue 9, 19.09.2020. ISSN 2689-09. 92 **The USA Journals, USA** [www.usajournalshub.com/index.php/tajas](http://www.usajournalshub.com/index.php/tajas) 164-169. **Имп.5.2.**
29. Farkhodovna, A. M. (2020). The problems of preparing students for the use
30. of school physical experiment in the context of specialized education at secondary schools. European Journal of Research and Reflection in Educational Sciences, 8 (9), 164-167.
31. Saidov S.O., Fayzieva Kh. A., Yuldosheva N. B. Atoeva M.F. The Elements Of Organization Of The Educational Process On The Basis Of New Pedagogical Technologies. The American Journal of Applied Sciences, 2(09), (TAJAS) SJIF-5.276 DOI-10.37547/tajas Volume 2 Issue 9, 19.09.2020. ISSN 2689-09.92 **The USA Journals, USA** [www.usajournalshub.com/index.php/tajas](http://www.usajournalshub.com/index.php/tajas) 164- 169. **Имп.5.2.**
32. Atoeva Mehriniso Farhodovna, Arabov Jasur Olimboevich, Kobilov Bakhtiyor Badriddinovich. (2020). Innovative Pedagogical Technologies For Training The Course Of Physics. The American Journal of Interdisciplinary Innovations and Research, 2(12), 82-91.

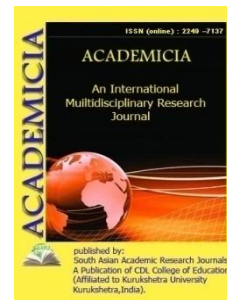
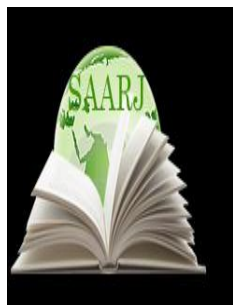

DOI: **10.5958/2249-7137.2021.01137.X**

## THE ROLE OF TEACHING READING ACTIVITIES

**Xakimboyeva Ozoda\***; **Rozikova Madina\*\***; **Pulatova Sabrina\*\***

\*Teacher of Uzbekistan State World Languages University,  
UZBEKISTAN

\*\*Fourth year student of Uzbekistan State World Languages University,  
UZBEKISTAN

### ABSTRACT

*Today, in teaching of English as a foreign language in our country, the appropriate texts must be selected considering the students' vocabulary knowledge, grammar levels, interests and needs in multi-level reading instruction like in other levels, reading instructions in multi-level, determined by the criteria established by the Common European Framework, can include texts with events mentioned in personal letters, texts about feelings and thoughts and texts with words used frequently in work or daily life. In this study reading texts used in multi-level English language teaching will be exemplified. Literature review will be used in this study. For example, reading texts with the topics such as work life, an article from Latest UK news newspaper, airport security and film review can be used in the reading instruction. The type of questions that can be asked and how the texts can be examined during the teaching of these texts are explained.*

**KEYWORDS:** *Teaching English, Multi-Level, Reading Studies, Reading Activities, Teaching Reading.*

### INTRODUCTION

A good deal of the current research in the field of EFL reading is embedded in a Psycholinguistics framework (Goodman, 1970, Coady, 1979). In this view, the reader is seen as an active processor of information, one who selects only the most productive cues from the printed page. One way of facilitating a reader's interaction with a text for triggering and building background knowledge is through pre-reading activities (Hudson, 1982). Pre-reading activities provide orientation to content and context. They vary with the nature of the text, the reader's purpose and context of situation (Wallace, 1992).

### ***Importance of Reading***

Most scholars would agree that reading is one of the most important skills for educational and professional success (Alderson, 1984). In highlighting the importance of reading comprehension Rivers (1981:147) stated that “ reading is the most important activity in any language class, not only as a source of information and a pleasurable activity, but also as a means of consolidating and extending one’s knowledge of the language”.

Reading reinforces the learner’s other language skills. Krashen (1981) confirms that those who read more, have larger vocabularies, do better on test of grammar and write better (Kim & Krashen, 1997). Chastian (1988:218) while accepting the significance of reading for meaning claimed that all reading activities serve to facilitate communication fluency in each of the other language skills.

According to Eskey (1988), in advanced levels of second language the ability to read the written language at a reasonable rate and with good comprehension has long been recognized to be as oral skills if not more important.

In an early study on reading strategies, Hosenfield (1977) used a think aloud procedure to identify relations between certain types of reading strategies and successful or unsuccessful second language reading. The successful readers, for example, kept the meaning of the passage in mind while reading, read it in broad phrases, skipped inconsequential or less important words, and had a positive self-concept as a reader. The unsuccessful reader, on the other hand, lost the meaning of the sentences when decoded, read in short phrases, pondered over inconsequential words, seldom skipped words as unimportant, and had a negative self-concept.

In their study involving good and poor readers, Hopkins and Mackay (1997) found that good readers often have more ready access to a variety of purposeful reading strategies to undertake reading tasks successfully and that they use them with greater frequency and flexibility. They are active in making inferences and using dictionaries to resolve uncertainty about the meanings of words or larger units of discourse.

In another empirical study, Song (1998) studied 68 first year tertiary students majoring in Archeology, Esthetics, and religion at a university in Korea to investigate the impact of strategy training on the reading ability of EFL university students. He also aimed to obtain answers for the differentiated effect of the strategy training on students' reading proficiency level and types of reading comprehension questions. The findings of the study showed that the reading strategy training does improve EFL college students reading proficiency. Furthermore, the study demonstrated that less able readers might benefit from the training more than more able readers. Finally the study revealed that the students' ability of grasping main ideas and of making inferences from the given passages was significantly enhanced.

The findings of Song's (1998) study is confirmed by the results of Salataci and Akeyl's (2002) study who investigated the reading strategies of Turkish EFL students in Turkish and English possible effects of reading instruction on reading in Turkish and English. Salataci and Akeyl tried to find out whether strategy instruction in EFL reading affect EFL reading strategies and reading comprehension in English. Moreover, they investigated if strategy training in EFL reading affects reading strategies in Turkish. Their participants were 8 Turkish students enrolled in a pre-intermediate level class of a one-year intensive English course offered at a Turkish-

medium technical university. The data in their study come from think-aloud protocols, observation, a background questionnaire, a semi-structured interview and the reading component of PET (the Preliminary English Test). The results indicated that strategy instruction had a positive effect on both Turkish and English reading strategies and reading comprehension in English. This finding is in accordance with Falk and Wehby's (2007) study findings who investigated the impact of explicit reading instruction on students' with emotional/behavioral disorders. Their findings suggest that direct instruction offers a promising approach to increasing the reading achievement – and potentially the behavioral outcomes- of students with emotional behavioral disorders. Reading strategy instruction has also received some attention in Iran (Barati, 1992, Sedighi, 1998, Shirazi, 1999). In his study on the effect of reading strategies on recall and retention of Iranian EFL learners, Barati (1992) considered two reading strategies: underlining and note-taking. Through analyzing the subjects' performance on factual and conceptual questions, he concluded that in both experiments note-takers could significantly outperform underliners on factual questions; but with reference to conceptual questions there was no significant difference between the two strategies.

In another study, Sedighi (1998) studied the effects of training in the use of reading strategies on the improvement of reading comprehension of 110 students at Allameh Tabatabaei University and Islamic Azad University, Iran. His study consisted of three phases. In the first phase, he conducted a descriptive research to investigate the strategies reading teachers use to teach reading comprehension in EFL classes in Iran. In this phase, he found that teachers in Iran still use traditional method of language teaching without enough strategic content. In the second phase, he conducted a survey study to describe the strategies good readers and poor

readers use in reading their EFL reading assignments. Finally in the third phase which was the experimental one, he investigated the effects of training in the use of reading strategies on the improvement of reading comprehension. It was revealed that reading strategy instruction enhances comprehension ability of the students.

It was also shown that low ability comprehenders benefited from strategy instruction more than middle and high ability comprehenders.

While lots of studies on reading strategy instruction have been done in EFL and ESL context, few studies have been conducted on the impact of strategy training on ESP readers. In Iran, Shirazi (1999) conducted a research in order to determine the impact of pre-reading strategy instruction on the reading comprehension of Iranian ESP readers. The results of his study indicated that efficient comprehension requires effective activating of the learner's background knowledge. In other words, the readers' schemata should be tapped on prior to the reading. He concluded that if the pre-reading activities are employed efficiently, learning how to read is quite easy.

There is little evidence to show that whether ESP students can benefit from reading strategy training as much as EFL learners. Therefore, the findings of the present experimental study can shed more light on the issue of teaching reading strategies and it will set the ground for a comparison between the effectiveness of reading strategy instruction versus traditional teaching of reading comprehension. Moreover, this study has got the purpose of discovering students from which proficiency level all more likely to benefit most from strategy training. While Shirazi (1999) only focused on the instruction of a few pre-reading strategies, the present study intends



to investigate the effect of all pre-reading, during-reading, and post- reading strategy instruction on reading ability of ESP readers.

### ***Interactive View of Reading and its Relationship with ESP***

A significant body of literature posits that reading is an interactive process (Carrell, Devine & Eskey 1988; Grabbe, 1991; Rumelhart & Ortony 1977). According to Grabbe (1991:385) the notion of reading as an interactive process refers to “a kind of dialogue between the reader and the text” The notion of reading as an interactive process evolved from the schema theory and is often termed top-down approach to reading. Carrell (1983) distinguishes between formal schemata the reader’s knowledge of formal, rhetorical structure of the texts and content schemata – previous knowledge which the reader possesses.

In an interactive model, the reader is not seen to progress in just one direction (bottom-up or top-down) in understanding the text, but as being able to alternate approaches as necessary (Barnett, 1989). The reader is seen as able to draw simultaneously from a variety of sources to understand the text such as lexical, orthographic, schematic, semantic, syntactical, and visual (Davies, 1995). Thus reading is seen as a simultaneous perceptual and cognitive process (Rumelhart & Ortony, 1977). Interactive model of reading comprehension not only acknowledges the role of background knowledge, but also it stresses the significance of processing actual words of the texts. Goodman (1981:137) maintains that, “ ... the goal of reading is constructing meaning in response to text. It requires interactive use of graphophonic, syntactic, and semantic cues to construct meaning.” Although he is often referred to as a leading advocate of the top –down approach, his model by his own admission is interactive.

An interactive model of reading posited by Grabbe (1991) usually refers to interplay of both bottom-up and top-down reading strategies (Block, 1992). Bottom-up strategies include decoding graphic features and grammatical characteristics, while top-down strategies include predicting, applying background knowledge and recognizing global text structure. The notion of top-down strategies is usually used in the literature to include both global strategies for processing the text as well as activating conceptual knowledge of the world (Carrell, 1985 Shih, 1992).

According to Dubin and Bycina (1991), the interactive model entails the reading processes to be as such that the visual data are transmitted to brain where they are matched with existing knowledge. Then on the basis of this experience, predictions are made about the content of the text, upon which, further sampling of the data are either confirmed or revised.

Anderson (1999) claims that “many teachers now accept the view that reading is the result of a two way communication between the reader and the text, achieved through simultaneous processing (which involves word recognition, sound/spelling correspondence etc.) and top-down processing (which involves skills like predication, inference etc.)

How do the above notions relate to ESP reading pedagogy? Grabbe’s (1991) notion of reading as an interactive process implies that the ESP reader most probably has more limited content and formal schemata as well as less knowledge of language used in the text than the author has, thus, while an ESP reading course usually emphasizes building up student’s knowledge of rhetorical structures and improving their knowledge of the target language. The gap in content schemata should not be ignored. The issue of ESP reading instructor as a content specialist raised in ESP literature (e.g. Robinson, 1991). Grabbe’s interactive model of reading dictates that ESP

instruction should focus both on decoding language and on global reading strategies which (Duffy, 1988:763) defined them as “plans for solving problems, encountered in constructing meaning”. They can be taught to students and when taught strategies help student’s performance on tests of comprehension and recall.

### ***General Views on Pre-reading Activities***

The goals of Pre-reading stage are to activate the student’s knowledge of the subject, to provide any language preparation that might be needed for coping with the passage and, finally to motivate the learners to want to read the text (Celce-Murcia, 1991). Tudor (1989) call pre-reading activities “enabling activities” because they provide a reader with the necessary background to organize activity and to comprehend the material (these experiences involve understanding the purpose (S) for reading and building a knowledge base necessary for dealing with the content and the structure of the material). They say that pre-reading activities elicit prior knowledge, and focus attention. Various techniques have been suggested by some authors (e.g. Greenall & Swan, 1986) to mobilize existing knowledge including the use of pictures, movies and even role – plays. Research has not determined which of these is the most effective. So teachers are free to experiment according to the nature of reading material and inclinations of their classes (Carrell &Eisterhold, 1983). In an academic setting, however, more formal techniques might be appropriate, of course different scholars listed different types of pre-reading activities, (Celce-Murcia, 1991:225) suggests, Word Association,

### **Discussion and Text Surveys**

Word association tasks generally involve eliciting from the students as many ideas as they can offer regarding the announced subject of the text. Normally their suggestions are written on the board and sometimes arranged into semantic map or “graphic organizer” which indicates how concepts are related to each other.

Discussions have also been found to activate what students know and through the exchange of information, to enhance their knowledge of the subject. Discussions can be initiated by simply posing questions about the content of the text or by using “anticipation guide” which is a series of statements often provocative in nature, which are intended to challenge student’s knowledge and beliefs about the content of the passage (Celce-Murcia, 1991:225).

Nuttal (1982) claims that discussion promotes the active struggle with the text and students learn the processes of critical thinking that good readers use. Group work is ideal, because in small groups, even the weaker students should be active and learning. The procedure works in almost every level, and discussion can be in L1, if students cannot manage it in the FL.

Text Survey is often, but not exclusively, used with longer stretches of discourse, such as chapter from a textbook, the purpose of this activity is to quickly determine the structure of the piece and to identify the key ideas (Celce-Murcia, 1991).

Tudor (1989) gives five other categories of Content-related pre-reading activities (a) pre questions to be answered after reading the text; (b) pre questions to activate the reader’s knowledge about the topic; (c) content organizers (e.g., summaries); (d) predictions based on the title, subheadings, illustrations, or skim reading of the text; and (e) integrated reading preparation (combining the above). Taglieber (1988) found the last two activity-types (viz. Using illustrations to make predictions, and formulating questions) to be more effective in facilitating

EFL student's comprehension than vocabulary pre-teaching. This result is interesting, since it indicates that heightened background knowledge can enable students to use contextual clues to overcome specific vocabulary deficiencies.

Taglieber (1988) has indicated three major problems that interfere with reader's comprehension.

1. Lack of vocabulary.
2. Difficulty in using language cues to meaning.
3. Lack of conceptual knowledge.

She claimed that the following practical preceding activities may help address these problems:

1. Pictorial context
2. Pre-questioning
3. Vocabulary Pre-teaching

### ***Pictorial Context***

Illustrations can be an integral part of ESP courses. The justification is that they make ESP courses more tangible and understandable. Robinson (1991:62) asserted, "as well as print material ... one would expect that for teaching ESP there would be a rich supply of authentic visual and mechanical material"; however, he believed that there is not a great deal of discussion of this in the literature.

In this regard, Wilson (1986) referred to visual support for the avoidance of problems in the comprehension. She also suggested that visual aids may be exploited as a kind of elicitation strategy.

Furthermore, she favored a classroom in which students use illustrations to fulfill a specific task.

Ellis (1993:26) stated, "visual stimuli, like verbal stimuli, are organized in comprehension and memory" He further added that the organization for visual stimuli is a consequence of perceptual processing, which is bottom-up, or data-driven, in its earlier stage, but top-down processing is affected by conceptual knowledge later on.

As a supporting basis for teaching through illustration, Paivio (1971) proposed the dual coding theory of learning from words and pictures. The theory proposes that learners can construct three types of connections when they are presented with verbal and visual material. McDaniel and Waddill (1994) conducted a research to find out the extent to which pictures can enhance recall of textually presented information, particularly item specific (detailed) information and relational information. They concluded that providing readers with the requisite comprehension abilities to begin with, pictures enable the extraction and under ordinary circumstances do not encode effectively.

### ***Pre-questioning***

The questions we are discussing here in pre-reading stage are not intended to test. Their purpose is to make students aware of the way language is used to convey meaning, the questions are not necessarily different from questions in tests, but their purpose and the way they are used is quite

different. Nuttal (1982:160) suggests signpost questions would be of great help in pre-questioning. A signpost stands at a crossroads to show travelers the way.

In using signpost questions in pre-reading stage Nuttal (1982) states that you can ask an easy SPQ on the whole text, as an initial top-down activity; and / or you can ask one for each section. Write the SPQ on the board and ask class to read the text silently and find answer. After silent reading, perhaps followed by group discussion check whether they have been able to do this. If a fair number have not, leave it open and explain that you will return to it later avoid giving an answer yourself if you possibly can. Pre-questioning is taught by having the instructor ask questions about a passage and the students answer the questions, through pre-questioning students set purposes for reading, the method is supported by (Johnson, 1981).

### CONCLUSION

Finally, results of this study further show that although a great majority of the participants favor the effectiveness of using activities in teaching reading, they do not use activities as frequently as expected. Most of the participants express that this is because of the crowded classroom environments and the heavy load of the curriculum. With accurate planning and information passed onto the teachers, this problem should be dealt with to secure the benefits of activities in the foreign language classroom.

Lastly, in course-books and materials, the use of activities can be emphasized and by presenting alternative activities, foreign language teaching can be enriched so that primary school students enjoy learning English in a robust manner.

In a nutshell, this paper has presented a review and analysis of the literature on teaching English reading encompassing an overview of activities, classifications of activities in teaching reading, and the influence of using activities on the language learners' performance. Prior researches on using English reading activities have been included as well.

Adams, M. J. (1991) 'Why not phonics and whole language.' In Ellis, W. (ed.) All Language

### REFERENCES LIST

1. Adams, M. J. (1991) 'Why not phonics and whole language.' In Ellis, W. (ed.) All Language and the Creation of Literacy. Baltimore, MA: The Orton Dyslexia Society
2. Adams, M. J. (1990) Beginning to Read: Thinking and Learning About Print. Cambridge MA: MIT Press.
3. Barr, R. (1984) 'Beginning reading instruction: from debate to reformation'. In David Pearson (ed) Handbook of Reading Research. New York: Longman.
4. Bond, G. & Dykstra, R. (1967) 'The co-operative research program in first-grade reading instruction' Reading Research Quarterly 2 (4), pp 1-142
5. Cazden, C. (1992) Whole Language Plus: Essays on Literacy In The United States and New Zealand. New York: Teachers' College Press
6. Chall, J. (1967) Learning to Read: the Great Debate. London: McGraw-Hill

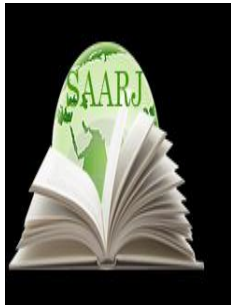

**ACADEMICIA**  
**An International**  
**Multidisciplinary**  
**Research Journal**  
 (Double Blind Refereed & Peer Reviewed Journal)

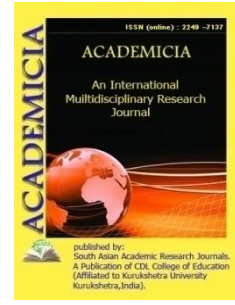

**DOI: 10.5958/2249-7137.2021.01156.3**

## DIALOGIC SPEECH TRAINING UNITS

**Paluanova M\*; Abishova G\*\*; Dauletbaeva R\*\*\***

<sup>1,3</sup>Karakalpak state University,  
 UZBEKISTAN

### ABSTRACT

*This article deals with the units of teaching dialogical speech, gives ways of conducting dialogical forms of communication, and their essence. The characteristics of the methodological deductive and inductive approaches are given. There are many examples from dialogical speeches.*

**KEYWORDS:** *Dialogical Speech, Unity, Structure, Short Dialogue, Deductive, Inductive, Process, Play, React, Replica, Utterance, Perception, Understanding, Use, Reproduction*

### INTRODUCTION

Let's start with the dialogic form of communication as the most characteristic for the manifestation of the communicative function of language. At the initial stage, the dialogic form of communication involves the ability to greet the interlocutor and respond to the greeting, as native English speakers do; the ability to say goodbye politely; the ability to introduce someone to someone; to express agreement and disagreement to do something; the ability to congratulate on a holiday, birthday, New Year, etc.; to express regret, apology; to express joy, delight, displeasure, etc.

**MAIN PART:** These general provisions and the various approaches and specific examples given in the articles are concretized in relation to the nature of the speech act, which is subject to modeling at this stage of training. Depending on whether we want to get a one-step or multi-step speech action, the composition of the components of the situation and their qualitative characteristics should change.

The units of teaching dialogic speech can be dialogic units. Dialogic unities can be different in structure. The most common ones are:

- question-answer:

Do you live near London? – Oh, yes, in a small country house.

Can you skate or ski? – I can ski.

- question – question:

Is it your pen? – Why do you ask me?

Will you help me? – What shall I do for you?

- statement-question:

I shan't go to the park. – Why? What will you do?

I want to know his address. – What for?

- statement-statement:

I'll go to the library after classes – - And I'll stay there.

This is a box of sweets for you. – Oh, thank you, I like sweets very much.

The unit of dialogue training can be not only a dialogic unity, but also a whole short dialogue-a sample consisting of several (2 – 3) dialogic unities. For example:

- Hello, Fred.

– Hello.

– It's a fine day today, isn't it?

– Certainly it is.

– Then let's go for a walk to the park.

– OK. Etc.

In the methodology of teaching foreign languages, there are two ways of teaching dialogic speech – deductive and inductive.

In the deductive approach, learning begins with a whole dialogical sample, which is considered as a structural and intonational standard for constructing similar ones. The sample dialog is a dialogic complex, it consists of several dialogic units. The training begins with the fact that the dialogue is listened to in its entirety, memorized by heart, then there is a variation of its lexical content, working out the elements, and, finally, the students are brought to conduct dialogues on the same topic as the one being learned. Proponents of this approach refer to the fact that in natural conditions, the child learns the language system "from top to bottom": from large intonation-syntactic blocks to their elements, development goes by isolating elements from the whole, belonging to the whole makes it easier to remember, etc. The disadvantage of this approach is that it does not develop the ability to independently use the material in speech, focusing on the formal side of speech. The path from the whole dialogue to the assimilation of its elements leads to the fact that there is a premature automation of the elements in the relationship in which they are used in the whole dialogue. This leads to its mechanical memorization and limits the possibilities of free conversation in new conditions.

The second approach-inductive-suggests a path from mastering the elements of the dialogue to its independent conduct on the basis of the educational and speech situation. This approach is gaining more and more supporters due to the fact that from the very first steps it directs to

learning the interaction that underlies dialogic speech; the formation of speech skills and skills in this way occurs in the process of communication. Relying on analogy plays a big role at the lower level of skill development, in the formation of primary skills, and here the reference dialogue can play its role, not for memorization, but as a role model. At a higher level, the task of teaching students to independently plan speech actions "through awareness of the motives, goals and possible results of the action", as well as "to develop the content and form of speech meanings that are adequate to the meaning", comes to the fore.

In accordance with the inductive path of learning, the preparation for conducting a dialogue includes:

- 1) Improving the mental mechanisms of dialogic speech;
- 2) Formation of skills of using language material typical for dialogic speech;
- 3) Mastering the ability to interact with partners in an internal and external speech situation.

Learning dialogic speech begins with learning to respond to the interlocutor's remark. First, the teacher gives stimulating cues, varying them depending on the type of dialogical units, and the students master the ability to respond to them. The variety of reactions depends on the class, on the language tools they have, on the individual characteristics of the students. For example, on the cue-stimulus What's his name? (photo shown) different reactions may follow:

P1 – Azat Dauletbaevich.

P2 – His name is Azat Dauletbaevich.

P3 – I don't know.

P4 – I don't know what his name is.

Or the teacher's cue-stimulus It's a fine day today may be followed by the following reactions:

P1-Oh, yes. It's great.

P2 – Not very.

P3 – It sure is.

P4 – I can't say so. It's windy. Etc.

Then the stimulating cues are given by the children themselves, and their companions react to them. After students learn how to respond to a stimulus easily and quickly with a single cue, the teacher shows them how to expand the responding cue into a short utterance. For example:

P1 – What season do you like, Gulxan Matchanovna?

T – I like spring. It's warm. The sun shines brightly. And I can work in the garden and what about you, Polat?

In order for the response training to be non-formal and have a communicative orientation, the teacher can use a variety of games. For example, it is very important to teach students to respond quickly to stimulating questions. To do this, you can use the game "Ping-pong".

– Do you like to play badminton?

– Yes, I do.

– Can you play it well?

– Yes, I can.

- Did you play it in summer?
- Yes, I did.
- Is it difficult to play it?
- No it isn't.
- Will you teach me to play it?
- Yes, it's my pleasure.

This game, conducted at a fast pace, forms the correct response of students to a variety of stimulating questions. The teacher starts this game, and then passes on his function to the children. By repeating this kind of work in the course of reaction training, and it should take place throughout the entire initial stage, because it is the essence of the conversation (dialogue), the teacher achieves the formation of this important skill. This work will allow you to prevent and eliminate typical errors such as:

T – Do you like to skate?

R. – Yes, it is.

Or a game of "Guess", for example, guess where Petya was on Sunday:

T – Where was Pete on Sunday?

- At the Zoo.

- I believe at the Zoo

- In the park.

- I think he went to the country.

- At the cinema.

- At his Granny's.

- I think he was at home.

Petya listens to the children, and the one who guesses becomes the "host" and offers his question, for example: Where was Sashya last Saturday? - and the game continues.

In the process of learning to respond, training and stimulation begins. The same purpose is served by a series of exercises that encourage students to start a dialogue through an indirect question.

T-Igor, ask Petya what he did yesterday.

Igor – Petya, what did you do yesterday?

Petya – I walked with my dog.

The same purpose is served by the game "Guess". The student leaves the class, and the class conceives of some object, its walking or action with it. The question for guessing should be very simple, of the same type: Is it a ...? or the guessers ask a number of questions, for example: What color is it? Where is it? Is it large or small? What can we do with it? Etc.



In this game, students learn how to stimulate speech with questions. However, the incentive to start a conversation can also be a statement. And this should be shown to the students. For example, the teacher gives a reacting remark and asks the children to choose different statements-stimuli that would cause this reaction. For example: T – With who did you go there? Possible incentives:

- I went to the theatre yesterday.
- I went to the country last Sunday.
- We went to the Zoo last Saturday. Etc.

The teacher may suggest that the students develop a stimulating statement. For example, the same reaction With who did you go there? it can be caused by the following stimuli:

- I like “Buratino” very much. I went to the theatre yesterday.
- The weather was so fine. We went to the country last Sunday.
- I like to sing and dance. We went to our friends last week.
- I am fond of animals. We went to the Zoo last Saturday.

If the training unit is a short sample dialog, then working with it goes through three stages:

1. Perception and understanding.
2. Playback (simple and with modification).
3. Use it in new situations.

Children listen to the dialogue either in a sound recording or in the performance of the teacher. The teacher provides and verifies the understanding of the dialogue. Then the children listen to it again with the support of the printed text and practice reading, that is, reproduce it. At home (and sometimes in the classroom) students memorize the dialogue and reproduce it from memory. Next, the teacher offers the students words to substitute, or the students do it themselves. Thus, the dialog with the modification is played back. For example, the dialog:

- Jack isn't at school today.
- What' the matter with him?
- He is ill.

Students can replace the name and the last remark (He is not well. I don't know. In this way, students memorize the structure of the English dialogue and the dialogic units themselves, which allows them to use those of them that are suitable for this communication situation in new situations.

The vast majority of exercises used in teaching dialogic speech are speech exercises. However, the initial introduction to new standard phrases in typical dialog combinations can be carried out in isolation from the speech situation. The purpose of such exercises is to establish in the memory of students strong connections between replicas that constantly or often enough appear as part of this dialogical unity, i.e. to work out contextual connections on a functional basis and structural connections between replicas. Outside of the speech situation, it is also possible to

provide lexical diversity of replicas, to teach the deployment and coupling of replicas, as well as to form automatisms in the grammatical and lexical transformation of replicas [ 1, 123]. Accordingly, we can distinguish three types of work on the material:

- 1) memorizing dialogic units by heart;
- 2) combining replicas based on functional relationships;
- 3) grammatical and lexical transformations of replicas.

The assimilation of new dialogic unities occurs by memorizing short dialogues consisting of one or two unities. This is how unities are learned, including greetings, addresses, formulas of politeness, as well as syntactic unities that allow for variation in the response:

- Happy New Year, Ann!
- Happy New Year, Peter!
- I wish you all the best.
- The same to you.
- Let us go to...
- With pleasure (I am sorry, but I can't).

In the process of memorizing dialogic units, when it is possible to focus students' attention on the form of speech, the most favorable conditions are created for practicing the intonation characteristic of different types of replicas. Learning a small dialogue is better to start with auditory perception. Then the first, most vivid impression will be a good basis for mastering the sound form of unity; auditory memory also develops, which is also important for dialogue. Learning dialogic unity by ear reproduces the conditions for operating with replicas in a natural dialogue. However, it would be wrong to limit ourselves to just auditory perception of the dialogue being learned, since this may lead to distortion and incorrect merging of words, incorrect articulation of the phrase. Therefore, it is advisable to reinforce the next stage of learning the dialogue with visual perception. The written text will be a good support for repeating the dialogue at home.

The reproduction of even a small dialogue should not take the form of an indifferent pronouncing of the learned. Trying to bring this exercise closer to the conditions of speech communication, the teacher describes verbally or shows in the picture a situation in which such a dialogue can occur. Students should imagine themselves as one of the actors and act in the style of this character, staging the dialogue. If the dialogue is reproduced by persons, it is desirable that each of the partners alternately act as the first or second interlocutor [3, 92].

An essential component of the preparation of language material is any kind of grammatical and lexical transformations of replicas in accordance with the variability of the conditions of their use in speech (change of the actor, time of action, etc.). The exercises recommended for this purpose are divided according to the structural principle into distributive (change of syntactic connections), substitution (expansion of associative connections) and transformational (expansion of both connections). The choice of exercises is related to the lexical and grammatical features of the replicas [ 2, 112].

Usually, two groups of exercises are used, which differ in the degree of independence of the students' reaction in the dialogue: to produce a dialogue with pre-set rules (in this case, models are used with the transfer of the action to another person, another object, another time, with a change in the nature of the action); to produce a dialogue caused by a stimulator embedded in the partner's statement. Cues learned as part of dialogic units should then be incorporated into new combinations. It is also necessary to enter into the dialogue phrases that were used earlier in monologue statements. For this purpose, you can use a series of exercises that combine replicas based on contextual relationships: selecting from two columns of replicas that match the meaning; naming a reference replica to a given reactive one; naming a reactive replica to a given reference one. At the stage of combining a speech sample with previously studied ones, exercises for expanding replicas are also offered.

The peculiarity of all these exercises is that they are aimed at establishing interverbal connections, i.e. they teach you to respond only to a linguistic stimulus. They can therefore be attributed to the number of preparatory exercises. Having prepared the material for dialogic speech in this way, you can start performing speech exercises. As you know, speech activity is modeled in the pedagogical process with the help of educational and speech situations (URS). URS is defined as a set of speech conditions set by students, necessary and sufficient for students to correctly perform a speech action in accordance with the intended communicative task

## CONCLUSION

As components of the URS, the formulation of the task of the exercise is considered, which models the motive or purpose of the speech action; the description of the situation (conditions and participants of communication), which models all the components of the speech situation, the URS should arouse interest in students, take into account their life experience and language capabilities; the conditions of the situation should be reported in an extremely concise form. The effectiveness of a situation is determined by the ratio between the volume of the speech response and the description of the situation.

These general provisions and the various approaches and specific examples given in the articles are concretized in relation to the nature of the speech act, which is subject to modeling at this stage of training. Depending on whether we want to get a one-step or multi-step speech action, the composition of the components of the situation and their qualitative characteristics should change.

## REFERENCES:

1. G. V. Rogova, I. N. Vereshchagina " Methods of teaching English at the initial stage in general education institutions" (manual for teachers and students of pedagogical universities), M, 2000.
2. G. V. Rogova "Methods of teaching foreign languages in secondary school", M, 1991.
3. A.D. Klimentenko, A. A. Mirolyubova" Theoretical foundations of methods of teaching foreign languages in secondary school", M, 1981.

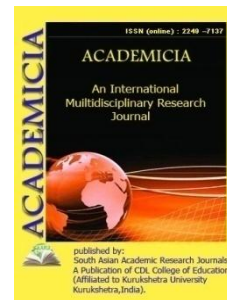
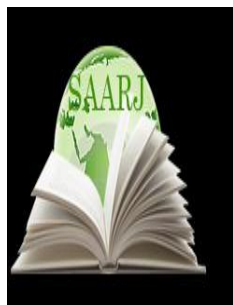

DOI: **10.5958/2249-7137.2021.01155.1**

## VISIBILITY IN TEACHING DIALOGIC SPEECH

Abishova G\*; Dauletbaeva R\*\*; Paluanova M\*\*\*

<sup>1,3</sup>Karakalpak state University,  
UZBEKISTAN

### ABSTRACT

*This article deals with clarity in teaching dialogical speech. A detailed description of visualizations, forms of their use, development, stimulation are given. The sequence of using the types of visualization with specific work and examples is recommended.*

**KEYWORDS:** *Visibility, Stimulus, Filmstrip, Overhead, Replica, Screen, Dialogical Speech, Verbally, Situation, Listening, Fantasy, Assimilation, Fantasy, Reproduction, Activity, Use, Meaning, Guess*

### INTRODUCTION

Projecting the words of the father on the screen, the teacher invites you to join the conversation. This work should be done in pairs. During the work of the students, the teacher observes them, provides assistance to those who need it, and calls one or two couples for control. In a weak class, before working in pairs, you can give a sample of the task performance either in a sound recording, or in the performance of a teacher with a strong student.

**MAIN PART:** Teaching dialogical speech can be stimulated by visualization, listened to or read, watched a filmstrip, slides, or a verbally given situation. Dialogue speech can be developed and stimulated by printed text, based on the text heard, watching filmstrips, work on pictures. The choice of the type of work depends on what is being worked out in the lesson.

The use of such clarity as: overhead scope, printed text and pictures with a complicated, undeveloped situation, when teaching dialogues in a foreign language, is important and necessary.

Learning dialogic speech can be stimulated by visual clarity, text listened to or read, viewed by a filmstrip, slides, or a verbally set situation. For example, when teaching dialogic speech, you can use a codoscope. The teacher prepares a banner on which the words of the father addressed to the son (or stimulating remarks) are presented. The task of the students is to select the reacting cues that match the meaning, so that the dialogue turns out.

Father: I say, Sonny, what shall we buy for Mummy on Woman's day?

Sonny (1) ...

Father: That's a good idea! And what will you say to Mum?

Sonny: (2) ...

The reacting cues can be:

(1) Let's buy her some flowers.

Let's buy her a large box of sweets.

Let's buy her the book about Moscow. Etc.

(2) I'll say, "Dear Mum, I love you so much".

I'll say, "Best wishes for Mother's Day".

A good, useful exercise that forms dialogic speech is a task of the type Listen, read and act. The meaning of these tasks, which develop the ability to conduct a conversation, is in their last part (act), which, unfortunately, is not always performed in the classroom [1, 86].

Dialogic speech can be stimulated by printed text that is easily dramatized. For example, "William and Mr. Romford". After reading the text, the children act out the following dialogue between Mr. Romford and William:

- Hello, Mr. Romford!

- Hello, William! Are you going home now?

- Yes.

- Give this to your sister, please. Tell her it's a present from me for her birthday. But don't open the basket. There is a nice little cat in it.

- All right.

- You must give it to Ethel, but you mustn't open it in the street.

Dialogic speech can also be developed on the basis of the listened text. For example, "It doesn't matter". Before listening to the text, students receive a task: "Dramatize the text". The result may be the following dialogue between Betty and Mary.

- What are you doing, Betty?

- I'm writing a letter to my friend Kitty.

- But how can you? You can't write.

- Well, it doesn't matter, because Kitty can't read.

The incentive for the development of dialogic speech can also be a verbally given situation. For example, you meet a friend. He (she) says he (she) has a new flat (house). Have a talk with him (her) about his (her) new flat. In a strong class, this task is enough. In a weak class, you can give support in the form of questions or only interrogative words: When ... Where ... How many rooms ... Is it far from ... Etc.

Dialogic speech can be stimulated by viewing filmstrips and organizing a conversation between the teacher and the class, the student and the student: who (what) they learned from the filmstrip, whether they liked the filmstrip, what they liked. For example, children are invited to watch the filmstrip "Tim Goes to School" and talk about this topic [2,121].

Work on images with a complicated non-expanded situation. The development of students' speech on the basis of images with an unfolded situation is not carried out in isolation from the main work in the lesson on educational and methodological complexes, but is included in the lesson when introducing and activating language material, with thematic repetition of such, as well as for the development of listening skills, dialogic and monological speech of students. Working with this type of images is characterized by the fact that, regardless of the techniques used to work with the material of the manual, both the teacher and the students, starting from the situation proposed in the picture, creatively approach the deployment of this vaguely outlined situation in a number of different content options that correspond to the interests and capabilities of each student. The main thing should be the development of students' speech activity based on imagination, speculation, internal visibility, with the natural use of language material in their speech, learned during the entire previous course of English language training.

The choice of the type of work depends on what is being worked out in the lesson. A variety of forms of work on pictures with both simple and complicated non-inverted situations is designed to help avoid monotony and promote proactive foreign language speech creation of students in the process of developing mental activity.

The recommended sequence of using the types of work for this type of images is as follows:

- 1) The teacher's stories to develop the perception of English speech by ear and create an attitude to use speculation when drawing up new options for the deployment of the situation proposed in the picture.
- 2) Students' questions to the teacher on the picture to create a new version of the situation.
- 3) Work of students in pairs. This type of work can have several options: a) a conversation about any person depicted in the picture; b) unfolding the original situation; c) drawing up a dialogue that could occur between the persons depicted in the picture. After the pair work, a new conversation between two or more students can be played out in front of the entire class.
- 4) Drawing up a story by students along the chain.
- 5) Students' own stories, compiled on the basis of the original situation shown in the picture. It should be recalled that when working with this type of visualization, the teacher should suggest to students the language material that they have partially forgotten or go beyond what they have learned, but they need it for their own development of the initial situation shown in the figure. It is necessary to strive in every possible way to ensure that the speech activity of students proceeds as smoothly as possible [3, 95].

The same image can be used in classes at different stages of language acquisition in accordance with the development of the relevant thematic material. Students can also be asked to remember the scheme of the non-expanded situation depicted in the picture, according to which they worked in the lesson, and make a story based on it at home, unfolding the situation based on

individual speculation, a story on behalf of one of the persons depicted in the picture, and in some cases, a dialogue between them.

When working with pictures with a complicated non-inverted situation, it is recommended to use the composition of stories by the class in a chain or a conversation according to the scheme class - teacher, class – student, teacher - class as a speech charge, which is quite achievable with a certain training of students.

The proposed system of work on pictures with a complicated non-expanded situation does not involve the reproduction of the teacher's stories by students, since retelling, not being an independent type of speech in terms of content, does not sufficiently involve the students' own thinking in foreign language speech activity, does not stimulate the development of speculation and fantasy, does not bring the situation depicted in the drawing closer to the life experience of each student and, therefore, can not be considered either creative or, especially, initiative speech.

Retelling (reproduction) relies mainly on the mnemonic abilities of the student. When performing this type of work, students' attention is focused not on expressing their thoughts, images, emotions, attitudes, etc., but on recalling the details of what was given in the source text. The latter takes time, since the pace of speech activity naturally decreases, and only a limited number of students are involved in the educational process. This does not mean that the use of such a technique as playing back what you have listened to or read is not recommended [2, 87].

The main tasks of the teacher's stories when working on pictures with a complicated situation are as follows:

- 1) Show students that the same picture can be a starting point for the deployment of a wide variety of situations and that the main thing in this case is not the image, but the internal visibility, own imagination, imagination, interests and language capabilities of each student;
- 2) become a kind of "spark plug" for the active speech activity of students. Therefore, it will be more fruitful if students, after listening to the story, begin to clarify the details with the teacher or another student, or express their attitude to what they have heard.

For example, after listening to a text on the topic "Appearance" about a girl, students may begin to ask: "Does she have this or that? "(Has she (a)...?), " Does she like this or that? "(Does she like...?), etc., or say: "I don't think she is ..." (I don't think she is (can, will)...), etc. With a certain habit of using creative and proactive speech, which should be formed from the younger stage of language learning, students will be able to ask a variety of questions for each text and give the most unexpected judgments, through which they control not only the degree of understanding of what they have listened to, but also the attention of each student during the teacher's story. Questions and statements of individual students should strive to turn into a conversation between them, to make it the property of the entire class.

If a question is asked that repeats the material of the text or contradicts it, the teacher can turn to one of the students for the appropriate clarification: "So what color are Masha's eyes?" (What was the color of Masha's eyes?), "So what was Kolya in his hand: a bag or a book?" (What had Kolya in his hand – a bag or a book?), etc.

The main thing is to stimulate the independent speech of students in a natural fast-flowing conversation according to the scheme class • teacher, class-student, class-class. With a certain level of training of students, which is achieved only with systematic and purposeful work, this can be achieved. Then it will take less time to complete the task, and the results for the development of students' oral speech will be higher [1.89].

The teacher can use different texts, make partial changes to them in accordance with the conditions and interests of each specific group of students, and compose their own by analogy. Such inclusion in the texts of unfamiliar vocabulary is determined by the need to teach students to perceive texts that have not only a well-known vocabulary, to develop their semantic guess, as well as the desire to bring the language of texts closer to the natural, as far as possible with its limited composition. Words that may cause difficulty in understanding may be given in a text with a Russian equivalent, so that the teacher can immediately give it to the students if necessary. They are necessary for the student only to understand this text, and their possible transfer to the long-term memory of students should be based on involuntary memorization. Since the texts are compiled mainly according to the language minimum of educational and methodological complexes in English, they should not be difficult for students; a difficult place to understand should be calmly explained, without interrupting the main line of the story, for example: "My friend told me a funny story – a funny story – so he told me a funny story about ..." etc.

**CONCLUSION.** To increase the emotional impact of texts on students, to increase their interest in what they say, they should be told based on a picture, and not read from a book. It is necessary to achieve a direct understanding of what is said, followed by a speech reaction on the part of students in the form of a series of clarifying questions and their own statements, that is, in creative or initiative forms of speech – this is the recommended way in this manual to further intensify the process of teaching a foreign language, the need for which is caused by a limited amount of time allocated to the study of this subject.

The most important thing in the organization of dialogical communication is to create a positive emotional attitude to the activities performed by children. The formal performance of tasks that promote the development of dialogic speech skills negates the practical result.

The use of such visualizations as: a codoscope, printed text, and pictures with a complicated non-expanded situation, when teaching dialogues in a foreign language is important and necessary.

#### **LIST OF USED LITERATURE:**

1. G. V. Rogova, I. N. Vereshchagin "Methods of teaching English language at the initial stage in educational institutions" (a Handbook for teachers and students of pedagogical universities), M, 2000.
2. G. V. Rogova "Methods of teaching foreign languages in high school", M, 1991.
3. A. D. Clementine, A. A. Mirolyubova "Theoretical foundations of the methodology of teaching foreign languages in high school", M, 1981.



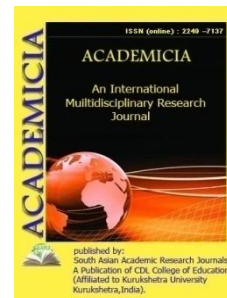

DOI: **10.5958/2249-7137.2021.01154.X**

## GENITIVE CASE PREPOSITIONS IN GERMAN LANGUAGE AND THEIR PECULIARITIES

Babaeva Gulzira\*; Bakbergenov Aybek\*\*; Otebaeva Aysuliu\*\*\*

<sup>1,3</sup>Karakalpak State University,  
UZBEKISTAN

### ABSTRACT

*This article discusses German genitive case prepositions, classification and distinguishing peculiarities of types of genitive case prepositions and meanings according to their functions. As well as, the translation of genitive case prepositions into the Karakalpak language is analyzed with examples and the similarities and differences between their semantic aspects in two languages are extensively assessed.*

**KEYWORDS:** *Preposition, Case, Adverb, Noun, Dative Case, Genitive Case, Accusative, Nominative, Prepositions Of Time, Prepositions Of Place, Alternative, Conjunction*

### INTRODUCTION

In linguistics, there is a great number of words that lexically and grammatically to connect nouns, pronouns, verbs and other words in sentence structure. In the Karakalpak language, case affixes serve to combine one part of the sentence with the others, while **prepositions** (Präpositionen) are the main connectives in German language. In a sentence, a preposition is never a separate part of it, either it goes with the following word to form an object, adverbial modifier, or predicative and attributive. Prepositions come before articles, adjectives and nouns, denoting the location, time, direction and cause of the action. In the sentence, prepositions usually come in relation to grammatical cases. In German, grammatical cases divided into four categories namely: **Nominative, Genitive, Accusative, Dativ** and they are associated with the noun, determining its syntactic function in the sentence.

### MAIN PART

In German, **Dativ** and **Accusative** cases have their own prepositions, which are constantly used together. For example, prepositions like **mit** (with), **bei** (at), **von** (from; about), **nach** (after; to), **aus** (out of; from), **zu** (to; for) are always accompanied by dative case, at the same time accusative case is related to the following prepositions: **durch** (through), **für** (for), **um** (around),

**gegen** (against), **ohne** (without). Therefore, through the preposition before the noun, it is possible to find out in which case is the subject. If the preposition **mit** is used in the sentence, then the noun and article in front of it automatically require dative case. For instance:

*Ich fahre mit der U Bahn.* [1]

*Men metro menen baraman.*

*(I will take the subway.)*

However, in German, there are also prepositions that are used in both cases, particularly dative and accusative cases. In that regard, the grammatical case of the preposition is recognized by determining whether the verb is an action or non-action word. On condition that the verb means an action that moves from one place to another, then the preposition takes accusative case, but if the verb is not in motion, then the preposition directly demands dative case.

In addition, there is a wide range of German prepositions which are used in correlation with genitive case. Nevertheless, since they are grammatically complicated, people who learn German as a foreign language make use of those prepositions rarely in oral speech. Instead of this, dative and accusative prepositions which are simple to understand are frequently used, on the other hand, this phenomenon occurs only in colloquial language and they are encountered in expanded scientific literature. The most important and useful prepositions, which require the Genitive case are **während** (during), **wegen** (because of), **trotz** (in spite of; despite). There is a wide range of such genitive case prepositions meaning time, place and cause, which are occasionally used in German.

Although, the number of prepositions that are used in the meaning of time in genitive case is limited, they play an influential role in the semantic meaning of the sentence, being an answer to the question word **qashan?** (when?). In particular, this includes prepositions like **außerhalb** (outside of), **innerhalb** (within), **während** (during) and **zeit** (while).

When we translate the word **außerhalb** from German, means **-tın' sırtında, - dan tısqarı** (outside of something), functioning as genitive case preposition of time:

*Außerhalb der Geschäftszeiten ist niemand im Büro.* [2]

*Jumıs waqtınan tısqarı mekemedede heshkim bolmaydı.*

*(Out of working hour, there is no one in the office)*

In this example, the word **außerhalb** has served as time preposition, expressing the unlimitedness of time and event which takes place out of a specific period of time.

The word **innerhalb** means **-tiñshinde, -tiñ waqtında, -tiñ dawamında** (within), performing the function of Genitive case preposition:

*Meine Doktorarbeit muss innerhalbeines Jahres fertig sein.* [3]

*Meniñ doktorlıq jumısım bir jildiñ ishinde tayar bolıwı kerek.*

*(My doctoral dissertation should be ready within a year)*

In the given example the word **innerhalb** is used to express the fact that it is necessary to carry out an action within a specific period of time. Apart from the meaning of time, the word

**innerhalb** is used to express the location. When translated from German, it means **-tń ishinde** (inside of):

*Innerhalb dieser Stadt gibt es viele Parks. [4]*

*Bul qalanń ishinde kóp parkler bar.*

*(There are lots of parks inside the city)*

With the help of the preposition **innerhalb** in this sentence, we can infer information about a particular place.

The word **Während** is used as a preposition and a conjunction in German. In both cases, **während** is used in relation with time, in other words, when it is used as a conjunction, its translation into Karakalpak is **sol waqıtta, dawamında** (during, while). To be more precise, the word **während** serves to connect two or more simultaneous actions.

*Während ich koche, sieht mich meine Katze die ganze Zeit an. [5]*

*Men awqat pisirip atırǵan waqıtta, meniń' pıshıǵım maǵan uzaq waqt qarap turadı*

*(While I am cooking, my cat looks at me all the time)*

The function of the word **während** in this example is to join two sentences which take place at parallel time.

If the word **während** comes in the form of a preposition, then its translation is **-tń waqtında** (when). The word **Während** is among prepositions which are frequently used in genitive case and we can see that it is used only in expressions of time.

*Während des Sonnenuntergangs blieben die Tiere ganz still.*

*Quyashtıń batqan waqtında haywanlar tım tırıs bolıp qaldı.*

*(All the animals remain very calm during the sunset)*

In the above mentioned example, the article **des** has taken the form of genitive case, linking the preposition **während** with the noun.

The word **Zeit** has its own grammatical function, that is, it serves as a noun, it is translated into Karakalpak as **waqt** (time). When the word **Zeit** comes as a noun in the sentence, it is written with a capital letter:

*Hast du heute Zeit? - Ja, ich habe heute Zeit. [6]*

*Búgin seniń waqtıń bar ma? Awa búgin waqtım bar.*

*(Do you have time today? Yes, I do)*

The word **Zeit** is used in German not only as a noun, but also as a preposition in some cases. When the word **Zeit** is used as a preposition in the middle of the sentence, it is spelled with a small letter. The word **Zeit** means **dawamında, boyı** (throughout, along) when translated from German. The preposition **Zeit** comes only before the noun word **Leben** (life), but it necessarily requires a possessive pronoun between the preposition and noun. The preposition comes in the function of meaning occasions which have been happening for a long period of time. Thus, it is

true to mention that other types of genitive case prepositions are not used with this word, when it comes in front of the word **Leben** with possessive case.

*Viele Hausfrauen arbeiten zeit ihres Lebens für ihre Familie.*

*Kóplegen úy biykeleri ómir boyı óz shańaraqları ushın jumıs isleydi.*

*(Many housewives work for their family throughout their lifetime)*

The prepositions used in the meaning of place in German are very numerous. Being an answer to the questions **qay jerde? qayda?** (where?), these prepositions come on the right and left side of the noun, indicating its position in the sentence.

In addition to the function of preposition, the word **abseits** serves as an adverb. When it comes as an adverb, it means **shette, qaptalda** (beside), denoting the location of the noun.

*Das Haus lag abseits. (Adverb)*

*Úy shette jaylasqan.*

*(The house is located offside)*

*Das Haus lag abseits der Straße. (Preposition)*

*Úy kóshenin' shetinde jaylasqan.*

*(The house is outside the Street)*

In the given example, the word **abseits** is used as an adverb and a preposition. When it comes as a preposition before the noun, it changes the meaning of the noun, determining the place where it is situated. However, when it comes as an adverb, no clarity has been added to the sentence.

The word **entlang** in German comes in genitive and accusative cases. When we translate it into Karakalpak, it means **boylap, -tıń boyında** (along). If it is in genitive case, it comes before the noun, influencing its meaning:

*Entlang des Flusses stehen die Bäume.*

*Dáryaniń boyında terekler ósip tur.*

*(There are trees along the river)*

As seen in the example above, the word **entlang** is associated with the noun, conveying its exact location. At the same time, **entlang** can be placed after the noun, when it is connected with Accusative case.

*Gehen Sie immer die Straße entlang!*

*Kóshe boylap júriń!*

*(Go along the street!)*

As you can see in the following example, the word **jenseits** translated from German, means **-tıń basqa tárepinde** (on the other side):

*Unsere Freunde wohnen jenseits des Gartens.*

*Meniń doslarım baǵdın' basqa tárepinde jasaydı.*

*(My friends live on the other side of the garden)*

The preposition **diesseits** comes in the opposite meaning of the word **jenseits** in Karakalpak, to be more specific, when it is translated from German, it means **-tñ bergi tárepi, -tñ bergi tárepinde** (on this side of).

*Diesseits des Tales liegt ein schönes Schloss.*

*Oypatlıqtñ bergi tárepinde ájayıp saray jaylasqan.*

*(There is a beautiful castle on this side of the valley)*

The words **oberhalb** and **unterhalb** are used in genitive case, possessing contradictory meanings to each other. **Oberhalb** comes in the meaning of **-tñ ústinde, -tñ joqarisında** (above), while the word **unterhalb** means **-tñ astında, -tñ tómeninde** (below):

*Die alte Burg liegt oberhalb der Stadt. [7]*

*Eski saray qalanıñ joqarisında jaylasqan.*

*(The old castle lies above the city)*

*Unterhalb der 1000 Meter - Grenze befinden sich viele Rastplätze.*

*Mñ metrli biyikliktegi shegaranıñ tómeninde kóplegen dem alıw orınlari jaylasqan.*

*(There are many resting places 1000 metres below the border)*

In the given examples, the words **oberhalb** and **unterhalb** express the precise positions of definite areas.

The word **unweit** serves to express meaning of a place or destination that is not distant in space and translated as **-tñ qasında, -tan uzaq emes jerde** (not far from, near).

*Besuchen Sie oft das Kino unweit Ihres Hauses?*

*Úyiñizdiñ qasındağı kinoteatrğa tez-tezden barıp turasızba?*

*(Do you often go to the theatre near your house?)*

In German, causative prepositions of genitive case connect the two words or sentences in the sence of causation. To illustrate, several types of such prepositions are given in the following examples.

The word **aufgrund** is translated into Karakalpak as **-tñ sebebinen, sebepli** (because of; due to), identifying the reason of the result of the acton in the sentence. It can be seen in the next example:

*Aufgrund deiner Faulheit wirst du die Prüfung vielleicht nicht bestehen.*

*Seniñ jalqawlıgıñnıñ sebebinen imtihannan óte almaysañ-aw!*

*(You probably cannot pass the exam because of your laziness)*

*Anlässlich der 1000 - Jahr - Feier unserer Stadt findet im August ein internationales Musikfestival statt.*

*Bizlerdiñ qalamızdñ 1000 jullıq yubiley bayramınıñ múnasibeti menen avgust ayında xalıqaralıq koncert festivalı bolıp ótedi*

*(Due to the 1000th anniversary of our city, an international music festival will be held in August)*

In the second example above, the word **anlässlich** has been used to indicate a definite cause in the sentence.

The preposition **infolge** means that there is a continuation of some kind of event. Its literal translation in Karakalpak is **-tıñ sebebinen, -tıñ nátiyjesinde** (as a result of). For instance:

*Infolge des Unfalls ist das Auto kaputt geworden.*

*Baxıtsız waqıyanıñ nátiyjesinde mashina buzılıp qaldı.*

*(The car broke down as a result of the accident)*

Moreover, it is essential to state that the genitive case prepositions such as **mangels** and **wegen** come in the meanings of cause and result as well.

*Mangels ausreichender Beweise wurde der Angeklagte freigesprochen.*

*Jeterlishe dálillerdiñ jetispewshiligi sebebinen ayıplanıwshı aqlandı.*

*(Due to the lack of sufficient evidence, the suspect was acquitted)*

*Mangels Arbeitsverträgen können sie jederzeit entlassen werden.*

*Jumis shártnamalarınıñ bolmağanlıǵı sebepli olar qálegen waqtında jumıstan bosatıwı múmkin.*

*(Because of the absence of employment contracts, they may be dismissed at any time)*

In the given examples, the preposition **mangels** is translated from German as **-tıñ bolmağanlıǵı sebepli, -tıñ jetispewshiligi sebepli** (due to the lack of).

The word **wegen** comes in the same meaning as the word **aufgrund** in Karakalpak.

*Wegen des Streiks kamen viele Menschen verspätet zur Arbeit.*

*Des Streiks wegen kamen viele Menschen verspätet zur Arbeit.*

*Tártipsizliklerdiñ sebebinen kóp adamlar jumısqa kesh keldi.*

*(Due to the lack of order, many people came to work late)*

Only two prepositions of genitive case, namely **trotz** and **ungeachtet**, come in the contrary meaning, and translated as **qaramastan** (despite of). In German, these prepositions are considered synonyms, and both of them perform the same function. The unique difference between them is that **ungeachtet** is used only in the written style, whereas the word **trotz** is used in both written and oral speeches.

*Ungeachtet des Schmerzes setzte er fort, zu laufen.*

*Awırıwına qaramastan ol juwırıwdı dawam ettirdi.*

*(Despite his illness, he continued to run)*

*Trotz des Telefonanrufs haben wir weitergegessen.*

*Telefon qońurawı bolıwına qaramastan bizler awqatlanıwdı dawam ettik.*

*(Despite the phone call, we continued to eat)*

In the given examples, the words **trotz** and **ungeachtet** have been used to express the acting against regardless of the current circumstances. Apart from the genitive case, the word **trotz** comes in correlation with dative case, however this occurs in oral speech only. The preposition **trotz** comes without any articles, and adjectives in front of it in a sentence.

In German, two synonym words **anstatt** and **statt**, serve to express two things which are mutually exclusive, and translated as **-tiń ornına** (instead of). These prepositions are used just in genitive case, possessing the similar meaning and function.

*Statt/Anstatt eines Blumenstraußes verschenkte er ein altes Buch.*

*Ol gúl dásteniń ornına eski kitap sawǵa qıldı.*

*(Instead of a bouquet of flowers he gave away an old book)*

As it can be seen in the example, the words **anstatt** and **statt** can be used as an alternative to each other. In German, these prepositions come before the noun, giving the meaning that one person, thing or action replaces another.

## CONCLUSION

Thus, from the examples mentioned above, it can be inferred that each of the prepositions of genitive case has its distinctive characteristic. It is also worth noticing that they play a vital role in the structure of the sentence as they provide various meanings that have significant impact on the content of the text. We can conclude from the examples illustrated in this research, genitive case prepositions are used to determine the place and time in which the event takes place, contrast which show the difference between two statements, cause which identifies why something happens, and alternation. This means that, in German, in most cases the prepositions of genitive case are used in compound sentences in order to connect one word or sentence with the others. Especially, it is possible to encounter such prepositions in scientific records in linguistics of German language.

## REFERENCES

1. Anneli Billina, Lilli Marlen Brill, Deutsch üben Wortschatz und Grammatik A2, Hueber Verlag 2019,
2. Anne Buscha, Szilvia Szita, C Grammatik - Übungsgrammatik Deutsch als Fremdsprache Sprachnivea C1- C2 Schubert Verlag 2013
3. Anneli Billina, Monika Reimann, Übungsgrammatik für die Grundstufe, A1 - B1, Hueber Verlag 2012
4. Dora Schulz, Heinz Griesbach, Grammatik der deutschen Sprache, Max Hueber Verlag 1960.
5. Friederike Jin, Ute Voß, Deutsch als Fremdsprache Grammatik aktiv Cornelsen B2-C1, Schulverlage Berlin, 2017.
6. S.Saidow, Deutsche Grammatik in Übungen, 2003.

7. S.V Krestinsky., Deutsche Grammatik von heute. Functional grammar of the German language
8. Sebastian Nagel, Lokale Grammatiken zur Beschreibung von lokativen Sätzen und ihre Anwendung im Information Retrieval, München 2008.
9. T.V.Sosnova, O.V. Gasova, Deutsche Grammatik, Textbook on German grammar with rules and exercises, Belarusian National Technical University 2013.
10. Stefan Zweig, Der Roman "Angst "
11. Michaela Perlmann - Balme, Susanne Schwalb, Magdalena Matussek, Erweiterte Darstellung der Grammatikseiten zu Sicher! C1 KB Hueber Verlag,
12. Karin Hall, Barbara Scheiner, Übungsgrammatik für Fortgeschrittene, Deutsch als Fremdsprache, Max Hueber Verlag
13. Gerd Bosch, Mary Bianchi, Das Zertifikat Deutsch als Fremdsprache, Deutscher Volkshochschul - Verband Goethe Institut, 1991 Bonn
14. L.Yu.Shipizina, «Exercises in the grammar of the German language», Arkhangelsk, Pomor State University named after M. V. Lomonosov 2003
15. Sabine Dinsel, Deutsch üben 15 - Präpositionen A2- C1, Hueber Verlag 2011





**ACADEMICIA**  
**An International**  
**Multidisciplinary**  
**Research Journal**  
 (Double Blind Refereed & Peer Reviewed Journal)



**DOI: 10.5958/2249-7137.2021.01153.8**

## LIOTRYPHON PUNCTULATUS – THE ECTOPARASITE OF CODLING MOTH

**Berdiev Dzhura Khursandovich\***; **Omonova Nafisa Rakhimovna\*\***;  
**Norkobilova Zarina Boykobil kizi\*\*\***

\*Associate Professor,  
 Karshi state university, UZBEKISTAN  
 Email id: berdiyev3057@mail.ru

\*\*Teacher of Karshi state university,  
 UZBEKISTAN  
 Email id: nafisa.omonova1@mail.ru

\*\*\*Teacher of Karshi state university,  
 UZBEKISTAN  
 Email id: norqobilova94@inbox.ru

### ABSTRACT

*The article describes the seasonal expeditions in the orchards of Kashkadarya according to the seasons, eggs of *Liotryphon punctulatus*, *Four-toothed ascogaster*, *Red-footed microdus* *Braconidae* were collected from the external parasites of the main pest of the garden, codling moth, and studied in the laboratory. According to laboratory results, the most dominant species is *Liotryphon punctulatus*.*

**KEYWORDS:** *Population, Pests, Entomophagous, Ichneumonoidea, Red Foot Microdus, Parasite, Fungus.*

### INTRODUCTION

In reducing the pest population size of entomophagous use reduces their number of species to a certain extent. According to the article, according to the seasons of 2020, seasonal expeditions were carried out in the gardens of Kashkadarya. According to the scientific research results, the collected entomophages were analyzed in collaboration with experts from the Institute of Zoology of the Academy of Sciences of Uzbekistan entomology laboratory. As an analysis result, the parasite *Liotryphon punctulatus* was recorded as a dominant species. Therefore, we have studied the parasite development as follows. During the winter, under the old bark of the

apple tree, 350 pieces of adult larvae of the apple worm, which had crawled into the cocoon, were stored in the laboratory. Observations continued. As a result, 214 liotryphon parasites flew out of the cocoon. The analysis showed that the parasite overwinters in the larval phase of the adult larvae. Laboratory observations show that the parasite larvae can withstand winter temperatures up to 20°C. The most common external parasite of apple caterpillars (ectoparasite), the oligophagous parasite overwinters in the larval stage of the adult apple caterpillar and turns into a fungus in February next year. Wintering larvae of ichneumonidae also tolerate temperatures down to -20°C. In Uzbekistan, liotryphon flies from mushrooms, mainly in late March to early April. The flying ichneumonidae codling manages to infect the wintering worms of the moth. *Ichneumon idea* lays its eggs on or next to the codling moth. One worm can lay up to seven eggs, but only in one of them does the larva develop fully, in the rest, the larvae die by injuring each other.

The laid eggs can be fertilized or unfertilized, females in fertilized eggs; only male *ichneumon idea* develops from unfertilized. Liotryphon flies out of the fungus before puberty. In the fungi, first the males of the parasite and then the females emerge. After the females are fed with flower nectar and the hemolymph of the host, its eggs mature and begin to lay eggs in 5-6 days. Females that consume protein and carbohydrate supplements live 30 to 40 days, while male insects live 15 to 20 days. The female liotryphon lays up to 120-130 eggs.



**Fig.1. Liotryphon punctulatus**

In the laboratory, one ichneumonidae was found to have paralyzed up to 118 codling moth worms. During the growing season, liotryphon reproduces up to 6 times.

*Four-toothed ascogaster* – *Ascogaster quadridentatus* (Hymenoptera group, Braconidae family). Codling moth is an effective parasite that kills at the expense of eggs and worms. Codling moth is found in all regions where it is widespread. In Uzbekistan, the emergence of ascogaster codling moth worms in the first half of May coincides with the mass laying period of apple butterflies. They begin to lay eggs when they are sexually mature or after 5-6 hours. Ascogaster searches for the apple caterpillar's egg and lays an egg in it. Only male insects develop from unfertilized eggs. In the laboratory, it was found that the female lays up to 700 eggs. The larva of the parasite flies out of the host embryo and stops developing and the master

worm feeds vigorously with its inner head during cocoon wrapping. After feeding, the host worm wraps itself around the cocoon and turns into a mushroom. The 520 laid eggs flew.



Fig 2. The parasite propagated in the laboratory

It takes 30 to 34 days for *Ascogaster* to fully develop, during the growing season braconid gives 3–4 generations.

**Red foot microdus - *Microdus rufipes* Ness.** (Hymenoptera turkumi, Braconidae oilasi). A common parasite of codling moth worms and several other butterfly worms overwinter inside the codling moth worm cocoon during the larval phase in the microdus range. The parasite flies a few days earlier than the codling moth worm before it reaches sexual maturity and needs to be fed extra carbohydrate food. 2–4 days later, the female lays eggs in the first and second year larvae of the codling moth under the skin and core of the microdus apple and at the age of 4, the parasite larvae emerge from the larvae and feed on its remains after the codling moth worm has hatched into an internal parasite (endoparasite) up to the larval stage inside the master cocoon, the cocoon wraps around the cocoon and turns into a mushroom. *Microdus* develop synchronously with its master, the apple worm, and the parasite reproduces as many generations as the pest does. Out of the 500 eggs bred in the laboratory, 357 were hatched.

#### Research results

Parasites types	Number of eggs laid in the laboratory (pcs)	The number of parasites hatched from eggs in the laboratory (pcs)	Parasite damage In %	Damaged codling moth (pcs)
<i>Liotryphon</i> <i>Liotryphon punctulatus</i>	350	214	61.14%	131

<b>Four-toothed ascogaster</b> – <i>Ascogaster quadridentatus</i> Wesm.	700	520	19%	98
<b>Red foot microdus-</b> <i>Microdus rufipes</i> Ness	500	357	25.2%	90

According to the scientific research results conducted in the laboratory, the damage rate of codling moth was 131 pieces and it was found to be high.

**Liotryphon** – *Propagation of Liotryphon punctulatus in the laboratory and distribution to apple orchards before the start of each phase of codling moth gives high efficiency.*

### Rezyume

Olib borilgan tadqiqot natijalaridan kelib chiqib codling mothga qarshi quyidagi turlar o`rganildi **Liotrifon** – *Liotryphon punctulatus*, **To`rttishli askogaster** – *Ascogaster quadridentatus*, **Qiziloyoq mikroodus-** *Microdus rufipes* bu turlar orasida *Liotryphon punctulatus* ustun tur sifatida aniqlandi.

### Резюме

По результатам исследования на яблоневых садах изучены следующие виды:

Liotrifon – *Liotryphon punctulatus*, квадридентатус– *Ascogaster quadridentatus*,

Qiziloyoq mikroodus- *Microdus rufipes*. Среди этих видов *Liotryphon punctulatus* был определен как доминирующий вид.

### Resume

Based on the results of the study, the following species such as Liotrifon - *Liotryphon punctulatus*, Quaternary ascogaster - *Ascogaster quadridentatus* and Red-footed microdus - *Microdus rufipes* were studied against apple orchards. Among these species, *Liotryphon punctulatus* has been identified as the dominant species.

### REFERENCES

1. Adashkevich B.P., Umarova T.M. Sorokina A.P. Outs of the entomophage in Uzbekistan // Plant protection.-1987 N-5. p-34-35.
2. Zh.Kh Berdiev, MB Shukurova "Integrated measures against apple pests in the south of Uzbekistan"Lambert Academic Publishing Germany. p- 103.
3. Muminov B.A. and others. ,, Practical training in general entomology - Tashkent,1994.32-p
4. Dospekhov B.A. ,, Technique of the field experiment. –M: Kolos, 1979. -312 p.
5. A. Sh. Khamraev, K. Nasriddinov "Biological protection of plants"2003. p-287.
6. Viktorev GA, Ecology of parasites-entomophages. M. ,, Science "1976.- 152 p.

7. A. G. Davlatshina “Ecology and biology of entomophages in the distribution of agricultural crops in Uzbekistan”. Tashkent ,, Science ”1974.-176
8. A.V. Madatyan Determination of the timing of the fight against the codling moth // Plant protection. 1985. N-11. p- 39.
9. Zh.Kh Berdiev, M.B Shukurova,, APPLE MOTH (LASPEYRESIA POMONELLA L.)PHYSICAL CONTROL METHOD. Impact Journals Vol.2, Issue 2, Feb 2014, 29-32.
10. Khojaev Sh.T. The main directions of insect sex pheromones in Uzbekistan. // Plant protection,1990.N-1 –p- 21-23.



**ACADEMICIA**  
**An International**  
**Multidisciplinary**  
**Research Journal**  
 (Double Blind Refereed & Peer Reviewed Journal)

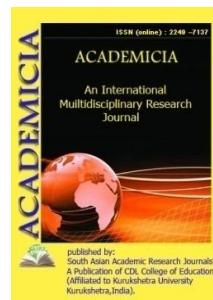

DOI: **10.5958/2249-7137.2021.01224.6**

**SOME ISSUES OF IMPROVING THE HYDRO GEOLOGICAL  
 CONDITIONS OF THE SOILS OF KARAKALPAKSTAN**

**Abduvahob Ismonov\*; Gulnoza Kattayeva\*\*; Bakhtiyor Ramazonov\*\*\***

\*Ph.D of Biological sciences,  
 Head of the Department of Genesis,  
 Art. scientific. Employee Geography and soil Mapping Scientific,  
 Research Institute Soil Science and Agrochemistry,  
 UZBEKISTAN  
 Email id: abduvahob60@mail.ru,

\*\*Ph.D. Student,  
 Scientific Research Institute of Soil Science and Agrochemistry,  
 UZBEKISTAN  
 Email id: gulnozakattayeva@mail.ru,

\*\*\*Associate professor, Ph.D.,  
 Chirchik State Pedagogical Institute of Tashkent Region,  
 UZBEKISTAN  
 Email id: ramazonov\_74@mail.ru,

**ABSTRACT**

*The article deals with lithological, geomorphological and hydrogeological conditions of the soils of the Republic of Karakalpakstan. According to the topography of groundwater, the causes of changes in their location and the laws of formation are studied. In protected areas located in irrigated areas, groundwater averages 1-2.5 m. around, their highest stay corresponds to the period of saline washing and vegetative irrigation. In Chimbay, Bozatov, Kungrad, Takhtakor, Shumanay and Karaozak districts, the average groundwater level is 2.5 m. stands at. In the former coastal areas of the dried bottom of the Aral Sea, the average groundwater level was 1.5-2.0 m.*

**KEYWORDS:** *Delta-Alluvial Plains, Groundwater, Hydrogeological Conditions, Chemistry And Type Of Salinity, Relief*

## INTRODUCTION

The Republic of Karakalpakstan occupies the Amu Darya delta, the southern part of the Aral Sea and the adjacent regions of Ustyurt and Kyzylkum. Karakalpakstan is a country of large and far from fully utilized opportunities for the development of diversified agriculture. It is based on oasis, irrigated agriculture. But due to the presence of vast pastures, reed thickets and numerous reservoirs, agriculture here is uniquely combined with semi-stale animal husbandry, as well as fishing, hunting and fur farming [1; 2].

### **The object of research and their methods of implementation**

According to climatic conditions, the territory of the Aral Sea is located in the northern part of the subtropical and in the southern part of the subboreal subzone of the desert zone of Central Asia. The average annual air temperature in July reaches 25.8-28.1 °C, with an absolute maximum of 41-42 °C. The wide annual range of temperature fluctuations from absolute maximums to minimums indicates a sharp continental climate.

The territory of the Aral water area is located on ancient, old and partly on relatively young surfaces of the Amu Darya delta. Ancient and old surfaces long ago emerged from the influence of flood floods and at a certain stage of their development - even before their irrigation development - went through the stages of drying and desertification. This area, like the entire former "living delta", has dried up and is now undergoing intense desertification.

The research is based on the comparative-geographical method, taking into account the conditions of soil formation, which will make it possible to study the genesis of soils in the main directions of the soil-forming process. In the field studies, morphological methods were used to ensure the reliability of field diagnostics of soils and their main morphogenetic properties. Laboratory and analytical studies on selected soil samples were carried out at the analytical center of the Research Institute of Soil Science and Agrochemistry according to generally accepted methods [3; 4; 5].

### **Results of the study**

The hydrogeological and meliorative conditions of the region are unfavorable, which is caused by the extremely difficult general groundwater runoff. This is facilitated by the weak slopes of the delta, the composition of the soil-forming rocks, characterized by high dustiness, and the structure of the soil-soil strata, characterized by the absence of continuous drainage layers. Therefore, the depth of occurrence and the regime of the groundwater level here are determined by the ratios of their arrival and discharge.

The groundwater level in different parts of the Amu Darya delta is different and depends on the degree of development, watering and drainage of the territory. On irrigated areas and virgin-fallow lands located among them, it fluctuates within 1-2.5 m. Their highest standing falls on the periods of leaching and vegetation irrigation. On the periphery of the oases in Chimbay, Bozatau, Kungrad, Takhtakupyr, Shumanay and Karauzyak districts, groundwater occurs at a depth of 2.5-4 m.

The almost stagnant nature of groundwater, when its consumption is mainly for evaporation and transpiration by vegetation, determines their variegation in terms of the degree of mineralization,

which ranges from slightly saline to brines (on virgin lands), especially this phenomenon is observed on the old coast of the Aral Sea (depth of ground water 1, 5-2.0m).

Over the past 30-35 years, studying and comparing soil maps and other materials, it can be established that automorphic - takyrs and semi-hydromorphic - takyrs-meadow soils, which dominated in the Aral regions and occupied significant areas in other regions, over the past decades have largely evolved into meadow soils are typical representatives of the hydromorphic series [6; 7; 8]. After a sharp decrease in the water content of the Amu Darya and the global drying out of the floodplain-alluvial plains, meadow and bog-meadow soils, drying and desertification, evolved into meadow-takyr (kinky residual-meadow and residual-boggy) soils. Here, slightly saline and non-saline (washed) soils occupy more than 27.3% of the area, but the prevailing area of land is saline in an average (37.4%) and strong (35.3%) degree. Particularly unfavorable land reclamation is observed in Muynak, Karauzyak, Kegeili, Bozatau, Kungrad and Takhtakupyr districts, where the share of highly saline soils reaches 43-86%, and slightly saline and washed soils - 12-23%. The reason for this situation was, first of all, the poor condition of the collector-drainage network, as well as under-washing and under-watering caused by a shortage of irrigation water.

The Amu Darya delta is characterized by a relatively homogeneous leveled surface with a general slight slope (0.00010-0.00020) from the top to the mouth. The flatness of the relief is only slightly complicated by elevated stripes along the numerous active and dead channels and extensive inter-channel depressions. The height of the riverbed shafts depends on the size of the channel and the position in the delta. In the upper reaches, they have a height of up to 4-6 m, and in the lower reaches, where the river-side banks are located, in the stage of formation, their height rarely exceeds, 1-2 m. The width of the riverbed shafts also depends on the above reasons and ranges from hundreds of meters to several kilometers. In the areas of the modern delta of the Amu Darya, the riverbed swells of dead channels are natural dams that determine the spread of flood floods. In river valleys, the farther the terraces are from the channels, the higher and older they are. In the delta, however, all the difference in relief is associated with the uneven accumulation of alluvium. In the immediate vicinity of the channel during flood floods, the maximum amount of material suspended in the water is deposited, and in the distance it is minimal, but both the riverbed swells and the inter-channel depressions are of the same age. To the south of Nukus, the current bed of the Amu Darya is cut into the alluvium. There are no near-river banks along the river in this area, and even a floodplain terrace stands out. There are areas of hilly and ridge sands scattered throughout the delta, rising above the plain from 2-3 to 6 m and more.

By genesis and relief, two types of sands are distinguished: hilly and cumulus gray mica sands formed by crumbling alluvial deposits, ridge-hilly reddish sands of bedrocks carried by the wind from the Kyzylkum plateau [9]. Reddish sands are distributed mainly on the alluvial plains adjacent to the Kyzyl Kum. In areas of intensive farming, the delta-alluvial relief is significantly transformed. As a result of the field leveling, the unevenness of the relief is leveled, and with prolonged cultivation due to agro-irrigation sediments, the surface of the inter-channel depressions slightly increases.

The high turbidity of the Amudarya water contributes to the rapid siltation of the canals. Therefore, in irrigated areas, there are often accumulations of irrigated sediments, thrown out during cleaning. The complexity of the geological and geomorphological structure of the



territory of Karakalpakstan has also caused an extraordinary variety of its hydrogeological conditions. Ground waters of different age and structure areas have different feeding areas, depth of occurrence, chemistry, salinity, etc. Delta-alluvial plains, composed of loose sandy-clayey strata, for example, have a single hydraulically connected groundwater table. The sources of groundwater supply here are the waters of the Amu Darya, which come in the form of a ground flow from the channel, as well as from flood floods and irrigation canals. Therefore, remote feeding in the form of groundwater transit prevails.

The formation and regime of groundwater in the area under consideration is largely determined by its lithological and geomorphological features, climate and groundwater regime. Due to the small slopes of the terrain, high dustiness and sharp stratification of soils, showing to some extent the properties of a "layered screen", there is an extreme difficulty in the total underground runoff. The speed of movement of the soil flow is measured in tens of centimeters per year. The formation and regime of groundwater in the area under consideration is largely determined by its lithological and geomorphological features, climate and groundwater regime. Due to the small slopes of the terrain, high dustiness and sharp stratification of soils, showing to some extent the properties of a "layered screen", there is an extreme difficulty in the total underground runoff. The speed of movement of the soil flow is measured in tens of centimeters per year.

Studies have shown that the complexity of the geological and lithological-geomorphological structure of the territory of Karakalpakstan has led to the extraordinary diversity of its hydrogeological conditions. Ground waters of different age of development and structure of soils have different sources of nutrition, depth of occurrence, mineralization, salinity chemistry, etc. The main source of groundwater supply is the water of the Amu Darya, coming in the form of a ground flow from hypsometric, higher located territories, as well as filtration water from irrigation canals, irrigation networks and irrigated areas [10].

The hydrogeological conditions of the territories of the Republic of Karakalpakstan contributed to the fact that the formed groundwater, as well as a large amount of surface irrigation water, do not have sufficient runoff and are spent mainly on evaporation and transpiration. Infiltration waters, superimposed on the groundwater, raise the groundwater level. The conditions of the local outflow of groundwater, provided by the outflow, determine the different rate of this rise. The depth of the groundwater level in the main part of the irrigated area, at the end of the growing season of agricultural plants, is above the critical 2.5-3.0 meters, during vegetation irrigation this figure is 1-2 meters.

The ground waters of the delta-alluvial plains have different mineralization. There are both fresh, containing less than 1 g / l of salts, and brines with a salt concentration of more than 110-120 g / l. In general, groundwater salinity increases with distance from food sources. In March-April, when there are massive leaching of lands before sowing, the water table rises throughout the oasis. Further, with an increase in temperature in the month of May, evaporation increases, and from the second half of June - and transpiration, as a result of which the groundwater level gradually decreases. In autumn, starting from the month of October and in winter, groundwater is the lowest.

Periodic studies of the soil cover indicate a deterioration in the subsequent years of the qualitative state of lands in all territories of the Aral Sea. This is due to the increasing processes

of soil salinization, an increase in groundwater, the development of wind erosion and desertification, which together leads to soil degradation.

In this regard, it is necessary to develop agricultural measures for the conservation and protection of soils. The main measures for soil protection are: A set of agrotechnical measures, a set of reclamation measures and a set of anti-erosion measures.

## CONCLUSION

Unfavorable hydrogeological conditions, despite artificial drainage, create preconditions for a rise in the level of saline groundwater and the appearance of secondary soil salinization in irrigated areas. To maintain the groundwater level below the critical depth, annual cleaning, if necessary, and the installation of new additional drainage is necessary. To remove toxic salts from the root layer, high-quality flushing is also necessary.

When installing the irrigation regime, it is necessary to be guided by the hydromodular zoning, which gives the calculated irrigation rates, irrigation schemes and irrigation rates, the use of which, against the background of an efficiently working collector-drainage network, will allow the groundwater to be kept below the critical level. The widespread introduction of crop rotations as a powerful means of improving the reclamation state of soils and increasing their fertility. To carry out a complex of anti-deflationary measures on sandy-sandy soils and sands.

Thermal resources will make it possible to grow here under irrigation conditions medium-fiber varieties of cotton, as well as grain, vegetables, melons, fruit, fodder and other agricultural crops; even in these territories, gardens, vineyards and others can be created.

## REFERENCES

1. PochviUzbekskoySSR III-tom[Soils of the Uzbek SSR III-volume]. izd. «Uzbekistan», Tashkent.1964. -s
2. KrilovM.M. Kvoprosugidrogeologo-meliorativnogorayonirovanienizoviyAmudari[On the issue of hydrogeological-reclamation zoning of the lower reaches of the Amu Darya], InstitutGeologiiANUzbekistana, Tashkent, 1952.
3. PochvirespublikiKarakalpakstan[Soils of the Republic of Karakalpakstan], Kn. 1-7. Tashkent 1995-1998.
4. KuzievR.K., AbduraxmanovN.Yu. idr. 2013. Ukazaniyapovedeniyuzemelnogokadastra, provedeniyupochvenno-iziskatelskixrabotisostavleniyupochvennixkart[Instructions for maintaining a land cadastre, conducting soil exploration and compiling soil maps]. Tashkent, - s. 52
5. Arinushkina Ye.V.1975. Rukovodstvopoximicheskouanalizupochv [Soil Chemical Analysis Guide]. Moskva. MGU, - s. 491.
6. **RozaovB.G. 2004. Morfologiyapochv[Soil Chemical Analysis Guide]. Moskva, Akademicheskijproekt, - s. 432.**
7. Ramazonov B.R., Kuziev R.K. Evolution of soils of the Aral Sea area under the influence of anthropogenic desertification. European science review. No. 1-2. 2018 February.Premier publishing Vienna 2018 pp 24-28.

- 
- 8.** Ramazonov B.R., Kuziev R.K. Soils of the dried part of the Aral sea and problems of desertification International Journal of Psychosocial Rehabilitation, Vol.24, Issue 04 2020. A web based peer reviewed publication for mental health practitioners, consumers & applied researchers. [www.psychosocial.com](http://www.psychosocial.com) Hampstead Psychological Associates Road, London NW1 7 JA United Kingdom. Page 4134-4146.
  - 9.** Ramazonov B.R. Ismonov A.J. Natural conditions of soil formation and increasing productivity of the Aral Sea soils (on the example of the Kungrad region) Fundamental and applied research: from theory to practice: materials of the II international scientific and practical conference, timed / T.4. - Voronezh, 2018. - P. 235-240.
  - 10.** Koll. avtorov. 1975. PochviUzbekistana[Soils of Uzbekistan]. Tashkent. – c. 5-105

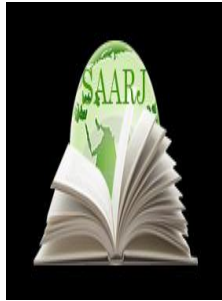

**ACADEMICIA**  
**An International**  
**Multidisciplinary**  
**Research Journal**  
 (Double Blind Refereed & Peer Reviewed Journal)



**DOI: 10.5958/2249-7137.2021.01225.8**

**PROBLEMATIC SITUATIONS IN HIGHER AUTHORITY  
 ADMINISTRATION AND WAYS TO IMPROVE OF DEALING WITH  
 THEM**

**Bekzod Shukhratovich Khaitov\* ; Nargiza Muzaffarovna Babaeva\*\***

\*Master's Student,  
 Kokand State Pedagogical Institute,  
 UZBEKISTAN

\* Associate Professor,  
 Scientific Supervisor, Candidate of Economical Sciences,  
 Kokand State Pedagogical Institute,  
 UZBEKISTAN

**ABSTRACT**

*The Uzbek dictionary characterizes the concept of academic conflict as follows: "Pedagogical conflict is a conflict between the teacher and the pupil, the master and the student, the teacher and the student, or the conflict, hostility, enmity, attitude, conflict, discord". Hatred, discord, strife, due to common quarrels happens. When people think of conflict, they cruel incidents such as hostility, terrorizing, aggression, strife. This article gives exhortation and guidance on the training of modern management staff.*

**KEYWORDS:** *Formal Teacher, Informal Teacher, Constructive Conflicts, Objective Conflicts, Subjective Conflicts.*

**INTRODUCTION**

Conflict is frequently alluded to as conflicting views, clashes that are expressed through intergroup or interpersonal connections related to obnoxious enthusiastic experiences.

From a psychological point of view, a situation that features a devastating effect on people is not the conflict itself, but their result. Conflicts cause negative sentiments in the human mind, such as fear, panic, and animosity. If these experiences are solid and last a long time, a protective reaction can develop and be reinforced in a person.

---

## THE MAIN FINDINGS AND RESULTS

Negative circumstances as a result of conflict cause certain changes in a person's sentiments, behaviors, thinking, and even character. These changes are shown in the behavior of the individual, spread to other situations in which the subject partakes, and begin to involve a wide extend of connections. For case, a person rose in an environment of fear and peril is more likely to afterward end up a source of the same environment. He indeed raises his children in such an environment or manages his subordinates in this style.

It was found that the post-conflict temperament swings in labor communities and the time it takes to calm down take up three times more time than the period of preparation for the conflict.

A study of the causes of conflict in communities has identified a number of components that create conflict. These include constrained labor resources, the interconnectedness of production issues, vulnerability about the future of the organization, dissatisfaction with communication inside the organization, low level of training, and so on.

*Constructive and destructive conflicts.* Conflict can play a positive role in community life in case the source of the struggle isn't hidden when contradiction is clear. This include of conflict is what scholars call the "constructiveness of strife." Constructive conflicts within the organization emerge, first of all, on the fundamental issues emerging from labor action. When there's strife of intrigue, for someone the working environment is vital, and the work they do is of awesome significance. At the same time, another representative sees personal non-work-related eagerly as a major issue. In this case, in case the issue that caused the strike is settled, this struggle will vanish. In any case, a conflict that emerges over any work can have a solid impact on a person's enthusiastic circle and show its claim damaging nature. Destructive conflict debilitates the effectiveness of the group.

*Types of conflicts.* The following basic types of conflict are distinguished:

- Personal;
- Interpersonal;
- Between an individual and a group;
- Intergroup;
- Social.

The leader encounters each of the enumerators listed in his or her management activities. In this regard, we will provide information on them below.

*Personal conflicts.* This type of conflict is sometimes referred to as internal conflict. This type of conflict is caused by internal conflicts of the individual, and the factors that lead to such differences can be divided into two main groups:

- 1) The needs and aspirations of a person are in conflict with the responsibilities he assumes;
- 2) Internal relatives as a result of a person's disobedience to the requirements imposed on him. As an example, we can recall the following situations that occur at the level of the organization: The employee wants to do something carefully, but the deadline for completion of the task is increasing. As a result, there is a conflict between the two desires, such as the desire to be on

time and a serious attitude to work. Hence, such a mismatch between a person's worldview and habits is at the heart of an internal conflict. Another example of an internal conflict is when an employee has difficulty getting an assignment from two managers at the same time and which one to do first. The cause of the conflict covered in these two examples was determined by the external environment.

*Interpersonal conflict.* This type of conflict is common in work communities. According to most managers, the only reason for such a conflict is the disproportion of employee character. However, the analysis of the circumstances of this conflict shows that the basis of interpersonal conflicts, in most cases, lies in objective reasons. One of these is the limited resources in the organization. For example, problems arising from the use of means of production, their ownership, adherence to working hours and discipline, and the demand for labor. Typically, any employee feels that such resources are needed by someone else, not themselves. When a dispute arises between a manager and an employee, the employee may feel that the amount of work allocated to him or she is unfair, and the manager may feel that the employee is looking at the job with indifference.

*Conflict between an individual and a group.* Within any group, norms of interaction, labor activity, and behavior are formed. Any member of the group must comply with the requirements arising from these norms. Deviation from the accepted norm is considered a negative event and causes a conflict between the individual and the group. This type of conflict occurs even between the leader and the employees who obey him. For example, a change in management style applied by a manager can, in many cases, lead to a conflict between him or her and his or her employees.

At the organizational level, most problems arise on the basis of intergroup and social conflicts. In resolving such conflicts, the leader will need the support of peers and assistants.

*Conflicts among groups.* One of the sources of this conflict is the existing tensions between formal and informal groups in the community. For example, conflicts between the management of the organization and employees, between informal groups within the department, between the administration and the trade union are examples of this.

Technologies for the development of effective management activities in the resolution of conflict situations of heads of educational institutions

Another group of reasons for the occurrence of conflict can include a system of perceptions that arise in human perception in a conflict situation. A.G.Shmelev, a Russian researcher, while studying the factors that cause conflicts in small groups, argues that the conflict situation escalates into a conflict mode with such a system of perceptions. In particular, in the "system of egocentric perceptions" that take place in human perception, the participant in the conflict puts his interests, goals and needs at the center of the whole situation. Such a person analyzes the consequences of the conflict only in terms of the satisfaction of his personal interests. People, things and events around them are perceived as a means to an end. Such an approach to a situation arising from a conflict of interest is the basis for further escalation of the conflict.

The third type of attitude that is formed in a conflict situation is debated as a "system of socio-centric perceptions". Such a system has a polycentric, i.e. multi-centric, appearance, unlike the previous two monocentric (single-centered) systems. In the "socio-centric system", the resolution

of the situation is in the interests of all parties to the conflict, and the person takes into account the needs of the majority in resolving the problem situation.

## CONCLUSION

*"You-I" information.* Usually, any participant in a conflict claims that their interests are being discriminated against and often tends to blame the other party as the cause of the conflict. In many cases, the development of a conflict situation goes from exposing the faults and shortcomings of the other party to mutual insults. The attention of the parties to the conflict is focused on the other person's personality and lifestyle. For example, "If you didn't do that, it wouldn't be the same result," "Did you forget again," "How many times should you be assigned this task?" It should be noted that the main form of communication in conflict escalation is the focus on the person and even the personality of the other person.

## REFERENCES

- [1] Azizxodjaeva N.N. (2003). *Pedagogical technologies and pedagogical skills*. – Tashkent: Finance. –p. 192
- [2] Al-Bukhari, Abu Abdullah Muhammad ibn Ismail. Hadith. Al-Jami as-Sahih (Reliable Collection). 4 books. Book 1. Translated from the Arabic by Z. Ismail. – Tashkent: Publishing house "Qomuslar". 1991. –p. 560.
- [3] Arzikulov D. Improving professional skills through psychological and pedagogical trainings. *Journal of Vocational education*. – Tashkent: 2002. Issue 4. – p. 28.
- [4] Askarova O.M., Hayitboev M., Nishonov S.M. (2008). *Pedagogy*. – Tashkent: Talqin. –p. 287.
- [5] *Atlas of new professions*. Moscow School of Management "SKOLKOVO". – Moscow. 2014. – p. 168.
- [6] *Information systems and technologies*. S.S. Gulomov et al. – Tashkent: Publishinghouse "Sharq". 2000. –p. 592.

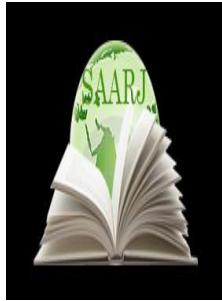

**ACADEMICIA**  
**An International**  
**Multidisciplinary**  
**Research Journal**  
 (Double Blind Refereed & Peer Reviewed Journal)



**DOI: 10.5958/2249-7137.2021.01226.X**

## HISTORY OF THE UZBEK NATIONAL THEATER AND MAKE-UP

**Feruzat Suratovna Jalilova\***

\*Associate Professor,  
 State Institute of Arts and Culture,  
 UZBEKISTAN

### ABSTRACT

*This article examines the history of the Uzbek national theater and the history of makeup. The purpose of the article is to analyze the study of the history of makeup and its appearance in the theater. Particular attention is paid to the work of the director and make-up artist in the performances. And also the founders of the Turon troupe consisted of such actors as Hasan Kary, Ishanhoja Khani, Sami Kary (Abdusame Ziyabov), Abdulla Avloni, Badriddin A'lamov, Shorahim domla Shokhinoyatov, Nizomiddin Khojaev, Shokirjan Rakhimsham, Kudzhamratzhaev Abdulaziz Khodjaev, Musakhon Mirzakhanov, Umarkul Anarkulov, Fusail Zhonboyev, Salimkhon Tillakhonov, Kudratulla Yunusiy, Tulagan Khuzhamyarov, Ubaydulla Kary Ergoziev. The article is devoted to the current problem of makeup.*

**KEYWORDS:** *Make-Up, Director, Performance, Actor, Stage, Play, Poster, Troupe, Study, Theater, Character, Drama, Comedy, Character, Role, Staging, Epic Heroisms.*

### INTRODUCTION

The history of the Uzbek theater is also the history of makeup. Because at the very beginning of the activity of the national theater, the first signs of makeup appeared, although they were completely simple.

In the middle of 1913, the first professional theater group was formed on the territory of Uzbekistan, which at the beginning of 1914 showed its first national play on stage, and thus officially began its activities as a theater troupe. Since at the beginning of the 20th century, Turkestan was under the rule of Tsarist Russia, the theatrical sphere had to submit to the dominant beliefs of the empire, in particular the registration of such a large cultural institution as a theater, and permission to operate it.



The troupe unofficially showed its first performances in June and July 1913. The head of Tashkent enlightenment Munavvar Kara Abdurashidkhanov actively participated in the organizational and propaganda activities of the creative group. In 1913, on August 8, the troupe presented its first performance "Tomosha Kechasi" in the garden of Sheikh Hovand Takhur. At that time, there were no national theaters in any city of the Turkestan Territory. In the Samarkand weekly magazine "Oyina", in circulation since November 14, 1913, it was published about the play "Padarkush", which was still not staged, despite permission from the author to stage it.

Beginning in December 1913, preparations were made in Tashkent for the showing of the work "Padarkush". In the process of creation, teachers of modern schools took an active part. Such representatives of the enlightenment as Chunonchi, Abdulla Avloni, Muxammadjon kary, Nizomiddin Khojaev, Shokirjon Rakhimiy showed their dedication in this matter. The Tatar intellectual Mukhamedyarov was directing the performance, prepared by Tashkent amateurs. But due to the delayed preparations, the production of the drama is delayed. At the beginning of 1914, Aliaskar Askarov arrived from Samarkand and took responsibility for the work of the director of the play. In February 1914, the play "Padarkush" is planned to be staged together with the Azerbaijani comedy "Khur-Khur".

First performance. On February 27, at seven o'clock in the evening, amateurs of the Tashkent theater officially begin showing their performances in the one thousand one hundred local hall of the Colosseum Theater in the New City of Tashkent. A poster issued for this reason indicated that the performance consisted of three parts.

In the first part - the screening of the play Padarkush, based on the play of the same name by Mahmudhoja Behbudi; in the second - the humorous scene "Khur-Khur" by the Azerbaijani actors Aliaskar Askarov, Guluzorkhonim and Shahbalov; in the third part it was said about "Milliy ukish va zhurlar", where it was envisaged to show a concert of eight numbers. Hafiz Mulla Tuychi, dancer of Kurbanhon, Mulla Ahmadjon tour, were supposed to participate in the concert, as well as read Avloni's poems "Turkiston faryodi" and "Tuy". At the end of the poster, the head of the evening, Abdulla Khoja, was indicated, and the director, Askarali Askarov. On that day, a theatrical performance was shown that met European criteria and also based on the traditions of national performances, which led to the beginning of theatrical art in Turkestan.

Abdullah Avloni. Beginning in 1915, the Turon troupe staged new examples of the emerging Uzbek playwright. For example, "The Unhappy Bridegroom" by A. Kadiri (1915), "The Oppressed Woman" by H. Muin (1916) took places from the troupe's repertoire. The troupe, starting from the first steps, strived for innovation and cooperation, for the formation as a professional team, for creative growth, for the development of the cultural and educational level of the people in difficult conditions, and for this it tried to present its bold initiative.

The basis of the "Turon" troupe was made up of such actors as Hasan Kary, Ishankhodja Khani, Sami Kary (Abdusame Ziyabov), Abdulla Avloni, Badriddin A'lamov, Shorahim domla Shokhinoyatov, Nizomiddin Khojaev, Bashirjan Rakhimi, Kudzhashullahruhruh, Musakhon Mirzakhanov, Umarkul Anarkulov, Fusail Zhonboev, Salimkhon Tillakhonov, Kudratulla Yunusiy, Tulagan Khujamyarov, Ubaydulla kary Ergoziev. Since 1916, they were joined by Sulaimon Khodjaev, Mannon Uygur, Gulom Zafari. Some scientific sources indicated that Abdurakhmon Akbarov, Yusuf Aliyev, Sadullohoja Tursunkhodjaev, Muso Azizov, Mirmulla Shermukhammedov, Mukhiddin Sharafiddinkhodjaev also worked in the troupe. By 1917, until

the revolution, "Turon" was a theater troupe, which consisted of about thirty permanent actors, directors Nizomiddin Khojaev, Abdulla Avloni, Badriddin Aylamov, with a registered charter, with a repertoire of works in the national and universal spirit, with winter and summer scenes city of Tashkent, and full of hope and challenges. She also served as the basis in the formation and development of the culture and traditions of European theater not only in Tashkent and on the territory of Uzbekistan, but also in the countries of Central Asia.

The coming to power of the Bolsheviks in 1917 had a negative impact on the development of the theatrical culture of the Uzbek people. Those events forced the recently opened national Uzbek theater to sharply change its course in a completely different direction. The remaining members of the already disbanded Turon troupe on the eve of 1917, Nizomiddin Khodjaev, Gulyam Zafari, Badriddin Alamov, Gazi Yunus, Shokirjon Rahimi and Kayum Ramazon, led by Mannon Uygur, decided to renew the Turon theater and continue its progressive and educational traditions.

But there were still no works that fully responded to the new requirements of the new government, therefore, in the period from March 1918 to September 1919, sixteen plays had to be shown at the Turon Theater, fifteen of which were one-act. Among these works were the musical pieces "Wish", "Bad Son", "The Merciful Apprentice" by the poet and composer G. Zafari.

In the 1920s, they served as the basis for the formation of an Uzbek children's playwright and musical drama theater. In 1919, the Uzbek troupe named after S. Karl Marx under the leadership of M. Uygur. In March 1920, after merging with the amateur club "Tarakki", the Exemplary Regional Drama Troupe was created. The Tatar theater figure Kamal I was invited to the troupe as a director. And E. Bobozhonov, M. Korieva, O. Jalilov, S. Olimov, M. Mukhamedov, A. Ardobus (Ibragimov), Sh. Nazhmiddinov formed the creative basis of the troupe. Before moving to the capital (at that time the city of Samarkand) in 1925, the troupe set goals: rapprochement to the life of the people and the country, addressing the main exciting life issues of society. Released on March 26, 1920, the drama "Poisonous Life" by Hamza, the musical drama "Halima" by G. Zafari played a significant role. And two years later, on June 20, 1924, "Farhad and Shirin" by Alisher Navoi (based on Khurshid's staging) was shown, and on December 15 - Leili and Majnun by Fizuli (based on drama and music by Uziyar Khodjibekov).

In 1929 the troupe moved from Samarkand to Tashkent and was transformed into the State Uzbek Drama Theater named after A. Hamza. In the 30s of the twentieth century, the theater achieved significant success. This period was also characterized by the formation of art schools for actors and directors. The best works of the Uzbek playwright determined the development of the Uzbek theatrical art, on the stage - the theme of the principles of nationality. Ideologically and artistically developed performances, a variety of colors and solutions in them, are also associated with the achievements of Uygur and Babadzhonov in directing. Some of the best local, Russian, Soviet and Western European plays were in the theater's repertoire: Khamza's Bai and the Laborer (1939), Gogol's Inspector General (1935, 1952), Ismailov's Rustam (1934), Fatkhulin's Mask Torn Off (1932), "Honor and Love" (1936) by K. Yashen, "Hamlet" (1935, 1939, 1940) and "Othello" (1941) by Shakespeare and other performances became grandiose achievements of the Uzbek theater. In 1933, the theater was awarded the title of academic, and in 1937 was awarded the Lenin Order.

During the Second World War (1941 - 1945) patriotic performances "Death to the occupants" by Yashen, "Mother" by Uygun, "Flight of the Eagle" by I. Sultan, reflecting the heroism of the Uzbek people in the past, "Mukanna" Alimjan and "Jalaliddin Manguberdi" by Shaikhzoda were shown together with temporarily arrived Russian and Ukrainian representatives of the theater. In the post-war years, the theater's repertoire was enriched with works of contemporary themes. Developing folk heroic and romantic traditions close to Uzbek art, the theater created performances that deeply revealed the social essence of the characters. In such works as "For those at sea" by Lavrenev, "Russian question" by Smolov, "General Rakhimov" by Yashen, magnificent images of the participants in the war were created. During these years, performances were shown in various genres that presented the images of the Soviet person building communism: "The Honor of the Family" by Mukhtarov, "Song of Life", "Navbahor", "Hurriyat" by Uigun, "Silk Suzane" by Kakhkhara, "Makar Dubrava" by A. Korneichuk, "Secrets of the Heart" by B. Rakhmonov and others. The theme of the struggle of the Eastern peoples against colonial oppression was also included in the repertoire of the theater: "A Story about Turkey", "A Legend of Love" by N. Hikmet, "Daughter of the Ganges" based on the novel by R. Tagore "Downfall", "Algeria is my homeland!" M. Diba. Deeply philosophical humanistic confession of socially and historically generalized images are expressed in the performances "Alisher Navoi" by Uigun and Sultanov (1945 - 1948), "Kremlin chimes" by Pogodin (1947), "Family" by Popov (1952), "Guilty without guilt" by A. N Ostrovsky, "Bourgeois", "Vassa Zheleznova" by M. Gorky, "Dawn of the East" by Safarov (1951), "Inspector General" by Gogol (1952), "Julius Caesar" by Shakespeare (1958), "Guiding Star" by Yashen (1958), Schiller's "Robbers".

In the early 50s, young actors Z. Mukhammadzhanov, Y. Abdullaeva, E. Malikbaeva, T. Azizov, Y. Akhmedov, I. Alieva, R. Ibragimova and others joined the theater. A.I. Ginzburg (1951 - 1958, 1960 - 1965, 1971 - 1976) and T. Khuzhaev (1958 - 1960, 1966 - 1971) played the role of the chief director.

During this period, the change of generations intensified in the theater. After T. Khojaev, the director was A. Kobulov, N. Otaboev, B. Yuldashev, R. Khamidov, H. Apponov, H. Kuchkarov, S. Kaprielov, T. Isroilov, L. Fayziev. T. Azizov, P. Saidkasymov, O. Yunusov, T. Yusupova, R. Ibragimova, O. Norboeva, G. Dzhamilova, D. Ismoilova, M. Ibragimova, G. Zakirova, T. Todzhiev, T. Oripov, T. Karimov, R. Avazov, Y. Akhmedov, E. Komilov, T. Muminov, S. Umarov, Y. Sadiev, J. Zokirov, M. Abdukunduzov, G. Khodzhiev became active participants in the theater. In the 1960s - 1970s, the theater staged epic heroisms, social psychological drama, comedy, journalistically poignant and satirical, lyrical plays. The best performances of that time of the theater were "People with Faith" by Sultanov (1960), "Mirza Ulugbek" by Sheikhzade (1961), "Optimistic Tragedy" by V. Vishnevsky, "Voice from the Coffin", "My Dear Mothers" by A. Kakhkhara, "Poplar mine in a red scarf" by Aitmatov (1964), "Bloody Mirage" by Azimov (1964), "Stolen Life" by Morimoto Kaoru, "King Lear" by Shakespeare, "Parvona", "Flight" by Uigun, "Enemies" by M. Gorky, "Oedipus the King" by Sophocles (1969), "Mary Stuart" by Schiller, "The Sixth of July" by Shatrov, "Dawn of the Revolution" by Yashen (1973), "Don't Throw Fire, Prometheus!" M. Karim, "Living Corpse" by L. Tolstoy, "Before Sunset" by Gauntmann and others.

After the proclamation of independence of Uzbekistan, dramatic changes took place in the activities of the theater. Now the creative group had the right to freely conduct activities and compose their own repertoire. As a result, the drama Sahibkiran Temur K. Marlo was staged for

the first time on the Uzbek stage. Tesha Muminov, Madina Mukhtorova, Saida Rametova, Nadira Makhmudova, Uchkun Tillaev and others became the leading actors of the theater. The theater was directed by Valijon Umarov (2005). On September 21, 2001, a decree of the President of the Republic of Uzbekistan was issued on assigning the status of "National Theater" to the Uzbek Academic Drama Theater named after Khamza and calling it "Uzbek National Academic Drama Theater".

In January 2014, the President signed a decree "On the celebration of the 100th anniversary of the Uzbek National Academic Drama Theater" and on November 28, 2014, the theater celebrated its 100th anniversary. President of the Republic of Uzbekistan Islam Karimov congratulated and awarded the theater workers with titles, medals and orders. In accordance with the decree, the theater actor Asadillo Nabiev was awarded the title "Honored Artist of the Republic of Uzbekistan", actress Tuti Yusupova was awarded the order "Fidokorona Hizmatlari Uchun", actors Dildorkhan Ikramova and Fatkhulla Masudov - the order "Mehnat Shukhrati". The theater actor Abduraim Abduvahobov and artists Babaniyaz Kurbanov and Svetlana Tsoi were awarded the Dustlik order, the actor Mirolim Kilichov and the head of the theater lighting department Mahmudjon Aripjanov were awarded the Shukhrat medal. In 2001 the theater building was reconstructed. After the renovation, the theater completely changed its appearance, equipped with new equipment. There is a specially equipped room for make-up and is equipped with modern technology, as well as separate dressing rooms.

## REFERENCES

1. Avdeev A.D. The origin of the theater. M. - L., "Art", 1959.
2. Resurrection A. Scenic makeup. SPb., 1910.
3. Stanislavsky K.S. My life is in art. M., "Art", 1948.
4. Jalilova F. Makeup. - UzDSI, 2008
5. Jalilova F. Makeup. - UzDSI, 2015
6. Anjan A., Volchansky. Makeup va cinema. - M. 1957.
7. Ismoilov M. Sana pardozi. - T.2004.
8. Shkolnikov. Stage makeup basics. - M. 1957.
9. Vipuskakh School of Inventing Art 10. - M. 1963.
10. Sundukova V.N., Akhmedova Z.A. K.S. Stanislavsky. T. 2012.

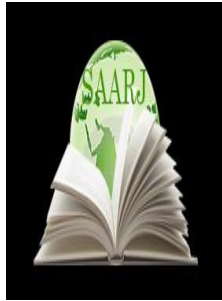

**ACADEMICIA**  
**An International**  
**Multidisciplinary**  
**Research Journal**  
(Double Blind Refereed & Peer Reviewed Journal)



DOI: **10.5958/2249-7137.2021.01227.1**

**THE ROLE OF DIFFERENTIAL CALCULUS AND DIFFERENTIAL EQUATIONS IN SOLVING PRACTICAL PROBLEMS AIMED AT IMPROVING THE PROFESSIONAL TRAINING OF CIVIL ENGINEERS**

**Komiljon Kurbonalievich Turgunov\***

\*Senior Teacher,  
Department of “Mathematics and Natural Sciences”,  
Tashkent Institute of Architecture and Construction,  
UZBEKISTAN

**ABSTRACT**

*The article explores the solution of practical problems using derivative and differential equations in improving the professional training of civil engineers through a high level of teaching mathematics, which is fundamental in the field of technical education. At the same time, practical problems are given and mathematical solutions are given.*

**KEYWORDS:** *Mathematical Model, Product, Maximum And Minimum Values Of Function, Differential Equations, Equilibrium Equation, Air Exchange Equation, Heat Dissipation Intensity Of Concrete, Free Vibration Processes In Construction.*

**INTRODUCTION**

In today's fast-paced world, higher education institutions are able to deal with problematic situations with in-depth theoretical and practical knowledge, as well as the ability to work independently in their chosen field, independently improve their knowledge and skills, and take a creative approach. The task is to train specialists who can identify, analyze and adapt quickly to the conditions.

It is impossible to train modern personnel without raising the level of knowledge in mathematics, which is considered fundamental. Therefore, the science of mathematics is of great importance in the formation of a wide range of builders, architects and designers. In addition, mathematics serves as a tool for the successful mastery of many techniques and special disciplines related to economics. In particular, the use of professionally oriented tasks in the teaching of mathematics to students of construction specialties allows forming the necessary professional qualities of the future specialist.

---

## THE MAIN FINDINGS AND RESULTS

The purpose of studying mathematics in higher education in the field of engineering (architecture and construction) is to acquaint students with the mathematical bases used in solving theoretical and practical economic, technical problems, to develop logical thinking skills, to get used to independent study of scientific literature, raising the level of general knowledge, the ability to analyze technical processes, practical problems with mathematical methods and to translate projects into the language of mathematics. The study of economic processes in construction, industry, agriculture and other areas is carried out using mathematical models. In order to be able to construct mathematical models of these processes and to be able to economically analyze the constructed models, the future specialist must have sufficient mathematical knowledge.

The main requirements for the mathematical training of a civil engineer in accordance with the program of mathematical science are:

- Strict assimilation of basic theoretical concepts of mathematics;
- understand the definitions, affirmations and theorems given in the mathematics course;
- be able to apply basic mathematical facts, formulas in practice;
- understand the relationship of mathematical models with the considered material phenomena;
- Analyze and interpret the results in accordance with the practical guidelines.

The above requirements for the mathematical training of a civil engineer imply not only to equip students with a certain set of mathematical knowledge and methods, but also to consider their practical application.

Thus, a career-oriented problem is a mathematical problem, the condition and requirement of which determines the model of a particular situation that arises in the professional activity of a civil engineer, and the study of this situation with the help of mathematics contributes to professional development.

The above allows you to formulate the requirements for the professionally oriented tasks used in the mathematical training of the future builder:

- the issue should describe the situation that arises in the professional activity of a civil engineer;
- The assignment should have the unknown properties of some professional object or event, which should be studied according to the known properties available using mathematical tools;
- In solving problems, the construction engineer should help to master the mathematical knowledge, techniques and methods that form the basis of his professional activity;
- Tasks should ensure the mastery of the interaction of mathematics with general technical and special disciplines;
- The content of a professionally oriented mathematical problem determines the propaedeutic stage of the study of the concepts of special disciplines;
- Solving a practical problem should ensure the mathematical and professional development of the civil engineer's personality.

Here are some examples of professionally oriented tasks that use mathematical hardware.

1. In the practice of designing a network of highways, it is often necessary to design branching nodes.

The location of the intersection and the relative condition of the roads passing through it are determined by a set of economic and geographical conditions, but the first step in solving this problem is to save only the time spent on transportation. Therefore, the following auxiliary task is solved first.

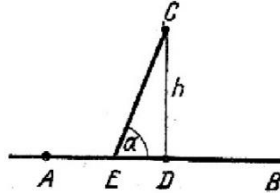

That should be the angle of contact of the road (CE) with the highway (AB)  $\alpha$  to minimize the time spent on transportation along the AEC route.

Speed  $v_m$  on the highway and  $v_y$  on the roundabout.  $v_m > v_y$

Draw a CD of length  $h$  perpendicular to the line AB through point C. Let the length of the section AD is  $l$ .

It is known that  $CE = \frac{h}{\sin \alpha}$  and  $DE = h \operatorname{ctg} \alpha$   $CE = \frac{h}{\sin \alpha}$ .

On the AEC route we find the travel time of the car:

$$t = \frac{l}{v_m} - \frac{h \operatorname{ctg} \alpha}{v_m} + \frac{h}{v_y \sin \alpha}$$

Point A is conditionally assigned, only it determines the direction of movement along the trunk.

Angle  $\alpha$  can vary in the range of  $(0; \frac{\pi}{2})$ .

We came to the problem of finding the smallest value of  $(0; \frac{\pi}{2})$  intervals of  $t(\alpha)$  functions.

We take this  $t(\alpha)$ .

$$t'(\alpha) = \frac{h}{v_d \sin^2 \alpha} \left( \frac{v_d}{v_m} - \cos \alpha \right).$$

Since  $0 < \frac{v_y}{v_m} < 1$  and  $\alpha \in (0; \frac{\pi}{2})$ , we see that  $\alpha_0 = \arccos \frac{v_y}{v_m}$  is  $t'(\alpha) = 0$ .

Since  $\alpha \in (\alpha_0; \frac{\pi}{2})$  is  $\alpha \in (0; \alpha_0)$  and  $t'(\alpha) < 0$ , we see that  $\alpha \in (0; \alpha_0]$  functions decrease in  $t'(\alpha) > 0$  and  $\alpha \in [\alpha_0; \frac{\pi}{2})$  functions increase in  $t(\alpha)$ . So  $t(\alpha)$  functions reach the smallest value in  $\alpha_0 = \arccos \frac{v_y}{v_m}$ .

2. The length of the boundary of the cross-sectional area of the channel is called the wet perimeter of the channel. Theoretical calculations and experimental cross-section revealed that the smallest wetted channels of all channels differed in maximum permeability and at the same time in minimum filtration. Experts note that such channels have the most hydraulically optimal profile. In reclamation practice, canals or trays are often built in the form of rectangular, triangular, trapezoidal and circular segments. Therefore, it is interesting to calculate the most hydraulically profitable profile for channels of this shape.

a) What is the ratio of the width and depth of a channel with a rectangular cross-section to have the most hydraulically optimal profile?

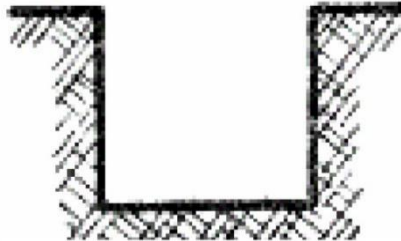

Let the width of the channel be  $x$  and the cross-sectional area be  $\omega$ .

The wetted perimeter of the canal is  $\lambda(x) = x + \frac{2\omega}{x}$ .

We come to the problem of finding the smallest value of function  $\lambda(x)$  in the interval  $(0; \infty)$ .

That can be  $\lambda'(x) = \frac{x^2 - 2\omega}{x^2}$ .

Solve  $\lambda'(x) = 0$  equations to get  $x = \sqrt{2\omega}$ .



Since  $x \in (0; \sqrt{2\omega})$  is  $\lambda'(x) < 0$  and  $x \in (\sqrt{2\omega}; \infty)$  is  $\lambda'(x) > 0$ ,  $\lambda(x)$  functions have the lowest value at  $x = \sqrt{2\omega}$ . This means that the width of the channel should be  $\sqrt{2\omega}$  and the depth  $\frac{\omega}{\sqrt{2\omega}}$ . The ratio sought is  $\frac{1}{2}$ .

b) The angle of inclination of a channel with a cross-sectional area of  $\omega$  and an equilateral trapezoid is  $\alpha$  ( $\text{ctg} \alpha = m$ ). What is the ratio of the width of the bottom of the channel to its depth, which has the most hydraulically optimal profile?

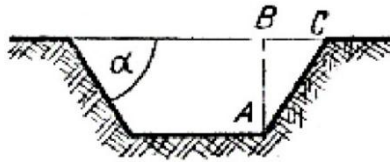

Let the bottom of the channel be  $b$  feet wide and  $h$  feet deep.

In that case  $BC = h \text{ctg} \alpha = hm$ ,  $AC = \sqrt{AB^2 + BC^2} = h\sqrt{1+m^2}$

Cross-sectional area  $\omega = \frac{1}{2}h(2b + 2hm) = bh + mh^2$ .

The wetted perimeter of the channel is  $\lambda = b + 2AC = b + 2h\sqrt{1+m^2}$ .

We find  $b = \frac{\omega - mh^2}{h}$  on the surface of the cross section.

As a result, we get  $\lambda(h) = \frac{\omega}{h} - mh + 2h\sqrt{1+m^2}$ .

We come to the problem of finding the smallest value of the function  $\lambda(h)$  -in the range  $(0; \infty)$

. Solving using the product we get  $h_0 = \sqrt{\frac{\omega}{2\sqrt{1+m^2} - m}}$  results.

The resulting ratio is  $\frac{b}{h_0} = 2\sqrt{1+m^2} - m$ .

c) Let the cross-sectional area of the channel be a segment.

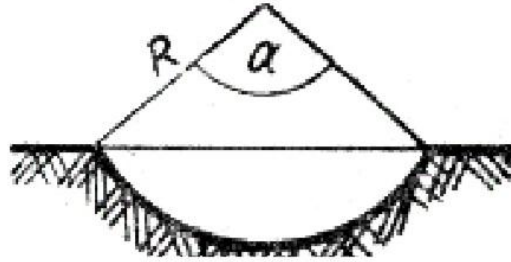

What is the central hydraulic profile of the channel at a central angle of  $\alpha$  ?

Let be the radius of circle  $R$  . The cross-sectional area of the channel is

$$\omega = S_{\text{sek}} - S_{\Delta} = \frac{R^2}{2}(\alpha - \sin \alpha) . \text{ From it } R = \sqrt{\frac{2\omega}{\alpha - \sin \alpha}} .$$

$$\text{Wet perimeter of the channel } \lambda(\alpha) = R\alpha = \sqrt{2\omega} \sqrt{\frac{\alpha^2}{\alpha - \sin \alpha}} .$$

Instead of checking the  $\lambda(\alpha)$  -function, we can find that the simpler

$$f(\alpha) = \frac{\alpha^2}{\alpha - \sin \alpha} \text{ function is } \alpha = \pi \text{ by checking the minimum using the product.}$$

This means that the cross-sectional area of the channel should be a semicircle.

3. Mixing problems are common in the sewage system (water supply, sewerage, chemical industry).

We explain how to solve a basic problem involving a single reservoir.

The tank in the picture contains 1000 liters of water, which dissolves 100 kg of salt.

The mixture (salted water) operates at a rate of 10 liters / min and contains 5 kg of dissolved salt. The mixture in the tank is kept flat by stirring. The tank runs out in 10 minutes. Find the amount of salt in the container at any time  $t$  .

Let us determine the amount of salt t time  $y(t)$  in the tank.

Its  $t$  time changes rate.

$$y'(t) = \text{Salt infiltration rate} - \text{Salt exit rate}$$

5 kg of dissolved salt is 50 kg of dissolved salt in 10 minutes.

As 10 liters of mixture is expelled every minute,  $\frac{10}{1000} = 0.01$  parts of the total amount is expelled. The result is  $0.01y(t)$  salts.

In the above we come to the following simple differential equation.

$y' = 50 - 0.01y$ . Solve the equation for which this variable is divisible by  $\frac{dy}{dt} = -0.01(-5000 + y)$

$$\frac{dy}{y-5000} = -0.01dt; \ln|y-5000| = -0.01t + \ln C \Rightarrow y-5000 = Ce^{-0.01t}.$$

We find the variable using  $y(0) = 100$  (initially 100 kg of salt) starting balls.

$$100 - 5000 = Ce^0 \Rightarrow C = -4900$$

We have  $y = 5000 - 4900e^{-0.01t}$  solutions.

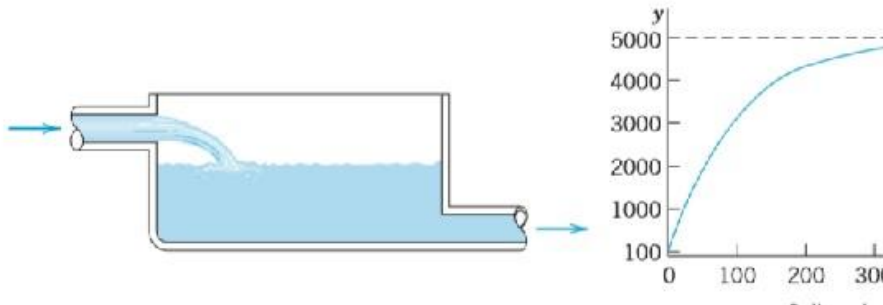

4. The rate of heat dissipation of concrete in proportion to the amount of heat released at a given

time:  $q = \frac{dQ}{d\tau} = m(Q_{\max} - Q)$  views.

With complete hydration of cement  $Q_{\max}$ , the maximum amount of heat that can be released in the concrete of this composition, parameter  $m$ , varies depending on the type of cement (for concrete in cement it is in the range of 0.010 - 0.015 1 / h). Determine the heat generation function of concrete.

5. In construction work, great attention should be paid to various issues related to vibration. Earthquakes can shake buildings, their structures, and the foundations on which engines and machinery are installed. The buildings in which they are located must be constructed in such a way as to exclude vibrations for the normal operation of the mechanisms and the integrity of the structure. All the practical problems associated with vibrations, despite their natural properties, are combined with general principles and methods that constitute the essence of the theory of vibrations. Vibration processes, which are practically completely different in nature and nature, are characterized by differential equations of motion that are uniform in form. The following

differential equation  $x''(t) + 2hx'(t) + \omega_0^2 x(t) = 0$ ,  $h = \frac{b}{2m}$ ,  $\omega_0^2 = \frac{k}{m}$  represents the process of free oscillation in construction constructions.

The solution of this equation is illustrated in the figure.

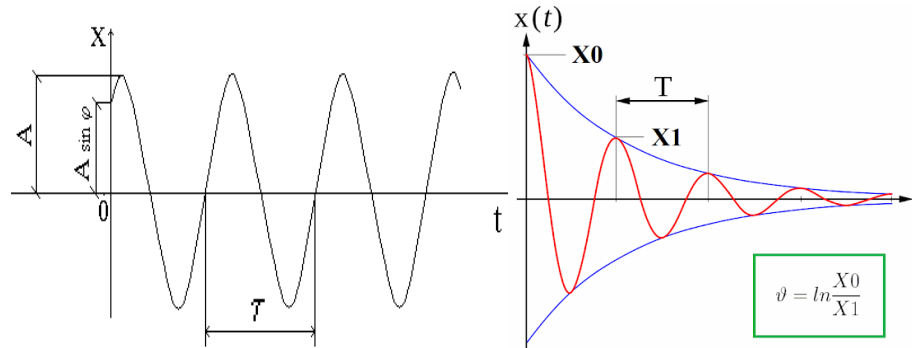

The specificity of each specific problem is determined by the constants included in these equations, which depend on the physical nature of the phenomenon being studied. Using the given parameters of the problem (construction), we can analyze the integral curve and determine the nature of the oscillation.

6. In winter, the daytime temperature in a particular office building is maintained at 24 °C.

The heating was turned off at 10:00 a.m. and turned on again at 6:00 p.m. At 14:00 on a certain day, the temperature inside the building was found to be at 20 °C. The outside air temperature was 18 °C at 10:00 a.m., and dropped to 10 °C at 6:00 p.m. What was the temperature inside the building when the heat was turned on at 6:00 in the morning?

## CONCLUSION

Analysis of the solution to the problem allows determining the degree of formation of the professional qualities of the construction engineer personality. Along with providing professional motivation, it strengthens the connection between mathematics and practice.

The practice of teaching in technical higher education institutions shows that the educational process, organized in terms of the regular demonstration of the professional direction of students' mathematical training, shapes the professional qualities of the individual. The specialist will always be able to continue the education in the right direction with a good knowledge base.

## REFERENCES

- [1] Erwing Kreyszig, Herbert Kreyszig, Edward Normuton. (2011). *Advanced engineering Mathematics*. – New York, Copyright.
- [2] C.H.Edwards, D.E.Penney. *Elementary Differential Equations*. Upper Saddle River, New Jersey 07458, 2008.
- [3] I.Rikhsiboev, N.S.Mohamed. (2019). *Engineering mathematics 2*. PenerbitmentariTanjongmalim. – Perak.
- [4] Sh.R.Xurramov. (2018). *Higher Mathematics*. – Tashkent: “Tafakkur”, Volume 1, Volume 2. (Sh.R.Xurramov. Oliy matematika T: “Tafakkur”, 1-jild, 2-jild, 2018.)
- [5] U.A.Rozikov, N.H.Mamatova. (2019). *“Mathematics and life”*. – Tashkent. Fan. (U.A.Rozikov, N.H.Mamatova "Matematikavaturmush" Toshkent :ФАН, 2019.)
- [6] Turgunov K.Q. Jumaev D.I. (2021). *“Higher Mathematics”* (Practical issues for civil engineers, design architects) – Tashkent: Tashkent Institute of Architecture and Construction.

(Turg'unov K.Q. Jumaev D.I. "Oliy matematika" (Quruvchi muhandislar, loyihalovchi arxitektorlar uchun amaliy masalalar) T.: TAQI,2021.)

[7] Sh.R.Khurramov, K.K.Turgunov. (2015). *Lectures on Higher Mathematics*. – Tashkent: Tashkent Institute of Architecture and Construction. (Sh.R.Xurramov, K.K.Turg'unov. "Oliymatematikama'ruzalar". T: TAQI, 2015 y.)

[8] Krymskaya Yu.A., Titova E.I., Yachinova S.N. (2014). *Professional training of builders through solving mathematical problems*. Modern problems of science and education. No. 2.

[9] Kuimova, E.I. (2014). *Applied orientation of the course of mathematics in the construction university*. Young scientist. No. 11 (70).

[10] Ryabushko A.P., Jur T.A. (2016-2018). *Higher mathematics: theory and problems: textbook*. At part 5: parts 1, 2, 3. - Minsk. "Higher School".

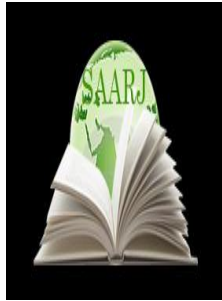

**ACADEMICIA**  
**An International  
 Multidisciplinary  
 Research Journal**  
 (Double Blind Refereed & Peer Reviewed Journal)



**DOI: 10.5958/2249-7137.2021.01228.3**

**THE NEED FOR A SPEECH DETECTION PROGRAM IN THE PROCESS  
 OF SOCIAL INTEGRATION**

**Munavvara Abdujabbarovna Kurbanova\***

\*Associate Professor,  
 Doctor of Philological Sciences,  
 Tashkent State University of Uzbek Language and Literature named after Alisher Navoi,  
 UZBEKISTAN

**ABSTRACT**

*The article is devoted to the development of software for computer linguistics, which highlights the level of research on the problem in world and Uzbek linguistics. Types of speech-related computer programs according to the methods of creation, technology and function are discussed. The study discusses the role of speech recognition software in the development of Uzbek computer linguistics, the mechanism and possibilities of creating a program for digitizing voice messages.*

**KEYWORDS:** *Language, Speech, Computer Linguistics, Speech Synthesizer, Speech Recognition Software, Artificial Intelligence, Audio Information, Digital Technology, Linguistic Software, Speech Corpus.*

**INTRODUCTION**

Ensuring the integration of language into modern media has become one of the priorities of socio-political activities, with a special focus on the development of a system of economic and cultural relations based on digital technologies. The results of research in computer linguistics are extremely important for innovative solutions to problems in this area. To date, a number of scientific and practical results have been achieved in world computer linguistics: an automatic translation system in natural language, an automatic search system for textual information, automatic analysis and synthesis of spoken speech, optimized human-machine (computer) communication, natural language processing (Natural Language Processing) system was formed. In the world of computer linguistics, the implementation of research such as text editing software, speech synthesizer, text corpus, software for linguistic-statistical analysis of texts, abstracting texts has contributed to the creation of large-scale linguistic databases. [1]

M.Ayimbetov [2, 47], S.Rizaev [3, 50], S.Muhamedov, A.Pulatov, S.Muhamedova, A.Rahimov, N.Abdurahmanova, who conducted linguostatistical researches on the basis of Uzbek language materials in the formation of computer linguistics in our country, The scientific researches of M.Abjalova are of special importance. S.Muhamedov and R.Piotrovsky's study "Engineering Linguistics [4, 25] and the experience of system-statistical research of Uzbek texts" [5, 420] discusses linguistic models, modeling and its general principles.

N.Abdurahmanova's research draws conclusions on the creation of linguistic support for machine translation, provides morphological and syntactic models of Uzbek and English, bilingual affixes, morphological dictionary, linguistic support of verb phrases, simplicity of English translation of models, based on the principles of morphological, syntactic-semantic analysis of texts for machine translation, developed recommendations for the coordination of paradigmatic (associative) relations on the principles of linguistic software for electronic dictionaries and software [6, 141-148].

The research conducted by M. Abjalova created the theoretical basis for the formation of the linguistic support of the system of automatic editing and analysis in Uzbek computer linguistics; the principles of morpheme valence, categorization, syntagmatic and methodological separation of words in the formation of the linguistic supply of automatic editing and analysis are developed, based on the importance of linguistic module and modulation; the provision of grammatical categories of the Uzbek language on official and scientific texts, grouping by word groups, the formation of models of connection by conjugation, adaptation and management in the sentence structure; graphic editing, morphological and syntactic analysis modules have been developed to provide automatic editing / analysis technology and software excellence [7, 104-106].

In recent years, in Uzbek computer linguistics, special attention is paid to the development of speech-related programs. In particular, as part of a practical research project at the AlisherNavoi Tashkent State University of Uzbek Language and Literature, a program was developed to translate the Uzbek text into a voice message - the first interpretation of the national speech synthesizer (M.Kurbanova, B.Mahsudov, E.Isoev, 2020), TTSuzbot telegram launched online via the bot. This software product is a user-friendly interface, especially for blind people to work independently with electronic text in Uzbek.

## **THE MAIN FINDINGS AND RESULTS**

Speech-related computer programs also play an important role in translating a voice message into text. This process is carried out through the speech recognition system [8]. This system is a technology designed to be able to receive verbal expressions of all level units of a program or machine language system and to convert them into a machine-readable format. Although there are interpretations of speech recognition software in English, Russian, Japanese, Korean, Chinese and other languages in world computer linguistics, this issue is one of the problems in Uzbek computer linguistics.

The first device for voice recognition was created in 1952, which detected numbers pronounced by humans. In 1963, a miniature detection device called the "Septron", a fiber-optic memory device developed by engineers at Sperry Corporation, was introduced in the United States.

They served to carry out this or that sequence of actions according to certain sentences pronounced by the human operator. “Septrons” are designed to automate voice dialing in the recorded wired area and to automatically record the text that is pronounced on the teletype (in the voice control of complex military equipment); aviation (in the creation of “smart avionics” subject to the orders of pilots and crew members), used in automated control systems.

Commercial programs for speech recognition originated in the 1990s. Typically, they are used by users who cannot type large amounts of text because of a hand injury. These programs (e.g., Voice Navigator) [9] convert the user's voice to text.

It is well known that speech recognition software is widely used in search engines in the global network. Initially, Google researchers developed a voice search for the Chrome Internet browser and the Android mobile device. Sophisticated technologies have been added to the Google search engine's voice software for Android and Apple Phones. The user can use them to press a phone button and express an optional question through sounds. The audio is then converted to a digital file that is intelligible to the software and sent to a Google server.

An important aspect of Microsoft-Tell Me, which serves as a speech recognition program, is the natural interaction of tools used in daily activities. “Tell me” works on the basis of human voice, which means that the user can send a voice message and receive any information on a mobile device. In this case, the user says a message; the phone receives this information in the form of text. South Korean Information Technology Research Institute in collaboration with Google search engine English, Korean and Chinese speech recognition device and developed voice technology that allows viewers to search for a television program using the IPTV system. The advantage of these technologies is that they add many applications to the automatic speech recognition program for the “provision of voice functions”.

Innovative technologies require the creation of speech corpora at the initial stage of the formation of a speech recognition system based on modern research methods. To do this, tens of thousands of different types of sentences are selected according to the options of phonemes available in the language, adapted to different speech styles, structure, purpose of expression, and their audio database is created. Because each person's voice is individual and the program is not limited to recognizing only the same voice, each speech in the database is read by several speakers who differ in factors such as age, gender, and region.

Unlike audiobooks, there are certain technical requirements for this program, in the process of preparing audio information on speech parameters, it is necessary to remove the noise in it using a sound processing program. Each sentence and its phonetic expression are stored in a separate file and compared with each other using machine learning technology. To do this, you will also need to include transcripts of linguistic materials in the program database.

Pronunciation and spelling dictionaries serve as a valuable lexicographic source in the formation of the speech recognition system. When compiling dictionaries for the program, special attention should be paid to the orthography of words. Machine learning technology determines the specific phonetic laws, orthopedic norms, and linguistic features in general through the practically independent study of language.



At the next stage of the activity, acoustic and linguistic models will be developed and program algorithms will be developed based on the results obtained in this regard. This creates the initial interpretation of the speech recognition program.

Voice recognition technology is one of the fastest growing areas of artificial intelligence. This technology is improving qualitatively in the XXI century. As a result, new approaches to the processing of natural language are emerging.

## CONCLUSION

Speech recognition software Voice control of mobile phones and other automated technical devices by persons with limited hand movements; voice input and editing of text on a computer; independent use of search engines in the global network; providing information and advice, ordering for branded services; conducting public surveys, conducting surveys, reading audio sources by people with hearing impairments into text, entering the diagnoses of patients in the form of text by voice on an electronic record sheet, preparation of audio recordings of interviews, text of meeting minutes and transcripts, teaching students to pronounce correctly, plays an important role in increasing their literacy rate. In this regard, the creation of an interpretation of the speech recognition program in our national language is one of the urgent tasks in Uzbek computer linguistics.

## REFERENCES

- [1] Rakhimov A. (2011). *Fundamentals of computer linguistics*. – Tashkent. (Rahimov A. Kompyuter lingvistikasi asoslari. – Toshkent, 2011.)
- [2] Aiyymbetov M.K. (1997). *Problems and methods of quantitative-typological measurement of the proximity of the Turkic languages (based on the materials of the Karakalpak, Kazakh and Uzbek languages)*: Author's abstract. Doctor of Philological Sciences. Diss. – Tashkent.
- [3] Rizaev S. (2008). *Linguo-static study of the Uzbek language*: Doctor of Philological Sciences. Diss. – Tashkent.
- [4] Mukhamedov S.A. (1980). *Static analysis of the lexico-morphological structure of Uzbek newspaper texts*: Author's abstract. Diss. Candidate Philological Sciences. - Tashkent. – p. 25.
- [5] Bektayev K.B., Piatrovsky R.G. (1997). *Mathematical linguistics*. – Moscow. Higher school. – p. 420.
- [6] Abdurahmonova N. (2017). Modeling method in machine translation. Problems of theoretical assumptions of linguistics and methodology in the period of globalization. *International distance conference*. – Tashkent.
- [7] Abjalova M. (2018). *Linguistic modules of text editing and analysis software*. Current issues of Uzbek linguistics. – Tashkent. Tashkent State Pedagogical University named after Nizami.
- [8] Kurbanova M.A.,
- [9] Speech recognition. <https://cloud.yandex.ru/docs/speechkit/stt/>
- [10] Technology & Engineering Emmy Winners Announced - Yahoo [www.yahoo.com](http://www.yahoo.com)

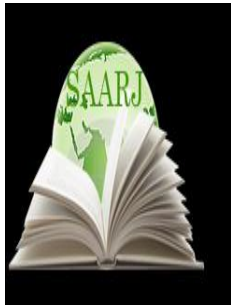

**ACADEMICIA**  
**An International**  
**Multidisciplinary**  
**Research Journal**  
 (Double Blind Refereed & Peer Reviewed Journal)



**DOI: 10.5958/2249-7137.2021.01215.5**

## CRITERIA FOR THE FORMATION OF INNOVATIVE MENTALITY AND SPIRITUAL AND MORAL QUALITIES OF YOUNG PEOPLE

**Rajabboev Jurabek\***

\*Student,  
 Department of National Idea,  
 Fundamentals of Spirituality and Legal Education,  
 Urgench State University, Urgench, UZBEKISTAN  
 Email id: sv997710@gmail.com

### ABSTRACT

*The paper is devoted to fostering the innovative thinking of students in technical and scientific spheres. The research, aimed at finding the ways for fostering the students' innovative thinking, incorporates the definition and analysis of innovative mentality, including its cognitive and instrumental components, and various characteristics such as creative, theoretical, social, constructive, transformative, and pragmatic ones, which constitute a complex structure of innovative thinking.*

**KEYWORDS:** *Innovative Thinking, Characteristics Of Innovative Thinking, Fostering The Students' Innovative Mentality.*

### INTRODUCTION

Although we clearly see today that there can be no social development without scientific and technical discoveries, no work on spirituality mentions the importance of scientific and technical knowledge, the methodology of their study does not reveal. Scientific and technical knowledge is also a reflection of the objective laws and requirements of spiritual development. Actually, there is no place in our spiritual heritage to solve this problem, but the present time requires scientific and technical research; the effective use of the achievements of the scientific and technological revolution in all spheres of social life has become a necessity. Undoubtedly, such qualities as social justice, ideal society, perfect man, high spirituality, humanity, patriotism, faith, good behavior, community, unity, humility, generosity, peace-loving, diligence, family-oriented, which are glorified in the spiritual heritage of our people, are immortal. It is our duty to assimilate and inculcate it in the hearts of the younger generation. However, it is also true that

the objective laws of social development, the requirements of innovative development expect from us scientific and technical knowledge, discoveries. At the same time, it should be noted that historicalism and traditionalism prevail in spiritual-moral imperatives, which can sometimes lead to stagnation, conservatism. This historianism helps to ensure stability and unity in society, in interpersonal relations, strengthens the ties between the individual and society, it makes intergenerational diachronic ties into important values. However, they can also be an obstacle to innovative changes.

## **MATERIALS AND METHODS**

So we need to focus on deciding on a certain consensus, conformity, between traditionalism and modernization. Where historicism prevails, any innovation remains a dry desire. Therefore, it is necessary to pay due attention to young people who are active subjects of innovation, to form in them not only the ability to master innovations and creative activity, but also the ability to live with moral imperatives embedded in the spirituality of our people. Reconciling these two hypocritical, contradictory sides, no matter how complex and difficult the task, is an objective requirement of our national development.

Spiritual and moral imperatives are, in essence, the values created by our ancestors, inherited from them, the mentality, way of life and cultural life of our people and nation. Their connection with different interests and hobbies has formed the categories of "I" and "We" in the spiritual and moral life. "Rituals, traditions, and customs that have been formed and developed in a society over the centuries are also a manifestation of the moral relationship that exists between the individual and society. Based on these, the relationship between the individual "I" and the collective "We" is harmonized [1].

Many literatures emphasize the predominance of "We" in the spiritual and moral imperatives of the East. The fact that this communism has risen to the level of tradition is not a negative, conservative case, of course. But in the development of society, the category of "I" or "We" has never been absolutely dominant, it was impossible to live without harmonizing them. It is natural that there is a contradiction between these categories. Because "the development of the relationship between the individual and society is not just about commonalities. There will also be contradictions in this relationship.

The basis of these contradictions is the disproportion in the understanding and formation of the relationship between the individual and society. A individual is a special person. And society is the unity of such individuals formed on the basis of certain goals. Conflicts occur as a result of society not understanding the individual, the individual not understanding society. Take the life of Maria Curie Skladovskaya, a two-time Nobel laureate, for even major social tragedies, such as the contradictions that arise as a result of personal selfishness or, conversely, the complete shadowing of personal interests. Having a unique scientific ability, the genius creator is so devoted to her interests and research that she do not even think that a woman should have at least three or four dresses. Her "I" is Polonia, in search of radius. She wants to be alone all the time in this quest. Only her partnership with her husband, Pierre Curie (who is also a Nobel laureate), gives her peace of mind and satisfaction in life. It can be called creative (positive) selfishness, but still selfishness [2].

Many great artists are obsessed with one or another flaw, arrogance, as if glorifying their "I"[3]. That is why the Italian psychiatrist Lombroso notes the encounter of conceit, even madness, in

great creators [4]. Discovering something new, giving in to creativity is something that can lead to indifference. But this creative psychological state is unique to some individuals, and the whole society cannot live in such a state. In innovative mentality, there is a surge of creativity, but this is also typical of true inventors. The pain and joy of creating something activates the "I", sometimes making it a rival to those around him. That's why the great creators are introvert; don't like the circles, the crowds and the hassles.

We find these qualities in Beruni, Ibn Sina, and mystics. The "I" is not limited to Western artists, we observe it in the qualities of almost all great personalities. However, the traditions of the East have always embodied the "I", and it is rare to go beyond the "We", even in the most talented people. In our opinion, this is the reason why scientific and technical mentality in the East is not sufficiently developed. This can be seen in the following reasonable thoughts of E. Yusupov: "Social moral duty and responsibility sometimes contradicts a individual's personal interests.

## RESULTS AND DISCUSSION

Man sometimes seeks to circumvent traditions, customs, which are part of social moral duty and responsibility. The tendency to deviate from certain traditions in the context of social problems is more common in young people who are influenced by emotions and passions. They sometimes tend to adapt them rather than adapt to a particular social, moral environment. In the field of love, there are times when parents try to achieve their goals without taking into account public opinion, and emotions sometimes lead a person astray. Some people go so far as to commit suicide when they cannot find a way to resolve the conflict between public opinion and personal interests"[5].

According to the scientist, the spiritual life of young people should be in line with public opinion, a reflection of the requirements of "We". Giving personal interests to the public is seen as a sign of spiritual maturity. Eastern traditionalism does not allow the individual to go beyond its own limits; it keeps it within the bounds of spiritual-moral imperatives. Is it good or bad? If there is a positive case, what are the positive aspects, and if there is a negative event, what are these aspects? What do these aspects have to do with the topic, innovative mentality? On the first question, academician E. Yusupov states the following: "Morality is the result of the fact that each person feels responsible and accountable to others.

Based on this, it can be concluded that moral maturity is the understanding, reliance and development of spiritual values that have been formed over the centuries in the course of one's life and activity. The key issue is not only what moral heritage each nation has, but also to what extent new generations adhere to and develop it. For this reason, it has always been a sign of morality that every person should follow the rules of behavior, manners, treatment and attitudes that exist in society. Deviation or disregard for traditions and values in this regard is considered immoral. Immorality is a violation of the balance between "I" and "We"[6].

It turns out that the values that have been formed over the centuries determine a person's behavior that following them is moral, that violating them is considered immoral. The centuries-old balance between 'I' and 'We' is transformed into a firm moral imperative that cannot be broken.

From a spiritual and moral point of view, this idea is remarkable, but there is a danger of translating it into all human behavior, including creative activity, innovative research. If we

remember that almost all human activity in the East has been measured according to spiritual-moral imperatives, we find that the above danger is not unfounded. At the same time, there is a positive side of this idea, the spiritual-moral imperative. The scientific and technological revolution in the West rejected the traditions formed over the centuries, saw the intellectual power of man, his scientific potential as the only factor that ensures social development. As a result, Western civilization has made great strides, rescuing man from muteness in the natural environment, making his life prosperous, his mind free and his possibilities wide, colorful and enjoyable.

But wealth, money, and prosperity, which the West worships as its core values, have become, according to E. Fromm, "universal arguments that will overthrow the world, change and destroy all natural things and human qualities"[7]. The scientific and technological revolution and that it gave birth the life ideals, lifestyle and way of thinking to play an important role in this. It is widely acknowledged that the scientific and technological revolution has caused global environmental, demographic and spiritual crises, and that it has brought humanity to the brink of destruction. These tragic consequences of the addiction to the development of scientific and technical mentality should not be transferred to innovative development. This can be prevented, first of all, by our spiritual and moral traditions, oriental traditionalism. This is where the conditionality of the dialectical relationship between spiritual and moral imperatives and innovative mentality is manifested. This is the answer to the first and second question above. Eastern traditionalism is based on the principles of "seven measures, one cut" and "thanks for everything." It is a priority to rely on traditions, to measure behavior in accordance with the norms and views decided in the social environment, to support only the initiative that conforms to these norms and views. The novelty seems to be atheism, even a violation of existing routines, traditions. Innovative mentality cannot be limited to such norms and views; it is characterized by constant restless research, creation of something, striving to improve existence. Continuous improvement is its element and demand. It is not possible to completely eliminate these contradictions, but they can serve each other syn harmonically. For this, society and the state must be interested in ensuring such harmony. In our opinion, this interest can be reflected in the following areas, tasks: 1) the development of creative, innovative young people, intellectual forces; 2) creation of a new pedagogical technology for the formation of scientific and technical mentality on the basis of humanism, within the framework of spiritual and moral imperatives; 3) the formation of moral responsibility, social duty and scientific ethics in society in a way that supports the potential of artists with great intellect.

These directions, tasks seem trivial from the surface. The global crises caused by the scientific and technological revolutions worried first the members of the Club of Rome [8] and then the whole of humanity [9]. There is no social development without scientific and technical discoveries; the deterministic impact of these discoveries has raised the question of how scientific and technical research should be conducted and what educational model young people should be trained. Training young people capable of discovering creative, innovative techniques required a new pedagogical technology, an educational model, without addressing this issue, the training of scientific and technical personnel would cause to deepen the crisis. Between 1945 and 2000, about 400 globally-minded universities and academies were opened in European countries, training highly educated scientific and technical personnel. The policy of humanization of

scientific and technical discoveries, that is, the support of discoveries that meet the fundamental goals of man, has been implemented [10]

### CONCLUSION

In life, morality should be subordinated to morality, not interest. If interest is seen as superior to morality, people will go down the path of denying even the simplest truth that is known to all. There have been and will continue to be such people among mankind. The relevance of educational work is determined by the same reasons". Scientific and technical mentality, it is observed that discoveries are made in terms of certain interests. The great philanthropists seek to expand their material possibilities when they support this or that scientific and technical invention. This is a common tradition in the intellectual world. Hence, there is a danger that innovative discoveries contradict universal moral imperatives and requirements. The supremacy of the interests of over universal imperatives and demands is in stark contrast to the principles of stability, unity and justice in society, which inevitably causes unrest in social life. That is why E. Yusupov emphasizes educational work.

### REFERENCES

1. Yusupov E. Spiritual foundations of human perfection - Tashkent: University, 1998. 79-p.
2. Curie E. Marie Curie. Translated from French. Ed. 3 e- Moscow: Atomizdat, 1973.
3. Secret passions of the great-Moscow: AST: Zebra E, 2008.
4. Lombroso C. Genius and insanity -Saint Petersburg, 1992.
5. Yusupov E. Spiritual foundations of human perfection - Tashkent: University, 1998. 79-p.
6. That book. 80-p.
7. Fromm E. Art of Moscow: AST, 2014 -S.315.
8. A. Pecci Human qualities. Moscow: Progress, 1971.
9. Global problems and universal values. Moscow: Progress, 1990.
10. Zigunenko S.N. Great discoveries. Moscow: AST: Astrel: Transitkniga, 2005.

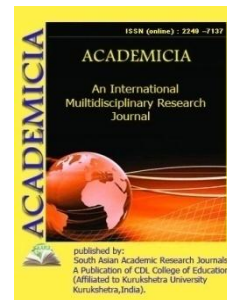
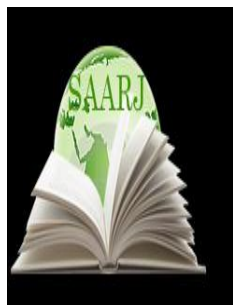

DOI: **10.5958/2249-7137.2021.01152.6**

**SYSTEMATIC ANALYSIS OF FORMALIN PRODUCTION ON THE  
EXAMPLE OF WELL-KNOWN FOREIGN COMPANIES AND JSC  
"NAVOIAZOT"**

**Pulotova Mokhira Rakhmatiloevna\***; **Jurayev Uchkun Yusuf ugli\*\***;  
**Norkulov Intizor Odiljonovich\*\*\***; **Rustamov Shakhzod Sirojiddin ugli\*\*\*\***;  
**Saparboyev Ruzimboy Kadamboy ugli\*\*\*\*\***

\*Independent Researcher,  
Teacher of the Department of Automation and Control of Technological Processes and,  
Production of the Tashkent Institute of Irrigation and,  
Agricultural Mechanization Engineers Bukhara branch,  
UZBEKISTAN

<sup>2,5</sup>Students of the Department of Automation and Control of Technological Processes and,  
Production of the Tashkent Institute of Irrigation and,  
Agricultural Mechanization Engineers Bukhara branch,  
UZBEKISTAN

**ABSTRACT**

*Currently, formalin is gaining more and more practical importance as a very valuable intermediate product on the way of obtaining various organic compounds and polymeric materials with a wide variety of properties. The world consumption of formalin is growing all the time. Today, there is a significant deficit of formalin, both in the domestic market and in the markets of foreign countries. In this regard, there is a need to create new production facilities, as well as reconstruction (expansion) and modernization of existing production facilities. The article presents an analysis of several technological schemes for the production of formalin.*

**KEYWORDS:** *Formalin, Methanol, Alcohol Evaporator, Reactor, Absorber Pumps, Steam Generator, Circulating Coolant Pump, Collector Of The Coolant, Water Pump.*

## INTRODUCTION

Formalin is one of the large-tonnage products of the chemical industry. Formaldehyde, which is part of formalin, has a high reactivity, availability and low cost, therefore formalin has become one of the most important intermediates in the chemical industry. Its importance for modern industrial organic synthesis can hardly be overestimated. Formalin is used for the production of synthetic resins, plastics, plasticizers, organic dyes, various adhesives, varnishes, pharmaceuticals and other products. Formalin is also used in agriculture for seed dressing, in the leather industry for tanning leather, in medicine and animal husbandry as an antiseptic, etc. The world production of formalin is estimated at 14-45 million tons per year.

**LITERATURE REVIEW:** One of the first industrial production facilities for formalin on metal oxide catalysts was built by the Italian firm Monteedisson, which has extensive experience in chemical engineering (Fig. 1).

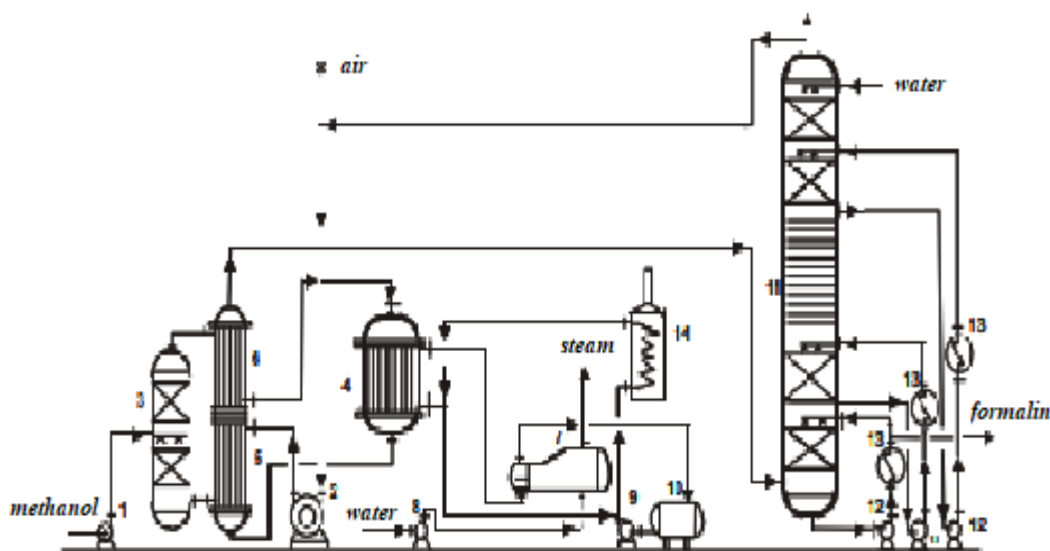

Figure 1 - Technological scheme of the Italian company "Monteedisson"

1 - methanol pump; 2 - blower for air / offgas mixture; 3 - alcohol evaporator; 4 - reactor; 5 - heater for the mixture of air with exhaust gas; 6 - working mixture superheater; 7 - coolant cooler - steam generator; 8 - water pump; 9 - circulating coolant pump; 10 - collector of the coolant; 11 - absorber; 12 - absorber pumps; 13 - absorber coolers; 14 - coolant heater at start-up.

At this installation, the production of a working air-off-gas methanol-containing mixture is carried out by adiabatic evaporation of methanol due to the heat accumulated by the heated mixture of air and off-gas. "The process of evaporation of alcohol is carried out in a packed column apparatus. Methanol is fed into the middle of the apparatus through spray devices, the upper part of the nozzle serves as a spray catcher. The mixture of air with offgas entering the lower part of the apparatus and the resulting working mixture are heated in a two-section heat exchanger by hot reaction products leaving the reactor. The composition of the resulting mixture of air with abgaz in terms of oxygen concentration and the composition of the working mixture in terms of methanol content are automatically maintained at all operating installations of this and other companies. Initially, the heat exchanger, which acts as a waste heat boiler for removing



the heat of the reaction products and heating the air-exhaust gas mixture and overheating the working mixture, was installed horizontally, and in subsequent schemes - vertically. The catalyst in the reactor tubes is cooled by a circulating refrigerant - a high-temperature organic coolant (HERE). The refrigerant is forcibly circulated in the system "reactor shell - waste heat boiler (where the heat exchanger is cooled by evaporating water) - circulation pump - reactor". The preset catalyst temperature is automatically maintained by the amount of circulating heat carrier. At start-up of the installation, the catalyst is heated to the initial reaction temperature by a circulating coolant in a special furnace with flue gases or heating elements. Reaction products cooled in a two-section heat exchanger

go down the absorption column, where formaldehyde and methanol are extracted from them with water flowing in countercurrent to the top of the absorber. Water for irrigation is supplied on the basis of obtaining a given concentration of formalin. Exhaust gas leaves the upper part of the absorber, about 75% of which is returned back to the process for mixing with air and vapors of methyl alcohol. The disadvantage of the technology for producing formalin using metal oxide catalysts from Monteedisson is the high specific power consumption, since to obtain an equal amount of formalin in comparison with the use of a silver catalyst, a 6-fold volume of the reaction mass is passed through the system. Accordingly, the power of the installed blowers and the electricity consumption are also six times higher. A significant amount of it is consumed by the pump for circulating the liquid coolant in the "reactor - waste heat boiler" system. According to experts, the power consumption can be reduced if the methanol content in the working mixture is increased or, instead of the liquid cooler of the reactor, evaporative heat removal with the elimination of the circulation pump is used.

#### ***Analysis of the installation of the firm "Perstorp Formox"***

Almost simultaneously with the Monteedisson firm, the process of formalin production by a similar method was carried out by the Swedish company Perstorp Formox, which has been producing formalin since 1905. Differences of the technological scheme "Perstorp Formox" from "Monteedisson" are as follows [2, P.33]. First, the production of a methanol-air-gas mixture and its overheating are performed without an alcohol evaporator by injecting a given amount of methanol into the pipeline of the air-gas mixture supplied to the tubular heat exchanger. At the same time, water vapor obtained at the installation is directed into the shell space of the heat exchanger, and methanol evaporates and its vapors are mixed in the tube space with an air-gas mixture.

Secondly, an evaporating Dowtherm coolant, a mixture of biphenyl and biphenyl oxide, is used to cool the catalyst in the reactor. The coolant vapors are condensed in a heat exchanger - heat recovery boiler and return by gravity to the catalytic reactor, that is, the thermosyphon principle is implemented. Water vapor obtained during the condensation of heat carrier vapors is issued as a commercial one. Thirdly, the cooling of the reaction products is carried out in a heat exchanger with water to obtain water vapor, which is used to heat the heat exchanger, in which the working mixture is obtained and overheated (Fig. 2).

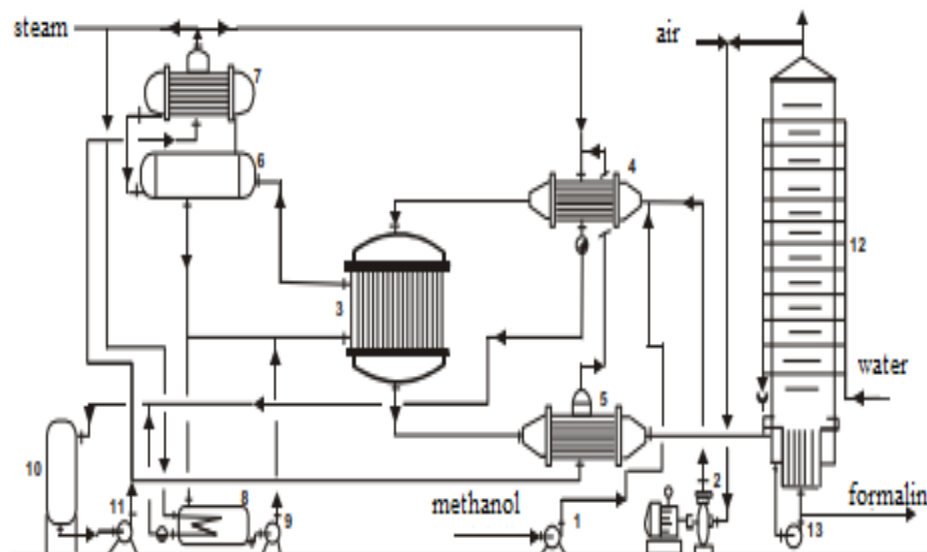

Figure 2 - Technological scheme of the Swedish company "Perstorp"

1 - methanol pump; 2 - blower for air / offgas mixture; 3 - reactor; 4 - apparatus for obtaining a working mixture; 5 - cooler of reaction products; 6, 7 - refrigerant vapor condensers; 8 - coolant collection; 9 - pump for circulation of the coolant at start-up of the installation; 10 - condensate collector; 11 - condensate pump; 12 - absorber; 13 - formalin pump

The regulation of the temperature regime of the catalyst operation with the evaporating coolant can be performed by two methods - direct and indirect. With the direct method, the amount of heat taken is directly related to the vapor pressure of the coolant. With a decrease in their pressure, more heat is taken away, which helps to lower the catalyst temperature. The indirect one consists in changing the pressure of the water vapor obtained in the heat-transfer boiler. Maintaining the set temperature in both methods is performed automatically.

The absorption system consists of one column with a bottom formalin cooling heat exchanger and heat removal on each plate. For this reason, the technological scheme of the Swedish company "Perstorp Formox" is more perfect and economical than in the case of "Monteedisson".

#### ***Firm "Haldor-Topsoe"***

The technology for obtaining formalin from the Danish-Japanese company Haldor-Topsoe is close to Perstorp, which is easy to see when looking at Figure 3 in detail .

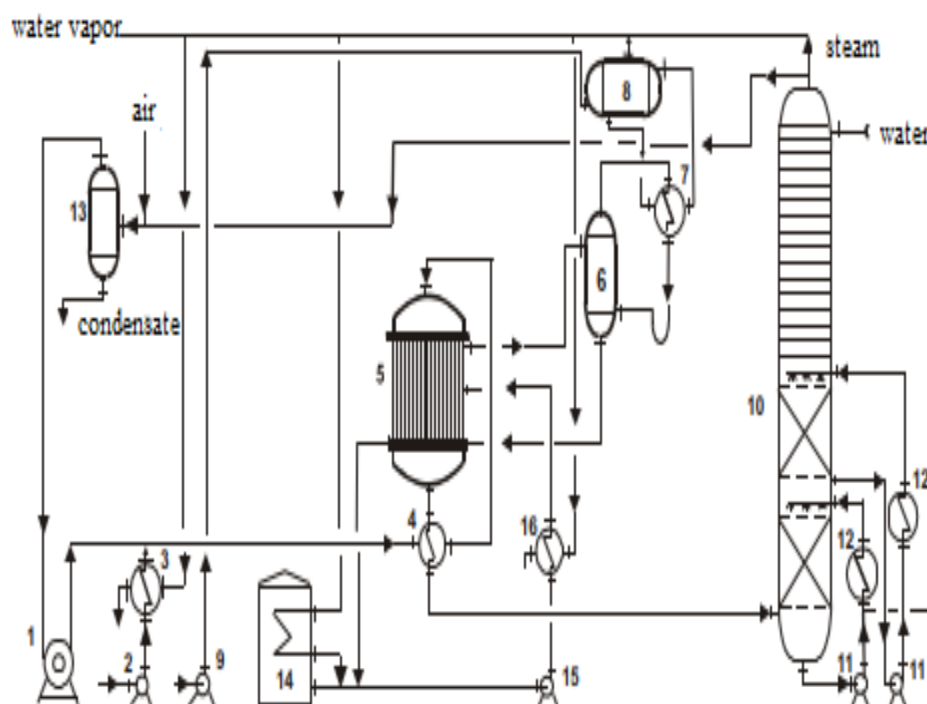

Figure 3 - Technological scheme of the Danish-Japanese company "Halder- Topsoe "

1 - blower for a mixture of air with offgas; 2 - methanol pump; 3 - methanol evaporator; 4 - working mixture superheater; 5 - reactor; 6, 7, 8 - coolant vapor condensers; 9 - water pump; 10 - absorber; 11 - formalin pumps; 12 - absorber refrigerators; 13 - condensate separator; 14 - coolant reservoir; 15 - pump for circulation of the coolant when starting up the installation; 16 - heat carrier heater.

In the proposed technological scheme, the evaporation of methanol is carried out in a special apparatus with the subsequent mixing of its vapors with a mixture of air and offgas. Condensation of methanol vapors does not occur in this case, since, when compressed in a supercharger, they are heated above the boiling point of methanol. Overheating of the working mixture is carried out in a heat exchanger by hot reaction products leaving the reactor.

For the absorption of formaldehyde, one three-section absorption tower is used. The two lower sections are packed with the outlet, cooling and forced return to the top of their section of the liquid phase, and the third one performs sanitary functions and is intended for additional binding of formaldehyde from the abgas.

### ANALYSIS OF THE PLANT OF THE FIRM "LUMMUS"

According to the scheme of the American company Lummus (Fig. 4), two industrial plants for the production of 37% formalin were built: in 1967 in Calver City by GAF (General Aniline Fabrik) and in 1970 by a Japanese company "Semitsu" in Osaka [2].

The capacity of each was approximately 25 thousand tons per year.

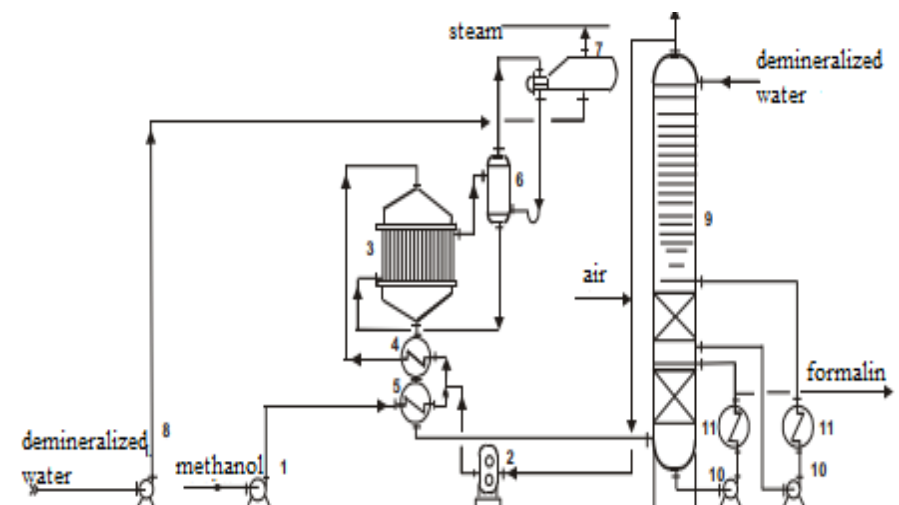

Figure 4 - Technological scheme of the company "Lummus"

1 - methanol pump; 2 - blower for air / offgas mixture; 3 - reactor; 4 - working mixture superheater; 5 - methanol evaporator; 6, 7 - coolant vapor condensers; 8 - pump of demineralized water; 9 - absorber; 10 - formalin pumps; 11 - formalin refrigerators

In this scheme, methanol is vaporized by hot reaction products, which first enter the heat exchanger, overheating the working mixture. Cooling of the catalytic reactor is carried out with an evaporating coolant to obtain commercial water vapor. The formaldehyde absorber is three-section, as in the previous schemes - two sections are packed and one is disc-shaped. This design ensures good absorption of formaldehyde from the offgas. In addition, during the implementation of the process, an additional stage of neutralization of acidic formalin is provided in the installation using ion-exchange resins, which significantly complicates the process. To prevent corrosion, the reactor is made of low alloy carbon steel.

It should be noted that due to the noted shortcomings, the technological processes of Lummus are less known than other licensors.

### **ANALYSIS OF THE INSTALLATION OF THE COMPANY "KLEKNER-HUMBOLT"**

Process flow diagram developed by Klöckner

Humboldt ", the hardware design is somewhat different from previous (Fig. 5).

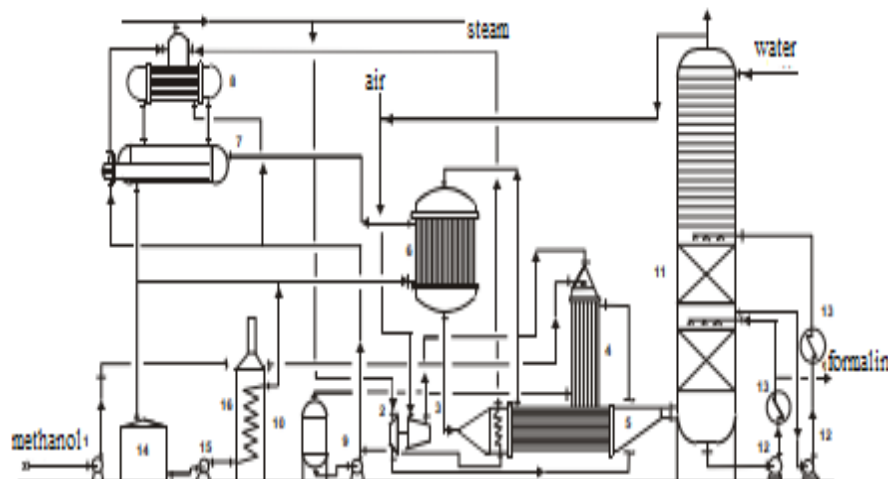

Figure 5 - Technological diagram of the German company "Klöckner-Humboldt "

1 - methanol pump; 2 - blower for air / offgas mixture; 3 - steam turbine; 4 - methanol evaporator; 5 - working mixture superheater; 6 - reactor; 7, 8 - coolant vapor condensers; 9 - condensate pump; 10 - condensate collector; 11 absorber; 12 - formalin pumps; 13 - absorber coolers; 14 - coolant reservoir; 15 - pump for circulation of the coolant when starting up the installation; 16 - heating agent heating furnace

Here, the injected mixture of air with exhaust gas enters the conical cover and then into the tube space of a vertical heat exchanger heated by hot steam condensate from a steam turbine. Methanol is fed into the same top cover through a shower-type spray nozzle and evaporates. This heat exchanger is installed on another horizontal heat exchanger, in which the working mixture is overheated by the hot reaction products passing through it and then enters the contact apparatus. Heat is removed by an evaporating heat carrier. The absorber, as in the previous schemes, is three-section: the first two sections are packed, the upper one is disc-shaped.

The reaction products are pre-cooled with evaporating water in a coil mounted in the front chamber of the heat exchanger. The blower is driven by a steam turbine running on steam from the installation. In the proposed technological scheme, the power consumption is the lowest in comparison with all other schemes, but there is no commercial water vapor.

### **Research Methodology: System analysis of the formalin production process flow diagram at Navoiazot JSC in Uzbekistan.**

The description of the technological scheme is given in accordance with [3].

The method for the production of formalin from methanol consists in obtaining formaldehyde on a catalyst "silver on a carrier" at a temperature of  $550\text{ }^{\circ}\text{C} \div 700\text{ }^{\circ}\text{C}$ , followed by its absorption in water and rectification. The formalin production process for one technological line consists of the following stages:

- obtaining a methanol-air mixture;
- synthesis of formaldehyde;

- absorption of formaldehyde to obtain "raw formalin";
- rectification of "raw formalin". The knots common to all threads are:
- collection and processing of substandard and drained products,
- purification of gas emissions,
- Combustion of absorption gases in a flare, heat supply, collection and pumping of condensate.

The auxiliary nodes are:

- preparation of the catalyst,
- storage and shipment of formalin,
- thermal disposal of waste.

A graphic representation of the stage of obtaining a methanol-air mixture and the stage of contacting is given on FYURA PF 000.000 ST.

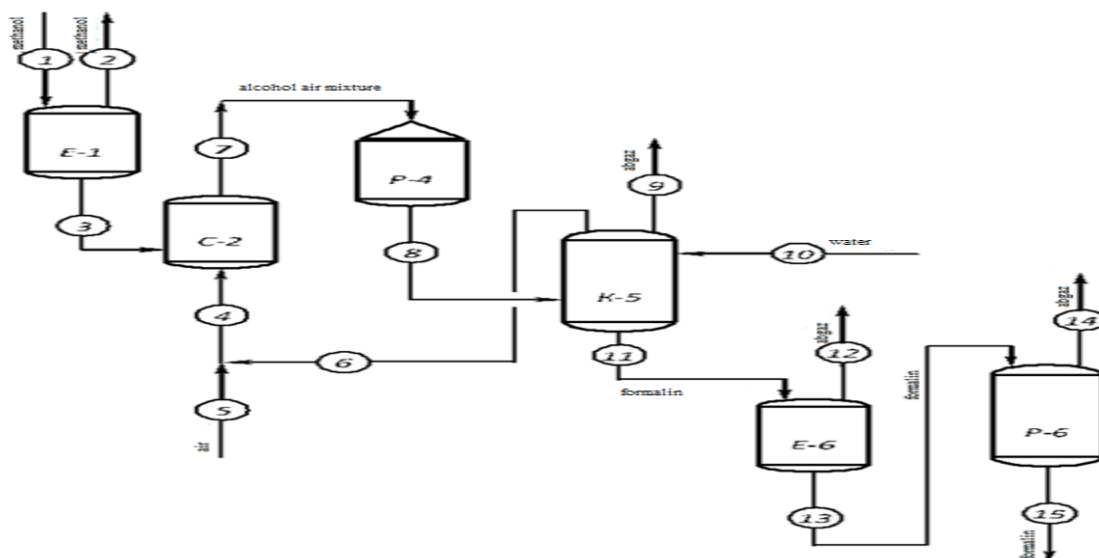

### Analysis and results: Getting a methanol-air mixture

Methanol from the warehouse is fed through check valves to the "methanol manifolds", where return methanol from the rectification units is added to the "fresh" methanol. Methanol (for one process line) from

"Methanolic comb" pre warmed in embedded heat exchangers absorption column pos. K16 up to 65 ° C and enters the alcohol evaporator for the formation of a methanol-air mixture. To reduce the side reactions of the formaldehyde production process, methanol in the mixer pos. X11 is miscible with demineralized or oversized water.

**CONCLUSION/RECOMMENDATIONS:** The work was to determine the possibility of expanding the production of formalin using the example of a formaldehyde synthesis unit.

However, an increase in productivity entails an increase in the heat load on heat exchangers and, as a consequence, an increase in the consumption of heat carriers (refrigerants). Also, to

ensure the required degree of conversion of methanol into formaldehyde, it is necessary to increase the amount of catalyst loaded into the contact apparatus.

Along with this, in the project, the issues of analytical and technological control of the process, ensuring safe production conditions and environmental protection were considered.

## REFERENCE

1. Nakrokhin B.G., Nakrokhin V.B. Formalin production technology from methanol. - Novosibirsk, 1995. -- 444 p.
2. Makhlai V.N., Afanasyev S.V. Introduction to the chemistry of urea-formaldehyde concentrate. - Togliatti: Publishing house of Togliatti Polytechnic. in-ta, 2001. - 114 p.
3. Obtaining low-methanol concentrated solutions of formaldehyde / Gritsan V.I. and etc.; Scientific and technical news. - 2005. - No. 10-11. - S. 27.
4. Catalytic production of formaldehyde from methanol under conditions
5. recycling of waste gases Petrik V.N. and others; Chemical industry. - 1990. - No. 5. - S. 10-13.
6. Arifjanov A. Sh., Nabiev O. M. Problems of domain modeling in the design of information and analytical systems. Bulletin of the Kyrgyz National Technical University. I. Razzakova, Bishkek, 2010, -S. 124-128.
7. Arifjanov A. Sh., Kulmurodov A.B. Tyu A. V. Development of basic software and mathematical support for local environmental monitoring systems for industrial enterprises. Oliy ukuv yurtlari akhboroti, fanlari technique, no. 3, 2000, pp. 52-55
8. Arifjanov A. Sh. Automated control systems for technological processes in water management: Textbook. - Tashkent, TIM, 2017.-136 p.
9. A. Sh. Arifjanov. Packages used in automation. Textbook. - Tashkent, TIIMSKh, 2018
10. Pulotova Mokhira Rakhmatilloyna<sup>1</sup>, Bozorov Prim Raimovich, Optimization and advanced control for thermal cracking processes. Modern materials, technique and technology magazine. 2 (10) 2017.5-10 Art. <https://cyberleninka.ru/article/n/optimization-and-advanced-control-for-thermal-cracking-processes/viewer>
11. Arifjanov A. Sh. Information and analytical technologies for monitoring and control in energy systems. Proceedings of the XI International Asian School - Seminar "Problems of Optimization of Complex Systems", July 27-August 7, 2015, part 1, Issyk-Kul Lake, Kyrgyz Republic, 2015, pp. 56-64.
12. Pulotova Mokhira Rakhmatilloyna. Optimization and control of chemical processes. International human calculation journal research [www.journalsresearchparks.org / index.php / IJHCS](http://www.journalsresearchparks.org/index.php/IJHCS) e-ISSN: 2615-8159 | p-ISSN: 2615-1898 Volume: 02 Issue: 01 | Apr-May 2020
13. Pulotova Mohira Rahmatilloeyevna, Namozov Shohrukh Ilyos OGLi, Muinov Ulugbek Bahtiyerovich. Application of MatLab system for performance of laboratory works on the subject of the theory of automatic control. Bulletin of Science and Education. Issue 10-2 (64)

14. M.R.Pulotova. Identification of discrete systems by the quasilinearization method and nonparametric identification methods. 2020. Modern instrumental systems, information technologies and innovations. Pages. 241-244.
15. Kislyak GA Project of Formin Production Workshop: A Review of the Final Qualifying Work. - Tomsk: Tomsk Polytechnic University, 2000. - 304 p.
16. Ivanov GN Fundamentals of design and equipment of organic synthesis enterprises: Textbook on diploma design - Tomsk: Tomsk Polytechnic University Press, 1991. - 112 p.
17. Permanent technological regulations for the production of formalin at the Tomsk Petrochemical Plant "Formalin and Carbose Plant".
18. Ogorodnikov KS Formaldehyde. - L .: Chemistry, 1984. - 328 p.
19. Gutnik SP, Sosonko VE, Gutman VD Calculations on Organic Synthesis Technology: Textbook. pension. - M: Chemistry 1988. - 272 p.
20. Lebedev NN Chemistry and basic organic and petrochemical synthesis technology: A textbook for universities. 4th Edition, Revised and Enlarged. - M .: Chemistry, 1988. - 592 p.





**ACADEMICIA**  
**An International  
 Multidisciplinary  
 Research Journal**  
 (Double Blind Refereed & Peer Reviewed Journal)



**DOI: 10.5958/2249-7137.2021.01150.2**

## THE USE OF BLACK BOX METHOD IN AUTOMATION OF DRYING

**M. R. Pulotova\* ; M. Sh. Abdullayev\*\***

<sup>1,2</sup>Assistants of the department,  
 “Automation and management of Technological processes and production”,  
 Tashkent institute of irrigation and agricultural mechanization engineers of Bukhara branch,  
 UZBEKISTAN  
 Email id: moxi7676@mail.ru

### ABSTRACT

*Provision of the feed base of the livestock sector of the Republic with new, nutritious feed pellets and automation of these systems on the basis of modern information and Communication Technologies is an urgent issue.*

**KEYWORDS:** *Grinding; Wetting; Granulation; Drying (Final Step);*

### INTRODUCTION

In recent years, a valuable source of raw materials for the food industry has appeared on the world market - amaranth seeds with high nutritional and biological value, containing a wide range of functional ingredients and biologically active substances, which determines the prospects for their use in food. [1]

Amaranth (shiritsa) is an agricultural crop that attracts the attention of researchers due to its high yield, protein richness and balance, high content of vitamins, minerals and dietary fiber. According to the FAO / WHO (Food and Agriculture Organization of the United Nations) in the 21st century, this plant is able to take a leading position as a food, feed and medicinal crop. In connection with the expected global climate changes on Earth, the use of amaranth becomes even more urgent due to its high ability to adapt to adverse environmental conditions. [2]

Amaranth in livestock and poultry farming is a profitable feed with high productivity indicators, which, when properly grown, is environmentally friendly (since it does not require the use of a number of chemicals necessary for growth, for example, barley). Amaranth feed grains contain about 14-18% protein, 5-6% healthy fats, 55-62% starch, pectin, 5 micro and macro elements each. Amaranth green grass meal and grass pellets are superior in terms of vitamins to standard grass meal and pellets used in feed for pigs, cows, chickens and rabbits.

**Method.** The black box method is chosen as the automation method of the drying process. The main point of view using the black-box method is that input and output parameters in the technological processes are related to each other with material balance or heat balance. The black box is can be defined as a rectangle scheme. On the black box, we can see how particular output parameters that we need to automate the process (exp. humidity, temperature) have a dependence on input parameters like drying agent consumption (gas consumption), the temperature of drying agent, or others.

- **Process of producing feed granules on the basis of amaranth**

Obtaining feed granules on the basis of Amaranth consists of several stages, which can be described as follows (figure 1): 1. Grinding; 2. Wetting. 3. Granulation. 4. Drying (final step)

First, the raw amaranth product goes to grinding, where the plant turns into powder, afterward for the improving adhesive feature the water is adding to it (moreover some ingredients will be added to thicken the mixture). Then the ready batch is granulated in a granulator press, at the end the granule is dried with hot air, and the finished product is taken. [5]

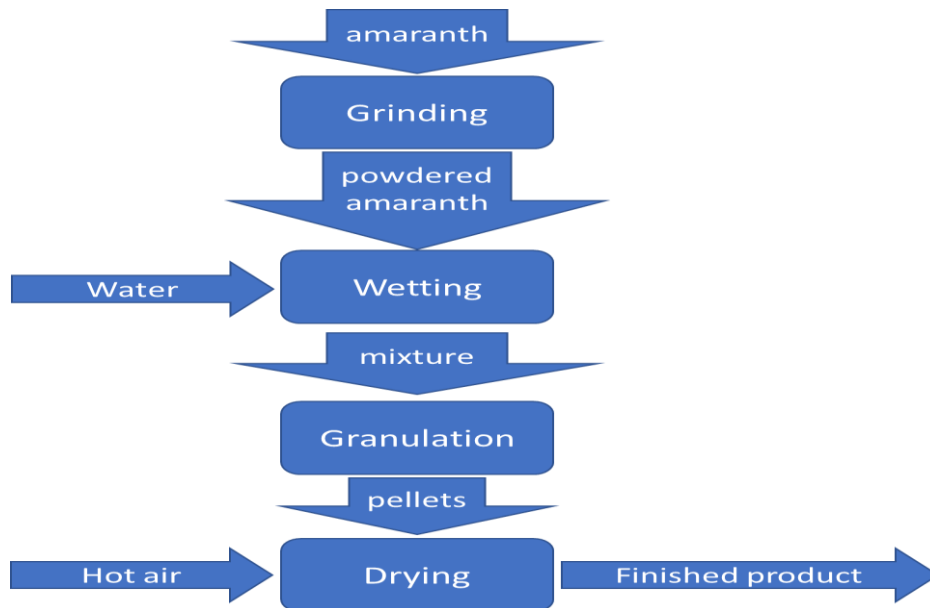

**Figure 1.** Production of feed granules on the basis of Amaranth.

- **Problem formulation.**

*The main parameters of the drying agent and material, as moisture carriers.*

*Relative humidity of the drying agent  $\phi$ :*

$$\phi = \frac{P_p}{P_n} \quad (1)$$

*Based on the Mendeleev-Clapeyron equation, one can obtain*

$$\phi = \frac{P_p}{P_n} \quad (2)$$

*The relative humidity of the material  $\omega$  is - the ratio of the mass of moisture  $M_m$  to the total mass of wet material  $M=M_{dm} + M_m$ , or to the mass of absolutely dry material  $M_{dm}$ :*

*Humidity attributed to the whole substance:*

$$\omega = \frac{M_m}{M} * 100, \% \text{, where } M=\text{var} \quad (3)$$

*Humidity, referred to the mass of absolutely dry material*

$$\omega^C = \frac{M_m}{M_{dm}} * 100, \% \text{, where } M_{dm}=\text{const.} \quad (4)$$

- **Controlled object.**

The belt dryer serves as a controlled object. The material is dried continuously at atmospheric pressure. In chamber 1 of the dryer (figure. 2), the layer of dried material moves along an endless belt 2 stretched between the leading 3 and driven 4 drums. Wet material is fed to one end of the tape, and dried material is removed from the other end. Drying is carried out by hot air or flue gases, which move countercurrent or cross current to the direction of movement of the material.[6]

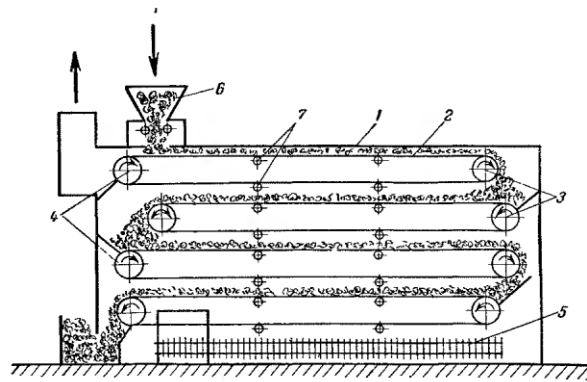

**Figure 2.** Belt dryer scheme.

Non-uniform drying of the material is usually observed in single-belt dryers with a continuous tape: in the inner part of the layer facing the tape, the final humidity is higher than in its outer part washed by gases or air.

More effective is the use of many belt dryers with metal mesh tapes. In them, the drying agent moves perpendicular to the plane of the tape through the layer of material located on it, i.e. cross current. When pouring material from tape to tape, the surface of its contact with the drying agent increases, which contributes to an increase in the speed and uniformity of drying. Belt dryers can work on various options for the drying process. [8]

**Process performance indicator - moisture of dry material  $\omega_{dm}$**

*The purpose of process management is to maintain -  $\omega_{dm} = \omega_{dm}^{\text{given}}$*

- **Material balance in terms of the total amount of moisture in the drying process**

**Dynamic equation:**

$$\rho_{dm} * V_{dm} * \frac{d\omega_{dm}}{dt} = G_{wm} * \omega_{wm} + G_{da}^{in} * \phi_{da}^{in} - G_{dm} * \omega_{dm} - G_{da}^{out} * \phi_{da}^{out} ; (5)$$

Here  $\rho_{cm}$ - dry material density;

$V_{dm}$  - dry material volume;

$\omega_{dm}$  - dry material relative humidity;

$G_{wm}$  - wet material consumption;

$\omega_{wm}$  - wet material relative humidity;

$G_{da}^{in}$  - input drying agent consumption;

$\phi_{da}^{in}$  - input drying agent relative humidity;

$G_{dm}$  - dried material consumption;

$G_{da}^{out}$  - output drying agent consumption;

$\phi_{da}^{out}$  - output drying agent relative humidity;

**Static equation**  $\frac{d\omega_{dm}}{dt} = 0$ :

$$G_{wm} * \omega_{wm} + G_{da}^{in} * \phi_{da}^{in} = G_{dm} * \omega_{dm} + G_{da}^{out} * \phi_{da}^{out} ; (6)$$

(5) and (6) one can get the following from expressions

$$\omega_{dm} = f(G_{wm}, G_{dm}, G_{da}^{in}, G_{da}^{out}); (7)$$

We get below in the analysis of the combustion chamber

$$G_{da}^{in} = f(G_f, G_{pa}, G_{sa}); (8)$$

Here  $G_f$  – fuel consumption;

$G_{pa}$  – primary air consumption;

$G_{sa}$  – secondary air consumption;

(7) and (8) of all possible controlling effects to adjust the final moisture content of the material from the statements listed, the  $G_f$  fuel consumption is the most informative one. [3]

From these dynamic and static material balance equations, we take the following relationships, in which we see a connection between fuel consumption and the main process parameters - product humidity, this method shows the relationship between control parameters and controlled variables.

- “Black box”

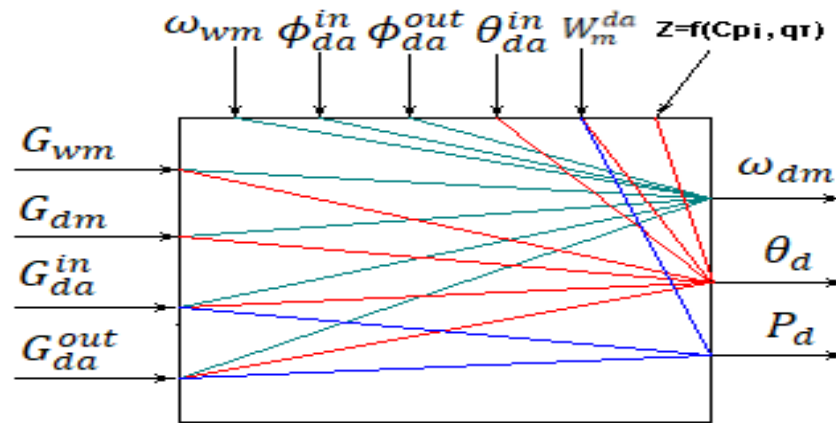

**Figure 3.** Information scheme of drying machine

- Possible control impacts:

$$G_{wm}, G_{dm}, G_{da}^{in} (G_f, G_{pa}, G_{sa}), G_{da}^{out}.$$

- Possible controlled disturbances:

$$\omega_{wm}, \phi_{da}^{in}, \phi_{da}^{out}, \theta_{da}^{in}, \theta_{wm}.$$

- Possible uncontrollable disturbances:

$$W_m^{da}, C_p$$

- Possible controllable variables:

$$\omega_{dm}, \theta_d(\theta_{da}^d), P_d(P_{da}^d).$$

- A dryer is a complex, multi-connected object.

## • RESULTS AND DISCUSSIONS

From the scheme for automation (picture 4), it can be seen dryer and sign of automation elements such as sensors, regulators and valves. Wet feed granules come from the press granulator to the ceil of dryer.

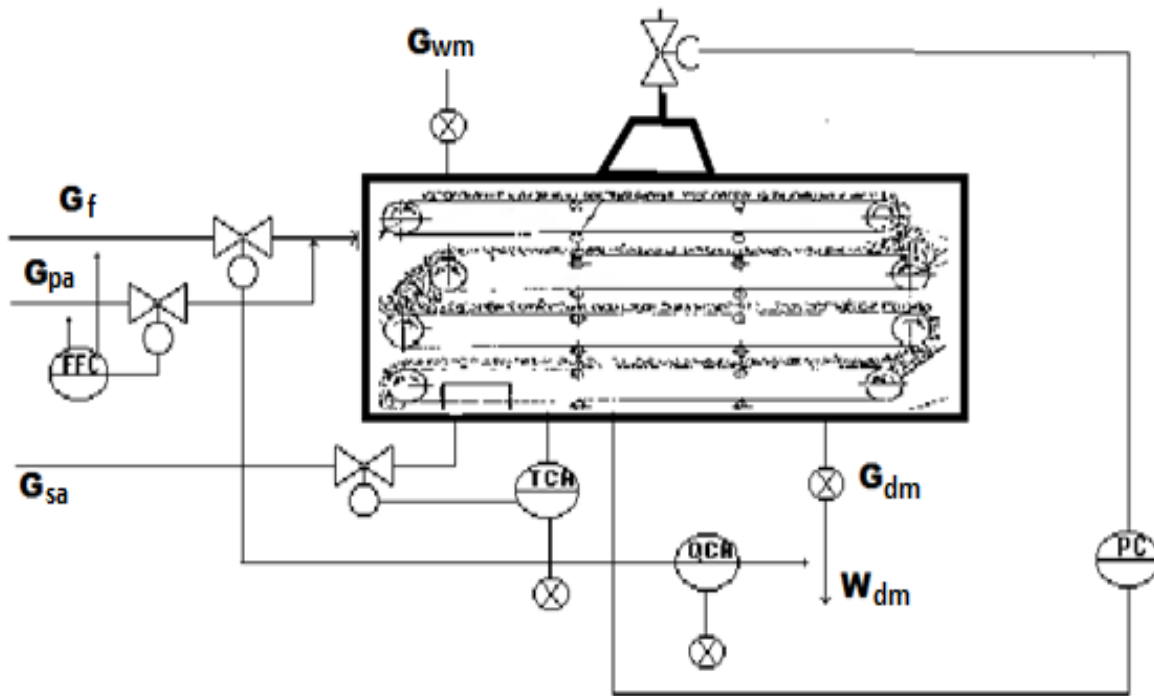

**Figure 4.** Scheme for automation of the drying process

- **Regulation**

- Regulation  $\omega_{dm}$  with fuel supply  $G_f$  - as an indicator of the effectiveness of the drying process
- Regulation of the ratio of fuel consumption  $G_f$  and primary air  $G_{pa}$  for the supply of primary air

$$G_{pa} = \gamma * G_f \text{ to ensure the efficiency of fuel combustion.}$$

- Regulation of the temperature of the drying agent  $\theta_{da}^{in}$  at the entrance to the drum secondary air  $G_{sa}$ .
- Stabilization of the costs of wet and dry material  $G_{wm}$  and  $G_{dm}$  with automatic dispensers - to ensure material balance in the solid phase.

- **Control**

- Consumptions-  $G_f, G_{pa}, G_{sa}, G_{wm}, G_{dm}$ ;
- temperature -  $\theta_{da}^{in}, \theta_{cada}^{out}, \theta_d$ ;
- Underpressure -  $P_d$ ;
- humidity -  $\omega_{dm}$  ( $\omega_{given}$ ).

- **Signaling**

- significant deviations  $\omega_{dm}$  from  $\omega_{given}$ ;
- significant increase in  $\theta_{da}^{in}$ ;
- Unplanned shutdown of the drive, at the same time a signal “To protection circuit” is generated.[9]

- **Protection system**

At the signal “To the protection circuit” - stop the flow of material and fuel into the drying unit.

## CONCLUSIONS

Amaranth has been gaining even more popularity in agriculture for more than twenty years. In the feed for livestock, its application takes place slowly. Nevertheless, now many farmers and peasants recognize that Amaranth is much more useful than nutrient varieties wheat, soybeans, barley and other traditional cultures. Considering the above, we carried out an analysis of the drying process where the main parameter is the humidity of the product, using the black box method to automate the drying process. “Black box”, which is considered as a belt dryer, portrays the relation between input (consumptions) and output (humidity, temperature) parameters. Material balance, in terms of the total amount of moisture in the drying process, substantiates these relations. Based on these interconnections on a black box, an automation functional scheme was built.

**Abstract.** The article describes the use of the “Black Box” method to automate the drying process in the technological system of producing granules based on amaranth. For this purpose, the correlation between the parameters involved in the drying process has been investigated and an information schematic illustrating these relationships is presented. Based on the given equations and information scheme, functional scheme of process automation is developed.

## REFERENCES

- Roslyakov Yu.F., Shmalko N.A., Bochkova L.K. Prospects for the use of amaranth in the food industry // News of higher educational institutions. North Caucasian region. Technical sciences, 2004. - No. 4. - S.92-95.
- Zheleznov A.V., Zheleznova N.B., Burmakina N.V., Yudina R.S. Amaranth: Scientific Foundations of Introduction. Novosibirsk, 2009.236s.
- Ivanova G.V. Automation of technological processes of the main chemical industries: Methodological guide. Part 2 / SPbGTI (TU) .- SPb., 2003.- 70s.
- Z. Salimov. Kimyoviy texnologiyaning asosiy jarayonlari va qurilmalari. T.2. Modda almashinish jarayonlari: Oliy o`quv yurtlari uchun darslik. T.: O`zbekiston, 1995. - 238 b.
- Arifzhanov A. Sh. Automated control systems for technological processes in water management: Textbook. - Tashkent, TIM, 2017.-136 p.
- Sh. Arifzhanov. Packages used in automation. Textbook. - Tashkent, TIIMSKh, 2018
- Pulatova Mokhira Rakhmatilloevna, Bozorov Prim Raimovich Optimization and advanced control for thermal cracking processes. Современные материалы, техника и технологии журналъ. 2 (10) 2017.5-10ст.

- Pulotova Mokhira Rakhmatilloevna . Optimization and control in the chemical processes. Журнал: International Journal of Human Computing Studies. Том 2, Номер 1. Страницы 1-4. 2020 год.
- M.R. Pulotova. The data and methods of the general scientific methodology.Used in the preparation and adoption of managerial Decisions in problematic production situations. The Way of Science International scientific journal, № 4 (74), 2020.





**ACADEMICIA**  
**An International**  
**Multidisciplinary**  
**Research Journal**  
 (Double Blind Refereed & Peer Reviewed Journal)



**DOI: 10.5958/2249-7137.2021.01149.6**

## MAKING INFORMATION SECURITY STRATEGIC TO BUSINESS

**S.M.Turdaliyev\***; **A.R.Yuldashev\*\***; **I.I.Djo'rayev\*\*\***; **T.V.Mamadaliyev\*\*\*\***

\*Teacher of Kokand State Pedagogical Institute,  
UZBEKISTAN

\*\*Teacher of Kokand State Pedagogical Institute,  
UZBEKISTAN

\*\*\*Teacher of Kokand State Pedagogical Institute,  
UZBEKISTAN

\*\*\*\*Teacher of Kokand State Pedagogical Institute,  
UZBEKISTAN

### ABSTRACT

*This article informs about the the importance of strategies of making business information. As well as security strategic faktors economy in use. Often times, the information contained within these environments is very sensitive and can potentially be put at risk if accessed or changed by an unauthorised user. This lack of security planning creates unnecessarily high costs and project delays. Generally, it costs far less to "build security in" than it does to "bolt it on" at the end. And while the recent economic downturn will certainly drive security teams to focus on finding operational efficiencies, it is important to note that efficiencies alone will not be sufficient to get us out of the economic crisis the world is facing.*

**KEYWORDS:** *Innovation, Business, Information Security, Strategy.*

### INTRODUCTION

Information security is undergoing a critical transformation. Traditionally viewed as a necessary evil or worse, a hindrance to business advancement, now, more than ever, it is critical that security strategy aligns to business priorities and enables innovation. And while the recent economic downturn will certainly drive security teams to focus on finding operational efficiencies, it is important to note that efficiencies alone will not be sufficient to get us out of the economic crisis the world is facing. Political and business experts agree that business

innovation is key to the return of global economic stability and growth. And information security has a critical role to play in the drive toward innovation.

Why? Because at the heart of many critical innovations is the secure and fluid exchange of information. We are an information-centric economy, heavily dependent on the information we create and share; and we find ourselves in an age of digital warfare where that information is put at risk everyday. The goal of the security organisation must be to enable the business to safely manage risk to gain maximum business advantage.

**Security is a Balancing Act.** What does this mean for today's businesses? It is important to note that how organisations innovate has changed over time from internal groups working side-by-side creating new products in a lab to geographically dispersed teams collaborating across organisational and physical boundaries. Innovation now requires open collaboration, direct interaction with customers, tighter integration with partners, and the incorporation of external talent and resources.

It demands sharing intellectual property, infrastructure and ideas, while at the same time safeguarding trademarks, copyrights, and patents. Forward-thinking security leaders have made tremendous progress in driving tighter linkages between business innovation goals and security actions. A critical element has been taking a more structured and strategic approach to organisational risk assessment.

Without the right security strategy, business innovation could be stifled or put the organisation at great risk. But because the business and security teams operate in separate silos, security is often applied as an afterthought. This lack of security planning creates unnecessarily high costs and project delays. Generally, it costs far less to "build security in" than it does to "bolt it on" at the end. It is imperative that security teams understand key business priorities and ensure that they are brought into the planning process early. To do this they will need to speak the language of business, not security.

**Setting Risk Management in Motio.** Recently, there has been a growing recognition of the need to take a risk-based approach to security. Different organisations are at different stages along this progression, based not only on how they view information security and its importance to the business but also on the maturity of their enterprise risk management program. There are some preconditions that are essential to the success of any security team's efforts.

First, the organisation must already be using the construct of "risk" in how they make investment and operational decisions. Some organisations may not have the culture for a risk-based approach as their strategy is still too tactical or "targeted opportunity" focused. The other key prerequisite is that there has to be sustained attention from the top. If there is no attention for enterprise risk management or at least some notion of assessing risk at the board or senior leadership level, then trying to be effective in information risk management is likely beyond the organisation's current capability.

A key component of building a security program that enables innovation is moving from "information security" to "information risk management (IRM)." IRM must incorporate the idea that information security is striving for an acceptable level of risk. The goal is to match risk exposure to risk appetite, not wipe out all risk. Having specific expertise in information security per se is still a crucial part of the program as it is essential for determining the optimum security

controls. Managing information risks must be conducted in a way that is meaningful to the business and is based on how other categories of risk are discussed and calculated.

So IRM must be integrated into the enterprise risk management framework. As an example, let's look at risk management and innovation in the context of data loss prevention. Many organisations are increasingly using Web-based collaborative tools to facilitate information and knowledge sharing among various user groups in order to improve productivity and eliminate the duplication of efforts.

Often times, the information contained within these environments is very sensitive and can potentially be put at risk if accessed or changed by an unauthorised user. Determining what data is most sensitive or at highest risk and identifying where it resides is the first step in preventing enterprise data loss. But understanding risk becomes important when it's time to implement the controls to prevent data loss. This is the step where security professionals are challenged to establish what level of risk they are willing to accept without stifling the innovation process.

Each organisation must qualitatively and quantitatively answer the following: How does an organisation measure risk? What kinds of controls should be implemented to protect the data? Who should be able to have access or make edits to the document? What kind of actions should be allowed (i.e., can it be printed or saved to external media)? And finally, what kind of action should be taken if the data is inadvertently accessed, changed or an attempt is made to send it (i.e., notification, quarantine, encrypt)? Determining a reasonable risk threshold while avoiding unnecessary disruption to your employees is a delicate balancing act.

**The Time Is Now.** The time is now for security professionals to establish themselves as a "trusted business partner." Security practitioners need to move beyond applying the security technology du jour to meet the latest audit, and instead focus on supporting key business initiatives while meeting compliance objectives.

Security needs to be framed in a business context. Staying ahead of the business and being prepared to promote security as an accelerator rather than an inhibitor will ensure that security has its rightful place at the innovation table.

## LITERATURE

- [https://en.wikipedia.org/wiki/Silicon\\_Valley](https://en.wikipedia.org/wiki/Silicon_Valley).
- <http://www.kylbakov.ru/page110/page144/index.html>
- <http://tehprog.ru>

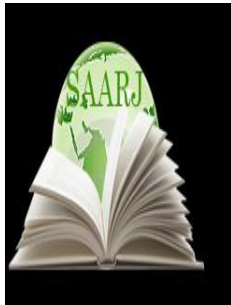

**ACADEMICIA**  
**An International  
 Multidisciplinary  
 Research Journal**  
 (Double Blind Refereed & Peer Reviewed Journal)



**DOI: 10.5958/2249-7137.2021.01222.2**

## E-GOVERNANCE IN INDIA: CONCEPT, INITIATIVES AND CHALLENGES

**Mrs. Anita\*; Dr. Pawan Kr. Sharma\*\***

\*Associate Prof,  
 Delhi College of Arts and Commerce,  
 University of Delhi, INDIA

\*\*Principal,  
 Dyal Singh Evening College,  
 University of Delhi, INDIA

### ABSTRACT

*While Governance relates to safeguarding the legal rights of all citizens, an equally important aspect is concerned with ensuring equitable access to public services and the benefits of economic growth to all. It also ensures government to be transparent in its dealings, accountable for its activities and faster in its responses as part of good governance. However, this would require the government to change itself – its processes, its outlook, laws, rules and regulations and also its way of interacting with the citizens. It would also require capacity building within the government and creation of general awareness about e-Governance among the citizens. This paper is an attempt to study the initiative taken by Govt. and issues and challenges faced in the successful implementation of its schemes.*

**KEYWORDS:** *Safeguarding, Implementation, Equitable*

### INTRODUCTION

#### CONCEPT

In India, the main thrust for e-Governance was provided by the launching of NICNET in 1987 – the national satellite-based computer network. This was followed by the launch of the District Information System of the National Informatics Centre (DISNIC) programme to computerize all district offices in the country for which free hardware and software was offered to the State Governments. NICNET was extended via the State capitals to all district headquarters by 1990.

In the ensuing years, with ongoing computerization, tele-connectivity and internet connectivity established a large number of e-Governance initiatives, both at the Union and State levels.

### **Types of Government Interaction in E-governance**

- **G2G:** Government to Government.
- **G2C:** Government to Citizen.
- **G2B:** Government to Business.
- **G2E:** Government to Employee

### **Some Initiatives Taken by Government**

- **Computerization of Land Records:** In collaboration with NIC. Ensuring that landowners get computerized copies of ownership, crop and tenancy and updated copies of Records of Rights (RoRs) on demand.
- **Admission to Professional Colleges – Common Entrance Test (CET):** With the rapid growth in the demand as well as supply of professional education, the process of admission to these institutions became a major challenge in the early 1990s. Recourse was then taken to ICT to make the process of admission transparent and objective.
- **Online admission process: Now the Govt. is emphasizing on the making admission process at all levels and courses across universities and professional and technical institutes online making it a transparent and easy for the admission seekers.**
- **MCA 21:** By the Ministry of Corporate Affairs. The project aims at providing easy and secure online access to all registry related services provided by the Union Ministry of Corporate Affairs to corporates and other stakeholders at any time and in a manner that best suits them.
- **E-office:** The Government of India has recognized the need to modernize the Central Government offices through the introduction of Information and Communications Technology. e-Office is aimed at increasing the usage of work flow and rule based file routing, quick search and retrieval of files and office orders, digital signatures for authentication, forms and reporting components.
- **UID:** The unique identification project was conceived as an initiative that would provide identification for each resident across the country and would be used primarily as the basis for efficient delivery of welfare services. It would also act as a tool for effective monitoring of various programs and schemes of the government.
- **Pensions:** The pensions MMP is primarily aimed at making the pension/ retirement related information, services and grievances handling mechanism accessible online to the needy pensioners, through a combination of interactive and non-interactive components, and thus, help bridge the gap between the pensioners and the government.
- **Banking:** The Banking MMP is yet another step towards improving operational efficiency and reducing the delays and efforts involved in handling and settling transactions. The MMP which is being implemented by the banking industry aims at streamlining various e-services

initiatives undertaken by individual banks. Implementation is being done by the banks concerned, with the banking Department providing a broad framework and guidance.

- **Crime and Criminal Tracking Network & Systems:** Crime and Criminal Tracking Network & Systems (CCTNS) MMP aims at creating a comprehensive and integrated system for enhancing the efficiency and effective policing at all levels and especially at the Police Station level through adoption of principles of e-Governance, and creation of a nationwide networked infrastructure for evolution of IT-enabled state-of-the-art tracking system.
- **Public Distribution System:** Computerization of the PDS is envisaged as an end-to-end project covering key functional areas such as supply chain management including allocation and utilization reporting, storage and movement of food grains, grievance redressal and transparency portal, digitization of beneficiary database, Fair Price Shop automation, etc.
- **E-procurement:** Ministry of Commerce & Industry (Department of Commerce) has been nominated as the Nodal Ministry for implementation of e-Government Procurement (e-GP) Mission Mode Projects (MMP). The vision of the e-Procurement MMP is “**To create a national initiative to implement procurement reforms, through the use of electronic Government procurement, so as to make public procurement in all sectors more transparent and efficient**”.
- **E-Courts:** The e-Court Mission Mode Project (MMP) was conceptualized with a vision to transform the Indian judiciary by making use of technology. The project had been developed, following the report submitted by the e-Committee under Supreme Court on national policy & action plan on implementation of information communication tools in Indian judiciary.
- A clear objective – to re-engineer processes and enhance judicial productivity both qualitatively and quantitatively to make the justice delivery system affordable, accessible, cost effective, transparent and accountable.
- **E-Biz:** The e-Biz Mission Mode Project, being executed by Department of Industrial Policy and Promotion (DIPP), Ministry of Commerce and Industry, Government of India, was conceptualized with the vision. Its vision is “**To transform the business environment in the country by providing efficient, convenient, transparent and integrated electronic services to investors, industries and business throughout the business life cycle**”.
- **Common Services Centres:** The CSCs would provide high quality and cost-effective video, voice and data content and services, in the areas of e-governance, education, health, telemedicine, entertainment as well as other private services. A highlight of the CSCs is that it will offer web-enabled e-governance services in rural areas, including application forms, certificates, and utility payments such as electricity, telephone and water bills.
- **Direct Cash transfer:** To facilitate disbursements of Government entitlements like NREGA, Social Security pension, Handicapped Old Age Pension etc. of any Central or State Government bodies, using Aadhaar and authentication thereof as supported by UIDAI.
- **Aadhar Enabled Payment system (AEPS):** AEPS is a bank led model which allows online interoperable financial inclusion transaction through the Business correspondent of any bank using the Aadhaar authentication. This has helped in financial inclusion. The four Aadhaar enabled basic types of banking transactions are as follows:-

- Balance Enquiry
- Cash Withdrawal
- Cash Deposit
- Aadhaar to Aadhaar Funds Transfer
- **Digital India program**
- **Digital Locker for every Indian:** Certificates issued by the government — education, residential, medical records, birth certificates, etc. — are to be stored in individual ‘digital lockers’ and a communication protocol established for government departments to access them without physically having to see the hard copy. The purpose of government is that copies of certificates issued by the government itself not to be carried around by people to government offices for various services.
- **Mobile Seva:** It aims to provide government services to the people through mobile phones and tablets. It has been developed as the core infrastructure for enabling the availability of public services through mobile devices. It enables a government department to integrate both web and mobile based services seamlessly and enhances the access to electronic services tremendously leveraging the very high penetration of mobile phones, especially in rural areas.

The list is endless and Govt. is making all efforts to make the digital India successful and making all the areas to be covered in the electronic area as far as possible.

### WHY E-GOVERNANCE?

Following are some of the main advantages of E-Governance.

- **Speed:** Technology makes communication speedier. Internet, Phones, Cell Phones have reduced the time taken in normal communication.
- **Cost Reduction:** Most of the Government expenditure is appropriated towards the cost of stationary. Paper-based communication needs lots of stationary, printers, computers, etc. which calls for continuous heavy expenditure. Internet and Phones makes communication cheaper saving valuable money for the Government.
- **Transparency:** Use of ICT makes governing process transparent. All the information of the Government would be made available on the internet. The citizens can see the information whenever they want to see. But this is only possible when every piece of information of the Government is uploaded on the internet and is available for the public to peruse. Current governing process leaves many ways to conceal the information from all the people. ICT helps make the information available online eliminating all the possibilities of concealing of information.
- **Accountability:** Once the governing process is made transparent the Government is automatically made accountable. Accountability is answerability of the Government to the people. It is the answerability for the deeds of the Government. An accountable Government is a responsible Government.

- **Convenience:** *E-Government brings public services to citizens on their schedule and their venue.*
- **Improved Customer Service:** *E-Government allows to redeploy resources from back-end processing to the front line of customer service.*
- **Increased access to information:** *E-Government improves the accessibility of government information to citizens allowing it become an important resource in the making the decisions that affect daily life and so it helps in empowerment of citizens*

### **The guiding principle for successful implementation of E-Governance projects**

- Form simplification and field reduction – Forms should be made simple and user friendly and only minimum and necessary information should be collected.
- Online applications and tracking - Online applications and tracking of their status should be provided.
- Online repositories - Use of online repositories e.g. for certificates, educational degrees, identity documents, etc. should be mandated so that citizens are not required to submit these documents in physical form.
- Integration of services and platforms – Integration of services and platforms e.g. Aadhaar platform of Unique Identity Authority of India (UIDAI), payment gateway, Mobile Seva platform, sharing of data through open Application Programming Interfaces (API) and middleware such as National and State Service Delivery Gateways (NSDG/SSDG) should be mandated to facilitate integrated and interoperable service delivery to citizens and businesses.

### ***Challenges before Govt.in successful implementation of e governance***

There are large numbers of potential barriers in the implementation of e-Governance. Some hindrance in the path of implementation, like security, unequal access to the computer technology by the citizen, high initial cost for setting up the e government solutions and resistance to change. Challenges identified as trust, resistance to change, digital divide, cost and privacy and security concerns.

#### **Trust**

Trust can be defined along two dimensions: as an assessment of a current situation, or as an innate personality trait or predisposition. The implementation of public administration functions via e-government requires the presence of two levels of trust. The first is that the user must be confident, comfortable and trusting of the tool or technology with which they will interact. The second dimension of trust pertains to trust of the government].

There has to be a balance between ensuring that a system prevents fraudulent transactions and the burden that extensive checks can take place on people who are honest. Recently, confidential information on military veterans was compromised when a computer containing their personal information was lost. This type of incident can erode trust and user confidence in government systems. Trust, along with financial security, are two critical factors limiting the adoption of e-government services.



**Resistance to change**

The innovation diffusion theory states that over time an innovation will diffuse through a population, and the rate of adoption will vary between those who adopt early, referred to as early adopters and to those who adopt the innovation much later, referred to as —laggards.

The resistant to change phenomenon can explain much of the hesitation that occurs on the part of constituents in moving from a paper based to a Web-based system for interacting with government. Citizens, employees and businesses can all have their biases with respect to how transactions should be processed. However, government entities and public policy administrators cannot ignore the changes that occur as a result of the implementation of information and communication technology (ICT). Education about the value of the new systems is one step toward reducing some of the existing resistance. It can also be particularly useful for a leader or manager, to buy into the new system at an early stage in the adoption process

**Digital Divide**

The digital divide refers to the separation that exists between individuals, communities, and businesses that have access to information technology and those that do not have such access. Social, economic, infrastructural and ethno-linguistic indicators provide explanations for the presence of the digital divide. Economic poverty is closely related to limited information technology resources

An individual living below poverty line does not afford a computer for himself to harness the benefits of e-government and other online services. As the digital divide narrows, broader adoption of e-government in the public domain becomes possible. Economic poverty is not the only cause of digital divide. It can also be caused by the lack of awareness among the people. Even some of the economic stable people don't know about the scope of e -governance. Awareness can only help to bring users to that service delivery channel once. It cannot guarantee sustained use of the system unless the system is also designed in such a way as to deliver satisfactory outcome. Procedures need to be simplified to deliver concrete benefits and clear guidelines provided to encourage their use by the actual end users and reduce user's dependence on middlemen/intermediaries

**Cost**

Cost is one of the most important prohibiting factor that comes in the path of e-governance implementation particularly in the developing countries like India where most of the people living below the poverty line. Elected officers and politician don't seem to be interested in implementing e-governance

**Privacy and Security**

There will be three basic levels of access exists for e-government stakeholders: no access to a Web service; limited access to a Web-service or full-access to a Web service, however when personal sensitive data exists the formation of the security access policy is a much more complex process with legal consideration. With the implementation of e-government projects, effective measures must be taken to protect sensitive personal information. A lack of clear security standards and protocols can limit the development of projects that contain sensitive information such as income, medical history.

## CONCLUSION

We have seen how the concept of e-governance and m-governance has evolved in Indian scenario and how much it is required for transparency and accountability on the part of government and at the same time it is also a toll to increase the participation of people in policy making by empowering them with the right information at right time. The penetration of internet, telecommunication services in India has increased in the last decade and this gives a ray of hope to the citizens of India to fight with the long persisting problems of poverty, corruption, regional disparity and unemployment. But at the same time, due to slow pace of project completion, red-tape and resistance from the side of government employees and citizens too has not given the desired result.

## BIBLIOGRAPHY

1. E-governance in India: Concept, Initiatives and Issues - INSIGHTS, [www.insightsonindia.com/.../e-governance-india-concept-initiatives-issue](http://www.insightsonindia.com/.../e-governance-india-concept-initiatives-issue)
2. E-Governance in India, [indiaegovernance.blogspot.com/](http://indiaegovernance.blogspot.com/)
3. E-Governance, National Portal of India, <https://india.gov.in/e-governance>
4. E-Governance: issues in implementation - [web.iiit.ac.in](http://web.iiit.ac.in)
5. E-Governance – Reforming Government through ... - Digital India, [digitalindia.gov.in/.../e-governance---reforming-government-through-te](http://digitalindia.gov.in/.../e-governance---reforming-government-through-te)
6. List of initiatives where the Government is providing Online Services, <https://factly.in/national-e-governance-plan-for-government-online-service>.

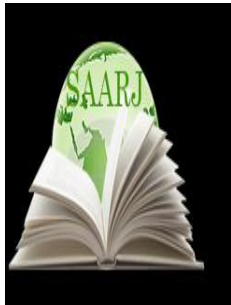

**ACADEMICIA**  
**An International**  
**Multidisciplinary**  
**Research Journal**  
 (Double Blind Refereed & Peer Reviewed Journal)



**DOI: 10.5958/2249-7137.2021.01148.4**

## THE USE OF MODERN INTERACTIVE PEDAGOGICAL TECHNOLOGIES IN PRIMARY SCHOOLS

**Oyshakhon Abdurasulova\***; **Abdullaeva Gavkharoy\*\***; **Ahmedova Mahfuza\*\*\***;  
**Siddikova Mamura\*\*\***

\*Teacher of secondary school,  
 Namangan, UZBEKISTAN

Email id: abdurashulovaoyshaxon@gmail.com

<sup>2</sup>Teacher of Namangan State University,  
 UZBEKISTAN

Email id: Ladymelody999@gmail.com

<sup>3</sup>Teacher of secondary school,  
 Namangan, UZBEKISTAN

---

### ABSTRACT

*The effective use of modern pedagogical technologies and interactive methods in the educational process has become one of the core issues in our country. The school teacher uses methods such as brainstorming, small group work, discussion, problem situation, design, role-playing, and practical exercises to open the content of the learning material, aimed at increasing pupils' interest and activity during the lesson. This article focuses on the effectiveness of organizing lessons using interactive methods in the classes of primary schools.*

**KEYWORDS:** *Method, Interactive Method, Pedagogical Technologies, Information And Communication Technologies, Interactivity.*

---

### INTRODUCTION

The word "technology" ("techno" in translation from Greek - skill, "logos" - science, concept) - the science of art and craftsmanship. In the explanatory dictionary of the Russian language defines: "Technology - a set of production methods and processes in the field of production, as well as a scientific description of production methods". The concept of "technology" came to pedagogy from the production environment, where it meant the process of organizing production, which allows you to get a specific part at the output. The technological approach in

pedagogy is associated with the precise definition and description of the goals of education, which allows you to more specifically achieve the intended results with all pupils, objectively assess the achievements and identify the problems of pupils.

The Uzbek dictionary defines the term "interactive" as based on the reception or transmission of information over a computer network. In Wikipedia, interactivity is evaluated as a concept that reveals the nature and level of interaction between objects and is said to be used in the fields of information theory, computer science and programming, telecommunications systems, sociology, industrial design, and so on. In a word, interactivity is the system of organizing the system, it is the parts of the system is to achieve a specific goal by establishing the exchange of information between. The interactive method is aimed at developing personal qualities, activating the acquisition of knowledge by increasing the activity between pupils and the teacher in the educational process. The use of interactive methods helps to increase the effectiveness of the lesson. The main criteria for interactive education are: informal discussions, the ability to freely express and express the learning material, a small number of lectures, but a large number of seminars, opportunities for pupils to take the initiative, small group, large group, assignment to work as a class team, written work and other methods, which have a special role in increasing the effectiveness of educational work.

Currently, one of the main directions in improving teaching methods is the introduction of interactive teaching and learning methods. All science teachers are increasingly using interactive methods in the classroom. As a result of the use of interactive methods, pupils develop the skills of independent thinking, analysis, drawing conclusions, expressing their opinions, defending them on the basis of reason, healthy communication, discussion, debate. In the process of interactive learning, the lesson is based on student interaction. The word interactive was derived from the English word, "Interact", i.e. Inter - means "interaction", "act" - means action, influence, activity. Interactivity is the interaction of two people, that is, the learning process takes place in the form of a dialogue, in the form of dialogue (computer communication) or on the basis of teacher-student interaction. Interactivity - occurs in interaction, movement, sensitivity, student-teacher, student-student (subject-subject) conversations.

The main goal of interactive methods is to create an environment conducive to the student's active, free, creative thinking, to activate his needs, interests, inner potential by creating the most favorable environment for the shooting process. Such lessons take place in such a way that in the process, no student is left out, and has the opportunity to openly express their thoughts on what they have heard, read and seen. Pupils develop a desire to learn, interest in each other, friendly relations are formed. Interactive methods that are considered modern in foreign language teaching methodology have been developed by scientists and have proven to be more effective than traditional methods. Interactive methods significantly increase the cognitive potential of the learning process compared to traditional methods.

The design of new technologies involves the use of methods of a task approach, internal dialogue and imitation games that require the activity of the personal structures of pupils' consciousness. When the activity makes sense, the child's cognitive action also acquires meaning and new, stronger motivation. The meaning of imitation-game situations is the ability, while playing, to solve the proposed tasks and freely express creative forces. This is especially true for primary school pupils, as the need for play remains strong when they arrive at school.

There are many types of interactive lessons, which are selected and prepared according to the characteristics of the subject and the intended purpose. There are specific requirements for the preparation of pupils to participate in interactive lessons, which include the acquisition of knowledge necessary for active participation in the lesson, readiness for communication, collaboration, independent thinking, self-expression and skills of free expression and defense, and so on. Efficient use of time in training is a prerequisite. It is necessary to properly select, prepare the necessary tools and clearly define the trainers and their responsibilities. There are specific differences between interactive methods and traditional teaching methods, and each teacher should compare these differences, their advantages and disadvantages in relation to each other, in choosing the methods of lesson planning and conduct. In this case, the most appropriate interactive for the transfer of new knowledge, the formation, development, consolidation of skills, repetition of knowledge, practical training, as well as for training on each topic, taking into account the specifics of the subject or the correct choice of other techniques. The application of properly selected techniques will ensure that the training is fun and effective.

Taking into account the "biology of attention", it is recommended that primary school teachers structure their lessons in such a way that only 20% to 40% of the study time requires intense attention of pupils. This means that after intensive work, teachers must take care of a break, during which the parts of the brain that were not previously working during the training session are activated. If pupils are continuously mastering new material that requires a high concentration of attention, then there comes a time when they cannot connect the new with the already known, cannot assess it and think over the conclusions. Breaks in the study process are not an empty time, but a necessity. Lessons in primary school need a special rhythm - the oscillation between immersion in a new experience and consolidation of what has been received.

According to the scholars of pedagogy and psychology, if the phase of concentrated learning lasts 10-15 minutes, you need to expect that the processing time of the material will take from 2 to 5 minutes. This period can be organized in different ways. Pupils can discuss their learning experiences with partners in small groups, can reflect on it alone, or completely get drawn out of school by engaging in specially organized activities that promote a balance of mind and body.

On average, children of seven to eight years old can intensively, without interruption, study for 15-20 minutes, no more. Children of nine to twelve years old - within 15-25 minutes, after that there must be a pause. The alternation of unfamiliar, unusual actions and ritual actions is especially important, but, according to psychologists, no more than threefold. Switching attention is necessary, but numerous do not relax, but, on the contrary, tire. It is noted among the moments that prevent the successful course of gaming activity, gaming fatigue. It occurs in the case of a very long game or during repetitive types of games, their uniformity and frequent use. The second case of the appearance of gaming fatigue is associated with a psychological incompatibility between players.

It is important to alternate technologies and observe the limitation in their number. However, the teacher should be aware that, along with attractive features, new gaming technologies may become undesirable for pupils. Pupils may experience negative emotions: fear of the possibility of being incapable of solving game problems, fears about relationships with other players, if the technology is competitive in nature, and worries about possible defeat are added to this. Therefore, it is very important for a teacher to give the student the opportunity to gain positive experience, help some participants to adapt, provide for encouragement, and think over options

for dividing pupils into groups. Newness brings joy, surprise and relieves tension; rituals create a sense of stability and predictability.

### CONCLUSION

The task of a primary school teacher is to build a lesson in such a way as to introduce an element of novelty into classes, to be able to cheer up pupils in time, relieve stress, concentrate attention and help them move from one learning situation to another. If we believe that learning is not only the transfer of knowledge, but also the creative process of human interaction, then by creating an atmosphere of understanding and mutual support in the group, we thereby form a positive attitude towards learning of children. The current stage of development of educational technology is characterized by the widespread use of interactive teaching methods in the educational process. In short, a teacher who aims to ensure the effectiveness of the lesson will achieve his or her goal only if he or she skillfully uses interactive teaching methods in their place.

### REFERENCES:

1. Abdullayeva Q. et.al. "Reading" 2nd grade, T. 2006
2. Abdullayeva K., et.al. "Literacy lessons" T, "Teacher" 1996.
3. Abdullayeva K. and others "Reading lessons in the 2nd grade", T., 2004
4. Azizhudjayeva N.N. Pedagogical technologies and pedagogical skills. Tashkent. 2006.
5. Abdullayeva K., etc. "Mother tongue" T., "Teacher" 1999.
6. Bori Ziyamammedov, Mamarajab Tadjiev. Pedagogical technology is a modern Uzbek national model. Tashkent. 2009.
7. [www.wikidepia.uz](http://www.wikidepia.uz)

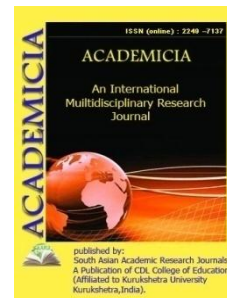
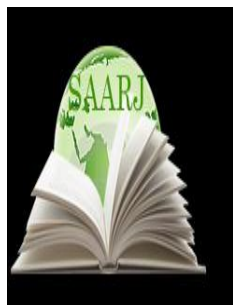

DOI: [10.5958/2249-7137.2021.01147.2](https://doi.org/10.5958/2249-7137.2021.01147.2)

## COMPARATIVE EVALUATION OF THE APPLICATION OF CALCIUM HYDROXIDE AND MATERIAL ON THE BASIS OF MINERAL TRIOXIDE OF THE BIO-DENT UNIT IN THE TREATMENT OF DEEP CARIES WITH TEMPORARY TEETH WITH LOW INVASIVE METHODS

**Nigora Djuraeva\***

\*Andijan State Medical Institute, Andijan,  
UZBEKISTAN

### ABSTRACT

*The aim of the work was to evaluate the comparative clinical efficacy of the use of a material based on calcium hydroxide, which has successfully proven itself in pediatric dental practice, and the innovative material "Bio-Dent" (DentalsPfarma), the experience of which is limited in the treatment of deep caries of deciduous teeth using minimally invasive methods. Clinical studies were carried out on the basis of the Department of Hospital and Clinical Dentistry at the Children's Regional Dental Clinic in Andijan. The basis for the clinical analysis was the data obtained during the examination and treatment of 52 somatically healthy children 4 - 5 years of age with a compensated form of caries. Summarizing the results of the studies, it was concluded that the use of the "Bio-Dent" material in the teeth of temporary occlusion is the most effective and promising in the treatment of deep caries while maintaining the vitality of the pulp.*

**KEYWORDS:** *Children, Temporary Teeth, Deep Caries, Calcium Hydroxide, "Bio-Dent"*

### INTRODUCTION

At the reception of a pediatric dentist, the diagnosis of deep caries in milk teeth is made with great caution and very rarely. According to T.F. Vinogradova (1987), with an active course of caries, replacement dentin does not have time to form and with deep carious cavities, there are direct pathological changes in the pulp comparable to pulpitis. Thus, in the temporary teeth T. F. Vinogradova and co-authors propose to diagnose deep perforated pulpitis. [6].

Other authors are less categorical regarding the diagnosis of deep caries. They explain this by the fact that during the period of stabilization of the growth of a temporary tooth in a somatically

healthy child, especially when the carious cavity is located on the chewing surface, such a diagnosis is quite justified (Ya.F. Kominek, 1968; A.A. Kolesov et al., 1991) It is known that the structure of hard tissues of milk teeth has certain anatomical and physiological features (smaller volume, wide dentinal tubules, the presence of low-mineralized zones of dentin, which in the form of wide strips of interglobular dentin reach the border of the pulp) contributing to the rapid spread of the infectious process and the development of complications even with a small depth of the carious cavity. Therefore, it is more justified to consider deep caries of a temporary tooth as a subclinical pulpitis, when, in the absence of clinical symptoms, serious morphological changes are observed in the pulp. At the same time, the primary task is to preserve the vitality of the pulp of the temporary tooth with minimal invasive intervention. The key to success in this situation is the selection of the most optimal material as a medical pad.

For many years, calcium hydroxide has been considered the most effective agent used to "heal" the pulp and restore dentin when the pulp is damaged by caries, trauma, or therapeutic intervention. Due to its high pH, calcium hydroxide has pronounced bactericidal properties, neutralizes the acidic products of bacteria, creates good conditions for dentin repair, and also has the ability to mobilize growth factors of the dentin matrix, which causes the formation of new dentin [1]. Recently, new high-tech materials such as mineral trioxide have appeared. unit (MTA®), Trioxident (VladMiVa), Biodentine™ (Septodont), TheraCalLC (BISCODental Products), etc. According to the literature, MTA® stimulates the formation of dentinal bridges, protecting exposed pulp more effectively than calcium hydroxide.

According to various hypotheses, the dentinogenesis caused by it may be associated with its bio-capacity, the ability to maintain marginal integrity and a temporary increase in the pH index [3]. Bio-Dent is a new calcium silicate-based material belonging to the same class as MTA®, similar in characteristics to some Portland cement derivatives. From a biological point of view, it has good compatibility and is capable of causing reparative dentin deposition by stimulating the activity of odontoblasts and cell differentiation, can serve as an artificial dentin substitute and used as a material for direct and indirect pulp capping [2,4].

**Aim of the study.** The purpose of our work was a comparative assessment of the clinical efficacy and feasibility of using a material based on calcium hydroxide, an innovative material "Bio-Dent" (DentalsPfarma) that has proven itself successfully in pediatric dental practice, the experience of which is insufficient in the treatment of deep caries (subclinical pulpitis) of temporary teeth by minimally invasive method of indirect pulp covering.

## **MATERIALS AND METHODS**

Clinical studies were carried out on the basis of the Department of Hospital and Clinical Dentistry in the children's regional dental clinic in Andijan.

The basis for the clinical analysis was the data obtained during the examination and treatment of 48 somatically healthy children 4 - 5 years of age with a compensated form of caries, satisfactory oral hygiene and a clinically established diagnosis: acute deep caries of temporary molars. The diagnosis was established on the basis of anamnesis data, clinical instrumental and X-ray examination. Parents of young patients were familiarized with the treatment plan and gave written consent to participate in the study. Two groups of patients were formed, 26 children in each group, a total of 68 teeth were cured (33 in the first group and 35 in the second group). Before starting treatment, all patients underwent professional oral hygiene and were given



recommendations for oral care. The dissection of the carious cavity was carried out with great care (in most cases, without the use of local anesthesia). With the help of a ball-shaped bur or an enamel knife, the eroded enamel was removed in order to widely open the carious cavity. The softened dentin was removed with an excavator, first from the walls of the carious cavity, controlling the degree of density by probing. At the bottom of the carious cavity, a small amount of light softened dentin was retained and the damaged dentin was considered as the wound surface of the tooth pulp. During instrumental treatment, the carious cavity was irrigated, if possible, with warm (t-37C) sterile saline solution. After isolation, the tooth cavity was dried with a sterile cotton swab without pressure. Then the patients of the first group were placed on the bottom of the cavity with a paste of calcium hydroxide Calcevit (Vladmiva) and a temporary filling made of glass ionomer cement, and in patients from the second group, the entire cavity was filled with Bio-Dent material (The second visit was appointed after 3 weeks. In the absence of complaints and pathological changes on the side of the tooth and on the X-ray, the treatment was completed. In the first group, a temporary filling with a medical bandage was removed, the cavity was irrigated with saline solution, dried, a thinner layer of Calcevit material was applied, an insulating pad made of modified GIC and a permanent filling from a compomer were applied.

In the second group, only the surface layer of the “Bio-Dent” material was removed (up to the enamel-dentin border) and after cleaning the cavity from sawdust, the tooth was restored with a computer. Control examinations were carried out every three months throughout the year. During the examinations, complaints, color and mobility of the tooth, the condition of the gums, clinical symptoms of the state of the pulp (its reaction to stimuli), the condition of the filling (integrity, marginal adhesion) and changes in the radiograph were assessed.

## RESULTS AND DISCUSSIONS

Currently, a pediatric dentist should not only be aware of new filling materials, but also be able to choose the most optimal tactics for treating teeth in children, analyzing existing and new clinical experience.

In practice, we are increasingly using the principle of minimal invasive treatment of dental caries with subsequent clinical and radiological control. With the development of modern dentistry, the absolute removal of all altered and even infected tissues is not necessary to stop the carious process. This is especially important when it comes to temporary teeth. If a healthy child has even a deep carious cavity in a formed milk tooth, there is always hope for the potential of the pulp.

Studies by a number of authors have shown that hermetically sealed cavities with left carious dentin give a small percentage of recurrence and an absolute decrease in the number of microorganisms. Remineralization of the remaining carious dentin was proved by biochemical methods and X-ray observations. In these studies, calcium hydroxide pads were used. [4].

A significant disadvantage of materials based on calcium hydroxide is that it can be destroyed by the dentinal fluid flowing through the underlying dentinal tubules, since a constant current of the dental cerebrospinal fluid can facilitate the diffusion of the components of the paste along the concentration gradient. The unregulated process of dentin formation can lead not only to the formation of conglomerates (denticles) in the tooth cavity, which, mechanically acting on the pulp, can cause its inflammation, but also to complete calcification of the coronal and root pulp and obliteration of the root canals.

The mechanism of action of cements based on calcium silicate, for example, Bio-Dent material, implies the release of calcium hydroxide with a basic pH value at the impermeable boundary of the material and dentin, as well as the resistance of the material to dissolution, eliminating the need for re-intervention. Despite the small amount of clinical data associated with the recent appearance of this material, animal studies convincingly indicate the positive qualities of the Bio-Dent material in terms of preserving the vitality of the pulp, the formation of dentinal bridges and the absence of complications (internal resorption). According to the manufacturer's data, Bio-Dent is compatible with all direct and indirect restorations and with all bonding systems. The remaining "Bio-Dent" can be treated as artificial dentin and remain in the deep cavity.

The research results showed a good therapeutic effect in both the first and second groups of patients. Dentin during the second opening of the tooth cavity using calcium hydroxide can be described as drier, harder and darker.

When using "Bio-Dent" material, the tooth cavity, according to the manufacturer's recommendation, was not re-opened. The condition of the bottom of the carious cavity was assessed radiographically. A month later, the radiographs showed a compaction of the bottom of the cavity in most cases. Clinically and radiographically, it was found that in the first group, out of 33 treated teeth, the carious process was arrested in 26 cases, in the second group - in 31 cases (out of 35 teeth). Thus, the effectiveness of treatment in the first group was 78%, in the second group - 87%. Also, in children of the second group, a smaller number of fillings with impaired marginal adhesion were revealed: 3 cases out of 32 treated teeth. While in the patients of the first group, the loss of the filling and the violation of its integrity was observed in 7 cases out of 33.

Based on our experience, the use of Bio-Dent material is much more convenient compared to the use of calcium hydroxide, does not require an insulating pad and is easier for children to tolerate, since the cavity is not reopened to excavate the treatment pad and replace it.

## CONCLUSION

Summarizing the results of the clinical observations, we can conclude that the use of the Bio-Dent material in the teeth of temporary occlusion is the most effective (in comparison with the widely used calcium hydroxide) and promising in the treatment of deep caries and the preservation of pulp vitality. In addition to the effectiveness of the Bio-Dent material, the advantage of the drug is its ease of use and its budgetary nature, which gives reason to recommend this drug for the treatment of deep caries of deciduous teeth using minimally invasive methods as an alternative to imported drugs of this category.

## REFERENCES:

1. Results of biological treatment of deep caries. Innovation in dentistry. Materials of the VI Congress of Dentists of Belarus. (Minsk, October 25-26). / Manak T.N. Savostikova O.S., Chernysheva T.V.
2. I, Laurent P, Teclas O. Bioactivity of Biodentine™: a Ca<sub>3</sub>SiO<sub>5</sub>-based Dentin Substitute. Oral session, IADR Congress 2010 July, Barcelona Spain, American Academy on Pediatric Dentistry Clinical Affairs Committee-Pulp Therapy subcommittee; American Academy on Pediatric Dentistry Council on Clinical Affairs. Guideline on pulp therapy for primary and young permanent teeth. *Pediatr Dent.* 2008-2009; 30 (7 Suppl): 170-4.

3. Saidon J., He J., Zhu Q., Safavi K., Spangberg L. Cell and tissue reactions to mineral trioxide aggregate and Port-land cement. *Oral Surg Oral Med Oral Pathol Oral Radiol Endod.* 2003; 95: 483-489.
4. Deery C. Mineral trioxide aggregate a reliable alternative material for pulpotomy in primary molar teeth. Is mineral trioxide aggregate more effective than formocresol for pulpotomy in primary molars? *EvidBased Dent.* 2007; 8 (4): 107.
5. Shayegan A., Petein M., VandenAbbee A. CaSiO, CaCO, ZrO (Biodentine™): a new biomaterial used as pulp-capping agent in primary pig teeth. Poster at IADT 16th World Congress Dental Traumatology, 2010 June Verona Italy
6. Vinogradova T.F. *Pediatric dentistry M. "Medicine" 1987*

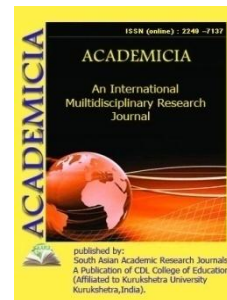
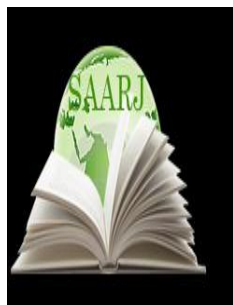

DOI: **10.5958/2249-7137.2021.01166.6**

## THE RESULTS OF NEUTRON-ACTIVATION ANALYSIS OF THE ATMOSPHERE IN THE SOUTHERN REGIONS OF CENTRAL ASIA

Turaev Ergash Yuldashevich\*; Haydarova Muharram\*\*

\*Professor of Termez State University,  
UZBEKISTAN

\*\*Master's Student,  
Termez State University,  
UZBEKISTAN

### ABSTRACT

*This article analyses the migration of harmful substances based on the use of physical methods in the study of environmental problems including the laws of their long-range distribution, the state of the environment in the regions, the presence of excess and foreign elements in soil, water and atmosphere. The results of the artificial environmental problem in the southern regions of Uzbekistan and its impact on the national economy are well documented.*

**KEYWORDS:** *Region, Ecology, Global, Local, Aerosol, Gas Phase, Particulate Matter, Adverse State, Harmful Substances, Heavy Elements, Atoms, Ions, Fluid, Compounds, Migration.*

### INTRODUCTION

Under the influence of anthropogen on the atmosphere in the process of human development in the current conditions, the main source of its pollution is the people. As a result of the global, regional or local environmental problems is arisen there will be problems for humanity again. Pollution of the atmosphere occurs mainly as a result of the release of various wastes of plants and factories into the air. Also, the drastic changes that occur in nature under human influence are also the source of environmental problems. An example of this is the emergence of the ecological problem of the island and the Aral Sea on the basis of unplanned consumption of Amudarya and Sirdarya waters on the basis of the concept of agricultural development in the 60-80 years of the 20th century of the states located in Central Asia. This environmental problem is of a global nature and has led to a sharp increase in the level of pollution of the Earth and the

atmosphere in the regions of many more countries, except for the countries that are currently located in Central Asia.

## **MATERIALS AND METHODS**

If 50-55 cubic km of the volume of water was supplied by the Amudarya and Syrdarya to the Aral Sea every year, the Aral Sea had been preserved. For the last 50 years, the Amudarya and Syrdarya have flowed into the Aral Sea 6-8 cubic km per year. The size of the Aral Sea has now decreased by 70-75% due to the supply of water. As a result, an area of about 5 million grams was separated from the seabed and became a source of ecological environment. The human beings who caused such problems are responsible for preservation. Surkhandarya region, the southernmost part of the Republic of Uzbekistan, has environmental problems of natural and man-made regional scale. Climatic conditions and geographical environment in the northern region of Surkhandarya region are very different from the southern region. There are similar climatic conditions in Shurchi, Altynsay and Uzun districts. Therefore, the region is densely populated. These areas also have their own environmental problems, the solution of which remains a topical issue. The main source of environmental problems that threaten the northern regions is the Tajik aluminum plant[1].

The plant was built only 10 km from the border of the region with Tajikistan, this enterprise is located at an altitude of 500-600 meters above sea level, and the gas aerosol and par-gas poisonous substances separated from it spread all year round to the Surkhondarya region. At present, these toxic substances have been able to poison most of the districts of Sariosia, Uzun, even the most important parts of the districts of Denov, Altinsoy, Shurchi [2]. As a result, there are serious problems in agriculture and animal husbandry. Horticulture and vegetable crops have failed, and some crops have been poisoned. Livestock productivity has fallen sharply and these toxins are having a negative effect on the human race. The incidence of the disease in the population has increased, and these poisonous substances adversely affect the offspring of humans. Among the harmful substances coming out of the plant, the atoms of heavy elements, the combination of toxic hydrogen fluoride with ions, are also dangerous to human health[3-4].

On the basis of the use of physical methods in the study of this environmental problem, the migration of harmful substances, the legality of the distribution of their quantity by distance, was studied. The results obtained with the help of neutron-activation analysis, nuclear gamma resonance spectroscopy and Potentiometric research methods show that the amount of harmful substances coming out of the Tajik aluminum plant exceeds the amount authorized in the northern region of the Surkhandarya region from 4 to 12 times of permission amount (PA), water, it was determined by the composition of the soil and atmosphere. According to the results obtained, it was found that harmful substances spread from 25 km to 60 km. Experiments have shown that the combination of HF has reached all regions of the districts of Sariosia and Uzun. It was found that the combination of HF in the 40-50 area of the denov and Altinsay districts is much more than the amount allowed. Even in the northern part of the Shurchi district, an increase in the amount of HF accumulation was confirmed in experiments. Experiments confirmed an increase in HF in the northern part of Shurchi district. indicates that this toxin affects the development of the national economy in the region. [5]

## RESULTS AND DISCUSSIONS

The experiments also revealed the annual migration of HF compounds and other harmful substances. The results show that the migration of harmful substances is influenced by climatic conditions, meteorological conditions. Wind direction and speed, humidity, precipitation and, most importantly, air temperature have a significant impact on migration. Experiments show that in the warmer months of the year (June-July-August), harmful substances spread over long distances. Considering that the summer temperature in the northern regions of the region is above 35-40, it can be seen that the harmful gases from the Tajik aluminum plant poison many areas in the northern region.

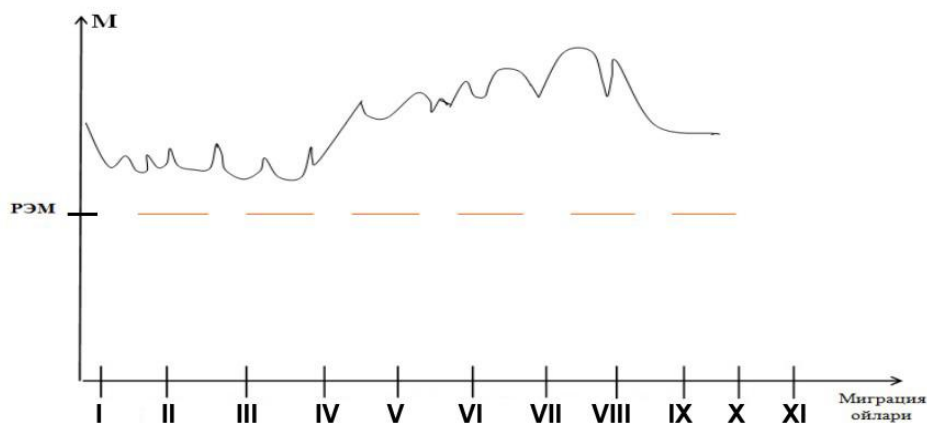

**Figure 1:** Graph of annual distribution of HF compounds in the northern regions of Surkhandarya region (PA-permissible amount)

Also, the harmful substances emitted from this plant include atoms of heavy elements (for example: P<sub>v</sub>) in the Mendeleev periodic table, various heavy ions, as well as aerosol-vapor emissions from the plant, which cause great damage to crops and livestock, as well as the local population. The experiments have shown that it has a strong effect on health. The following table shows the distance distribution of harmful substances emitted from the plant in the aerosol-vapor state in the territory of Surkhandarya region.

**TABLE 1 CONDITION OF HARMFUL SUBSTANCES EMITTED FROM THE TAJIK ALUMINUM PLANT**

№	Place of control	Aerosol phase	Par gas phase
1	Around the factory	65 %	35 <input type="checkbox"/>
2	10 km from the factory	18 <input type="checkbox"/>	82 <input type="checkbox"/>
3	25 km from the plant	15 <input type="checkbox"/>	85 <input type="checkbox"/>
4	40 km from the plant	10,5 <input type="checkbox"/>	89,5 <input type="checkbox"/>
5	55 km from the plant	5,7 <input type="checkbox"/>	94,3 <input type="checkbox"/>

It shows how far and in what condition the harmful substances reach. As a result of studying the environmental problems artificially created by the Tajik aluminum plant, which continues to

poison various regions of Surkhandarya region, including 1.5 million people, regardless of their condition.

### **CONCLUSION**

The restoration of the natural environment in the southern region of Uzbekistan, providing full information about living organisms and the source of this environmental problem affecting nature is the most important information for future generations.

### **REFERENCES:**

1. Misirov Sh.Ch. Potentiometric methods for determining the distribution of fluorides in the atmospheric air. Candidate dissertation. - T.1996.
2. Nishonkhodzhaeva S.A. Assessment of the impact of emissions of Tad.AZ on terrestrial vegetation. Research report for 1989-T. SarNIGMI.
3. Turaev E.Yu. Niyozova O.A. Ecological situation in the northern regions of Uzbekistan. 5th Scientific-Practical Conference of the Republic.-Termez 2017.168-169
4. Niyozova O.A. Turaev E.Yu. Neutron activation analysis of the composition of the atmosphere in the southern regions of the Middle Azim. 6th Scientific-Practical Conference of the Republic.-Termez, 140-141
5. Turaev, E.Y, Raimov, G.F. Ecological problems in the northern regions of Surkhandarya region and physical methods of their study. Materials of the Republican scientific-practical conference –Termez 2014 479-481

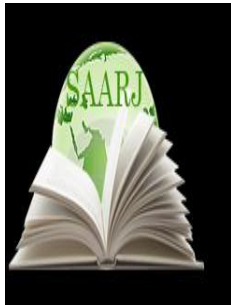

**ACADEMICIA**  
**An International  
 Multidisciplinary  
 Research Journal**  
 (Double Blind Refereed & Peer Reviewed Journal)



**DOI: 10.5958/2249-7137.2021.01165.4**

## ANALYSIS OF THE CIRCUITS OF THE ELECTROMAGNETIC PRIMARY CURRENT AND VOLTAGE OF THE CONTROL AND CONTROL SYSTEMS

**A.B.Abubakirov\***; **M.N.Bekimbetov\*\***; **R.J.Seytimbetov\*\*\***; **Sh.B.Kuatova\*\*\*\***

<sup>1,4</sup>Karakalpak State University named after Berdak,  
 Nukus, UZBEKISTAN

### ABSTRACT

*Conversion circuits and designs of electromagnetic current and voltage converters of monitoring and control systems for quantities and parameters of power supply as new physical and technical effects are used, sets the task of their systematization and selection of parameters of their elements and design. The paper presents the materials for the study of circuits and the design of the transformation of the primary electromagnetic converter of electric current and voltage in power supply systems.*

**KEYWORDS:** *Physical And Technical Effect, Control, Circuit, Control, Current, Voltage, Parameter, Power Supply, Converter, Magnetic Circuit.*

### INTRODUCTION

The values and parameters in the designs of the primary electromagnetic current and voltage converter of electrical energy of power supply systems are distributed in the transformation space, which, depending on the purpose and purpose, have a complex geometric configuration. Given the distribution, heterogeneity, nonlinearity, etc. values, parameters, nature of the environment and space of transformation of electromagnetic converters of primary electric current and voltage of the power supply system, one can imagine that their study and calculation in full is a difficult task even with the widespread use of modern computing systems.

Designs of elements and conversion circuits of primary electromagnetic current and voltage converters, the number of which is continuously increasing as various physical and technical effects are used in them, the problem of their systematization and the choice of rational values and conversion parameters and a design that meets the requirements of modern control and management of quantities and parameters is determined power supply systems.



In the presented graph model, the conversion areas of the primary electromagnetic current and voltage converter are the conversion factors for each phase output voltage  $W_a(x, y, z, t)$ ;  $W_b(x, y, z, t)$  and  $W_c(x, y, z, t)$  is determined based on the following analytical expressions:

$$\begin{aligned} \frac{F_{\mu 11} - F_{\mu 12}}{\Pi_{\mu 11}} + \frac{F_{\mu 11} - F_{\mu 12}}{\Pi 1_{\mu 11}} &= K_{IF_A} I_A \\ \frac{F_{\mu 12} - F_{\mu 11}}{\Pi_{\mu 11}} + \frac{F_{\mu 12} - F_{\mu 22}}{\Pi 1_{\mu 12}} &= -K_{FU_a} U_a \\ \frac{F_{\mu 21} - F_{\mu 11}}{\Pi 1_{\mu 11}} + \frac{F_{\mu 21} - F_{\mu 22}}{\Pi_{\mu 21}} &= K_{IF_B} I_B \\ \frac{F_{\mu 22} - F_{\mu 21}}{\Pi_{\mu 21}} + \frac{F_{\mu 22} - F_{\mu 32}}{\Pi 1_{\mu 22}} &= -K_{FU_b} U_b \\ \frac{F_{\mu 31} - F_{\mu 21}}{\Pi 1_{\mu 21}} + \frac{F_{\mu 31} - F_{\mu 32}}{\Pi_{\mu 31}} &= K_{IF_C} I_C \\ \frac{F_{\mu 32} - F_{\mu 31}}{\Pi_{\mu 31}} + \frac{F_{\mu 32} - F_{\mu 22}}{\Pi 1_{\mu 22}} &= -K_{FU_c} U_c \end{aligned}$$

in the form of a system of equations

$$\begin{aligned} \left( \frac{1}{\Pi_{\mu 11}} + \frac{1}{\Pi 1_{\mu 11}} \right) F_{\mu 11} - \frac{1}{\Pi_{\mu 11}} F_{\mu 12} - \frac{1}{\Pi 1_{\mu 11}} F_{\mu 21} &= K_{IF_A} \cdot I_A \\ -\frac{1}{\Pi_{\mu 11}} F_{\mu 11} + \left( \frac{1}{\Pi_{\mu 11}} + \frac{1}{\Pi 1_{\mu 12}} \right) F_{\mu 12} - \frac{1}{\Pi 1_{\mu 12}} F_{\mu 22} &= -K_{FU_a} U_a \\ -\frac{1}{\Pi 1_{\mu 11}} F_{\mu 11} + \left( \frac{1}{\Pi 1_{\mu 11}} + \frac{1}{\Pi_{\mu 21}} \right) F_{\mu 21} - \frac{1}{\Pi_{\mu 21}} F_{\mu 22} &= K_{IF_B} \cdot I_B \\ -\frac{1}{\Pi_{\mu 21}} F_{\mu 21} + \left( \frac{1}{\Pi_{\mu 21}} + \frac{1}{\Pi 1_{\mu 22}} \right) F_{\mu 22} - \frac{1}{\Pi 1_{\mu 22}} F_{\mu 32} &= -K_{FU_b} U_b \\ -\frac{1}{\Pi 1_{\mu 21}} F_{\mu 21} + \left( \frac{1}{\Pi 1_{\mu 21}} + \frac{1}{\Pi_{\mu 31}} \right) F_{\mu 31} - \frac{1}{\Pi_{\mu 31}} F_{\mu 32} &= K_{IF_C} \cdot I_C \\ -\frac{1}{\Pi_{\mu 31}} F_{\mu 31} + \left( \frac{1}{\Pi_{\mu 31}} + \frac{1}{\Pi 1_{\mu 22}} \right) F_{\mu 32} - \frac{1}{\Pi_{\mu 22}} F_{\mu 22} &= -K_{FU_c} U_c \end{aligned}$$

Where:

$$\begin{aligned}
 A_{11} &= \frac{1}{\Pi_{\mu 11}} + \frac{1}{\Pi 1_{\mu 11}}; A_{12} = -\frac{1}{\Pi_{\mu 11}}; A_{13} = -\frac{1}{\Pi 1_{\mu 11}}; A_{14} = A_{15} = A_{16} = 0; \\
 A_{21} &= -\frac{1}{\Pi_{\mu 11}}; A_{22} = \frac{1}{\Pi_{\mu 11}} + \frac{1}{\Pi 1_{\mu 12}}; A_{23} = 0; A_{24} = -\frac{1}{\Pi 1_{\mu 12}}; A_{25} = A_{26} = 0; \\
 A_{31} &= -\frac{1}{\Pi 1_{\mu 11}}; A_{32} = 0; A_{34} = -\frac{1}{\Pi 1_{\mu 21}}; A_{35} = A_{36} = 0; \\
 A_{41} &= A_{42} = 0; A_{43} = -\frac{1}{\Pi_{\mu 21}}; A_{44} = \frac{1}{\Pi_{\mu 21}} + \frac{1}{\Pi 1_{\mu 22}}; A_{45} = 0; A_{46} = -\frac{1}{\Pi 1_{\mu 22}}; \\
 A_{51} &= A_{52} = 0; A_{53} = -\frac{1}{\Pi 1_{\mu 21}}; A_{54} = 0; A_{55} = \frac{1}{\Pi_{\mu 31}} + \frac{1}{\Pi 1_{\mu 21}}; \\
 A_{61} &= A_{62} = A_{63} = 0; A_{64} = -\frac{1}{\Pi_{\mu 22}}; A_{65} = -\frac{1}{\Pi_{\mu 32}}; A_{66} = \frac{1}{\Pi_{\mu 32}} + \frac{1}{\Pi 1_{\mu 22}};
 \end{aligned}$$

$$\Pi_{\mu 11} \div \Pi_{\mu 31} = \Pi 1_{\mu 11} \div \Pi 1_{\mu 33} = \frac{l_{\mu i}}{\mu_i S_i}$$

$l_{\mu}$  - path length  $i$  – current sections of magnetic flux,  $m$ ;

$\mu_i$  or  $\mu_{0i}$  - magnetic permeability  $i$  – current plots;

$S$  - section plots  $m^2$ ,  $i$  – current sections of the conversion circuit.

The limits are defined as follows:

$$\begin{aligned}
 B_1 &= K_{IF_A} \cdot \overset{\square}{I}_A; B_2 = -K_{FU_a} \cdot \overset{\square}{U}_a; B_3 = K_{IF_B} \cdot \overset{\square}{I}_B; B_4 = -K_{FU_b} \cdot \overset{\square}{U}_b; B_5 = K_{IF_C} \cdot \overset{\square}{I}_C; \\
 B_6 &= -K_{FU_c} \cdot \overset{\square}{U}_c.
 \end{aligned}$$

or in matrix form

$$\begin{bmatrix}
 A_{11} & A_{12} & A_{13} & A_{14} & A_{15} & A_{16} \\
 A_{21} & A_{22} & A_{23} & A_{24} & A_{25} & A_{26} \\
 A_{31} & A_{32} & A_{33} & A_{34} & A_{35} & A_{36} \\
 A_{41} & A_{42} & A_{43} & A_{44} & A_{45} & A_{46} \\
 A_{51} & A_{52} & A_{53} & A_{54} & A_{55} & A_{56} \\
 A_{61} & A_{62} & A_{63} & A_{64} & A_{65} & A_{66}
 \end{bmatrix}
 \begin{bmatrix}
 F_{\mu 11} \\
 F_{\mu 12} \\
 F_{\mu 21} \\
 F_{\mu 22} \\
 F_{\mu 31} \\
 F_{\mu 32}
 \end{bmatrix}
 =
 \begin{bmatrix}
 B_1 \\
 B_2 \\
 B_3 \\
 B_4 \\
 B_5 \\
 B_6
 \end{bmatrix}.$$

Результаты исследования участков электромагнитного преобразования преобразователя первичного тока представлены на рис.2. а и б).

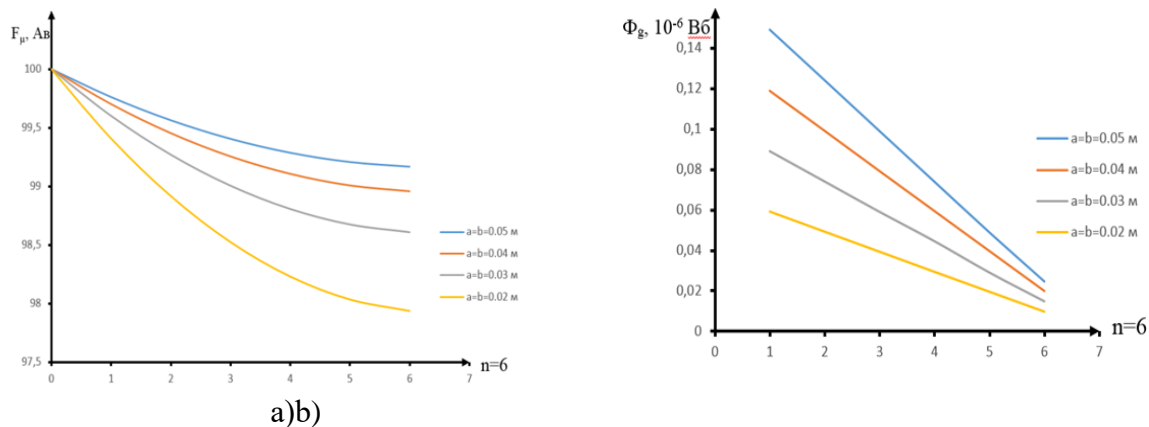

Fig. 2. Results of the study of areas of magnetic transformation:

a – change in ppm on the number of subdivisions –  $n$ ,

b – change in magnetic flux from the number of sections of the partition –  $n$ .

The graph model of the study of the magnitudes of the electromagnetic conversion of the primary current and voltage transducer for monitoring and controlling the values of the power supply system, makes it possible to analyze the rationality of the choice of both the geometric dimensions of the conversion sections (Figure 2, dimensions  $a = b = 0.01-0.04$ ) and the quantity sections of division  $n$  - allowing to increase the accuracy of the calculation and study of the sections for converting the primary current of electrical energy of power supply systems, is distinguished by clarity and high formalization in the formation of dependencies, which represent the main characteristics in general form. The unified value of the output signal in the form of an electric voltage depends on the rationalized forms and parameters of the sections of the magnetic circuit (the air gap where the sensitive element is installed - a flat measuring winding), which ensure the perpendicularity and uniformity of the intersection of the area of the sensitive element by the magnetic flux created by the primary currents of the electric network of the power supply system.

## LITERATURE

1. I.Kh.Siddikov, M.A.Anarbaev, A.A.Abdumalikov, A.B.Abubakirov, M.T.Maxsudov, I.M.Xonturaev. «Modelling of transducers of nonsymmetrical signals of electrical nets» // International Conference On Information Science And Communications Technologies Applications, Trends And Opportunities // Publication Year: 2019, Page(s): 1–6. <http://WWW.ICISCT2019.Org>.
2. I.X.Siddikov, A.B.Abubakirov, A.J.Allanazarova, R.M.Tanatarov, Sh.B.Kuatova // Modeling the secondary strengthening process and the sensor of multiphase primary currents of reactive power of renewable electro energy supply // Solid State Technology, Volume: 63 Issue: 6, Publication Year: 2020, pp: 13143-13148.
3. Abubakirov A.B., Yo'ldashev A.A., Baymuratov I.Q., Sharipov M.T., Utemisov A.D. «Study of conversion circuits and design of the electromagnetic primary current and voltage transducer of monitoring and control systems» // EPRA International Journal of Research and

- Development. Volume: 5 India. 2020. - С. 214-218. (SJIF Impact Factor: 6.260| ISI I.F.Value:1.241| Journal DOI: 10.36713/epra2016 ISSN: 2455-7838(Online)).
4. I.Siddikov,Kh.Sattarov, A.B.Abubakirov, M.Anarbaev,I.Khonturaev,M.Maxsudov.«Research of transforming circuits of electromagnets sensor with distributed parameters» // 10 th International Symposium on intelgent Manufacturing and Service Systems. 9-11 September 2019. Sakarya. Turkey. с.831-837.
  5. Abubakirov A.B. «Research of the electromagnetic transducers for control of current of three phases nets» // European science review, Scientific journal № 5–6 Vienna, Austria. 2018.- pp. 269-273.
  6. Siddikov I.KH., Abubakirov A.B., Yo'ldashovA.A., Babaxova G.Z., Xontoraev I.M., Mirzoev N.N. «Methodology of calculation of techno-economic indices of application of sources of reactive power» // European science review, Scientific journal № 1–2 Vienna, Austria. 2018.- pp. 248-251.
  7. Сиддиков И.Х., Саттаров Х.А., Абубакиров А.Б., Есенбеков А.Ж., Сарсенбаев Д.Б. «Применение управляемых компенсирующих устройств в системах электроснабжения» // Вестник ККОАНРУз. №2. Нукус, 2018.- С. 27-32.
  8. Зарипов М.Ф., Зайнуллин Н.Р., Петрова И.Ю. Графовой метод научно-технического творчества. – М.: ВНИИПИ ГКНТ, 1988. – 124 с.
  9. Лукашкин В.Г., Гарипов В.К., Слепцов В.В., Вишнеков А.В. Автоматизация измерений, контроля и управления.– М.:Машиностроение, 2005.– 663 с.
  10. Патент РУз. №04185. Преобразователь несимметричности трехфазного тока в напряжение/Амиров С.Ф., Азимов Р.К., Сиддиков И.Х., Хакимов М.Х., Хушбоков Б.Х., Саттаров Х.А. // Расмийахборотнома. – 2010. - №6.
  11. Патент РУз. № 04475. Преобразователь тока в напряжение /Амиров С.Ф., Азимов Р.К., Сиддиков И.Х., Хакимов М.Х., Хушбоков Б.Х., Назаров Ф.Д., Рустамов Д. // Расмийахборотнома. – 2012. № 2.
  12. International standard EN-50160, “Instrument transformers – Part 1: Current transformers”.
  13. Schaumburg H. Werkstoffe und Bauelemente der Elektrotechnik. Sensoren. Stuttgart: B.G. Teubner, 1992.– 517 p.
  14. Dominic M., Yiannos M. CMOS Circuits for Electromagnetic Vibration Transducers: Interfaces for Ultra-Low Voltage Energy Harvesting, 2015. – 300p. <https://www.springer.com>.
  15. Reza J. Electromagnetic Acoustic Transducer Analysis, LAP LAMBERT Academic Publishing (October 26, 2011), 164p.<https://www.springer.com>.
  16. John G. Webster, HalitEren. Measurement, Instrumentation, and Sensors Handbook: Two-Volume Set 2nd Edition, 2014. – 3559p.<https://www.springer.com>.
  17. Бессонов Л.А. Теоретические основы электротехники. Электрические цепи. – М.: Гардарики, 2006. – 701 с.

18. Демирчян К.С., Нейман Л.Р., Коровкин Н.В., Чечурин В.Л. Теоретические основы электротехники: В 3-х т. Учебник для вузов. Изд. 4-е – Спб.: Питер, 2006. – 576 с.
19. Зарипов М.Ф., Петрова И.Ю. Предметно-ориентированная среда для поиска новых технических решений «Интеллект»// IV Санкт-Петербургская международная конф. «РИ-95»: Тез. докл. – Спб., 1995. – С. 60-61.
20. Бронштейн И.Н., Семендяев К.А. Справочник по математике для инженеров и учащихся втузов. Изд. 13-е, исправленное. – Москва: наука, 1986. – 544 с.

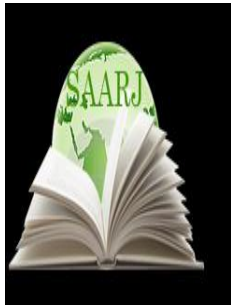

**ACADEMICIA**  
**An International**  
**Multidisciplinary**  
**Research Journal**  
 (Double Blind Refereed & Peer Reviewed Journal)



**DOI: 10.5958/2249-7137.2021.01164.2**

## MOHLAROYIM NODIRA'S SKILL IN USING A SATELLITE

**Imomaliyeva Musharrafhon Ilhomjon qizi\***

\*Kokand DPI, UZBEKISTAN

Email id: Musharrafimomaliyeva1991@gmail.com

### ABSTRACT

*Mohlaroyim Nodira's rubabiyat, its unique artistic landscape, skillful artistic approach to the use of words and the variety of tones can be understood. Nodira's incomplete Uzbek office is kept in the fund of the Institute of Oriental Studies of the Academy of Sciences of Uzbekistan. The devon includes 109 (or 1704 verses) by Nodira. There are 19 (328 lines) ghazals written under the pseudonym Komila. Today, the free and free-thinking women of our time and, in general, the happy Uzbek people, who have become the masters of their own destiny, remember with respect the noble and selfless poetess, because Nodira's immortal works in Uzbek and Tajik.*

**KEYWORDS:** *Ghazal, Radif, Rhyme, Devon, Rhythmic, Musical, Poetry, Nickname.*

### INTRODUCTION

Nodira is a well-known Uzbek poetess of the first half of the 19th century. Her real name is Mohlaroyim, and her literary pseudonym is Nodira. She also wrote Uzbek poems under the pseudonym Komila. The author of this pen is one of the great poets. He also wrote in Tajik and used the nickname Maknuna in his poems in this language.

During the poet's life, the literary environment of Kokand flourished. Umar Khan was not only his wife, the head of the country, but also a master poet. He wrote poems under the pseudonym Amir. From Nodira to us there are 2 devons. There are 189 ghazals in the Turkish devon. Some of them are in Tajik. Persian poems are concentrated in the Devoni Maknuna. Mohlaroyim's work has reached about 10,000 verses. The main part of the poet's poems is 7-9 bytes.

### MATERIALS AND METHODS

The study of Nodira's life and work began in her time. Hakim Khan Tora's "Muntahab ut-tavorix", Avaz Muhammad Attor's "Tuhafat ut-tavorix", Ishakhon Tora's "History of Fergana", Mushrif's "Enobus- In historical works such as "salotin and tavorihi havoqin", in Uvaysi's epics "The story of Muhammadalikhan" there is information about the talent, activity, creativity of Mohlaroyim.

Nodira's incomplete Uzbek office is kept in the fund of the Institute of Oriental Studies of the Academy of Sciences of Uzbekistan. The devon includes 109 (or 1704 verses) by Nodira. There are 19 (328 lines) ghazals written under the pseudonym Komila. There are 180 poems written under the pseudonym Nodira. 136 of them are in Uzbek, 44 in Tajik. Including 11 muhammas, 2 musaddas, 1 musamman, There is also 1 translator, 1 content and 1 subdivision. There are 333 ghazals written under the pseudonym Maknuna.

There are 156 Turkish gazelles in the poet's "Nodira" divan, of which 97 are radif and 58 are non-radiz.

Radif (Arabic - Radif) - a word or phrase that is repeated in Eastern poetry, including Uzbek poetry, after the rhyme at the end of a line or byte.

A radix can be a single word (short radix) or several words (broad radix). One-word radifs are more common in Nodira's work. According to the technique of the poem, the repetition of a radif is emotionally necessary. serves to ensure sound harmony, gives the poem a musical and rhythmic tone, and is also preserved in the translations of poems. The following words are found in the Turkish poems of the poet:

T/r	The name of the word used as a radix	Meanings given in the "Explanatory dictionary of the Uzbek language" Meanings given in the "Explanatory dictionary of the Uzbek language"
1	Hello	The word "welcome" is in the dictionary: Arabic welcome; 1. Respect means to greet with compliment; 2. Women's names. Welcome, good news, You're a real spit fire Nodira used the first meaning of the word in this byte.
2	Appearance	The word "appear" in the dictionary: 1. To appear, to be created; 2. To come from somewhere, to be present; 3. To appear, to stand out; 4. To be created, to originate; 5. To appear, to reflect. I remembered your face, it appeared late in the morning, Kavokib was on the threshing floor when the city appeared. Nodira used the 4th meaning of the word in this byte.
3	Dud	The word "dud" in the dictionary: 1. Smoke, dry; 2. Dust, dust, complication; 3. Oh, nola; 4. Bitter, angry, furious; 5. Heat taffeta. From noon to dude tonight, Who made the work smoke the sky of love. Mohlaroyim used the 1st meaning of the word in the first

		verse of this verse and the 5th meaning in the second verse. When I wrote the poem "Oh" And then Nodira went to the office. In this verse, the poet uses the 2nd meaning of the word.
4	Abas	The lexical meaning of the word "Abbas": Useless, useless, useless, useless. The effect of the fire of love, if not rare, The pain is excruciating.
5	Fido	The word "Fido" in the dictionary: Arabic - get rid of, get rid of, compensate, exchange. To dedicate oneself to someone or something, to an idea; to dedicate, to sacrifice. Come, O king of the world, sacrifice your country to the world, Step into my heart, sacrifice every step of the way.
6	He didn't come	The word "come" in the dictionary: 1. to take a path, to go 2. Be present. 3. "to begin", "to arrive", "to reach" 4. Indicates that the turn has come (form without -ma) Wow, what happened? I didn't come, All the good ones came from the trip, half did not come.
7	Let's go around	The word "circle" in the dictionary: 1. The verb to circle; 2. Sacrifice and sacrifice; 3. Pampering means respect; Shameless self-promotion for Ballistic Products and a great bargain on a neat little knife for you. Subhidam bodi sabo yanglig 'gulistan aylanay In this verse he used the 1st meaning of the word in the dictionary. I'll be waiting for you whenever you come, Let's start with a hundred years of coincidence. This byte uses the 2nd meaning of the word in the dictionary.
8	Talx	The meaning of the word "talh" in the dictionary: in Persian - bitter, bad. 1. taxir, bitter To me, O Komila, la`lidin ayru, If I eat sugar, it will be bitter.
9	Ajab	The lexical meaning of the word "wonderful": surprising, surprising, surprising, interesting. The words of his grace are wonderful, It is strange that the Sun has declared that it has no interest.
10	As a result	The meaning of the word "consequence" in the dictionary



	<p>is Arabic-end, result, effect, follow-up.</p> <ol style="list-style-type: none"> <li>1. Appreciation, friendship, love and the resulting good attitude;</li> <li>2. The end result;</li> <li>3. After everything (event) happened, the end.</li> </ol> <p>Wasl rebuilt the house, ruined the end of migration, The flood was followed by the destruction of the building. In this byte, Nodira uses the 2nd meaning of the word.</p>
--	---

## RESULT AND DISCUSSION

There are many artists in Uzbek literature who have a special place in their work. In particular, among the artists who have enriched the treasury of our classical literature, there are a number of poets, whose charming poems have already become the property of the people. He is still young and old:

You don't have to worry about it,  
There are no flowers in the flower garden.  
Or,  
Don't go for a walk, don't go for a walk,  
Late in the world, help your imagination.  
A man without love is not a man,  
If you are a man, choose love.

When we hear such verses, we think of the poet Nodirabegim. The warmth of the heart, the expression of tender feelings, the melody that touches the strings of the heart, the delicate glow of pure love give a special mood.

## CONCLUSION

Today, the free and free-thinking women of our time and, in general, the happy Uzbek people, who have become the masters of their own destiny, remember with respect the noble and selfless poetess, because Nodira's immortal works in Uzbek and Tajik. It arouses hatred of oppression, cruelty and inequality, as well as increases our love and devotion to our homeland and society. As the great poet said, "Husho is wise, turn around and build the foundation of goodness." and because of his good service to mankind, his good name, that is, his good name, lives forever in works and prose.

## REFERENCES:

1. "Nodira" office, Tashkent-1963, 61 pages
2. "National Encyclopedia of Uzbekistan" Tashkent -2020.2 vol
3. "National Encyclopedia of Uzbekistan" Tashkent -2020.1 vol
4. T. Jalolov "Uzbek poets" Tashkent-1970, p.79
5. Ilkhom Abdirakhimov. Development of effective demulsifiers on the basis of local raw materials // Universum: технические науки: научный журнал. – № 2(83). Часть [4] М., Изд. «МЦНО», 2021. DOI: 10.32743/UniTech.2021.83.2-4.36-39.

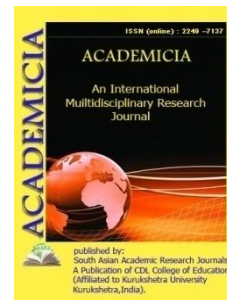
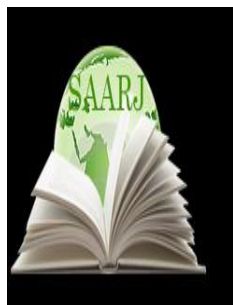

DOI: **10.5958/2249-7137.2021.01163.0**

## PEDAGOGICAL AND PSYCHOLOGICAL FEATURES OF THE FORMATION OF THE CREATIVE ACTIVITY OF FUTURE TEACHERS THROUGH PERSONALITY-ORIENTED EDUCATION

**Rakhimova Feruzakhon Mukhammadjonovna\***

\*Teacher of the Department,  
"Preschool education" of the Kokand State Pedagogical Institute named after Muqimiy,  
UZBEKISTAN

### ABSTRACT

*Changes in society, modern requirements for professional knowledge and personal qualities of specialists have created the need to update the content of education in pedagogical universities, innovative forms and methods of teaching, the widespread introduction of modern information technologies into practice. Another important aspect of the process of professional adaptation of future educators is to determine the set of necessary conditions for the acquisition and full implementation of professional knowledge, skills and competencies in these areas.*

**KEYWORDS:** *Professional Adaptation, Pedagogical And Psychological, Innovative Potential, Personality-Oriented Education.*

### INTRODUCTION

When developing strategic plans for the development of the labor market and educational services in the Republic of Uzbekistan, special attention is paid to the formation of the level of professional training and the ability of specialists to adapt to the requirements of the activity. This, in turn, requires solving the following tasks related to increasing the efficiency of the process of professional adaptation of future educators:

- determining the content of professional training of future educators, taking into account modern requirements and proposals of the labor market for the training of educators;
- Identification of pedagogical and psychological factors and conditions that form the innovative potential of high-quality acquisition of professional knowledge, skills and abilities;
- Determination and implementation of pedagogical conditions for professional adaptation on the basis of a creative and collaborative environment based on a systematic approach;

- Development and implementation of new publications, electronic textbooks, teaching materials for independent study of social and pedagogical aspects, theoretical issues and independent training of educators.

## **MATERIALS AND METHODS**

As you know, the professional adaptation of future educators is a purposeful, systemic process. Modern pedagogical and psychological research describes the stages of the process of professional adaptation of future specialists in different ways.

An important condition for ensuring the effectiveness of the tasks set is the substantiation of objective and subjective (external and internal) factors that affect the process of professional adaptation of future educators. Slastin's research on the formation of professional training of future educators shows that high professionalism, that is, the quality of the education received, depends on objective factors in achieving professional maturity and subjective factors that affect the personality's abilities, professional orientation, and effective pedagogical tasks. and an expert approach to decision making.

The socio-theoretical training of students of pedagogical universities is influenced by motivational and social factors, the content of which includes information, knowledge, the foundations of science, which are assimilated in the field of general education.

## **RESULT AND DISCUSSION**

Pedagogical and psychological training of students is based on the principles of the educational process, documents that reveal the content and essence of training, forms, methods and means of training, as well as knowledge of the age and individual characteristics of the student and their psychological state is determined by the level of professional knowledge, skills and abilities in acquisition.

The study showed that the skills of practical adaptation of future educators to professional activities are formed directly on the basis of special methodological training. In this case, the correct construction and implementation of the educational process of the student, the organization and management of the activities of teachers and students, the correct orientation of the educational activities of students, teaching, the degree of mastering the skills of effective use. forms, methods and tools for monitoring and evaluation in science, teaching and subject matter are described as key components.

One of the modern requirements for the process of professional adaptation of future educators is the ability to actively master and implement these innovations.

Innovative training is one of the criteria for professional training, determined by the formation of an axiological, acmeological, creative, reflective approach to pedagogical activity, the creation of an environment for creative cooperation in education, the introduction of innovative technologies into the educational process, active motivation for innovative activities.

Another important aspect of the process of professional adaptation of future educators is to determine the set of necessary conditions for the acquisition and full implementation of professional knowledge, skills and competencies in these areas. Because a comfortable and focused teaching environment makes it easier to achieve the desired result from the process.

The results of the experiment confirmed that the integration of pedagogical and psychological conditions is important for improving the quality of education in the process of training future specialists. It was also found that the practical disclosure of the potential of pedagogical technologies in the educational process, aimed at the professional adaptation of future educators on the basis of a systematic approach, will help to ensure a positive solution to the research problem. Subsequent sections of the case will focus on these issues.

It is known that the process of professional adaptation of future educators is a complex and individual process. In this case, it is advisable to study the individuality of the student's personality, learning conditions, environment and the system of interpersonal relations. In addition, an effective adaptation process contributes to the formation and professional development of future educators, their dedication and value approach to professional activity. This affects the efficiency, effectiveness and longevity of the professional.

### CONCLUSION

1. A feature of the modernization of the educational process in higher educational institutions is not only the formation of general parameters of professional training, but also the development of their creative abilities, the ability to accurately predict the goals and objectives of the process and strive for them. , characterized by the level of development of skills for the development and implementation of optimal ways to successfully organize the pedagogical process.
2. Modern requirements for the professional adaptation of future educators dictate the need for an innovative approach to the organization of the pedagogical process in these educational institutions. This presupposes the identification of pedagogical and psychological factors and necessary conditions that influence the process of professional adaptation in the study.
3. The empirical analysis carried out in this chapter of the study confirmed that the information-content and organizational-methodological factor of the professional adaptation of future educators is one of the main criteria for ensuring the effectiveness of the system.
4. The results of the experiment showed that the development and implementation of methods of professional adaptation based on innovative teaching technologies can give a positive solution to the research problem under study.
5. At the next stages of work, based on the capabilities of innovative technologies, the expediency of developing effective methods that help future educators to adapt to the requirements of pedagogical activity was substantiated.

### REFERENCES:

1. Egamberdieva N.M. and a team of authors. Educational technology for the formation of a highly spiritual personality. - T.: Science and Technology Publishing House, 2012. - P. 203.
2. Azizkhodzhaeva N.N. Pedagogical technologies and pedagogical skills. - T.: Finance, 2003. - S. 54-56.
3. Ragimov B.Kh. Formation of professional and cultural relations among future teachers.: Ped. fan. No. diss. - T.: 2002. B - 61-67.
4. Muslimov N.A. Theoretical and methodological foundations of the professional development of a teacher of vocational education: Ped. - T.: 2007. --357 p.1068

- 
5. IlkhomAbdirakhimov. Development of effective demulsifiers on the basis of local raw materials // Universum: техничекиенауки: научныйжурнал. –№ 2(83). Часть [4] М., Изд. «МЦНО», 2021. DOI: 10.32743/UniTech.2021.83.2-4.36-39

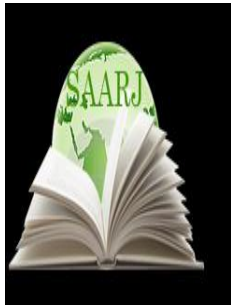

**ACADEMICIA**  
**An International  
 Multidisciplinary  
 Research Journal**  
 (Double Blind Refereed & Peer Reviewed Journal)



**DOI: 10.5958/2249-7137.2021.01218.0**

## THE FACTORS OF INCREASING SOCIAL CREATIVE ACTIVITY OF YOUTH

**Rajabboev Jurabek\***

\*Student,  
 Department of National Idea,  
 Fundamentals of Spirituality and Legal Education,  
 Urgench State University, Urgench, UZBEKISTAN  
 E-mail id: sv997710@gmail.com

### ABSTRACT

*This article discusses some aspects of social policy to create conditions for social activity of youth and social activity of youth in our country. In addition, factors influencing the social activity of young people are presented.*

**KEYWORDS:** *Youth, Person, Social Activity, Political Activity, Social Policy, New Conditions, Market Economy, Modern Education, Cognitive, Processes, Harmonious View, A Dynamic Features, Technical Research.*

### INTRODUCTION

Spiritual and moral factors are, in essence, the values created by our ancestors, inherited from them, the mentality, way of life and cultural life of our people and nation. Their connection with different interests and hobbies has formed the categories of "I" and "We" in the spiritual and moral life. "Rituals, traditions, and customs that have been formed and developed in a society over the centuries are also a manifestation of the moral relationship that exists between the individual and society. Based on these, the relationship between the individual "I" and the collective "We" is harmonized [1].

Many literatures emphasize the predominance of "We" in the spiritual and moral imperatives of the East. The fact that this communism has risen to the level of tradition is not a negative, conservative case, of course. But in the development of society, the category of "I" or "We" has never been absolutely dominant, it was impossible to live without harmonizing them. It is natural that there is a contradiction between these categories. Because "the development of the

relationship between the individual and society is not just about commonalities. There will also be contradictions in this relationship;

The basis of these contradictions is the disproportion in the understanding and formation of the relationship between the individual and society. "Creative" means creation. Although creation, creativity is essentially a social reality, in the literature on the psychology and theory of creation it is considered as a private, individual psychological phenomenon. In contrast to this approach, we focus on the social aspect of creative activity.

## **MATERIALS AND METHODS**

The extravagant, that is, the focus on innovative existence of innovative mentality raises a number of scientific and philosophical issues. It is difficult to understand the essence and significance of the subject without having certain theoretical views and assumptions about them. These issues include:

- Through what motives, stimuli or attitudes the creative cognitive reality becomes an extractive reality;
- Whether the harmony of the interests of "I" and "we" is preserved in this process, or whether "we" "swallow" all the processes;
- External deterministic factors activate the internal spiritual-mental mechanisms that motivate creative activity in accordance with which laws;
- Whether the social creative activity of young people is only extroverted, or whether it has an inner moral, spiritual, intravertive character;
- Finally, how the measurement of social creative activity is carried out, according to which criteria it is evaluated.

The transformation of creative cognitive reality into an extractive reality occurs through certain motives, stimuli, and attitudes. Lack of understanding of these psychological factors leads to an unbiased assessment of creative activity; each of them is studied and considered in sociology and psychology as a separate spiritual state of mind. We call them "activating factors" by their common name, because, in our opinion, they are the ones that give direction, importance and necessity to human activity, mobilize all his physical and spiritual strength and motivate him to achieve the set goal [2]. Social creative activity should be recognized first of all as an expression of a person's desire to find his place in society, in existence, in the existing system of relations. This desire is activated when it is actualized in the individual by social life and environment. A.G. Maslow, who studied the problems of creativity and its actualization, writes: "If we really want our children to actualize all the forces which they have, we must bring them up through a single goal, that is, through creativity"[3]. The philosopher and psychologist, thinking about education and preparing young people for life, said that today the world is changing rapidly, new problems are emerging, and in such conditions young people should not lose themselves, stand up to challenges and innovate "with pride and joy." Concludes [4] Again he writes: "We need to be people who don't make the world steady and stable who don't harden it like our ancestors did, who look to the abstract tomorrow with confidence, who look up to future changes and changing lives, who live improvised and adaptable to life. This is a new type of person. If you want, you can call him Heraclitus" [5] here we are talking about the inner state of creative

activity, self-discovery, and even the appearance of "ecstasy" as described by A.G. Maslow. Motives, stimuli and attitudes are rooted in this psychological state. So there are two stages in creativity: the first is the stage at the level of "ecstasy" and the second is the stage at the level of "improvisation and adaptation". Innovation involves or consists of both of them. The first is a person's desire for unique innovation and discovery, and the second is an essentially technical effort to bring the inventions of others into their environment, to install them. The latter is no secret; it can be done even by ordinary minds. Anyone with organizational and technical knowledge, experience in managing technological processes can lead. Countries that have built an industrial society for the first time do so in the process of bringing in foreign scientific and technological discoveries, because they do not yet have the intellectual forces and innovative technology capable of carrying out the scientific and technological revolution. The first stage of innovation is the stage of mobilization of scientific and technical forces in society, making them unique scientific and technical discoveries. The innovative development taking place in Uzbekistan includes both stages, but now we have the advantage of introducing foreign scientific and technical discoveries, through which the modernization of socio-economic life. The relevance of innovative research as culmination, creative activity is associated with these two stages. That is why half of them see innovation as a type of activity related to scientific and technical creativity. Contrary to this view, their social cognitive activity is aimed at introducing foreign technologies. They also associate culminating with this process.

## RESULTS AND DISCUSSION

The "ectase" (A.G. Maslow), intravertive nature of creative activity encourages the study of the interests of "I" and "we". A true creator tends to generalize his "I", preferring to communicate with someone who listens to his opinion or hears it. While this introversion in him is important for creative research, it has to reckon with "us," that is, social interests, especially in the field of scientific and technical creativity. The creation of a nuclear weapon confirms what disasters could befall humanity, which is the result of a failure to take into account the interests of humanity in scientific and technical research. This exemplary example is an important principle for every scientific and technical discovery. Take the internet, for example. Yes, it is a high product of the human mind, an opportunity for everyone to take an active part in world events, to increase their knowledge. But when it falls into destructive, aggressive hands, it can serve evil, inhuman purposes. Therefore, in innovative mentality, we realize that the issue of "I" and "we" is not in vain. Every year in Uzbekistan more than half a million young people who have graduated from schools are ready to take an active part in social relations and find their own way of life. More than 450,000 young people with higher and secondary special education are ready to show themselves, their knowledge and skills in various fields. Innovative changes, the introduction of scientific and technical discoveries do not lead to the creation of new jobs, but save the job vacancy. It is difficult to resolve this conflict with scientific and technical innovations. All areas of human activity, manual labor cannot be replaced by automation and innovative discoveries. This means that the need for manual labor in society remains.

Innovative mentality is nourished by the requirements of social development; it is not "for itself" but for the development of society. Our need for science, technology and innovation even leads to the abandonment of the ego, as A.G. Maslow points out. It is based on a complete devotion to creative pursuits, disregard for the opinions of others, living only with the pain of creation, forgetting that you are divided into two subjects, such as "you observe your own ego



and feel your own ego"[6]. In this case, the question arises as to whether "we" will not completely swallow the creative "I". Yes, there is such a great risk in traditional societies. This risk can be reduced by giving the creative self a social orientation to its creative activity, while acknowledging its propensity for individual exploration. The "I" of the Creator is not antagonistic to the "we" of society, but is ultimately measured by how all inventions have benefited humanity.

Innovative mentality must have a creator "I". It is not harmful for the creator to glorify his "I" or to have egocentric views in it. It is a quality that comes to him from his separation from other creators, from his environment, from his addiction for innovation. If we understand innovation as a kind of true creative activity, we have to support the "I" and endure the conceit and arrogance in it. If we understand innovation as the introduction of imported technical means and methods of work, then there can be no question of true creativity, the "I" of the creator, his stubbornness. These two approaches always follow innovative research, and their beginnings go back to the creator "I". This is why special attention is paid to the training of young professionals who tend to innovative mentality and research. In their scientific and technical mentality, the interests of "I" and "we" do not exaggerate as antagonists, but the true creator, the inventor, does not forget his "I". The dialectical connection between the "I" and the "we" has always been debated, in scientific and technical work, always in favor of the latter. Not only society, socium, but also the individual, the creator, has won from this.

External deterministic factors drive the spiritual mental mechanisms that encourage creative activity according to certain laws. Why is a person engaged in scientific and technical creation, innovative research? What are the mechanisms in the spiritual world of man that motivate him to search restlessly, and even to create scientific and technical innovations in opposition to prohibitions? How does the creator know if he is going the right or wrong way, is it possible to determine that? Admittedly, these questions are difficult to answer. Even experts who have studied the philosophy and psychology of creation have not found answers to these questions. That is why the Russian philosopher N.A Berdyaev, who expressed many interesting views on the philosophy of creation and wrote works, connects the creative process with personalism, divinity and transcendence [7]. Based on the existing social philosophical and scientific views, we believe that the above laws can be determined through contextual, experimental and component research [8]. These directions and methods of scientific research come in different levels and forms in innovative mentality. For example, the contextual method helps to solve a problem in a particular field using a new, technical invention. Automation of the production process, mechanization means the elimination of heavy manual labor, resulting in an increase in the number and quantity of products, saving time spent on them. This method imposes a humanization of labor on scientific and technical discoveries. The humanization of labor, that is, the humanization of social organization in accordance with the interests of man, is a requirement of the laws of management. Or take the experimental method. Its empirical view implies the creation of innovation through special testing. In this regard, we can cite the Decree of the President of the Republic of Uzbekistan dated August 17, 2018 "On a legal experiment to introduce a special regime of governance in Tashkent". It considers the rapid development and modernization of socio-economic sectors in Tashkent, attracting investments, rapid solution of problems in the social sphere and the population, the abandonment of quasi-enterprises and the introduction of a modern, efficient and innovative management system[9]. This experiment

should lead to the identification of methods, ways and technologies to solve existing problems, innovative transformation of urban infrastructure. Its main goal is to create a model of development that is consistent with the innovative development of the country, the formation of a system that increases the welfare of the population. The experiment will help to determine how the country's innovative development can be carried out in accordance with social, political, economic and cultural laws. Experimental creativity does not only lead to positive results, any scientific experiment can be a basis, a model for future experiments, ideas and research. In short, external deterministic factors activate the internal spiritual-mental mechanisms that stimulate creative activity in accordance with the requirements and laws of social development.

## CONCLUSION

This creative activity is the humanization of the social being, the use of the intellectual forces in the individual. Although the social creative activity of young people has an extroverted character, it is not a phenomenon that separates it from the creative person, from his spiritual life. Innovative research, the measurement of creative activity in young people requires special research. Such criteria are different in each type of creative activity. Therefore, experts are in favor of a differential approach to them[10]. In innovative research, such criteria are also determined by how they are approached: is innovation a genuine type of creative activity such as "ecstasy" or the introduction of imported scientific and technical discoveries? The search for criteria is justified only when we find the answer to this methodological question for ourselves.

## REFERENCES

1. Yusupov E. Spiritual foundations of human perfection - Tashkent: University, 1998. 79-p.
2. See: Russian Sociological Encyclopedia. Ed. G.V. Osipova. Moscow: NORMA INFRA M., 1998. 301 p.
3. See: Maslow G.A. Far limits of the human psyche. SPb.: Ed. gr. Eurasia, 1997. 69 p.
4. That work. 70 p.
5. That work. 70-71 p.
6. That work. 77 p.
7. See: Berdyaev N.A. Philosophy of Freedom. The meaning of creativity. Moscow: Pravda, 1989. 511-535 p.
8. V.G. Golovanova Philosophy of discoveries and inventions. Toshkent: Noshir, 2013, p. 1
9. Decree of the President of the Republic of Uzbekistan. "On the legal experiment on the introduction of a special regime of governance in Tashkent" // People's speech, 2018, August 18.
10. See: Baxranov L. Artistic criticism and fine arts (philosophical aesthetic observations). Tashkent: Tafakkur Publishing House, 2016. 69-79 p.

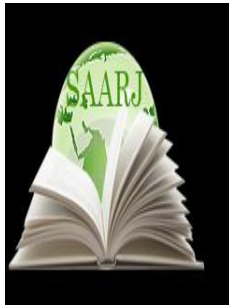

**ACADEMICIA**  
**An International**  
**Multidisciplinary**  
**Research Journal**  
 (Double Blind Refereed & Peer Reviewed Journal)

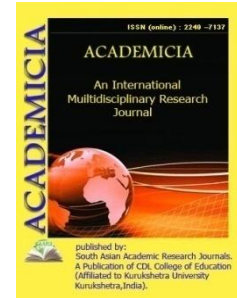

**DOI: 10.5958/2249-7137.2021.01161.7**

## GENERAL CHARACTERISTICS OF THE MILITARY COMMITTEES OF THE ARMED FORCES OF THE REPUBLIC OF UZBEKISTAN

**Boltaboyev. Abdugani\*; Yusupov Arabboy\*\*; Mansurov Mashrabboy\*\*\***

\*Teachers,

Faculty of Military Education of Fergana State University,  
UZBEKISTAN

\*\*Student,

Faculty of Military Education of Fergana State University  
Uzbekistan, Fergana, UZBEKISTAN

\*\*\*Student,

Faculty of Military Education of Fergana State University  
Uzbekistan, Fergana, UZBEKISTAN

---

### ABSTRACT

*This article informs about, the formation and unification of the military team, as well as the fact that each team which has its own characteristics, the great influence of the fighting spirit in the military team, and any difficulties encountered with this fighting mood victory, as well as the factors that determine the socio-psychological environment in the military community.*

**KEYWORDS:** *Military Community, Collective Opinion, Moral Value, Serviceman, Mood, Tradition, Economics, Politics, Ideological Reasons, Spiritual.*

---

### INTRODUCTION

In the process of formation and unification of the community, a common system of spiritual values is created. Spiritual values shape the mindset of the military community. A team opinion is a set of opinions that members have about an issue. Military activity is carried out in a military team, and in the process of this activity, the division of labor between the servicemen is of great importance. The public opinion in the units of the Armed Forces of our country is fully consistent with the public opinion in the whole society. This is a key factor in strong military discipline and high combat readiness. If servicemen have team-specific skills and competencies, interactions, as well as teamwork, will be effective, uninterrupted, and conflict-free. Each team will have its own structure. The position of the members in a certain position, the relationship

between them, forms the structure of the team. In teams with a stable structure, the position of each serviceman is also strong and gives good results.

## **MATERIALS AND METHODS**

A team mood is a set of feelings that a team member has about an event. The mood of the team is very influential and it is the motivation for the behavior and activities of the military. Some types of team mood (passion, confidence in success, high mood) are a factor in its success, while others (bad mood, lack of self-confidence, boredom, sadness and dissatisfaction), on the contrary, reduce the team's chances.

In addition, military teams have their own traditions. It is a tradition to preserve a characteristic of a team over time. Events that occur in society in general, and in the community in particular, in interactions and relationships between people, often take the form of a custom or tradition. The mood in a military unit, its activities and lifestyle, the commander's leadership style, and the specific behaviors of military personnel can also rise to the level of tradition. Traditions are universal, national, regional and collective. They serve as a kind of social "glue" in the team: it is the traditions that keep the team together. At the same time, it gives the team a sense of identity and charm. Traditions are divided into labor, sports, martial arts, and so on.

A unique socio-psychological environment also characterizes the community. Socio-psychological environment (microenvironment, moral environment) is a complex concept, which includes the feelings of each serviceman, the degree of satisfaction of their social needs (communication, mutual respect, friendship, abilities) level of performance, etc.), and the mood of the team. A set of emotions and experiences that occur in all or most members of a team at the same time is called team spirit. If the mood of an individual depends equally on physiological and other social factors, then the mood of the community is primarily the result of the whole system of social relations (economic, political, ideological, and spiritual). Social life is determined by the material and spiritual conditions of human life.

## **RESULT AND DISCUSSION**

Mood is a moving element of psychology and changes very quickly. A person's mood can quickly spread to others and "nourish" them. This is where the socio-psychological law of imitation applies, according to which, along with the positive, the negative also spreads quickly (for example, bad behavior, stupid fashion etc.). Bad moods are common among military personnel. It has no ideological reasons, but psychological reasons. The best way to prevent negative moods is to introduce statutory requirements in the unit, properly organize service, work and rest, as well as provide comprehensive care for military personnel. It is important to regularly inform servicemen about the situation in our country and in the world. First, commanders need to have confidence and alertness in their work. They need to be able to detect and prevent in a timely manner the negative moods that have just emerged in one or more military personnel. The military traditions formed in the teams are a source of positive mood: military oath, military parade, weapons and military equipment inspection, evening visit, enlistment of young soldiers, celebrations, exchange of guards, handing over the battle flag to the military unit tribe

Another factor that determines the socio-psychological environment in a military community is reputation (prestige or prestige), which is a specific form of relationship. Reputation is the

socio-psychological influence of one person (group) on another person (group). For example, the influence of a leader or commander on his subordinates, the teacher on his students, the team on the individual, and the influence of higher organizations on lower organizations. With the emergence of a group, a phenomenon of prestige also emerges and it becomes an integral part of interpersonal communication. The reputation of a unit commander is a key condition for success in strengthening military discipline among servicemen and in training and educating them. It is important to remember that a reputable commander has more influence than a non-reputable commander does.

Nevertheless, a reputation can never be gained through violence. Reputation is the product of existing relationships in the community as well as the positive qualities of the individual. Reputation always reflects respect for that person, confidence in his strengths and abilities. Another important aspect of reputation is that without it, no organizational activity can be carried out in society and in a particular military unit.

Reputation has the power of persuasion. Having it can have a powerful effect on those around you. Confidence in a person of prestige in the team is the unifying factor of this team. Any team can have not one, but several reputable people: a commander, a good specialist, military activists, an athlete, and so on. There are also many such soldiers. The reputation of an ordinary serviceman is a measure of his high position among his colleagues, based on respect, experience, knowledge, skills, moral, psychological and physical qualities. However, it is unfortunate to note that we have become accustomed to understanding the role of adults or commanders in the concept of prestige in life. Such a one-sided view of prestige contradicts the principle of educating servicemen in the community. It is the privileged servicemen among the ordinary soldiers who have a great opportunity to train other members of the team. The presence of a large number of dignitaries in the military unit indicates the richness and diversity of the spiritual life of the community, its wide range of opportunities. It should also be noted that the presence of a large number of people with prestige in a community - a great influence - sometimes leads to the emergence of an unhealthy environment in this community - a small group of opposing parties can also cause. As a result, the team is divided into small groups and weakened.

Discipline is also a specific socio-psychological phenomenon in military units, governed by general military rules and ethics, commands and instructions of commanders, social and public opinion, traditions, and prestige. Law and morality underlie any discipline, including military discipline. General military regulations govern military discipline, the relationship between servicemen, and how to act in certain situations that arise in the course of daily service activities.

The main conditions for a positive socio-psychological environment in the community are:

- Stable team structure;
- Psychological compatibility between personnel;
- Everyone works for the overall result;

## CONCLUSION

Experience has shown that the main reason for military discipline violations is that military personnel are partially or completely unaware of general military regulations. That is why it is so important for soldiers and sergeants to know the military regulations. His methodology plays

an important role in teaching military discipline. Regulation training usually begins with an officer telling a story about them. He tells the young soldiers about the types of military regulations, their purpose, and their importance in combat training. Then it is time to study the individual articles and reinforce them with real-life examples. In addition, some officers go the wrong way in teaching the rules - they require the military to memorize certain articles or rules completely. This attitude leads to indifference to their duties and a weakening of their mental activity.

**REFERENCES:**

1. M.Jorayev. Fundamentals of military pedagogy and psychology. Text of lectures. FSU, 2010
2. Sh.Tilavoldiyev, S.Kochkarov. Fundamentals of military patriotic education. Methodological manual. FSU, 2020
3. N.Boymurodov. Applied psychology. Study guide. Tashkent, 2008
4. IlkhomAbdirakhimov. Development of effective demulsifiers on the basis of local raw materials // Universum: техничекиенауки: научныйжурнал. – № 2(83). Часть [4] М.,Изд. «МЦНО», 2021. DOI: 10.32743/UniTech.2021.83.2-4.36-39.

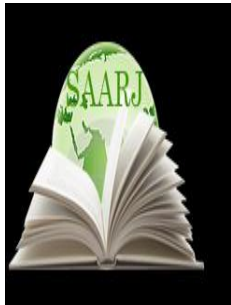

**ACADEMICIA**  
**An International  
 Multidisciplinary  
 Research Journal**  
 (Double Blind Refereed & Peer Reviewed Journal)



**DOI: 10.5958/2249-7137.2021.01160.5**

## THE IMPORTANCE OF PEDAGOGICAL IDEAS IN THE FORMATION OF YOUTH

**Turgunboev Tohirjon Abdugafurovich\***

\*Teacher of the Military Education Faculty of Fergana State University,  
 UZBEKISTAN

### ABSTRACT

*This article informs the importance of family, community and education in educating the young generation in the spirit of military patriotism, as well as the idea that the education of today's youth is one of the most responsible and urgent tasks, and the idea that the Motherland is one. It is about inculcating it in the minds and thinking of the rising generations.*

**KEYWORDS:** *Family, Neighborhood, Education, Youth, Personal Education, Social Education, Homeland, Patriotism.*

### INTRODUCTION

Each science in the same object of study distinguishes its subject of research – one or another form of existence of the objective world, one or another side of the process of development of nature and society. Education as a complex, objectively existing phenomenon is studied by many Sciences. Historical materialism, for example, considers education as a particular moment in the development of society, its productive forces and relations of production; history as a particular moment in the history of class struggle and class politics; psychology - in connection with the study of the formation of the personality of a developing person. The independence of any science is determined, first of all, by the presence of a special, own subject of research, the presence of such a subject that is not specifically studied by any other scientific discipline.

### MATERIALS AND METHODS

In the General system of Sciences, in the General system of "things and knowledge", pedagogy is the only science that has as its subject the education of man.

The study of all science begins with the understanding of such questions: how did this science arise and develop, and what specific problems does it explore?

In fact, each science has its own history and a fairly specific aspect of natural or social phenomena, the study of which it is engaged and the knowledge of which is of great importance for understanding its theoretical foundations.

The isolation and formation of pedagogy as a science were caused by the growing needs of society in creating special educational institutions, in the theoretical understanding and generalization of spontaneously emerging experience of teaching and upbringing of younger generations, special preparation for life. Education and upbringing, thus, became an objective need of society and became the most important prerequisite for its development.

That is why at a certain stage of development of human society and, in particular, in the later period of the slave-owning system, when production and science have reached significant development, education is allocated to a special social function, that is, special educational institutions appear, there are people whose profession has become the education and upbringing of children. This was the case in many ancient countries, but more or less reliable information about schools for boys has come down to us from Egypt, the Middle East and ancient Greece.

I must say that already in the ancient world, many public figures and thinkers were well aware of and pointed out the huge role of education, both in the development of society and in the life of each person. For example, according to the laws of Solon (between 640 and 635-CA. 559 BC), it was assumed that the father must take care of special training of his sons in a particular field of work. As education expanded and became more complex, a special branch of theoretical knowledge related to educational activities began to be developed more intensively. This branch of knowledge, as well as knowledge in other spheres of life and production, was first developed in the depths of philosophy. Already in the works of ancient Greek philosophers-Heraclitus (530-470 BC), Democritus (460-early IV century BC), Socrates (469-399 BC), Plato (427-347 BC), Aristotle (384-322 BC), and others. – contained a lot of deep thoughts on issues of education. The term "pedagogy" also originates from ancient Greece, which has been established as the name of the science of education. How did this happen?

In Ancient Greece, teachers were slaves who were assigned by aristocrats to look after their children, accompany them to and from school, carry school supplies, and take walks with them. The Greek word "paidagogos" (pada – child, Gogo – news) is a "schoolmaster". In the future, teachers were called specially trained people who were engaged in teaching and raising children and for whom teaching was a profession. Hence the special science of education became known as pedagogy.

It should be said that many other pedagogical concepts and terms also originate from Ancient Greece, for example, school, which means "leisure", gymnasium - public school of physical education, and later just a secondary school, etc.

The issues of education also occupied a significant place in the works of ancient Roman philosophers and orators. Interesting pedagogical ideas, for example, were expressed by Lucretius Carus (CA. 99-55 BC), Quintilian (42-118 BC), and others.

In the middle ages, problems of education were developed by philosophers-theologians, whose pedagogical ideas were religious in color and were permeated with Church dogma.

Further development of pedagogical thought was received in the works of thinkers of the Renaissance (XIV-XVI centuries). the most Prominent figures of this era - the Italian humanist



Vittorio da Feltre (1378-1446), the Spanish philosopher and teacher Juan Vives (1442-1540), the Dutch thinker Erasmus of Rotterdam (1465-1536), and others.

They criticized the mechanical rote learning that flourished in education, advocated humane treatment of children, and the liberation of the individual from the shackles of oppression.

Despite the intensive development of educational theory, pedagogy continued to be a part of philosophy. As a special science pedagogy was first isolated from the system of philosophical knowledge at the beginning of the XVII century. Most researchers associate the design of pedagogy as an independent scientific discipline with the name of the great Czech teacher Jan Amos Comenius (1592-1670). The principles, methods, and forms of organization of educational work with children and moral education formulated by him became integral elements of subsequent scientific and pedagogical systems.

The works of such prominent figures as J. J. Rousseau (1712-1778), D. Diderot (1713-1784), K. A. Helvetius (1715-1771) in France, John Locke (1632-1704) in England, Johann Heinrich Pestalozzi (1746-1827) in Switzerland, Friedrich Adolf Wilhelm Diesterweg (1790-1866) and Johann Friedrich Herbart were of inestimable importance for the formation of scientific pedagogy (1776-1841) in Germany.

The founders of revolutionary demographic views in Russian pedagogy were V. G. Belinsky (1811-1848), A. I. Herzen (1812-1870), N. G. Chernyshevsky (1828-1889) and V. A. Dobrolyubov (1836-1861). The works of L. N. Tolstoy (1828-1910) and N. I. Pirogov (1810-1881) had a great influence on the formation of Russian scientific pedagogy. A complete, systematic disclosure of domestic pedagogical ideas was given in the works of K. D. Ushinsky (1824-1870). A great contribution to the development of Soviet pedagogy was made by N. K. Krupskaya (1869-1939), A.V. Lunacharsky (1875-1933), M. I. Kalinin (1875-1946), A. S. Makarenko (1888-1939), V. A. Sukhomlinsky (1918-1970).

## **RESULT AND DISCUSSION**

The fact that pedagogy has put forward such a large number of major teachers is not accidental. The society with its intensive development of production, science and culture required increasing the literacy of the main producers. Without this, it could not develop. Therefore, the number of educational institutions is growing, the network of public schools that provide the necessary training for children is expanding, special educational institutions for teacher training are opening, and pedagogy is being taught as a special scientific discipline. All this gave a great impetus to the development of pedagogical theory.

Having emerged as a science about the education of children and youth, pedagogy, as the boundaries of education and the scope of subjective factors in the life of society expand, increasingly become a science about the General laws of educational influence on people of all ages.

All the period of its development, pedagogy was based primarily on education and training.

## **CONCLUSION**

In turn, education is an educational facet of education, has a scientific-disciplinary and natural essence, representing an integral pedagogical process, during which educational tasks are solved, education and development of students are carried out. This process is primarily two-way. On the

one hand, it serves as a training (teacher), who sets out the program material and manages this process, and on the other – students, for whom this process takes the nature of teaching, mastering the material being studied. Their joint activities are aimed at deep and lasting assimilation of scientific knowledge, development of skills and abilities, their practical application, development of creative abilities, formation of a materialistic worldview and moral and aesthetic views and beliefs.

Training should be available to this class, age, and level of development. And all that is available is based on the knowledge that is available in the child's mind, obtained in the process of education, family education, direct reflection of natural and social phenomena, communication with adults and peers, in reading, television programs, movies.

**REFERENCES:**

1. M.Jorayev. Fundamentals of military pedagogy and psychology. Text of lectures. FSU, 2010
2. Sh.Tilavoldiyev, S.Kochkarov. Fundamentals of military patriotic education. Methodological manual. FSU, 2020
3. N.Boymurodov. Applied psychology. Study guide. Tashkent, 2008
4. Ilkhom Abdirakhimov. Development of effective demulsifiers on the basis of local raw materials // Universum: технические науки: научный журнал. – № 2(83). Часть [4] М., Изд. «МЦНО», 2021. DOI: 10.32743/UniTech.2021.83.2-4.36-39.

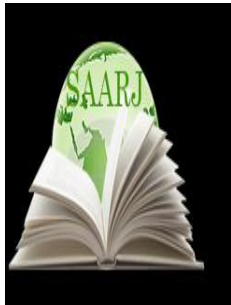

**ACADEMICIA**  
**An International  
 Multidisciplinary  
 Research Journal**  
 (Double Blind Refereed & Peer Reviewed Journal)



**DOI: 10.5958/2249-7137.2021.01159.9**

## DEVELOPMENT OF ENVIRONMENTAL LEGISLATION OF THE REPUBLIC OF KARAKALPAKSTAN AFTER GAINING INDEPENDENCE

**Sultanbek Bazarbaevich Tanirbergenov\***

\*Senior Lecturer,  
 Karakalpak State University named after Berdakh,  
 UZBEKISTAN  
 Email id: tanirbergen77@mail.ru

### ABSTRACT

*The article is devoted the problems of ecological legislation development in the Republic of Karakalpakstan. The Constitution declared land, water, forests, and its bowels to be national wealth [1, 53]. The Constitution was the basis for the environmental legislation of the Republic of Karakalpakstan. These rules unconditionally determine the responsibility of representatives of local khakimiyats for the state of the environment in the region (city), namely, they not only endow them with certain rights in the field of environmental protection, but also increase their responsibility in this regard.*

**KEYWORDS:** *Constitution, Environ mental Legislation, Environ mental Rights Of Citizens, Environmental Information, Environmental Education, Environmental Insurance, Environmental Audit, Ecological Disaster Zones, Compensation For Environmental Damage, Agrochemicals, Environmental Protection.*

### INTRODUCTION

Since gaining independence by the Republic of Uzbekistan, in accordance with generally accepted norms and principles of international environmental law and national environmental legislation, consistent steps have been taken to develop and improve the organizational structure of environmental quality management and rational use of natural resources. In the context of complex structural transformations carried out in the sectors of the country's economy, an increase in the volume of traffic flows and transportation, the intensification of agricultural and industrial production, a significant increase in the urban population, the solution of environmental protection problems, the organization of rational use of natural resources, the

reproduction of natural resources, ensuring the environmental safety of the population and ecological systems are the most important tasks of our state.

## **MATERIALS AND METHODS**

The formation of the environmental legislation of the Republic of Karakalpakstan is associated with the adoption of the Constitution of the Republic of Uzbekistan and, on its basis, the Constitution of the Republic of Karakalpakstan. The Constitution declared land, water, forests, and its bowels to be national wealth [1, 53]. The Constitution was the basis for the environmental legislation of the Republic of Karakalpakstan. The Constitution was adopted in 1993 on April 9 at the XII session of ZhukorgiKenges of the Republic of Karakalpakstan of the 12th convocation. It outlines the main plans of the state's environmental strategy and the main directions of consolidating the environmental legal order.

On the basis of the Constitution of the Republic of Uzbekistan, the Laws of the Republic of Karakalpakstan "On Nature Protection", "On Land", "On Subsoil", "On Forests", "On Water and Water Use", "On Protection of Atmospheric Air", "On Protection and Use of flora ", " On the protection and use of the animal world ", " On waste ", " On specially protected natural areas. " The Constitution of the Republic of Karakalpakstan has defined four articles related to the protection of the natural environment. In particular, Article 48 requires citizens of the Republic of Karakalpakstan to respect the environment. This article appeared for the first time on the basis of the Constitution of Karakalpakstan and is aimed at increasing the responsibility of citizens for the state of the environment, to prevent the ownerless and only in their own interests, the relationship of man to nature. Article 53 of the Constitution reads: "The land, its subsoil, waters, flora and fauna and other natural resources are national wealth, subject to rational use and protected by the state." This article also has environmental and economic content. Article 52 implies: "The use of property must not harm the surrounding reality." The Constitution pays special attention to the role of state bodies in the protection of the natural environment, its protection. Since, with the development of market relations, the rights of private owners have expanded. In such conditions, economics and ecology can contradict each other. The Constitution emphasizes the priority of the environmental interests of society.

Article 90 of the Constitution of the Republic of Karakalpakstan defines the tasks of state bodies and in it special attention is directed to the regulation of environmental protection.

These rules unconditionally determine the responsibility of representatives of local khakimiyats for the state of the environment in the region (city), namely, they not only endow them with certain rights in the field of environmental protection, but also increase their responsibility in this regard. The provisions of the Constitution of the Republic of Karakalpakstan are concretized in other sources of environmental law [2, 112].

At the same time, an analysis of Article 53 of the Constitution of the Republic of Karakalpakstan shows that it deals with natural resources as a nationwide wealth, but they are not considered as a necessary source of life for the present and future generation. Since the health of citizens is in many ways inextricably linked with their right in relation to a comfortable natural environment.

In this regard, we believe that the constitution, which is the main source, both for all other areas and for environmental legislation, should express along with the duties of a citizen a respectful

attitude to the environment, as well as their rights to a comfortable natural environment [3, 212-213].

Modern development of legal regulation of environmental relations makes it possible to draw conclusions about the objective foundations of further improvement of environmental legislation on environmental protection and regulation of relations to ensure environmental safety, rational use and protection of natural resources [4, 91].

## RESULT AND DISCUSSION

The basic principles and mechanism of action of the above legal documents of environmental significance, in general, should be reflected in the main law of our country. Similarly, the Law "On Nature Protection" today cannot cover all environmental and legal relations, nor coordinate the political and legal, socio-economic, organizational and technical mechanisms of the environmental policy of our country. Since it does not sufficiently regulate the issues of social cooperation between state bodies and civil society institutions in resolving environmental problems, the environmental rights of citizens, the mechanism their protection, environmental information, environmental education - upbringing, as well as relations such as environmental insurance, environmental audit, environmental disaster zones, their legal status, compensation for environmental damage, agrochemicals.

This Law is considered complex not only in terms of the content of social relations required by regulation, but also in the form of legal regulation.

This means that the norms of environmental legislation, occupying a central place, but not the only one on the steps of legislation on environmental protection, act together with a set of norms of others - administrative, civil, etc. legal spheres. In particular, the provisions of the law on compensation for damage (Articles 49, 51) were more concretized by the provisions of civil law, etc. Such norms provide a link between environmental legislation and other branches of legislation.

In the Constitution of the Republic of Uzbekistan, the political, socio-economic and spiritual foundations of society are enshrined in independent sections and are defined quite specifically, and the foundations of environmental policy are contained in the norms of various sections and set out in a declarative form.

In order to improve constitutional norms and environmental and legal relations, in our opinion, it would be advisable to combine all environmental norms into an independent chapter - "Fundamentals of Environmental Policy". This chapter should include four articles that establish the foundations of environmental policy: 1) Ownership of natural objects and resources; 2) Basic requirements for the protection of the natural environment; 3) Basic requirements for the use of natural resources; 4) Requirements for ensuring the environmental safety of the population.

The Constitution of our state enshrines the basic environmental rights and obligations, as well as the principles of environmental protection and the use of natural resources. The mechanism for the implementation of these norms is specified in environmental legislation.

## CONCLUSION

In conclusion, it can be noted that the current level of development of environmental legislation, formed in the years of independence, is constantly evolving. It is continuously associated with large-scale economic reforms, privatization processes, democratization of all sectors of society. During this period, the initial important documents were adopted on the formation of environmental legislation in the country. Despite this, in this area, a codification document has not yet been adopted that comprehensively regulates environmental relations. Therefore, the main attention of representatives of lawmaking, scientists engaged in research in this area, should be aimed at creating harmony between man - society - nature, finding a legal solution that meets the requirements of today to regulate relations between them and, finally, to further improve organizational and legal mechanisms in this area. Constitutional environmental provisions are fundamental for the development of the branch of environmental law, aimed at regulating the foundations of environmental relations. In addition, the constitutional foundations should become the basis for the formation of modern environmental legislation.

## REFERENCES:

1. Constitution of the Republic of Karakalpakstan. - Nukus: Karakalpakstan, 2021.S. 53.
2. Bakhiev E., Khodzhanizov D. The origin of biosphere life.-Nukus: Karakalpakstan, 1995. P. 112.
3. Zhoraev Yu.O. Constitutional norms as a guarantee of ensuring the environmental interests of citizens // Constitution and human interests: materials of an international scientific and practical conference. - Tashkent: Academy of the Ministry of Internal Affairs of the Republic of Uzbekistan, 1997.-- B. 212-213.
4. Erofeev B.V. Environmental law of Russia. Textbook. 20th edition. - M.: Eksmo, 2007.-- P.91.
5. Ilkhom Abdirakhimov. Development of effective demulsifiers on the basis of local raw materials // Universum: технические науки: научный журнал. – № 2(83). Часть [4] М., Изд. «МЦНО», 2021. DOI: 10.32743/UniTech.2021.83.2-4.36-39.

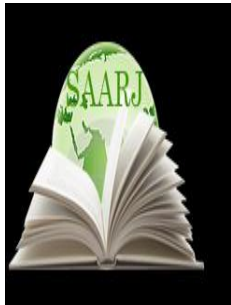

**ACADEMICIA**  
**An International**  
**Multidisciplinary**  
**Research Journal**  
 (Double Blind Refereed & Peer Reviewed Journal)



**DOI: 10.5958/2249-7137.2021.01158.7**

## LEGAL BASIS FOR THE DEVELOPMENT OF RADIO AND TELEVISION IN THE REPUBLIC OF KARAKALPAKSTAN

**A.K. Utepbergenova\***

\*Senior Teacher,  
 Nukus branch of the Uzbek State Institute of Arts and Culture,  
 Nukus, UZBEKISTAN  
 Email id: utepbergenova85@gmail.com

### ABSTRACT

*The article analyzes the history of the creation of the legal basis for the development of radio and television in the Republic of Karakalpakstan and the radical change in business activity, the expansion of creative opportunities. Most importantly, today the urgent task is to strengthen the role of the media, to protect the professional activities of journalists, to create a radio and television that can penetrate the hearts of the population and critically analyze the existing problems.*

**KEYWORDS:** *Television, Radio, Tv-Journalism, TV-Programme, Editorial Staff.*

### INTRODUCTION

Radio and television, one of the sources of mass communication and information of the twentieth century, have rapidly entered the life of society and become a factor influencing the formation of social and spiritual consciousness. When we think of television and radio interacting with the general public, we mean not just a single-meaning television and viewing event, but an extremely complex, routine, process that affects the worldview of millions of viewers. Basically, television and radio have demonstrated in a very short period of time that they are a very broad, mass, fast, and lively art medium in terms of technical capabilities, the scope of creative research, compared to other art forms. Television and radio have invented new means of expression in the solution of life's problems, in the perfection of the human heart and mind [1].

### MATERIALS AND METHODS

The development of radio and television in the Republic of Karakalpakstan dates back to the years of independence. It was during this period that the development of television and radio

broadcasting became an important direction of the ongoing socio-political and socio-economic reforms in the country. At the state and government level, unprecedented changes and creative developments have begun as a result of the import of modern technical equipment from the most developed countries of the world. For the first time, specialized, private and digital TV channels have been launched. Infrastructure has been created for the sector. Such changes require the study of the development of radio and television and their place in the socio-cultural life of the population in a separate topic. Most importantly, today the urgent task is to strengthen the role of the media, to protect the professional activities of journalists, to create a radio and television that can penetrate the hearts of the population and critically analyze the existing problems.

In order to meet the information needs of the population of the republic, to radically improve the content of television and radio programs, to expand the range of broadcasts and genres, it has been done on the basis of laws and decisions adopted by our government [2].

## RESULT AND DISCUSSION

Decree of the President of the Republic of Uzbekistan No PF-309 of January 7, 1992 “On transformation of the State Committee for Television and Radio Broadcasting of the Republic of Uzbekistan into the State Television and Radio Broadcasting Company of Uzbekistan”, March 28, 1994 “On measures to strengthen the material and technical base of the State Television and Radio Broadcasting Company of Uzbekistan” August 25, 1997 “On complex re-equipment of the system of the Uzbek Television and Radio Company”, November 8, 2005 “On measures to reform and develop independent television and radio broadcasting channels”, December 27, 2005 “The adoption of the Resolution “On measures to improve the activities of the National Television and Radio Company of Uzbekistan” shows that a wide field of action for creative research in the field has been created, all conditions have been created to open new opportunities. [3]

In order to reform and develop the National Television and Radio Company of Uzbekistan and independent television and radio channels, reorganize their activities, and initially improve the regulatory framework, a number of normative acts of the Cabinet of Ministers of the Republic of Uzbekistan were adopted. In particular, on the basis of the Resolution of the Cabinet of Ministers of the Republic of Uzbekistan dated February 14, 2006 “On measures to organize the activities of territorial divisions of the National Television and Radio Company of Uzbekistan” practical measures were taken to reorganize the Republic of Karakalpakstan and regions [4].

In particular, on the basis of the laws adopted by the Oliy Majlis of the Republic of Uzbekistan, the Jogorku Kenesh of the Republic of Karakalpakstan has adopted several laws related to journalism. In particular, the Law of the Republic of Karakalpakstan of 5 October 2007 “On Mass Media” (as amended), 25 June 1997, the Law “On Protection of Journalism”, 25 June 1997, “Guarantees of access to information and Law on Freedom of Information, August 28, 1999, Law on Advertising, November 12, 2003, Law on Principles and Guarantees of Freedom of Information, Law of August 29, 2007, Law on Copyright and Related Rights For example, the Law on Mass Media has been repeatedly appealed to, a number of amendments and additions have been made to its new editions, censorship has been abolished, and the independent operation of television and radio has been ensured to ensure its economic independence. In general, over the years of independence, more than 40 normative legal acts have been adopted in this area [5].



Karakalpak radio and television cover the socio-political, socio-economic and cultural life of the Republic, other major social events and events taking place here, addressing important issues of socio-economic development of local authorities and self-government, political and social development of citizens. has been developing programs aimed at increasing their social activity and effectively organizing their activities to protect their constitutional rights and freedoms. Development of information-humanitarian, educational, cultural-enlightenment programs taking into account the interests of the multi-ethnic population of the Republic of Karakalpakstan, popularization of modern achievements in the field of world culture, art, music, tourism, cinema, taking into account the interests of the multi-ethnic population and prepares TV viewers, radio listeners and, above all, high-level artistic and entertaining TV and radio listeners who cultivate a sense of beauty and spirituality in young people and children [6].

## CONCLUSION

As a result of reforms in the system during the years of independence, the Karakalpak TV and Radio Company has become the only broadcaster that covers 95-98% of the territory of the Republic in terms of the distribution of its TV and radio channels. During the years of independence, the activities of the Karakalpak TV channel have changed radically. Various shows and TV programs in new genres have been created. Today, the Karakalpak TV channel broadcasts 18 hours a day in analog and digital formats [7].

In April 2013, the TV programs of Karakalpakstan were included in the digital broadcasting network "UZDIGITAL TV". Thanks to the dubbing studio, which opened on June 1, 2013, young viewers have the opportunity to watch cartoons in Karakalpak. In 2014, a second dubbing studio was launched, and the start of dubbing movies into Karakalpak is one of the biggest achievements in the industry [8].

## REFERENCES:

1. Мирзиёев Ш. Миллий тараккиёт йулимизни катъият билан давом эттириб, янги босқичга кутарамиз. 1-жилд. - Т.: Узбекистан, 2017.
2. Тўртинчи Ҳокимият. Ўзбекистон республикасининг оммавий ахборот воситалари, ноширлик ва матбаачилик фаолиятини тартибга солувчи қонунлари, қарорлари ва бошка ҳужжатлари тўплами. Т.2003.
3. Т.Аҳмедов. Ўзбекистонда телевиденининг ривожланиш жараёни ва унинг аҳолии ижтимоий-маданий ҳаётидаги ўрни. Тарих фанлари буйича фалсафа доктори (PhD) Автореферат дисс.. Т.2019.
4. Мадреймов Т. История и развития средств массовой информации в Каракалпакстане в 1930-1990 гг. (радиовещание и телевидение). Автореф. дисс. канд. истор. наук. - Т., 1997
5. Мадреймов Қ. Журналистика кәсибининң жанкүйери. Н. 2015.
6. Уснатдинов Ш. Журналистикаға кирисиў. Н. 2009.
7. Pkhom Abdirakhimov. Development of effective demulsifiers on the basis of local raw materials // Universum: технические науки: научный журнал. – № 2(83). Часть [4] М., Изд. «МЦНО», 2021. DOI: 10.32743/UniTech.2021.83.2-4.36-39.

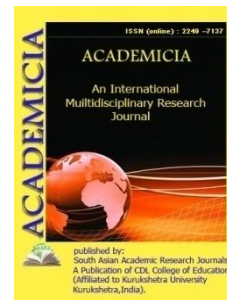
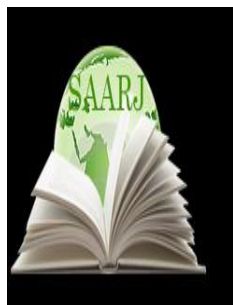

DOI: [10.5958/2249-7137.2021.01157.5](https://doi.org/10.5958/2249-7137.2021.01157.5)

## THE CONCEPT OF «BUSINESS POTENTIAL»: ESSENCE, ECONOMIC SIGNIFICANCE

**Bozorova Muborak Sharopovna\***

\*Senior Lecturer at the Department of Foreign Languages,  
Tashkent Financial Institute,  
UZBEKISTAN

---

### ABSTRACT

*This article discusses existing approaches to entrepreneurial potential. The term entrepreneurial potential is analyzed by the author, on the basis of which he formulates an integrated definition of the studied concept, takes an attempt to apply a systematic approach to solving the problem.*

**KEYWORDS:** *Entrepreneurship, Entrepreneur, Innovation, Entrepreneurial Potential, Entrepreneurial Activity, Opportunities, Risk, Economic Growth, Business.*

---

### INTRODUCTION

The emergence of various forms of ownership in the economy, development of small business and private entrepreneurship has been identified as a priority of the economic policy of the country since the early days of independence.

The essence of the Decree of the President of the Republic of Uzbekistan “On the Strategy of Action for the Further Development of the Republic of Uzbekistan” also envisages the acceleration of socio-economic development and liberalization of the economy, further development of entrepreneurship[15]. One of the most important objectives of the Strategy is to continue institutional and structural reforms aimed at reducing the government’s involvement in the economy, protecting its private property and strengthening its prestige, and stimulating the development of small business and private entrepreneurship. Entrepreneurship, as a type of activity, implies that entrepreneurs have a certain way of thinking, a special style and type of economic behavior, expressed in a creative attitude to the matter, free manifestation of initiative, a constant desire for innovation, the search for innovative solutions and opportunities, expanding the scope and scope of activities and, which is especially important, constant readiness for risk and finding ways to overcome it.

In economically developed and developing countries, entrepreneurship is recognized as the driving force of the economy, and the degree of its development depends on the formation and implementation of entrepreneurial potential. Being a kind of labor potential, it has specific features, determined both by the nature of a particular type of entrepreneurial activity, and by the characteristics of a particular economic system. Entrepreneurial potential is a complex economic category, the study of which is extremely important in terms of assessing the reserves of entrepreneurship development. The latter, in turn, is the result of the realization of the potential under consideration, a source of economic growth, and the strengthening of the national economic system as a whole.

## LITERATURE REVIEW

Entrepreneurial potential of innovations, role implementation form functions, the final product of economic creativity, etc. At the beginning of the 18th century, R. Cantillon and his followers J. Thünen, G. Mangoldt, and F. Knight singled out risk ability as one of the elements of entrepreneurial potential. J. Schumpeter considered innovation, creativity as the leading ability of an entrepreneur. L. Mises, F. Hayek, I. Kirtsner focused on such individual psychological characteristics of the entrepreneur as managerial abilities, independence in choosing and decision making, the ability to respond to changes in economic and social situation [1]. Leading economists of the country Gulyamov SS [13], HodiyeV.B. Yu., Kasimova MS [14] Other scientific and theoretical works and theoretical and practical aspects of business development were analyzed in detail.

Stepanov A. Ya .. and Ivanov N. V. considering the entrepreneurial potential of the organization, understand it as “the combined capabilities of the enterprise to determine, shape and maximize the needs of consumers in goods and services in the process of optimal interaction with the environment and rational use of resources” [10]. The most comprehensive assessment of entrepreneurial potential is given by P.V. Zhuravlev [6], which includes its structure are elements such as professional knowledge, innate and acquired abilities, innovative potential, as well as extra functional qualifications. To the memory of Cheplyaeva I. E. entrepreneurial potential - an economic category, “representing a socially determined set of opportunities and abilities for organization and implementation entrepreneurial activity by its carriers ” [12].

Tikhonova N.E. and Chepurenko A. Yu. define entrepreneurial potential as “the totality of all individuals ready for occupation entrepreneurial activity” [11]. M.V. Grachev believes that “entrepreneurial potential is a combination of orientation to achieve success, personal and collective responsibility, freedom of expression and creativity” [4]. Thus, the entrepreneurial potential is identified by the authors, first of all, with a person as his carrier. As a result, the interpretation of the concept under consideration is limited, as a rule, to the structural level and subject of disciplinary research. At the same time, the concept under study, as we believe, is much broader. Indeed, the formation and realization of entrepreneurial potential is impossible to inhuman. However, man, existing in a real socio-economic reality cannot realize their entrepreneurial abilities without an appropriate educational level, resource, infrastructural, legal and other support, i.e., without adequate conditions. Moreover, the creation of the latter requires compliance with the principle of consistency, based on them utility levelness of the national economy, and therefore the concept of entrepreneurial potential is multilevel. Therefore, in our opinion, the above definitions need further determination. To this end, we analyze the concepts

of “entrepreneurship” and “potential” and formulate on this basis an integrated definition of entrepreneurial potential.

### ***ANALYSIS AND RESULTS***

The essence and content invested in the concept “entrepreneurship” in the development of economic theory changed and ordered. It is believed that A. Smith was one of those who first became involved in entrepreneurship. However, another ten years before him, these problems seriously R. Cantillon was interested, formulating the thesis according to which the difference between supply and demand in the market makes it possible individual market entities to buy goods cheaper and selling them more expensive. It was he who called these market entities “entrepreneurs, “that is, in translation from French, “intermediaries.”[3] There is no clear definition of entrepreneurship in modern economic literature. As a rule, in most cases, its essence is replaced by the goal of entrepreneurial activity, i.e., maximizing profits. However, as suggested by G. Bagiyev and Asaul A.N., this definition cannot be considered complete. “Most practitioners and researchers focus on making a profit, seeing it as the ultimate goal of entrepreneurship. However, entrepreneurship has as its ultimate goal not so much profit as the continuity of the reproduction process associated with the reproduction of demand and the satisfaction of constantly changing, constantly increasing needs of an individual or a social group, society as a whole. In this regard, entrepreneurship isomer correctly defined as a process of continuous search for changes in needs, end-user demand for products and services, satisfying this need by organizing production, marketing, marketing, logistics, management, focused on the best innovations that bring maximum productivity in each of stages of there production process” [1]. Thus, the authors focus on the consumer and his needs, the satisfaction of which can bring maximum profit. In our opinion, such a definition is most consistent with modern socioeconomic reality, reflecting the principle of the social orientation of market relations. Moreover, this approach does not at all deny the risk, initiative and innovativeness inherent in entrepreneurship.

As StepanovA.Ya.and Ivanov N.V., and does notexist unambiguous definition of the term "potential"[8]. At all, the potential comes from the Latin Potentialis - powerful, literally powerful [11]. In various sources, potential is defined as power, strength[5] or as “means, stocks, sources available and able tobe mobilized, put into action, used to achieve certain goals, implement the plan; solving a problem; the possibilities of an individual, society, state in a certain area ” [2]. In other words, the potential characterizes real (and not theoretical) possibilities that currently cannot be implemented due to various reasons or lack of relevant conditions. For entrepreneurial activity as such conditions favors the business environment. Recall that the latter should be understood as “the prevailing in the country (region, municipality)favorable socio-economic, political, civil law situation that provides economic freedom for capable citizens to engage in entrepreneurial activities aimed at meeting the needs of all subjects of a market economy” [7].

Hence, the business environment, in our opinion, can be represented as a reflection of the totality of the real conditions and opportunities for doing business that are already implemented today. In our opinion, the entrepreneurial potential should be considered as a combination of real business opportunities that can be realized through providing a favorable entrepreneurial climate [8]. Note that by “real” we mean those economic, social, legal and other conditions in which entrepreneurship is currently functioning and developing. In this sense, speaking of entrepreneurial potential, we are talking about the current resource, infrastructural and other support, its more efficient use, real people with relevant personal characteristics, ready to

become subjects of the activity in question, but not able to do it by virtue of financial and other barriers, adverse conditions created [9]. From this, on the one hand, we can conclude that the "entrepreneurial potential" is logically regarded as a concept similar to the concept of "entrepreneurial resource", which means "the ability to efficiently organize economic resources for carrying out economic activities." On the other hand, the entrepreneurial potential, in addition to the efficient use of resources, also includes the totality of opportunities to do this, and therefore we consider this concept more complex and voluminous.

### CONCLUSIONS AND SUGGESTIONS

1. The formation of entrepreneurial potential is the most important factor in the development of the business sphere, and entrepreneurial potential is its key element. Business sphere also includes the entrepreneurial environment as a condition for the realization of entrepreneurial potential and entrepreneurial activity.
2. To determine the nature and structure of entrepreneurial potential, we propose a multi-level approach, according to which entrepreneurial potential is necessary considered as a system with complex hierarchical and socio-economic structures.
3. To date, there is no single methodology, and also scorecards for assessing entrepreneurial potential. we consider it appropriate to use the three-component method assessments involving the inclusion in the system of indicators of such factor variables as a socio-economic state subject, socioeconomic aging of the subject and its economic performance.
4. In order to improve the qualitative and quantitative characteristics human component of entrepreneurial potential, and also ensuring a positive perception of entrepreneurial potential.

So, the analysis allows us to conclude that entrepreneurial potential must be seen as a multi-level system of resources and real business opportunities that can be realized through risky, innovative activities and the organization of favorable business environment in order to ensure socio-economic the effectiveness of the functioning of the business sector.

### REFERENCES:

1. Asaul, A. (2008). *Patterns and trends in the development of modern entrepreneurship*.(p.280). Moscow: ANO "IPEV".
2. Bagiev, G.L., &Asaul, A.N. (n.d.).*Organization of entrepreneurial activity: The content of entrepreneurial activity*. Retrieved from [http://www.aup.ru/books/m72/1\\_1.html](http://www.aup.ru/books/m72/1_1.html)
3. Vasyukova, I.A. (2005). *Dictionary of foreign words*. (p.992). Moscow: Astrel; AST:Transitbook.
4. Grachev, M.V. (1998). *Innovative Economics: Monograph P.V.Zhuravlev. Personnel Management in Entrepreneurial Organizations /P.V.Zhuravlev*. (p.224). Moscow: Russian Academy of Economics.
5. Grachev, M.V. (1993). Entrepreneur in themodern economy. *Society and Economics*, No.4, pp.28–40
6. Zhuravlev, P.V. (1998). *Human Resource Management in Entrepreneurshiporganizations*. (p.224). Moscow: Russian Academy of Economics.

7. Lapusta, M.G. (2000). *Entrepreneurship*.(p.448) Moscow: INFRA-M.
8. Likhanos, E.V., &Baidakov, A.N. (2011) *Entrepreneurial potential. Formation entrepreneurial potential as a factor in the development of the business sphere*. (p.178).LAP LAMBERT Academic Publishing GmbH& CO. KG.
9. Likhanos, E.V. (2010). The resource base of entrepreneurial potential region. *Economic vector of the region StGAU*, No. 1 (5), pp. 48-53.
10. Stepanov, A.Ya.,& Ivanov, N.V. (n.d.).*Category "potential" in the economy*.Encyclopedia of Marketing. Retrieved from<http://www.marketing.spb.ru/read/article/a66.html>
11. Chepurenko, A.Yu. (2004). *Small business in asocial context*. (p.480). Moscow: Nauka.
12. Cheplyaeva, I.Ye. (1999). *Entrepreneurial potential: Problems formation and use in the Russian economy*: dis. ... cand. econ. Sciences:08.00.07. (p.168). Saratov.
13. Gulyamov, S.S. (2008). *Entrepreneurship andsmall business*. (p.365). Tashkent.
14. Kasymova, M.S., et al. (2003). *Small BusinessManagement*. (p.253). Tashkent.
15. (2017). Decree of the President of the Republic ofUzbekistan “On the Strategy of Action for theFurther Development of the Republic ofUzbekistan”. “*People's Word*” G//// 08.02.2017y. No. 28.
16. IlkhomAbdirakhimov. Development of effective demulsifiers on the basis of local raw materials // *Universum: техническиенауки: научныйжурнал*. – № 2(83). Часть [4] М.,Изд. «МЦНО», 2021. DOI: 10.32743/UniTech.2021.83.2-4.36-39.

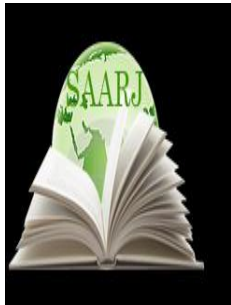

**ACADEMICIA**  
**An International**  
**Multidisciplinary**  
**Research Journal**  
 (Double Blind Refereed & Peer Reviewed Journal)



**DOI: 10.5958/2249-7137.2021.01176.9**

## IMPROVING TECHNOLOGIC EDUCATION ON THE BASIS OF THE STEAM METHOD

**G.I. Ishmuradova\* ; M. Kucharova\*\***

\*Associate Professor,  
Karshi State University,  
UZBEKISTAN

\*\*Master of the 2<sup>nd</sup> stage,  
Karshi State University,  
UZBEKISTAN

### ABSTRACT

*This article provides information about the integration of science in improving the teaching of technology in the system of continuing education, focuses on the relevance of science, defines the integration and application of the STEAM method of a new approach to integrated education.*

**KEYWORDS:** *Integration, Technology, Education, STEM, STEAM STREAM Method.*

### INTRODUCTION

The growth rate of economic development of the new Republic of Uzbekistan is highly recognized by the world community. It is also the result of large-scale reforms aimed at the development of science, education reform, and the full support of scientific and innovative activities. The transition to a path of development based on innovation and integration is being accelerated as one of the priorities of the country's economic development.

To do this, the subject (linear) development of curricula for the system of continuing education, the development of certain ideas, concepts, patterns in the minds of students, that is, the prevention of the formation of the form of plates, the integration and study of content-related subjects leads to the effectiveness of educational work[1].

The interactive course of technology education is a system of visual education, which explores the secrets of creating visual skills based on the deepening and expansion of integrative knowledge. The system of visual education is based on different types, forms, methods, objects.

---

## MATERIALS AND METHODS

*Technology is an integrative approach to education* - it involves interdisciplinary connections. The word integration is Latin and means to restore, to fill, to unite parts as a whole. Integrative education is a study that expands, complements and deepens the content, integrates the study of interdisciplinary specialties[2].

It is known that in the system of general secondary education, the use of an integrated approach in the selection of technology educational content and taking into account its main task, comprehensive human development, life and work, career choice and future career secrets. is to prepare for the study. In the system of continuing education, the selection of the content of education for a particular profession (specialty) on the basis of an integrated approach takes into account the field of production. There are different theories in the organization of the integrative approach today, and we think that it is appropriate to take this direction in education as follows[2].

1. Intra-science integration. It is based on theoretical knowledge and practical skills within a single subject.
2. Interdisciplinary integration. It is based on theoretical knowledge and practical skills in several subjects
3. Integration of subject sciences and methods of its teaching. This creates new theories based on previously learned knowledge.

In the study of interdisciplinary issues in the teaching of general secondary subjects of technology education in general secondary schools, in particular, drawing, painting, physics, mathematics, mother tongue, literature, and ecology The presence of cracks was detected.

The development of modern integrative education is aimed at improving the new state educational standards and curricula of general secondary education, as well as the gradual implementation of STEAM methods.

The STEAM integrated education approach is one of the major trends in global education. It covers math, technology, creativity, engineering and the natural sciences.

The integrated learning process allows for the training of required specialists in engineering, design and modeling. STEAM is integrated learning within a scientific and technological concept based on real-life requirements.

The goal of integrated education is to envision education, society, work, and the world as a whole, and to build sustainable relationships between them.

STEAM educational technology is a new method of teaching school students, which is different from traditional teaching methods. It is designed to teach students four subjects at the same time –subject (Science), technology (Technology), engineering (Engineering), Fine Arts, and Mathematics. STEAM is an integrated learning system for subjects, not for science[3].

STEAM education is the application of scientific and technical knowledge in real life through practical training.



## RESULT AND DISCUSSION

### How did this educational approach come about?

STEAM education technology is a combination of theory and practice. The abbreviation STEM was first proposed by the American bacteriologist R. Colwell in the 1990s, but has only been in active use since the 2000s. STEM education is a set of educational activities that contribute to the study of technology and engineering, from pre-school education. Based on STEM (science, technology, engineering, mathematics), new variants of this concept have emerged, the most common of which are STEAM (science, technology, engineering, art and mathematics) and STREAM (science, technology, robotics, engineering, digital 'at and mathematics).

Today, STEAM is one of the main trends in world education. With the rapid development of technology, new professions are emerging. The demand for STEM professionals is growing everywhere. According to various estimates, STEAM knowledge is required in 9 out of 10 majors with high growth rates. In particular, by 2018, the demand for specialties such as chemical engineers, software developers, petroleum engineers, computer systems analysts, mechanical engineers, civil engineers, robotics, nuclear medicine engineers, underwater architects, aerospace engineers is expected to increase. STEAM education prepares students for a technologically advanced world. Technology has grown exponentially over the past 60 years.

Examples include the Internet (1960) and GPS technology (1978) to DNA scanning (1984) and of course the iPod (2001) and others. Today, almost everyone uses smart phones. It is impossible to imagine our world without technology. Technology continues to evolve, and STEM skills are at the heart of that development.

The application of the STEAM method in technological education is carried out in the following stages:

1. Mathematics, physics, technology, etc. are studied;
2. The STEAM method identifies a system of knowledge, skills, and competencies that students can acquire;
3. The interdisciplinary task to be done is defined;
4. Evaluation, testing, improvement. Development of a project for the production of products, evaluation system based on the STEAM method;
5. Giving to students an itemsto make different types of things.

So, they use different methods based on queries and projects to solve the problem.

The theme: Sewing the clothes to teapots and embroidering teapots

1. Composition selection
2. Draw a sketch
3. Take measurements
4. Select the thread color
1. Select the type of material

2. Sew the seam type

3. Necessary equipment: needle, thread, material, ruler, colored pencils, paper.

### **The connection between the STEAM method and sewing clothes teapots and embroidering teapots**

**1-TABLE**

<b>Technology</b>	<b>Mathematics</b>	<b>Engineering</b>	<b>Fine art</b>
They learn the sequence of work, that is, the development of technology.	Measurement and calculation skills will be strengthened	Properties of the material: permeability, wettability design, learn to construct.	They choose the shape, appearance, color, composition

### **CONCLUSION**

Thus, the use of integrative approaches in the training of technology teachers builds engineering skills in students, leading to the improvement of technological knowledge and technological competencies.

### **REFERENCES:**

1. Abdukuddusov O.A. Professional pedagogy. Tashkent. OMKHTTKMO and UKTI.-2013-311b.
2. Proceedings of the traditional XV Republican scientific-practical conference of young scientists, doctoral students, masters and students on the theme “The use of innovative technologies in the integration of education, science and industry - an important factor in the development of the country” - Samarkand: SamDAQI edition, 2018.
3. Muhammadiyeva N.A. STEAM education is a modern approach to teaching. P. 484-487 “Improving the quality of general secondary education: content, methodology, assessment and learning environment” // Proceedings of the international online scientific-practical conference. Tashkent. 2020, August
4. PkhomAbdirakhimov. Development of effective demulsifiers on the basis of local raw materials // Universum: техничекиенауки: научныйжурнал. – № 2(83). Часть [4] М.,Изд. «МЦНО», 2021. DOI: 10.32743/UniTech.2021.83.2-4.36-39.

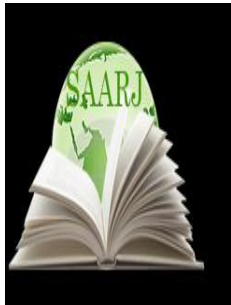

DOI: [10.5958/2249-7137.2021.01175.7](https://doi.org/10.5958/2249-7137.2021.01175.7)

## THE IMPORTANCE OF INTERACTIVE GAMES IN ENGLISH LANGUAGE TEACHING AND THEIR IMPACT ON THE TEACHING PROCESS

Nosirova Dilfuza Nabievna\*

\*An English Teacher,  
Andijan region law school, UZBEKISTAN

### ABSTRACT

*In this article was given information about the full use of interactive methods in teaching English, peculiarities of the process of pedagogical cooperation, the main basis of pedagogical technology, in English, each lesson, topic, specific technology of the subject, the need to pre-design the teaching process, and how to create a technological map of the lesson in appearance or form.*

**KEYWORDS:** *Interactive Methods, Pedagogical Cooperation, Teaching Process, Technological Map, Information Technology.*

### INTRODUCTION

The interest in the use of interactive methods, innovative technologies, pedagogical and information technologies in the educational process in the educational process is growing day by day. One of the reasons for this is that while traditional education has so far taught students to acquire only ready-made knowledge, modern technology teaches them to search for the knowledge they have acquired, to study and analyze it independently, and even to draw their own conclusions. The educator creates conditions for the development, formation, acquisition and upbringing of the individual in this process, and at the same time performs the function of management, direction. In the learning process, the student becomes the main figure.

Innovative technologies are innovations and changes in the pedagogical process and the activities of teachers and students, the implementation of which is based on the full use of interactive methods.

Interactive methods are called collective thinking, that is, methods of pedagogical influence, which are an integral part of the content of education. The peculiarity of these methods is that they are carried out only through the interaction of educators and students.

The process of such pedagogical cooperation has its own characteristics, which include:

- forcing the student to think independently, to create and to research, not to be indifferent during the lesson;
- Ensuring that students have a constant interest in knowledge in the learning process;
- to strengthen the student's interest in knowledge independently, creatively approaching each issue;
- The organization of constant joint activity of the teacher and the student.

According to teachers, researchers, practitioners studying the problems of pedagogical technology, pedagogical technology is only related to information technology, and improving the effectiveness of teaching that needs to be applied in the teaching process - the use of the teacher's technological tools, computers, distance learning, or a variety of techniques.

We believe that the most basic foundation of pedagogical technology is that it depends on the technology chosen so that the teacher and the student can work together to achieve a guaranteed result from the set goal, that is, in the process of teaching, each educational technology used to achieve a guaranteed result on purpose can form a collaborative activity between the teacher and the student, if both can achieve a positive result, in the learning process, if students can think independently, work creatively, research, analyze, draw their own conclusions, evaluate themselves, the group, the group and them, and the teacher is able to create opportunities and conditions for such activities, which is the basis of the teaching process.

Each lesson, subject has its own technology of the subject, that is, pedagogical technology in the learning process is an individual process, it is a goal-oriented, pre-designed and guaranteed pedagogical process based on the needs of the learner.

## **MATERIALS AND METHODS**

In English, it is up to the teacher and the student to choose what technology to use to achieve the desired result. Because the main goal of both parties is clear: to achieve a result. Depending on the level of knowledge of students, the nature of the group, the technology used, for example, to achieve the result, you will need to work with a computer, but you will need film, handouts, drawings and posters, various literature, information technology. It depends on the teacher and the student.

In addition, it is necessary to design in advance in the teaching of English, in the process of which the teacher considers the specifics of the subject, place and conditions,

Improving the effectiveness of education - the most important thing is to take into account the technological means of the teacher, the ability and needs of the student, as well as the ability to organize collaborative activities.

Only then can the desired guaranteed result be achieved. In short, the student needs to be brought to the center of learning. It is important for the teacher to be able to see each English lesson as a whole and to design the future lesson process in order to visualize it. In this case, the teacher

---

creates a technological map of the future lesson for each subject, the subject taught for each lesson, based on the nature of the subject, the capabilities and needs of students.

Creating such a technological map is not easy. Because for this, the teacher must be aware of pedagogy, psychology, private methodology, pedagogy and information technology, you will also need to know a lot of techniques, methods. The color of each lesson depends on the projected technological map of the lesson, which is carefully thought out in advance. The form or form of the technological map of the lesson depends on the experience, goals and will of the teacher. Whatever the technological map, it should reflect the course process as a whole and clearly reflect the clearly defined purpose, task and guaranteed result, the technology of organization of the course process.

The structure of the technological map saves the teacher from writing an extended syllabus of the lesson, because such a map reflects all aspects of the lesson process.

### **RESULT AND DISCUSSION**

In English, every subject of the subject taught by the teacher of English, the technological map created for each lesson, allows him to imagine and understand his subject as a whole (for one academic year), the beginning of a holistic learning process helps them to see the results to be achieved, starting with the goal. In particular, the technological map can be structured based on the student's ability and needs to bring him or her to the center of learning as an individual. This leads to better and more in-depth teaching of English compared to other subjects.

In the process of teaching English, students are treated as individuals, the use of various pedagogical technologies and modern methods allows them to think independently, freely, to research, creative approach to each issue, a sense of responsibility, conducting research, analysis, effective use of scientific literature, and most importantly, strengthens their interest in reading, science, pedagogue in his chosen profession. Achieving such a result in an English class requires the use of innovative and information technologies in the learning process in practice.

They are very diverse. Modern methods used in the teaching process, or technological trainings that help to increase the effectiveness of teaching, help students to develop logical, intellectual, creative, critical, independent thinking, helps them develop their skills, become competitive, mature professionals, and nurture the professional qualities that professionals need.

### **CONCLUSION**

From the above, it can be said that the use of new pedagogical technologies in teaching English makes the teaching process even more interesting, ensures the interest of students in science and language, as well as the development of mature personnel for the great future of our country.

### **REFERENCES:**

1. Kholikov A. Pedagogical skills - Tashkent .: Economics - Finance, 2010.
2. Azizkhodjayeva N.Kh. "Pedagogical technology and pedagogical skills" - Tashkent .: Tashkent State Pedagogical University, 2003
3. <https://cyberleninka.ru>
4. <https://uz.denometr.com>

5. <https://aim.uz>

6. Ipkhom Abdirakhimov. Development of effective demulsifiers on the basis of local raw materials // Universum: технические науки: научный журнал. – № 2(83). Часть [4] М., Изд. «МЦНО», 2021. DOI: 10.32743/UniTech.2021.83.2-4.36-39.

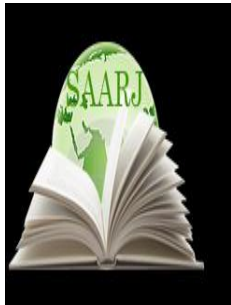

**ACADEMICIA**  
**An International**  
**Multidisciplinary**  
**Research Journal**  
 (Double Blind Refereed & Peer Reviewed Journal)



**DOI: 10.5958/2249-7137.2021.01174.5**

## THE FACTORS ACCELERATING THE INNOVATIVE ACTIVITY OF TEACHERS

**Khalilova Feruza Abdulvosievna\* ; Nasretdinova Feruza Nabievna\*\***

\*Teacher of the Department of Electric Power,  
 Fergana Polytechnic Institute,  
 UZBEKISTAN

\*\*Lecturer,  
 Department of Electric Power,  
 Fergana Polytechnic Institute,  
 UZBEKISTAN

### ABSTRACT

*In this article discusses the innovative activities of teachers, educational technologies, educational activity in education, the development of creative thinking in students, the formation of skills of critical approach to teaching materials. The period requires the student to become an active participant. This activity, in turn, serves as a basis for the formation of such qualities as conscious attitude, independence, creativity, inquisitiveness. Improving the innovative activity of the teacher depends on many factors, such as the choice of types of pedagogical technology - the knowledge to be formed, methods of action, personal qualities, organizational form of training, applied methods, tools and so on.*

**KEYWORDS:** *Innovation, Activity, Educational Technologies, Methods.*

### INTRODUCTION

At present, more and more problem-based, programmed, exploratory methods are used with students to activate the teaching process, and in practical classes, working and pedagogical games, giving individual assignments has become one of the prerequisites for the implementation of the combination of individual and group activities of students. One of the most important aspects of modern education is the achievement of an innovative nature of pedagogical activity.

The issue of achieving an innovative nature of pedagogical activity in developed countries has been seriously studied since the 60s of the last century.

---

## MATERIALS AND METHODS

Conceptual approach to innovation in science in methodology was described (Yu.V.Gromyko, V.I.Slobodchikov, P.G.Shedrovitsky, etc.); in psychology (L.S.Vygotsky, V.V.Davidov, N.F.Talyzina, etc.); described in general pedagogy (M.V.Klarin, M.M.Potashnik, A.I.Prigojin, N.R.Yusufbekova, K.Angelovsky, Yu.Voglaid, K.Rodgers and others).

In the scientific and pedagogical literature, the experience of preparing teachers for innovative activities is generalized by a number of scientists.

The study of innovation processes in education raises a number of theoretical and methodological issues related to innovation and creative activity of the teacher (criteria for evaluating innovation, traditions and innovations, features of the innovation cycle, the teacher's attitude to innovation, etc.). In their research, scientists often deal with a specific aspect of preparing teachers for innovative activities:

Improving the innovative activity of the teacher depends on many factors, such as the choice of types of pedagogical technology - the knowledge to be formed, methods of action, personal qualities, organizational form of training, applied methods, tools and so on. For example, it is recommended to use binary or integrative lessons, work or role play, heuristic dialogue in the development of creative thinking in students, the formation of skills of critical approach to the teaching material and the organization of productive learning activities. In this case, the teaching methods must be commensurate with the purpose.

Modern educational technologies allow students to search for the knowledge, methods of action and personal qualities they possess, to study independently, to express their opinions. In this process, the teacher performs the functions of management, direction, creating conditions for the formation and development of the learner.

Reasons for focusing on educational technology as a current problem:

- First, the breadth of opportunities for the development of the learner;
- secondly, to provide an opportunity to widely introduce a systemic-functional approach to the pedagogical process;
- Thirdly, it covers the stages from the purpose of the pedagogical process to the teacher to monitor and evaluate the results and, if necessary, to make the necessary adjustments;
- Fourth, because it is based on activation factors, it allows you to get a result close to the intended purpose.

The main requirement for the pedagogical process (educational technology) is to achieve high (quality and efficiency) results without spending excessive (mental and physical) stress, time, money. In this case, the pedagogical process is directly related to the subjects involved in it, regardless of how it is organized and conducted, provides for the following:

- Improving the efficiency and quality of the pedagogical process;
- conscious decision-making and communication between the participants of the pedagogical process;
- Ensuring that students fully master the knowledge, methods of action and personal qualities;



- the formation of students' skills of conscious, active, independent, creative thinking and action;
- creating conditions for students to realize their potential;
- adherence to the ideas of democracy and humanity.

According to the above, "Pedagogical (educational) technology"(s) - in order to optimize the process of education and personal development, taking into account human and technical capabilities and their interaction is a system that combines the stages of design, implementation (implementation), making the necessary adjustments, comparing the results with the goal, which provides for the formation and development of knowledge, methods of action and positive personal qualities in students[1.60]

## **RESULT AND DISCUSSION**

Operating in a market economy requires an environment of direct social competition. This environment, in turn, serves as a basis for conscious activity such as innovation, striving for high quality and efficiency, creativity, inquisitiveness, diligence. Therefore, a conscious attitude towards independent learning in the younger generation arouses a sense of motivation. In the pedagogical process, motivation is considered as a key factor that guarantees its quality and effectiveness. It is natural that the motivation of students to study is important.

The period requires the student to become an active participant. This activity, in turn, serves as a basis for the formation of such qualities as conscious attitude, independence, creativity, inquisitiveness. The upbringing of highly qualified, well-educated young people who are innovative in their thinking, who are successful in a market economy, requires increasing educational activity in education. To do this, first of all, it is necessary to create pedagogical conditions in education. So, one of the most pressing issues today is to increase learning activity in education, to accelerate the innovative activities of teachers.

Today, it is important for educators to have the skills and abilities to innovate. Educators are required to have an innovative approach in order to be able to master the skills of innovative activity. By its very nature, the acquisition of innovative activity skills by educators is based on the decision of an innovative approach.

V.A. Slaven's innovation, as a set of purposeful, focused processes aimed at widespread dissemination and use. According to the author, any innovation aims to meet the needs and aspirations of social actors through new tools[1.97].

The concepts of "new" and "innovation" are important in any innovation. Innovation introduced into various attitudes and processes is manifested in the form of content specific, subjective, local and conditional ideas. Private innovation involves changing, updating, changing one of the elements of an attitude, object, or process. [2.120]

Subjective novelty represents the need to update the self of a particular object. Local innovation serves to describe the practical significance of the innovation being introduced for a particular object.

Conditional novelty, on the other hand, serves to shed light on a set of specific elements that enable a complex, progressive update to take place in an attitude, object, or process.

R.N.Yusufbekova focuses on the pedagogical approach to innovation. In particular, pedagogical innovations in the process of education and upbringing by the author were not previously known, it is emphasized that it is the variable content of the pedagogical event that leads to the unregistered situation or outcome.

According to Russian scientists A.I.Prigogin, B.V.Sazonov, V.S.Tolstoy, N.P.Stepanov and others recognizes that there are two approaches to the study of the innovation process and its components, and the organization of the innovation process:

1) the individual micro level of innovation (according to which some new idea is introduced into practice);

2) micro level, which represents the interaction of individually introduced innovations (in this case, the interaction, unity, competition and replacement of one by another is considered important)[6. 78].

A.I.Prigogin, B.V.Sazonov and V.S.Tolstoy in their research tried to substantiate the systemic concept of innovation. At this point, the authors distinguish the following two important stages of the innovation process:

1. Development of ideas that appear as innovations (m: planning of the development of a particular type of product by the enterprise, organization).

2. Large-scale development of innovation (specific product) [ 7. 87]

## CONCLUSION

In conclusion, we can say that innovative activity is the acquisition of theoretical knowledge, practical skills and abilities on the basis of directing the mental, intellectual, physical strength of the teacher to a specific goal, supplementing practical activities with theoretical knowledge requires the development of cognition, design, communicative speech, and organizational skills. The following are important in preparing a teacher for innovative activities:

- equipping with knowledge of professional ethics;
- To provide knowledge about the traditions of teacher-student;
- to study the problems of formation of spirituality;
- teaching the secrets of enlightenment;
- study and analysis of best practices in pedagogy of foreign countries;
- Development of long-term plans.[5.317]

Also, in essence, the innovative activity of pedagogy is the creation of scientific research, development, experimental work, creation of a new technological process or a new improved product based on the use of scientific and technical achievements.

## REFERENCES:

1. Abdullaeva, B.S., Sobirova, M.A., Abduganiev, O.T., Abdullaev, D.N. Journal of Advanced Research in Dynamical and Control Systems. 12(2), c. 2706-2714

2. Ishmuhamedov R.J., M.Mirsolieva. Innovative educational technologies in the learning process. - Т.: “Science and technology”, 2014. 60 p.
3. Makarova, N.S. Higher school didactics.monograph / N. S. Makarova, N. A. Duka, N. V. Chekaleva. – 2<sup>nd</sup>editon, Rev. and add. - М.: Yurayt Publishing House, 2019 - 172 p.
4. Muslimov N.A. and others. Innovative educational technologies. Educational-methodical manual. - Т.: “Sano-standart”, 2015. - 208 p.
5. Karimova M., Tuychieva R. THE PEDAGOGICAL BASICS OF TRAINING STUDENTS FOR PROFESSIONAL, MORAL AND EDUCATIONAL FUNCTION // Scientific Bulletin of Namangan State University. - 2019. - Т. 1. - №. 10. - P. 311-317.
6. Education in the digital age: monograph / N. Yu. Ignatova; Ministry of Education and Science of the Russian Federation; FGAOU VO UrFU, 2017.-- 128 p.
7. Savelyeva S.S. Pedagogical conditions for the formation of professional competence of a teacher in the educational process of a university: monograph. - Voskresensk, 2012.--218 p.
8. IlkhomAbdirakhimov. Development of effective demulsifiers on the basis of local raw materials // Universum: техническиенауки: научныйжурнал. – № 2(83).Часть [4] М.,Изд. «МЦНО», 2021. DOI: 10.32743/UniTech.2021.83.2-4.36-39.

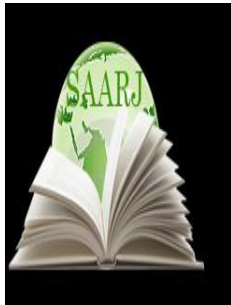

**ACADEMICIA**  
**An International  
 Multidisciplinary  
 Research Journal**  
 (Double Blind Refereed & Peer Reviewed Journal)



**DOI: 10.5958/2249-7137.2021.01173.3**

## PEDAGOGICAL BASES OF THE ORGANIZATION OF METHODOLOGICAL WORK IN PROFESSIONAL COLLEGES

**Karimova Mukaddas Otajonovna\***; **Nasirova Mavjudakhon Bakhodirovna\*\***;  
**Tuychieva Ranokhon Nodirjon kizi\*\*\***

\*Associate Professor,  
 Fergana State University,  
 UZBEKISTAN

\*\*Master's degree student,  
 Fergana State University,  
 UZBEKISTAN

\*\*\*Student,  
 Kokand state Pedagogical Institute,  
 UZBEKISTAN

### ABSTRACT

*In this article given information about the organization of methodological work in vocational colleges, the improvement of the educational process, the deepening of the content and quality of education. The scientific basis of methodological work is the training of well-rounded, qualified specialists as a result of improving the educational process in the system of secondary special, vocational education.*

**KEYWORDS:** *Methodical Work, Education, Teachers, Engineers - Pedagogues.*

### INTRODUCTION

Implementation of the tasks set in the education system today and the issue of training qualified specialists requires the introduction of the most modern forms and methods of educational work in secondary special vocational education institutions and a new approach to the educational process. The effective organization of the educational process in the newly established vocational colleges depends in many respects on methodological work.

## **MATERIALS AND METHODS**

The main purpose of the organization of methodological work is the pedagogical preparation of teachers and engineers-pedagogues for the daily educational process. Methodological work lays the foundation for the successful implementation of daily educational work. It is necessary to provide methodological assistance in teaching modern methods and forms of teaching, best practices and the application of the latest achievements of science in the teaching process, because the main problem in the training of professionals is the rapid change in the requirements for the specialist and the disparity in the fact that the teaching staff is not fully capable of implementing these requirements.

Educational and methodological work in vocational colleges requires the organization in order to improve the educational process, deepen the content and improve the quality of education.

Improving the quality of training is in many respects related to the effective organization of methodological work, scientific and methodological support of the educational process. It follows that teachers, engineers, educators and foremen working in professional colleges, managers need to study the main issues of the content of methodological work and its organization.

Methodological work is based on the achievements of science and advanced pedagogical experience, as well as the development of the creative potential of the teacher, his professional skills, and, ultimately, it is necessary to understand the set of interrelated pedagogical activities that allow to increase the level of education of students. The scientific basis of methodological work is the training of well-rounded, qualified specialists as a result of improving the educational process in the system of secondary special, vocational education,

The methodological work carried out in educational institutions plays an important role in their development into competitive, mature.

One of the issues of scientific and methodological support of the educational process is the issue of improving the content of education. Because the content of education is a curriculum, programs, government documents, and this goal can be achieved as a result of their improvement and full implementation, this issue is the main in methodological work.

## **RESULT AND DISCUSSION**

The activity of engineers-pedagogues of the educational institution is not limited to the provision of theoretical and practical knowledge, ie teaching, individual work with each student in their work, independent work on themselves, working with a group of students, carrying out organizational work on their subject, organizing and equipping classrooms, laboratories, training workshops, working with parents, participating in the work of methodological commissions on subjects, and so on.

Engineer-educators must work tirelessly at all times to work with a group of students, organize their work, and achieve the intended goal, for this it is necessary for them to increase and improve their knowledge. This is because the knowledge they receive in higher education is not enough.

It is based on methodological work, research, creation. Therefore, in organizing their independent work from pedagogical engineers, it is necessary to organize them on a scientific basis.

The structure of methodical work of professional colleges is as follows:

- Improving the ideological, political, pedagogical and professional skills of engineers and teachers of educational institutions;
- Improving the content, form and methods of education and upbringing of students in accordance with the requirements of the times;
- Ensuring and generalizing the unity of education and mutual unity in vocational training;
- study, generalization and application of advanced pedagogical, industrial and scientific-technical achievements to improve the educational process;
- study and implementation of guidelines for the implementation of scientific and methodological work.

The main purpose of such work is to improve the quality and efficiency of the pedagogical process by improving the professional and pedagogical skills of managers, teachers and pedagogical engineers.

The task of methodological work in professional colleges is as follows:

- Organization of educational and methodical work on the basis of state educational standards;
- Improving the spiritual and educational level, pedagogical skills and professionalism of the teaching staff of the educational institution;
- Improving the content, form and methods of education of future professionals on the basis of modern requirements:
- Ensuring the unity of education in the process of teaching students, the interaction between professional training;
- In-depth study, generalization and application of advanced pedagogical and industrial experience, scientific and technical achievements in the educational process;
- providing the educational process with new didactic materials and teaching aids;
- education - improving the professional skills and pedagogical skills of educators, etc.

Scientific-methodical work is an integral part of the activities of engineers and teachers, the implementation of which must be performed by all pedagogical partners of the educational institution.

The organization of pedagogical activity on a scientific basis is a measure of methodological and organizational complexes aimed at improving the working conditions of students, engineers and teachers, the organization and methods of teaching, the application of scientific and technical achievements, increasing the efficiency of the educational process.

## CONCLUSION

In conclusion, it is a fact of life that does not require proof that the performance of the tasks assigned to professional colleges depends directly on the teachers. The rapid development of science and technology, the widespread introduction of advanced production technologies in practice, requires teachers to increase the effectiveness of lessons and extracurricular activities,

rationally using the factors that activate the learning activities of students. This requires the organization of methodological work in professional colleges in an unconventional way on the basis of modern requirements.

Also, the creation of socio-political, legal, psychological and pedagogical conditions for the thorough development of educational and vocational programs, the modernization of the content of vocational education, taking into account the regional characteristics of the labor market, is a key requirement today. One of the main tasks is to connect the system of training and education of junior specialists with the requirements of the ongoing reforms in society, the process of renewal, to raise the level of educational services to this type of education, to improve the knowledge and quality of training.

#### REFERENCES:

1. Abdukudusov O.A. Vocational pedagogy. (Textbook) T .: ЎМКХТТКМО and УҚТИ, 2014.- 310 p.
2. Khodjabaev A.R., Inamov D.D. Qualimetric approach as a means of assessing the quality of training of future teachers of vocational education // Education throughout life: lifelong education in the interests of sustainable development. - 2014. - T. 12. - No. 2.
3. Volkova S.R., Khodjabaev A.R. Technology of advanced training and retraining of pedagogical personnel for the system of secondary specialized, vocational education of the Republic of Uzbekistan // Education throughout life: lifelong education in the interests of sustainable development. - 2004.-- T. 1.
4. Karimova M., Tuychieva R. THE PEDAGOGICAL BASICS OF TRAINING STUDENTS FOR PROFESSIONAL, MORAL AND EDUCATIONAL FUNCTION // Scientific Bulletin of Namangan State University. – 2019. – T. 1. – №. 10. – С. 311-317.
5. Ilkhom Abdirakhimov. Development of effective demulsifiers on the basis of local raw materials // Universum: техничекиенауки: научный журнал. – № 2(83). Часть [4] М., Изд. «МЦНО», 2021. DOI: 10.32743/UniTech.2021.83.2-4.36-39.

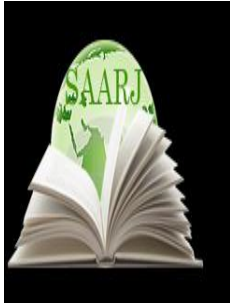

**ACADEMICIA**  
**An International**  
**Multidisciplinary**  
**Research Journal**  
 (Double Blind Refereed & Peer Reviewed Journal)

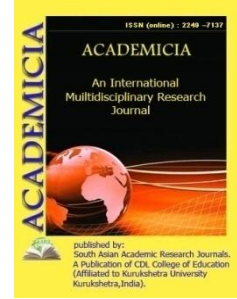

**DOI: 10.5958/2249-7137.2021.01172.1**

## THE MOTHERLAND IS HOLY AS A SACRED PLACE

**Yusufjonov Kuyoshbek Komiljonugli\***; **Mirzakarimov Davron Donyorjonugli\*\***;  
**Tuxtaboyev Sardor Qahramonjonugli\*\*\***; **Ruzaliyev Ozodbek Mashrabjonugli\*\*\*\***

\*Student of the Faculty of Military Education,  
 Fergana State University, UZBEKISTAN

\*\*Student of the Faculty of Military Education,  
 Fergana State University, UZBEKISTAN

\*\*\*Student of the Faculty of Military Education,  
 Fergana State University, UZBEKISTAN

\*\*\*\*Student of the Faculty of Military Education,  
 Fergana State University, UZBEKISTAN

### ABSTRACT

*This article discusses the concept of the Motherland, its sanctity as a sacred place and the great legacy of our ancestors, the thoughts of our first president and poets about the homeland. A child who loves his parents, their ancestors, their traditions, customs, professions, loves others. He is proud of his nation, people, literature, art, religion and culture, inspired by the nature of the country where he grew up, and understands the value of its sacred land. The king again calmly handed the golden sword to the enemy commander. But the cunning beast was not satisfied. He promised: "You will give a piece of abandoned land in your country where nothing will grow, otherwise we will bleed your country".*

**KEYWORDS:** *Motherland, People, Nostalgia, Umbilical Cord Blood, Our Ancestors.*

*"We consider the work of spirituality and enlightenment to be a work of patriotism, a work of conscience. A person with a conscience and spirituality will definitely love his homeland. Conscience means spirituality - sincere service to the people, the Motherland".*

*Shavkat Mirziyoyev*



## INTRODUCTION

The homeland is the place where a person is born, where his umbilical cord blood is shed, where he spends his childhood and youth, where he is educated, and where he always misses when he travels.

The homeland begins at the threshold, at the place where he was born and raised. That is why it is necessary for a child to grow up in the house where he lives and breathes, and to have eternal love and devotion to his motherland, which is a magnificent and powerful place for him to grow up.

Everyone's love for his homeland is instilled in him through mother's milk, mother's goddess and parental love.

A child who loves his parents, their ancestors, their traditions, customs, professions, loves others. He is proud of his nation, people, literature, art, religion and culture, inspired by the nature of the country where he grew up, and understands the value of its sacred land. After all, no one can find happiness outside the Homeland. A person who does not have a reputation in his own country is not valued in another country.

That is why in our people “Be a shepherd in your own country until you become a sultan in another country”, “It is better to be a beggar in your own country than to be a king in another country”, “When you die, die, be in your homeland!” such translations are not in vain.

## MATERIALS AND METHODS

In ancient times, people wanted to invade a country. But the king of the land was wise and peaceable. To prevent bloodshed, he presented the warlord with a racehorse, a thoroughbred horse. But the enemy did not stop threatening to start a war. The king again calmly handed the golden sword to the enemy commander. But the cunning beast was not satisfied. He promised: “You will give a piece of abandoned land in your country where nothing will grow, otherwise we will bleed your country”. The king was so determined that he commanded his army: “O brave sons of my country, go and fight! The cunning beast is looking at our sacred soil. We will not give an inch of the land inherited from our ancestors to the enemy”, he said.

Everyone who travels and lives in another country knows the value of their home, their home, their homeland.

The great thinker AlisherNavoi, Babur Mirzo, Furkat and other ancestors lived far away from their homeland, with a strong longing for the homeland, smelling the soil of the motherland and the fruits grown in it. , it is clear to everyone that they have suffered at the hands of the country.

Their spiritual experiences are the condition of a true patriot. A true patriot will not leave the Motherland, no matter where he lives, in good or bad days, he will be with him.

Our first President Islam Karimov said with great love about our Motherland:

“A person who considers his native land, where his umbilical cord blood was shed and where his ancestors lay, to be an unequal, holy Motherland in the world, has clear goals, pride and high pride”. “Of course, the world is wide, there are many countries in the world, but in this world, our unique homeland, Uzbekistan, is unique. This is a beautiful country; this holy land is only for us”.

Our great enlightened ancestor Abdullah Avloni said about the homeland:

"Everyone's hometown and country is called their homeland. Everyone loves the place where they were born and raised. Even animals have this sense of homeland. If an animal loses its homeland, it will not live as happily as it did on its own land, its life will be bitter, and the love of its homeland will always be in the corner of its heart".

Our ancestors also expressed these ideas in a poetic way. Note the following lines of the famous poet and enlightener SiddikiKhandayliki:

*What is it Motherland? Where I was born, where I live,*

*The place of rowing up, playing and laughing ...*

*My soul is my homeland, my body is my homeland, my eyes are my homeland,*

*Forget about seeing about it, where I saw it*

Depriving a person of his homeland is the greatest sin.

Everyone's home is his inviolable homeland. So, according to the custom of our people, if you suddenly have to go to someone's house, the landlord apologizes. Our ancestors considered it a sin to deprive not only man but all living beings of their homeland. AlisherNavoi got up from a meeting and hurried home.

His friends then asked him why. AlisherNavoi replied: "On the way, an ant came with me, clinging to my clothes. I wanted to take him home because he had lost his homeland. That's why I was in such a hurry".

They do not love the country only because of its unique riches, beautiful nature and favorable conditions. The climate of the motherland, regardless of its nature, is a sacred place for a person, which cannot be exchanged for anything, where his soul and spirit can rest.

There are evil forces in the world that will destroy all nations.

For example, the pre-independence Soviet government expelled the Crimean Tatars and deported them to other countries, including ours.

## **RESULT AND DISCUSSION**

As a result, they lost their homeland for almost half a century. It was only after the collapse of the Soviet empire that they returned to their homeland, the Crimean peninsula. Our people remained faithful to the traditions of our ancestors, sympathized with them in the most difficult days and gave them a place in their hearts.

During the Second World War, our people provided food, clothing, shelter, and shelter to about 1 million people of different nationalities who had been evacuated from the Nazi-occupied territories of the USSR. 200,000 of them were children. In Tashkent alone, 2,323 orphans have been adopted by our compatriots. Thanks to the kindness of our people, they have a lifelong childhood love for Uzbekistan. These people saw our country as their true homeland.

Such kindness of our people is a testimony to the great happiness of living in the homeland, the deep tragedy of statelessness.

**CONCLUSION**

In short, the homeland is the place of ancestors, the country, the people who have grown up, whose language, history, culture, customs and values are truly formed, is the ground on which to grow and mature. It is the childhood duty of each of us to take care of him. Understanding the homeland is a lifelong process for a person.

Our great Khorezm scholar NajmiddinKubro was very old when the Mongol army led by our ancestor Genghis Khan invaded.

Enemies, given his prestige, allowed him to leave the besieged city of Old Urgench. But our brave and wise ancestor will not accept this condition of the enemy.

He and his countrymen died heroically defending their homeland. It is our highest duty to love our dear Motherland, which our ancestors have cherished for thousands of years, and to cherish every inch of its soil like the apple of our eye. Not loving one's country is the greatest loss of human happiness and emotion. Ignoring the fate of the motherland is tantamount to leaving it in the hands of others.

A real child loves the Motherland with all his being, devotes all his energy and abilities to its preservation and development.

**REFERENCES:**

1. Ibragimov A. and others. Sense of homeland. Tashkent, 1997, p.152
2. IslOmKarimov. High spirituality is an invincible force. T. : “Ma’naviyat” Publishing House, 2013, p. 90.
3. The homeland and the nation are sacred. T. : “Ma’naviyat” Publishing House, 2000, p.
4. Sense of Homeland 5<sup>th</sup> grade. T. : “Ma’naviyat” Publishing House, 2015
5. PkhomAbdirakhimov. Development of effective demulsifiers on the basis of local raw materials // Universum: техническиенауки: научныйжурнал. – № 2(83).Часть [4] М.,Изд. «МИЦНО», 2021. DOI: 10.32743/UniTech.2021.83.2-4.36-39.

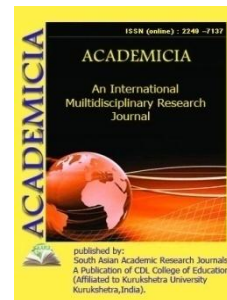
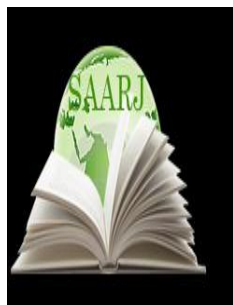

DOI: **10.5958/2249-7137.2021.01171.X**

## STRENGTHENING THE ROLE OF GERMAN IN EDUCATIONAL LANGUAGE SKILLS

**Kakhorova Zabarjad\***

\*Student,  
Karshi State University,  
UZBEKISTAN

### ABSTRACT

*In this article we can see to what extent the role of language skills is in German. The article discusses the strengthening of the German language among other languages of instruction and the use of innovative methods for teaching German at schools and universities. It also focuses on the special role of language skills in language learning, with an emphasis on the role of language skills in German and their teaching Learner lies.*

**KEYWORDS:** *Language Skills, Educational Language Skills, Language Skills, Communication Difficulties, Reading Fluency, Conference Of Ministers Of Education, Qualification Profile.*

### INTRODUCTION

Educational language skills in the German language are the essential prerequisite for all pupils to learn and to succeed in school. They are therefore of paramount importance in improving equality of opportunity and equity in education. Educational language finds expression in oral and written language use and includes the areas of competence reading, writing (including spelling), listening and speaking. These educational language skills are available individually. They are developed and strengthened through language education and language support.

Language competence describes the ability or the degree of proficiency of (foreign) language learners to apply their knowledge of a language and their skills in a language.

### RESULT AND DISCUSSION

Language is the key to communication, understanding and discourse and therefore essential for a successful degree, regardless of the subject. Competencies in several languages are a prerequisite for mastering an (international) degree and a multiple advantage for students. Without targeted promotion of language skills, neither academic communication nor international careers are

possible. The English language skills of the students and the lecturers must be at a level that guarantees academic language skills that allow a degree without provoking linguistically justified dropouts or dropouts.

As a rule, it is extremely beneficial for cooperation if lecturers are able to act in both languages in an academic context. Linguistic errors will occur, but they should not interfere with communication; in the event of communication difficulties, they can be compensated by switching to the other language. These compensatory languages can also be the source languages of the students. Concepts of language education and language promotion are not limited to teaching in the subjects German and German as a second language or target language, but also focus on specialist teaching and corresponding all-day offers. By linking technical and linguistic action, the students acquire educational and technical language skills in an authentic context.

Language-conscious teaching in all subjects, learning areas and learning fields enables or facilitates the receptive and productive handling of subject and learning content. In particular, in German lessons as the main subject for language education and support, the respective sub-skills are developed systematically and in small steps. Exercises on writing and reading fluency and the conscious use of writing and reading strategies in all subjects, learning areas and learning fields beyond primary level contribute significantly to the development and expansion of the central competence areas of reading and writing. This complex and demanding task to strengthen educational language skills can only be successfully mastered in close coordination and cooperation of all those involved in school education. Successful teaching and learning processes depend to a large extent on a common understanding of the teachers for the importance of language education, diagnostics, language promotion and multilingualism from. The awareness of school administrators and teachers of the relevance of the educational language German in teaching and learning processes in all subjects, learning areas and learning fields should be strengthened. Linguistic education and language promotion are therefore an indispensable component in all phases of teacher training. As part of the university education (1st phase), in the teacher training course at a university or college of education, the aim is to enable prospective teachers to acquire the basics of language education and language promotion. The preparatory service (2nd phase) builds on the knowledge and skills acquired during the course for language education and language promotion. By linking theory and practice, it prepares the teachers for the activities that arise on the basis of the curriculum and education plans and thus “language education as a continuous task of teaching as a standard task for all school types and levels” (intercultural education and education in schools – reports from the federal states on the implementation of the 2017 resolution). Teachers of all types of school should, if possible, be trained in the 3rd phase with regard to strengthening the educational language sub-competencies. The contents of the competences to be taught build on each other systematically and are to be coordinated accordingly between the educational institutions. The cooperation of educators with teachers in the area of “strengthening linguistic competences” during the transition from elementary to primary is of crucial importance, as language education and language promotion can be all the more successful, the earlier this begins in the children’s educational career. The conveyance of concepts of language education and language promotion is already part of the training of educators, based on the requirements of the resolution of the Conference of Ministers of Education “Competence-oriented qualification profile for the training of educators at technical schools and technical academies”.

## CONCLUSION

After all, I believe that every foreign language learned has its own set of rules and abilities. This is particularly reflected in the German language. The above services demonstrate the language skills of the German learners. It is surprising that learners can barely communicate despite good knowledge of German and cannot bring up the expected success. For this, the students practice more, hear a lot, read aloud and memorize texts is particularly important. Only then can the learner see the expected result. That would be all I want to write.

## REFERENCES

1. Recommendations for work in primary schools (resolution of the Conference of Ministers of Education and Cultural Affairs of July 2nd, 1970 in the version dated June 11, 2015) 2. Standards for teacher training: educational sciences (resolution of the Conference of Ministers of Education and Cultural Affairs of December 16, 2004 in the version of June 12, 2014).
2. Strategy “Education in the digital world” (resolution of the Conference of Ministers of Education and Cultural Affairs of December 8th, 2016 in the D.F. of December 7th, 2017).
3. Expertise “Education through Language and Writing (BiSS)” (Federal-State Initiative for Language Promotion, Language Diagnostics and Reading Promotion, 2012).
4. Educational standards of the Standing Conference. Explanations of the conception and development (on December 16, 2004, the Conference of Ministers of Education and Cultural Affairs acknowledged and approved).
5. Competence-oriented qualification profile for the training of educators at technical schools and technical academies (resolution of the Conference of Ministers of Education and Cultural Affairs of December 1, 2011 in the version dated November 24, 2017).

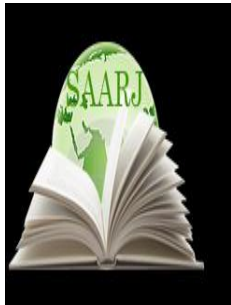

DOI: **10.5958/2249-7137.2021.01170.8**

## EDUCATION REFORMS AND ITS EFFECTIVENESS

**Z.A. Zulfikorova\***; **Yu. R. Jurayeva\*\***

<sup>1,2</sup>Department of "Foreign Languages",  
Karshi Engineering and Economics institute,  
UZBEKISTAN

### ABSTRACT

*This article reforms and nature and decrees and decrees and decrees of the industry and its effectiveness is analyzed in detail in education. The peculiarity of this is that in traditional education, students are taught only to acquire ready-made knowledge, while the use of modern technology teaches them to search for their knowledge, study and think independently, analyze, and even draw their own conclusions. Due to the specificity of the foreign language studied in the process of teaching foreign languages, the way of life, cultural creativity of the Uzbek nation and its rich historical heritage are studied in harmony.*

**KEYWORDS:** *Pedagogy, Education, Reform, Decrees, Methods, Pedagogical Technologies, Modernization, Innovation, Higher Education, Foreign Languages.*

### INTRODUCTION

Today, our country has large-scale positive changes in improving the quality and effectiveness of education.

The question of the quality and effectiveness of education is primarily priorities for the quality and effectiveness of the education system, which increases the intellectual potential of today's youth of the current Uzbek youth is one of the priorities.

Achievements in science, technologies, manufacturing and technologies have been created by all possibilities, conditions for all modern modern, innovative approaches, young people in educational institutions working at all stages of the Institute for Continuing Education.

In particular, it is no secret that a number of decisions and decrees were adopted and the growth of reforms in the education system in recent years, and special attention is paid to the preparation of reforms in the education system.

In particular, the Presentation of the President of the Republic of Uzbekistan № 3955-PP dated September 30, 2018 "On the goal of improving the management of the preschool education system" is to strengthen the technical base, ensure the quality of highly educated, highly qualified teaching staff, high-tech personnel arc, aesthetic and physical development of children, as a key goal was identified to radically increase their level of school readiness.

Also, the Law of the Republic of Uzbekistan "On Education" №-637 URL, adopted on September 23, 2020, recognizes the priority of education as a basic principle, freedom of choice of education, non-discrimination in education, equal opportunities for education, The inculcation of national and universal values in education and upbringing, the humane, democratic nature of education and upbringing, the continuity and consistency of education, openness and transparency in the field of education have been strengthened.

In order to identify priorities for systemic reform of higher education in the Republic of Uzbekistan, to raise the process of training highly qualified independent thinking to a qualitatively new level, to modernize higher education, to develop social and economic sectors based on advanced educational technologies The Concept for the Development of the Higher Education System of the Republic of Uzbekistan until 2030, approved by Decree No. 5847, is the basis for new reforms in this area.

It is clear from the above-mentioned legal and regulatory documents that the reforms in the education system are being carried out in a comprehensive, systematic manner.

The intelligence of children in the pre-school education system, which is the first link in the education system, the mastery of information technology requires further improvement of educational programs in preschool education on the basis of advanced foreign experience. According to the President's decree, the program of large-scale comprehensive measures for 2017-2021 envisages radical improvement of the quality of school readiness, introduction of modern approaches to the educational process, creation of all conditions for intellectual, moral, aesthetic and physical development of children

According to the program, it is planned to strengthen the material and technical base of 2,200 preschools, rebuild preschools in rural areas, provide the necessary inventory, equipment, teaching aids and multimedia tools.

It should be noted that in preschool institutions, children have the initial skills to learn a language through various interactive methods, while in schools, systematic work has been done to ensure that children master foreign languages. Children are interested in the introduction of a system of teaching foreign languages based on the age characteristics of students on the basis of new state educational standards and new textbooks in this area. In addition, modern textbooks have been developed for students in grades 1-4, and students and teachers are provided with textbooks one hundred percent free of charge.

In order to increase the effectiveness of foreign language teaching, schools have been provided with all the necessary equipment and inventory, and the textbook "Kids' English" is based on a single conceptual methodology and principles for primary school.

As of 2017, 4th graders who have been educated in accordance with the new state education standards in foreign languages will continue to study in 5th grade, and in connection with this process, existing English, French and German textbooks will also meet the new requirements, it



was redesigned and introduced into the education system as a logical continuation of foreign language textbooks for grades 1-4.

In order to meet the demand for foreign language teachers in 2013-2016, 6,133 graduates of higher education institutions studying in this area were employed in secondary schools. In the 2017-2018 academic year, 1,421 graduates of 18 higher education institutions training foreign language teachers were hired. According to 2017 data, over the past three years, 652 entrants were admitted to foreign languages in 47 districts of the Republic of Karakalpakstan, Kashkadarya, Navoi, Namangan, Samarkand, Syrdarya, Surkhandarya, Fergana and Tashkent regions. recorded.

Significantly, new, unique approaches to teaching a foreign language to schoolchildren have been chosen. In particular, along with language learning, the children got acquainted with the culture of the people whose language is being studied in comparison with our national values and traditions. The textbooks also include examples of Uzbek and world literature, which serve to form a culture of reading in children.

The introduction of advanced pedagogical and new information technologies in education not only increases the effectiveness of teaching, but also plays an important role in educating an independent and logical thinking, well-rounded, mature, highly spiritual person through the practical application of scientific achievements.

Today, there is a growing interest in the use of interactive methods and information technology in education, in the learning process, in the study of foreign languages, in the classroom. The peculiarity of this is that in traditional education, students are taught only to acquire ready-made knowledge, while the use of modern technology teaches them to search for their knowledge, study and think independently, analyze, and even draw their own conclusions. In this process, the teacher creates conditions for the development, formation, acquisition and upbringing of the individual, and at the same time performs the function of management, direction.

In particular, "Brainstorming", "Thought Attack", "Networks" method, "Syncway", "BBB", "Fifth plus", "6x6x6", "Debate", "Role play", FSMU, "In small groups modern interactive methods such as "work", "Step by step", "Zigzag", "Saw", "Give me a word", "Wheel" are used effectively.

In the education system, foreign language teaching focuses on teaching students to think, understand the opinions of others and express them orally and in writing, and the development of an independent-minded, well-educated literate person plays a key role. Due to the specificity of the foreign language studied in the process of teaching foreign languages, the way of life, cultural creativity of the Uzbek nation and its rich historical heritage are studied in harmony.

So, the large-scale reforms being carried out at all stages of the education system in our country, the creation of conditions to enrich the quality of education, broaden the horizons of students, master the achievements of modern science and technology, the use of educational technologies, national, universal values. creates the basis for the formation of In turn, the state provides teachers with sufficient benefits and conditions, and provides effective use of the experience of developed countries.

Advanced pedagogical and new information technologies are effectively used in the learning process, in the acquisition of foreign languages.

---

**REFERENCES**

1. Address of Sh.M.Mirziyoev to the Oliy Majlis and the people of Uzbekistan. December 29, 2020.// [www.uza.uz](http://www.uza.uz).
2. Decree of the President of the Republic of Uzbekistan No. PF-5847.// "Concept of development of the higher education system of the Republic of Uzbekistan until 2030". October 8, 2019.
3. Resolution of the President of the Republic of Uzbekistan dated September 30, 2018 No PP-3955 "On measures to improve the management of preschool education"
4. Law of the Republic of Uzbekistan "On Education". No. ZRU-637.// September 23, 2020.
5. Sayidahmedov N. New pedagogical technologies. - Tashkent: Finance, 2003.
6. <https://fargona.adliya.uz/uz/news/detail.php?ID=40169>.
7. <https://lex.uz/docs/5013007>.
8. <https://old.xs.uz/index.php>.



# ACADEMICIA

## An International Multidisciplinary Research Journal

(Double Blind Refereed & Peer Reviewed Journal)

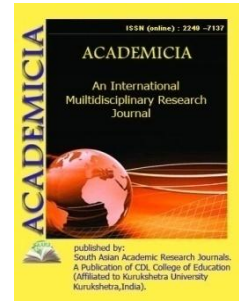

DOI: **10.5958/2249-7137.2021.01229.5**

### TOWARDS CREATING A TECHNOLOGY-ENHANCED LANGUAGE CLASSROOM: SOME PEDAGOGIC CONSIDERATION FROM THE PERSPECTIVE OF BANGLADESH

Mizanur Rahman Jewel\*; Sheikh Alauddin\*\*

\*Senior lecturer,  
Bangladesh International School and College,  
BANGLADESH  
Email id: mizanbd781@gmail.com

\*\*Assistant Professor and Head in Charge,  
BANGLADESH  
Email id: alauddinbu1957@gmail.com

#### ABSTRACT

*The present paper aims at illustrating the significance of using technology in the language learning classroom. It basically and in general focuses on some of the current practices of Bangladeshi educational institutions in line with the global way-forward. Technology-enhanced language learning is a common phenomenon now-a-days all over the world. Technology aids in the process of language learning in the classroom. The paper focuses on the application of the technology in foreign language learning scenario. At the same time, it brings into light the current scenario of technology uses in the language learning set-up of Bangladesh. It, at the same time, intends to disseminate the information on global and regional foreign language learning set-up.*

**KEYWORDS:** *Technology, Computer-Assisted Language Learning (CALL), Pedagogy, Learners, Foreign Language.*

#### INTRODUCTION

##### Preamble

The challenge Bangladesh faces is how to become a learning society and to ensure that its citizens are equipped with the knowledge, skills and qualifications on information and communication technology (ICT) they will need in the next century. ICT revolution imposes particular challenges on education systems in Bangladesh. These challenges reduce to three

broad areas. The first has to do with participation in the information society, the second considers how ICT impacts on access, cost effectiveness and quality of education, while the third is to do with the way that ICT changes the education process. However, ICT is contributing to ever-increasing inequalities in Bangladesh through the so-called “digital divide” that splits the Bangladesh between those who are “ICT-literate” and the majority who are not and most of the women have no access to a computer and the Internet. A series of factors, including literacy and education, language, time, cost, geographical location of facilities, social and cultural norms, and women's computer and information search and dissemination skills constrain women's access to information technology.

### **Importance of Technology in Contemporary World**

The goals of using technology in the foreign language classroom are the same as in any foreign language classroom: to provide students with opportunities to engage the target language through reading, writing, speaking, and listening comprehension. In fact, using technology, and computers in particular, can only help to give students opportunities to encounter the culture of the target language more authentically.

In the past, it was believed (during the audio-lingual days) that structured drills and repetition were all that were needed to make students more proficient in a language, and this is what “language labs” were mainly used for. Now, research in applied linguistics has shown that meaningful exposure to a language is the most important factor in language learning. The Internet, CD-Roms, recording software, and audio files all provide these opportunities for students to be exposed to the target language in a meaningful way.

The authentic language that students encounter when conducting web-quests or reading on-line versions of newspapers, magazines, and catalogs (store Web sites) is more engaging for students and also provides opportunities for cultural awareness and empathy.

Regardless of the type of technology that a teacher uses, it is important to keep in mind that the meaningful exposure to the target language is the most important factor. Many technology-based activities do not look like traditional classroom exercises, but this is not a bad thing. When students are engaged in an activity that forces them to make meaning of the language that they encounter, they are gaining in proficiency.

### **Why Use Technology in the Language Classroom**

There are many benefits to using technology in the language classroom:

- Multimodal practice with feedback
- Individualization in a large class
- Pair & small group work on projects
- Fun factor
- Variety in resources available & learning styles used
- Real-life skill-building in computer use

There are many different ways to integrate technology into your teaching and the students' learning. These are just a few of those:

---

- Collaborative projects
- Peer editing of compositions
- Email
- Reinforcement of classroom material
- Games and simulations
- Blogging and podcasts
- Web Quests
- Authentic language learning opportunities
- As a resource for multimedia (images, audio, video, etc.)
- As a resource for activity and lesson plans

### **Educational (ICT) Policy of Bangladesh**

Bangladesh faces the challenge of becoming a learning society, and ensuring that its citizens are equipped with knowledge of ICT, skills and qualifications they will need in this century. Application of computers in industry, business, communication, and education and in every other sphere of life demands the extensive introduction of computer education from primary to post-graduate level, and career-oriented professional ICT training provided by NGOs like the Dhaka Ahsania Mission or a training centre like Bangladesh Computer Council. Formal education in computers was first started in 1984 with the foundation of Computer Science and Engineering Department in Bangladesh University of Engineering and Technology. ICT education thereafter gradually extended to the bachelor's degree, higher secondary and secondary school levels. In Bangladesh, there are about 83,796 primary level institutions, 5,694 and 15,748 junior and secondary level institutions respectively, 2,339 higher secondary and degree colleges and more than 1,000 ICT training centers. This section describes the introduction and status of ICT education in primary and junior secondary, secondary and higher secondary, diploma, undergraduate and post-graduate levels, and career-oriented professional ICT training.

### **History: From audio-lingual to multi-media.**

The language laboratory with which most Americans are familiar was a creation of the boom in education and technology after World War II. The audio-lingual method of the 50's and 60's demanded a great deal of repetition and creation of language within established patterns such as the person-number substitution drill. During the height of this method in the 60's and 70's, schools and universities often had several large rooms dedicated to carrels in which students would sit, either by themselves or in a class, and answer questions posed to them on audiotape, or repeat utterances for the purpose of checking their own pronunciations or grammar. From an instructional point of view, it was not unusual to devote a full day of class (one-fifth to one-fourth of the entire course) to taking the class as a whole to the lab. As audiotape technology became more inexpensive and widespread, students began to listen to their tapes at home. Language labs made available high-speed copiers so that students could make a personal copy of the lesson to listen to at home. Publishers were made aware of this trend, and began to bundle individual audiotapes with the textbooks. The ease of personal access to audiotape technology had two immediate consequences. First, attendance at language labs began to drop as it became

unnecessary for students to sit in carrels to do their homework. Second, anecdotal evidence began to mount that students were simply not getting the same benefit from listening to tapes at home. Professors complained that students were not listening to the tapes properly, if at all. They would rarely repeat a tape until they got the answers right, and they were not checking their answers properly. Students, who by the 80's were accustomed to being entertained at home via television, Nintendo, and personal computers, complained that the tapes were just too boring to be believed, and they were simply unwilling to spend the time repeating drills the way their parents had. The final nail in the coffin of the audio lab was the death of the audio-lingual method itself. New research noted that it was not necessary to bore students with repetitive drills in order for them to learn language, but it was important to engage the students in the language as often as possible.

As early as the 60's and 70's, foreign language methodologists began to experiment with computer-assisted language instruction. The early efforts, dependent entirely upon the access one had to the computer (usually a line-by-line terminal attached to a mainframe), were little more than electronic workbooks. The student would be asked a question, type in an answer, and be given immediate feedback whether the answer was wrong or right. Some programmers favored the game model, in which one played simple games like "Hangman" in the second language. Some students, those particularly interested in language or computers, were inspired to learn in this way, but for most, the experience turned out to be as unpleasant as the audio lab: one had to go to a public place, sit in a carrel, and do repetitious work. Only this time the students had to contend with unfamiliar technology, user interfaces that varied greatly from machine to machine (especially in the approach to foreign characters), and, as with their experience listening to tapes at home, little to no supervision. At the same time that MTV was revolutionizing the visual vocabulary of a generation, computer screens full of text or excruciatingly amateurish graphics.

It wasn't until the 90's that the possibilities of computer-assisted language learning (CALL, for short) really opened up. On the hardware side, personal computers finally got fast and big enough to run sophisticated programs, and networking began to make technology available for collective endeavors such as education. With larger machines came multimedia capabilities: CD-Rom, Midi ports, and the like. On the software side, the success of the Windows operating system meant that PC users could finally learn the benefits of a standard user interface that Macintosh users had known for years: learn one interface, run any program using the same key-stroke commands. Of course, the software also kept up with the growing capabilities of the hardware, and it became extremely easy to run complicated software on CD or link to the Internet with a double click. The market soon discovered the interest in foreign language instruction, especially for business, and responded with several language "methods" for the most profitable language. (It should be noted that these CDs offer little more than conversational language methods. They can teach phrases and vocabulary and some grammar, but they are hardly the same as a full language course.) Even more important than the commercial offerings was the explosion in the World Wide Web across the world. In an hour in front of a computer, a student can now visit a variety of sites in the countries in which their target languages are spoken and see "authentic language," that is, language written by native speakers for native speakers. At the same time, they learn about the culture both directly and indirectly, through pictures, audio, videoclips, discussion groups, e-mail resources, and the like. Language teachers always knew that to learn a language one had to "go there." Now, it appeared that "there" was able to come

her. Since the web was available from both Macintosh and Windows platforms, even the perennial problem of hardware differences appears to have been overcome.

Programs that had hesitated to jump on the technology bandwagon when all it offered were simple programs (like the modern language program at Trinity) realized that the time had come to take advantage of the hardware and software at hand. Since the audio-lingual lab was essentially dead anyway, and since the entire campus, including the residence halls, was wired for the campus network during the summer of 1996, we could only improve current instruction by seeing what could be done to create what we optimistically called the "virtual language laboratory."

### **Basic Assumptions**

If students won't come to the lab, then the lab can go to the students. The faculty at Trinity has by no means given up on the value of a language lab. Research has shown that language proficiency is a direct function of time spent dealing with the language. The "virtual language lab" was not meant to replace any of the tools of the past. Students would still be expected to use textbooks, audiotapes, and workbooks for drill and practice. The technology is intended to enhance the traditional classroom language acquisition experience. Because this is a kind of lab, it is expected that students will use it on their own time, that they will learn language because they are dealing with it, either by reading web pages in the target language, or by participating in student-oriented discussion groups or e-mail exchanges, or by listening to RealAudio or shortwave broadcasts, or by doing activities similar to those found in their workbooks, but adapted to take advantage of the multimedia technology.

This rationale has a number of assumptions behind it. First, on the side of language learning and instruction, it is assumed:

1. that students do not necessarily need only structured drills in order to learn, that language acquisition takes place any time the student is dealing with the target language (one might make the pedagogical leap and assume that the more students are engaged with a target literature or culture the more they will learn about those as well);
2. that information that students discover on their own has greater impact than information they are told or that they gain through memorization;
3. that "authentic language" is more engaging and useful (although occasionally problematic) than created pedagogical language, and that, as a result, students will be interested in accessing authentic language web pages in their target language, perhaps enough so to click on a few links of their own and go exploring, thus spending more time with the language and culture;
4. that websites and other software appropriate to a language lesson can occasionally be brought into class, thus giving the students a common "lab" experience;
5. that culture, which has been recognized as essential to full comprehension of another language, is easier to comprehend from real-life web pages than from the distilled cultural overviews usually written into textbooks;

6. that language, literature, and culture are intertwined so that one cannot really know one without knowing something of the others and that one always learns something about the others by studying one of them; and
7. that professors are willing to adapt their materials to include Internet materials and accommodate the unexpected, such as when a student brings a previously unknown site to the attention of the class;

### **Online Activities**

The following is a list of the most popular kinds of activities multimedia technology offers to students:

- e-mail, discussion, chat, and lists
- web page creation
- games, including web hunts
- current events: news, sports, leisure activities
- information retrieval; research
- authentic language through personal web pages
- images and maps available to supplement readings
- analyze texts electronically
- online audio and video

### **Using technology for different areas of language study**

While technology has had a major influence on the teaching and learning of languages, a lot of disagreement surrounds areas such as the teaching of grammar, vocabulary, language skills and testing.

#### **Grammar**

The increase in the number of interactive exercises on CD-ROM and the web has undoubtedly benefitted the analytical learner. Students can practise 24/7 and receive instant feedback. However, many teachers and material writers would argue that this kind of practice is based on an outdated, stimulus-response methodology. These grammar exercises 'skewer' the language, so on-line practice focuses on 'crisp' areas of language at the expense of 'fuzzy' areas. Here's a good example of this distinction:

Crisp: Is 'I went there': (a) Simple past? (b) Present perfect?

Fuzzy: What's the difference between (a) 'I did it' and (b) 'I've done it'?

#### **Vocabulary**

Arguments are currently raging about the use of electronic translators. These provide many benefits, allowing students to cross-check between bi-lingual dictionaries and mono-lingual dictionaries, and encouraging them to review language. Yet, when used for production, they seem to encourage the selection of the wrong word in English, and teachers can quite easily spot



an essay written with the help of one of these small machines. They also inhibit fluency if students take them out in discussion classes – which they frequently do.

### Skills

In the area of the receptive skills, listening and reading, the effect of technology has been huge. The Internet has provided a vast range of material, offering many more opportunities for exposure to authentic materials, both audio and text. At the same time, much of this material is clearly unsuitable for language learners. The debate continues as to how useful YouTube is and to what extent is technology ‘responsible’ for the rise in plagiarism in EAP (English for academic purposes).

The influence of technology on the productive skills of speaking and writing is, arguably, less. If you wish to improve fluency, many students would argue that nothing is better than a face-to-face language lesson, a discussion class with the teacher. Can the same be said about taking a fluency class using Skype, a web-based program such as Illuminate or a class in the virtual world, Second Life? What value does ‘Voice recognition’ have? Wikis enable students to compose an essay together at a distance, making them a suitable medium for collaborative writing. However, not all learners wish to learn from each other, and prefer only the teacher to correct their work, rather than a peer.

### Testing

There has been an explosion of on-line testing in the last few years. Such test materials use the same formats as multimedia materials: gap-fill, multiple choice etc. Is this a match made in heaven? Some would argue that on-line tests actually favour students who use computers, and ignore the assessment of ‘affective factors’ such as personality and learner type.

### Theory vs Practice

This is a world which is driven by technology. The innovators innovate, and later, pedagogy plays catch-up, as teachers try things out. The world of theory (of evidence and research) is, arguably, lagging behind what is happening in the classrooms. In other words, if you wait for a case study to justify whether or not Twitter has value, you may be waiting a long time, and the technology will have moved on by the time the research has been done.

### Technology readiness for the educational institutions of Bangladesh

Bangladesh has a relatively long experience in the use of computers - the first "second generation" computer was installed in 1964 at Dhaka and very soon some of the large banks and industrial concerns started using computers, mainly for accounting and payroll applications. The utility companies (e.g. gas, electricity) also started using the bureau facilities of these installations for their customer billing. Unfortunately, the financial crisis that the country faced immediately after its independence in 1971 did not permit the sustenance of this early lead and lack of maintenance forced the closure of most of these installations.

Although the possibility of export of data entry services and software from Bangladesh has been discussed for over a decade, only a few companies were successful in getting some work from outside. In June 1997, the Government of Bangladesh appointed a Committee (with the author of this article as its Convenor) to look into the problems and prospects of export of software from Bangladesh. The Committee submitted its report in September, 1997. It contained 45 recommendations, both short term and medium term; some of these recommendations have

already been implemented and the government has asked different concerned ministries to go ahead with implementing the other recommendations.

Although not properly exploited yet, Bangladesh does have quite a few inherent strengths which can be used as the launching pad for making this country a potential offshore source of Software and Data Processing Services. Some of these advantages are :

A substantial number of educated unemployed youth force, with ability to read and write English, exists in the country. They can be trained in the required skill (particularly in Data Processing Services) within a short time. Quite a few Bangladeshi skilled professionals have been working abroad. They can be encouraged to return to the country and/or collaborate with Bangladeshi entrepreneurs, provided proper environment is created. Universities in Bangladesh are turning out an increasing number of graduates in Computer related subjects every year, although the number is much less than the requirement. A large number of Bangladeshi students are studying overseas in Computer related subjects. A wide range of Hardware platforms, from Mainframe to

The government has taken a decision recently (June, 1998) to withdraw all import duties and VAT from all computer hardware and software. This has brought the prices of computers down to a level affordable by middle income households and sales of PCs have soared during the last few months. A 80-90% annual growth in the number of PCs sold is expected this year.

An Information Technology village is going to be set up very close to Dhaka. The government has already made 18 acres of land available for setting up this IT village. This would be similar to the Software Technology Parks in India. All the infrastructure, including high-speed telecommunication facilities (2 Mbps link) would be provided. These would enable the small companies to move into buildings with readily available facilities. Since this is going to take at least two years, a decision has been taken to initially set it up in an existing building in Dhaka.

In June, 1996 the government decided to allow private companies to act as Internet Services Providers (ISPs) using VSATs. At present, there are about 22,000 account holders with the ISPs (8 in Dhaka and 2 in Chittagong) and the total number of users would be around 100,000. The slow speed of access provided by VSATs ( max. 128.8 kbps) is a major constraint. A number of Cybercafes providing e-mail and Internet browsing facilities have been opened in Dhaka city; these are quite popular among the young generation. Public kiosks with internet facilities are also being planned.

BTTB has already established a network for providing Internet connectivity and plans to start commercial service very soon. The proposed tariff rate should make Internet connection affordable to a larger cross-section of public. BTTB is also establishing a fibre optic backbone in the country. They also plan to offer ISDN service very soon using the facilities of the already installed digital exchanges in Dhaka and Chittagong cities.

In order to enable the young entrepreneurs in the IT field, a special fund has been created by the government to provide working capital loan without any collaterals. A venture capital fund is also being set up. The banking procedures are also being amended and simplified to reflect the different nature of software transactions.

Experience of other countries shows that it is very difficult to achieve success in exporting software unless there is a big domestic market. The government ministries and departments are

being asked to computerise their activities. A domestic price preference of 15% would be given to suppliers of locally developed software.

Some of the local firms have already succeeded in exporting software, although the total amount is not very large. One firm has been producing CDs with searchable database for US and Latin American clients. CAD conversion work and web-page design work are also being undertaken. Taking advantage of the considerable number of COBOL programmers who were trained in the sixties and seventies, a number of firms are doing work related to the Y2K problem. ERP software is being developed by a local firm in partnership with Microsoft.

The government has placed top most priority to human resource development in the IT field. At present, the annual output of graduates in the IT field would be around 500. The target is to produce 10,000 programmers annually by the year 2001. There are about 24 Universities offering undergraduate degree programmes in IT-related fields. All the four BITs (at Rajshahi, Chittagong, Khulna and Gazipur) are also planning to offer undergraduate degree programmes in computer science and engineering from next year. The 20 Polytechnics are also introducing 3-year diploma programmes in Computer Technology. In addition, a large number of educational and training institutes, many of them with linkage with foreign institutions, are also offering training courses. One of the major problems faced by these institutions is the shortage of trainers. Recognizing this problem, the GOB Committee (referred to earlier) recommended that BCC should take up a crash programme to train at least 1000 high-level trainers by the end of 1999. Moreover, the absence of adequate physical resources (e.g. computer hardware and software) and weakness in course contents in the training institutions will adversely affect the quality of output from these institutions. An accreditation system is planned to be introduced by the government soon.

BUET was the first institution to offer post-graduate degrees (M.Sc. and Ph.D.) in Computer Science and Engineering. Some other institutions have also initiated research programmes in IT related fields. These include Machine Learning, Pattern Recognition, Speech Recognition, Automatic Translation, Computational Algorithm, VLSI and 3-D Vision. Considerable research work has been done in the use of Bangla in computers. Unfortunately like R&D in other fields of science and technology, there is very little interaction between academia and industry.

Efforts were initiated about 13 years back to introduce computers in schools and colleges. 'Computer Studies' has been introduced as an optional subject both in SSC and HSC examinations. The lack of adequate physical facilities, computers and qualified teachers has resulted in very few students opting for these courses. Experience of other countries shows that teaching of computer programming by incompetent teachers may do more harm than good. Therefore, teacher training is one of the priority actions to be taken.

In order to co-ordinate the computerisation activities of government and semi-government agencies a National Computer Committee was set up in 1983. This was transformed into the National Computer Board in 1988 and the Bangladesh Computer Council was set up in 1989 by an Act of Parliament. It had some initial problems and faced a lot of criticism from the IT community when it became more of a regulatory body, rather than a promotional body as originally envisaged. It is planned to strengthen BCC by inducting more IT professionals, so that it can play a bigger role in IT development in the public sector, particularly in human resource development.

A large number of Bangladeshis are now working in the IT field in different companies in USA and are gradually moving up the organizational hierarchy. The government is trying to get the assistance of these non-resident Bangladeshis (NRBs) in IT development, particularly by giving them incentives to set up software companies in Bangladesh.

Although the banking sector had been among the pioneers in computerization in Bangladesh, the present level of computer usage in banks is very low. The foreign banks operating in Bangladesh have taken a lead in computerizing their front office operations. It is only during the last 4/5 years that some of the Bangladeshi banks have started gradually computerising their front office activities and very soon a network of automatic teller machines (ATMs) using VSATs would be set up by the private banks throughout the major towns.

At present, Internet access is available only in a few Universities. The University Grants Commission is setting up BERNET (Bangladesh Educational and Research Network) establishing linkage among the Universities and providing access to the Internet.

The present government has recognized IT as one of the priority sectors and is providing all support to the private sector to enable them to enter the export market for software and data processing services. Recognizing the bright future of IT, a large number of students, young professionals and businessmen are taking keen interest in acquiring knowledge about computers and its applications. This is reflected in the tremendous enthusiasm generated in the on-going International Computer Show organized by Bangladesh Computer Samity. It is expected that within the next 3 to 4 years, IT applications in Bangladesh would not only spread to various private and public sector offices and industrial units, but Bangladesh would emerge as a regional hub for software development.

### **Using Video in the F/SL Classroom**

What are the practical implications of using video in the classroom? At the most basic level of instruction, video is a form of communication and it can be achieved without the help of language, since we often interact by gesture, eye contact and facial expression to convey a message. Video provides visual stimuli such as the environment and this can lead to and generate prediction, speculation and a chance to activate background schemata when viewing a visual scene reenacted. It can be argued that language found in videos could help nonnative speakers understand stress patterns. Videos allow the learner to see body rhythm and speech rhythm in second language discourse through the use of authentic language and speed of speech in various situations. Videos allow contextual clues to be offered. In addition, video can stimulate and motivate student interest. The use of visuals overall can help learners to predict information, infer ideas and analyze the world that is brought into the classroom via the use of video instruction. In a teaching or testing situation video can help enhance clarity and give meaning to an auditory text; it can create a solid link between the materials being learned and the practical application of it in a testing situation; the video can act as a stimulus or catalyst to help integrate materials or aspects of the language; videos can help manipulate language and at the same time be open to a variety of interpretations.

Arthur (1999) claims that:

"Video can give students realistic models to imitate for role-play; can increase awareness of other cultures by teaching appropriateness and suitability; can strengthen audio/visual linguistic

perceptions simultaneously; can widen the classroom repertoire and range of activities; can help utilize the latest technology to facilitate language learning; can teach direct observation of the paralinguistic features found in association with the target language; can be used to help when training students in ESP related scenarios and language; can offer a visual reinforcement of the target language and can lower anxiety when practicing the skill of listening."

Video used in a classroom should be interpretive and to the point. The visual should show reasonable judgment and enhance comprehension, heighten sensory acuteness, and illustrate the target language being used. Practitioners should avoid the use of distracters, over-crowded or violent stimuli. Visuals are ineffective in the learning process when the visual is too small; when the visual or video uses stereotypes; when the visual or video is a poor reproduction; when the picture is too far away from the text illustration; when the video has irrelevant captioning; when the video or visual offers too much information related or unrelated to the picture; when the video or visual is poorly scaled; and when the picture is not esthetically meaningful. A visual cue may be accompanied by a written cue to focus on a lexical item being furnished. Videos can make the task, situation or language more authentic. More importantly, video can be used to help distinguish items on a listening comprehension test, aid in the role of recall, help to sequence events, as well as be adapted, edited or changed in order to meet the needs of the language learner (Canning, 1998).

### **Key Consideration for Using Video in the Classroom with Nonnative Speakers**

Although video may be a popular tool to use with students, as F/SL educators we must not lose sight of the educational purpose it has in the language classroom. It is suggested that language teachers should ask themselves the following questions before implementing a video lesson with F/SL learners:

- How will the language learner benefit from the use of video in the classroom?
- How will the visual component enhance the auditory component?
- Who will select the video? Is it the class, the teacher or the curriculum developers?
- Who decides which language should be exploited from the video? Is it the class, teacher or curriculum developers?
- How do you plan to exploit the 1-10 minute segment of the video? What are the alternative methods of exploiting the clip for further reinforcement in the classroom?
- Whose responsibility is it to select key vocabulary and structures from the video?
- Who decides how many times the video is played?
- How can students and teachers develop academic listening and conversational listening activities based on the video?
- How is the video used in a classroom context?
- How does video support the curriculum?
- Can the comprehension of the video be measured without visual support?
- Can the comprehension of the video be measured without auditory support?

- How will you assess the comprehension of the video by the language learners?
- How practical is the video to improve a learner's academic listening and/or conversational listening skills?
- What is the educational purpose for showing the video? How will you later assess its effectiveness with the learners ability to comprehend information?

### **Using Computer in language classroom**

For some tasks, computers can provide distinct advantages over more traditional approaches. The use of a computer for listening exercises often provides not only sound, but also visual input providing students with more contextual clues. Students interacting with a computer are also using motor skills as well, which can have a strong reinforcing effect on the learning process by connecting physical actions (clicking, typing) with desired results. Students are also allowed more control over their own learning process as they make the decisions when to repeat questions, exercises and sequences based on their own progress.

Probably the strongest argument for the use of the computer in the classroom environment is that of student self-pacing. Especially in the field of pronunciation, students can employ a computer to record themselves to compare their pronunciation to a target pronunciation. This can be repeated endlessly until a student is satisfied with his/her result. These pronunciation exercises are often combined with visual aids (such as intonation graphs) to help the student recognise how his/her pronunciation compares to the target pronunciation. Common tools such as spell checking can also provide the student with valuable self-analysis instruction.

Finally, with the aid of the Internet and CD-Rom based materials, teachers can quickly access documents addressing individual student needs. This is especially effective when teaching English for Specific Purposes such as Business English. An example would be white papers put up on a company web-site discussing certain technologies in English that students are currently employing. Another example is glossaries provided for specific business sectors (port, banking, insurance, etc.). Using these materials, the teacher can often provide content addressing specific student needs, thereby improving motivation and effectiveness.

### **Making the student comfortable with the technology**

Admittedly, the computer can be an overwhelming and imposing instrument to students and teachers. The complexity of the computer - not to mention the overwhelming choice of possibilities - can put students and teachers off as they lose time grappling with how to use the computer. There are a few basic principles that should be followed in order to help the student (and teacher) feel more at home using the computer.

- The computer should always be turned on, booted, and the program loaded (preferably the exercise chosen) before the class begins. In this manner, students focus on doing the task at hand rather than getting to the point where they can do the task.
- Students who are not comfortable using computers should be placed with students who are. These students should not be forced to use the mouse or type at the keyboard. As they become more familiar with the technology, they will often begin to play a more active role - even if they don't, the ability to use the computer is not the issue.

- Students more comfortable with the computer should be strongly discouraged from using other resources available in the program itself, or in other programs. These students should be encouraged to explore these resources on their own by taking advantage of self-access programs.
- Use of the computer should be phased in; instead of introducing a complex series of exercises to be done for a lesson, teachers should begin by doing a limited amount of work with the computer (i.e. one listening exercise followed by an interactive quiz).

### **Computer-assisted language learning (CALL)**

Computer-assisted language learning (CALL) is a form of computer-based learning which carries two important features: individualized learning and bidirectional learning. It is not a method. CALL materials are materials for learning. The focus of CALL is learning, and not teaching. CALL materials are used in teaching to facilitate the language learning process. It is a form of student-centered learning materials, which promote self-paced accelerated learning. CALL is not a software application, but rather courseware that is designed specifically for language learning for a specific group of learners.

CALL originates from CAI and was invented in 1960s. Computer-Assisted Instruction was first viewed as an aid for teachers. The philosophy of CALL puts a strong emphasis on student-centered lessons that allow the learners to learn on their own using structured and/or unstructured interactive lessons. These lessons carry 2 important features: bidirectional (interactive) learning and individualized learning. It is a tool that helps teachers to facilitate language learning process. CALL can be used to reinforce what has been learned in the classrooms. It can also be used as remedial to help learners with limited language proficiency.

The design of CALL lessons generally takes into consideration principles of language pedagogy, which may be derived from learning theories (behaviorist, cognitive, and constructivist) and second language learning such as Krashen's Monitor Theory.

Others may see CALL as an approach to teaching and learning foreign languages whereby the computer and computer-based resources such as the Internet are used to present, reinforce and assess material to be learned. CALL can be made independent of the Internet. It can stand alone for example in a CDROM format. Depending on its design and objectives, it may include a substantial interactive element especially when CALL is integrated in web-based format. It is in the area of industrialization of teaching that is reigning now. The traditional face-to-face teaching which is based on interpersonal communication between the teacher and student is gone. However, the industrialized teaching is able to offer teachers with the opportunity of sourcing from the computer internet rather than being faced with the problem of materials. It may include the search for and the investigation of applications in language teaching and learning. Except for self-study software, CALL is meant to supplement face-to-face language instruction, not replace it.

Computers have been used for language teaching ever since the 1960s. This 40-year period can be divided into three main stages: behaviorist CALL, communicative CALL, and integrative CALL. Each stage corresponds to a certain level of technology and certain pedagogical theories. The reasons for using Computer-assisted Language Learning include: (a) experiential learning, (b) motivation, (c) enhance student achievement, (d) authentic materials for study, (e) greater

interaction, (f) individualization, (g) independence from a single source of information, and (h) global understanding. The barriers inhibiting the practice of Computer-assisted Language Learning can be classified in the following common categories: (a) financial barriers, (b) availability of computer hardware and software, (c) technical and theoretical knowledge, and (d) acceptance of the technology.

In multimedia programs, listening is combined with seeing, just like in the real world. Students also control the pace and the path of the interaction. Interaction is in the foreground but many CALL programs also provide links to explanations simultaneously. An example of this is Dustin's simulation of a foreign student's arrival in the USA. Programs like this led also to what is called explorative CALL.

More recent research in CALL has favored a learner-centered explorative approach, where students are encouraged to try different possible solutions to a problem, for example the use of concordance programs. This approach is also described as data-driven learning (DDL), a term coined by Tim Johns.

### **Theoretical basis for CALL instruction design**

Computers have become so widespread in schools and homes and their uses have expanded so dramatically that the majority of language teachers now think about the implications. Technology can bring about changes in the teaching methodologies of foreign language beyond simply automating fill-in-the-gap exercises. The use of the computer in and of itself does not constitute a teaching method, but rather the computer forces pedagogy to develop in new ways that exploit the computer's benefits and that work around its limitations. To exploit the computers' potential, we need language teaching specialists who can promote a complementary relationship between computer technology and appropriate pedagogic programs.

A number of pedagogical approaches have developed in the computer age, including the communicative and integrative/experimentative approaches outlined above in the History of CALL. Others include constructivism, whole language theory and sociocultural theory although they are not exclusively theories of language learning. With constructivism, students are active participants in a task in which they "construct" new knowledge based on experience in order to incorporate new ideas into their already-established schema of knowledge. Whole language theory postulates that language learning (either native or second language) moves from the whole to the part; rather than building sub-skills like grammar to lead toward higher abilities like reading comprehension, whole language insists the opposite is the way we really learn to use language. Students learn grammar and other sub-skills by making intelligent guesses bases on the input they have experienced. It also promotes that the four skills (reading, writing, listening and speaking) are interrelated. Sociocultural theory states that learning is a process of becoming part of a desired community and learning that community's rules of behavior.

What most of these approaches have in common is taking the central focus away from the teacher as a conveyor of knowledge to giving students learning experiences that are as realistic as possible, and where they play a central role. Also, these approaches tend to emphasize fluency over accuracy to allow students to take risks in using more student-centered activities, and to cooperate, rather than compete. The computer provides opportunity for students to be less dependent on a teacher and have more freedom to experiment on their own with natural language in natural or semi-natural settings.

---



### **Use of CALL for the four skills**

A number of studies have been done concerning how the use of CALL affects the development of language learners' four skills (listening, speaking, reading and writing). Most report significant gains in reading and listening and most CALL programs are geared toward these receptive skills because of the current state of computer technology. However, most reading and listening software is based on drills. Gains in writing skills have not been as impressive as computers cannot assess this well.

However, using current CALL technology, even with its current limitations, for the development of speaking abilities has gained much attention. There has been some success in using CALL, in particular computer-mediated communication, to help speaking skills closely linked to "communicative competence" (ability to engage in meaningful conversation in the target language) and provide controlled interactive speaking practice outside the classroom. Using chat has been shown to help students routinize certain often-used expressions to promote the development of automatic structure that help develop speaking skills. This is true even if the chat is purely textual. The use of videoconferencing give not only immediacy when communicating with a real person but also visual cues, such as facial expressions, making such communication more authentic.

However, when it comes to using the computer not as a medium of communication (with other people) but as something to interact with verbally in a direct manner, the current computer technology's limitations are at their clearest. Right now, there are two fairly successful applications of automatic speech recognition (ASR) (or speech processing technology) where the computer "understands" the spoken words of the learner. The first is pronunciation training. Learners read sentences on the screen and the computer gives feedback as to the accuracy of the utterance, usually in the form of visual sound waves. The second is software where the learner speaks commands for the computer to do. However, speakers in these programs are limited to predetermined texts so that the computer will "understand" them.

Self access language learning centers or independent learning centres have emerged partially independently, and partially in response to these issues. In self-access learning, the focus is on developing learner autonomy through varying degrees of self-directed learning, as opposed to (or as a complement to) classroom learning. In most centres, learners access materials and manage their learning independently, but have access to staff for help. Many self-access centres are heavy users of technology and an increasing number of them are now offering online self-access learning opportunities. Some centres have developed novel ways of supporting language learning outside the context of the language classroom (also called 'language support') by developing software to monitor students' self-directed learning and by offering online support from teachers.

Center managers and support staff need to have new roles defined for them to support students' efforts at self-directed learning. In fact, a new job description has emerged recently, that of a "language advisor".

### **CONCLUSION:**

Foreign language learning especially English language is a dominant aspect for the present world. The tradition of technology based language learning is growing and spreading around the globe with the global changing scenario. Bangladesh is also trying to cope up with global

prospective. If, some improvements, on certain aspect can be made the country would be able to flourish the shifting trend in a more better and comprehensive manner.

#### REFERENCES:

1. J. Harmer: *The Practice of English Language Teaching*, 7th ed. London: Pearson Longman. (2007)
2. A. Scharle, A Szabo: *Learner Autonomy*. Ed. Penny Ur. London: Cambridge University Press. (2000)
3. J. Carlson, G. Nelson: "Chinese students' perceptions of EFL peer response group interaction" *Journal of Second Language Writing*, 5/1, pp 1- 19. (1996)
4. C.O. Macdonca, K.E. Johnson: "Peer review negotiations: revision activities in ESL writing instruction" *TESOL Quarterly*, 28/4, pp 745- 769. (1994)
5. S. Sengupta: "Peer Evaluation: 'I am not the teacher'" *ELT Journal*, 52/1, pp- 19- 28. (1998)
6. T. Roskams: "Chinese Efl Students' Attitudes to Peer Feedback and Peer Assessment in an Extended Pairwork Setting" *RELC Journal*, 30, pp 79- 123. (1999)
7. Angers, J., & Machtmes, K. (2005). An ethnographic-case study of beliefs, context factors, and practices of teachers integrating technology. *The Qualitative Report*, 10 (4), 771-794.
8. Becker, H.J. (1993). How exemplary computer-using teachers differ from other teachers: Implications for realizing the potential of computers in schools. *The Journal of Research on Computing in Education*, 26, 291-321.
9. Davis, F.D., Bagozzi, R.P., & Warshaw, P.R. (1992). Extrinsic and intrinsic motivation to use computers in the workplace. *Journal of Applied Social Psychology*, 22, 1111-1132.
10. Delcourt, M.A., & Kinzie, M.B. (2002). Computer technologies in teacher education: The measurement of attitudes and self-efficacy. *Journal of Research and Development in Education*, 27 (1), 35-41.
11. Stefl-Mabry, J. (1999). Professional staff development: lessons learned from current usability studies. *Journal of Information Technology Impact*, 1(2), 81-104.
12. Woodrow, J.E. (1992). The influence of programming training on the computer literacy and attitudes of preservice teachers. *Journal of Research on Computing in Education*, 25(2), 200-218.
13. Yildirim, S. (2000). Effects of an educational computing course on preservice and inservice teachers: A discussion and analysis of attitudes and use. *Journal of Research on Computing in Education*, 32(4), 479-495.
14. Zhao, Y., Pugh, K., Sheldon, S., & Byers, J. (2002). Conditions for classroom technology innovations. *Teachers College Record*, 104(3), 482-515. Cambridge University Press. N.Y.
15. Brumfit, C. and R. Carter. (1986). (Eds.) *Literature and Language Teaching*. Oxford: Oxford University Press.
16. Chowdhury, S. I. (2001). "Rethinking the Two Englishes" In *Rewriting English in Bangladesh*. (Eds.) Fakrul Alam, Niaz Zaman and Tahmina Ahmed:15-25.

17. Kachru, B. B. (1986). "Non-native Literature in English as a Resource for English Teaching". In *Literature and Language Teaching*. (Ed.) C. Brumfit, and R. Carter. Oxford: Oxford University Press. 135-147.
18. Langer, J. (1997). Literacy Acquisition through Literature. *Journal of Adolescent and Adult Study*, 40, 602-614

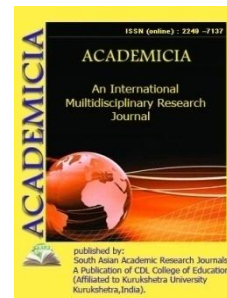
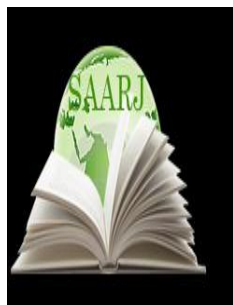

DOI: **10.5958/2249-7137.2021.01232.5**

## THE IMPORTANCE OF USING LEGUMES TODAY

**Mamadali Nazarov\***; **Madina Gaybullaeva\*\***

\*Associate Professor,  
Candidate of Agricultural Sciences,  
UZBEKISTAN

\*\*Teacher,  
Fergana State University,  
Fergana, UZBEKISTAN

---

### ABSTRACT

*It is known that in the conditions of the irrigated soils of our country, the cultivation of secondary crops allows the cultivation of additional crops from each hectare of land. When legumes are used as a secondary crop, not only the grains of these crops, but also their soybeans and other waste products are used as feed rich in whey protein for livestock, which is more "healthy" for livestock than wheat straw. This article discusses the relevance of using legumes and provides scientific advice in this regard. At the same time, the introduction of innovative technologies in the use of leguminous crops is being studied.*

**KEYWORDS:** *Legumes, Soil, Crops, Irrigation Technology, Mineral Fertilizers, Protein, Nitrogen.*

---

### INTRODUCTION

A number of decisions, orders adopted on more efficient use of land and water in agriculture in Uzbekistan since 2016, the introduction of best practices into the new farming system, the revision of foreign agricultural technologies, irrigation and fertilization in each region, the introduction of significant innovations in the placement of agricultural crops has served to increase the volume export and quality improvement.

The growing increase in humanity has made human needs the main criterion - the provision of food in the country and the task of increasing productivity from year to year. In recent years, the sown area under cotton and winter wheat has reached 2.2 million hectares, and the sowing of legumes such as moss, beans, soybeans, peas, on land freed from winter crops, prevented the

deterioration of the soil cover, for the development of animal husbandry, mixed sowing of peas, vinyas, vetch, beans with corn, sowing corn for grain, the extraction of oil and protein from soybeans also improve the quality of feed.

### **Main part**

Planting plants in the spring to meet the world's protein demand, such as soybeans, peas and moss, will also help meet the protein demand. Currently, according to FAO, a person's protein requirement should be 90-100 g per day.

Protein deficiency in humans leads to physiological functional retardation of growth and development, rapid fatigue, especially mental fatigue.

Protein demand from legumes, alfalfa, alfalfa, legumes, green manures and catch crops is radically improved by meeting the demand for animal protein, which is important for improving human health. Protein from legumes is easier and better absorbed (before March 3), and animals also rank higher than other grains. Vegetable protein is the cheapest and most digestible. This means that legumes store several times more nitrogen than other plants, which makes the soil more fertile. Nitrogen, on the other hand, enriches the soil with substances that are constantly needed in the biotic world, as well as phosphorus, potassium, molybdenum, manganese, zinc.

To obtain a high and high-quality yield from leguminous crops, i.e. the use of the maximum amount of nitrogen in the air; a) depending on the pH of the soil or soil solution, lupine is good at pH -5.0, excellent at pH 6.0, good at pH -7.5, soybeans and beans - 6.5-7; 2 - conditional water regime (75 - 80%) - norm; Condition 3 should be aeration, ie, aerobic aerobics; Condition 4 If legumes have not previously been planted in the ground, the seeds should be moistened with nitrogen 3-4 hours before sowing in a cool (protected from the sun) place, otherwise the crop will not form.

5<sup>th</sup> condition is in the fertilization system should be sprayed with seeds that consume 1 kg / ha of elements containing trace elements, spraying with molybdenum on acidic soils gives good results. Nitrogen fertilizers are applied to the young phase before sowing, phosphorus and potassium are added at 100–80 kg /ha before plowing.

### **DISCUSSION**

In the eighteenth and nineteenth centuries, European scientists noted the effect of natural nitrogen, phosphorus and potassium on the growth of natural nitrogen, phosphorus and potassium in soil. For example, one of the founders of agrochemistry, the German chemist J.Libih (1847), in his book "Chemistry in Agriculture and Physiology" said that the plant receives ammonia from the air, but in 1856 it was even believed that the plant receives nitrogen through the roots in the form nitrate. Since then, many researchers have proven that plants need macro, micro and ultra micro nutrients.

Today, there are several microorganisms that accumulate nitrogen in the soil, including ammonifiers, nitrogen fixers, nitrifiers and denitrifiers. Scientific research has solved the problem of bacteria that bind proteins, nucleic acids, molecular nitrogen and convert ammonia to nitrate.

19 substances in the plant are elements S, N, O, N, P, S, K, Ca, Mg, Fe, Mn, Cu, Zn, Mo, B, Cl, Na, Si, CO, which are important. ; of which C, H, O, N are organogen, 95% of the body, the rest

are P, S, K, Ca, Mg, Fe, Al, Na, Si, etc. 5%. 0.001% by weight of the plant, but the substances necessary for growth and development are called ultra-trace elements Mn, Cu, Ca, Mo, B, Co.



**Fig.1. The structure of Root nodules in beans.**

The results showed that in the initial periods of ontogenesis (10-12 days) in this and non-fed variants of fertilization of beans and peas little differs from the plant, the accumulation of the biomass of photosynthesis per day increased significantly due to the activation of growth from the beginning of branching.

It was found (determined) that in both plants chlorophylls "a" and "v" on the leaves were 4.2-4.8 mg per 1 dm<sup>2</sup> of surface (beans) -2.90-3.15 mg when applied with nitrogen and phosphorus-potassium fertilizers. In addition, the accumulation of chlorophyll in the world flow is most intense in the morning (9-11), slows down at 13-16 hours of the day and increases again in the evening (Table 1).

**TABLE 1. THE AMOUNT OF CHLOROPHYLL IN THE LEAF IN THE EXPERIMENTAL VARIANTS (ON AVERAGE FOR 2017-2018)**

Options	3-5 true leaves		Buddingphase		Flowering (blossom) phase		Whenthe 2-3 beans are ripe	
	"a"	"b"	"a"	"b"	"a"	"b"	"a"	"b"
1.	7,5	1,8	7,5	1,8	8,0	1,10	7,4	0,82
2.	8,6	2,1	9,2	2,1	9,6	1,80	5,8	0,91
3.	7,9	2,3	9,3	2,0	11,3	1,84	6,0	1,10
4.	6,9	2,0	11,3	1,95	12,3	2,0	6,1	1,12
5.	7,4	2,1	11,4	2,1	12,0	2,3	6,3	1,13
6.	7,3	1,2	12,3	2,1	11,1	2,2	6,2	1,12
7.	8,3	2,3	13,6	2,4	12,4	2,3	7,2	1,14

Based on the above, since 2017, stationary experiments have been carried out to determine the effect of different levels of nitrogen on peas, soybeans, beans in the humid regions of the

Chimgan hills of the Fergana region, we research mainly on the number, weight, life expectancy of branched bacteria in beans, pea root.



*Fig. 2. The structure of the Root nodules of the pea plant.*

In experiments carried out on pie endogenous bacteria, the seeds were treated with 137 nitrogen preparations when sowing cotton after wheat in 2016. In the second year, they were transplanted in the spring without nitrogen, in the summer 3 more times. At the same time, starting from 2017, soybeans were planted with the Nasaf variety. In 2017, 2018 and 2019, before sowing half of 30,60,90,120 kg of nitrogen per hectare, the rest was watered with cultivator fertilizers to a depth of 15-16 cm. All agrotechnical work was carried out in accordance with the recommendations of N.N. Ataboeva, Sh. Khudoikulov (2018) in "Plant growing" ("Botany").

## REFERENCES

1. M. Nazarov, M. Gaybullaeva. Influence of ecological factors on photosynthesis processes in legumes. "Agro Science" Journal. 2020, 2nd appendix.
2. 2. Rubin B.A., Gavrilenko V.F. Plant Physiology, M.MGU, 1956.
3. 3. Otaboyev Sh., Nabyev M. Insonvabiosfera, T., «O'qituvchi», 1995 y.
4. Бекназов Р.У., Новиков Ю.В. Охрана природы, Т., «O'qituvchi», 1995 г.
5. F. Ramade. Elements d'ecologie. ecologie appliquee. 5e-edition EDISCIENCE. International. 1995.
6. 6. Tursunov X. T. Ekologiya asoslarivatabiatnimuhofaza qilish. «Saodat RIA», 1997y.
7. 7. Ziyomuhamedov B. Ekologiyavama'naviyat, T., «Mehnat», 1997-y.
8. 8. Лосев А. В., Провадкин Г. Г. Социальная экология. М., «ВЛАДИС», 1998 г.
9. Majidov T. Unconventional and renewable energy sources. Tashkent, 2014.

10. Shodimetov K. Use of alternative energy sources and its economic prospects. Tashkent – “ILM-ZIYO”– 2014.
11. Shodimetov K. The development of alternative energy is a strong social protection factor. Tashkent, 2013
12. Allaev K. Electric power industry of Uzbekistan and the world. Tashkent, 2009
13. Gorodov R. Unconventional and renewable energy sources. Tomsk, 2009.
14. Abdurakhmonova, M. M., ugliMirzayev, M. A., Karimov, U. U., & Karimova, G. Y. (2021). Information Culture And Ethical Education In The Globalization Century. *The American Journal of Social Science and Education Innovations*, 3(03), 384-388.
15. Butaboev, M. T., & Karimov, U. U. (2020). «ЗЕЛЁНАЯ ЭКОНОМИКА». МИРОВОЙ ОПЫТ И ОСОБЕННОСТИ РАЗВИТИЯ В УЗБЕКИСТАНЕ. *Theoretical&AppliedScience*, (2), 704-710.
16. Karimov, U., & Abdurakhmon, A. (2017). INNOVATIVE INFORMATION TECHNOLOGY IN EDUCATION. *Форум молодых ученых*, (5), 9-12.
17. Karimov, U., & Kasimov, I. (2018). THE IMPORTANCE OF MODERN INFORMATION TECHNOLOGIES IN DEVELOPMENT OF DISTANCE EDUCATION. In *Перспективные информационные технологии (ПИТ 2018)* (pp. 1186-1187).
18. Бутабоев, М. Т., & Каримов, У. У. (2020). ПЕРЕХОД К «ЗЕЛЁНОЙ ЭКОНОМИКЕ» И ОСОБЕННОСТИ ЕЁ РАЗВИТИЯ В УЗБЕКИСТАНЕ. *Интернаука*, 23(152 часть 2), 41.
19. Каримов, У. У. (2017). РОЛЬ СРЕДСТВ МАССОВОЙ ИНФОРМАЦИИ В ПРОЦЕССЕ ГЛОБАЛИЗАЦИИ. In *Перспективные информационные технологии (ПИТ 2017)* (pp. 1189-1192).
20. Каримов, У., Хакимова, Д., & Халилов, Л. (2018). ИНФОРМАЦИОННОЕ И КОММУНИКАЦИОННОЕ ТЕХНОЛОГИИ ВЛИЯНИЕ НА ОБРАЗОВАНИЕ В ТЕХНИЧЕСКОМ ОБСЛУЖИВАНИЕ. *Мировая наука*, (10), 193-197.
21. Каримов, У., & Каримова, Г. (2018). ГЕОПОЛИТИЧЕСКАЯ КОНКУРЕНЦИЯ В ИНФОРМАЦИОННОМ ПРОСТРАНСТВЕ. In *Перспективные информационные технологии (ПИТ 2018)* (pp. 1368-1372).
22. Каримов, У., Хакимова, Д., & Тулкинов, З. (2018). ЗАДАЧИ ПОСТРОЕНИЯ ГРАЖДАНСКОГО ОБЩЕСТВА. *Теория и практика современной науки*, (10), 193-195.
23. Каримов, У. (2017). ИНФОКОМТЕХНОЛОГИИ (ИКТ) ФОРМИРОВАНИЕ ДУХОВНЫХ ХАРАКТЕРИСТИК ЛИЧНОСТИ. In *Перспективные информационные технологии (ПИТ 2017)* (pp. 1160-1163).
24. Методическое пособие по эксплуатации ветроэнергетической установки. Т., 2012.
25. Gaybullaeva M. F. The Role Of Biomass In Saving Natural Resources //The American Journal of Horticulture and Floriculture Research. – 2021. – Т. 3. – №. 02. – С. 1-6.





**ACADEMICIA**  
**An International**  
**Multidisciplinary**  
**Research Journal**  
 (Double Blind Refereed & Peer Reviewed Journal)



**DOI: 10.5958/2249-7137.2021.01233.7**

## **DEVELOPING SMALL BUSINESS AND ENTREPRENEURSHIP THROUGH THE TRANSITION TO THE DIGITAL ECONOMY**

**Obidjon Azizov\***

\*Independent Researcher,  
 Department of economic theory of the Socio-Economic Faculty,  
 Fergana State University, UZBEKISTAN

### **ABSTRACT**

*Today, new digital technologies, innovative business models occupy all spheres of economic life of society and affect the essence of the economy, which in turn shapes the qualitative structural changes in the economy. As a result, the digital economy is emerging as a subsystem of the traditional economy, characterized by the active use of digital technologies and the circulation of specific electronic goods. The level of development of the digital economy is closely linked to national competitiveness, which requires special attention to the development of the state and business. This article provides an overview of the development of the digital economy in the world and in Uzbekistan, an overview of the development of the digital economy, as well as various threats and some suggestions for their elimination.*

**KEYWORDS:** *Digital Economy, Small Business, E-Commerce, Innovation, Sustainable Development, Economic Growth, Government Regulation Of The Economy, Threats And Risks To Scientific And Technological Progress*

### **INTRODUCTION**

Many researchers rightfully link medium-term trends in the development of society and the economy with their digitalization. Today, new digital technologies and innovative business models are penetrating all areas of the economic life of society, influencing the essence of the economy and forming qualitative structural changes in it.

It can be said that humanity has entered a new era of global change due to digitalization and other technological developments being put forward by many researchers today.

It is no exaggeration to say that by the 21st century, e-economy has already moved beyond economic processes. Now that digitalization is being applied to the social processes of society,

the successful lives of people are also increasingly dependent on the digitalization process. Indeed, the activities of all government agencies and their structures are also being evaluated through the widespread introduction of digital technologies. The development of the digital economy on a global scale has led our country to pay great attention to this trend. Admittedly, at the moment, Uzbekistan has not yet achieved a leading position in the world in the digital economy. However, in the group of countries that follow the leaders, it can be said that the rapid development of digitization on economic growth and the promotion of reforms in this area are considered as one of the countries on the agenda, and thus improving its position in this direction year by year.

### **MAIN PART**

The joint activities of the government and business are important for the rapid development of the digital economy in any country.

It is worth noting that the digital economy is now widely accepted as the solution to almost all existing rapid development problems.

In support of our view, we see this reflected in socio-economic and humanitarian studies, including statements and official documents of influential politicians and government officials, as well as a sharp increase in interest in digital issues among the public.

However, it must be acknowledged that just as not all diseases are claimed, the self-digital economy does not serve as the primary means of eliminating all elements of the global economy. The development of artificial intelligence and, as a result, modern technological changes, the digitization of society and the economy and all social structures closely related to them will go hand in hand with direct economic digitization, as all aspects of life are inextricably linked with the economy.

### **An overview of the development of the digital economy.**

Since the second half of the 20th century, information technology has become increasingly important in the economic development of many countries around the world.

At the present stage due to scientific and technological progress the single information economic space is achieving economic growth and labor productivity, creating innovative jobs and digital assets, expanding the rights and opportunities of citizens, as well as access to global markets and enhancing the competitiveness of enterprises, thereby improving the quality of public services.

Chronologically, in 1995, the American scientist N. Negroponte introduced the concept of “digital economy” in connection with the use of modern information technology in digital economic processes and their management. According to him, the advantages of the digital economy include the elimination of the complexity of product delivery, size of the data, low prices, resources for the production of electronic goods, the relatively small size of the product, as well as the almost instantaneous movement of goods via the Internet

The digital economy has become a key factor in the development of various international organizations. In particular, the Organization for Economic Co-operation and Development (OECD) has described the digital economy as a combination of several common goals achieved by people through the Internet and related technologies.

The digital economy is unequally distributed around the world, and there is an uneven distribution in the development of this industry even between the North Pole and the South Pole. For example, the United States itself has an advantage in the development of the digital economy network in the North Pole, with a quarter of the pole in that state. Today, the geography of the digital economy is gaining momentum in the economies of two countries, China and the United States. Currently, the U.S. and China account for 75% of blockchain technology authorship and 90% of the market capitalization of the 70 largest digital platforms in the world.

Looking at the recent past of digital economy development, business digitalization began with domestic and corporate projects and gradually gained global coverage, and soon major digital business participants took first place in the world in digitalizing economic development. In this regard, it is necessary to recognize the development of the world's largest companies in terms of market capitalization, such as Apple, Alphabet, Microsoft, Amazon and Facebook in the field of digital business.

Another major company on this list is Alibaba Group, an internet retailer. In addition, examples of “digital ecosystems” can be found in a variety of other industries and companies today.

In short, the digital economy can be described as a new type of economic relations that already exists and is actively developing in all sectors of the world market.

It is no exaggeration to say that the digital economy may soon become a leading segment of the growth and development of the economic system, a driver of rapid industry management. A single example of this is the fact that the digital economy has some advantages over material commodity exchanges, such as the speed of delivery of goods or the actions taken in practice to provide services almost instantly. Another advantage of the digital economy is that it is associated with lower production and transaction costs.

### **Development of digital economy in Uzbekistan**

Today, in the process of large-scale reforms in our country, comprehensive measures are being taken to actively develop the digital economy, the widespread introduction of modern information and communication technologies in all sectors and industries, especially in public administration, education, health and agriculture.

A number of measures aimed at accelerating the development of the digital economy in the country with the broad involvement of information technology are being set by the head of our state. It should be noted that adoption of the Decree of the President of the Republic of Uzbekistan dated October 5, 2020 No PF-6079 on approval of the strategy “Digital Uzbekistan – 2030” and measures for its effective implementation was an important program aimed at accelerating the development of digital industry in the country .

This Decree provides for the introduction of more than 400 information systems, electronic services and other software products in various areas of socio-economic development of the regions in the framework of digital transformation of regions and industries in 2020-2022, automation of management, production and logistics processes in enterprises in the real sector. More than 280 information systems and software products have been identified for development. Another important role of this decree in the implementation of the digital economy strategy is the addition of appropriate higher education institutions to improve the digital literacy and skills of governors, government agencies and organizations in the regions, training them in information

technology and information security, with their 12,000 employees being trained in IT too. This, in turn, will help reduce poverty through the widespread implementation of local information, the introduction of e-government services for the development of small businesses and private entrepreneurship, which play an important role in the socio-economic life of the country through the digitalization of the economy in remote areas.

The Decree also provides for the practice of hearing monthly reports of the heads of government agencies and organizations on the implementation of planned projects and measures for the development of the digital economy and e-government, as well as consideration of their responsibilities. Based on continuous monitoring of the widespread implementation of the digital economy in the country, it is planned to take measures to further improvement of e-government services in business, optimization of functional processes and procedures in state bodies and organizations.

Another important reform envisaged in the decree was the introduction of the formation of a personal account for the establishment of electronic interaction with government agencies and organizations in the issuance of an ID card to an individual under the complex program "Digital Tashkent". Today this system has been put into practice, which allows even more accelerating and optimizing the stages of documentation and registration process when starting a small business. In addition, the Open Data Portal of the Republic of Uzbekistan envisaged by the Decree provides for the online posting of public statistics by government agencies and organizations, registration of patents, medicines and medical devices, public transport, land use and other public statistics. Significant benefits will be achieved in the development of entrepreneurship in the field of large business. This will allow entrepreneurs to obtain the necessary information from the open data portal, preventing them from obtaining documents of various permits, applying to the competent authorities for the first step to start a business.

In addition, it should be noted that the ability of individuals and legal entities to pay all established state duties, fees, fines and other mandatory payments online using electronic payment systems will create a wide range of benefits for small businesses.

Another important aspect is that the Decree stipulates that by January 1, 2022, the digital transformation of commercial banks will be completed by providing a wide range of online services, including the sale of remote credit products, opening deposits and accounts.

It is also planned to open digital technology training centers for the general population, especially for young people and women, on the basis of existing infrastructure facilities in each district and city. This is aimed at ensuring the broad penetration of public administration into the community and through it, improving the skills of citizens to live in step with the development of the digital economy.

The scope of the reforms includes the organization of paperless electronic document exchange and office work, digitization of all administrative procedures and operational processes, ensuring openness and transparency of activities and the use of public services in settlements, automation of interdepartmental electronic cooperation. provides e-government services to the subjects without human factor.

In short, the “Digital Uzbekistan – 2030” Strategy sets out the strategic goals, priorities as well as medium- and long-term prospects for the development of the digital economy and e-government in Uzbekistan.

It should be noted that today in our country the transition to the digital economy is widespread in all areas. In particular, work has begun on the introduction of the "Electronic Polyclinic" in the health sector, which is expected to reduce the number of documents in medical institutions by 40% and waiting times by 60%. Currently, only in the capital, information systems for electronic medical records, hospitals and ambulances are being introduced in this area. Starting next year, it is planned to launch software in this area in the regions of the country.

It should be noted that in order to ensure the rapid development of the digital economy and to cover all areas in this regard, 2020 has been declared in Uzbekistan “Year of Science, Education and Digital Economy”. On the accelerated development of this sector, the President of Uzbekistan signed another Decree “On measures to widely introduce the digital economy and e-government”. This Decree provides for a doubling of the share of the digital economy in the country's GDP by 2023, including the introduction of a set of information systems in production management, the widespread use of software in reporting in the field of financial and economic activities, as well as the task of its rapid formation through the automation of technological processes.

## CONCLUSIONS AND SUGGESTIONS

In the context of globalization, the digitization of the economy as an important factor of development will bypass the electronic front of any country. Digitalization requires a balanced development not only in the economy, but also in all spheres of life, as well as in social and spiritual life. At the same time, it should be taken into account that lagging behind in one sector will lead to failures in other sectors. As a single example, it is natural that the electronicization of documents in the field of construction lags behind, which in turn delays the registration of the business. As a result, it is necessary to recognize that the start of entrepreneurship and the acceleration of positive results will be slowed down.

Another important factor is the optimization of procedures for providing public services to entrepreneurs, reducing the number of required information and documents, the transfer of all processes related to the issuance of licenses and permits for business activities in electronic form in real time primarily serves the development of small business.

The development of digital technologies in the economy will provide management through the automation of all stages of small business, thereby reducing logistics and procurement costs, robotization of production processes, as well as the introduction of artificial intelligence technologies will enable the development of entrepreneurship in any country.

Therefore, it is expedient to put forward a number of proposals for the development of the digital economy in the transition period. In particular, as a prelude to the rapid development of this sector, there is a need to improve the existing regulatory framework in our country for the introduction of innovative automated control systems and software products.

Accelerating the creation of industry databases in the form of mutual electronic exchange of information between government agencies, the formation of an open registry of information

needed for business, by expanding existing information systems of competent state bodies and organizations to assess the level of digitalization.

In this regard, the implementation of the adopted regulations in this area by the relevant structures is significantly lagging behind. It should also be noted that the lack of awareness of local executives on the content of reforms in the sector leads to the fact that the development of information and digitalization lags behind global economic development.

Today, in many countries around the world, including Uzbekistan, portals for the provision of public services to the population, as well as payment platforms have been developed. In the field of reporting and exchange of information in the field of entrepreneurship, tax authorities are also moving to electronic reception, work on the widespread use of plastic cards for social payments is underway.

The widespread introduction of the digital economy requires, first of all, informatization and technological development. This, in turn, generates the need to increase the number of training of specialists in the field of information, the formation of inter-branch, regional and interstate systems of cyber security, including the improvement of legislation to combat cybercrime, the creation of security units in law enforcement agencies. However, it should be borne in mind that information security should not hinder the growth and development of technology, and it is desirable to strengthen the interstate exchange of information in the field of cyber security, along with the development of the digital economy.

## REFERENCES

1. "The digital economy as one of the models for the development of a post-industrial society", IN Shchepina, AA Borodina, 18.04.2019, Vestnik VSU. "Economics and Management". 2019 No. 2 // Dahlman C., Mealy S., Wermelinger M. Harnessing the Digital Economy for Developing Countries, OECD, Paris 2016.
2. "Defining, Conceptualising and Measuring the Digital Economy", Rumana Bukht and Richard Heeks, UK's Economic and Social Research Council.
3. "Digital economy report", UNCTAD.
4. Decree of the President of the Republic of Uzbekistan dated October 5, 2020 No PF-6079 on approval of the Strategy "Digital Uzbekistan - 2030" and measures for its effective implementation.
5. Resolution of the President of the Republic of Uzbekistan dated April 28, 2020 No PP-4699 "On measures for the widespread introduction of the digital economy and e-government." Defining, conceptualizing and measuring the digital economy. Rumana Bukht and Richard Heeks, Centre for development informatics, University of Manchester, UK.
6. "OECD Digital Economy Outlook 2020", <https://www.oecd.org/digital/oecd-digital-economy-outlook-2020-bb167041-en.htm>
7. Asaul V.V. Mikhailova A.O. Ensuring information security in the formation of a digital economy // Theory and practice of service: economics, social sphere, technologies. 2018r.
8. "G20 Digital Economy Development and Cooperation Initiative", <https://www.mofa.go.jp/files/000185874.pdf>

9. Dashchenko Yu.Yu. Digital economy as the economy of the future // Trends in the development of science and education. 2018
10. Formation of digital economy and industry: new challenges: monograph // Aleksandrova A.V. Aletdinova A.A. U. Aftakhova; Peter the Great St. Petersburg Polytechnic University. 2018.
11. Xasanov, I. M. (2019). Problems of employment in Uzbekistan. *Образование и наука в России и за рубежом*, (16), 156-158.
12. Karimov, U., Kaxarov, S., Yokubjonov, S., & Ziyodov, D. (2018). USING NEW INFORMATION TECHNOLOGIES IN DISTANCE LEARNING SYSTEM. In *НОВАЯ ПРОМЫШЛЕННАЯ РЕВОЛЮЦИЯ В ЗЕРКАЛЕ СОВРЕМЕННОЙ НАУКИ* (pp. 9-11).
13. Abdurakhmonova, M. M., ugliMirzayev, M. A., Karimov, U. U., & Karimova, G. Y. (2021). Information Culture And Ethical Education In The Globalization Century. *The American Journal of Social Science and Education Innovations*, 3(03), 384-388.
14. Butaboev, M. T., & Karimov, U. U. (2020). «ЗЕЛЁНАЯ ЭКОНОМИКА». МИРОВОЙ ОПЫТ И ОСОБЕННОСТИ РАЗВИТИЯ В УЗБЕКИСТАНЕ. *Theoretical & Applied Science*, (2), 704-710.
15. Karimov, U., & Abdurakhmon, A. (2017). INNOVATIVE INFORMATION TECHNOLOGY IN EDUCATION. *Форум молодых ученых*, (5), 9-12.
16. Charting our Water Future: Economic Frameworks to Inform Decision Making. Мюнхен: Группировка водным ресурсам 2030. 2009 год, стр.7
17. Global Forest Resources Assessment 2010: Main Report. Рим. Продовольственная и сельскохозяйственная организация (ФАО) ООН. 2010 год, стр.56
18. Karimov, U., & Kasimov, I. (2018). THE IMPORTANCE OF MODERN INFORMATION TECHNOLOGIES IN DEVELOPMENT OF DISTANCE EDUCATION. In *Перспективные информационные технологии (ПИТ 2018)* (pp. 1186-1187).
19. Бутабоев, М. Т., & Каримов, У. У. (2020). ПЕРЕХОД К «ЗЕЛЁНОЙ ЭКОНОМИКЕ» И ОСОБЕННОСТИ ЕЁ РАЗВИТИЯ В УЗБЕКИСТАНЕ. *Интернаука*, 23(152 часть 2), 41.
20. Tobin, J. (1974). *The New Economics One Decade Older*. Princeton.
21. И.А.Хасаншина. Цифровая экономика. Учебник для вузов. М., 2019.
22. Каримов, У. У. (2017). РОЛЬ СРЕДСТВ МАССОВОЙ ИНФОРМАЦИИ В ПРОЦЕССЕ ГЛОБАЛИЗАЦИИ. In *Перспективные информационные технологии (ПИТ 2017)* (pp. 1189-1192).
23. Хасанов, И. М. (2020). РОЛЬ ДОМОХОЗЯЙСТВ В РАЗВИТИИ ЭКОНОМИКИ РЕГИОНА. In *МИНТАҚА ИҚТИСОДИЁТИНИ ИНВЕСТИЦИЯЛАШНИНГ МОЛИЯВИЙ-ҲУҚУҚИЙ ВА ИННОВАЦИОН ЖИҲАТЛАРИ* (pp. 198-202).
24. Хасанов, И. М. (2020). Сущность и функции домашних хозяйств в современной экономической системе. *Образование и наука в России и за рубежом*, (3), 65-67.

- 
25. Абдрахманова Г.И., Гохберг Л.М. и др. Цифровая экономика: краткий статистический сборник. М.: Национальный исследовательский университет. «Высшая школа экономики», 2018.
  26. Аюпов Р.Х., Болтабоева Г.Р. Рақамли иқтисодиёт асослари. Дарслик. Тошкент, 2020.
  27. “Рақамли иқтисодиётни шакллантиришдаги замонавий трендлар: тажриба, муаммо ва истиқболлар” мавзусида Республика онлайн илмий-амалий анжумани маъруза тезислари тўплами. Тошкент, 2020 йил, 14 октябр.
  28. Основы цифровой экономики. под редакцией М.И.Столбова, Е.А.Брендалевой. Учебное пособие. М., 2018.
  29. Гулямов С.С., Аюпов Р.Х. Рақамли иқтисодиёт ва электрон тижорат асослари. Ўқув кўлланма. Тошкент, 2020.
  30. Ходиев Б.Ю. Цифровая экономика в Узбекистане. //Мировая экономика, 2017, №12.
  31. Khasanov I. M. Essence, Mission And Value Of Entrepreneurship Activity //The American Journal of Management and Economics Innovations. – 2021. – Т. 3. – №. 02. – С. 38-45.
  32. Каримов, У., & Каримова, Г. (2018). ГЕОПОЛИТИЧЕСКАЯ КОНКУРЕНЦИЯ В ИНФОРМАЦИОННОМ ПРОСТРАНСТВЕ. In *Перспективные информационные технологии (ПИТ 2018)* (pp. 1368-1372).
  33. Butaboyev M.T., Karimov U.U. The development of the digital economy is the shortest way to achieve the development of society // EPRA International Journal of Economic Growth and Environmental Issues. Volume: 8. Issue: 2. September, 2020. p.47-51.





**ACADEMICIA**  
**An International**  
**Multidisciplinary**  
**Research Journal**  
 (Double Blind Refereed & Peer Reviewed Journal)



**DOI: 10.5958/2249-7137.2021.01234.9**

## PROGRESSIVE DEVELOPMENT OF ENIGMATIC TEXTS IN LINGUISTICS

**Yakubova Nodirakhon Davlatbay kizi\***

\*Doctorant of Kokand state pedagogical Institute,  
 Kokand, UZBEKISTAN

### ABSTRACT

*This article is devoted to the study of enigmatic texts as a special type of text. It deals with the origin of enigmatic texts, their distribution in different forms in different countries, the first collections of "riddles" and their authors. The article reflects attempts to explore puzzles not only as an object of folklore but also as a linguistic object.*

**KEYWORDS:** *Text, Enigmatic Text, Riddle, Puzzle, Conundrum, Linguistic Phenomenon.*

### INTRODUCTION

Nowadays, linguistics is concerned with the study of phenomena related to human linguistic thinking and its communicative activity. The creative potential of language can be seen obviously in the phenomenon of human speech. This creativity is reflected in the text, which is the product of the phenomenon of verbal communication. As a result of the integration of scientific ideas around the world, new directions are emerging and forming within the boundaries of various scientific fields. In particular, the direction of textual linguistics has gone through a number of stages of its development. In this field, the text is recognized as an object of linguistic research.

The most characteristic feature of the text, emphasized by various authors, is that in it, on the basis of relevance and purposefulness, the ideas under the general theme, along with providing information, also have a semantic sequence. Not all authors dwell on this feature of the text, as the idea that the semantic completeness of the text must have certain limits is disputed.

Recently, in the process of text analysis, the communicative character has come to the fore. All the diversity that exists in our language today arises only from the manifestation of images and systems of images that are stored in our memory and can be reflected in the human mind. Images that contain additional ethical or aesthetic content have a symbolic meaning in the minds of

native speakers, i.e., speakers of that language. That is why the text is considered as a socio-communicative unit.

The development of the field of textual linguistics requires researchers to focus on less studied areas, in particular the study of different game-related types of texts. Although literature, especially folklore, was originally the subject of study, riddles and other related genres, such as chiston and crossword puzzles, were used as a type of puzzle to create a special mode of communicative collaboration in the form of dialogue. and not only allows us to understand the various forms of the vernacular from new positions, but also demonstrates the inexhaustible potential of oral creativity, the formation of an aesthetic worldview, the elucidation of original considerations and ideas.

In this sense, we have found it necessary to study enigmatic texts in world linguistics - puzzles, crossword puzzles and logical questions as a special type of text. We consider it expedient to analyze the philological stage of the process of studying enigmatic texts, in particular, the development of the field of "riddles" in two main directions: the first is the process of reciting, collecting and compiling riddles from different strata of the people's representatives orally; that is, the practical phase and the second is a theoretical process aimed at the linguistic study of these collected materials. If we look at the history of the development of riddles, the most common form of enigmatic texts in the first stage, we see that the oldest riddles contained mythical symbols, poetic texts here served partly to describe and partly to explain natural and environmental phenomena. Over time, this meaning of the puzzles disappeared, only the figurative-allegorical description remained, and people began to look at the puzzles as a simple exercise of the mind.

From ancient times the riddles had a special mysterious meaning, and in folk epics they also acquired a special divinity. That is, there were also beliefs that guessing the riddles would help the desires to be answered, to get rid of the danger. Puzzles can also be included as a plot element in fairy tales and adventure tales, which served as one of the forms of testing the protagonist[1]. Saying a riddle and finding its answer, puzzle competitions are a very common motif of this folk epic and the fiction created under its influence. This special question-and-answer tour covers all nations and eras, including the Edda, which depicts ancient Germanic and Scandinavian mythology, the Kalevala, an ancient Finnish song, and Indian poetry[2].

Ancient Russian and Slavic songs consisting of riddles usually follow a cycle of legends about the "wise girl"[3]. According to their content, when the bride and groom are compared, the idea that the bride is not so stupid is also highlighted.

However, among the ancient Greeks, riddles were associated with words and were mainly expressed in hexameters (poetic measurements). In Greek, riddles were also used for didactic purposes. Poets, on the other hand, added puzzle-shaped words to their works[2].

In later periods of Christianity, under the influence of reading the books of the Scriptures, many puzzles began to emerge in places where puzzles were considered important, with biblical themes or the origin of everything that exists. In the seventeenth century, interest in riddles was revived: in France Fenelon, Bualo, Jean-Jacques Rousseau were known as puzzle writers, while in Germany Schiller spoke with his poetic riddles. In Russian literature, V.A.Zhukovsky created wonderful examples of poetic riddles.

Such texts exist in all nations, and in this sense, we must first turn our attention to collections based on riddles. In particular, the first collection of German riddles in Western Europe was published in Strasbourg in 1505 (later published in 1875), and in France by Abbot Koton in 1646, the collection "Recueil des énigmes de ce temps"[2]. From English literature, Archer Taylor's "English Riddles from the Oral Tradition" (published in 1951), Exeter Book (published in 1961)[4], and F.J.Childe's "English and Scottish ballads" are unique sources, including the oldest Anglo-Saxon riddles.

We can see that the collection and study of Russian folk riddles on a scientific basis began in the 60s of the XIX century. According to I.M. Kolesnitskaya, the scientific collection of Russian folk riddles was originally compiled by I.A. Khudyakov and published in 1861 with a brief introduction[5]. Also from Russian literature D.N.Sadovnikov's "Russian folk riddles" ("Zagadki russkogo naroda") (1876), M.A.Rybnikova's "Puzzles" ("Zagadki") (1931) and V.V.Mitrofanova's collections such as "Zagadki" (1968) are the first examples of such sources. Most of these collections have a unique thematic structure.

Ўзбек халқ топишмоқларини тўплаш ва қисман бўлса ҳам текшириш ишлари ҳам XIX асрнинг 2-ярмидан бошланган[6]. It is not known whether there were any collections of Uzbek riddles until the nineteenth century, with the exception of a few Turkic riddles in "Codex comanicus"[7] a few muammos found in some manuscripts, question-and-answer riddles, and chistons[6]. However, over time, the first collections of Uzbek riddles, although translated into Russian, were published. The collection published in 1895 "Proverbs and riddles of Sartov" by N.Ostroumov [8] and A.Vasilev's article "Sartovskie zagadki"[9] was prepared for publication in 1909. Thus, the number of people interested in collecting these samples of Uzbek folklore has increased. However, not all of them were analyzed because they did not meet scientific requirements.

Riddles, which have been the masterpieces of folk wisdom for many years, are not only a joyful game of the mind, a means of spiritual relaxation, which develops human perception, observation, poetic imagination, but also a key role in understanding the spiritual world and historical past of our ancestors. They are invaluable documents of historical culture. In this regard, A.N.Tolstoy wrote: "It is a mistake to think that oral literature is only the fruit of popular entertainment. He filled the stable spiritual image and historical memory of the people, the activities, nature and customs of their ancestors, and the whole life flowing in accordance with them with deep meaning[10].

## CONCLUSION

The culture of the ancient and talented people has flourished on Uzbek soil. All sections of the population were involved in the collection of folklore works. Scientists such as B.Karimov, M.Afzalov, Z.Khusainova made a significant contribution to the study of Uzbek riddles. The archive fund of the Institute of Literature of the Academy of Sciences of Uzbekistan has accumulated a huge amount of material on Uzbek riddles [11]. It is among these materials that one can find a number of riddles in the oral poetry of the Uzbek people, created on the basis of the laws of national poetics. In Uzbek folklore, as in other nations, the main manifestations of artistic speech, such as comparison, allegory, animation, adjective, are subject to one goal - poetic perception, poetic description of reality. Uzbek riddles reflect the Uzbek reality, the Uzbek nature. That is why folk riddles are small examples of folk art.

Therefore, one of the important tasks of modern Uzbek theoretical linguistics is to talk about such poetic works based on concealment, that is, the language, structure, semantic and pragmatic features of enigmatic texts.

#### REFERENCES

1. Zagaka // Kazakhstan. National encyclopedia. - Almaty: Kazakh encyclopedia, 2005. - T. II. - ISBN 9965-9746-3-2
2. <https://ru.wikipedia.org/wiki>. Date of access: 24.03.2021
3. Potebnya A, «Explanation of Malorussian and related folk songs», v. II, XLVIII and L, 188
4. Orlova O.S. Zagadka as tekst lingvisticheskogo issledovaniya. Nauchnaya statya .. UDK 82-193.1 p.3
5. Kolesnitskaya I.M. Mystery in a fairy tale. “Uchenye zapiski LGU”, seriya filologicheskix nauk, L., 1941, vyp.12, p.100
6. Husainova Zubayda. Uzbek folk riddles. Publishing house "Fan" of the USSR of Uzbekistan, Tashkent, 1966
7. Codex Cumanicus, baksimile, Copenhagen, 1936
8. Ostroumov N.P. Poslovitsy i zagadki sartov, etnograficheskie materialy, vyp.III, 1895
9. Vasilev A. Sartovskie zagadki.// “Turkestanские ведомости” newspaper. 1909. No. 113
10. Tolstoy A.N. Homeland // Sobr.Soch. v 10 t. M., 1986. T. 10: Journalism — P.66
11. Abdurahimov M. Uzbek folk riddles. www.ziyouz.com Library, page 3

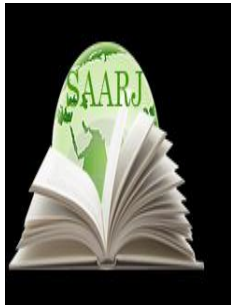

**ACADEMICIA**  
**An International  
 Multidisciplinary  
 Research Journal**  
 (Double Blind Refereed & Peer Reviewed Journal)



**DOI: 10.5958/2249-7137.2021.01235.0**

## KOKTURK WRITING AND DIFFERENT IDEAS IN ITS STUDY

**Dilorom Mirzaeva\***

\*Student,  
 Fergana State University,  
 Fergana city, UZBEKISTAN

---

### ABSTRACT

*This article discusses the peculiarities of the Kopturk alphabet, which existed in the early Middle Ages and was one of the main writings of the Turkish Khanate, and its importance in cultural life at that time. Although there are some sources on the use of writing in the Hunnic period, we do not know the exact meaning of this writing. therefore, the first known alphabet used by the Turks was the one widely used during the Kopturk period. So what is the blue alphabet? What are its features? The Kopturk alphabet, used by the ancient Turkic people, was later used by the Huns and Kyrgyz.*

**KEYWORDS:** *Kopturk Alphabet, Orkhon-Enasay Inscriptions, V.Tomsen, N.Yadrinsev, Turkic Peoples, Inscriptions.*

---

### INTRODUCTION

Our culture, which has been influenced by many civilizations throughout history, is also influenced by language. Over time, the use of the alphabet began to change according to the geography in which it was located. The Kopturk alphabet, known as the first alphabet used by the Turks, is similar in origin, although it is very different from the modern alphabet. So what is the blue alphabet? What are its features? The Kopturk alphabet, used by the ancient Turkic people, was later used by the Huns and Kyrgyz. Research has also shown that it was used by Turks who immigrated to Europe and by a group called Sekeller in 16th century Hungary.

### METHODS

The Kopturk alphabet and its origins are being studied. It is believed that pictures were used in the formation of this alphabet. This script is also very important for our culture because it was the main writing system used by the Turks.

This first Turkish alphabet, which was widespread during the Turkish Khanate, was used not only in writing but also in manuscripts. The so-called "East Turkestan Manuscripts" prove this. Apparently, this alphabet was used for some time during the Uyghur period, which came after the Kokturks. The Shine-Usu inscription, dated 759–760, and the Taryat inscription, discovered in recent years, illustrate this point. The Kokturk alphabet was also used by the Bulgarians, Khazars, Pechenegs, and Sekels with some modifications, and thus spread from Central Asia to the interior of Europe.

The emergence of the Turks as a political entity on the stage of history dates back to the centuries BC, the Hiungnu period. Although there are some sources on the use of writing in the Hunnic period, we do not know the exact meaning of this writing. therefore, the first known alphabet used by the Turks was the one widely used during the Kokturk period. In recent years, a two-line text written in the Kokturk alphabet found in a fortress near Issyk-Kul dates back to the 5th-4th centuries BC. Therefore, it must be acknowledged that the first Turkish inscription belonging to the Kokturks was found centuries before the establishment of the Turkish Khanate.

The Orkhon-Enasay inscriptions were first reported in the early 18th century by the Russian scientist S. Remezov, later by the Swedish scientist F. Stralenberg and the German scientist D. Messerschmidt. The fact that these inscriptions belonged to the Turkic peoples was first proved by the French scientist J. Abelremyza, and then by the Russian scientist N. Yadrinsev. In 1890, as a result of archeological expeditions along the Orkhon River under the leadership of N. Yadrinsev and V. Radlov, 2 atlases were published in 1892. The first Orkhon-Enasay inscriptions published in these atlases were read in November 1893 by the Danish linguist W. Thomsen. After Thomsen, Radlov compiled a transliteration and transcription of a text on a huge stone written in the eighth century in memory of the Turkish prince Kultegin and translated it into German. This material formed the first idea of the structure, phonetics, morphology and lexicon of the ancient Turkic language.

## RESULTS

There is no consensus among scholars on the origin of the Orkhon-Enasay inscription. It is widely believed that the inscription is derived from the Sogdian and Pahlavi scripts of the Aramaic script. The place and time of the appearance of the Orkhon-Enasay inscription are still unresolved. Due to some graphic features related to the place and time of its appearance, it has the options of orkhon, talas, yenisey. The oldest of these is the Orkhon version. These inscriptions are in harmony with the Turkic languages, are more perfect, and are somewhat easier to write and read than the Arabic script, after the Arab conquest of Central Asia, Kazakhstan, and many other places inhabited by the Turkic peoples. Arabic script is widespread in the countries.

Because the characters used in the alphabet were similar to the characters in the old Scandinavian script called Runic, they were considered runic characters and it was speculated that they may be related to this alphabet. However, Russian scholars such as Aristov have suggested that the symbols may have been derived from old Turkish brands. Jevat Emre suggested that the Kokturk script had the same roots as the Sumerian script. This is what can be said in the midst of various and even contradictory arguments, and in scientific circles Thomsen's opinion is considered widespread and well-founded. There are 38 letters in the alphabet, 4 of which are vowels. Stamps in the alphabet represent sounds. The sounds "ae", "i-1", "ou", "ö-ü" are also used in the alphabet without separating them from each other. When writing

text in this alphabet, spelling is done from right to left or from top to bottom without attachment. The text uses two dots to separate words.

## DISCUSSION

The Yenisei writing system contains more than 150 characters of the Orkhon alphabet, using a total of 38 letters of the Kokturk alphabet. The deleted characters are 38 in the Orkhon alphabet. Of the fourth, 34 are consonants. The main reason for the large number of consonants in the alphabet is that some letters are represented by two characters. Other features of the alphabet are:

- ❖ Each has two letters that give the sounds “y, t, s, r, n, l, g, d, b” depending on whether the vowel next to it is thin or thick.
- ❖ Double sounds have a pair of consonants. They can be used as "yn, nch, ik".
- ❖ Flours are used inseparably. It is written and read according to the harmony of the vowels.
- ❖ As in the Latin alphabet, non-adjacent blue letters are used separately.
- ❖ There is a big pause between the words. No more punctuation.
- ❖ The text is usually read from the right.
- ❖ Flours are not used much. If there are vowels, they are included in the first syllable. Subsequent vowels are not used when they are the same. Only the last letter is written with a vowel.
- ❖ There is no confusion in consonants. Thin and thick consonants can be used interchangeably.

The works written in the Kokturk alphabet cover the Uyghur and Kokturk periods. The inscriptions are usually tombstones, and the remains of the Uighur Turks are mostly considered to belong to the Mani and Buddhist religions.

The inscriptions are also called bengü stones, and these stones were erected to build a monument after the death of the recipients of the state message and the khagans. Inscriptions from the Kokturk period:

- Kokturk inscriptions
- Monument to the Nightingale
- Kultegin monument
- Bilga Hakan monument

It is known that the technique of printing the book was used in the Uyghur period. There are many stories about the period. The Kokunch Theater is one of them. In general, the excitement and national consciousness in the works of the Kokturk period are not reflected in the writings of this period. The inscriptions are usually found in the form of tombstones.

Groups of the Orkhon-Enasay inscription such as Lena Baikal, Yenisei, Mongol, Altai, East Turkestan, Central Asia, and Eastern Europe have been identified. Russian and European scholars such as V. Thomsen, V.V. Radlov, P.M. Melioransky, A.A. Polovtsev, G. Geikel, S.E. Malov, L.N. Gumilyov, D. Nemet have made a great contribution to the study of the Orkhon-Enasoy inscription. Academicians G.Abdurahmanov and A.Rustamov and professor

N.Rakhmonov from Uzbek scholars also studied the Orkhon-Enasay script and carried out certain researches. The study of these monuments continues to this day.

## CONCLUSION

In short, some lexical units and grammatical forms of the Orkhon-Enasay script are found in modern Uzbek, Uyghur, Azerbaijani, Kyrgyz, Kazakh, Turkmen, Karakalpak, Tatar, Bashkir, Karachay, Bulgarian and other Turkic languages. The Orkhon-Enasay script is a valuable source for studying the history, culture, ethnography, language and history of Turkic languages.

## REFERENCES:

1. Малов С.Й.. Памятники древнетюркской письменности. М., - Л., 1951.
2. Малов С.Й. Енисейская письменность тюрков. М., - Л., 1952.
3. Айдаров Г. Язык орхонского памятника Билге Кагана. Алмата, 1966.
4. Кляшторный С.Г. Древнетюркские рунические памятники как источник по истории Средней Азии. М., 1964.
5. Абдурахмонов Ф., Рустамов А. Қадимги туркий тил. Т., 1982.
6. Р.Шамсутдинов, Х.Мўминов. Ўзбекистон тарихи. Ўқув-методик, ёрдамчи материал. Андижон. 2011.
7. Н.У.Мусаев ва бошқ. Ўзбекистон тарихи. маърузалар матни. Тошкент, 2014.
8. Жабборов И. Ўзбек халқи этнографияси. -Т., “Ўқитувчи”, 1994.
9. Каримов, У. У. (2017). РОЛЬ СРЕДСТВ МАССОВОЙ ИНФОРМАЦИИ В ПРОЦЕССЕ ГЛОБАЛИЗАЦИИ. In *Перспективные информационные технологии (ПИТ 2017)* (pp. 1189-1192).
10. Каримов, У., Хакимова, Д., & Тулкинов, З. (2018). ЗАДАЧИ ПОСТРОЕНИЯ ГРАЖДАНСКОГО ОБЩЕСТВА. *Теория и практика современной науки*, (10), 193-195.
11. Исломов З.М. Ўзбекистон модернизациялаш ва демократик тараққиёт сари. – Т.: Ўзбекистон, 2005.
12. Рахманов А. Гражданское общество: достижения, проблемы, перспективы: учебное пособие. – Т.: Академия, 2007.
13. Каримов, У. (2017). ИНФОКОМТЕХНОЛОГИИ (ИКТ) ФОРМИРОВАНИЕ ДУХОВНЫХ ХАРАКТЕРИСТИК ЛИЧНОСТИ. In *Перспективные информационные технологии (ПИТ 2017)* (pp. 1160-1163).
14. Зиёев Ҳ. Тарих – ўтмиш ва келажак кўзгуси. Тошкент, 2000.
15. Насимхон Раҳмон. Турк ҳоқонлиги. -Т.: 1993.
16. Сағдуллаев А. Қадимги Ўзбекистон илк ёзма манбаларда. Тошкент, 1996.
17. Сағдуллаев А., Норқулов Н. ва б. Ўзбекистон тарихи: Давлат ва жамият тараққиёти. Тошкент, “Шарқ”, 2001.
18. Ахмедов.Б. Ўзбек улуси. Тошкент, 1992.



**19.** Ҳасан Ато Абуший. Туркий қавмлар тарихи. Тошкент, 1993

**20.** Каримов, У., & Каримова, Г. (2018). ГЕОПОЛИТИЧЕСКАЯ КОНКУРЕНЦИЯ В ИНФОРМАЦИОННОМ ПРОСТРАНСТВЕ. In *Перспективные информационные технологии (ПИТ 2018)* (pp. 1368-1372).

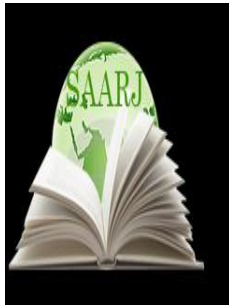

**ACADEMICIA**  
**An International  
 Multidisciplinary  
 Research Journal**  
 (Double Blind Refereed & Peer Reviewed Journal)

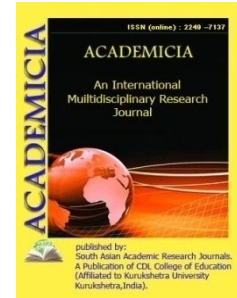

**DOI: 10.5958/2249-7137.2021.01236.2**

## ORGANIZATION OF THE EDUCATION PROCESS BASED ON A CREDIT SYSTEM, ADVANTAGES AND PROSPECTS

**Obidov J.G\*; Alixonov E.J\*\***

<sup>1,2</sup>Ferghana polytechnic Institute,  
 UZBEKISTAN

Email id: jamshidobidov19@gmail.com

### ABSTRACT

*This article to the analysis of credit system introduction to the education process, it's futures and perspectives in educational system of the Republic of Uzbekistan, especially in TUIT is devoted. This article the fundamental position in the modern assessment system in the field of education. The introduction of a credit system raises the need to compare similar modernization steps in the experience of other countries are describes. The introduction of the credit system in Uzbekistan requires a comprehensive analysis of the optimal approach in the process of its implementation. This the article reflects the educational practice in countries with economies in transition regarding the introduction of a credit system for assessing knowledge gained on the basis of experimental work.*

**KEYWORDS:** *Credit Education System, Credits, Educational Process.*

### 1. INTRODUCTION

Social and economic development of the Republic of Uzbekistan was a prerequisite Root of Perfection I Higher Education. The priority issue was the training of personnel, the creation of conditions for the retraining of higher education specialists at the level of international standards.

Based on the modern requirements of social life and the economy, one of the main tasks of modernizing the higher education system is the introduction of modern forms and technologies into education based on the study of international experience.

Decree of the President of the Republic of Uzbekistan dated February 19, 2018 "On measures to further improve information technology and communications" and the Cabinet of Ministers of the Republic of Uzbekistan "On measures to radically improve and enhance information

technology" The effectiveness of the training system at the Fergana Polytechnic Institute "will radically improve and increase the efficiency of training at this institute.

An important step in the ongoing system of innovations is the introduction from the 2018-2019 academic year of a credit training system for training personnel in the field of information technology and communications in order to ensure the university's entry into the list of the most prestigious universities in the world. [1]

## 2. LITERATURE REVIEW

Currently, the most widespread and mature credit systems are the United States Credit System (USCS), which has been in use since the end of the 20th century, and the European Credit Transfer System (ECTS), which began to form in the mid-1980s. biennium and since 1997 has been adopted by the European Commission as a unified system for comparing learning outcomes in the educational space of the EU countries. Since June 1999, after the European countries signed the Bologna Declaration (where the introduction of a credit system of education is the main criterion for the country's entry into the Single European Educational Space), these processes began to spread more and more intensively. [4]

The analysis of the literature made it possible to state that the credit system is an asynchronous (as opposed to the traditional - "linear") model of the organization of the educational process. It includes all the mechanisms that support it, including credit accounting technology, a system for selecting training courses, principles of grading, a set of criteria for obtaining a diploma, rules for transferring from course to course, rules for converting credits received when transferring to another university, etc.

At the same time, a loan is understood as a unified unit of measurement of the volume of a student's / teacher's academic work, corresponding to 45 academic hours of total labor intensity for any academic period in a bachelor's program, 60 academic hours in a magistracy and 75 academic hours in doctoral studies. Therefore, a credit based system (CBS) is a subject-based educational model based on the requirement to complete the volume of academic work, expressed in credits, in order to obtain a professional qualification or degree.

Comparative analysis of traditional and CBS shows significant differences between them in a number of signs: the duration of the academic year, vacations, semesters, sessions, in the forms and methods of monitoring and assessing the quality of education, the movement of students from university to university, the trajectory of training, the electivity of courses and disciplines, mobility and etc.

The comparison of the credit system and the traditional (linear) education system allows us to say that it is the credit system that has the ability to prepare students for professional activity in the conditions of a modern information (post-industrial) society and, with the correct organization and construction of the educational process, can become a guarantee of high quality education. [2]

According to the Rules for organizing the educational process on CBS, every 15 academic hours of classroom work is accompanied by 30 hours of students' independent work. It is independent work that is the main advantage of the credit system. The free choice of subjects, teachers, schedules gives students the opportunity to be independent, active, mobile, plan and carry out their educational activities as they please. Other advantages of the credit system include: a high

degree of academic freedom; the independent nature of the educational activities of students; developing style of teaching activities of the teacher; independent search educational activity of students; innovative content of educational programs; expanding the volume of the university component of educational programs; an increase in the proportion of active, problem-stimulating, interactive teaching methods; predominance of practical forms of conducting classes; systematic, step-by-step control of students' academic work; productive, research level of knowledge assimilation; diversification of the content and terms of mastering educational programs; compatibility with any national educational system; the possibility of international credit transfer. [11]

It should be emphasized that the advantages of the credit system relate primarily to three interacting parties - students, teachers and the educational institution. And each side benefits from this in its own way. For students, the benefits are: free choice of subjects, teachers and timetables; cumulative rating system, i.e. the ability to assess your knowledge during the learning process, and not after it; enhanced communication capabilities, skills of quick adaptation to a new environment, communication and exchange of information; confidentiality of the student's information about his grades, the number of credits collected, provided by the assignment of an identification number. [13]

Teachers also benefit a lot from the credit system: students' interest in the subject makes the teacher's job much easier; a clearly graded grading system allows for a fair and transparent assessment of student progress; the opportunity to receive grades from students, opinions and recommendations on the subject.

As for the institution itself, the introduction of a credit system adds a significant amount of flexibility and adaptability to its policies. Unlike a traditional university, where the curriculum could remain constant for 10-15 years, a university of a new model has the ability to change the composition of the taught disciplines quite quickly, focusing on the demand for a particular specialty in the labor market, given its relevance given the existing market and social trends.

### **3. Research Method**

The education credit system is based on a trend of transparency and student-centered selection and transfer of test units. This system is considered accumulative, that is, it provides for the growth of loans accumulated earlier at all stages of education.

Its importance lies in the fact that academic programs will be tailored to the requirements of the labor market. 50 percent of the subjects of the curriculum are selective and will be introduced into the information systems of the educational process. Individualization and differentiation of the education system is based on adaptation to changes in socio-economic conditions and educational and program documents.

Under the credit system, classes are conducted in an interactive form. During the week, the student performs independent work, after which the teacher gets acquainted with the results of the work and the weekly rating of students. A student at a university can observe the growth and decline of his rating in his chosen direction. If a student receives a low score or does not prepare for one lesson, then his average grade will decrease. If he does not attend lectures, does not participate in seminars, he is not allowed to take exams. Thus, this form of training necessitates constantly improving the knowledge of teachers and the work of students on themselves. [16]

Credit technology enables the student to choose a subject that is included in the working curriculum. Also, students have the opportunity to choose teachers. Taking into account the fact that first-year students do not yet know all the teachers, for the convenience and objectivity of the choice of teachers, the teachers of the disciplines are developing curricula (syllabus) of subjects. Having familiarized themselves with the curriculum, students will have an idea of the discipline and the requirements for each teacher individually. It is also necessary to note the factor that students, having the opportunity to choose a teacher, do not always choose teachers objectively. Demanding, strict, highly qualified teachers can be left without a student. But this is a matter of time; subsequently, students will choose just such mentors in order to achieve their goal - to gain in-depth knowledge in the chosen direction.

It should be noted that the education system should meet the modern requirements of a dynamic of increasing globalization and informatization development process, in order to prepare highly qualified personnel having high demand in the job market. And for this reason, the importance of introducing a credit system into training for the formation of specialists is so that they can find and process the necessary information, analyze and effectively use it in their future work.

The use of information technologies at the Tashkent University and its operating branches of the credit education system will provide an opportunity to prepare highly qualified specialists who are competitive in the current unstable international labor market, as well as to ensure a high rating of an educational institution among 1000 universities in the world. [6]

In accordance with the government decree "On measures to radically improve and increase the efficiency of the training system at the Tashkent University of Information Technologies named after Muhammad al-Khwarizmi" at the Tashkent University of Information Technologies named after Muhammad al-Khwarizmi and its branches, starting from the 2018-2019 academic year, a credit education system for training personnel in the field of information and communication technologies was introduced. The main goal is to ensure the entry of the university into a number of prestigious universities in the world by introducing a credit education system.

The main advantages of the credit education system:

- Academic mobility - the possibility of continuing the student's studies in foreign educational institutions;
- High level of quality of education - attracting highly qualified industry specialists from foreign educational institutions and leading enterprises to the training;
- Development of curricula, based on the experience of foreign higher educational institutions, in order to ensure the intensification of the learning process;
- Possibility of students' choice of disciplines, etc. [13]

It should be noted that under a credit education system, the level of a student's mastering of a certain course depends on the accumulation of a certain number of credits based on various criteria. The total number of credits earned by a student is determined on the basis of the student's active participation in the classroom, the results of tests during the course, the results of scientific research, oral and written examinations, and practice. The introduction of the credit system of education in the educational process of the university will radically improve the system of training highly qualified specialists who are competitive in the changing international

market, and TUIT will also enter the TOP 1000 prestigious universities in the world. directions for its further development were developed. [7]

Academic Credit System is standards assessment systems, which determines the effectiveness of student learning in higher education. In some cases, only admitted students must first complete a special course in the credit system.

The evaluation criteria are similar to the evaluation criteria of the previous system, but they have their own specifics. Typically, the teacher gives the grade, taking into account student attendance, test results, research and final written work. Also, credit scores differ depending on the composition and complexity of the courses, as well as on how well it fits in the chosen direction. For example, a course that requires a lot of research work has the highest score. It should also be noted that the final control tests are conducted by a special department, which determines the transparency and objectivity of the assessment of students' knowledge. [6]

#### 4. Results

In the Republic of Uzbekistan, the introduction of the credit system in the educational process is due to the desire to improve the level of education, and the desire to comply with world requirements. The introduction into the educational process of the credit system, which is widespread in many higher educational institutions of the world, will allow our educational institutions to become one of the most prestigious universities in the world.

The implemented system has a number of advantages for students:

First, the credit scores collected do not change, they can be transferred when transferring to study at another, more suitable university.

Secondly, the student has the opportunity to choose any subject at will. Of course, there are subjects, the study of which is necessary, but he can choose other disciplines on his own.

Education is determined according to different levels of mastering the course by the student, which depends on the amount of credit. [13]

At the stage of implementation of the credit system, the concept was formed that this system is something completely new. In fact, for, for a student, there is nothing new. If we look in more detail, the following aspects can be identified:

-Visit. Attendance in the educational process has always been a mandatory criterion, which has remained in the credit system. If in the old system 72 hours of passes was the limit, then in the credit system each item is counted separately (7 items \* 5 passes = 35 passes or 70 hours).

-Tasks. In this criterion, too, little has changed, only strict time frames have been set. If in the old system a student could not complete tasks until the end of the student and only by the end of the semester take assignments at a time, then in the credit system, for each assignment, a due date is set after which the student is not given the opportunity to retake. This will make it necessary for students to submit assignments on time and free teachers from the need to accept assignments in large numbers in a short period of time.

-Scholarship. In this aspect, little has changed either, if in the old system scholarships were deprived of arrears and later expelled, then in the credit system a student can be a debtor for up to 7 years.

#### 4. CONCLUSION

In conclusion, it should be noted that the introduction of the credit system into the education process will make it possible to raise the level of education to a new qualitative level, through the effectiveness of training and student mobility - the possibility of recognizing the loans acquired in other educational institutions, as well as to eradicate the shortcomings that existed in the old system.

#### REFERENCES:

1. Decree of the President of the R. Uz. "On measures to further improve the field of information technology and communications" dated 19.02. 2018 g of .
2. Resolution Cabinet P . Uz. "On measures to radically improve and increase the efficiency of the training system at the Tashkent University of Information Technologies named after Muhammad al-Khwarizmi" dated 24.07 . 2018 g of .
3. Sagimbaeva G.S., Darvish O.B. Features of the training of future specialists in the conditions of the credit system of education (on the example of Kazakhstan) // Modern problems of science and education. - 2014. - No. 6.
4. Baidenko V.I. Bologna Process: Searching for Commonality of European Education Systems (TUNING Project). M., 2006.
5. Burtsev A.K., Zvonova V.A. The Bologna Process. Foundational materials. M., 2006.S. 29.
6. Bushin N.I., Druzhinina T.G. et al. Training of competitive specialists in the system of professional education. Ufa, 2003.
7. Grebennikova I.D. Innovative aspects of the modern educational process in the context of Russia's accession to the Bologna Convention // Legal Education and Science, 2007, N 1.
8. Majidov X., Mirzoev PP Independent work of students in the credit education system. // Questions of psychology and pedagogy, Kurgan-Tyubinsk State University. 2009. No. 3, pp.
9. Madzhidov X., Mirzoev PP, Tabarova M.A. Credit technology of education and the main factors affecting the improvement of the quality of training bachelors. / LHajik branch of the international academy of sciences of higher education, 2009, №2. p.
10. Obidov J. G. O. About safety technique and issues of supplying electricity of the textile industry //ACADEMICIA: An International Multidisciplinary Research Journal. – 2020. – T. 10. – №. 9. – С. 123-127.
11. Умаралиев, Н., Матбабаев, М. М., & Эргашев, К. М. (2020). УСТАНОВКА ДЛЯ ИЗУЧЕНИЯ ОПТОЭЛЕКТРОННОГО ДАТЧИКА ВЛАЖНОСТИ ВОЗДУХА. Известия высших учебных заведений. Приборостроение, 63(3).
12. Иброхимов, Ж. М. (2018). АСУ ТЕХНОЛОГИЧЕСКОГО ПРОЦЕССА НА ОСНОВЕ ИНТЕЛЛЕКТУАЛЬНОГО ОПТОЭЛЕКТРОННОГО СЕНСОРА. In Современные технологии в нефтегазовом деле-2018 (pp. 280-283).
13. Ibrokhimov, J. M. (2020). Application of the solar combined systems consisting of the field of flat and parabolocylindrical collecting channels for hot water supply of the industrial

factories. ACADEMICIA: AN INTERNATIONAL MULTIDISCIPLINARY RESEARCH JOURNAL, 10(12), 1293-1296.

14. Jamoldinovich, A. E. (2020). THE IMPORTANCE OF METROLOGY AND STANDARDIZATION TODAY Alikhonov Elmurod. INTERNATIONAL SCIENTIFIC AND TECHNICAL JOURNAL “INNOVATION TECHNICAL AND TECHNOLOGY”, 1(4), 1-3.

**Websites used:**

11. <https://www.indianjournals.com/ijor.aspx?target=ijor:aca&volume=10&issue=9&article=016>

12. <https://cyberleninka.ru/article/n/european-credit-system-of-education>

13. <https://scholar.google.com/scholar?oi=bibs&cluster=7336290608054849008&btnI=1&hl=ru>

14. <http://ferpi.uz/>





**ACADEMICIA**  
**An International**  
**Multidisciplinary**  
**Research Journal**  
 (Double Blind Refereed & Peer Reviewed Journal)



**DOI: 10.5958/2249-7137.2021.01237.4**

## ECOLOGIC AND ECONOMIC ASPECTS OF SOLVING THE WASTE PROBLEM

**D. M. Akhmedova\* ; T. Umarov\*\***

\*Associate Professor of Fergana State University,  
 Fergana, UZBEKISTAN

\*\*Master's Degree Student of Fergana State University,  
 Fergana, UZBEKISTAN

### ABSTRACT

*It is no secret that the weight of anthropogenic factors increases from year to year, depending on the level of human civilization, types and amounts of various waste elements in the environment, and the impact on nature is increasing day by day. However, it should be noted that before the rapid development of science and technology in the past, they did not feel the influence of environmental problems. This is because the waste from the Earth's environment undergoes natural self-cleaning processes. As a result, ecological harmony and balance in nature are not very disturbed. Basically, this was the case until the 19th century, when a "scientific and technological revolution" was observed in the development of human life and production. This article scientifically investigates the environmental and economic aspects of solving the waste problem.*

**KEYWORDS:** *Ecology, Nature, Waste, Technology, Ecological Problem, Environmental Protection, Natural Resource.*

### INTRODUCTION

Nature is a complex system that people and societies are its product. It exists and develops in exchange for nature. Man satisfies his needs at the expense of nature. It takes air, water, food, minerals and fuel from nature and influences nature throughout its life. As a result, new memorable objects for nature are being created. These include towns and villages, factories, roads, mines, reservoirs, agricultural land, and more. Such man-made landscapes, created by human intelligence and labor, have an impact on the environment. The rapid growth of the world population, the rapid development of science and technology, the uneven distribution of natural

resources on the territory of countries require the maximum use of available natural resources and thereby accelerate the development of society. As a result, the laws between nature and humanity are destroyed. Violation of these laws will sooner or later lead to an ecological crisis.

### **Main part**

Today, many people around the world are concerned about the state of the environment. An ecological catastrophe is taking place before our eyes. The issues of environmental protection and efficient use of available natural resources remain relevant. It became clear that man is the cause of the current ecological crisis and the one who can save him from this crisis with his own intellect. Protection of the environment from pollution and the use of natural resources largely depends on the level of environmental literacy and environmental culture of people, regardless of the society in which they live. Improving the environmental awareness of the population is one of the priority directions for solving environmental problems in our independent republic. It is especially important to teach the subject "Fundamentals of Ecology and Environmental Protection" at all stages of the education system.

Due to anthropogenic factors, especially at the later stages of the development of society, the quality and quantity of all living resources in the environment and on Earth change. Due to the growth in the production of semi-finished products, frozen and canned foods, they have recently been sold in special boxes, boxes, special containers, paper and cellophane bags. The packaging consists mainly of paper, glass, metal, cellophane and plastic. Most importantly, they cannot be reused. The population disposes of this waste in public landfills, especially in some areas where there are densely populated apartment buildings. This increases the amount of household waste. It is necessary to develop measures to correct this negative situation and change it for the better.

In this regard, the Decree of the President of the Republic of Uzbekistan dated April 21, 2017 No. PP 2916 "On measures to radically improve and develop the system for performing work related to household waste in 2017-2021." This decision is aimed at improving the sanitary and epidemiological situation in the regions and cities of the country, cardinal improvement and further development of the waste management system in 2017-2021.

### **DISCUSSION**

According to experts, the world's population consumes 1 ton of industrial and household waste per capita per year. In the Tashkent region, this figure is twice as high. Currently, the Almalyk Chemical Combine alone has accumulated over 60 million tons of waste. Of these, only 1% is spent on processing.

#### **Solid waste formation in Uzbekistan**

- Up to 10 - 12 thousand. tons of solid waste per day, 4.4 million tons per year.
- No. 45 - formed in Tashkent, Fergana and Samarkand regions.
- It is predicted that an additional 100 million tons will be formed in 2015-2030, which will reach 7 million tons per year by 2030.

#### **Recycling solid waste**

- ▶ There are 235 businesses. Capacity - 500.0 thousand tons per year. (11.2%)
- ▶ Processing of 88 polymers - 155.2 thousand tons.

- ▶ Processing 96 waste paper - 141.6 thousand tons.
- ▶ Recycling of 8 windows - 200.9 thousand tons.
- ▶ Processing of 23 tires - 0.9 thousand tons.
- ▶ 20 other waste

The Law of the Republic of Uzbekistan "On Waste" In the field of waste management on the territory of the Republic of Uzbekistan, prevention of harmful effects of waste on the life and health of citizens, the environment, waste generation and their rational use in economic activities.

The introduction of waste-free technological processes is a socio-economic problem, especially in chemical technology. This requires the selection and manufacture of the most optimal technological process available.

It is known that each household consumes different food items and a certain amount of waste (husks, seeds, etc.) is released from them. In rural areas, especially in households where pets (animals, birds, etc.) are kept, this waste is not disposed of, i.e. are passed on to pets for food. This, firstly, will save the environment, secondly, it will take care of pets, and thirdly, it will create additional funds in the family budget.

Unfortunately, in some areas where there are densely populated apartment buildings, the population dumps this waste in public landfills. In addition, the following measures can be taken to improve and reverse this negative situation in high-density areas. If we take the example of a single housing company, then about 20 apartment buildings will be connected to it. If each house has an average of 40 to 60 apartments, then the company will have 800-1200 apartments. Each household has an average of 3 people. A family consumes on average 2 kg of potatoes, 2 kg of carrots, 1 kg of onions and other products (melons, fruits, etc.) per week. Although these products produce an average of 0.5 kg of animal feed, it would be prudent to develop livestock farming as a subsidiary farm under the Homeowners' Association for efficient waste management. To do this, the homeowner's association will have to submit a business plan to the bank with which it has an account. A business plan may include the purchase of 10 or 20 head of cattle, the construction of buildings for their feeding and care, as well as the purchase of the necessary equipment, their distribution and distribution of various handouts. The Homeowners Association can take out a loan or loan based on this business plan and use the funds for their intended purpose. The Homeowners Association encourages each family and its members to actively participate in the implementation of the business plan.

If 0.5 kg of feed waste per household is 400 kg or 600 kg per week (0.5x800 or 1200), this feed waste is fed to livestock on a ration basis. Food waste is packed in special plastic containers, which the company distributes to each family and sends it to the Food Waste Collection Center. The representative of this center regularly organizes the collection of food waste. At the same time, as an additional feed, the enterprise can allocate the necessary land, plant alfalfa and corn, collect a certain amount of hay and grass. This event will contribute to the life and health of all types of waste, improve the environment, prevent waste generation, use it wisely in economic activities, achieve economic efficiency and, most importantly, further improve the spiritual, economic and environmental education of our people.

It was determined that for every 1000 kg of solid waste, thermal combustion is generated, which is generated by burning 250 kg of fuel oil. In terms of thermal capacity, 10.5 tons of municipal solid waste is equivalent to 1 ton of oil. Extraction of aluminum from recycled material saves only 5% of energy costs, 4 tons of bauxite ore from 1 ton of aluminum, saves 700 kg of coking coal, less than 35 kg of waste is emitted into the air, glass products from residues save 1.2 tons of primary product, energy savings 2,5%.

The main purpose of waste management is to increase the responsibility of producers and consumers. In this regard, the experts explained the role of waste management: "The production and disposal of waste should be regulated in such a way that they do not harm human health and do not restrict ecological products that are acceptable for use." It is based on preventive principles of environmental protection.

### CONCLUSION

All waste that affects the environment and entails economic costs must be recycled or disposed of. The more important it is to conserve resources through health and environmental protection and recycling, the higher the demand for its quality. Disposal of untreated waste is the lowest cost. This can have a significant impact later on.

In order to preserve the environment, toxic gases and emissions must be reduced and eliminated through the use of environmental protection measures and methods, rather than their generation.

### REFERENCES

1. Resolution of the President of the Republic of Uzbekistan dated April 21, 2017 No PP 2916 "On measures to radically improve and develop the system of implementation of works related to household waste in 2017-2021."
2. National report on the state of the environment and the use of natural resources in the Republic of Uzbekistan. Tashkent, 2013.
3. Yu.VNovikov, R.I Beknazov. "Man and the environment" Moscow, 1980.
4. A.Ergashev. General ecology Tashkent, 2003.
5. A.Ergashev, T.Ergashev. Ecology, biosphere and nature protection. Tashkent. New Generation, 2005.
6. Yuldashev C Kh., Nazarov M., Umarov U., "Influence of environmental factors on structure of cotton and its productivity." Tashkent, "Fan", 1976.
7. Zokirov T.C., "Ecology of cotton field".Tashkent, 1991.
8. Ibrahimov O., "Cotton fructification and its control factors". Tashkent, 1992
9. Akhmedova D., Nazarov M. Influence of environmental factors on bio-ecological features and its productivity".Ferghana, 2019.
10. P.Baratov. "Nature protection", Tashkent, 1991.
11. Abdurakhmonova, M. M., ugliMirzayev, M. A., Karimov, U. U., &Karimova, G. Y. (2021). Information Culture And Ethical Education In The Globalization Century. *The American Journal of Social Science and Education Innovations*, 3(03), 384-388.

12. Butaboev, M. T., & Karimov, U. U. (2020). «ЗЕЛЁНАЯ ЭКОНОМИКА». МИРОВОЙ ОПЫТ И ОСОБЕННОСТИ РАЗВИТИЯ В УЗБЕКИСТАНЕ. *Theoretical&AppliedScience*, (2), 704-710.
13. Бутабоев, М. Т., & Каримов, У. У. (2020). ПЕРЕХОД К «ЗЕЛЁНОЙ ЭКОНОМИКЕ» И ОСОБЕННОСТИ ЕЁ РАЗВИТИЯ В УЗБЕКИСТАНЕ. *Интернаука*, 23(152 часть 2), 41.
14. Каримов, У. У. (2017). РОЛЬ СРЕДСТВ МАССОВОЙ ИНФОРМАЦИИ В ПРОЦЕССЕ ГЛОБАЛИЗАЦИИ. In *Перспективные информационные технологии (ПИТ 2017)* (pp. 1189-1192).
15. T.A.Abduraximov, Z.A.Jabborov. “Problems of soil pollution and protection measures”, Tashkent, 2007.
16. Каримов, У., & Каримова, Г. (2018). ГЕОПОЛИТИЧЕСКАЯ КОНКУРЕНЦИЯ В ИНФОРМАЦИОННОМ ПРОСТРАНСТВЕ. In *Перспективные информационные технологии (ПИТ 2018)* (pp. 1368-1372).
17. Sh.Otaboev, M.Nabiev. Human and the biosphere. Tashkent, Teacher, 1995.

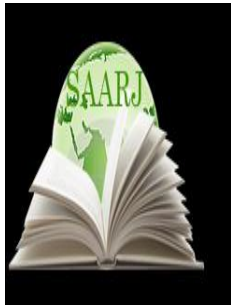

**ACADEMICIA**  
**An International  
 Multidisciplinary  
 Research Journal**  
 (Double Blind Refereed & Peer Reviewed Journal)



**DOI: 10.5958/2249-7137.2021.01238.6**

## THE IMPORTANCE OF “AL-FIQH AN-NOFE” IN SOLVING MODERN SOCIAL PROBLEMS

**Bekzodbek Muxtarov\***

\*PhD student at the chair of Islamic studies and,  
 International Islamic academy of Uzbekistan,  
 ISESCO chair for the study of Islamic Civilization,  
 Tashkent, UZBEKISTAN  
 Email id: b.muxtarov@iiu.uz

### ABSTRACT

*In today's globalization process, a state of rapprochement between different ideas and cultures around the world has emerged, resulting in the displacement of some cultures and customs from others, leading to the emergence of a single culture and ritual for humanity. The diversity in the culture of the world's population is disappearing and a single mass culture is emerging. This will negatively affect the future of countries with national and religious values in the world. In particular, attacks on Islamic culture and its manifestations have a serious impact on the lives and activities of Muslims. Therefore, the issues raised in the work of Nasiruddin Samarkandi "al-Fiqh an-nofe" play an important role in educating Muslim youth in the spirit of national and religious values, solving social problems in their lives.*

**KEYWORDS:** *Globalization, Social Issue, Samarkandi, Al-Fiqh An-Nofe, Source, Popular Culture, Moral Depravity, Dress Code.*

### INTRODUCTION

Every nation in the world has its own traditions, customs and national values. The spiritual values that have sprouted in a certain land, formed and refined for hundreds of years, are the priceless wealth of this nation, this people. In the rapidly evolving techniques and technologies of globalization, a deeper understanding of the nature of such wealth is essential.

At the same time, in the process of globalization, there is a proliferation of different ideas and views around the world. This process is especially active among young people and is reflected in their behavior. In particular, “Popular Culture” and its various manifestations are examples of

this. Spiritual and moral depravity, moral depravity, violence, individualism, egocentrism, indifference to national and spiritual values and the dangers of subverting them, the perception of immorality as a culture, disregard for original spiritual values, indifference to national and spiritual values in young people showing its negative impact on young people. These include virtual (computer) games, movies made in some foreign and private studios, low-level songs, the Internet and social networks, mobile phones, the yellow press, the urbanization process, false information, radio and television.

It is no coincidence that the problem of moral depravity has come to the fore in these manifestations of "popular culture". The analysis of these concepts leads to the following conclusions:

Moral depravity is the lowest human activity, gradually rising from the stage of "free love" to "same-sex marriage". He morally corrupted the youth and introduced adultery instead of the love that had been cherished for thousands of years. For example, "Today, 30 percent of women in the United States have at least two abortions before marriage, and girls are raised in the same spirit. The majority of voters will vote against any policy that interferes with such a lifestyle"[2]. In general, moral depravity first affects the family, and then it harms the purity of the offspring. However, in the East, the issue of family sanctity, generational purity is an important value. Regarding all kinds of immorality, the hadith states: "A believer does not have two qualities in common: one is greed and the other is malice" [1].

The content of violence is the transfer of one's domination over another. Violence violates the rights of the individual and embodies animal feelings and characteristics in his or her mind [7]. He said that today movies are promoted through computer games and various guides on the internet.

Individualism is a moral principle that expresses the individuality of human life, the absoluteness and autonomy of individual rights [3]. According to this idea, a person puts his own interests above the interests of others. The person must be an individualist. However, there is also a norm of individuality. Individualism is a contradictory form of community, which brings up the individual in a spirit of alienation from society, neighborliness, kinship, and community in general.

Egocentrism is the prioritization of the human self. The most troubling aspect of this is that such a person always considers himself to be right, to look down on others, to know that his actions are absolutely right, which is the main sign of egocentrism.

Another of the main manifestations of popular culture is that this person puts himself in non-human forms, changes his body parts, and completely denies the culture of dress.

### **The main part**

Although Nasiruddin Samarkandi's "al-Fiqh an-nofe" was written almost nine centuries ago, the social issues outlined in the book have not lost their relevance. In particular, the 23rd chapter (book) of the work is called "Production" - the book "Approved Works", which deals with the problems that arise in today's social life and their solutions. In particular, this section details the culture of dress, men's and women's clothing, and jewelry. In particular, this section emphasizes that it is not permissible for men to wear clothes made of silk, on the contrary, it is possible for women to wear clothes made of silk, which is an adornment for them [4: 887]. This is evidenced

by the hadith of the Prophet (peace and blessings of Allah be upon him): “It is haram for the men of my ummah to wear clothes made of silk and gold, and it is halal for the women of my ummah”.

He then goes on to describe the views of the sectarians on the use of the silk pillow. While Abu Hanifa allowed the use of silk pillows, his disciples Abu Yusuf and Imam Muhammad considered it makrooh for a man to use silk pillows [4: 888]. Abu Hanifa gave two reasons for allowing a man to use a silk pillow, the first being that there was no sign of clothing on the pillow, and the second being verse 32 of Surat al-A'raf: Say: proved.

Also in the next issue, Abu Yusuf and Imam Muhammad agreed that men's tight armor could be worn inside during the war on a tight garment made of silk - kimkhob (Kimkhob is a thick garment worn during war. It is worn inside an armor that protects the human chest and front body from bullets). Abu Hanifa, on the other hand, said that it was makruh [4: 888].

Based on the above considerations, it can be said that a man was advised to avoid clothes made of silk when wearing clothes. Because it is so gentle, it is intended to take men out of masculine qualities and negatively affect their character. It is emphasized that the dresses made of silk are suitable for the delicate nature of women and give them elegance and splendor.

Today, unfortunately, among young people who follow the "popular culture", there is a growing tendency to ignore national traditions in the choice of clothing, and to resort to Western-style clothing. This has led to the spread of inappropriate dress culture among members of the community as well as Western traditions. Therefore, educating the younger generation in the spirit of national and religious values is one of the important tasks facing society.

Another aspect of ‘popular culture’ is the wearing of jewelry of various shapes and forms. Their prevalence among men is contrary to national and religious values.

In “al-Fiqh an-nofe”, Samarkandiy mentions this, noting that men are forbidden to wear gold and silver jewelry, and women are allowed to do so [4: 889]. Also, men were only allowed to have a silver ring, belt (belt) and sword handle made of silver.

Wearing wedding rings made of gold, which is common in wedding ceremonies today, is also one of the cultures that has come from the west. In national and religious values, men are not allowed to wear gold rings. There was no such custom in marriage ceremonies either. But the custom of giving women gold and silver jewelry as dowry has been around for centuries, and scholars have allowed it.

During “Nofe”, Samarkand said that it was makruh for boys to wear silk clothes and gold jewelry, even when they were babies [4: 890]. In this way, the scientist meant that children should be brought up properly from an early age, and a child who has been brought up beautifully from an early age should not go astray even when he grows up.

But nowadays, among the young and old, such vices as adornment, luxury, and luxury are becoming more and more common in daily life and ceremonies. This is the result of their departure from national values and their blind imitation of other cultures.

This is also reflected in household items, guest utensils, and wedding utensils. According to religious values, doing so is a waste. It was returned from waste. Nasiruddin Samarkandi also mentions this in his book, saying that "It is not permissible for men and women to eat, drink,



smell and use utensils made of silver and gold" [4: 890]. This is evidenced by the words of the Prophet (peace and blessings of Allah be upon him) narrated by al-Bukhari and Imam Muslim: He also noted that it is permissible to use glassware, crystal and polished stoneware in Samarkand household items.

However, it can be used if the saddle and similar frequently used items are given a silver color. However, the scholar stated that it is makruh to pour gold and silver water on the mushaf of the Qur'an, and to cover the mushaf with gold or silver. To this, Abdullah ibn Mas'ud said, "Cleanse the Qur'an (from all kinds of gold and silver ornaments and sheaths). Do not clothe him with the clothes you wear".

This means that Samarkand not only forbids household items used by people, but also the Qur'an from being made of gold. Because all this is, firstly, a waste, and secondly, people can be proud of such things in front of others and lead to arrogance. Pride, on the other hand, leads people to evil.

During the topic, it was pointed out that it is permissible to use golden water to decorate mosques and draw various patterns on their walls, which would be to glorify the mosques, but it would be preferable to leave this work [4: 891-892].

Even today, the construction of mosques and their over-decoration is in full swing. But it is even more important to think about the actions in it and the upbringing of the people who pray in it. For this reason, mosques should be clean, tidy, light, free from useless hashams and patterns.

It is also a good deed to improve educational institutions or health care facilities and create appropriate conditions for people in them. In this regard, the ongoing beautification work in the country is an example of solving the most important tasks.

Nasiruddin Samarkandi in his book "Production" also mentions the use of animals. There is no harm in cutting animals so that they do not give birth. But he says that it is makruh to use them in service [4: 892].

In the age of modern medical science, scientists are conducting research on artificial insemination to improve animal reproduction. Livestock on many modern farms are being bred through artificial insemination. This was allowed by Islamic scholars. Only this process is required to occur in animals of the same sex. It has also been stated that it is not possible to inseminate an animal of the same sex naturally or artificially with an animal of the same sex.

One of the socio-economic issues raised in "al-Fiqh an-nofe" is the issue of "Ihtikar" - Monopoly. It is makruh for people to buy food on a daily basis, sell it at any price, or keep it at any price, and then artificially raise the price. The words of the Prophet (peace and blessings of Allah be upon him) narrated by Imam al-Hakim as evidence of this are cited as evidence:

Samarkandi said: "If the sultan (head of state) does this for the sake of the people, it is permissible" [4: 899]. Hence, it is permissible by the state or the head of state to control the sale of foodstuffs necessary for the daily needs of the people, to take measures not to artificially increase their prices in the interests of the majority of the people.

One of the approved trade practices in the work is the issue of selling fruit juices. The scientist noted that it is possible to sell fruit juices, that this work will replace intoxicating drinks, discourage people from consuming such drinks and quench their thirst [4: 901].

Also, at present, the trade in fruit trees is developing, and their sale is carried out internationally. In this case, traders have to pre-order the gardeners and buy a certain part of the ripening crop in advance.

This issue is mentioned in a separate book of "al-Fiqh an-nofe", "Musaqat - on the rent or purchase of a certain part of the fruit" [5: 1303]. Abu Hanifa said, "Musaqat is the renting of a part of the fruit of a tree, and it is void." Abu Yusuf and Imam Muhammad, on the other hand, said that it is permissible if its duration and amount of harvest are clearly defined. It's like likening to renting fruit. The musaqat says that it is permissible to use trees, grapes, dates and vegetables, and that if the harvest is more than the cut amount, it can be purchased. It is stated that if the conciliation agreement is terminated, then the party who terminated it will compensate the damage.

"Al-Fiqh an-Nofe"'s "Book on Hunting and Slaughter" describes the conditions and circumstances of the slaughter of animals that are consumed by humans, one of the social and domestic issues [4: 960]. In particular, Samarkandiy says that if he deliberately abandons the "tasmiiyah" during the slaughter, it is not permissible to eat what he has slaughtered. In this regard, the scholar cites verse 121 of Surat al-An'am: "Do not eat that which does not mention the name of Allah". Imam Shafi'i says that it is permissible to eat. This is evidenced by verse 3 of Surat al-Ma'ida. At the same time, Samarkandi says that if the butcher forgets to say the tasmiiyah at the slaughter, it can be eaten according to the union of scholars. When 'Abdullah ibn Mas'ud was asked about this, he was quoted as saying, "The name of Allah is in the heart of every Muslim." So, for the meat of a slaughtered animal to be halal, it must have been slaughtered in honor of Allah and in His name. In order for it to be correct to say "Bismillah" at slaughter, the following four conditions must be met:

The one who kills "Bismillah" himself;

Saying "Bismillah" with the intention of slaughtering;

Saying "Bismillah" or words in its meaning that glorify Allah, and refraining from uttering words with other meanings;

He must assign the Bismillah to the animal being slaughtered.

This section also mentions animals that can and cannot be eaten. It is makruh to eat zobb and lizard meat. Because the hyena is a beast. Imam Shafi'i said that it is not makruh to eat zob meat. This is evidenced by the fact that the Prophet (peace and blessings of Allah be upon him) ate zobb on his table. In addition to the Samarkand theme, he also considers the consumption of insects to be makrooh and quotes verse 157 of Surat al-A'raf.

Regarding the consumption of horse meat, it is narrated that Abu Hanifa said that it is makruh, and that his disciples Abu Yusuf and Imam Muhammad are not makruh. Samarkandi agrees that it is not makruh to eat horse meat here.

It is also said that there is no impediment to eating rabbit meat, but it is not permissible to eat the meat of humans and pigs (pigs). Of the aquatic animals, only fish and animals of this species can be eaten. The Prophet (peace and blessings of Allah be upon him) said: "We were given two deadly bodies and two bloods. Two dead fish and a locust, two blood livers and a blackbird". The variety of seafood dishes and their sale is expanding in the existing modern restaurants. This

leads people to ask questions on this issue. The issues outlined above play an important role in answering these questions and preventing misunderstandings.

Today, some misguided groups visit graves and forbid the people of the graves from reciting the Qur'an. They claim that such acts are heresy and do not reward the pilgrimage and recitation of the deceased. Nasiruddin Samarkandi has touched upon this issue in his work "al-Multaqot". The scholar said, "It is permissible to visit graves. Once a week the graves are visited with the aim of blessing them. When he enters the cemetery, he greets the people of the grave. He prays for them by asking Allah for goodness, forgiveness and mercy" [6:52]. The scholars of Ahlas-Sunnah unanimously allowed visiting the graves [6:62]. In particular, reports of visiting graves on Friday or the day before or the day after were mentioned. It is also makruh to sleep in the grave and pray there. sitting on the grave is forbidden from climbing on it. During a visit to the grave, he is said to have walked around it.

The Hanafi scholars have stated that it is not makruh to recite the Qur'an at the grave [6: 448]. At the same time, hadiths have been narrated during the pilgrimage to recite Surahs "Ayatul Kursi", "Ikhlas" and "Fatiha". This has been proven to benefit and benefit the people of the grave.

## CONCLUSION

The social issues mentioned in Samarkandi's "al-Fiqh an-nofe" and other works of jurisprudence are a source of special attention not only for their time, but also for finding solutions to some of the problems that exist today and preventing conflicts and heresies. One of the main tasks of the research is to reveal the role of "al-Fiqh an-nofe" in finding answers to social problems that arise in society today. Issues such as "men's and women's dress code", "use of silk fabric", "use of gold and silver jewelry, utensils", "decoration of mosques", "decoration of the Qur'an with gold water" described in the book "Istehsan" And its negative impact on the education of young people and their prevention in the book "On hunting and slaughter "Animal consumption" plays an important role in answering the questions that arise in social life.

## REFERENCES:

1. Hadiths about morality. - Tashkent: Movarounnahr, 1992. – P. 16.
2. Byukenen P. Smert Zapada. - Moscow: Gardariki. 2004. – P. 16.
3. Nazarov Q. Encyclopedic Dictionary of Philosophy. - Tashkent: Sharq, 2004. – P. 89.
4. Nasiruddin Muhammad ibn Yusuf Samarkandi. Al-Fiqh an-nofe. - Ar-Riyaz: Maktaba al-abikon, 2000. - J 2. – 440 p.
5. Nasiruddin Muhammad ibn Yusuf Samarkandi. Al-Fiqh an-nofe. - Ar-Riyaz: Maktaba al-abikon, 2000. - J 3. – 600 p.
6. Nosiruddin Muhammad ibn Yusuf Samarkandi. Al-Multaqot fi al-fatovo al-hanafiyya. - Beirut, Lebanon: Dor al-kutub al-ilmiyya, 2000. –488 p.
7. Shaginskaya E.N. Mass culture of the XX century: essay theory. – Moscow: 2000. – p. 20.

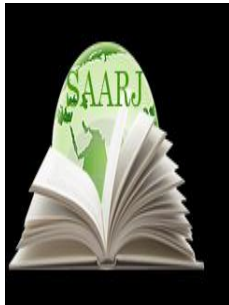

**ACADEMICIA**  
**An International  
Multidisciplinary  
Research Journal**  
(Double Blind Refereed & Peer Reviewed Journal)



DOI: **10.5958/2249-7137.2021.01239.8**

## MODERNIZATION OF INDUSTRIAL COMPRESSORS BASED ON MODERN AUTOMATION TOOLS

**Abduraxmonov Sultanali Mukkaramovich\***; **Sayitov Shavkatjon Samiddin ugli\*\***;  
**Khasanov Ulugbek Shamilevich\*\*\***; **Karabayev Fazdindin Sirojiddinovich\*\*\*\***

\*Associate Professor,  
Tashkent University of Information Technologies named after Muhammad al Khwarizmi,  
UZBEKISTAN

\*\*Assistant,  
Fergana Polytechnic Institute,  
UZBEKISTAN

\*\*\*Master Student  
Fergana Polytechnic Institute,  
UZBEKISTAN

\*\*\*\*Master Student,  
Fergana Polytechnic Institute,  
UZBEKISTAN

---

### ABSTRACT

*Modern compressors are built mainly by their computer-based automatic control systems that meet modern energy-saving requirements. Computer controls ensuring the safety of the equipment operation creates the conditions for saving energy.*

**KEYWORDS:** *Electrical Energy, Computer Controls, Discrete Signals, Conversion Of Analog, Regulator, Compressor.*

---

### INTRODUCTION

A compressor is an industrial equipment that is designed to compress gases, increase pressure and further supply compressed gas to the consumption of technological processes. The tasks in this case can be different from meeting the need for high-pressure compressed air to increasing the pressure in order to separate (dehumidify) the gas. Industrial compressors are used in many

industries and in various technological processes. Because the compressor is a rather complex and expensive equipment, with a large consumption of electrical energy [1].

Modern compressors are built mainly by their computer-based automatic control systems that meet modern energy-saving requirements. But many industrial enterprises use compressor machines built according to the projects of the 90s, which did not have computer control. Computer controls ensuring the safety of the equipment operation creates the conditions for saving energy.

Replacing these compressors with a new automated one requires a large financial cost. Therefore, the modernization of compressors based on elements of modern computer automation is relevant. We have developed modern automated control systems for compressor units based on multi-level automation systems built on the basis of industrial controllers, operator panels and operator workstations[2,3].

The constructed system is a two-level system consisting of a first-level system implemented on microprocessor-based meters-regulators, remote access modules, and a second-level system implemented on an industrial computer.

The first-level system includes:

- Subsystem for collecting, displaying and converting information; implementations of control actions.

The first of the subsystems performs: - collection, conversion of analog and discrete signals from the object; control of the reliability of the input analog information; - generates discrete signals (signs) of channel malfunction; measurement of input signals and output beyond the limits of the specified parameters.

- blocking the operation of the compressor according to certain parameters.

The second subsystem of the first level performs the calculation, checks for restrictions and implements the calculated control actions on the executive mechanisms of regulatory bodies.

The second-level system includes:

- subsystem for collecting and processing and storing information;

- subsystem for diagnostics of the state of the main equipment and situational control of the technical process;

- subsystem for adapting the coefficients of regulators and filtration coefficients;

The second-level information collection and processing subsystem collects analog and discrete information from the ADC and DAC modules, as well as information entered by the operator from the keyboard, filters and checks the reliability of the input information.

The subsystem of diagnostics of the state of the main equipment and situational control of the technological process of the second level is designed to recognize with a certain degree of confidence situations of shutdown of the main equipment and the state of the technological process with the issuance of recommendations on the virtual structure of the control circuits.

The subsystem of adjustment of coefficients of regulators on the basis of the analysis of dynamics of transients on channels:" the regulated variable - the position of the regulating body "

carries out adjustment of tuning coefficients of regulators, and on the basis of the analysis of behavior of current values of analog parameters, carries out adjustment of coefficients of filtration.

The information representation subsystem is designed to implement a set of functions of the driver-operator dialogue with a personal computer. Information exchange between subsystems should be carried out through a system-wide information base. The operating mode of the system is continuous, three-shift.

The developed system is implemented for the modernization of the compressor 2VM2 .5-12/9.



**Fig 1. Compressor 2VM2, 5-12 / 9**

The compressor 2VM2. 5-12 / 9 is a horizontal, crosshead, piston compressor of two-stage compression, made on the opposite base M2, 5.

Complete set of the compressor 2VM2, 5-12/9 2VM-2,5-12/9 - all compressors are supplied with 2VM2. 5-12 / 9 electric motors, intermediate and end refrigerators.

Intermediate gas coolers are located above the compressor cylinders. The end gas cooler is installed on the foundation near the compressor. The 2VM air piston compressor with cylinder and oil seal lubrication is used in almost all industries where compressed air is not subject to strict cleanliness requirements. They are designed for the supply of compressed air as an energy carrier in construction works, coal and ore mining, tunneling, transportation of bulk products, in the drives of automation systems, pneumatic machines and equipment, etc.

Modular reciprocating air compressor units 2VM are mounted on a single supporting frame in factory readiness. The compressor 2VM2. 5-12 / 9 is driven by an asynchronous electric motor.

Technical characteristics of the compressor:

Compressible gas	Air	
Motor shaft speed, rpm	750	375
Capacity,	27	13,5
according to the suction conditions, m <sup>3</sup> / min Initial	Atmospheric pressure	
pressure, atm Final	9	
pressure, atm	130	130
Flow rate ohl. water without end cooler (inlet +15°C), l / min Oil	96	
Amount of oil to be poured into the compressor frame, l	100	

Compressor	
weight, kg	3920
Type	A2K 85/24-8/16 УХЛ4
Power, kW	160/75
Voltage, V Installation	380
weight in the scope of delivery, kg	5000
Overall dimensions of the installation, mm	3000×1485×2100

The newly developed automated control system "Compressor" has special mnemonic circuits that control and control the operation of the compressor[4]:

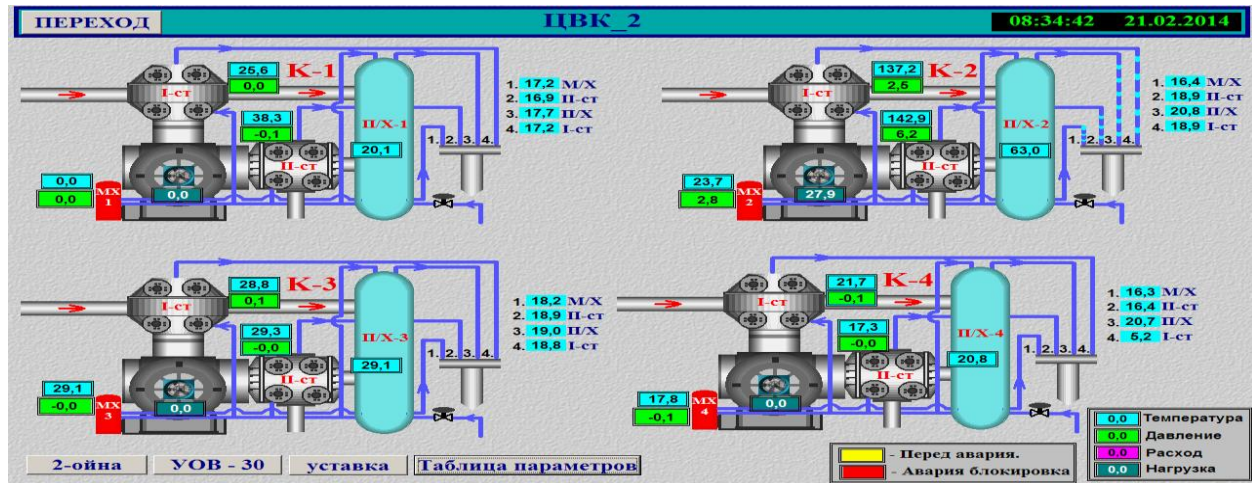

Fig. 2 The main mnemonic diagram.

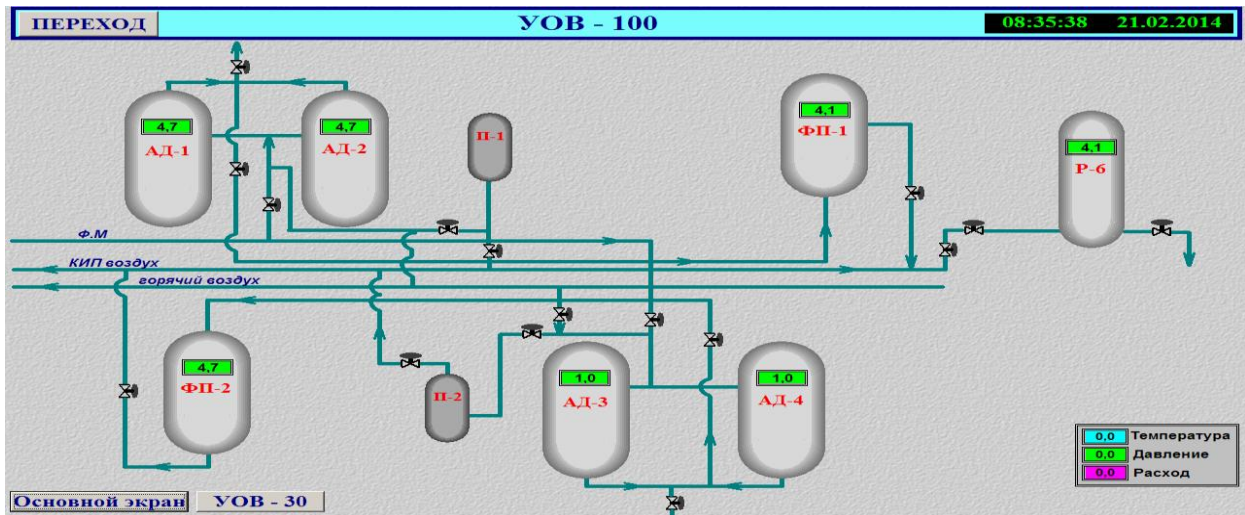

Fig. 3. Mnemonic diagram of the drying and compressed air supply technology.

ПЕРЕХОД		ЦВК_2				08:36:01 21.02.2014			
№	Компрессор 1 П.ЛК73	уставка	дис.сиг	показ	№	Компрессор 2 П.ЛК73	уставка	дис.сиг	показ
1.	К-1 температура масла	73,0	0,0	00000	1.	К-2 температура масла	73,0	0,0	27,2
2.	К-1 температура I-ступен	173,0	0,0	17,9	2.	К-2 температура I-ступен	173,0	0,0	141,0
3.	К-1 температура II-ступен	173,0	0,0	30,8	3.	К-2 температура II-ступен	173,0	0,0	146,4
4.	К-1 температура п.пром хол	73,0	1,0	24,5	4.	К-2 температура п.пром хол	73,0	0,0	66,5
5.	К-1 давление I-ступен	2,7	0,0	0,0	5.	К-2 давление I-ступен	2,7	0,0	2,4
6.	К-1 давление II-ступен	8,2	0,0	-0,1	6.	К-2 давление II-ступен	8,2	0,0	6,2
7.	К-1 давление масла	1,0	0,0	-0,0	7.	К-2 давление масла	1,0	0,0	2,8
№	Компрессор 3 П.ЛК73	уставка	дис.сиг	показ	№	Компрессор 4 П.ЛК73	уставка	дис.сиг	показ
1.	К-3 температура масла	73,0	0,0	23,3	1.	К-4 температура масла	73,0	0,0	17,7
2.	К-3 температура I-ступен	173,0	0,0	23,1	2.	К-4 температура I-ступен	173,0	0,0	21,4
3.	К-3 температура II-ступен	173,0	0,0	23,6	3.	К-4 температура II-ступен	173,0	0,0	16,5
4.	К-3 температура п.пром хол	73,0	0,0	23,4	4.	К-4 температура п.пром хол	73,0	0,0	20,8
5.	К-3 давление I-ступен	2,7	0,0	0,1	5.	К-4 давление I-ступен	2,7	0,0	-0,1
6.	К-3 давление II-ступен	8,2	0,0	-0,0	6.	К-4 давление II-ступен	8,2	0,0	0,0
7.	К-3 давление масла	1,0	0,0	-0,0	7.	К-4 давление масла	1,0	0,0	0,0
Основной экран		Таблица каналов		уставка_2					

Fig. 4. Mnemonic display of technological parameters

## CONCLUSION

We have developed a system that reduces the human impact on the operation of the compressor and optimizes the operation. The implementation of the system is achieved by saving electrical energy by 20 %.

The upper level of the automated control system "Compressor" is developed on the instrumental software package Trace Mode and is universal for use in other types of compressors.

## REFERENCES:

1. Воронецкий А. В. Современные центробежные компрессоры. — М.: Премиум Инжиниринг, 2007. — 140 с
2. 2. Аллаяров О.Н., Сургучев А.В., Чеботарев С.М., ., Абдурахмонов С.М., Хен В.П. «Автоматизированная система управления технологическим процессом выпуска стеклосуды на базе TRACE MODE». Журнал Приборы и системы. Управление, Контроль, Диагностика, 2003 г. (Россия), №6, стр. 20-21.,
3. Аллаяров О.Н., Сургучев А.В., Абдурахмонов С.М., Хен В.П. «АСУТП станции защитных атмосфер» Журнал Приборы и системы. Управление, Контроль, Диагностика, 2003 г. (Россия), №8, стр. 15-16.
4. С.М. Абдурахмонов, Н.М. Жураев, З.Ш. Халилов. ИШЛАБ ЧИКАРИШ КОРХОНАЛАРИНИ ЗАМОНАВИЙ КУРИЛМАЛАР АСОСИДА МОДЕРНИЗАЦИЯЛАШ., МАШИНАСОЗЛИКДА ЗАМОНАВИЙ МАТЕРИАЛЛАР,



- ТЕХНИКА ВА ТЕХНОЛОГИЯЛАР. Халқаро илмий- техникавий анжуман Туплами. Андижон, апрель, 2016. стр. 519-521
5. Khmonov S. M., Sayitov S. S. Smart traffic light technology //ACADEMICIA: An International Multidisciplinary Research Journal. – 2020. – Т. 10. – №. 11. – С. 1309-1313.
  6. Mukaramovich A. S., Samidinugli S. S., Anvarovich T. A. About automated measuring systems in the production of bulk products //ACADEMICIA: An International Multidisciplinary Research Journal. – 2020. – Т. 10. – №. 10. – С. 1299-1304.
  7. Хмадалиев Ў. А., Сайитов Ш. С. У. Контроллер заряда аккумуляторной батареи позволяющий уменьшить количество солнечных панелей //Universum: технические науки. – 2018. – №. 2 (47).
  8. акимов М. Ф., Тожибоев А. К., Сайитов Ш. С. СПОСОБЫ ПОВЫШЕНИЯ ЭНЕРГЕТИЧЕСКОЙ ЭФФЕКТИВНОСТИ АВТОМАТИЗИРОВАННОЙ СОЛНЕЧНОЙ УСТАНОВКИ //Актуальная наука. – 2019. – №. 11. – С. 29-33.
  9. Сайитов Ш. С. и др. НОВАЯ КОНСТРУКЦИЯ ДЛЯ ПАЙКИ ТЕРМИНАЛА СИСТЕМЫ ПОДОГРЕВА ЗАДНЕГО СТЕКЛА АВТОМОБИЛЯ //Актуальная наука. – 2019. – №. 9. – С. 22-27.
  10. Mamasodikov Y., Qipchaqova G. M. Optical and radiation techniques operational control of the cocoon and their evaluation //ACADEMICIA: An International Multidisciplinary Research Journal. – 2020. – Т. 10. – №. 5. – С. 1581-1590.

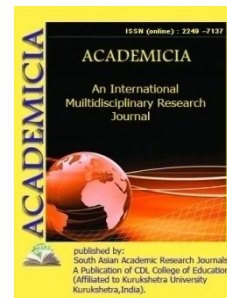
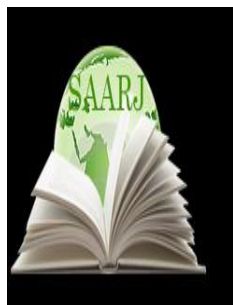

DOI: **10.5958/2249-7137.2021.01240.4**

## THEORY AND PROBLEMS OF RUSSIAN LANGUAGE TRANSLATION IN THE FIELD OF TECHNOLOGY

**Parpieva Makhsudakhon Makhmudjonovna\***

\*Senior Lecturer

Department of Uzbek Language and Literature,  
Fergana Polytechnic Institute,  
UZBEKISTAN

### ABSTRACT

*Due to the rapid development of modern technologies, the translation of scientific and technical terminology is particularly relevant in recent years. Today, scientific and technical translation is not only a type of translation activity, but also a separate applied discipline. And the main task of scientific and technical translation is a brief and accurate presentation of the information and the absence of errors. without any emotional coloring. Moreover, one of the goals is also to create an electronic dictionary that would be able to include multi-component terminology that is applicable in narrower, less studied areas of knowledge. A separate item examines the features of automated translation programs, the selection and analysis of four-component terms, and the frequency of their use. Use in the studied texts, as well as their verification for the presence of a pro -7 message in the text.*

**KEYWORDS:** *Search For An Algorithm, Dictionary, Research Materials, Methods, Structure, Multicomponent Terms, Vocabulary.*

### INTRODUCTION

A distinctive feature of scientific and technical texts is the abundance of terms and various phrases, formulas, graphs, the translation of which can cause a number of difficulties. And the main task of scientific and technical translation is a brief and accurate presentation of the information and the absence of errors. without any emotional coloring. Due to the rapid development of technology, new terms (neologisms) are constantly appearing in the scientific language, which even the latest dictionary does not have time to fix, which also presents great difficulties in translation.

Thus, the relevance of our work is determined by the lack of knowledge of the translation of terminology from Russian into English, especially on the material of such narrow areas of knowledge as opt informatics. The relevance of our research work is also due to the increasing role of the importance of adequate translation of scientific terminology.

The object of the research is scientific and technical terminology and multicomponent terms. The subject of the research is the peculiarities and difficulties of translation of scientific and technical texts in general, and terminology in particular.

As for the purpose of this work, it can be defined as the identification of difficulties encountered in the translation of scientific and technical terminology. Moreover, one of the goals is also to create an electronic dictionary that would be able to include multi-component terminology that is applicable in narrower, less studied areas of knowledge. In accordance with the purpose of the work, the following 5 tasks were formulated, the solution of which is aimed at a comprehensive disclosure of the topic and achieving the goal:

1. Introduction to the basic concepts of the scientific and technical field
2. Selection of materials and tools for analysis and research
3. Extraction of multicomponent terms for further research
4. Search for an algorithm and build a translation hypothesis for translation
5. Creating a dictionary

The theoretical significance of my work is due to the importance of research and study of the specifics of the translation of scientific and technical terminology.

As for the practical significance, it consists in the fact that sometimes a translator has to deal with scientific and technical terms, and at the same time with the difficulties of technical translation, without the knowledge of which you can make many mistakes, even if you are proficient in a foreign language. In this regard, this research paper can be a good guide to the translation of terms of varying degrees of complexity.

Russian – Russian and Russian – English terminological technical dictionaries, as well as scientific and technical texts, were used as research materials. In the practical part, the body of the text is considered, which includes annotations to articles of a scientific and technical nature, and in particular, opt informatics.

To perform all the tasks of my work, the following methods were used:

1. Structural analysis;
2. Statistical Analysis;
3. Identification of technical terminology features;
4. Comparative translation method.

The scientific novelty of my thesis is that due to technological progress, more and more terms in various fields of knowledge appear every day, and the need to develop a clear algorithm for translating scientific terminology is growing.

Moreover, multicomponent terms have not previously been considered in the texts of scientific and technical literature in such detail, which once again confirms the need to develop a clear algorithm for their translation.

Our research work is aimed at identifying the difficulties in translation of scientific and technical terminology from Russian into English.

The structure of this thesis is presented as follows: table of contents, introduction, theoretical and practical research, conclusion, bibliography, and appendix. The list of references contains 30 sources.

In the first chapter, we consider the main concepts related to translation, the style of the text, especially of a scientific and technical nature, as well as the difficulties that may arise when translating them. Special attention is paid to such concepts as term and terminology, which are key to our work. Further, various classifications of scientific and technical terms and resources used by the specialist in the translation of terminology are considered.

The second chapter is aimed at proving the relevance of the problems of translating scientific and technical terminology based on opt informatics, since the chosen field of knowledge is important for research due to its lack of knowledge and, accordingly, the problems that arise for the translator with terminology of this nature. The next section examines the body of text from which multicomponent terms are extracted. A separate item examines the features of automated translation programs, the selection and analysis of four-component terms, and the frequency of their use. Use in the studied texts, as well as their verification for the presence of a pro -7 message in the text. An important section is the introduction to the translation algorithm of multicomponent terms, which can be a good helper for students and translators in specialized fields of knowledge.

In this paper, we are dealing with the translation of texts of scientific and technical style. In this regard, it is necessary to find out what the style is, what the texts of this topic are and what features they have.

A language style is a collection of language tools. The style of scientific and technical literature, in turn, is distinguished by the presence of special characteristics.

First, it's the vocabulary. In scientific and technical texts, special terms are used, which are selected in accordance with the field of knowledge to which a particular text belongs in order to accurately convey the idea.

As for grammar, scientific and technical texts abound in the use of passive, impersonal, and vaguely personal constructions.

Most of the sentences are compound and compound sentences. Consequently, the language of scientific and technical style is widely used conjunctions, compound prepositions, and various phrases. In addition, it is worth noting that the author of the text, trying to convey information and explain those or other facts, discoveries, processes, avoids the personal forms of the verb, replacing them with the 10 passive voice. In this regard, it becomes obvious that all the processes and phenomena in the text act as subjects, while overshadowing the author of the text.

The style of presentation of information. The main feature of the scientific and technical text is the brevity of the presentation of the material and the clarity of the wording.

---

Zhidkov A.V., in turn, identifies the following features of the style of scientific and technical translation: strict consistency and consistency of all components of the idea presented by the author, the content of the text, the availability of a specialist in a particular field in terms of understanding the information presented, as well as the statement of scientific fact.

Having found out what the style of scientific and technical texts is, we should proceed to the definition of scientific and technical translation.

In this paper, the problems of translation of scientific and technical terms were considered, among which the problems of translation of multicomponent terminology were of particular interest.

To date, issues related to the translation of scientific and technical literature are of great interest to specialists.

The first chapter is completely devoted to the consideration of such concepts as translation, scientific and technical translation, terminology and terminology. We paid special attention to the peculiarities of scientific and technical texts in terms of vocabulary, grammar and style of presentation of information.

#### REFERENCES:

1. Ахметова, Г. Д. Некоторые сложности перевода английских технических терминов / Г. Д. Ахметова // Молодой ученый. Ежемесячный научный журнал. – 2015. – №4(84). – М. : ООО «Издательство Молодой ученый», 2015. – 15 с
2. Бархударов, Л. С. Язык и перевод (Вопросы общей и частной теории перевода) / Л. С. Бархударов. – М. : «Международ. отношения», 1975. – 240 с
3. Нишонов У. И. Билингвизм и его использование в обучении //Достижения науки и образования. – 2018. – №. 15 (37).
4. Парпиева М. М., Нишонов У. И. Интеграция интерактивных методов в процессе образования //Вестник науки и образования. – 2019. – №. 19-2 (73).
5. Нишонов У. И., Парпиева М. М. Лингвистические проблемы перевода: текст как объект переводческой деятельности //Проблемы современной науки и образования. – 2019. – №. 11-2 (144).
6. Нишонов У. И. Методы обучения как компонент учебного процесса в национальных группах //Вопросы науки и образования. – 2018. – №. 7 (19).
7. Парпиева М. М. Самостоятельные задания поискового и творческого характера как способ активизации деятельности на уроках русского языка //Достижения науки и образования. – 2018. – №. 16 (38).
8. Парпиева М. М. Информационно-коммуникационные технологии в процессе обучения русскому языку как неродному //Вопросы науки и образования. – 2018. – №. 7 (19).
9. Парпиева М. М. УПРАВЛЕНИЕ ОБРАЗОВАНИЕМ КАК ОТРАСЛЬ НАУЧНОГО ЗНАНИЯ И ПРАКТИКИ //Качество высшего и профессионального образования в постиндустриальную эпоху: сущность, обеспечение, проблемы. – 2016. – С. 224-228.
10. Парпиева М. М., Исраилова С. М., Мадумарова М. Д. Преимущества применения ИКТ (информационно-коммуникационных технологий) на уроках русского языка //Наука, техника и образование. – 2019. – №. 5 (58).

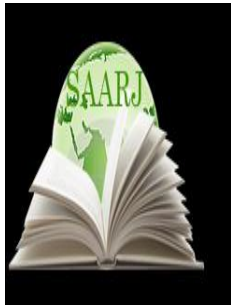

**ACADEMICIA**  
**An International  
 Multidisciplinary  
 Research Journal**  
 (Double Blind Refereed & Peer Reviewed Journal)



**DOI: 10.5958/2249-7137.2021.01241.6**

**METHODOLOGICAL RECOMMENDATIONS FOR THE ACTIVITIES  
 OF THE CENTERS FOR EDUCATORS OF PRE-SCHOOL  
 EDUCATIONAL ORGANIZATIONS**

**Abdukarimova Maftuna\***

\*Master Student,  
 Andijan State University,  
 UZBEKISTAN

**ABSTRACT**

*In this article, a number of methodological recommendations and proposals on the activities of the Centers of activity developed on the basis of the state requirements for the development of children of primary and preschool age, the state program "first step" and the features of the development of children for age are presented. During the 4th week of January with the children of a large group of MTT, on the basis of the theme "Alphabet of sobriety", the methodical recommendations and conclusions that gave positive results in the test of practical experience on language and Speech, Art, construction, constructivism and Mathematics, Science and nature, Games and staging centers, didactic games and their use in the process.*

**KEYWORDS:** *Development, Knowledge, Skills, Qualifications, Didactic Play, Creative Side-Play, Geometrical Figures, Methodology, Methodological Recommendation.*

**INTRODUCTION**

While we live in a civilized age of Science and technology, the indicators of Child Development and mental growth are also growing day by day. All developed countries want young people to take an active part in the life of society and the country and open the doors to all the necessary opportunities for this. In particular, in our state, all the necessary conditions are created for the growth of the younger generation. In the decree of our President SH.Mirziyoyev "on the strategy of Action for the further development of the Republic of Uzbekistan" "to educate young people who are healthy, spiritually and mentally developed, think independently, are loyal to the motherland, have a firm life outlook" the fact that it is defined as an important task means that the problem of youth education is one of the most priority issues of the country's policy. New technologies and innovations, a number of methods and tools are being developed in each area

every day and hour. In particular, in the field of pre-school education, radical reforms are carried out in recent years. The establishment of the Ministry of pre-school education, the development of the state program “first step”, the introduction of a number of new legislation into the education system show positive indicators of quality efficiency in every sphere.

Creation of new methodical and educational tools, introduction of modern technologies, we also achieve achievements in education and training through the development of new pedagogical technologies and techniques that will be used in creative, didactic, staged and building-building games. These bring a number of convenience to educators and educators. Due to their pedagogical skills and individual characteristics of children, the issue of co-operation, the need to develop new methods of training are entrusted to them. 2-th principle of the Convention on the rights of the child- it is necessary for children to develop their abilities more broadly. That is, the laws of obtaining knowledge, entertainment, recreation, cultural activities, information are laws. After all, with reasonable use of all created opportunities and conditions, the education and upbringing of worthy heirs to ancestors depends on educators.

In this regard, I would also like to pass my methodological recommendations for the kata group Educators of the organization conducting research on the topic “Alphabet of sobriety” on the 4th week of January, which received a positive result, based on the state requirements and the requirements of the state program “first step”.

Age group: large group.

Month: January.

Moon blue: the joy of winter.

4 Week theme: Alphabet of sobriety.

The general purpose of the activities of the centers: to create an understanding and imagination about the fertility of the winter season itself, Entertainment and the charm of the holidays.

To teach politeness, decency, culture of treatment, non-application of words, listening in the process of communication, synthesis of analysis of words, Statement of perceived thought in the literary language in accordance with the culture of speech. To be cultured in communicating with the surrounding people, to form independent thinking skills on the basis of integrated education. Within the framework of the activities of each center “to form knowledge, skills and skills pertaining to” sobriety.

### **Language and Speech Center**

The purpose of the center: to increase the vocabulary of educators, to create the skills of communication on the basis of literary language norms, to develop skills of cultural listening and recounting.

Necessary equipment: prepared in advance for the Center, ”sweet word sister”, ”the boy with decency” poem passage.

The activity of the center begins with a story telling:

“Sweet word sister”

Since there are gardens with many amenities, beautiful apart from the resort, which has gone from the wisdom of the drag that the carefree and independent mother Uzbekistan. Among such kindergartens there is a 23-th kindergarten, which is distinguished from other kindergartens by its children with wrists, whims and decency. The children here are distinguished from other kindergarten children by their own conversational manners, culture of dressing, exemplary behavior. Among the children in this kindergarten there are sisters named Shahrizoda and Bibifotima. The sisters are very polite, wash their hands away when they wake up early, to their parents “Assalomu - alaykum” as long as the girls say. Speaking of parents, “Labbay replied that”, “Hop is”.

One day a neighbor named Kadirjon, who does not want to go to their house to the kindergarten, when adults say, “No, no, no, no”, does not want to say hello, does not want to listen to his mother's words, came to the guest. The sisters met him as a welcome Kadirjon with a good mood and invited him to dinner at the table. As soon as Kadirjon sat down at the table, he stretched out his hand to eat. Then Shahrizoda: Kadirjon to eat first an adult hand stretches, and then after they give permission, we begin to eat. We washed our hands, you did not wash. He said that we should wash our hands before and after eating. Sisters learned in kindergarten after having had dinner “the poem “ boy with decency:

Kattalarga hurmatda,  
Kichiklarga izzatda.  
Odobli bola har gal,  
Assalom: der albatta.  
Do'stlariga qadirton,  
Jonvorlarga mehribon.  
Tovuqlarga berar don,  
Odob-ahloqli bola.  
Xonalari ozoda,  
Kiyimlari top-toza,  
Charchamas o'qib- yoza,  
Odob ahloqli bola.  
Erta tong turar barvaqt,  
O'ynar telefonmas shahmat.  
Ota-onangga rahmat,  
Odob-ahloqli bola.  
Sport bo'lsin yo'ldoshing,  
Kitob esa sirdoshing,  
Fahrlantir yurtboshing,





Odob-ahloqli bola.

deb aytib berishibdi.

Having heard the poem, Kadirjon was born of his masculine and evil spirit, which greatly upset his mother. He wants to throw out his bad habits. When he returned home to his mother: tomorrow I will also go to the kindergarten sister Shahrizoda and Bibifotima DEC said beautiful words, I rejoice you, ask his mother to forgive me. Kadirjon was very pleased with the fact that his mother changed her son, and gave him a gift from the book of fairy tales kata.

Expected result: to teach the educators the words that denote the positive feelings involved in the story and in the poem. Children's interpersonal and free-thinking skills to find content. To achieve the effectiveness of educator and Parent cooperation.

### The curse Center

The goal of the center: to shape the drawing skills of Educators, based on their own interests and abilities, tactfully imagining a good mood. Distinguish colors that represent a bright excellent mood, delight them on the basis of drawings on the basis of drawings. Develop fine hand matting movement.

Necessary equipment: White Paper of A4 size, black and colored pencils, various smileys, watercolor paints, a picture depicting a water vessel, a moose pencil and a smiling sun.



Activities of the center: the educator first creates an imagination in the educators on the subject of sobriety. Laugh, be polite, tidy will tell the children the pleasant aspects. Exercise doskasigi using the image of the sun, they depict a picture of the sun, which came out of their imagination and laughed, sad and crying. the educator gives the children the right training in the use of colors, they monitor their activities and help the children. From smileys, which represent a different mood in the process of drawing children they use it.

All children's drawings are analyzed at the end of the activity and children are encouraged positively.

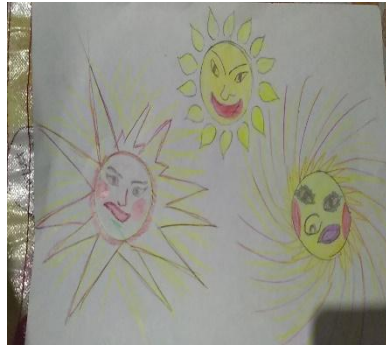

Recommendations: “through smileys on the basis of the theme of” sobriety “laughing”, “upset”, “pumpkin pals”, “angry”, “crying”, setting up a corner representing the mood in general. Form the skill of drawing on the basis of imagination. Smileys that express the mood



### Center for construction, construction and mathematics

The purpose of the center: to teach educators to make a paravoz on the basis of geometric figures ( circle, square, rectangle, triangle, oval). Make accurate and reverse counting skills up to 1-9. In children, by playing our cheerful paravoz ' didactic game, correctly correlate their creativeness regarding how to construct them.

Necessary equipment: scissors, glue, colored cardboard paper, black and colored pencils, „a colorful picture with a cheerful image.

Activities of the center: at the beginning of the activity, the educator mentions the use of careful equipment. Repeating the name of each of the geometrical figures, they make a cheerful paravoz of the group with their participation. Picked up the paravoz from different colored cartons, wheels, relays, 9 carriages , eyes, eyebrows and mouth after clapping, the image of” cheerful paravoz " is combined on the basis of a worn image. In the process of this activity, the educator supervises and assists the children. After that, our cheerful paravoz” plays didactic game.

Bizning quvnoq paravoz ,

Unda bor 9 xona.

Barchaga yo'l ko'rsatar,

Boshqaruvchi yagona.

Vagon sanash qiyin ish,

Bir, ikki, uch, to'rt, besh,

Olti, yetti, sakkiz, to'qqiz,

Charchadim endi so'zsiz.

Keling endi siz sanang,

Jo'r ovozda hamohang..... (bolalar sanaydilar)

Biroz muddat dam oling,

Paravozga chiqa qoling.

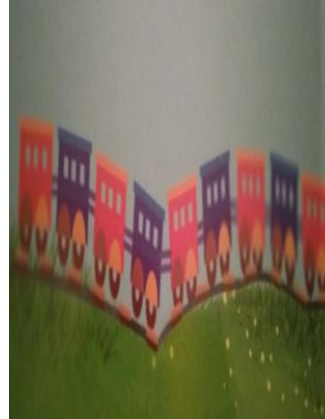

Methodological recommendation: to repeat the subject-based concepts, to find the right and reverse counting skills through didactic gameplay content from 1 to 9. To teach simple methods of making a parachute using geometrical figures. It is very effective to play the didactic game in minutes, in addition to activity.

### Center for science and nature

The purpose of the center: to provide educators with information about the changes in nature, the exchange of seasons, the pleasure of winter in the snow. Creating concepts about the state of snow in children by clearing the corridor of the kindergarten playground from the snow, observing the transformation of the winter into water at a hot temperature, and ice in the cold, and from a heap of snow "make an enchanted ice kindergarten".

The activity begins with providing educators with information about the useful properties of snow. The fact that each of the snowflakes falling from the sky has a repeating shape, the more it rains, the more it will saturate the earth with water and get a plentiful harvest in the fields, saying: children wear warm clothes and wear gloves because : we clean the corridor of the playground of our kindergarten from snow piles and from collected snowflakes, we Over the kindergarten, which is made of snow piles, pour cold water and magically freeze. The educator will tell about the changes that are happening in the composition of the snow.



After returning to the training room, in one breath, quick remarks are made:

-Erta tong otdi, qo'lda qor qotdi.

-Gilam qoqsa osmondan, par to'kilar har yondan.

-Qor yaxshi, o'ynashga qorbo'ron yaxshi.

Remarkable aspect: participation of all children in the process of activity is controlled. Active educators are encouraged. In them, consciousness and imagination are formed about the states of the snow.

### **Center for Sujet-role playing and staging**

The purpose of the center: to assist children to carry out their activities in harmony with their interests and talents on the basis of creative support. To teach to adhere to the culture of speech and to perform roles. achieve the sounds and voices of circus animals, by imitating them to express their actions and circumstances, enrich their imagination about circus performances, stage a live circus performance



Necessary equipment: posters depicting circus performances, videos from circus performances, deployments depicting circus heroes (masquerade, buratino, watch animals), their stage clothes, a lion cage (made of yellow yarn as a rectangle) and small balls on the floor, balloons.

Activities of the center: circus performances begin with watching short videos depicting. Educators are given information about the animals of the spectacle, the culture of the spectator. After that, a mysterious circus performance begins. Before you into the viewing area will come into the circus manager. Then visit The Masquerade, buratino and one after another circus animals: puppies, horses, elephants, monkeys, rabbits and lions. Children perform the actions of circus heroes, their voices entering the role. In the distribution of roles, the educator should take into account the interests and performance skills of children.

Recommendation: create a live circus performance environment. Educators are taught to distinguish circus animals, by imitating sounds and voices, to express their states of movement through roles.

To give information about audience culture. “During the summer recovery”, bring the children to the live circus performances. Help them to feel the mysterious pleasure in the circus.



#### REFERENCES:

1. M.SH.Mirziyoyev “Xarakterlar strategiyasi 2017-2021”T. Ma’naviyat-2017
2. Ilk va maktabgacha yoshdagi bolalar rivojlanishiga qo’yiladigan davlat talablari Toshkent-2018
3. “Ilk qadam” davlat dasturi T-2018
4. F.R.Qodirova,SH.Q.Toshpo’latov.....”Maktabgacha pedagogika”T-2019
5. Avdeeva A.N. Principles of constructing and conducting an interactive lecture // Bulletin of science and education. - 2020. - No. 8-1 (86).
6. Avdeeva A. N. Techniques of constructive influence in the process of interactive learning at the university // World Science 2020. Problems and Prospects: Materials of the II International Scientific and Practical Conference (April 9, 2020, Moscow) Saratov: Publishing House of the Center for Contemporary Arts "Academy of Business", 2020. pp. 31-33. ISBN 978-5-907199-74-3

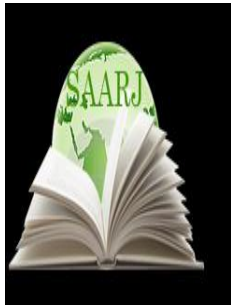

**ACADEMICIA**  
**An International  
Multidisciplinary  
Research Journal**  
**(Double Blind Refereed & Peer Reviewed Journal)**



**DOI: 10.5958/2249-7137.2021.01169.1**

## **ENRICHMENT OF THE QUALITY OF EDUCATION AND ITS ESSENCE**

**N. T. Ishankulova\***

\*Senior Teacher,  
Foreign Languages Department,  
Karshi Engineering and Economics Institute,  
UZBEKISTAN

---

### **ABSTRACT**

*This article analyzes the information on the use of changes in the education system in our country and its content and modern methods of reforms and modern methods of training in the system of continuing education. Today, the development of young people cannot be imagined without innovative ideas. Education, science, production is an independent worldview, determines well-made young people with high knowledge and thinking, which has an independent worldview. In the use of joint training, sending students to students in advance, each small group, demonstrating the assignment provided in the next lesson, using the methods of presentation, using presentations.*

**KEYWORDS:** *Education, Ideology, Patriotic, Innovation, Lesson, Reform, Order, Pedagogical Technology, Model, Modeled Lesson, Collaborative Lesson, Research Details.*

---

### **INTRODUCTION**

From the early years of independence of our country, the training of competitive personnel has become the need for competitive personnel using the education system and using the achievements of developed countries.

Providing various areas of the state and society with intellectual, educated personnel was considered as one of the priorities. In turn, specialists in this area have been borne by the presentation of the literature in the fields of the field, the introduction of innovation and education technologies in the educational process, in terms of the Identity of the Independence.

In this regard, President Shavkat Mirziyoyev stresses: "Another issue is crucial: this is the professional level of teachers and professors, their special knowledge. It is necessary to create an

environment that actively supports the process of education, spiritual, enlightenment maturity and the formation of real values. "

Stations defining the quality of education related to the learning process, encourages problem lectures, interesting in the form of questions, questions, and to think of advanced pedagogical technologies, and think of students, and to think freely, to think freely, to think freely, to think freely. There are many technologies that attract problem situations, solve problems, to freely communicate, in scientific research, find solutions to the problem.

Today, the development of young people cannot be imagined without innovative ideas. Education, science, production is an independent worldview, determines well-made young people with high knowledge and thinking, which has an independent worldview. In this case, the education system requires best practices, creativity from any teachers working in the education system.

From the early years of independence of the country's independence, reforms in the education system were voluntary and applied. In 1992 and in 1997, the Law on Education and the 1997 National Training Program and gradual changes in the education system were updated. Wide reforms have been carried out in recent years, in order to be held for the sustainable development of the Republic of Uzbekistan for 2017-2021, in particular, practical measures, updates, a number of decisions and decrees, the education system. Lifting to the top, reforming all links of the education system, developed countries, are the main task of training highly qualified personnel and young people, which are independent worldview, intellectual motorism.

This, in turn, is relevant than ever to work with all the coaches, pedagogues working in the system of continuing education, the effective use of information technology, effective use of information technology, effective use of interactive and innovative technologies.

Life itself proves that life itself is not sufficient in the early second-friendly age. Science, technology and innovative technologies in production cover the education system, as well as other industries. These are modern pedagogical technologies, innovative technologies, interactive methods, methods of non-traditional classes, etc.

Innovation (Innovation) - innovation, is news. Innovative technologies are a pedagogical process and the activities of teachers and student, in mainly interexive techniques are used to fully in it. Today, both traditional and non-traditional models of organizing the lesson of education are used by our teachers.

A non-traditional lesson is aimed at the student's personality, and it is also known as the student in the center. It should be noted that the non-traditional models of organization of the lesson have a number of achievements. In this way, teaching requires great skills from our teachers. Non-traditional forms of education include:

1. Oodelized lesson;
2. Heavial learning lesson;
3. Incidental lesson;

1. Modeled class and society are a set of methods in the classroom and the model of the processes in the community and the methods of studying students in their personal participation and education.
2. The joint study is a set of methods that provide educational in exchange for working in independent groups.
3. The study research model is a set of methods that provide for a specific problem.

Apparently, the lesson in all three models encourages students of student-educational students, creative research, to work together. The non-traditional lesson has a number of advantages in the following areas:

- leads to good development of the content of the course, freestyle observation;
- Insurance of timely re-communications;
- Creation of conditions for applying concepts in practice;
- offer of various teaching methods;
- to be a high level of motivation;
- well recollection of past materials;
- Improving the development of communication;
- increase in self-assessment;
- Formation of positive attitude of students in the field of the topic;
- Development of critical and logical thinking;
- Students form knowledge, skills, skills such as the formation of problems solving skills.

It is a great opportunity for students to have knowledge, skills and skills, such as improving the content of the learning, entering the contents of science, developing self-assessment, critical, critical, critical, and logical thinking of students. This, in turn, requires an innovative technological approach to education. A particular project of each lesson is prepared and determined what results will be achieved on the basis of this projector basis. In the context of a market economy, one of the most effective ways to train national ideas in the field of education is to use the most effective forms of educational in organizing the lesson.

In the use of joint training, sending students to students in advance, each small group, demonstrating the assignment provided in the next lesson, using the methods of presentation, using presentations. The formation of the skills to work in the team and to find the problem solving in the team will serve to develop skills between students, solving solutions to the problem, and innovative approach.

So, of the following ways, of course, in the learning of foreign languages In particular, the fields of foreign languages in particular is a national tradition, the formation of skills, the formation of skills, national pride and pride, the country He hurts the groundwork for the formation of qualities such as involved in development and independence, as perfect and competitive personnel.



**LIST OF USED LITERATURE:**

1. President of the republic of Uzbekistan Shavkat Mirziyoyev appeal to the Oliy Majlis // <HTTPS://preside.uz/uz/lists/view/4057>;
2. Constitution of the Republic of Uzbekistan // [HTTPS://lex.uz/doms/20596? Ondate = 08.12.1992% 2000 # 92374](HTTPS://lex.uz/doms/20596?Ondate=08.12.1992%2000#92374);
3. Decree of the President of the Republic of Uzbekistan on February 7, 2017 on "On the Strategy of Action to the Development of the Republic of Uzbekistan" // Voice of Uzbekistan. - 2017 - February 9.
4. Mirziyoyev Sh.M. Critical analysis, strict disciplinary and personal liability - each leader must be the daily rule of the activity. T., "Uzbekistan", 2017, 45 B.
5. K.T.olimov. Large experiences in modern technologies and innovative technologies. Educational-methodical complex. Bukhara 2015.
6. Law of the Republic of Uzbekistan "On Education". No. ZRU-637.// September 23, 2020.
7. Sayidahmedov N. New pedagogical technologies. - Tashkent: Finance, 2003.
8. Abdabdukodirov A. Innovative technologies in education. - Tashkent: Talent, 2008 - 180b.
9. <https://lex.uz/docs/5013007>.

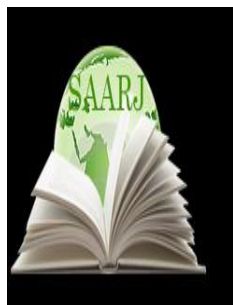

**ACADEMICIA**  
**An International  
 Multidisciplinary  
 Research Journal**  
 (Double Blind Refereed & Peer Reviewed Journal)

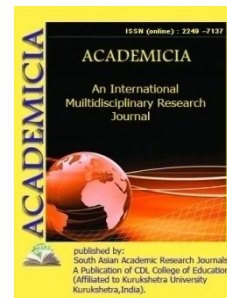

**DOI: 10.5958/2249-7137.2021.01168.X**

## THE ROLE OF UPBRINGING IN THE MATURITY OF THE PERSON AND ITS SPECIFIC FEATURES

**Ravshanova Nasiba\***

\*Senior Lecturer,  
 Department of "Foreign Languages",  
 Karshi engineering and economics institute,  
 UZBEKISTAN

### ABSTRACT

*This article is generalized the information about the maturity of the person and its characteristics. As well as the theory of education as a part of pedagogical science analyzes the content, form, methods, tools and techniques, the importance of the spiritual heritage of Eastern thinkers of the educational process today.*

**KEYWORDS:** *Pedagogy, Education, Education, Theory, Methodology, Spiritual, Heritage, Values, Decrees, Manners, Means, Culture*

### INTRODUCTION

The future and development of any nation depends on the spiritual maturity, worldview, intellectual potential of young people. In particular, raising the spiritual qualities in the minds and hearts of young people, strengthening solidarity in families and communities, strengthening ideological immunity against ideological and information attacks, spiritual and moral criteria, the priority of national and universal values, regular study of geopolitical and ideological processes, terrorism, extremism, ideology. Understanding the essence of such issues as effective ideological fight against human trafficking, drug trafficking and other dangerous threats, dedication to the development of our developing country, honest work, and thorough mastery of the secrets of modern science are among the most pressing tasks today.

Indeed, the Resolution of the President of the Republic of Uzbekistan dated March 26, 2021 "On measures to radically improve the system of spiritual and educational work" provides for fundamental, practical and innovative research in spiritual education and social sciences, increasing the effectiveness of spiritual and educational work in all sectors of education. The basis of education is the organization, implementation, study of the heritage of our great

ancestors, who contributed to the development of world science, a deep understanding of the rich spiritual heritage left by them, the formation of highly spiritual, competitive personnel through the effective application of modern technologies in education.

Education and its theoretical foundations are an integral part of pedagogical sciences, studies the content, shape, methods, tools, tools, tools, tools, tools, and techniques, as well as the problems of the educational process.

Currently, as well as in educational institutions, teacher educators pay special attention to the formation of young people as spiritually, mature person. In this regard, President Shavkat Mirziyoyev emphasizes: "Another issue is crucial: this is the professional level of teachers and professors, their special knowledge. It is necessary to create an environment that actively supports the process of education, spiritual, enlightenment maturity and the formation of real values".

In this regard, if we think about the goals and objectives of education, education is a process of comprehensive development of the younger generation on the basis of a specific, clear goal and socio-historical experience, the formation of its consciousness, behavior and worldview. In different times and places, social education has been expressed in essence differently, and its content is based on social goals.

The purpose of education is determined by social order. From the simplest action to the most comprehensive state program, education is always goal-oriented. Without a purpose, there can be no upbringing that does not express a particular idea. Based on the purpose of education, based on its content, the methods and techniques that serve to achieve the goal are identified. The problem of the purpose of education is one of the most pressing issues of pedagogy.

The purpose of education can be general and individual in nature. Advanced pedagogy demonstrates the unity and harmony of general and individual goals. The goal is aimed at the positive solution of the general social goal of education and manifests itself as a system of specific tasks. Hence, the purpose of education is a system of tasks to be solved on the basis of the organization of the educational process. Educational goals are grouped into general and specific tasks according to their nature and scope.

Human qualities such as spiritual and moral purity, faith, honesty, piety, honor, kindness, and respect for the elderly, which play an important role in the spirituality of society and the maturity of the individual, do not form spontaneously. At the heart of all this is the content, ideological direction and effectiveness of education for the younger generation in the family, general secondary, secondary special, vocational and higher education.

An important component of social education - a new approach to the organization of mental, spiritual, moral, physical, labor, aesthetic, legal, environmental, economic education for the formation of the younger generation as a modern, harmoniously developed person, to develop their effective ways. The output is particularly relevant. These are the most important tasks in education.

In this regard, in recent years, large-scale reforms have been carried out and implemented in our country. First of all, not only in our country not only in our country not only in our country is extremely important in the upbringing of the younger generation of the younger generation growing.

According to the Resolution of the Cabinet of Ministers of the Republic of Uzbekistan dated July 6, 2020 № 422 "On measures for the gradual implementation of the subject" Education "in general secondary education", there are noble goals, such as deepening the values and high spirituality, educating them in the spirit of patriotism and humanity, the organization of spiritual and educational work in general secondary education on a new basis.

Also, the introduction of a single subject "Education" in general secondary education, combining the disciplines "Ethics", "Sense of Motherland", "The idea of national independence and the foundations of spirituality" and "History of world religions" has great educational value for students, serves to enrich their knowledge, to raise their spiritual maturity.

Today's issue of education of modern globalized, modern technical technology is a factor in the developed period - every nation is a factor in which the future is the future.

In particular, the XXI century entered as a computer age in human history. However, it is necessary to work, based on how effective and the technique is developing and increasing an important place in the life of the society, raising a person in public life, based on nationality of Central Asian thinkers, leading options of Central Asian thinkers, and the leading views of Central Asian thinking.

In the upbringing of young people in a harmonious man, the valuable spiritual heritage of Eastern will be as an important program. Such as the Muhammad al-Khwarizmi, Abu Nasr Farabi, Abu Ali ibn Sina, Abu Rayhon Beruni, Ahmad Al-Farghani, Imam Ismail al-Bukhari, Ahmad Yassavi, Bahouddin Naqshband, Amir Temur, Mirzo Ulugbek, Alisher Navoi and Zakhtaliddin Muhammad Babur. The social, political and philosophical views of popular scientists play an important role in all-time.

From no one, a person who does not know his past's cultural heritage did not study and honor his ancient descendants, he or she does not know his life.

The study of the cultural heritage of the past is a complex process. Sampling for cultural heritage and the absorption of the noble ideas in the age of-generation should be carried out continuous, consistent, systematically, and purposeful.

In particular, the President of the country noted the following statements at the solemn ceremony dedicated to the 29 th anniversary of the independence of the Republic of Uzbekistan: The first Renaissance of Uzbekistan, fell to the second-philosan stone and Temur and the Temurids. It was not only Movaraunnahr, but the whole of the Central Asian countries increased to a new level of development. It was also noted that during this period, the development of science, culture and arts was manifested and the rise of contemplations was manifested.

In this speech of the head of our state, the word "The glorious power of our people is still being created in Uzbekistan - the period of a new renewal - the third of Renesans".

In fact, the rise processing process in our lives in growing rapidly is displayed in all areas. In the early years of independence, it was tried to reveal the original essence of our national identity, rich historical, spiritual and scientific heritage. It should be noted that our people have joined the idea of "national revenue - the national construction" in steadfast.

So, it is difficult to enrich the minds of youth and worldview today, on the basis of historical principles in educational system, on the basis of historical role in all stages of the education system.

**LIST OF USED LITERATURE:**

1. Speech by President of the Republic of Uzbekistan Sh.M. Mirziyoev at the solemn ceremony dedicated to the 29th anniversary of the independence of the Republic of Uzbekistan. // 31 August 2020, <http://www.uztail.uz/uz/post/6557>.
2. Thukhtakhodjaeva M. X. i dr. Pedagogy. T., 2005.
3. Resolution of the President of the Republic of Uzbekistan "On measures to radically improve the system of spiritual and educational work. " //- [www.uza.uz](http://www.uza.uz).
4. [www.Lex.uz](http://www.Lex.uz).
5. [www.uza.uz](http://www.uza.uz).

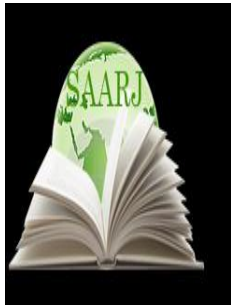

**ACADEMICIA**  
**An International**  
**Multidisciplinary**  
**Research Journal**  
 (Double Blind Refereed & Peer Reviewed Journal)



**DOI: 10.5958/2249-7137.2021.01216.7**

**THE EFFECT OF SCIENTIFIC AND TECHNICAL MENTALITY AND  
 INNOVATION ON THE FORMATION OF MODERN SPIRITUAL AND  
 ETHICAL FACTORS IN YOUNG PEOPLE**

**Rajabboev Jurabek\***

\*Student,  
 Department of National Idea,  
 Fundamentals of Spirituality and Legal Education, Urgench State University,  
 Urgench, Uzbekistan.  
 Email id: sv997710@gmail.com

**ABSTRACT**

*This article analyzes the influence of spiritual and moral factors in the formation of scientific and technical thinking in young people. The role of scientific and technical literacy in the formation of innovative thinking of young people in modern times has been scientifically discussed.*

**KEYWORDS:** *Spiritual And Moral Factors, Innovation, Creation, Creativity, Superior, Modern Education, Cognitive, Processes, Harmonious View, A Dynamic Features, Technical Research.*

**INTRODUCTION**

The scientific and technological revolution, the processes of modernization taking place in society will inevitably affect people's lives, spiritual and moral factors. The scientific and technological revolution has been studied since the new era (16th century). This would greatly expand the scope of our subject and lead us to deal with the history of science and technology. Therefore we are limited mainly to a brief look at the changes that have taken place since the second half of the twentieth century to the present. Doctor of Philosophy, Professor N. Shermuhamedova, who has observed the history of epistemological research, writes: "In the middle of the 18th century, the number of scientists in the world did not exceed 10,000, but by the end of the 19th century, the number of scientists had reached 100,000," she said. By the end of the 16th century, most of the "scholars" were clergymen with religious knowledge. In the 19th century, science and technology became an independent branch of social labor, and it was practiced by "secular" professional scientists who had graduated from special faculties of

universities and institutes. In 1850, about a thousand scientific journals were published in the world, and by 1950 their number exceeded 10,000. In 1825, the German chemist Yu. Libix established a scientific laboratory, which began to bring the scientist a large amount of income. By the end of the 19th century, the number of such laboratories was increasing. Science is beginning to attract more and more attention of traders and entrepreneurs.

## **MATERIALS AND METHODS**

They will start to finance the work of scientists, which is of industrial and significant producing.[1]. During this period, science and technical thinking differed from religious clerical views, scientists were interested in real-life problems, especially the improvement of the means of production, the discovery of the mysteries of the universe and its service to human interests. The struggle between the clergy, the church and the owners of science and technical mentality had led to many tragedies. Here we can remember the fate of Galileo, Copernicus, Spinoza, Bacon, Acosta. The second half of the twentieth century is a new stage in science and technical mentality . It was a postclassical period when a revolution took place in science and technical thinking. "After the Second World War, the achievements of science and technology in economically developed countries will be put into practice on an unprecedented scale in industry, agriculture, healthcare and everyday life. Science is making huge changes, especially in energy (nuclear power stations), transport (automotive, aviation), electronics (television, telephony, computers)."The development of science will be a key factor in the creation of the latest military equipment, and the escalating arms race in the condition of the post-war confrontation between the two camps will force major powers to invest heavily in scientific and technological research"[2]. During this period, science and technical thinking differed from irrational inheritance, and it was preferable to rely on common sense, to abandon sophisticated approaches and to devote to scientific research in accordance with the science of logic. During this period, about 60 research institutes and the Academy of Sciences of Uzbekistan, the Academy of Agricultural Sciences, the Academy of Medical Sciences were established in Uzbekistan alone. For the development of rational mentality, a new system of education, dreamed of by our jadid ancestors, will be created; all areas will be managed by highly qualified personnel. The information technological revolution of the late twentieth century has radically changed people's worldview and perception of the universe. Today, about 6 million scientists work in this great science. During the years of independence, the Khorezm Mamun Academy, branches of the Academy of Sciences of the Republic of Karakalpakstan and Samarkand, Andijan, Namangan, Bukhara, Surkhandarya, Kashkadarya and Fergana branches were opened in Uzbekistan. These research centers serve to develop intellectual mentality, enrich the life of society with the results of innovative research. The former "Chinese wall" between science and religion is being removed. The establishment of the Tashkent Islamic Institute for the Study of Islamic Culture and Mentality, 10 Islamic secondary special educational institutions, the Tashkent Islamic University under the Cabinet of Ministers, and the International Scientific Research Center named after Imam Bukhari leads to a harmony between religious and secular knowledge. These young people are bound to be influenced by their spiritual and moral views. Because today in these scientific institutions have a main goal which the formation of young people who have a great love for the rich heritage of Islam, full of high spirituality and enlightenment, actively participating in the processes of modernization and innovative development in our society,

mastering modern knowledge and information technologies, ready to fight religious extremism and terrorism[3].

## RESULTS AND DISCUSSION

The main goal is to form young people who will be able to hold their ceremonies in accordance with modern requirements. The impact of scientific and technical thinking and innovation on the formation of modern spiritual and moral factors in young people can be seen in the following:

- when it is considered that the intellect as a modern sign, an indicator of human perfection;
- in the tendency to modernize social life on the basis of modern knowledge, scientific worldview;
- when evaluating the achievements of innovation and modernization in terms of high moral and ethical values;
- while acting as a supporter of scientific and technical discoveries, humanization of technological processes, humanization;
- while enriching their spiritual world with high ideals, exemplary experiences and modern altruistic views based on a combination of secular and religious knowledge;

Although the view of the intellect as an important indicator of human perfection has existed since the time of our great ancestors, such as Abu Nasr al-Farabi, Abu Rayhan al-Biruni and Ibn Sina, it was not until the twentieth century that it became a special quality of man. (Farabi). The newly established schools were based on the paradigm that everyone, regardless of human origin, nationality, gender, has intellect, everyone can discover, create, show their intellectual abilities.

Sexual and social restrictions on the upbringing of young people have been halted. It was essentially a novelty, an innovative change. Today, it has become a tradition to turn intelligence into natural intelligence and artificial intelligence. This is primarily due to cybernetics, computerization. "The emergence of computer systems, which began to be called intelligent systems (IS), and the development of a direction called artificial intelligence (SI) have given rise to a new approach to a number of traditional theoretical cognitive problems. This, in turn, has helped to find new ways of research, to focus on many aspects of cognitive activity that no one has previously remembered, to understand new cognitive mechanisms and outcomes" [4]. This scientific innovation gave rise to the theory of "computer mentality". At the same time, the practical mastery of the computer has become a common reality. For example, today in Uzbekistan about 7 million people use the Internet. About a third (32 percent) of our respondents considers computer technology to be the most effective means of intellectual growth. According to them, the computer plays the same role as books and scientific heritage in human development. Even the computer is superior to any other means with its responsiveness, richness of information and quick interaction, communication. The maturity of young people depends on the adequate dissemination of scientific, spiritual and vital heuristic information. The lack of this information, the lack of ability to use it, has a negative impact on the intellectual development of young people. At the same time, artificial intelligence, computerization also raised the issue of spiritual and moral development of man, as a result of which the term "computer ethics" appeared. According to scientists, "we cannot replace a person with computers in areas related to



interpersonal relationships, mutual understanding and affection, for example, replacing a psychiatrist or judge with a computer is immoral. According to J. Moore, computer ethics is a dynamic and complex field of research that studies the relationship of ever-changing computer technology to the language of facts, conceptualization, politics, and values. Computer ethics does not consist of a list of rules to hang on the wall or even ethical principles that are automatically applied to computer technology. Although computer ethics links technology to and depends on ethics, it represents the goal of understanding computer technology and implementing policies in this regard"[5]. Hence, the debate over the connection of intellectual pursuits with spiritual moral values continues, which is one of the immanent laws of contemplation. But technocratic ideas and proposals are also likely to open up new topics and directions for innovative research. The desire to modernize social life on the basis of modern knowledge and worldviews is the result of maximalism in youth. True, most of them cannot imagine exactly what modernization, what reforms will lead to. Living with high spiritual and moral ideals, seeking them from secular and religious values and experiences is a characteristic feature of Uzbek youth. They are well aware of the negative attitudes towards Islam and religious values during the Soviet era. At this point, the impact of the education system is obvious. In the Soviet era, it was impossible to write or talk about Islamic thought, because in Islam, ideas and views based on common sense, rationality, and life experience were contrary to communist ideology.

## CONCLUSION

In fact, the development and thinking of the world cannot be imagined without the Islamic phenomenon and culture. Under the influence of Islam, such spiritual and moral factors were formed in the East and the legacy of such thinkers was formed, without which it is difficult to turn today's development, innovative changes into a reality. It is true that Islam has influenced these spiritual and moral factors and the legacy of thinkers in different ways, while religious fanatics have opposed scientific research and did not want them to be included in public life. For example, M. Khatami, who specifically studied Islamic thought, reveals that he formed different philosophical, scientific, political and moral ideas at different times. Some ideas (e.g., Farabi's political-philosophical legacy) have been completely forgotten [6]. Islamic mentality was a paradigmatic phenomenon that influenced secular views and knowledge, which could not be erased from the hearts of the people, the nation. Forty-three percent of our respondents say that scholars who have left a deep mark on Islam and thought are a school of life ideals, their spiritual and moral qualities, and 37 percent say that religious values, especially Islamic moral traditions, influence the formation of secular views. They believe that changes in society will strengthen Eastern and Islamic values, giving a national spiritual outlook to the modernization process. Underlying this optimism lies confidence in the Islamic heritage and modern renewal.

## REFERENCES

1. Shermuhamedova N. Research methodology. Tashkent: Science and Technology Publishing House, 2014. 24 25 p.
2. That work. 26 p.
3. Alimov U. Qualities of science. Tashkent:MOVARAUNNAHKR, 2010. 108 p.
4. Philosophy of knowledge. Gnoseology. Tashkent: University, 2005. 317 p.
5. That book. 324-325 p.
6. Khotamiy M. From the history of Islamic mentality. Tashkent: Minhoj Publishing House, 2006. 12 p.

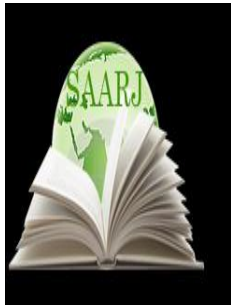

**ACADEMICIA**  
**An International  
 Multidisciplinary  
 Research Journal**  
 (Double Blind Refereed & Peer Reviewed Journal)

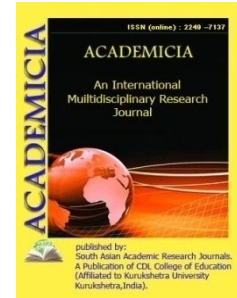

**DOI: 10.5958/2249-7137.2021.01186.1**

## THE ADVANTAGES AND DISADVANTAGES OF MULTIMEDIA AND ITS USING IN TEACHING ESL

**Xakimboyeva Ozoda\*; Safayeva Nigina\*\***

\*Teacher,  
 State World Languages University,  
 UZBEKISTAN

\*\*Fourth year student of Uzbekistan State World Languages University,  
 UZBEKISTAN

### ABSTRACT

*Educational systems around the world are under increasing pressure to use the new technologies to teach students the knowledge and skills they need in the 21st century. Education is at the confluence of powerful and rapidly shifting educational, technological and political forces that will shape the structure of educational systems across the globe for the remainder of this century. Many countries are engaged in a number of efforts to effect changes in the teaching/learning process to prepare students for an information and technology based society. Multimedia provide an array of powerful tools that may help in transforming the present isolated, teacher-centred and text-bound classrooms into rich, student-focused, interactive knowledge environments. The schools must embrace the new technologies and appropriate multimedia approach for learning. They must also move toward the goal of transforming the traditional paradigm of learning. Teacher education institutions may either assume a leadership role in the transformation of education or be left behind in the swirl of rapid technological change. For education to reap the full benefits of multimedia in learning, it is essential that pre-service and in-service teachers have basic skills and competencies required for using multimedia. This paper, therefore, explores the latent benefit of using multimedia tools particularly in professional teacher education. The paper also discusses why pre-service teachers need to use multimedia technologies within the context of students' familiar, technology-rich living spaces to develop their own teaching skills and the technology skills of their students. In addition, the author also explains the role of multimedia in enhancing the 21st century skills.*

---

**KEYWORDS:** *Multimedia, Teacher Education,, Pre Service Teachers, 21st Century*

---

## INTRODUCTION

Multimedia offers the lecturer many benefits including: satisfying educational objectives, increasing pupils understanding, demonstrating events, showing places, conducting experiments which would otherwise be impossible. Sharing of multimedia outputs is done carefully such that it will not disturb other learners working in the same classroom! Not only may a number of pupils be performing similar activities at the same time on a network, the lecturer must decide whether to control the activities via the media of the computer. The use of multi-party desktop conferencing with the lecturer chairing the running of the conferencing session, showing selected parts of a video is a case in point.

Giving pupils an opportunity to produce multimedia documents of their own provides several educational advantages. Pupils work with the same information from four perspectives: 1) as researcher, they must locate and select the information needed to understand the chosen topic; 2) as authors, they must consider their intended audience and decide what amount of information is needed to give their readers an understanding of the topic; 3) as designers, they must select the appropriate media to share the concepts selected; and 4) as writers, they must find a way to fit the information to the container including the manner of linking the information for others to retrieve.

Some of the advantages that can be listed for the use of multimedia, according to the authors of the above report, are as follows:

Multimedia can:

- enhance learning in different locations and institutions of diverse quality;
- present opportunities to pupils working at different rates and levels;
- provide (tirelessly, without holding up other pupils) repetition when repetition is warranted to reinforce skills and learning;
- compensate, in the short term, for high pupil populations and limited numbers of trained and experienced teachers – in combination with robust teacher development initiatives and improvements in teachers' working conditions.

Updates to content ware can ensure that teachers and pupils encounter and have the chance to work with current and authentic sources. Such encounters tie learning to the most important events of our time and underscore the general idea that knowledge itself is not fixed and finalized, that there is a universe of discoveries and a library of analyses that can be available to pupils.”

To what extent these advantages of multimedia are relevant to language teaching and learning will be discussed later in this section.

Teachers have chosen a variety of technologies to help in educating ESL pupils. In some instances the older technologies of audiotapes, language masters, televisions, and videotapes are still utilized. Audiotapes are used in listening centers, and in some cases with home projects. Language masters are still used as listening and speaking centers in some classrooms. The common technologies of television and videotapes are valuable learning tools, when used

appropriately. With previewing, viewing, and post-viewing activities included, a wide array of activities can be used with video and television that provide both auditory and visual language experiences.

The emerging technologies of computers and multimedia provide opportunities for even more learning experiences for EFL pupils. Word processing, e-mail, computer software, the Internet, and the World Wide Web are all sources of more and different learning activities. The interactive nature of multimedia provides new ways to enhance the learning experience of EFL pupils.

Teachers use multimedia with EFL pupils for a variety of reasons. The text, graphics, video, and audio encourage immersion in language. The nonjudgmental aspect of technology is comforting for these pupils. The individualization, instant feedback, and assessment components of many software packages are all positive factors. Pupils are motivated when using technology, especially the new emerging technologies. They feel empowered and often content is more accessible to them.

Many factors need to be considered when evaluating multimedia. It should be easy to use and to navigate. It should be consistent with the knowledge we have about EFL pupils' learning needs. Software should be appealing and, of course, it should have a purpose.

Technology is a valuable part of all pupils' learning and education. It can be an integral factor in the EFL pupil's learning. Not only can technology, and particularly the emerging technologies, assist in the acquisition of language skills, but also technology can aid in the all-important task of aiding pupils in the mastering of curriculum content in English. When appropriate preparation and activities are utilized, technology can assist teachers in meeting the special language and learning need of EFL pupils.

One of the major concerns of many countries today is that there is a mismatch between graduates' skills, acquired from higher education institutions and the skill sets needed in industry. Many of the current graduates are found to be lacking in creativity, communications skills, analytical and critical thinking, and problem-solving skills.<sup>1</sup> As such, there is much need for institutions of higher education to focus on training future graduates to be more adaptable to the needs of the industry.

Currently, many institutions are moving towards problem-based learning as a solution to producing graduates who are creative and can think critically, analytically, and solve problems. Since knowledge is no longer an end but a means to creating better problem solvers and encourages lifelong learning, problem-based learning is becoming increasingly popular in educational institutions as a tool to address the inadequacies of traditional teaching. Since these traditional approaches "do not encourage pupils to question what they have learnt or to associate with previously acquired knowledge" problem-based learning is seen as an innovative measure to encourage pupils to "learn how to learn" via "real-life" problems.

We would like to extend this contention further by using multimedia technologies to create a multimedia-oriented project. By doing so, we hope to further develop the pupils' ability to become creative and critical thinkers and analyzers, as well as problem-solvers, within this multimedia-mediated problem-based learning (PBL) environment. This learning mode is constructivist in approach whereby the pupils participate actively in their own learning process and construct their own knowledge.

The move towards using problem-based learning in many educational institutions has resulted in a shift in the curriculum model. The focus is moving from content towards problems to provide a more realistic approach to learning and to create an educational methodology which “emphasizes real world challenges, higher order thinking skills, multi-disciplinary learning, independent learning, teamwork and communication skills” via a problem-based learning environment. However, this model can be further strengthened with the inclusion of multimedia technology into this problem-based learning environment to enhance the pupils’ learning experience.

With the use of multimedia projects, pupils can utilize the knowledge presented to them by the teacher, and represent them in a more meaningful way, using different media elements. These media elements can be converted into digital form and modified and customized for the final project. By incorporating digital media elements into the project, the pupils are able to learn better since they use multiple sensory modalities, which would make them more motivated to pay more attention to the information presented and better retain the information.

On the other hand, there are also some disadvantages of multimedia and its use in teaching. I can consider the price of the tool as the first problem, because as everyone knows multimedia tools are expensive and not all people or teachers can afford it for themselves. Every teacher wants to use it but, as they do not have enough money to have its tools they mostly try to avoid of using it.

The next disadvantage is that it is not always to configure, I mean not all teachers can use it easily. Because it is difficult to use it people who are not aware of this kind of program as it requires special hardware. Even sometimes teacher take a readymade material it is difficult them to use it because of lack of knowledge in that sphere.

Creating multimedia projects is both challenging and exciting. Fortunately, there are many multimedia technologies that are available for developers to create these innovative and interactive multimedia applications. These technologies include Adobe Photoshop and Premier to create and edit graphics and video files respectively, Sound Forge and 3D Studio Max to create or edit sound and animation files, respectively. They can also use an authoring tool such as Macromedia Director or Author ware to integrate and synchronize all these media elements into one final application, add interactive features, and package the application into a distributable format for the end-user. Another advantage of creating multimedia projects in the classroom setting is that when pupils create multimedia projects, they tend to do this in a group environment. By working in a group, the pupils will have to learn to work cooperatively and collaboratively, using their group skills and a variety of activities to accomplish the project’s overall objectives.

As stated by Agnew : “Pupil-created multimedia projects are beneficial, in addition, because they often involve substantial work, open-ended assignments, theme-based activities, and knowledge and experiences that the pupils draw from a wide variety of sources.” Multimedia-oriented projects are “a way for pupils to achieve high self-esteem, to increase their ability to function as self-directed learners, to learn to think effectively, and to practice problem-solving and decision-making”.<sup>2</sup> Therefore, using multimedia in the teaching and learning environment enables pupils to become critical thinkers, problem-solvers, more apt to seek information, and more motivated in their learning processes. Multimedia is slowly gaining ground as a way for pupils to represent the knowledge that they acquire in class and to construct their own interpretation of the

information acquired. It also fosters collaborative and cooperative learning between and among pupils, thus better preparing them with a skill set for real-life work situations.

Having analyzed the theme of my research work, having studied several resources on the given topic and having seen the works of other scholars about the multimedia and its use in education and especially in teaching EFL and ESL I came to the conclusions below:

1) The term Multimedia is said to date back to 1965 and was used to describe a show by the Exploding Plastic Inevitable. The show included a performance that integrated music, cinema, special lighting, and human performance. In the 1993 first edition of McGraw-Hill's *Multimedia: Making It Work*, Tay Vaughan declared, "Multimedia is any combination of text, graphic art, sound, animation, and video that is delivered by computer. When you allow the user – the viewer of the project – to control what and when these elements are delivered, it is interactive multimedia. When you provide a structure of linked elements through which the user can navigate, interactive multimedia becomes hypermedia."

2) The use of multimedia in education has been extensive, as it has been effective in increasing productivity and retention rates, where research has shown that people remember 20% of what they see, 40% of what they see and hear, but about 75% of what they see and hear and do simultaneously. It is now permeating the educational system as a tool for effective teaching and learning. With multimedia, the communication of the information can be done in a more effective manner and it can be an effective instructional medium for delivering information. A multi-sensory experience can be created for the audience, which, in turn, elicits positive attitudes toward the application. Multimedia has also been shown to elicit the highest rate of information retention and result in shorter learning time.

1. Most teacher advocates of audiovisual aids have made similar observations on the primary and secondary level as well. An effective teacher knows the secret of AV instruction is to utilize the unique capability of each medium. This can only be accomplished if the teacher is willing to put in the necessary planning and effort. The rewards can be considerable. Once a technique is mastered, its use can free the teacher for the many classroom activities in which human interaction is still, and always will be, vital.

Pupils respond to information differently. Thus, it is often to our advantage as teachers to use many different formats and modes to teach the subject matter of a lesson. This is why teachers normally use some combination of lecture, text and hands-on laboratory for conveying information. With the advent of the Internet and the multiple formats that can be communicated over the World Wide Web, we now have several new and exciting ways to present information. The Web allows the incorporation of animation, moving pictures, and sound into lessons, which extends our abilities to present materials that encourage pupil interaction with the subject matter. Pictures and animations help bring to life scientific principles, and multimedia allows pupils to take a more active role in learning: they can watch experiments in action, see microorganisms up close, and use a mouse or keyboard to navigate images, simulations and interactive material. One of the advantages of using multimedia is to convey information quickly and effectively to all pupils – and keep them interested in learning.

2. Multimedia materials in the teaching of foreign culture are of inestimable value. I have discovered that these aids are extremely effective; especially at a time when the visual media seems to dominate all our lives and, as such, that this visual conditioning communicates to us

with greater sharpness and impression. It must be kept in mind that multimedia materials serve the teacher only as supports to his lectures and the assigned required readings; Pupil evaluations both essay and objective, of the multimedia used in the course attest to the effectiveness of their use in the classroom.

So, as we are living in the 21<sup>st</sup> century we must use all opportunities that we are given. Teachers of this century have the opportunity to engage pupils like never before. Multimedia resources, such as interactive online games, video clips, pod casts and sets allow them to address a range of learning styles and meet the needs of every pupil.

## CONCLUSION

To summarize the theme we have taken under discussion we can state that Teaching Reading, speaking, writing and listening with the help of authentic materials have profound advantages:

- it helps pupils form the experience of English text reading
- it supports the pupils enlarge vocabulary
- it helps pupils be aware of the history, social life and culture of people whose native language they are learning as a second or foreign language.
- it helps the pupils to develop reading, writing, listening, and speaking techniques; to improve their observational skills, to obtain analytical methods and make stylistic interpretation analysis.
- It improves the pupil's abilities of any authentic and compulsory material.
- It forms the pupils' fluency in the English language
- It provides the pupils' effective communication
- It develops pupils' critical thinking and creative approach abilities
- It helps the pupils to gain much knowledge, form the outlook.
- More over Teaching reading, writing, listening, and speaking for using authentic materials implements professional aim as to develop pedagogical – professional practice in pupils.

## REFERENCES

1. Alessi, S.M. & Trollip, S.R. (2001), *Multimedia for learning*, (3rd Edition)
2. Allyn and Bacon. Bajraktarevic, N., Hall, W., & Fullick, P. (2003), "Incorporating learning styles in hypermedia environment: Empirical evaluation", *Proceedings of AH2003: Workshop on Adaptive Hypermedia and Adaptive Web-Based Systems*. (1956), *Taxonomy of educational objectives: Book 1, Cognitive domain*, New York: Longman.
3. Bransford, J., Brown, A., & Cocking, R. (Eds.) (1999), *How people learn: Brain, mind, experience, and school*, Washington, DC: National Academy Press.
4. Capobianco, B. (2007, June), "A self-study of the role of technology in promoting reflection and inquiry-based science teaching." *Journal of Science Teacher Education*, 18(2), 271-295. Retrieved July 2, 2007, from Education Research Complete database.
5. Committee on Workforce Needs in Information Technology. (2001). *Building a workforce for the information economy*, Retrieved from the National Academies Press.

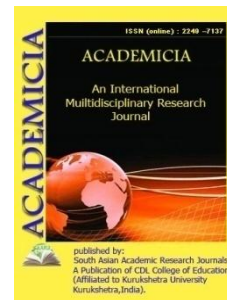
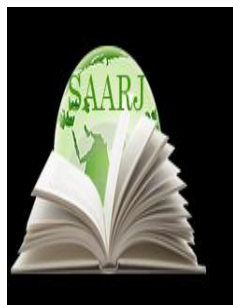

DOI: **10.5958/2249-7137.2021.01185.X**

**THE DEPENDENCE OF THE RESISTANCE OF ESTRADIOL ON THE INFLUENCE OF THE MUTANT HENA OF THE ALLEL A WITH JUVENILE DYSMENORRHEA**

**Yakubova Oltinoy\***

\*Andijan Medical Institute,  
UZBEKISTAN

**ABSTRACT**

*Girls were examined with YUD (n = 64) compared with the control group (n = 50). For the release of DNA, venous blood was served from the elbow vein, with the detection of estradiol-alpha receptor genes and serum estradiol (E2). The data obtained during genetic studies are consistent with the indicators obtained during the study of the level of estradiol, in the blood of girls with primary dysmenorrhea, depending on the presence of CTD criteria. It was revealed that the presence of a mutant allele A, as well as the G2014A genotype in the ESR1 G2014A genotype in women, can affect the level of estradiol levels in the blood, which was confirmed by genetic analysis, which revealed that the intelligence of the mutant allele of the estrogen receptor - alpha (one-deactive replacement of Guanin On adenine in RS2228480), 1.9 times higher in the group of girls with YUD with CTD than in the YUD group without CTD ( $\chi^2 = 4.515$ ;  $p = 0.03$ ).*

**KEYWORDS:** *Juvenile Dysmenorrhea, Connective Tissue Dysplasia, Estradiol.*

**INTRODUCTION**

Around the world, one of the factors that worsen the quality of life of girls and teenage girls is considered painful syndrome accompanying the physiological process - menstruation. According to WHO, the prevalence of menstrual pain syndrome in the structure of teenage gynecological pathology is extremely high, while about 15% of them characterize menstrual pains as painful. Juvenile Dysmenorrhea (YUD) - painful menstruation in girls under 18, in the absence of pelvic pathology, are general and often depleting gynecological suffering regardless of age or nationality. Despite the high prevalence, the primary dysmenorrhea among girls is often poorly diagnosed and is even ignored by medical workers and the girls themselves and



their mothers who can take painful menstruation as a normal part of the menstrual cycle. If the pathological situation occurs in the body of the growing female body, the formation of pathological states of organs and tissues in the form of dysplastic manifestations from the connecting tissue is occurred. A large variety of clinical criteria for the severity of undifferentiated connective tissue dysplasia (CTD), but the features of the metabolism of the connective tissue are still unclear. To date, it has been established that human endometrium undergoes cyclic waves of proliferation, differentiation, apoptosis and regeneration, depending on the increase and decrease in the levels of estradiol synthesized in the ovaries and progesterone. The synthesis of specific proteins of estrogen alpha-receptors was determined by the ER $\alpha$  genome (ESR1). This gene is located on chromosome 6Q25. It consists of 8 exons, 7 intron and occupies more than 140 kilobes. Molecular mechanisms, thanks to which these polymorphisms affect the activity of receptors, remain intact. RFLP is found in the intron, i.e. The almost non-functional region of the gene, and since they are separated by 50 pairs of bases, are presumably in a strong linear clutch.

**THE PURPOSE OF THE STUDY IS:** to establish the role of molecular genetic mechanisms of violation of endometrial regulation on the basis of a survey of single polymorphisms of genuine receptor genes of genital steroids, regulation of angiogenesis, in patients with dysmenorrhea.

**MATERIAL AND METHODS OF RESEARCH:** We examined girls with YUD (n = 64) compared with the control group (n = 50). For the release of DNA, venous blood was served from the elbow vein, with the detection of estradiol-alpha receptor genes, polymerase chain reaction (PCR), which was carried out using specific primers (NPF Litech, Russia) in the automatic amplifier "Rotor Geene 6000". The concentration of serum and estradiol (E2) was determined by the IFA methods on the AT-858 analyzer (ShangheiAntaiDiagnostics CO, LTD) using the ELISA test system sets - Austria. The data obtained in the study was subjected to statistical processing on the Pentium-IV personal computer using the Microsoft Office Excel-2012 software package, including the use of built-in statistical functions.

### THE RESULTS OBTAINED AND THEIR DISCUSSION.

Analysis of the distribution of allelic variants of the ESR1 G2014A gene, according to Table 1, showed that the frequency of occurrence of a mutant allele (a) in a group of patients with YUD, accompanied by CTD reliably higher compared to the control group of practically healthy persons ( $\chi^2 = 3,999$ ,  $p < 0.04$ ,  $OR \geq 1.92$ ). A reliable increase in the homozygous genotype with the participation of risky alleles AA also met significantly more often compared to the control group, with the indicators  $\chi^2 = 3.716$ ,  $p = 0.053$ . This gives grounds for assumption that YUD in girls with CTDs may have a genetically deterministic origin.

**TABLE 1 DISTRIBUTION OF FREQUENCIES OF ALLELES AND GENOTYPES OF THE ESR1 G2014A GENE IN GIRLS WITH PRIMARY DYSMENORRHEAL WITH CTD COMPARED TO THE CONTROL GROUP OF PRACTICALLY HEALTHY FACES**

Genetic type	YUD + CTDn=64	YUD + CTD %	Genetic type	control, n=68	control, %	OR	$\chi^2$	P
G	99	77,34	G	118	86,76	0,52	3,999	0,04
A	29	22,66	A	18	13,24	1,92		
GG	44	68,75	GG	53	77,94	0,62	1,429	0,23

GA	11	17,19	GA	12	17,65	0,97	0,005	1
AA	9	14,06	AA	3	4,41	3,54	3,716	0,053

In the study of the distribution of allele variants of the ESR1 G2014A gene in the group of patients with YUD, accompanied by CTD (n = 64) compared with a group of girls with YUD without CTD (N = 54), showed that the frequency of the mutant allele (a) in the patient group YUD with CTD is reliably higher compared to the control group of girls with YUD without CTD ( $\chi^2 = 4.515$ ,  $p < 0.033$ ,  $OR \geq 2.14$ ). Homozygous risky genotype with the participation of alleles AA, also met significantly more often compared to a group of girls with YUD without CTD ( $\chi^2 = 3.718$ ,  $p = 0.05$ ,  $OR \geq 4.25$ ) (TAB. 2).

**TABLE 2 DISTRIBUTION OF FREQUENCIES OF ALLELES AND GENOTYPES OF THE ESR1 G2014A GENE IN GIRLS WITH YUD WITH CTD COMPARED TO THE CONTROL GROUP AND FROM YUD WITHOUT CTD**

Genetic type	YUD + CTD, n=64	YUD + CTD, %	Genetic type	YUD + Without CTD, n=54	YUD + Without CTD, %	OR	$\chi^2$	P
G	99	77,34	G	95	87,96	0,47	4,515	0,033
A	29	22,66	A	13	12,04	2,14		
GG	44	68,75	GG	43	79,63	0,56	1,79	0,2
GA	11	17,19	GA	9	16,67	1,04	0,006	1
AA	9	14,06	AA	2	3,70	4,25	3,718	0,05

At the next stage, it was decided to analyze the distribution of frequencies of the occurrence of allele variants and ESR1 G2014A genotypes in the group of girls with YUD without CTD compared with almost healthy persons in population control.

**TABLE 3 THE DISTRIBUTION OF THE FREQUENCIES OF ALLELES AND GENOTYPES OF THE ESR1 G2014A GENE IN GIRLS WITH YUD WITHOUT CTD COMPARED TO THE CONTROL GROUP OF PRACTICALLY HEALTHY FACES.**

Genetic type	YUD + Without CTD, n=54	YUD + Without CTD, %	Genetic type	controle, n=68	controle, %	OR	$\chi^2$	P
G	95	87,96	G	118	86,76	1,11	0,078	0,78
A	13	12,04	A	18	13,24	0,90		
GG	43	79,63	GG	53	77,94	1,11	0,051	0,8
GA	9	16,67	GA	12	17,65	0,93	0,02	0,8
AA	2	3,70	AA	3	4,41	0,83	0,038	0,8

As can be seen from Table 3 during the analysis of these groups, there were no reliable markers.

The indicators obtained during the study of the level of estradiol in the blood of girls with primary dysmenorrhea, depending on the presence of CTD criteria are given in Table. four.

**TABLE 4 ESTRADIOL CONTENT IN BLOOD SERUM (NMOL / L)**

Group	estradiol
Practically healthy, n=25	0,9±0,12
YUD + Without CTD	

Light, n=10	0,85±0,06
Average, n=31	0,85±0,04
Heavy, n=15	0,85±0,04
YUD with CTD	
Light, n=24	0,56±0,16 <sup>a,6</sup>
Average, n=100	0,52±0,06 <sup>a,6</sup>
Heavy, n=50	0,47±0,12 <sup>a,6</sup>

Note: A - Differences regarding these groups of healthy girls are significant, B - differences regarding these groups of girls with YUD without CTD meaning ( $P < 0.05$ ).

In the group of girls with a might of a light degree without the presence of criteria, the estradiol content in serum has only a tendency to reduce the values of practically healthy girls and amounted to  $0.85 \pm 0.06$  nmol / l. These values corresponded to the norms of the norm in the 2nd phase of the cycle. In the group of girls with an average and heavy degree of dismenoria, the preservation of the regulatory quantities of estradiol was revealed. In girls with the presence of criteria for CTD, with a light severity of the severity, the separation of estradiol in serum was significantly reduced in 1.6 ( $p < 0.001$ ) times compared with the indicators of a group of practically healthy girls, in 1.51 ( $p < 0.05$ ) times Regarding the values of a group of girls with YUD without manifestation of CTD. As can be seen from the given data, the level of estradiol in the blood serum decreased more pronounced. As the pathological process progresses the content of estradiol even more decreased, especially with a severe degree of dismenoria. Thus, the level of estradiol in the blood serum of girls with an average degree of primary dismenoria decreased in 1.73 ( $p < 0.001$ ) and 1.63 ( $p < 0.05$ ) times, relative to the values of a group of girls with YUD without manifestation of CTD and practically healthy girls. That is, patients with CTD, at YUD, there was a hypooestroy. In the group of girls, the Estradiol in serum in the Signs of the CTD is 1.9 ( $p < 0.001$ ) and 1.8 ( $p < 0.05$ ) times, relative to the values of a group of girls with YUD without manifestation of CTD and practically healthy girls . A strong reverse correlation was noted between the severity of dysmenorrhea and the content of estradiol ( $R = -0.92 \pm 0.1$ ,  $p < 0.01$ ), and the presence of the manifestation of the Girls from the YUD is exacerbated by hypoethroemia.

It is interesting to note that the data obtained during genetic studies are consistent with the indicators obtained during the study of estradiol levels in the blood of girls with primary dysmenorrhea, depending on the presence of CTD criteria (Table 4).

Conclusions: 1. The presence of a mutant allele A, as well as a homozygous genotype AA in the ESR1 G2014A genotype in women, can affect the level of estradiol levels in the blood.

2. Genetic analysis revealed the intelligence of a mutant allele of the estrogen receptor gene - alpha (single-meter replacement of guanin on adenine in RS2228480) 1.9 times higher in the group of girls with YUD with CTD than in the YUD group without CTD ( $\chi^2 = 4,515$ ;  $p = 0.03$ ).

**REFERENCES:**

1. Gynecology. National leadership. Gootar "Media". Association of Medical Societies in Quality. 2011.- P. 428-437
2. Children's and teenage gynecology. Uvarova E. V. - Moscow, 2009. - P. 301-318.
3. Gromova O.A. The multifaceted role of macro and trace elements in the construction of bone tissue / Gromova O.A., Torshin I.Yu., Limanova O.A. // Gynecology. - 2014. - T. 16. - № 2. - P. 50-56.
4. Gynecological endocrinology and reproductive medicine. Michel von Wolff, Peter Stit Pen. with it. Under Proc.D.Dt.Med.NukProf.E.N.andreyeva Moscow Honey Press Inform 2018 P.96-101
5. The National Recommendations of the Russian Scientific Medical Society of therapists on the diagnosis, treatment and rehabilitation of patients with connective tissue dysplasia, developed by the Group Dysplasia section of the RNot, approved at the National Congress of Therapists on October 14-16, 2015. Medical Bulletin of the North Caucasus 2016. T.11 No. 1 - pp. 247-248.
6. Ozhogina E. V., Moses V.G. The quality of life of women with primary dysmenorrhea. // Questions of gynecology, obstetrics and perinatology. - 2016. - № 1. - P. 42-44
7. Optimization of the choice of the method of operational treatment in patients with complicated formations of the Genital prolapse / S.N. Buyanova, N.A. Schukina, MA Chechnev [et al.] // Russian Bulletin of the Acoucher-Gynecologist. - 2012. - №6. -S87-91.
8. Orlova V. S., Trushina O.V., Kalashnikova I.V. Connective tissue dysplasia is a factor that aggravates the menstrual painful syndrome in adolescence // Magazine of obstetrics and female diseases. - 2018. - T.67. - No. 1. - P. 38-46.
9. Pubyrev, V.P. Pathological anatomy of human genome / V.P.Pubyrev, V.A.Stepanov. - Novosibirsk: Science. Sib.Enterprise RAS, 1997. - P. 22.
10. Systematic analysis of the molecular-physiological effects of the synergistic effect of iron, manganese and copper on the connective tissue / N.V. Kerimkulova, I.Yu. Torshin [et al.] // Reproductive Endocrinology. - 2013. - №4 (12).- p. 101-110].
11. Trushina O.V., Orlova V.S., Kalashnikova I.V. et al. Physical development and somatic background of adolescent girls, suffering from dysmenorrhea, combined with connective tissue dysplasia // Scientific statements. A series of medicine.Pharmacy. 2018. Volume 41. No. 1. C.36-45
12. Chaika G.V., Lomakhuk B. O., Kucherenko O. M. Lychanni Look at Etiologist PervinoDyemenorje. (L\_TeaturiL\_Teaturi) Actual Pedyatnia, Obstetrics, Ta Ginecology. Obstetrics of that ginecology. - 2015. # 2. - P. 183 - 188.
13. AbaraoguUo, Igwe SE, Tabansi-Ochiogu CS, DuruDo.A Systematic Review and Meta-Analysis of Therapy in Women with Primary Dysmenorrhea.Explore (NY). 2017 NOV - DEC; 13 (6): 386-392. DOI: 10.1016 / J.EXPLORE.2017.08.001. EPUB 2017 Aug 30.

14. Anderson A. RESENT ADVANCES IN THE GENETICS OF ALERGY AND ASTHMA / A. ANDERSON, W.O.C.M. Cookson // MOL. Med.Today. - 1999. - V. 5. - P. 264-273.
15. Blackstock CD, Higashi Y, Sukhanov S, et al. Insulin-Like Growth Factor-1 Increases Synthesis of Collagen Type I Via Induction of the Mrna-Binding Protein Larp6 Expression and Binding to the 5 'Stem-Loop of Coll1a1 and Coll1a2 Mrna. J Biolchem. 2014; 289 (11): 7264-7274. DOI: 10.1074 / jbc.m113.518951
16. Chen CX, Shieh C, Draucker CB, Carpenter JS. Reasons Women Do Not Seek Health Care for Dysmenorrhea.jClinnurs. 2018 Jan; 27 (1-2): E301-E308. DOI: 10.1111 / JOCN.13946. EPUB 2017 SEP 7.
17. De Sanctis V, Soliman AT, Elsedfy H, Soliman Na, Soliman R, El Kholy M. Dysmenorrhea in Adolescents and Young Adults: A Review in Different Country.acta Biomed. 2017 jan 16; 87 (3): 233-246.
18. Feng X, Wang X. COMPARISON OF THE EFFICACY AND SAFETY OF NON-STEROIDAL ANTI-INFLAMMATORY DRUGS FOR PATIENTS WITH PRIMARY DYSMENORRHEA: A NETWORK META-Analysis.mol Pain. 2018 Jan-Dec; 14: 1744806918770320. DOI: 10.1177 / 1744806918770320. EPUB 2018 Mar 27.
19. GULTIA, EDMUND JOSEPH, ET AL. "Ginger Root DecoptioAs Pain Reliever Among Adolescents with Primary DysmenorRhea." Asian Journal of Health 3 (2013): 1+ Academic Onefile. Web. 25 May 2016.
20. IACOVIDES S., Avidon I., Baker F. C. Women With Dysmenorrhoea Are Hypersensitive to Experimentally Induced FrearmIschaemia During Painful Menstruation and During The Pain-Free Follicular Phase // EUR J Pain. - 2015. - 19: 797-804.
21. JO J, Leem J, Lee Jm, Park KS. Herbal Medicine (Hyeolbuchuko-Tang or XuefuzhuyuDecoptio) for treating primarydysmenorrhoea: Protocol for a Systematic Review of Randomised Controlled Trials. BMJ Open. 2017 Jun 15; 7 (6): E015056. DOI: 10.1136 / BMJOPEN-2016-015056.
22. Pattanittum P, Kunyanone N, Brown J, Sangkomkamhang US, Barnes J, Seyfoddin V, Marjoribanks J. Dietary Supplements for Dysmenorrhoea. Cochrane Database Syst Rev. 2016 Mar 22; 3: CD002124. DOI: 10.1002 / 14651858.cd002124.pub2.
23. Woosley J. A., Lichstein K. L. Dysmenorrhea, The Menstrual Cycle, and Sleep // Behav. Med. - 2014. - Vol. 40. - P. 14-21.

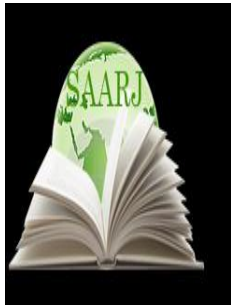

**ACADEMICIA**  
**An International  
 Multidisciplinary  
 Research Journal**  
 (Double Blind Refereed & Peer Reviewed Journal)



**DOI: 10.5958/2249-7137.2021.01184.8**

**LANGUAGE AND CULTURE**

**G. Akramova\* ; N. Mullaeva\*\***

\*Teacher Fergana State University,  
 UZBEKISTAN

\*\*Teacher Fergana State University,  
 UZBEKISTAN

**ABSTRACT**

*This article contains ideas about the relationship between language and culture, their linguistic interpretation, interdependence. Some languages are spoken by tens or even hundreds of millions of people, while others are spoken by thousands, hundreds, or even countless people. For example, Congolese speak 500 languages, Indonesians 250, and Sudanese 117. Language and culture can be seen as a relative asymmetry. The reason for this can be explained by the fact that the representatives of many countries around the world carry out the process of communication in a single language.*

**KEYWORDS:** *Linguoculturology, language, culture, linguistic world, scale, specific language, linguistic feature, mentality, ancient, ethnic, national identity, ontogenesis, phylogeny, communication, ethnoculture.*

**INTRODUCTION**

In linguoculturology, the subject of comparison of language and culture has a special significance. According to Russian linguists E.M. Vereshchagin and V.G. Kostomarov, language and culture are closely interrelated concepts. [1.] In fact, such notions go back to ancient times. They agreed that there was no doubt that the spiritual dimension of language came from the world. Undoubtedly, the sphere of influence of language on culture has its own power. This means that language and culture cannot be imagined in isolation”.

The problem of the commonality of the concepts of “people” and “language” in the Indo-European, Finno-Ugric, Turkic, and African language families has been in the constant focus of scholars since ancient times.

Because, if we look at history, when we say people, we mean a group of people who speak several languages, but when we say language, we mean the language that exists in the consumption of the people. A particular language is a means of distinguishing the national characteristics of one nation from another. It is important that the ethnic and linguistic characteristics of the population are interrelated. These similar features in them are remarkable in that they were more clearly manifested in primitive times.

## **MATERIALS AND METHODS**

Gradually, as tribal units evolved from large to small and, conversely, from small to large communities, the ethnic and linguistic characteristics of the communities changed accordingly. In contrast to the growing state of human society, the process of convergence of languages was slow. Often, we see representatives of the same people speaking different languages, and in some peoples, we observe their communication in a single language.

For example, while the state language of the Uzbek people is Uzbek, representatives of more than 130 nationalities speak mainly Uzbek, Russian, Tajik, Tatar, Korean, Azerbaijani, Turkmen, Kyrgyz, and Turkish. Switzerland, on the other hand, is a Swedish nation, with a population mainly speaking Romanian, German, Italian and French.

Language and culture can be seen as a relative asymmetry. The reason for this can be explained by the fact that the representatives of many countries around the world carry out the process of communication in a single language. For example, German-speaking Germans and Austrians, Portuguese-speaking Portuguese, Brazilians and 5 other African countries, Spanish-speaking Spanish and 20 citizens of Latin America, English-speaking Americans as well as Americans, Canadians, Australians and again used by a large proportion of South African countries. In addition, citizens of 19 countries in Africa also officially speak English. Also, the Indian people also speak mainly English after their mother tongue.

According to experts, it has been found that there are more languages than there are peoples on Earth.

According to the Uzbek linguist, Professor BR Mengliev, "there are more than 3,000 languages in the world, and according to some sources, there are about 7,000 languages. The UN has officially announced that there are 2,976 languages.

## **RESULT AND DISCUSSION**

Some languages are spoken by tens or even hundreds of millions of people, while others are spoken by thousands, hundreds, or even countless people. For example, Congolese speak 500 languages, Indonesians 250, and Sudanese 117. Chinese is spoken by about a billion people around the world, while Chukot and Vele are spoken by only a few hundred thousand people. Or that there are more than a million people in Dagestan who speak about 40 languages. According to a 2012 census in Russia, 40 people in Dagestan speak Baghula, 12 people speak Chamala, and five people speak Kaitags. In New Guinea, almost every village has its own language".

It can be said that language cannot be the main factor in the emergence of national identity. There is a factor of religious affiliation between the sense of national identity and the relationship of language, and the belief in a particular religion can also determine the national characteristics of a particular nation. However, it should not be forgotten that Japanese Shinto,

which is practiced by members of one nation, in contrast to the Armenian-Gregorian churches, The Shari'a rules of Islam bring together the sense of identity of people of different nationalities who are not brothers. The most virtuous qualities peculiar to a Muslim, if necessary, constitute the criteria of national spirituality.

In particular, concepts such as humanity, justice, honesty, tolerance are one of the highest values that affect not only the national identity of the Uzbek people, but also its spiritual foundations.

According to N.B.Mechkovskaya, in the context of the comparison of language and culture, we think that they should talk about interdependent determinism. That is, language and culture are interrelated as follows:

1. in the communicative process
2. ontogenesis (in the process of formation of speech ability)
3. in phylogeny (formation of a social person).

In his article, the Uzbek linguist A.Nurmonov commented on the theories of linguistic relativity and linguistic determinism, as well as the relationship between language and culture.

He acknowledges the ideas of the founders of the theory of linguistic relativity, B. Wharf and E. Sepir, that language and thought are forms of culture, and at the same time dwells on the commonality of languages: "Every language not only reflects the spirit of the people, the national culture, the way of seeing and perceiving the world, but also has such commonalities in the creation of images between languages that are the product of universal thinking".

A.Nurmanov divided the scholars into 3 groups: "The first group is connected with the names of V.Humboldt, E.Sepir and B.Worf, who considered language as a unifying force in the relations of language and thinking, language and culture", concludes and interprets this idea as a one-sided view.

The Uzbek linguist notes that in understanding the center of the image on which the nomination is based, it is impossible to ignore the general aspects of different languages. This suggests that the conclusion of the theory of linguistic relativity about the primacy of language in the perception of the world is one-sided.

A.Nurmonov [2] points out that the scientists of the group in their views completely denied the connection between language and culture. According to him, the third group of scholars synthesizes these views and states that "language and culture are interrelated and at the same time different phenomena.

The role of language in the relationship of language and culture is great. The ethnoculture of each nation finds its own expression through its own language. But because of the existence of this ethnoculture in the objective being, it also manifests itself through language.

Linguistic mentality, in contrast to consciousness, not only reflects the realities of the external world in the individual, but also connects these perceptions with cognitive space, and this conceptual content is relevant to the specific national-lingual (linguistic) community in each particular moment of time. occurs through.



## CONCLUSION

In understanding the essence of mentality, we must not overlook the interdependence of concepts such as language, culture, ethnos. We observe an isomorphism in the structure of language and culture in the system of signs of generality and specificity of language and culture.

In particular, the concept of speech culture refers not only to the norms of the Uzbek literary language, but also to the norms of the national language, [3.]

These norms include specific norms of dialects. Therefore, approaching the above concept of isomorphism, N.I.Tolstoy establishes the following classification:

- a) elite culture;
- b) folk culture;
- c) intermediate culture;
- g) traditional-professional culture.

So, instead of concluding, we can say that there is a mutually conditioned duality between language and culture. Language, as a linguoculturological phenomenon, embodies cultural riches, and the development of any national culture, at the same time, depends on the specific nature of a particular language. At the same time, language can express the whole world by itself, it can embrace a multifaceted culture, a diverse society from a lexical-semantic point of view.

## REFERENCES:

1. Sh.Makhmaraimova. Linguoculturology. T., 2017.-164b.
2. Educational-methodical complex on anthropocentric linguistics.// Compilers: D.E.Lutfullaeva, D.S.Khudoyberganova.Tashkent, 2016.-21p.
3. Vereshchagin E.M., Kostomarov V.G. Language and culture.-M .: “Indrik”, 2005.-1040p.
4. “Map of the peoples of the world” -M., 1961.
5. IlkhomAbdirakhimov. Development of effective demulsifiers on the basis of local raw materials // Universum: техническиенауки: научныйжурнал. – № 2(83).Часть [4] М.,Изд. «МЦНО», 2021. DOI: 10.32743/UniTech.2021.83.2-4.36-39.

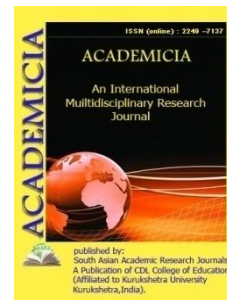
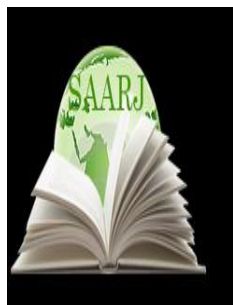

DOI: **10.5958/2249-7137.2021.01183.6**

## THE ENLIGHTENMENT ACTIVITY OF BEHBUDI

**N.Urinbaev\***

\*Associate Professor, Senior Lecturer,  
Candidate of Philosophical Sciences,  
Institute of Advanced Training under the Fergana Regional Department of Public Education,  
UZBEKISTAN

### ABSTRACT

*This article describes Behbudi's enlightenment activities, Jadid schools in Turkestan, the education system and the idea of its reform, views on the national education system, the work done by the Jadids in this direction and the specific problems. The author, for example, in recent chapters has cited the views of world and Turkestan scientists on the formation of the earth, and has given insights into geographical objects and terms such as maps, globes.*

**KEYWORDS:** *Turkestan, Jadid, Reform, Local, Enlightenment, School, National Liberation, Tsar, Administration, New Method, Geography, Russia, Children's Book, Islam, History, Globe, Scientific, Practical, Censorship, Exam, Manual, Policy.*

### INTRODUCTION

The emergence of Jadid schools in Turkestan dates back to the end of the XIX - beginning of the XX century. According to experts, the idea of reforming the education system came to Turkestan fifteen to twenty years later than in Crimea, Kazan and Azerbaijan. The main reason for this was the policy of the Governor-General of Turkestan aimed at consciously keeping the local population away from enlightenment. The fact that an enlightened people could fight for their rights, for freedom from colonial oppression, and for national liberation, forced Tsarist Russia and its administration in Turkestan to remain vigilant.

### MATERIALS AND METHODS

The secret service of the governor-general's office, the Tsarist Okhranka, closely monitored every step taken by the local intelligentsia to reform the education system. Even at the end of the 19th century, when new methodological schools began to open, a special commission was formed for the Turkestan educational district. The commission decided to put an end to the unauthorized construction of new schools. The resolution contained the following articles:

1. Local schools are opened with the special permission of the tsarist administration.
2. The opening and teaching of local schools is allowed only to Russian citizens who are politically credible.
3. Only books published with the permission of Russian censorship are taught in local schools.
4. Persons who open a school without a special permit are deprived of the right to open a school and teach for life ...

Despite such barriers in front of the new schools, the selfless children of the people, including Behbudi, who at the beginning of the last century set out to open “usul savtiya” (sound method) schools. One of the first “usul savtiya” schools opened in Samarkand was opened in 1903 in the village of Rajabamin, Jambay district, in the yard of the famous enlightener Abdukadir Shakuri.

Behbudi contributed to the establishment and operation of this school. But Behbudi moved him to his backyard because there were not many commuters from the city among the schoolchildren and it was difficult for them to attend Rajabamin village. During these years, he taught the students of this school “Muntahabi Geography” (“Brief General Geography”), “Madhali Geography Umrani” (“Introduction to Population Geography”), “Brief Geography of Russia” (“Brief Geography of Russia”), he created textbooks and manuals such as “Kitabat ul-Atfol” (“Children’s Book”), “A Brief History of Islam” (“A Brief History of Islam”).

This in itself tests to the fact that Behbudi was an enlightener who set himself the task of imparting both religious and secular knowledge to his students.

Behbudi's Selected Works (1999), published by Ma'naviyat, gives us a clear idea of his two textbooks and manuals. One of them is Kitab ul-Atfol. Behbudi gave examples of types of letters, giving students an idea of the conditions of writing and the skills of writing in it, as they could not learn the skills of writing, despite the fact that they studied in ancient schools for four or five years.

Excerpts from the book “General Geography” give information about the meaning of the word “geography”, when did the science of geography, the importance of studying this science, as well as about the countries of the world. In addition, the textbook includes chapters “Old and new sages”, “Sages of Turkestan”.

The author, for example, in recent chapters has cited the views of world and Turkestan scientists on the formation of the earth, and has given insights into geographical objects and terms such as maps, globes. These books, which were of great scientific and educational importance in their time, have long served as textbooks and manuals in other schools in Samarkand.

In his article "On the examination of the Samarkand method Jadid school" Behbudi wrote that these textbooks and manuals were taught at the Shakuri school and students took the exam on their basis: In our book Madhali Geography of Umrani and Brief Geography of Russia, we describe the distance (measurement) of Russian countries in Europe, Asia, Africa, America and Australia, as well as the number and time of each country and government, and the distribution of Russia. They described in detail and memorized the old and new continents of the population, the territories and seas, and the number of Muslims, Christians, Jews, and Magians on earth [ 1. ].

In addition to educators, Likoshin and Vyatkin, on behalf of the local government, as well as bailiffs, merchants and shopkeepers, took part in the examination described in the article. The exam, which lasted two days from 10 a.m. to 6 p.m., left a good impression on them. Most of them praised the students' knowledge, while some even cried out of excitement.

“Haji Mavlonbek”, writes Behbudi, “stood for six hours, weeping over the children's answers to the questions of religion and knowledge, and gave the teacher a gift of 15 soums”. [2].

The knowledge and examination held on the basis of Behbudi's textbooks and manuals at the Shakuri school raised the prestige of the Jadid schools in the eyes of the public, in which Behbudi's services were not insignificant.

## RESULT AND DISCUSSION

This ardent propagandist of science not only opened a school and wrote textbooks and manuals, but as one of the great public figures of Turkestan region in 1907 sent to the Muslim faction of the 3rd State Duma of Russia to consider the project “Cultural Autonomy of Turkestan”. Unfortunately, the 3rd State Duma ignored this project developed by Behbudiy. However, if approved, the project would have a significant impact on the social life of Turkestan.

Our compatriot, who found this historical document in foreign archives, wrote the following about Doctor Temir Khoja ugli: “... if this text is carefully studied, it is clear that Behbudi wanted autonomy for Turkestans living in Turkestan under Tsarist Russia (excluding the Emirate of Bukhara and the Khiva Khanate), which was more courageous than its time and demanded broad rights. One of the two most important topics in the draft is the privatization of schools (Article 18) and the other is that the Russian State Duma should not interfere in the internal affairs of Turkestan [1].

Behbudi also presented a section entitled "General Schools" in the "Draft" presented to the Muslim faction of the 3rd State Duma, in which the following issues were asked to have legal force:

17. “Let the question and article of general education in Russia make Turkestan an equal (inclusive) community.

18. Turkestan schools and madrassas should be free from government control.

19. To appoint a commission from Muslims for general higher and secondary school.

The Russian alphabet should not be used in Islamic schools.

20. There are Muslims in various enterprises, prisons and military bases, and a Muslim priest should be appointed” [2].

These articles of the draft testify to the fact that Behbudi took a bold step from the Enlightenment to the independence movement as early as 1907.

Behbudi later founded Oyna magazine, which published articles encouraging young people to acquire religious and secular knowledge and to master not two but four languages. Writing a series of articles based on various travel impressions, he provides convincing evidence that the scientific and cultural progress taking place in the East and especially in the West is the result of the great attention paid to science in those countries.

**CONCLUSION**

There is also information that one of the leaders of the National Awakening Movement in those years acknowledged Behbudi's views that the reform of the education system alone was not enough to achieve the "cultural autonomy of Turkestan". In conclusion, it can be said that he and the true children of a nation like his will never tire of fighting for the happiness, future, prospects and independence of their people.

They will always faithfully serve the Motherland and its people. They can always, at any time, in any field be an example and role model for the younger generation.

**REFERENCES:**

1. Newspaper of Turkestan region, 1096, issue 27.
2. World Literature, August 2003.-P.148.
3. Naim Karimov. Mahmudkhoja Behbudiy. Tashkent, 2011, -P.80.
4. Ilkhom Abdirakhimov. Development Of Effective Demulsifiers On The Basis Of Local Raw Materials // Universum: Технические Науки: Научный Журнал. – № 2(83). Часть [4] М., Изд. «МЦНО», 2021. Doi: 10.32743/Unitech.2021.83.2-4.36-39.

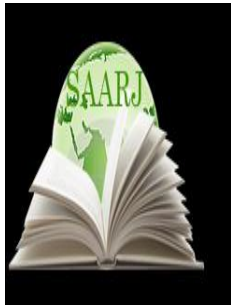

**ACADEMICIA**  
**An International  
 Multidisciplinary  
 Research Journal**  
 (Double Blind Refereed & Peer Reviewed Journal)

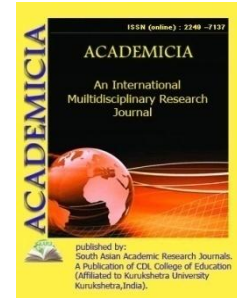

**DOI: 10.5958/2249-7137.2021.01182.4**

## THE PROBLEM OF PROTECTION AND USE OF ARCHITECTURAL RESERVES OF HISTORICAL CITIES OF UZBEKISTAN

**Kahhorov Azimjonc Xurramovich\***

\*Jizzakh State Pedagogical Institute,  
 UZBEKISTAN

Email id: azimjon\_piter@mail.ru

### ABSTRACT

*This article reveals the trends in the formation of tourist complexes in historical cities and protected areas rich in historical and cultural monuments; to study their impact on the formation of master plans and the preservation of historical monuments in the cities included in the tourism system, the types and categories of service enterprises, their location, as well as their high socio-economic efficiency. Recommendations have been developed for the preservation and rational use and preservation of architectural, historical and cultural monuments.*

**KEYWORDS:** *Architecture, History, Tourism, Monuments, Territory, Heritage, Tourism, Development, Development, Resources, Architecture.*

### INTRODUCTION

The problem of preserving and using the architectural reserves of historically formed cities of Uzbekistan reflects the general level of urban planning ideas, including the attitude of the Uzbek people to the heritage and care for its future. They are witnessing significant qualitative changes in the process of changing the historical parts of the cities of Uzbekistan.

In terms of its tourism resources, Uzbekistan is one of the leaders in Central Asia and one of the 10-15 countries in the world with unique potential in this area. In ancient times, the cities along the Great Silk Road, which connected China with European countries, have many architectural monuments of historical periods, which are undoubtedly of great interest to tourists.<sup>1</sup>

Decree of the President of the Republic of Uzbekistan "On measures to restore the Great Silk Road and strengthen the participation of the Republic of Uzbekistan in the development of international tourism in the Republic of Uzbekistan" of June 1995, Resolution of the Cabinet of Ministers of the Republic of Uzbekistan dated 30.06.1999 The Law of the Republic of

Uzbekistan "On Tourism", adopted on 20.08.1999, provides for the development of schemes for the development of promising tourism for the historical cities of Uzbekistan.

The volume of tourism in Uzbekistan is constantly growing. In the list of enterprises of the Central Council for Tourism and Excursions of Uzbekistan alone, the total volume of tourism in 1990 was 31.4 million people, and in 1991 - 33.4 million people, including tourists and amateurs on weekends, tourists and other categories. The growth rate of domestic and foreign tourism, on the one hand, due to the increase in leisure time of workers, the growth of material prosperity, the growth of the cultural level of the population and, on the other hand, the trend of active recreation, reaches about 5% of annual flow.<sup>2</sup>

The variety of tour itineraries, the opportunity to get acquainted with the historical past and modern life of the protected area or city, as well as the most favorable conditions for a study tour, along with the rest of the historical nature. Therefore, the range of issues that need to be addressed has become much wider, and as a result, we have come to develop in all respects all the key aspects of tourism development in the project area.



1 picture. Samarkand .2018.

Tourist organizations do not spend money on additional services for tourists and do not receive adequate income from them. This, of course, not only reduces economic efficiency, but also has a significant impact on the tradition of introducing tourists to the traditions of the destination area. The developed system of additional service enterprises - the production and trade of art monuments, national cuisine, the demonstration of folk traditions in wonderful traditions, etc. - all this not only helps to expand the flow, but also the rich history and culture of tourism.

It should be borne in mind that tourism has a significant impact on the development of urban planning. Preservation and rational use of architectural, historical and cultural monuments; reconstruction of old ones and beautification of new cities; transport, road construction; utilities; local industry and trade - it is expedient to plan all this, taking into account the prospects for the development of tourism, the share of capital investment in the development of these areas of activity.

## **MATERIALS AND METHODS**

The great place allocated to the tourism economy is determined, first of all, by the fact that we see a real economic basis for the preservation and rational use of monuments in tourism, the creation of conditions that have been preserved for many years, occupying a worthy place in architecture. - Spatial structure of cities. This approach stems from the Law of the Republic of Uzbekistan "On the Protection and Use of Cultural Heritage" adopted by the OliyMajlis.<sup>3</sup>

The law itself already represents the unity of beings and ways to solve the problem. Taking into account the different techniques and methods of including tourism in the structure of the ancient city, we can simultaneously find the optimal way to use the architectural monuments in search of the optimal functional organization of tourism, to find new ways to adapt them.

## RESULT AND DISCUSSION

Based on the above, we emphasize that the systematic design of tourism should probably be the basis for the planning, construction and operation of tourist complexes - as highly efficient state-owned enterprises. Tourism is able to actively influence the development of related sectors of the economy and, first of all, one of the most difficult problems of modern architecture and urban planning - the preservation of the historical appearance and architectural monuments of the rich cities of our republic.

The existing structure of the ancient city, the preservation of all the architectural monuments and valuable houses in their environment, the ethnographic zones that meet the national and climatic features and national characteristics, and the living environment - a functional environment. Consists of identification.

## CONCLUSION

Provision of the territory with engineering facilities, organization of tourist zones and reconstruction of handicraft and trade streets. Formation of a buffer zone between the "Old and New" city and administrative territories; development of a single-storey residential building or residential complex. to satisfy the conditions of development in the historical zone, to create places for the use of the labor force, taking into account the peculiarities of the historical zones.

## REFERENCES

1. Ахмедов М.К. Самарқанд меъморий ансамблларининг янги ҳаёти // Архитектура и строительство Узбекистана. Ташкент, 2007. №3. – С.32.
2. Лавров В.А. Градостроительная культура Средней Азии. М., 1950., с.178.
3. Ноткин И.И., Гордеева И.И. Памятники архитектуры и реконструкции городов Узбекистана, «Строительство и архитектура Узбекистана», 1972., с.7–11.
4. Салимов А.М. Из опыта приспособления памятников архитектуры для современных функций // Архитектура и строительство Узбекистана. Ташкент, 1990. – №3. – С.26-28.
5. Холиков, С. Р. (2021). Историческое развитие архитектурного комплекса Хазрати Имам (ХАСТИМОМ). INTERNATIONAL JOURNAL OF DISCOURSE ON INNOVATION, INTEGRATION AND EDUCATION, 2(1), 104-107.
6. Жонузаков, А. Э., & Холиков, С. Р. (2020). Архитектурный комплекс Хазрати Имам (Хастимом)-пример сохранения и использования культурного наследия в Узбекистане. Academy, (11 (62)).
7. Холиков, С. Р. (2021). Марказий Осиё архитектура ёдгорликлари гумбазларининг турлари. INTERNATIONAL JOURNAL OF DISCOURSE ON INNOVATION, INTEGRATION AND EDUCATION, 2(2), 40-43.
8. Pkhom Abdirakhimov. Development of effective demulsifiers on the basis of local raw materials // Universum: технические науки: научный журнал. – № 2(83). Часть [4] М., Изд. «МЦНО», 2021. DOI: 10.32743/UniTech.2021.83.2-4.36-39.





**ACADEMICIA**  
**An International  
Multidisciplinary  
Research Journal**  
(Double Blind Refereed & Peer Reviewed Journal)



**DOI: 10.5958/2249-7137.2021.01181.2**

**NEW GENERATION SPECIALISTS IN THE RENEWING UZBEKISTAN:  
COMPARATIVE ANALYSIS OF NATIONAL AND FOREIGN  
EXPERIENCE**

**Ganiev Oybek Nuriddinogli\***

\*Researcher of the National University of Uzbekistan,  
Employee of the State Testing Center under the Cabinet of Ministers,  
Republic of UZBEKISTAN  
Email id: oybekg@yahoo.com

**ABSTRACT**

*This article is a comparative analysis of the problems faced by specialists in the formation of the foundations of national statehood, the process of reforms to address public policy in the formation of a new system of specialists in public administration of independent Uzbekistan.*

**KEYWORDS:** *Independence, State, Society, Administration, Leading Experts, New Generation, Mental Centre, Institute, Soft Power, Brand.*

**INTRODUCTION**

The Action Strategy for the five priority areas of development of the Republic of Uzbekistan for 2017-2021, developed on the initiative of the President of the Republic of Uzbekistan Shavkat Mirziyoyev, pays special attention to public administration reform, development of an organizational and legal framework of public service. In this strategy is given the main purposes that the successful implementation of radical changes and reforms in the life of the state and society, first of all, the growing demand for young and enterprising professionals with solid knowledge in a market economy, able to understand and analyze the current foreign and domestic policy of Uzbekistan. What is the reason for this? Has not a new generation of specialists been formed for the independent state of Uzbekistan over the past 30 years? If so, why is there a need for a new generation of specialists for today's renewed Uzbekistan? We will try to answer such questions in our analysis.

## **MATERIALS AND METHODS**

### **Complications of the past**

Achieving political independence of Uzbekistan has allowed the formation of a new system of leaders and management specialists in public administration. This is a unique period which required the work to be done, the most important of which is the radical renewal of the system of leaders and managers formed during the former socialist regime, the training and retraining of leaders and managers to meet the requirements of a new political system and state and society building. This is "... the consistent continuation of the policy that has completely changed the image of our country and the meaning of our lives and the achievement of our goals, to become one of the developed democracies" [1], as well as "specialists who are able to solve large-scale, complex and broad tasks", "it is about training specialists who have a deep sense of responsibility for the fate of their homeland, its present and future, who think independently and innovatively" [2].

As the First President of the Republic of Uzbekistan I.A. Karimov noted in the early years of independence and he began to look at the life philosophy: "The fate of reforms, their effectiveness, impact on our lives depends, first of all, on the qualifications of specialists, their mastery, patriotism and dedication."

This is reflected in the following aspects:

The task of gradually forming a new generation of leaders and management specialists to strengthen and preserve independence in Uzbekistan has been identified as one of the most important tasks of the transition period. To solve this problem:

First, the lack of trained leadership professionals who understand independence and new market relations;

Second, the need for new thinking for existing managers and management professionals;

Third, the new system of specialists required the training of leaders and management specialists, taking into account such aspects as the formation of their political, management-related political thinking on the basis of the national idea.

Why? This is because the system of training leaders and management specialists of the "Soviet Party School", which existed in Uzbekistan during the former totalitarian system, was not abolished.

Therefore, the main achievement of the national interests of our country is that due to independence, Uzbekistan has moved to the foundations of a new system of leaders and management specialists, free from the single communist ideology, unique and appropriate, meeting the principles and requirements of national and democratic development.

To this end, the First President of Uzbekistan Islam Karimov identified the transition from administrative-command to democratic methods of governance in the country, the study of the role and place of leaders and management specialists in regulating all aspects of social relations.

Due to independence, the single-party system in the country was abolished. In place of the class-party, ideological principles of training, new human interests, the priority of freedom have been introduced. This led to the formation of a new political thinking in leaders and management

professionals. As a result, the Constitution of the Republic of Uzbekistan states that “social life in the Republic of Uzbekistan develops on the basis of diversity of political institutions, ideologies and opinions. No ideology can be established as a state ideology.

This set a new political pillar for the formation of a new system of leaders and management specialists in the country.

Based on this, we divide the stages of formation of the system of specialists in the development of independent Uzbekistan into the following periods:

The first stage: the first stage, which includes the first reforms and changes related to "... the transition period and the formation of the foundations of national statehood", the transition period 1991-2000, which left a huge mark on the life of our country and people;

The second phase, covering the period from 2001 to 2007, was a period of active democratic renewal and modernization of the country, which played an important role in ensuring the sustainable development of our economy, political life, the legislative, judicial and social humanitarian spheres. These reforms are inextricably linked with changes in the political thinking of public administration leaders and management professionals in the transition period. Each stage is characterized by significant practical achievements in the field.

The third phase covers the years 2010 to 2016. This period was a period of public administration reform, decentralization of public administration and development of civil society institutions in our country. Each of these periods is inextricably linked with its own reforms.

## RESULT AND DISCUSSION

### **"The greatest danger is in the level, knowledge, science and dedication of specialists"**

Shavkat Mirziyoyev's coming to power as President of the Republic of Uzbekistan is the fourth stage of the country's development, and from the first days the most painful point for our country was the dissatisfaction of specialists, their level and knowledge do not meet today's requirements. In particular, there is a need to attract about 1,000 foreign scientists and experts to develop various fields in Uzbekistan. This was stated by President ShavkatMirziyoyev on December 18, 2018, at a meeting on the need for modern specialists, the involvement of educated youth in strategic areas: In the current process of structural change, it has become clear that most professionals are not ready for this, and their knowledge, skills and abilities do not meet modern requirements. For example, the initial need for doctoral and master's degree training, advanced training and internships abroad are more than 3.5 thousand. Our country needs more than 600 compatriots with international scientific and practical experience. There is a need to attract about 1,000 foreign scientists and experts. That is, today the urgent need for ordinary scientific and scientific-pedagogical specialists is more than 5,000. If we take into account the demand for production, this figure will increase at least 50-100 times," he said.

Of course, there is a good reason for the head of state to tell such a sad truth. It is not in vain that these important statements are being made today to ensure the future of our country and its national interests. It is clear that if we do not pay serious attention to the issue of modern specialists, it will have a negative impact on the fate of the country.

In due course, it is useful to recall the words of the American statesman and military leader George Marshall: "A state that does not define its interests will work against its own people." [4]

While man's great creative potential directly serves to preserve the integrity of the universe, it binds his relationship of stability between nature, society, and man. In our country, too, the image of man, raising his dignity in all spheres of public life has risen as a top priority of our state policy. Nations and all religions and denominations have equal rights. After all, as the First President of Uzbekistan said, "... if any nation and people at a difficult turning point in history do not maintain their unity and solidarity, stand firmly in the pursuit of their national interests, there is no doubt that they will lose their independence and freedom, lose responsibility and vigilance, which are their greatest and unequal wealth" [6].

Today in our country it is directly related to the process of selection, training and placement of specialists. There will be no qualitative change in public administration without the creation of an effective system for the selection and training of innovative and independent-minded, responsible, enterprising, well-trained, patriotic, honest professionals [7]. So, our young people are provided with employment with a free, wide use of the desired professional skills in practice.

Researcher Jim Collins writes in his book *From Good to Greatness*: "The leaders of great companies began the process of reorganization by getting the right people for their team and getting rid of the unnecessary ones. After that, they chose which way to swim. The basic idea is that everything is decided by experts and the word "who" is more important than the word "what". Because experts are the strategy, they are the organizational structure, they are the tactic. Companies today need to build their foundations to move to a new level of quality. In my opinion, the fundamental answer to this question is the question of experts [8]. In short, these views of Jim Collins are consistent with the statement that the quality of professional training today should be commensurate with the quality of education. To do this, it is necessary to train highly qualified specialists who are able to carry out innovative activities in educational institutions. It is also impossible to succeed in any field without carefully training and appreciating professionals. In this regard, it should be noted that the state should consistently pursue a policy of specialists, including the effective use of the institution of rotation, which is one of its key elements - the analysis of global trends in the effective use of potential, training and placement of specialists, the development of conclusions are important [9].

It is no coincidence that the El-Yurt Umidi Fund under the Cabinet of Ministers of the Republic of Uzbekistan has been established to train highly qualified specialists to ensure the above-mentioned national interests in domestic and foreign policy. Because, for the country, "we need quality, not quantity. To achieve this, it is necessary to thoroughly study foreign experience. The state that pays special attention to the training of specialists wins. Our most important task is to establish a system of training specialists on the basis of science-based experience, " the head of state said. [10]

Today, in order to fulfill one of these tasks and to select qualified specialists, the State Testing Center under the Cabinet of Ministers together with the Ministry of Public Education, the Ministry of Information Technologies and Communications and the Agency "Uzstandard" until March 1, 2021, to certify teachers of "Computer Science and Information Technology" as an example, work is underway to introduce a national system.

Another example is the establishment of the State Institution "Scientific and Educational Center" (Scientific Center) under the State Testing Center on the basis of the decision of the Cabinet of Ministers "On additional measures to improve the testing system." The purpose of the centre is to

organize testology and pedagogical measurements, foreign language training courses, training of qualified specialists, candidates of science and cooperation with leading international organizations in the field, to establish a regional scientific school of testology in Central Asia.

### **"Intellectual centres– the idea and the creative force of the state"**

It is of great importance for the developed countries of the world to study and analyze the issue of comprehensive development of the country on the basis of objective conditions. Probably, for this reason, these tasks are performed by "mental centres/institutions" on a planetary scale. "In the 1990s, there were about a hundred think tanks in Washington alone." After 2000, there was an increase in the need for analytical activities in the world as a whole. As an example, we can see that the total number of think tanks reached 4.5 thousand [12], and by the end of 2009, their number was 5.5 thousand [13].

Their scope of activities, sources of funding and responsibilities vary. Some specialize in specific areas of both domestic and foreign policy, while others specialize in studying the problems of a particular region. The activities of the well-known US "think tanks" are funded in two ways - privately and through government agencies [14].

Commenting on the response to the emergence of think tanks, American professor Donald Eibelson said that as the United States becomes a hegemon in a bipolar world, he argued that mental centres developed because Washington's top leadership feels highly responsible and needs the intuition and competence of think tanks to help develop holistic and well-founded national security policies [15].

For this reason, many international organizations and think tanks have set up a system for studying and analyzing the development of the world's countries and identifying their activities. These include the National Defense Research Institute (RAND, USA) [16], the Stockholm International Peace Research Institute (SIPRI, Sweden) [17], the Oslo Institute for Peace Studies (PRIO, Norway) [18], and other think tanks and organizations. It was these international institutions that developed the study and analysis of global problems after the Second World War. What is the reason?

In international relations today, the countries of the world are conditionally divided into countries that train scientists and suppliers (donor countries) and countries that use them (recruiting countries). The conditionality of this division is that, for example, Western European countries are considered donor countries for the United States if they are recruiting countries for Asian and African countries. Therefore, the departure of scholars is not a problem for them, as the United States and Canada are included in the list of recruiting countries in the absolute sense. Therefore, an analysis of the US policy on intellectual security, which is an integral part of the national security system today, shows that, unlike other developed countries, it pursues a policy of "retaining" science, advanced technology or qualified personnel.

The reason is that the United States sees the above-mentioned common security strategy and doctrine as one of the intellectual potential and vital interests of its citizens. The implementation phase of this process allows for the direct implementation of intellectual security in the U.S. national security system in two phases.

**The first stage** is to attract scientists who contribute to world science during the re-establishment of the CIA under the President of the United States in the process of redistribution of the world

after the Second World War and as a result of their search, scientists were able to settle in the United States and continue to use their intellectual potential to this day.

**The second stage**, as a result of the radical economic changes that took place in world politics after the collapse of a great state like the Soviet Union, also had a serious impact on the scientific and technological potential of the CIS countries. This is due to the fact that the funds allocated for scientific research have been sharply reduced, and in some areas even suspended.

In addition, at that time, some countries even abandoned the system of organizing science through the Academy of Sciences. These circumstances have greatly narrowed the opportunities for talented young people to engage in science.

This, in turn, has led scientists to lose their high status and prestige in society as before. Consequently, in such circumstances, the rank of scientist has lost its appeal to young people. The younger and middle generation of existing research institutions has abandoned scientific activity. They tried to adapt to the demands of the market system: some hit themselves on commercial, some on simple technical personnel activities. Unable to adapt to the conditions in scientific research institutions, the most talented scientists turned their attention to Europe and the United States, and many of them were forced to leave their homelands.

Based on this, we can see that the break-up of the former Soviet Union had a positive impact on the flourishing of intellectual potential in the United States today. For example, 70 to 80 per cent of world-renowned mathematicians and more than 50 per cent of theoretical physicists emigrated from Russia to the United States in the 1990s, according to the U.S. National Science Foundation. The fact is that more than half of the country's specialists in the field of science have left the CIS countries) is proof of the above.

## CONCLUSION

In conclusion, from the first years of independence, Uzbekistan, along with the developed countries of the world, has established bilateral relations with the United States. This is especially true in the field of education. For example, as a result of the Umid Foundation's training of young people in the United States or developed countries, the role of intelligence in the labour market is growing, as well as the importance of foreign experience in ensuring intellectual security. The implementation of positive achievements in the interests of our country in this direction has become a topical issue on the agenda, as the state depends on the youth.

If we use the term "soft power", which has recently attracted the attention of the scientific and political community, it is through this that Uzbekistan has achieved social stability at the level of demand in our country.

Indeed, every sovereign state in the world is judged by the contribution of a particular society to world stability. Uzbekistan has come up with such a practice that in some sense it is not a mistake to call it the "brand" or "soft power" of our state.

## REFERENCES

1. Каримов И.А. Ватанимиз ва халқимизга садоқат билан хизмат қилиш – олий саодатдир. -Т.: “Ўзбекистон”, 2007. – 9-б.

2. Каримов И.А. Ўзбекистоннинг 16 йиллик мустақил тараққиёт йўли. -Т.: “Ўзбекистон”, 2007. – 25-б.
3. Каримов И.А. Юксак малакали мутахассислар — тараққиёт омили//Бунёдкорлик йўлидан. 4-жилд. -Т.: “Ўзбекистон», 1995. – 38-б.
4. Қаранг: Умаров Х. Ўзбекистон Республикаси геосиёсий ҳолатининг геостратегик хусусиятлари. Сиёсий фанлар номзодини олиш учун ёзилган диссертацияси. –Т.: , 2004. –Б.71.
5. Тишков В. Самоопределение российской нации//Международные процессы. 2013. №1 (32). [электронный ресурс] [http: www.intertrends.ru/seven/002/htm](http://www.intertrends.ru/seven/002/htm)
6. Каримов И.А. Юксак маънавият – енгилмас куч. – Т.: Маънавият, 2008.-Б. 51.
7. Демократик ислохотларни изчил давом эттириш, халқимиз учун тинч ва осойишта, муносиб ҳаёт даражасини яратиш – барқарор тараққиёт кафолати. Ўзбекистон Республикаси Президентлигига номзод Шавкат Мирзиёевнинг Тадбиркорлар ва ишбилармонлар ҳаракати – Ўзбекистон Либерал-демократик партиясининг VIII съездидаги маърузаси/Халқ сўзи, 2016 йил 2 ноябрь.
8. Джим Коллинз "ОТ Хорошего к Великому" издательство " Манн, Иванов и Фербер" Москва 2011.
9. Хусайнов У. Давлат хизматида мутахассисларни танлаш ва уларни жой-жойига қўйишнинг айрим масалалари (ривожланган мамлакатлар тажрибаси асосида). Ўзбекистон Республикасида давлат хизматини ислох этишнинг ҳуқуқий асослари. Тошкент, 2015. 53-бет.
10. Шавкат Мирзиёев: Бизга микдор эмас, сифат керак. 2019 йил 23 майда Ўзбекистон Миллий университетида олий таълим ва илмий-тадқиқот муассасалари раҳбарлари, академиклар, олимлар, ёш тадқиқотчилар билан бўлган учрашувда сўзлаган нутқи. <http://www.uza.uz>
11. Erik C. Johnson How Think Tanks Improve Public Policy. [www.cipe.org/e21/priE21.html](http://www.cipe.org/e21/priE21.html)
12. Qarang: Think Tanks and Trans nationalization of Foreign Policy // US Foreign Policy Agenda. 2002. Vol. 7. No 3., The Leading Public Policy Research Organizations in the World. Philadelphia. 28.07.2010.. - P. 15.
13. <http://gtmarket.ru/news/state/2009/01/12/1888>
14. Бобоқулов И.И. Умаров Х.П. Хавфсизлик асослари.– Т.: 2011. - Б.57.
15. Эйбелсон Д. “Мозговые центры” и американская внешняя политика: история вопроса. <http://usinfo.state.gov>
16. [www.rand.org](http://www.rand.org)
17. <http://www.sipri.org/databases/terms>
18. <http://www.prio.no/Research-and-Publications/Project>
19. PkhomAbdirakhimov. Development of effective demulsifiers on the basis of local raw materials // Universum: техничекиенауки: научныйжурнал. – № 2(83).Часть [4] М.,Изд. «МЦНО», 2021. DOI: 10.32743/UniTech.2021.83.2-4.36-39.

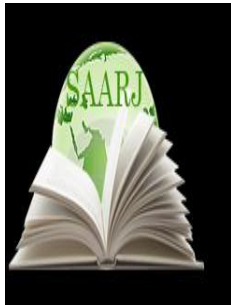

**ACADEMICIA**  
**An International  
 Multidisciplinary  
 Research Journal**  
 (Double Blind Refereed & Peer Reviewed Journal)



**DOI: 10.5958/2249-7137.2021.01231.3**

## WOMEN AND INFORMATION COMMUNICATION TECHNOLOGY MICRO-LEVEL STUDY IN RURAL KERALA

**R. Venkata Ravi\*; Aryanathu. V\*\***

\*Associate Professor,  
 Gandhigram Rural Institute INDIA  
 Email id: rvenkataravi@hotmail.com

\*\*Research Scholar,  
 Gandhigram Rural Institute INDIA  
 Email id: aryanathuv1993@gmail.com

### ABSTRACT

*Information Communication Technology [ICT] concentrates on these three aspects - Information, Communication and Technology. The paper is based on a study which covered various aspects of the Users of ICT Gadgets, in terms of their socio-economic profile, pattern of utilization of ICT tools, purpose for which the ICT tools used and also the constraints experienced by SC and ST women in Use of ICT tools. The micro level study was undertaken in two villages of Kollam district in Kerala. These two villages are identified based on the concentration of SC and ST population in the Kollam district, Anchal Block and Two Villages - Kulathupuzha and Thinkalkarikakom are identified and purposively chosen for the study. The researcher has used a structured interview schedule, and also Focus Group Discussion with women. In this paper, outcome of the Focus Group Discussion and Case studies are presented and discussed.*

**KEYWORDS:** *Access, Employment, Information, Technology, Utilization, Enabling*

### INTRODUCTION

In the 2000s, India is emerging as a role model for Information Technology infused development, from e-governance to ICT-D. India's importance in this area is partially explained by the symbolic success of its export-oriented Information Technology (IT) industry, often represented as an "engine of growth" for the wider national economy<sup>1</sup>. It means that technology



is playing a pivotal role in the development process and paving way for multiplier effect with the use of technology by the people.

The Information Communication Technology [ICT] has three dimensions - Information, Communication and Technology; to promote information via communication with the help of technology. The Communication is a process that promotes the forces of transformation and survival of communities<sup>2</sup>. The ICT is providing Information as a resource that can affect the life of the people in a given area. It needs to be understood that as the technology enables the transaction of information as a resource.

Any amount access to Information, Communication and Technology (ICT) creates new opportunities to enhance the women skills, knowledge particularly in increasing the productivity of the existing livelihoods and move towards the knowledge and economic empowerment<sup>3</sup>. It reads that ICT is enabling factor and also opening up the opportunities for livelihood in the society.

Higher education system in India is undergoing a dynamic change. Good education is always seen as promoting factor for high career<sup>4</sup>. Bhattacharya and Sharma observed that development of Information Communication and Technology (ICT) has brought a shift in the current education system in India<sup>5</sup>. It implies that ICT influence the delivery of content and same accessed by many at the end point. Therefore, the learning opportunities have widen due to the ICT intervention in the education system.

Whereas in contrast Balit<sup>6</sup> argued that isolated and marginalized sections of the society, in particularly those who are in rural-remote groups face acute constraints with regard to access to information and communication. Thus, they have limited participation and voice in the public sphere and in decision-making process affecting their lives and thus risk further marginalization, politically, socially and economically. It underlines the possible influence of the ICT among the socially excluded and their participation in the public life.

Anita Gurumurthy, Nandini Chami, (2014), the gender gap in income and education levels are key contributors to the gender gap in ICT access<sup>7</sup>. Odambe et al, (2002) argue that in rural areas, women are more likely to be information- and resource-poor, isolated, and less educated compared to men<sup>8</sup>. It implies that these factors play significant role in access to ICT in the rural areas with given level of endowments.

Stauffacher and Kleinwacher, (2005) have observed that information has the ability to improve standards of living for everyone by enhancing all aspects of our lives, from trade to telemedicine, from education to environmental protection<sup>9</sup>. It means that ICT is capable of influencing the ability of the people which lead to development.

According to Minakshi Ramji, (2006), women and SCs can face problems that may prevent them from free access. Social and cultural norms may also mean that women due to their multiple responsibilities or SCs who are mostly daily labourers have less time to access ICTs. Illiteracy is greater among women and SCs and as such this can pose a problem for access. Lastly, poverty may restrict these groups from owning ICTs<sup>10</sup>.

Dalal (2006) argues that while there is recognition of the potential of ICT as a tool for the promotion of gender equality and the empowerment of women, a gender divide' has also been identified reflected in the lower numbers of women accessing and using ICT compared with

men. Unless this gender divide is specifically addressed, there is a risk that ICT may exacerbate existing inequalities between women and men and create new forms of inequality<sup>11</sup>.

Patil (2007) observed that, in India the utilization of ICT for women empowerment is in the take-off stage and obviously there are many field and technical problems. The key constraints are insufficient regional specific information, inadequate internet connectivity and electricity, inadequate support from facilitator, lack of Infrastructure facility, lack of construction of content in local language, limited duration of projects, problem of monitoring and evaluation, lack of operators knowledge, lack of the involvement of other ICT channels, lack of marketing management and development skills<sup>12</sup>. Patil et.al (2009), the main barriers to women's use of ICT continue to be lack of proper training especially among the rural and deprived women. In this context Schools, Panchayat offices and Women Self-Help Groups (SHGs) should impart ICT training<sup>13</sup>.

Mehta (2013) study revealed that 69 percent of India's population lives in rural areas; the majority of India functions with substantial barriers to education attainment and social mobility, and work in an unorganized, casual labor market which yields very little income. The rural population is at an inherent disadvantage in India as they lack the pre-requisites to participating in their country's economic growth in the tertiary, modern services sector<sup>14</sup>. Jewan Singh et al (2010) study found that ICT enhances community participation, community empowerment and improve the socio-economic condition of the community<sup>15</sup>. Han Ei Chew et al (2010) found that the impact of information and communication technologies, especially landline and mobile phones, computers, and Internet cafés in facilitating economic growth in the developing world<sup>16</sup>.

The available literature on the ICT and its accessibility indicates that ICT is capable of influencing the process of development in the society. The process is also subjected to the many factors that work as enabling and also disabling factors for the application of ICT by people in the grassroots level. Hence, the authors have interacted at the field level with Schedule Caste Community households to understand their level of access to various ICTs; and their influence on their decision relating to their socio-economic and political life. The study would be relevant in the context of empowerment of the Schedule Caste households and access through modern technology.

### **1. Focus of the Paper**

The UN Resolution in October 2015 has resolved [Item No. 5 b] and focused on "enhance the use of enabling technology, particularly Information and Communication Technology, to promote the empowerment....". In this context, it significant to understand the level of access to various Information and Communication Technology [ICT] in terms of use of Mobile Phone, Use of Television, Access to Radio, Access to Computer and Internet facilities in the rural areas.

This paper is based on a micro-level study covering aspects on how far the ICT tools are owned and used by Schedule Caste and Schedule Tribes Women; aspects on which the women are getting information or exchange information. The paper is based on a study which covered various aspects of the Users of ICT Gadgets, in terms of their socio-economic profile, pattern of utilization of ICT tools, purpose for which the ICT tools used and also the Constraints experienced by SC and ST women in Use of ICT tools.

The micro level study was undertaken in two villages of Kollam district in Kerala. These two villages are identified based on the concentration of SC and ST population in the Kollam district, Anchal Block and Two Villages - Kulathupuzha and Thinkalkarikakom are identified and purposively chosen for the study.

The SC women is found to be more in the Kulathupuzha and ST women are more in the Thinkalkarikakom in the Anchal Block. From village each sample village, 75 women was targeted as sample respondents, and totally 150 respondents is base for the study. But, due to ground level problems and non-availability of the respondents at the time of field visit, the researcher was able to meet and interact with a sample of 88 ST women and 62 SC women, thus reaching a total of 150 women respondents. The researcher has used a structured interview schedule, and also Focus Group Discussion with women.

Initially, there was challenge for the researcher in terms of non-cooperation by the women and demonstrated lot of resistance in answering the questions asked by the researcher. Because, most of these ICT Gadgets are costly and when questioned about its ownership, SC and ST women have found different and also difficult to answer them. They are bothered as the Researcher is taking stock of the facilities owned by the SC and ST women in the village. Later, with persistent efforts made by the researcher, the women could come-out of their shell and provided information.

## 2. Output of Focus Group Discussions and Case Studies

The researchers focused to bring out the influence of ICT gadgets on women Users and their family. It is a complex process of assessment of effects, that involves use of information received through the ICT gadgets and measuring its effects on the Users and on their living condition. Hence, the researcher has used the Case Study methodology to bring out the positive effects and influence of the ICT gadgets on the living condition of the women Users.

Based on the preliminary observations made in the Focus Group Discussions, the researcher has identified cases for further investigation so as to document the effects of the utilization of ICT gadgets on the Women Users and their way of living. This chapter presents the output of the discussions and Case Studies on the effect and impact.

## 3. Output of Focus Group Discussion

The Focus Group Discussions was conducted in the study villages. About 15 tribal girl student and 15 women from different age groups have participated in the discussions **.It is to get a clearer picture of the women's perception and using towards ICT. In this focus group discussion it was possible to effectively assess the use of accessing ICT in the everyday lives of rural women and the development needs of the rural tribal communities.**

The Focus group discussion was conducted in a Prematric hostel for tribal girls in Kulathupuzha situated in Villumala.13-18 years old tribal girls were participated in the two day discussion .These students need to travel 3-4 km to school from their home .since it is a forest area the fright of elephants would set hurdles on their way. Most of their parents are labors and working far away from their place .so the school authority provided a prematric hostel near the school, for the sake of students safety and make their studies easy. Students are comfortable in the hostel .All of them are under BPL category .each of them owned 50 cent to 1 acre .They are leading nuclear families. T.V and mobile phone are the most familiar devices used by tribal girl's \ students in

ICT gadget list. Telephone is very rare .they is not that aware of internet, though it is a part of their school studies but as a beginner they have some knowledge about internet.

### **3.1 Pattern Mobile and Telephone Utilization**

Everyday students in the tribal hostel are allowed to use mobile phone for 5-10 minutes. That is only for calling their parents. In home, the girls used call friends and other uses are taking photos, listening music and videos, calculations etc. Android phones are very rare in them.

One girls experiences sharing in the group discussion ....During time of excursion she was deviated from the group and become alone; at that time mobile phone helped her to get the right way and she reached safely in to the group.

A girl came to know her SSLC results through the phone. Another girl came to know the results of Intermediate Board Examination .Other one has been listening music in mobile phone after coming from work in the plantation. It makes her more relaxed.

One girl explained a situation in which the mobile has helped her very much in a difficult situation. She could participate in Student Police Cadet when her teacher gave information to be present in the school at the right time. Mobile phone helped her to contact the teacher who provided the information. It created an opportunity for the girl.

In many cases, the women labour were informed about the MGNREGS work in advance, through SMS from the Mobile Phone.

### **3.2 Pattern of Radio Use**

Very few Tribal women are familiar with Radio. Even if it is in the mobile phone due to the range [signal] problem they could not get it all the time.

Radio is very informative and communicate device for women. Many women heard the speech of Prime Minister from the programme *Manki Bath*. There was a connectivity problem some time, so could not listen to full speech.

Veena [SC woman] They are use to listen to Radio daily for during the last 6 years. Now due to range problem they could not hear it properly. Otherwise many used to listen news, speeches (especially Prime Minister Narendra modi speech manki bath), weather report, film, songs, etc.

One girl explained a situation in which the radio has helped her very much in a difficult situation .she faced a general knowledge questions [mostly related to name and position of few leaders] from her teacher in class. She could answer well, because she had listen those topic in Radio.

Vidya, housewife used to listen radio every day. She regularly listen news, music; comedy etc. It has helped to improve the general knowledge and develop interest in the music. Mostly useful to relax in the evening.

### **3.3 Pattern of Television Use**

Television is the most familiar device to all. Most of the women are aware about the positive aspects of it.

Saranya: she is one of the higher secondary students; she regularly watch news, weather, music, serial, documentary, educational programmes. She is one of the regular viewers of the documentary programme safari.

Majority of the housewives using cable Television. They used to see educational programmes in Amrita Channel, Victors and local news in Manorama, Reporter, Amrita, Mangalam, Surya, Asianet The problems in use of Television are - there is no adequate signal during the rainy season, eye problem, power cut and not able to watch. The type of information, they are getting through Television is related - agricultural news, Horoscope, Cookery shows, Yoga and meditational programme, Music and Exam results

Deepthi [worker] “we can make new dishes from the cookery show. we used to try new items by seeing cookery show. we used to see agricultural programmes like kissan, krishi deepam..

Shalini [working with book shop]: For her *kodiswaran* programme in Asianet is very informative. We can increase our G.K level by watching that programme. Doctor’s phone in programme inspired us .now I have set my ambition to become a doctor.

### 3.4 Computer and Internet usage Pattern

Among the women, mostly students are using computer for the purpose of drawing, playing games, animation, coloring and typing. They are totally unaware of internet. Most of them replayed they are in the Beginner level of computer and internet literacy.

Most useful to learn new skills - Using the Internet, Reading books, Watching TV generally Reading newspapers, Using computers, Watching educational TV (eg documentaries/Learning Zone and also Listening to the radio

The output of the Discussion is indicating that women are aware of the ICT gadgets. But still they are not reached remote villages on large scale. However, whoever is aware and own the ICT gadgets are putting the same into maximum usage. In this discussion they gave some suggestions for their betterment.

1. There is no range all the time, tower is necessary.
2. Lack of awareness internet and computer so training programmes are needed.
3. Internet café is necessary
4. Computer centre is necessary
5. Government have to provide computer
6. Make them aware about government schemes
7. Solve the range problems
8. Increase the efficiency of akshaya centre

### 4. Case Studies:

An attempt has been made to discuss with some individuals to document the perception and attitude of the women on the ICT gadgets.

**Case - 1: Mrs. Ajitha.S** [36 years old] she is residing at Villumala, Thingalkarikakom village. She has studied up to 10<sup>th</sup> standard. Her husband is also completed only school level of education. Her family is a nuclear family. She has used to collect information about the world through mobile phones, news papers, and TV. Usually she receives both internal and external [personal and public] news through mobile from her friends and relatives.

The programmes of her choice in the Television includes watching yoga, agricultural programmes, news, sports, cooking, health programmes, music channels, films, serials, etc. It helps her to update information on day to day affairs. By watching agricultural programmes; she is accustomed with gardening and earns money by selling organic vegetables. She practices yoga everyday from the Television which helps her to cure all the problems of mind and body. Music programmes help her to rejuvenate her mind to do the house hold activities in a more relaxed way.

Knowledge - providing quiz programmes like *kodeeswaran* updates her general knowledge. She enjoys the entertainment programmes like *kuttipattalam* with her family. She considers Television as an inevitable thing in her family life.

**Case -2: Ms. Sujitha. K** [26 years old] she is residing at villumala, Thingalkarikakom village. She is a graduate and unemployed too. So she is preparing and appearing for competitive exams. Her family consist of four members and the entire family is living with her father's meager income. Mobile applications, Television programmes and Newspaper provides the information about world and day to day affairs which helps in her preparations for examinations. Apart from this, now-a-days government propagates mobile apps by informing about qualified exams through personal messages. She is also make use of the famous schemes of the Prime Minister KAUSHAL VIKAS YOJANA [PMKVY] through the mobile phone. It provides required technical training for her to get a better job. She has trained in computer training.

**Case-3: Ms. Reshma** [21 years old] she residing at **Villumala, Thingalkarikakom** village. She has studied up to degree level. Now she is studying in St. Johns College Anchal. She used to collect information about the world through mobile phone, news paper, and Television. Usually, she receives messages about home events and other general news through mobile from my friends and relatives. Mobile phones plays a vital role in my life to collect and gather information's to communicate. Moreover, Television also supports much to get more information.

Through mobile phones she has able to get information's and download project regarding works. She has been watching Television programmes on educational, entertainment programmes and takes notes on it to make use of it in my daily works. So, she has much benefited by real progress. Thus, she collect information that improve her knowledge and help the needy in time.

**Case-4: Ms. Vanaja** [41 years old] and residing at **Villumala, Thingalkarikakom** village she has completed her secondary education and now working as a sales assistant in a showroom. She is also working in MGNREGA which help in managing and running her family. She is married and living with her two sons. She makes use of mobile to contact her showroom many times. Also she uses internet in the mobile to search online customers and for replying necessary enquiries of theirs. Mobile enables her to make a good coverage for her business transactions. She can access the organizations special classes on new products through mobile and also get information about launching new products through mobile. She has been helped and enabled by the Mobile phone in her occupation.

**Case -5: Ms. Archana** [40 years old] and she is residing at **Villumala, Kulathupuzha** village she has studied up to higher secondary level. She is living with two daughters and struggling to run her family as a widow. She is compelled to manage the expenses of daughters' education as well as family maintenance with her meager wages.

She is working as a Chairperson of SHG Federation. She is more depended on computer and mobile for her daily routine and office work. She got computer training in the Akshaya programme that helped her to do her works more fruitfully. Mobile is helpful for her as she can contact her fellow workers for enquiring about the closing of accounts, meetings and daily activities. Apart from this she can acknowledge the latest up-comings through computer and mobile. Now, she has carrying work on the effective steps to be taken in SHG through computer. In this task, Internet helped her a lot in this regard. She is also using mobile phone daily and computer. Now, mobile phone and computer are playing an essential role in her life.

**Case -6: Ms.Vinita** [35 years old] she residing at **villumala, kulathupuzha** village. She is a spinster and running a tailoring shop. Mobile helps her lot in her works through mobile application and internet. She can update latest designs in dress patterns and also new stitching styles will be explained in detail. With this new technology, she got a lot of customers who are interested in her works. Now, she has a plan to open a new boutique. For this she has made contact with resellers through Phone and she can buy materials through online. She hopes she will get online customers through *face-book* and *whats app*.

**Summing up:** The case studies indicate that the ICT gadgets are part of their life and they have enabled to do their work effectively and efficiently. The information is a resource that becomes knowledge when it is delivered / accessed and applied properly. The ICT gadgets are channels to deliver the Information and Knowledge to women that in turn used by them to take decisions. So, the ICT gadgets are enabling technology for rural women, particularly to SC and ST women.

## REFERENCE

Anita Gurumurthy, Nandini Chami, 2014. Gender equality in the information society - a review of current literature and recommendations for policy and practice. Pp 14.

Bhattacharya I and Sharma K, 2007. India in the knowledge economy – an electronic paradigm, International Journal of Educational Management 21(6) 543–568.

Balit, S, 2004. Communication for isolated and marginalized groups, blending the old and the new. Paper for Ninth United Nation Round Table on Communications for Development, FAO, and Rome 2004 Chapter 6.

Chakravartty, P. (2001) “Flexible Citizens and the Internet: The Global Politics of Local High-Tech Development in India,” *Emergences: Journal for the Study of Media and Composite Cultures*, 11 (1): 69-88.

D. A. Patil, A. M. Dher, C. B. Pawar, ICT and Empowerment of Rural and Deprived Women in Asia, Asia-Pacific Journal of Rural Development. Vol. XIX, No. 1, July 2009.

Dalal, P. Use of ICT for Women Empowerment in India, Asia-Pacific Journal of Rural Development, 2006.

Han Ei Chew P. Vigneswara Ilavarasan Mark R. Levy The Economic Impact Of Information And Communication Technologies (ICTs) On Microenterprises In The Context Of Development, The Electronic Journal on Information Systems in Developing Countries, EJISDC (2010) 44, 4, 1-19.

Jewan Singh , V. Mansotra and Vinod Sharma, Information And Communication Technologies For Strengthening Panchayat Raj in India “A Model For J&K State”, Proceedings of the 4th National Conference; INDIACom-2010 Computing For Nation Development, February 25 – 26, 2010 Bharati Vidyapeeth’s Institute of Computer Applications and Management, New Delhi

Learning: Impact on Women’s Empowerment.Hayward FM, Internationalization of US Higher Education. Preliminary Status Report, 2000.

Minakshi Ramji, 2006. Information and Communication Technology and Economic Development: Some Observations on the Socially Excluded from Village Knowledge Centres in Pondicherry, India. MSc in Local Economic Development, Dissertation, 2005-2006 London School of Economics and Political Science. Pp.16.

Mehta Belwant Singh. 2013. “Capabilities, Costs, Networks and Innovations: Impact of Mobile Phones in Rural India”. Institute for Human Development

Odame H.H, Hafkin, N., Wessler, G and Boto, I. 2002, ‘Gender and Agriculture in the Information Society’, International Service for National Agricultural Research (ISNAR) briefing paper.

Patil, D. A. 2006 Patil, D. A. 2007. A Study of Communication Networks and Development in Kolhapur District, Ph. D thesis (Sociology), Submitted to Shivaji University, Kolhapur.

Stauffacher, D. and Kleinwacher, W. 2005, ‘The World Summit on the Information Society: Moving from the Past to the Future’, United Nations ICT Task Force: New York.

Vikram Gopinath, (2007) “Role of Information and Communication Technology in the Rural Development: Study of Thangachimadam Village Resource Center and its Village Knowledge Centers,”(Un-published Dissertation).





**ACADEMICIA**  
**An International  
Multidisciplinary  
Research Journal**  
**(Double Blind Refereed & Peer Reviewed Journal)**



**DOI: 10.5958/2249-7137.2021.01258.1**

## **ISSUES OF FURTHER IMPROVEMENT OF WATER CADASTRE LEGISLATION OF UZBEKISTAN**

**Toshboeva Robiya Sobirovna\***

\*Acting Associate Professor of the Department of Environmental Law,  
Candidate of Legal Sciences, Tashkent State Law University,  
UZBEKISTAN

### **ABSTRACT**

*The article analyzes the legal basis for maintaining the state water cadaster of Uzbekistan as one of the mechanisms for ensuring water safety reveals the essence and goals of maintaining the state water cadaster, summarizes the latest trends in improving the legal and technological foundations for the formation of water cadaster information. The author presents some scientific and practical problems related to the formation of water cadaster information, the solution of which would contribute to ensuring the transparency of water information and its reliability, and studies foreign experience in this area. Based on the analysis of the current water legislation, special legal literature, as well as foreign experience, the author substantiates proposals for further improvement of water cadaster legislation and develops three draft normative legal acts aimed at legal regulation of water cadaster management.*

**KEYWORDS:** *State Water Cadaster, Water Monitoring, Unified Information System, Water Cadaster Information, Surface Water, Underground Water, Water Use, Information And Communication Technologies, "Smart Water", And Digitization*

### **INTRODUCTION**

#### **Relevance of the topic**

Water is a precious and essential resource for the maintenance of life on Earth. As the foundation of life, water, through its diverse uses, continues to play a major role in addressing a broader range of challenges to achieve food security, reduce poverty and improve the quality of life in the world. That's why we need to have complete and reliable information that answers questions like: How much water do we have? What is its quality? How long will it last? What is the cost of water resources?

As global environmental crises escalate, water security, which means the ability of the population to have sustainable access to an adequate amount of acceptable water quality to support human livelihoods, well-being and socio-economic development, is an integral part of a country's environmental security.[1] Water security promotes environmental protection and social justice by resolving conflicts and disputes that arise over shared water resources. And to ensure this very safety, we must first of all be provided with reliable statistics on the state of the waters.

Today, in Uzbekistan, in the conditions of water scarcity, the issue of ensuring water security will be even more relevant. In our opinion, the following problems in the field of water resources management are relevant to this issue:

1. Reduction of water resources as a result of climate change,
2. Increased demand for water due to population and economic growth,
3. further degradation of water quality.

The main problem of today's water use is the lack of reliable and transparent statistics on water and water bodies, which are concentrated in the State water cadastre (hereinafter referred to as the water cadastre). The information available in Uzbekistan on the state of water resources is far from complete and "stale" due to the lack of modern technologies in the process of collecting, processing and storing information that allow for systematic updating of water monitoring data ( we outlined the use of the latest information and communication technologies in the process of collecting, processing and storing water-cadastre information only last year!!!), its outdated methodological basis (the Regulations on the procedure for developing and maintaining the State water Cadastre of the Republic of Uzbekistan were adopted already in 1998!!!) and incomplete coverage of the quality indicators of water resources ( for example, the water cadastre does not contain information about wastewater flowing into large water bodies of the country and affecting its quality). For Uzbekistan, which is moving to a digital economy, the importance of reliable statistics and figures in the life of the state and society is paramount. Even in the last century, the famous Russian writer G. I. Ouspensky, speaking about the meaning of statistics, noted: "And yet it is only in these thick, boring books that the 'real' truth of our life is told in figures, about which we have completely lost the habit of speaking in human language, and it is only necessary once to get interested in these fractions, zeros, zeros, in this generally digital grain with which statistical books and tables are littered, so all of them, all this grain of numbers, will begin to take human images and it will begin to receive the meaning not of dead and boring signs, but, on the contrary, the meaning of the most versatile image of life." [2] In addition to this metaphor, I would like to add that this "digital grain" should be justified and updated, then it will have an important practical significance in environmental protection.

### **The degree of scientific knowledge of the topic**

Existing research in the field of legal regulation of water cadaster management in domestic environmental science addresses the issue of water cadaster management from the point of view of water fund management and is reflected in the works of such domestic scientists of environmental lawyers as Fayzieva Sh. Kh. [3], Usmonov B. M. [4], Salokhiddinova A. R.[5], Chembarisov E. I. and Rakhimova N. M.[6] , etc. Part of the national research in the field of water use is devoted to the problem of the use of transboundary water resources, in particular, the

works of Kholmuminov Zh. T. [7], Skripnikova N. K. [8], as a new trend of modern domestic water legislation, O. Narzullaev considered the issue of water use of biological resources in the context of the COVID-19 pandemic [9], etc.

Directly the issues of legal regulation of water cadaster management, the ratio of water monitoring, accounting and cadaster are reflected in the works of such scientists of the CIS countries as Bogolyubova S. A. [10], Kolbasova O. S. [11], Sivakova D. O. [12], Krasova O. I. [13], Budaragina L. V. and Tishchenko S. V. [14], V. A. Dukhovny, N. N. Mirzaev, A. I. Tuchin [15], Bekisheva S. D. [16], Petrakova S. V. [17], etc.

The relationship between the water cadaster and water management stability is revealed by Philip P. Miklin, a professor at Western Michigan University. [18]

#### Analysis of legislation

The regulatory framework for maintaining the water cadaster consists of: the Law "On Water and Water Use", Resolution of the Cabinet of Ministers of the Republic of Uzbekistan "On Approval of the Regulations on the procedure for Developing and maintaining the State Water Cadaster of the Republic of Uzbekistan" dated January 7, 1998 No. 11, Resolution of the Cabinet of Ministers of the Republic of Uzbekistan "On measures for further streamlining activities in the field of underground water use" dated June 27, 2017 No. 430, Decrees of the President of the Republic of Uzbekistan "On measures for the effective use of land and water resources in agriculture" of June 17, 2019, No. UP-5742 and "On approval of the concept of water management development of the Republic of Uzbekistan for 2020-2030" of July 10, 2020, No. UP-6024, etc.

In accordance with article 109 of the law "On Water and Water Use", the water cadaster includes data on water accounting for quantitative and qualitative indicators, registration of water use, as well as data on water use accounting.

The main task of the water cadaster is to obtain and maintain reliable information about water resources and water bodies at the current level with minimal costs by constantly improving the technology of collecting, summarizing, storing and providing information.

The water cadaster consists of the following sections:

- 1) Surface water
- 2) Underground water
- 3) Water use

The water cadaster is maintained by three bodies:

1. The Center of Hydro meteorological Service under the Ministry of Emergency Situations of the Republic of Uzbekistan-under the section "Surface waters»;
2. The State Committee of the Republic of Uzbekistan on Geology and Mineral Resources-under the section "Underground waters;
3. The Ministry of Water Resources of the Republic of Uzbekistan-under the section "Water use".

In accordance with the Concept of Water Management Development of the Republic of Uzbekistan for 2020 — 2030, it is planned to improve the system of forecasting, accounting and forming a database of water resources and ensure its transparency, which is implemented through the following measures:

- a) Step-by-step equipping of hydrological posts located on large and medium-sized rivers and says with automatic equipment based on digital technologies, expansion of the network of hydrological posts;
- b) Improving the control and accounting of water in all water bodies on the basis of digital technologies, creating a transparent information system on water resources;
- c) Implementation of the following measures for water resources forecasting, water accounting and data processing:
  - 1) Implementation of the geoinformation system in forecasting water resources, conducting operational monitoring of water resources and improving the reliability of forecast data;
  - 2) Standardization of data for water accounting at all water bodies;
  - 3) Improvement of information systems for collecting and processing information about water bodies based on information and communication technologies;
  - 4) Step-by-step implementation of water monitoring in water bodies using digital technologies, creation of a unified information system for all sources and water resources;
- h) Improving the water cadaster and database management system with the help of information and communication technologies and ensuring their transparency.

In addition, this act provides for the creation of an Integrated National System of Accounting, Planning and Management of water Resources linked to the National Cadastral Database, which will ensure the openness and accessibility of data on water resources.

At the same time, the introduction of "Smart Water" technology in water use and water consumption accounting is also an important step in the further improvement of the water cadaster.

It should be emphasized that the next cadaster of natural resources after the land cadaster in the field of its digitalization is just the same water cadaster.

### **Practical problems of water cadaster management**

1. Lack of a mechanism for economic assessment of water resources. In Uzbekistan, the procedure for assessing water resources is legally established, which means systematic accounting for quantitative and qualitative indicators both during the year and in a multi-year context through measurements with standard hydrometric devices, analysis of the reliability of the data obtained, their processing by standard methods and generalization by various territorial and temporary units, while the development of new criteria for the economic mechanism of water use, in particular, determination of the procedure for reimbursement by water consumers of state expenses for the delivery of water.

But we do not regulate the concept of "economic assessment of water resources", which includes the monetary form of the public utility of natural resources through production and consumption.

In the foreign legal literature, there are several concepts of economic assessment of natural resources, including water resources.

In particular, S. G. Strumming proposes to evaluate all natural resources by their costs for their development, the main criterion of which is net income and differential rent. [19]T. S. Khachaturov suggests estimating natural resources from the costs that we spend to get the effect of the resource used.[20]

A mixture of these two theories can be observed in the example of the Republic of Kazakhstan, where the base price of water resources is set from the ratio of the cost of protection and reproduction of water resources to the total intake from water sources.[21] At the same time, water quality is not taken into account in prices, which gives rise to a one-sided attitude to setting prices.

In the domestic environmental legislation, there is an economic mechanism for nature protection, which provides for the collection of fees for special use of natural resources, for pollution of the environment (including waste disposal) and other types of harmful effects on it; tax, credit and other benefits provided to enterprises, institutions and organizations, as well as individuals when implementing low-waste and resource-saving technologies, carrying out activities that give environmental and natural restoration effect; obtaining licenses (permits) for the right to release, discharge substances polluting the environment or to carry out other environmentally harmful activities, etc.

We support the position of the International Institute of Water Resources Management, according to which the economic assessment of water resources should be carried out in several stages in order of increasing complexity. A multi-stage

The main issues of the mechanism of economic assessment of water resources, in our opinion, should be:

1. Definition of the main criteria for economic assessment
2. Identification of the competent authorities involved in the assessment.

We propose to take the quantity and quality of water resources, the availability of irrigation structures, as well as the size of the differential rent for water use as the evaluation criteria. Note that this system of criteria is conditional, has a general character and can be updated depending on the individual properties of water resources and the powers of the competent authorities.

Recognizing that Uzbekistan's water resources and facilities are diverse in terms of water volume, background pollution, climate, geographical and landscape conditions, the development of common criteria for conducting an economic assessment of water resources is a very complex process. But at the same time, in the conditions of increasing scarcity of water resources for the purpose of rational use of the remaining resources, the regulation of the economic assessment of a natural resource is one of the main tasks of the natural resource cadastral system in the context of the transition to a "green economy".

2. There is no procedure for providing water cadaster information to interested individuals and legal entities, which prevents the full exercise of the constitutional right to receive information. In accordance with Article 17 of the Law "On State Cadastres", information from state cadastres is provided to state authorities free of charge, and to other legal entities and individuals in

accordance with the established procedure, for a fee, while the very concept of "established procedure" is not disclosed by law. The law "On Water and Water Use" and the Regulation on the Procedure for Developing and Maintaining the State Water Cadastre of the Republic of Uzbekistan do not disclose the procedure for providing water-cadastral information, which is a serious gap in the water-cadastre legislation. Article 29 of the Constitution of the Republic of Uzbekistan reads as follows: "Everyone has the right to seek, receive and disseminate any information, with the exception of information directed against the existing constitutional order and other restrictions provided for by law." If we proceed from this norm, then the lack of a mechanism for providing water-cadastre information is an obstacle to the implementation of this constitutional norm.

### **3. Insufficient validity and unreliability of information on the quality of water resources.**

This primarily concerns information on wastewater (in particular, information on wastewater entering the Chirchik, Akhangaran, and Bozsuv rivers), which reflects the discharge of specific harmful substances into reservoirs and assesses the actual pollution of natural waters. These rivers are polluted by wastewater from many industrial enterprises, municipal and collector-drainage runoff from irrigated fields. Of particular concern are the unaccounted-for wastewater that is not provided for in the design of treatment facilities and the rules for the acceptance of wastewater and is a concentrated discharge. And with the growth of urbanization, this problem is even more urgent

**4. In the water cadastre, there is no information reflecting the socio-economic and environmental efficiency of water resources, we evaluate only its raw materials.** The time has come when it is necessary to evaluate water not as a natural good, but as a natural capital that should be multiplied.

**5. The low level of the scientific basis of the water cadastre and practical developments.** It should be noted that the modern domestic water legislation does not fully and clearly regulate water relations. And scientific research in the field of legal regulation of water cadastre management in Uzbekistan is completely absent. The legal scientific works of Russian scientists contain only references to the function of accounting for water bodies and their condition in the framework of research on the protection of water and water bodies, as well as control and supervision of the activities of citizens and legal entities in the process of water use. Some of the research is devoted to the study of transboundary waters, while the legal problems of maintaining a water cadastre are still unexplored, which in turn is a serious gap. Recent trends in the improvement of water legislation are more focused on the introduction of new technologies in the process of collecting, processing and storing water cadastral information, which is also important. At the same time, we should not forget about its scientific and methodological components

**Foreign experience.** After analyzing the legislative basis for maintaining the water cadastre of the **Russian Federation**[22], **Kazakhstan**[23], the Republic of **Belarus** [24], **Turkmenistan**[25], we came to the conclusion that the content of the water cadastre of these countries practically repeats each other, while the system of bodies that conduct it is diverse.

If the water legislation of the post-Soviet countries still revolves around automated water cadastre systems, the proposals of scientists from the United States, Europe and Asia to improve

the formation, collection, processing and storage of water cadastre information at the current stage of development are based on the use of the latest nano-technologies.

In particular, in the collective work of American scientists, special attention is paid to the state of such a water body as a water reservoir and it is proposed to widely use satellite systems in tracking the quality of water resources, referring to the fact that a complete database on water resources in all countries does not yet exist. Since sensor data is not available worldwide, US scientists suggest using NASA's new satellite mission, ICESat-2, to obtain information on water quality, which they believe will be an important component of any global inventory of reservoir levels and will provide new insights into how reservoir management responds to climate variability and rising human demand.[26]

In the collective work of English scientists, it is proposed to use the new mobile infrastructure of eco-accounting as the basis of natural resource inventories, including the water cadastre, consisting of four modules: eco-consumer account, eco-shopping, eco-processing and eco-incentives.[27]

In the next collective work of American scientists, it is proposed to use remote sensing to catalog lakes in order to characterize the morphology and build a typology using cluster analysis. This method can be used to identify environmental research needs, adapt water monitoring and management programs, customize environmental programs, and use the conservation of available water resources more effectively to achieve large-scale management goals.[28]

The collective work of Mexican scientists examines the mapping and monitoring of fresh (surface) waters in the largest mountain range of Mexico-the Sierra Madre Occidental (SMO), covering the states of Chihuahua, Sonora, Sinaloa, Durango, Nayarit, Zacatecas and Jalisco, which are of great importance for understanding hydrological processes and water management. In this study, 120 Sentinel-2 satellite images were used. [29]

The problem of insufficient data and the need for a more reliable data inventory is also raised in the work of the Tunisian scientist BeljamAzhoubi. It proposes to develop and build scientific capacity through regional and international partnerships, as well as to implement rational water resources management for sustainable development based on gis technologies and the GALDIT index system. [30]

In the joint work of Argentine and Colombian scientists, the issue of delineation of water bodies is raised, which is not a clearly solved problem, as a result of which it is proposed to develop a conceptual model of water bodies of the LLO type with dynamic boundaries, based on the legal definitions of coastal boundaries in the future 4D LLO. [31]

In the collective work of Chinese scientists, water-saving technologies have long been seen as an effective method of reducing irrigation water use and alleviating regional water scarcity. However, the growing number of reports of more severe water shortages and the increasing use of water-saving technologies around the world have required a reassessment of water-saving practices in agriculture. This study develops a simple method based on satellite ET partitions to estimate water intake, consumption, and backflow from the 1980s to the 2010s, and quantifies water savings across the world and four hot irrigated areas at both field and regional scales based on a water accounting system. [32]

Summarizing foreign experience, I would like to note that Uzbekistan has something to borrow to further improve the mechanism for generating reliable information about water resources and providing it to potential consumers by deepening liberal reforms in the field of water resources management.

In particular, Uzbekistan has already taken the first steps to implement public-private partnership in the field of water management, consolidating the system of outsourcing in the use of water bodies. The next stage of this process, in our opinion, should be the participation of business entities in the formation of water-cadastre information on the basis of an investment agreement, which would allow updating the technological basis of water-cadastre activities and improving the quality of the information provided.

### **Proposals for the improvement of water cadastre legislation.**

Based on the above, in order to further improve the water cadastre legislation, we consider it appropriate:

first, to introduce a separate chapter on the state water cadastre in the draft Water Code, which, in our opinion, should look something like this:

#### **"Article X. State Water Cadastre"**

The State Water Cadastre is a geoinformation database on surface and underground water resources, consisting of several independent subsystems, intended for fiscal, legal, informational and administrative purposes, including qualitative and quantitative indicators, economic assessment, information on the geographical and legal status of water resources, as well as water users and water consumers.

#### **Article X. Bodies that maintain the state water cadastre**

The State Water Cadastre is maintained by:

Center of Hydrometeorological Service under the Cabinet of Ministers of the Republic of Uzbekistan - on the division of surface waters;

State Committee of the Republic of Uzbekistan on Geology and Mineral Resources - on the division of underground waters;

Ministry of Water Resources of the Republic of Uzbekistan-under the section of water use.

The data of the state water cadastre are provided by the Ministry of Water Resources of the Republic of Uzbekistan to the Cadastre Agency under the Tax Committee of the Republic of Uzbekistan for its further integration into the National Geographic Information System of the Republic of Uzbekistan.

#### **Article X. Financing and procedure for maintaining the State water cadastre**

The State water cadastre is financed from the State budget and other sources not prohibited by law.

The procedure for maintaining the State water cadastre is determined in accordance with the Regulations on the Procedure for Maintaining the State Water Cadastre.



---

**Article X. Water and cadastral information**

Water-cadastral information includes data on rivers, channels connecting various water systems that serve for territorial redistribution of runoff or irrigation; lakes and reservoirs; glaciers; underground waters (basins, aquifers, deposits) as well as hydroelectric facilities and reservoirs; structures for taking water from water bodies (channels, pumping installations, production wells, etc.); channels that serve for territorial redistribution of runoff; structures for the discharge of used and mine water into water bodies (collectors, drainage and drainage channels, tubular water outlets, etc.); structures for the treatment of used water.

Water cadastre information is intended to provide state authorities and management bodies, interested legal entities and individuals with the necessary data on water bodies, water resources, water regime, quality and use, as well as on water users and the contract for outsourcing of water bodies

**Article X. Provision of water-cadastral information.**

The provision of water cadastre information to state authorities and management bodies is carried out free of charge through the E-Government platform.

The provision of water cadastre information to interested individuals and legal entities is carried out on a paid basis through the territorial divisions of the State Services Agency.

**Article X. Liability for violation of water cadastre legislation.**

Officials and citizens who are guilty of violating the water cadastre legislation are liable in accordance with the established procedure»;

**secondly**, we propose to develop a Regulation on the procedure for providing water cadastre information to interested individuals and legal entities, which provides for:

**Section 1.** General provisions. This section should regulate the grounds for providing cadastral information in one place, the types of water-cadastral information, and the principles of forming water-cadastral information.;

**Section 2.** Types, forms and sources of formation of water-cadastral information. This section should regulate the sources of formation of water-cadastral information, the composition of water-cadastral information, the powers of the competent authorities to maintain the water cadastre when providing water-cadastral information;

**Section 3.** Conditions for the provision of cadastral information to interested individuals and legal entities. This section should regulate such issues as the procedure, conditions and terms of providing information to the appeals of interested individuals and legal entities, the payment procedure, the grounds for refusing to provide water-cadastral information, the procedure for reviewing appeals;

**Section 4.** Responsibility of officials for violation of the order of submission of information. This section should address the issues of holding officials accountable for violations of the procedure and deadlines for providing information to individuals and legal entities. "

Third, we propose to develop a Regulation on the economic assessment of water resources, which provides for:

**Section 1.** General provisions: This section should regulate the definition of the concept of economic assessment of water resources, objects of water resources assessment, subjects of water bodies assessment, environmental damage caused to water resources, risk factors for water resources assessment, criteria for economic assessment, etc.

**Section 2.** The procedure and conditions for conducting an economic assessment. This section should address such issues as the differentiation of water resources assessment based on water quality, criteria for determining the degradation of water bodies as a result of anthropogenic impact on them, the assessment of complex water resources and objects, etc.

**Section 3.** Assessment of water resources at the national level. This section should address the issues of determining the system of central bodies that carry out the assessment, the powers of central bodies that carry out the assessment, the amount of differential rent, etc.

**Section 4.** Assessment of water resources at the territorial level. This section should address the issues of determining the system of territorial bodies that carry out the assessment, the powers of territorial bodies that carry out the assessment, etc.”

fourth, in order to strengthen the scientific and legal development of common problems of water resources use and protection, we propose: to intensify scientific activities in the field of legal regulation of water-legal relations by providing various types of incentives for participation in international projects; to improve the methodological basis of water-cadastre research by ordering the appropriate literature; to open master's courses in law higher educational institutions in the specialty " Water law” .

In conclusion, I would like to note that water is one of the main elements of the universe, which is located inside every earthly substance. Therefore, the lack of water has devastating consequences for people, animals and plants and negatively affects the development of the economy. The existing water problems resulting from global environmental crises and human economic activity are getting worse day by day, and the forecast of the state of water resources is disappointing. At the same time, the need for it is growing every day. Therefore, in order to build the right tactics for the rational use of available water resources and their protection, we must always have complete and reliable water cadastre information at hand.

## REFERENCES

1. Fayziev SH.X. Konstitutsionno-pravovoerealizatsiyaekologicheskoypolitikiRespubliki Uzbekistan.[Constitutional and legal realization of ecological policy of the Republic of Uzbekistan]-.“Yuridikfanlaraxborotnomasi –Vestnikyuridicheskixnauk – Review of law sciences”-ilmiy-amaliyxuquqiyjurnal, 128-133 betlar.Maxsussonli, II-qism . 2021 й;
2. VodnieresursiUzbekstana [Water resources of Uzbekistan]- 2 URL <http://sreda.uz/rubriki/voda/vodnye-resursy-v-uzbekistane-2/> (датаобращение31.03.2021)
3. Г.И.Успенский. «Четвертлошаді»."[It simply came to our notice then]<https://readli.net/chitat-nline/?b=67284&pg=1> data obrashenie 25.03.2021 г.)
4. Fayziev SH.X. Predmet I Sistemavodnogoprava.Vodno-pravovyeotnosheniya.Istochnikivodnogoprava //Vodnoepravo.[The subject and system of water law.Legal relations of water.Sources of water law]. // Water law.Usmanov M.B., RustamboevM.X.Darslik. T.: 2004.-Б. 6-29; 40-51.

5. Suvxuquqi. [Water law] Darslik. (Mualiflarjamousi.) T., TDYUI, 2004, c.72
6. A.R.Saloxiddinov. Vzaimosvyaz problemnih vodnix resursov, stabilnosti i bezopasnosti Uzbekistan puti dostijenie vodnoy bezopasnosti: sbornik statey. [Interaction of problematic water resources, stability and security of Uzbekistan by means of achieving water security: a collection of states] –Tashkent: Red Grey, 2019, c.56
7. E.I.Chembarisov, M.H.Raximova. Vodnie kadastr. [Water cadastre] Uchebnoe posobie. T., 2018 god, s.24
8. Xolmuminov J.T. “Transranichnyevody I osobennostimejdunarodno-pravovoiochranjokrujausheisredy [Peculiarities of studying the sources of the subject "International law of transboundary waters and the environment"]. //Ekologiya habarnomasi, 2016, № 6, 26-28 betlar
9. Skripnikov N.K. Pravovoy rejim polzovanie transgranichnix vod [Legal regime for the use of transboundary waters] // Vedomostiv Verhovnogosuda, 2011, s.35-41
10. Narzullaev O. Biological resources - COVID-19. Legal support of biological resources for scientific purposes and biological safety. Solid State Technology, USA, pp. 434-445, 2020
11. Bogolybov S.A. Ekologicheskoepravo [Ecological law ]: Ucheb .dlyavuzov. M., 2001.c.167
12. Kolbov O.C. Onovom Vodnom kodeksi Rossiyskoy Federatsiyi [About the new Water Code of the Russian Federation ] // Zakonodatelstvo i Ekonomika. 1997. N 1-2. C. 15.
13. Sivakov D.O. Vodnoye pravo. [Water law] Uchebno-prakticheskoye posobiye. [http://mail.icwc-aral.littel.uz/bk/water\\_law/pdf/sivakov.pdf](http://mail.icwc-aral.littel.uz/bk/water_law/pdf/sivakov.pdf):
14. Krassov O.I. Prirodniyeresuri Rossii: Kommentariizakonodatelstva. [Natural resources of Russia: Comments on the legislation ] M.: Delo, 2002.c.236
15. L V. Budaragia, S. V. Tishenko. Stanovlniye i razvitiyegosudarstvennogovodnogoreestra v Rossii [Stanovlniye i razvitiyegosudarstvennogovodnogoreestra v Rossii] // Vestnik VGU. Seria: Pravo, s. 208-213.
16. V.A.Duhovny, N.N.Mirzayev, A.I.Tuchin. Indikatori iuvr [Indicators iuvr] URL <http://www.cawater-info.net/bk/iwrm/pdf/020.pdf>
17. Bekisheva C.D. Sovershenstvovaniye vodnogo zakonodatelstva v usloviyah perehoda Respubliki Kazahstan k «zelyonoy» ekonmike. [Improvement of water legislation in the context of the transition of the Republic of Kazakhstan to a "green" economy ] [http://www.cawater-info.net/bk/water\\_law/pdf/bekisheva.pdf](http://www.cawater-info.net/bk/water_law/pdf/bekisheva.pdf) (data obrasheniya 25.03.2021 )
18. Petrakov S.V. Obuchayushiyseminar vodnoyepravo RespublikiKazahstan – problemi i putiresheniya [Training seminar water law of the Republic of Kazakhstan - problems and solutions] [http://www.cawater-info.net/bk/water\\_law/pdf/petrakov2013-2.pdf](http://www.cawater-info.net/bk/water_law/pdf/petrakov2013-2.pdf) (data obrasheniya 22.03.2021)

19. FilippMiklin, NikolayAladin. VosstanovlenieAralskogo moray [Restoration of the Aral Morae] URL [https://elementy.ru/nauchno-populyarnaya\\_biblioteka/430635/Vosstanovlenie\\_Aralskogo\\_morya](https://elementy.ru/nauchno-populyarnaya_biblioteka/430635/Vosstanovlenie_Aralskogo_morya)
20. R.S.Toshboeva. Osobennostipravovogoregulirovaniyavedeniyakadastrovprirodnihresursov v usloviyahaktivnogovnedreniya v ekonomikuinovationihtehnologiy.Monografiya.[Features of the legal regulation of maintaining cadastres of natural resources in the context of the active introduction of innovative technologies into the economy ] T., TGYUU, 2019, s.37.
21. Strumulin S.G. Ostene «darovihblag» prirodi[About stene "darovihblag" prirodi].\\ Voprosi ekonomiki-1978, №9, s.14-18
22. Hachaturov T.S. Ekonomikaprirodopolzovaniya[Environmental economics ]. –M.: Ekonomika. 1982, s.232
23. NationalnoyevodnoyepravoRespublikiKazahstan i yegouvazka s mejdunarodnimvodnimpravom. Prioriteti i problemi.Napravleniyasovershenstvovaniya [National water law of the Republic of Kazakhstan and its linkage with international water law.Priorities and challenges. Directions for improvement ]URL[http://www.cawater-info.net/review/legal\\_kz.htm](http://www.cawater-info.net/review/legal_kz.htm)
24. [http://www.consultant.ru/document/cons\\_doc\\_LAW\\_60683/dfa1fa66896a0cfafddd17e590111a0dc530e734/](http://www.consultant.ru/document/cons_doc_LAW_60683/dfa1fa66896a0cfafddd17e590111a0dc530e734/) (дата обращения 14.04.2021)
25. [https://online.zakon.kz/document/?doc\\_id=1042116#pos=1320;-8](https://online.zakon.kz/document/?doc_id=1042116#pos=1320;-8)
26. <https://kodeksy.by/vodnyy-kodeks/statuya-58URL>(дата обращения 14.04.2021)
27. Водный Кодекс Республики Беларусь[WaterCodeoftheRepublicofBelarus] URL[https://kodeksy-by.com/vodnyj\\_kodeks\\_rb.htm](https://kodeksy-by.com/vodnyj_kodeks_rb.htm)(дата обращения 10.04.2021)
28. ВодныйкодексТуркменистана[WaterCodeoftheRepublicof Turkmenistan ]URL<http://extwprlegs1.fao.org/docs/pdf/tuk184359.pdf>(датаобращения 12.04.2021)
29. Jonathan C. Ryan, Laurence C. Smith, Sarah W. Cooley , Lincoln H Pitcher , and Tamlin M. Pavelsky. Global characterization of inland water reservoirs using ICESat-2 altimetry and climate reanalysis.American Geophysical Union. All rights reserved.2020 <https://www.scopus.com/record/display.uri?id>
30. Hua Huang, DaizhongSu ,WenjiePeng and You Wu. Development of a Mobile Application System for Eco-Accounting//Sustainability 2020, 12, 9675; [https://www.scopus.com/record/display.uri?eid=10.3390/su12229675file:///C:/Users/HP\\_110/Downloads/Development\\_of\\_a\\_mobile\\_application\\_system\\_for\\_ecoaccounting2020Sustainability.pdf](https://www.scopus.com/record/display.uri?eid=10.3390/su12229675file:///C:/Users/HP_110/Downloads/Development_of_a_mobile_application_system_for_ecoaccounting2020Sustainability.pdf)
31. L. E. Miranda, M. C. Rhodes, Y. Allen, K. J. Killgore. An inventory and typology of permanent foodplain lakes in the Mississippi Alluvial Valley: a frst step to conservation planning. Aquatic Sciences (2021) 83:20 <https://www.scopus.com/record/display.uri?eid>
32. Sarahi Sandoval, Jonathan Gabriel Escobar-Flores y Eduardo Sánchez-Ortíz. Inventario de cuerpos de agua de la Sierra Madre Occidental (México) usando SIG y percepciónremota.InvestigacionesGeográficas<https://www.scopus.com/record/display.uri?>

- eid DOI: dx.doi.org/10.14350/rig.59975 • NOTA TÉCNICA Núm. 102 • Agosto • 2020 • e59975 www.investigacionesgeograficas.unam.mx
- 33.** BelgacemAgoubi. A review: saltwater intrusion in North Africa's coastal areas—current state and future challenges *Environmental Science and Pollution Research* (2021) 28:17029–17043 <https://www.scopus.com/record/display.uri?eiddoi.org/10.1007/s11356-021-12741-z> / Published online: 1 March 2021 E
- 34.** Ramiro Alberdia, \*,1 , Diego A. Erbab. Modeling Legal Land Object for waterbodies in the context of 4D cadaster Received 18 April 2019; Received in revised form 16 November 2019; Accepted 5 December 2019 \* Corresponding author. E-mail addresses: ralberdi@fich.unl.edu.ar (R. Alberdi), diego.erba@utp.edu.co (D.A. Erba). *www.fich.unl.edu.ar. Land Use Policy* 98 (2020) 104417 Available online 12 December 2019 0264-8377/ © 2019 Elsevier Ltd. All rights reserved.
- 35.** Xinyao Zhou a , Yongqiang Zhang b , Zhuping Sheng c , KirilManevskid,e , Mathias N. Andersen d , Shumin Han a , HuilongLia , Yonghui Yang a,f,. Did water-saving irrigation protect water resources over the past 40 years? A global analysis based on water accounting framework// *Agricultural Water Management* 249 (2021) 106793 [https://www.scopus.com/record/display.uri?eidfile:///C:/Users/Lenovo\\_G580/Downloads/Telegram%20Desktop/](https://www.scopus.com/record/display.uri?eidfile:///C:/Users/Lenovo_G580/Downloads/Telegram%20Desktop/)

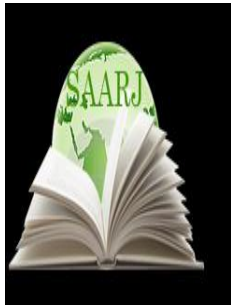

**ACADEMICIA**  
**An International  
 Multidisciplinary  
 Research Journal**  
 (Double Blind Refereed & Peer Reviewed Journal)



**DOI: 10.5958/2249-7137.2021.01259.3**

**THE ROLE OF CHESS IN THE DEVELOPMENT OF INTELLECTUAL  
 ABILITIES OF SECONDARY SCHOOL STUDENTS (BASED ON  
 COMPUTER TECHNOLOGY)**

**Toshev Murodjon Halilovich\***

\*Base Doctoral Student of Bukhara State University,  
 UZBEKISTAN

**ABSTRACT**

*The article provides some comments on the importance of chess (based on computer technology) in the development of intellectual abilities of secondary school students. **Basic terms:** N.N.Moiseev, N.M.Verzilin, E.I.Perovsky, D.O.Lordkipanidze, computer technologies, didactic principle, method, oral, visual, practice, observation.*

**KEYWORDS:** *N.N. Moiseev, N.M. Verzilin, E.I. Perovsky, D.O. Lordkipanidze, Computer Technologies, Didactic Principles, Method, Verbal, Visual, Practice, Observation.*

**INTRODUCTION**

About 60% of the population of the Republic of Uzbekistan are young people. Teaching them to care for our Motherland is one of the highest tasks of all educational institutions. Especially in the development of society, the education of mature young people is very important. In this case, the use of various tools, including games, in the development of intellectual abilities of students from the primary grades of schools is very effective. Today, our young people are regularly involved in games such as football, volleyball, wrestling, chess and checkers. Among them, the introduction of chess as a subject in a number of schools of our country is becoming important in educating young people mentally and spiritually.

Experiments have shown that students who play chess have a 40 percent higher response to intellectual influences. In the words of academician NN Moiseev, intellect is, first of all, the pursuit of a goal, an estimate of it, the planning of resources to achieve a goal. These are the algorithms of the game of chess. Chess gives joy and pleasure to students, enriches their spiritual worldview.

In order to use the intellectual abilities of secondary school students and the great potential of the game of chess in their development, firstly, it is necessary to pay attention to the correct choice

of didactic principles and methods, and secondly, to use didactic principles and methods. Ensuring the connection (combination) of theory and practice from the didactic principles, the systematic formation of skills and competencies, as well as the provision of visual aids are very effective in education. Source-based learning methods have been categorized by scholars such as N.M.Verzilin, E.I.Perovsky, D.O.Lordkipanidze into 3 groups (oral, visual and practical).

According to the classification of these scientists, resource-based learning methods are selected in the development of students' intellectual abilities (Figure 1).

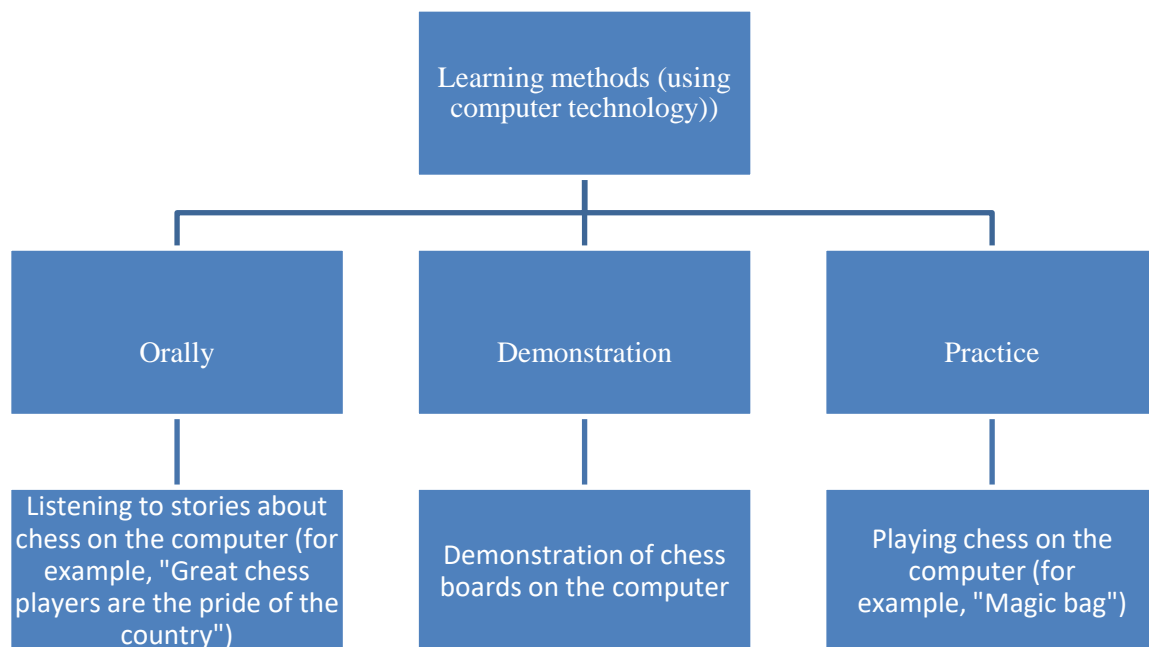

Figure 1. Use of computer technology in the use of resource-based learning methods Listening to the story from the above methods, observation, playing chess with the help of a computer is very important. Through the method of observation, students' behavior during lessons and games, attitude to the opponent (peer), mood, personal qualities are studied.

The above qualities of students can also be studied using the survey method (test form). The form of taking tests from students is especially popular.

1. Which game do you like?

A. I love football. I love chess

2. Are you bored playing chess?

A. for me the game of chess is boring V. i don't get bored of playing chess

3. Do you play chess at home?

A. Yes, we play chess at home. No, we don't play chess at home

4. Have you ever played chess on a computer?

A. I played chess on the computer. I didn't play chess on the computer

5. Is it good to play chess on the computer?

A. Ha V. No.

6. What do you do if your opponent swallows in chess?

A. Congratulations to my opponent on the victory. I am saddened by his victory.

Bukhara city No. 1 Children and Youth Sports School "Chess" circle students Kholmurodaliyev Abdulkakor Bukhara city 21 - secondary school student "Football" 5 other people interested in the game; Bakhtiyorova Robiya, Tohirova Umida, Zoyirov Muhammadziyo, Rakhmonova Shakhlokhon 1st grade and 3rd Shirinov Begzodlar Tests taken from 8th grade students of Bukhara city will be checked and their attitude to chess will be analyzed. The attitude of students who chose 10-40 percent of chess is unsatisfactory, 41-50 percent are partially satisfactory, 51-70 percent are satisfactory, and 71-100 percent are exemplary.

After this method, work will be organized to increase students' interest in the game of chess.

## REFERENCES

1. Коняева Е.А., Павлова Л.Н. Краткий словарь педагогических понятий: учебное издание / Е.А. Коняева, Л.Н. Павлова. - Челябинск: Изд-во Челяб.гос.пед.ун-та, 2012-131с.
2. Ўзбек тилининг изоҳли луғати."Ўзбекистон миллий энциклопедияси" Давлат илмий нашриёти. Тошкент.
3. Дўстов Б.А.Фазлиддинов Ф.С Собирова Н.Р. Psychological impact of football games to the formation of individuality of the student Journal of Critical Reviews 17.04.2020 стр 466-469
4. Абдуллаев М.Ж. Бошланғич тайёргарлик босқичида шуғулланувчи ўсмир енгил атлетикачиларнинг жисмоний тайёргарлиги динамикаси // "Фан-спортга" илмий назарий журнал. – Тошкен, 2018, №2. 13-15 б. [13.00.00№16].
5. Абдуллаев М.Ж. О некоторых особенностях кинематики метания диска с места // Система менеджмента качества в вузе: здоровье, образованность, конкурентоспособность. Сб. науч. тр. VII Междунар. науч. - практ. конф., 2018, С. 7-10.
6. Абдуллаев М.Ж. Физкультурно-оздоровительные подходы в процессе физического воспитания студентов вузов // Система менеджмента качества в вузе: здоровье, образованность, конкурентоспособность. Сб. науч. тр. VII Междунар. науч. - практ. конф., 2018, С. 10-14.
7. Абдуллаев М.Ж. Swot-анализ в структуре информационных технологий физического воспитания // Система менеджмента качества в вузе: здоровье, образованность, конкурентоспособность. Сб. науч. тр. VII Междунар. науч. - практ. конф., 2018, С. 14-18.
8. Абдуллаев М.Ж. Взаимосвязь физическое и психического развития детей в процессе физического воспитания. // Журнал. Вестник интегративной психологии. Ярославл,



2018. №17. 10-13 б. [13.00.00№23].
9. Абдуллаев М.Ж., Олимов М.С., Тўхтабоев Н.Т. Енгил атлетика ва уни ўқитиш методикаси. Дарслик. “Баркамол файз медиа” нашриёти Тошкент-2017 й. 620 бет
  10. M.J.Abdullaev. Methodology of application games in the training of young athletes//ACADEMICIA: An International Multidisciplinary Research Journal. ISSN: 2249-7137 Vol. 10, Issue 11, November 2020 Impact Factor: SJIF 2020 = 7.13/ 497-504 pg.
  11. M.J.Abdullaev. Characteristics, forms and methods of extracurricular activities with athletes of different ages//European Journal of Research and Reflection in Educational Sciences Vol. 8 No. 11, 2020 ISSN 2056-5852. 110-114 pg.
  12. M.J.Abdullaev. Methodology of application games in the training of young athletes//European Journal of Research and Reflection in Educational Sciences Vol. 8 No. 11, 2020 ISSN 2056-5852. 115-122pg.
  13. S.S., M.J.Abdullayev, A.T., O.Yu.. Improving Methodology Of Action Games In Training Athletes Of Different Ages//*European Journal of Molecular & Clinical Medicine*, 2021, Volume 8, Issue 1, Pages 806-813. [https://ejmcm.com/article\\_6556.html](https://ejmcm.com/article_6556.html)
  14. M.J.Abdullayev, O.I. Berdiyev, N.R. Omonova. Methodology Of Organization Of" Physical Education And Sports" Lessons In Higher Educational Institutions//The American journal of social science and education innovations (TAJSSEI) SJIF-5.857 DOI-10.37547/TAJSSEI Volume 3 Issue 02, 2021 ISSN 2689-100X. 3 (02), 312-320
  15. M.J.Abdullayev, Z.M.Turayeva Methodology Of Teaching 18-20 Year Old Girls For Healthy Aerobic Exercises // The American Journal of Medical Sciences and Pharmaceutical Research (ISSN – 2689-1026) Published: February 28, 2021 | Pages: 77-85
  16. S.S.Tajibaev, M.J.Abdullaev, A.T.Niyazov, O.Yu.Niyazova. This article scientifically analyzes and substantiates the methodology of using movement games in the development of physical and psychological training of 11-12-year-old athletes in the primary training group //*European Journal of Molecular & Clinical Medicine*,2020, Volume 7, Issue 6, Pages 2907-2914
  17. A.K.Ibragimov. Catalog of training tasks for training special endurance of yonggrilhandball players//Academical.An International Multidisciplinary Research Journal 2.35-39p
  18. R.R.Raxmonov. Distribution of training loads at the stage of competitive preparation for middle runners // ACADEMICIA: An International Multidisciplinary Research Journal <https://saarj.com> ISSN: 2249-7137 Vol. 11, Issue 2, February 2021 Impact Factor: SJIF 2021 = 7.492 Pages 768-777.
  19. F.Fazliddinov, M.Toshev N.Sabirova, B.Do'stov. Psychological impact of football games to the formation of individuality of the student. Journal of Critical Reviews ISSN- 2394-5125. 2020
  20. U.A.Farmonov The system of training young basketball players at the initial stage of training at school. Asian Journal of Multimedimensional Research (AJMR) 2020. Vol 9,Issue 11, DOI: 10.5958/2278-4853.2020.00279.7

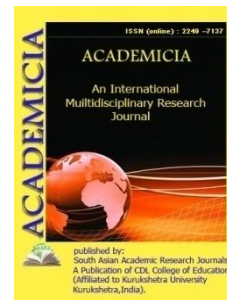
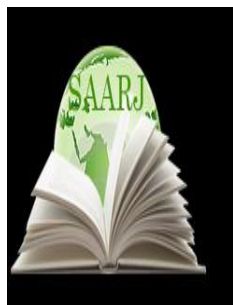

DOI: **10.5958/2249-7137.2021.01260.X**

## THE TECHNOLOGY OF INCREASING THE EFFECTIVENESS OF MATHEMATICS LESSONS IN INNOVATIVE EDUCATIONAL CONDITIONS

**Muxamadaliyeva Madinabonu Bohodirjon qizi\***

\*Lecturer,

Mathematics In Primary Education Methodology,  
Fergana State University, UZBEKISTAN

### ABSTRACT

*Today, the teacher requires the use of advanced pedagogical and new information technologies in the educational process. The introduction of advanced pedagogical and new information technologies in education not only increases the effectiveness of training, but also plays an important role in the upbringing of an independent and logical thinking, comprehensively high spiritual person by applying the achievements of Science in practice. This article describes the ways of teaching and learning using interactive techniques in the lessons.*

**KEYWORDS:** *Pedagogical Technology, Intellectual Attack, Technique, Grosses Intellectual Attack.*

### INTRODUCTION

The state standard of education is called upon to create equal opportunities for each of the students in their education, to encourage each of them to achieve a higher result and thereby ensure that the educational - cognitive process is organized differently. The production of state educational standards in the field of Science, Education on the basis of choice of educational disciplines implies the modernization of educational methodological complexes, including the teaching of mathematics in primary classes. The implementation of arithmetic in primary classes on the basis of the principle of linking and coordination of knowledge serves to ensure the internal linkage of Educational Sciences and Inter-interdependence of Educational Sciences. The Fulfillment by the students of the requirements for the performance of arithmetic operations in the primary classes helps them to acquire the necessary knowledge, skills and conics.

a) Adaptation of pupils to the surrounding natural environment.

- b) Acquisition of Educational Labor, communication of various types of activity.
- c) Self-control and assessment training.
- d) Definition General natural-a defined level of scientific knowledge is a description of its further development.

Thus, the process of performing arithmetic in the primary classes provides not only knowledge, conics and competency in teaching mathematics to the educational-cognitive process, but also the formation of qualities corresponding to the specific set of basic activities of the individual - labor training, communicative-moral and physical - perfection.

Theoretical basis of the methodology of teaching students to perform arithmetic operations. As stated in the "National Program of Personnel Training" in the law on development of Education" on the changes taking place in the system of public and economic relations, public education" each class student is assigned an important task. These tasks also allow to specific joints for primary education, since these joints can form a network in a variety of educational science programs, curricula, textbooks on the introduction of education, as well as in the methodological system.

The state educational standards open up wide opportunities for the creation of educational and methodological complexes (programs, curricula, courses, as well as provide for the connection of educational disciplines and the connection of educational disciplines on the basis of the principle of knowledge achievement. In the new course of mathematics, similar to the previous one, arithmetic plays a key role. In the new program of classes I-IV, the content of arithmetic materials has not changed much: the theory of arithmetic (the change of properties, results of actions and the results of actions when one of the components changes) is less illuminated, the theory is more strengthened by the connection of practical issues (counting, measurements, calculations, solving issues): the formation of concepts (number, counting, system, arithmetic Also the initial learning style of arithmetic has been perfected. It is included in the new science-based method and methodological school program aimed at Timely summarizing the facts and observations that are based on the activation of their recovery activities from all stages of the teaching of junior students, the appointment of a reciprocal link between certain issues, the emergence of independent performance studies in children. In the distribution of the study material by the academic years, it is planned to gradually increase the area of the studied numbers.

Numbers from 1-th grade I to 20.

Numbers from 2-th grade I to 100.

Numbers from 3-th grade I to 1000.

Numbers from Grade 4 to 1000000.

And, that is, multi-digit numbers are studied. The material for arithmetic operations is studied as concentrates. In total, there are five concentrates: decimal, second decimal, hundred, thousand, multi-digit numbers.

Each concert reflects in its content the main issues of the systematic arithmetic, for shimming, students learn the steps on the numbers within these or that limits, creating an idea of the essence

of arithmetic in general. Each time repeatedly resorting to the implementation of actions on the basis of a new finite material allows deepening and expanding the content of the most important arithmetic concepts. In addition, the gradual formation of solid learning and skills ( in counting, measurements, oral and written nomenclature, calculation, etc.k is provided, because the methods of performing these actions are gradually complicated by maintaining the generality. Thus, the study of nomenclature and arithmetic operations in each previous center is considered to be a preparatory work for further study of the corresponding issues, while in each subsequent Center the previously studied material is summarized and consolidated.

The methodology of teaching elementary mathematics is closely related to several disciplines. 1) With mathematics as the basis of teaching; 2) pedagogy; 3) Psychology; 4) with other teaching methods (native language, labor ...). The course of Primary Mathematics Education has become a subject of study. Functions of teaching methodology in elementary mathematics teaching:

1) to be able to carry out educational and practical tasks, 2) to enlighten the learning process of the system of theoretical knowledge; 3) to be able to teach the ways of forming the worldview of students;

4) Humanization of Education; 5) in the process of teaching mathematics shows the love of human labor, the upbringing of such qualities as self-esteem, hormones of each other; 6) teaching methodology shows the connection with the content of mathematics of the V–VI class, which is a continuation of mathematics of the I–IV classes.

The task of the elementary mathematics course is to help the school solve such tasks as “the use of new technology in providing students with thorough knowledge of the basics of science, giving them the current socio-economic knowledge, directing them to marriage, profession, training them to make a conscious choice”. Today, a number of developed countries have accumulated considerable experience in the application of pedagogical technologies that increase the educational and creative activity of students and guarantee the effectiveness of the educational process, and the methods that form the basis of this experience are called interactive methods. Below we will talk about the essence and use of several of the interactive techniques that are used in their practice.

#### The” thought attack» method

This method serves to ensure the activity of students in the process of training, to encourage them to think freely, to release from the inertia of the same thinking, to gather colorful ideas on a particular subject, as well as to learn to overcome the thoughts that arise at the initial stage of the process of solving creative tasks. Method” intellectual attack "A.F.Recommended by Osborn, his basic principle and condition is an expression from the absolute prohibition of criticism, stimulation of all kinds of bites and Jokes In relation to the thought that is being put forward by each participant of the exercise. The aim of this study is to provide free participation of students in the training process. The use of this method in the educational process will depend on the breadth of the pedagogical skills and scope of thought of the teacher.During the use of the” thought attack" method, it is desirable that the number of readers does not exceed 15 people. Training based on this method can be organized up to one hour.

The method of " gross intellectual attack”

This method is J.Developed by Donald Phillips, it can be used in classes consisting of several dozen (20-60) students. The method serves to create conditions for the expulsion of new ideas by students. Each group of 5 or 6 students must be positively addressed within 15 minutes after the different tasks or creative tasks are positively addressed within the specified time period, one of the members of the group will be informed about this. The information given by the group (assignment or solution of the creative task) is discussed and evaluated by the teacher and members of other groups. At the end of the training, the teacher announces the answers that are found to be the best and specific among the solutions of the given task or creative tasks. In the process of training, the activities of the members of the groups are evaluated according to the level of their participation.

The essence of the method is as follows: - assistance in the realization of the personal capabilities of each student performing certain tasks among the team; - the ability of students to put forward an idea against the idea expressed by a particular team. The training, based on the use of the method of "severe attack of thoughts", is organized in the following stages: 1-stage: the formation of small groups of students who are mentally close to each other, which are attached to themselves and are numerically equal; 2-stage: the identification of goals arising from the essence of the task or tasks assigned to the solution); Step 4: discuss the solutions of tasks, divide them into categories according to the correct solution; Step 5: reclassification of the solutions of tasks, that is, their correctness, the time spent on finding a solution, evaluation based on such criteria as a clear and clear description of the solutions; Step 6: discuss specific critical comments expressed on the solutions of tasks in the initial stages.

## REFERENCE

1. Makhmudova A. Guarantee of legal basic of supporting human rights in new level of Uzbekistan's development . International Journal of Advanced Science and Technology Vol.29 No.5, (2020), pp.1761-1770 <http://sersc.org/journals/index.php/IJAST/article/view/10305/5558>
2. Nugmanovna M. A. Factors and means of the content of legal socialization of the individual in modern civil society (<https://www.scopus.com/record/display.uri?eid=2-s2.0-85088801526&origin=resultslist&sort=plf-f&src=s&nlo=&nlr=&nls=&sid=c1f62c57476f328531a90cad4b4b4d7a&sot=aff&sdt=a&sl=51&s=AF>)

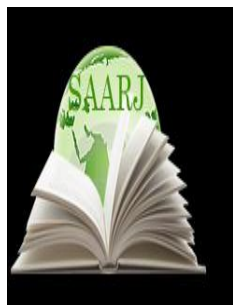

**ACADEMICIA**  
**An International**  
**Multidisciplinary**  
**Research Journal**  
 (Double Blind Refereed & Peer Reviewed Journal)

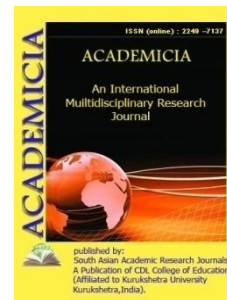

**DOI: 10.5958/2249-7137.2021.01261.1**

## ON MODELING OF MECHANICAL VIBRATIONS OF ORTHOTROPIC BOARDS IN ELECTRONIC DEVICES

**Abjalilov Sanakul Xujamovich\***; **Ashurova Dilfuza Nabiyevna\*\***;  
**Begmurodov Otabek Ahmadovich\*\*\***

\*Associate Professor,  
 Candidate of physical and Mathematical Sciences,  
 Navoi State Pedagogical Institute,  
 UZBEKISTAN

\*\*Associate Professor,  
 Doctor of Philosophy in Pedagogical Sciences,  
 Navoi State Pedagogical Institute,  
 UZBEKISTAN

\*\*\*Teacher, NSPI  
 UZBEKISTAN

### ABSTRACT

*Decisions of the homogeneous and non-uniform equation of a bend orthotropic on mechanical properties of the rectangular plate, received are described by a recurrently-operational method. For an illustration of algorithm of the decision of problems the recurrently-operational method results numerical results of test problems for the non-uniform equation, satisfying to initial and boundary conditions.*

**KEYWORDS:** *Electronic Equipment, Orthotropic Plate, Lamé Equation, Recurrent Operator Method.*

### INTRODUCTION

In modern conditions, electronic equipment, in addition to meeting the main set of technical characteristics, is subject to a number of strict requirements aimed at improving the design of electronic equipment that is resistant to mechanical and thermal disturbances [1].

In the monograph [2], discrete models of devices are considered without taking into account the anisotropy of electronic boards. However, when placing individual electronic devices on the

boards, some structural anisotropy of mechanical and thermal properties is created. Therefore, when placing individual elements in an electronic circuit, it is desirable to ensure the regularity of the structure so that the board can be considered as an orthotropic plate.

This article deals with the problem of mechanical vibrations of an orthotropic plate.

As is known, the problem of the eigenvalues of an orthotropic plate is reduced to solving the differential equation of plate deflections [3, 4, and 5]

$$L(w) \equiv \left( b_0 \frac{\partial^4}{\partial x^4} + b_1 \frac{\partial^4}{\partial x^2 \partial y^2} + b_2 \frac{\partial^4}{\partial y^4} + \frac{\partial^2}{\partial t^2} \right) w = 0, \quad (1)$$

Satisfying the initial and boundary conditions. Here

$$b_0 = \frac{1}{\rho} D_1; \quad b_1 = \frac{2}{\rho} D_3; \quad b_2 = \frac{1}{\rho} D_2; \quad f = \frac{1}{\rho} f_q; \quad \rho = \frac{h_0 \gamma}{g};$$

$$D_1 = \frac{E_1 h_0^3}{12(1 - \nu_1 \nu_2)}; \quad D_2 = \frac{E_2 h_0^3}{12(1 - \nu_1 \nu_2)}; \quad D_3 = D_1 \nu_2 + 2D_k; \quad D_k = \frac{G h_0^3}{12},$$

$h_0$  – Plate thickness;  $\gamma$  – specific gravity of the plate material;  $E_1, E_2, \nu_1, \nu_2, G$  – Young's modules, Poisson's coefficients, and the shear modulus for the principal directions;  $D_1, D_2$  – cylindrical stiffness;  $\lambda, \mu$  – Lamé constants,  $w(x, y, t)$  – deflections of the median surface of the plate.

#### Problem statement

Find deflections  $w(x, y, t)$  the median surface of an orthotropic articulated plate satisfying equation (1) and the following boundary and initial conditions:

$$w \Big|_{\substack{x=0,a \\ y=0,b}} = \frac{\partial^2 w}{\partial x^2} \Big|_{x=0,a} = \frac{\partial^2 w}{\partial y^2} \Big|_{y=0,b} = 0 \quad (2)$$

$$w \Big|_{t=0} = 0, \quad \frac{\partial w}{\partial t} \Big|_{t=0} = f(x, y). \quad (3)$$

To solve the problem (1) - (3), we apply the recurrent operator method [6,7].

Following the recurrent-operator method, the solution of the homogeneous equation (1) is sought in the form

$$w_r[g_r(x, y)] = \sum_{i=0}^{\infty} \sum_{j=0}^{\infty} Q_{i,j} \frac{\partial^{2i+2j}}{\partial x^{2i} \partial y^{2j}} g_r(x, y) \frac{t^{i+j+r}}{(i+j+r)!}, \quad r = 0, 1. \quad (4)$$

Where  $g_r(x, y)$  – An arbitrary analytical function.

$Q_{i,j}$  – The constant coefficients determined from equation (1)

Substituting (4) in (1), we get,

$$\begin{aligned}
& b_0 \sum_{i=0}^{\infty} \sum_{j=0}^{\infty} Q_{i,j} \frac{\partial^{2(i+j+2)}}{\partial x^{2(i+2)} \partial y^{2j}} g(x,y) \frac{t^{i+j+r}}{(i+j+r)!} + \\
& + b_1 \sum_{i=0}^{\infty} \sum_{j=0}^{\infty} Q_{i,j} \frac{\partial^{2(i+j+2)}}{\partial x^{2(i+1)} \partial y^{2(j+1)}} g(x,y) \frac{t^{i+j+r}}{(i+j+r)!} \\
& + b_2 \sum_{i=0}^{\infty} \sum_{j=0}^{\infty} Q_{i,j} \frac{\partial^{2(i+j+2)}}{\partial x^{2i} \partial y^{2(j+2)}} g(x,y) \frac{t^{i+j+r}}{(i+j+r)!} + \\
& + \sum_{i=0}^{\infty} \sum_{j=0}^{\infty} Q_{i,j} \frac{\partial^{2(i+j)}}{\partial x^{2i} \partial y^{2j}} g(x,y) \frac{t^{i+j+r-2}}{(i+j+r-2)!} = 0
\end{aligned}$$

Replacing the index  $i$  in the first double sum with  $i-2$ , in the second  $i$ -with  $i-1$ ,  $j$ -with  $j-1$  and in the third sum  $j$ -with  $j-2$ , and after combining all the sums into one, we get

$$\sum_{i=0}^{\infty} \sum_{j=0}^{\infty} [b_0 Q_{i-2,j} + b_1 Q_{i-1,j-1} + b_2 Q_{i-1,j-1} + Q_{i,j}] \frac{\partial^{2(i+j)}}{\partial x^{2i} \partial y^{2j}} g(x,y) \frac{t^{i+j-2}}{(i+j-2)!} = 0$$

In order for this equality to hold for all values of the common factor, the expression in square brackets must be set to zero. As a result, the problem is reduced to solving the following numerical recurrence relation

$$Q_{i,j} = -(b_0 Q_{i-2,j} + b_1 Q_{i-1,j-1} + b_2 Q_{i,j-2}) \quad (5)$$

Under initial conditions

$$Q_{i,j} = 0 \text{ By } i < 0 \text{ or } j < 0; \quad Q_{0,0} = 1. \quad (6)$$

Here are the first few coefficients  $Q_{i,j}$ :

$$\begin{aligned}
& Q_{0,0} = 1, \quad Q_{0,1} = 0, \quad Q_{0,2} = -b_2, \quad Q_{0,3} = 0, \dots \\
& Q_{1,0} = 0, \quad Q_{1,1} = -b_1, \quad Q_{1,2} = 0, \quad Q_{1,3} = 2b_1 b_2, \dots \\
& Q_{2,0} = -b_0, \quad Q_{2,1} = 0, \quad Q_{2,2} = 2b_0 b_2 + b_1^2, \quad Q_{2,3} = 0, \dots \\
& Q_{3,0} = 0, \quad Q_{3,1} = 2b_0 b_1, \quad Q_{3,2} = 0, \quad Q_{3,3} = -4b_0 b_1 b_2 - b_1(2b_0 b_2 + b_1^2), \dots \\
& \dots
\end{aligned}$$

By the method of complete mathematical induction, we can show the validity of the expressions



$$Q_{2i,2j} = (-1)^{i+j} \sum_{s=0}^i \frac{(i+j)!}{s!(2i-2s)!(j-i+s)!} b_0^s b_1^{2(i-s)} b_2^{j-i+s},$$

$$Q_{2i+1,2j+1} = (-1)^{i+j+1} \sum_{s=0}^i \frac{(i+j+1)!}{s!(2i-2s+1)!(j-i+s)!} b_0^s b_1^{2(i-s)+1} b_2^{j-i+s}; \quad (7)$$

In this case, the terms with negative powers at  $b_2$  should be considered equal to zero.

Note that the sum of all the coefficients is  $Q_{i,j}$ , for which  $i + j = 2k$ ,

$$(-1)^k (b_0 + b_1 + b_2).$$

In the isotropic case, i.e., when the coefficients in equation (1) are equal  $b_0 = b_2 = b^2$ ,  $b_1 = 2b^2$ , we get  $Q_{i,j} = 0$  при  $i + j$  odd and

$$Q_{i,j} = (-1)^{\frac{i+j}{2}} \frac{(i+j)!}{i!j!} b^{i+j} \text{ при } i + j \text{ even-numbered.}$$

By directly using the recurrent relation (5), taking into account (6), we can make sure that the coefficients  $Q_{i,j}$  with an odd sum of the indices  $i$  and  $j$  are zero.

Changing the order of summation, we present (4) as:

$$w = \sum_{i=0}^{\infty} \left( \sum_{j=0}^i Q_{i-j,j} \partial_x^{2(i-j)} \partial_y^{2j} (g) \right) \frac{t^{i+r}}{(i+r)!}.$$

Substituting (7) into this expression and collapsing the internal sum, we get the solution of equation (1) in the following operator form:

$$w = \sum_{i=0}^{\infty} (-1)^i \Delta_{xy}^{2i} (g) \frac{t^{2i+r}}{(2i+r)!}, \quad (8)$$

Where  $\Delta_{xy}^{2i} (\cdot) \equiv (b_0 \partial_x^4 + b_1 \partial_x^2 \partial_y^2 + b_2 \partial_y^4)^i (\cdot)$ .

For function (4), the following differentiation formulas are true:

$$\begin{aligned} \frac{\partial}{\partial x} w_r(g) &= w_r \left( \frac{\partial}{\partial x} g \right), \quad \frac{\partial}{\partial y} w_r(g) = w_r \left( \frac{\partial}{\partial y} g \right), \quad \frac{\partial}{\partial t} w_1(g) = w_0(g), \\ \frac{\partial}{\partial t} w_0(g) &= \frac{\partial}{\partial t} g + \left[ b_0 w_1 \left( \frac{\partial^4}{\partial x^4} g \right) + b_1 w_1 \left( \frac{\partial^4}{\partial x^2 \partial y^2} g \right) + b_2 w_1 \left( \frac{\partial^4}{\partial y^4} g \right) \right]. \end{aligned} \quad (9)$$

We find a solution to the Cauchy problem for equation (1) under the initial conditions

$$w \Big|_{t=0} = \phi_0(x, y), \quad \frac{\partial w}{\partial t} \Big|_{t=0} = \phi_1(x, y) \quad (10)$$

We will look for a solution to the problem (1), (9) in the form

$$w = w_0(g_0) + w_1(g_1). \quad (11)$$

Substituting (11) into (10), using the differentiation formulas (9) and considering that  $w_0(g) \Big|_{t=0} = g$ ,  $w_1(g) \Big|_{t=0} = 0$ , получим

$$g_0 = \phi_0, \quad g_1 = \phi_1.$$

Therefore, the solution to problem (1), (10) is the function

$$w(x, y, t) = w_0(\phi_0) + w_1(\phi_1) \quad (12)$$

Let

$$\phi_0 = \xi_{\lambda, m, n}(x, y), \quad \phi_1 = 0, \quad (13)$$

Where

$$\begin{aligned} \xi_{1, m, n}(x, y) &= \sin a_m x \sin b_n y; & \xi_{2, m, n}(x, y) &= \cos a_m x \sin b_n y; \\ \xi_{3, m, n}(x, y) &= \sin a_m x \cos b_n y; & \xi_{4, m, n}(x, y) &= \cos a_m x \cos b_n y. \end{aligned} \quad (14)$$

Substituting (14) in (13) and taking into account (4), we get

$$\begin{aligned} w_0^{\lambda, m, n} &= \\ &= \xi_{\lambda, m, n} \sum_{i=0}^{\infty} \sum_{j=0}^{\infty} (-1)^{i+j} Q_{i, j} a_m^{2i} a_n^{2j} \frac{t^{(i+j)}}{(i+j)!} = \\ &= \xi_{\lambda, m, n} \sum_{i=0}^{\infty} \sum_{j=0}^{\infty} (-1)^{i+j} Q_{i, j} a_m^{2i} a_n^{2j} \frac{t^{(i+j)}}{(i+j)!} = \\ &= \xi_{\lambda, m, n} \sum_{k=0}^{\infty} (-1)^k (b_0 a_m^4 + b_1 a_m^2 b_n^2 + b_2 b_n^4)^k \frac{t^{2k}}{(2k)!} = \xi_{\lambda, m, n} \cos \sqrt{\delta} t, \end{aligned} \quad (15)$$

Where

$$\delta = b_0 a_m^4 + b_1 a_m^2 b_n^2 + b_2 b_n^4 \quad (16)$$

The coefficients property is used here  $Q_{i, j} = 0$  by  $i + j = 2k + 1$ , and also the ratio

$$\sum_{i=0}^{2k} Q_{i, 2k-i} a_m^{2i} b_n^{2(2k-i)} = (-1)^k \delta^k.$$

In the case of an isotropic plate, we obtain

$$w_0^{\lambda, m, n} = \xi_{\lambda, m, n} \cos[b(a_m^2 + b_n^2)t] \quad (17)$$

The function (15) satisfies equation (1) and the initial conditions (13).

If the initial conditions are given as

$$\phi_0 = 0, \quad \phi_1 = \xi_{\lambda, m, n}(x, y), \quad (18)$$

Then the solution to the Cauchy problem will have the form

$$w_1^{\lambda, m, n} = \xi_{\lambda, m, n} \sum_{i=0}^{\infty} \sum_{j=0}^{\infty} (-1)^{i+j} Q_{i, j} a_m^{2i} a_n^{2j} \frac{t^{(i+j+1)}}{(i+j+1)!} = \xi_{\lambda, m, n} \frac{1}{\sqrt{\delta}} \sin \sqrt{\delta} t. \quad (19)$$

In the case of an isotropic plate, the solution (19) will take the form

$$w_1^{\lambda, m, n} = \xi_{\lambda, m, n} \frac{1}{b(a_m^2 + b_n^2)} \sin[b(a_m^2 + b_n^2)t] \quad (20)$$

The function (19) satisfies equation (1) and the initial conditions (18). We

Proceed to the solution of the inhomogeneous equation

$$L(w) \equiv \left( b_0 \frac{\partial^4}{\partial x^4} + b_1 \frac{\partial^4}{\partial x^2 \partial y^2} + b_2 \frac{\partial^4}{\partial y^4} + \frac{\partial^2}{\partial t^2} \right) w = f(x, y, t) \quad (21)$$

In accordance with the recurrent operator method [6, 7], the solution of equation (1) is

$$w_3(f) = \sum_{i=0}^{\infty} \sum_{j=0}^{\infty} Q_{i,j} \frac{\partial^{2(i+j)}}{\partial x^{2i} \partial y^{2j}} \frac{\partial^{-(i+j+2)}}{\partial t^{-(i+j+2)}} (f). \quad (22)$$

$Q_{i,j}$  -it is taken by the formula (5),  $\frac{\partial^{-s}}{\partial t^{-s}} (f) = \int_0^t \dots \int_0^t f(x, y, t) dt^s$ .

The general solution of equation (1) is the sum of solutions (4) and (21). Assuming

$F(x, y, t) = \phi(x, y) \psi(t)$ , we represent (22)

$$\begin{aligned} w_3(f) &= -(Q_{0,0} f^{-2} + Q_{0,1} f y^{-3} + Q_{0,2} f y^{-4} + Q_{0,3} f y^{-5} + \dots \\ &\quad + Q_{1,0} f x^{-3} + Q_{1,1} f x^2 y^2 + Q_{1,2} f x^2 y^4 + \dots \\ &\quad + Q_{2,0} f x^4 + Q_{2,1} f x^4 y^2 + \dots \\ &\quad + Q_{3,0} f x^6 + \dots) = \\ &= \left[ Q_{0,0} \phi \psi^{-2} + \underbrace{(Q_{1,0} \partial_{x^2} + Q_{0,1} \partial_{y^2})}_{=0} (\phi)(\psi)^{-3} + \right. \\ &\quad \left. + (Q_{2,0} \partial_{x^4} + Q_{1,1} \partial_{x^2 y^2} + Q_{0,2} \partial_{y^4}) (\phi)(\psi)^{-4} + \right. \\ &\quad \left. \underbrace{(Q_{3,0} \partial_{x^6} + Q_{2,1} \partial_{x^4 y^2} + Q_{1,2} \partial_{x^2 y^4} + Q_{0,3} \partial_{y^6})}_{=0} (\phi)(\psi)^{-5} + \right. \\ &\quad \left. + (Q_{4,0} \partial_{x^8} + Q_{3,1} \partial_{x^6 y^2} + Q_{2,2} \partial_{x^4 y^4} + \right. \\ &\quad \left. + Q_{1,3} \partial_{x^2 y^6} + Q_{0,4} \partial_{y^8}) (\phi)(\psi)^{-6} + \dots \right] \end{aligned}$$

Adding expressions  $Q_{i,j}$  from (5), we get

$$w_3(f) = w_3(\phi(x, y) \psi(t)) = \sum_{k=0}^{\infty} (-1)^k \Delta_{xy}^{2k} (\phi) \int_0^t \dots \int_0^t \psi(t) dt^{2k+2}. \quad (23)$$

**Example.** We solve the problem of forced vibrations of a rectangular, orthotropic, hinged plate. The problem is reduced to solving equation (21) under the following boundary and initial conditions

$$w \Big|_{\substack{x=0,a \\ y=0,b}} = \frac{\partial^2 w}{\partial x^2} \Big|_{x=0,a} = \frac{\partial^2 w}{\partial y^2} \Big|_{y=0,b} = 0, \quad w \Big|_{t=0} = 0, \quad \frac{\partial}{\partial t} w \Big|_{t=0} = 0.$$

$$f = \sin \frac{\pi}{20} x \sin \frac{\pi}{20} \cos \omega t, \quad b_0 = 0,735 \cdot 10^{-5} \frac{cM^2}{\kappa^2}, \quad b_1 = 1,2436 \cdot 10^{-5} \frac{cM^2}{\kappa^2}, \quad b_2 = 0,508 \cdot 10^{-5} \frac{cM^2}{\kappa^2}, \quad \omega = 20c^{-1} \text{ (the material is fiberglass CAST-In) [3,4].}$$

Let's solve the test problem of mechanical vibrations for a rectangular ( $0 \leq x \leq a$ ,  $0 \leq y \leq b$ ) plates in the case of equation (1) with the right-hand side

$$f = \sin \frac{\pi x}{a} \sin \frac{\pi y}{b} \cos \omega t, \quad (24)$$

under the following conditions

$$w \Big|_{\substack{x=0,a \\ y=0,b}} = \frac{\partial^2 w}{\partial x^2} \Big|_{x=0,a} = \frac{\partial^2 w}{\partial y^2} \Big|_{y=0,b} = 0, w \Big|_{t=0} = 0, \frac{\partial w}{\partial t} \Big|_{t=0} = 0. \quad (25)$$

We assume the following initial data  $a=b=20$ . The rest of the data is taken from the previous example [8, 9]. Substituting (24) in (21), we obtain solutions to equation (1) in the form

$$w_3(f) = \sin \frac{\pi}{a} x \sin \frac{\pi}{b} y \sum_{k=0}^{\infty} - \left[ \left( b_0 \left( \frac{\pi}{a} \right)^4 + b_1 \left( \frac{\pi}{a} \right)^2 \left( \frac{\pi}{b} \right)^2 + b_2 \left( \frac{\pi}{b} \right)^4 \right)^k \left( \frac{1}{\omega^2} \right)^{k+1} \times \right. \\ \left. \times \left( \cos \omega t + \sum_{i=0}^k (-1)^{i+1} \frac{\omega^{2i} t^{2i}}{(2i)!} \right) \right] \quad (26)$$

Solutions (26) satisfy (1) and initial boundary conditions (25). According to the formula (26), graphs are plotted (Fig. 1) of the oscillations of the central point of the plate from the impact (24). Figure 2 shows graphs of changes in the shape of the oscillation over time ( $t=0.2$  s,  $0.4$  s,  $0.5$  s) in the cross section  $x=10$  cm.

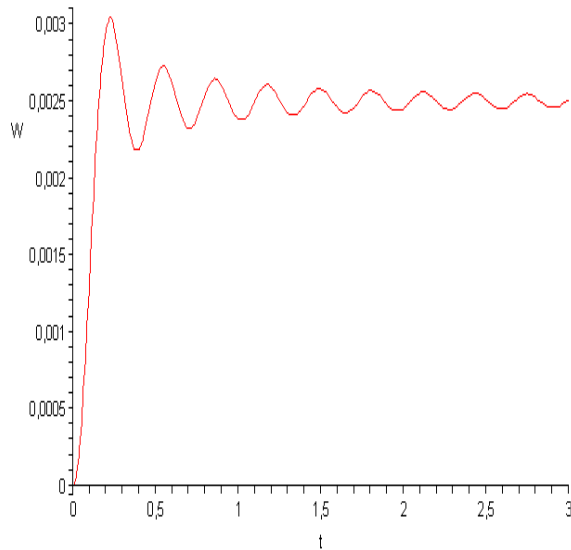

Fig 1

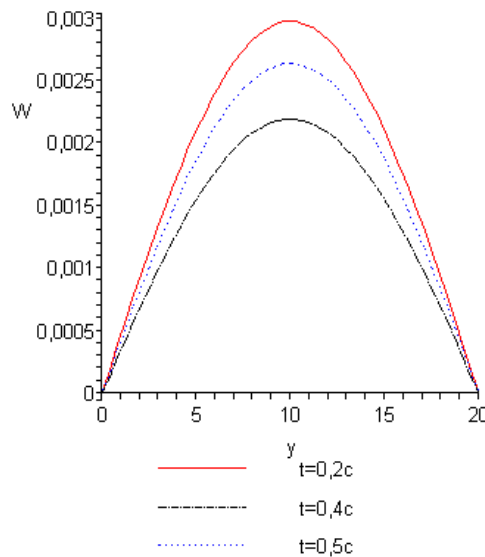
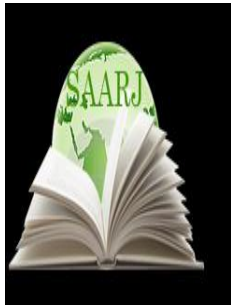

Fig 2

## REFERENCE

1. Ваченко А.С., Шалумов А.С. Моделирование механических процессов в блоках радиоэлектронных средств на основе метода взаимодействия «Проектировщик-система». Сетевой электронный научный журнал «Системотехника» №1, 2003.

2. Маквецов Е. Н., Тартаковский А.М. Дискретные модели приборов. М.Машиностроение .1982,136 с.
3. Амбарцумян С.А. Теория анизотропных пластин. М., 1967.
4. Амбарцумян С.А. Дургарьян С.М. Некоторые нестационарные температурные задачи для ортотропных пластин. АН СССР ОТН. «Механика и машиностроение» №3. 1962.
5. Лехницкий С.Г. Анизотропные пластины. М.1957.
6. Спиваков Ю.Л. Специальные классы решений линейных дифференциальных уравнений и их приложения к анизотропной и неоднородной теории упругости. Ташкент, Фан,1986, 186 с.
7. Фролов В.Н. Специальные классы функций в анизотропной теории упругости. Ташкент, Фан, 1981.-224 с.
8. Абжалилов С.Х. К моделированию механических колебаний ортотропных плат в радиоэлектронных устройствах. Узбекский журнал Проблемы информатики и энергетики, №1, 2006, г. Ташкент, изд. «ФАН» АНРУз, с. 95-100.
9. Ashurova D.N., QodirovaSh.T.. Some are about an innovative way to calculate function class limits. Илм сарчашмалари. №4, 2020. -P. 11-14 (in Uzbek).



DOI: **10.5958/2249-7137.2021.01262.3**

## POSITIVE ASPECTS OF INTERACTIVE LEARNING METHODS

M. SH. Fayziev\*; S.S.Jumaev\*; Majidov Sh.A\*\*; Sadikova D.A\*\*

\*Senior Teachers,  
Navoi State Pedagogical Institute,  
UZBEKISTAN

\*\*Teachers,  
Navoi State Pedagogical Institute,  
UZBEKISTAN

### ABSTRACT

*This article reveals some aspects of the development of students' creative potential, which is one of the main factors in the quality of education. One of these goals is to create a comfortable learning environment, that is, the conditions under which the student feels his success, his intellectual competence, which makes the learning process itself productive. The joint activity of students in the process of learning, mastering the educational material means that everyone makes their own special individual contribution to this process, that there is an exchange of knowledge, ideas, and ways of activity.*

**KEYWORDS:** *Interactive learning, interactive activities, cooperative learning, basic concepts of first-order differential equations.*

### INTRODUCTION

*Interactive training* – this is learning, immersed in communication. However, "submerged" does not mean "substituted". Interactive learning preserves the ultimate goal and the main content of the educational process. It modifies the forms from broadcasting to dialogical, i.e., including the exchange of information based on mutual understanding and interaction.

Interactive learning has very specific and predictable goals. One of these goals is to create a comfortable learning environment, that is, the conditions under which the student feels his success, his intellectual competence, which makes the learning process itself productive. The essence of interactive learning is to organize the learning process in such a way that almost all

students are involved in the process of learning, they have the opportunity to understand and reflect on what they know and think.

Interactive learning simultaneously solves several tasks:

- develops communication skills, helps to establish emotional contacts between students;
- solves the information problem, since it provides students with the necessary information, without which it is impossible to implement joint activities;
- develops general learning skills (analysis, synthesis, goal setting), that is, provides the solution of learning tasks;
- provides an educational task, as it teaches you to work in a team, to listen to other people's opinions.
- creates relaxation of the participants of the educational process, relieves nervous stress, switches attention, changes the forms of activity.

The use of interactive teaching methods in the work gives

**to the student:**

- \* development of personal reflection;
- \* awareness of involvement in the overall work;
- \* formation of an active subject position in educational activities;
- \* develop communication skills;
- \* adoption of moral norms and rules of joint activity;
- \* increased cognitive activity

**group:**

- \* formation of a group as a group community;
- \* increase cognitive interest;
- \* development of skills of analysis and introspection in the process of group reflection;

**to the teacher:**

- \* Non-standard attitude to the organization of the educational process;
- \* Formation of motivational readiness for interpersonal interaction not only in educational, but also in other situations.

The joint activity of students in the process of learning, mastering the educational material means that everyone makes their own special individual contribution to this process, that there is an exchange of knowledge, ideas, and ways of activity. And this happens in an atmosphere of goodwill and mutual support, which allows not only gaining new knowledge, but also develops the cognitive activity itself, translates it to higher forms of cooperation and cooperation.

Very often, teachers use various teaching methods, such as direct learning, research, and modeling. Each of these methods has advantages and disadvantages. Research makes learning

active, modeling interactive. A new level of interactivity is inherent in cooperative learning [1-4].

Cooperative learning is a way of working in small groups, where students themselves are responsible for the educational process. The essence of this method: "Everyone achieves their learning goals only if the other members of the group achieve their own."

Co-education has many variations. One approach is "competing teams". First, the teacher explains the material, which the students then work with in groups to consolidate. Control is carried out by writing each control work. The current score is calculated by group and compared over time. The winner with the highest total of individual points is awarded. Another approach is "teams-tournament". The initial stage is exactly the same as in the first case. However, the test paper is replaced by a tournament, where team members compete against each other to earn the most points for their group. The third approach is a "picture-mosaic", when a whole canvas is made up of individual pieces.

Traditionally, in universities, seminars begin with listening to students' reports, discussing the presented and studied material, and then discussing educational issues with a further assessment of the quality of the material learned on the topic. For example, the topic of the course of mathematical analysis "First-order differential equations" is studied by the traditional method of teaching. First, as a rule, there is a survey on the material passed, then listening to reports, for example, problems that lead to the concept of "differential equation»; the Cauchy problem on the existence and uniqueness of the solution of a first-order differential equation; the geometric meaning of the equation and its solution.

Then the training questions on the topic are analyzed:

1. General definition of a differential equation.
2. First-order differential equation (ordinary).
3. What does it mean to solve a differential equation?

The difference between the general and particular solutions of the equation.

4. The main essence of the Cauchy problem of solving a differential equation.
5. Geometric interpretation of the differential equation itself and its solutions.
6. The first skills of composing a differential equation based on the data of a certain problem.

The result at the end is that the two-hour lesson turns into a two-hour survey of students with a subsequent assessment of knowledge.

An interactive practical lesson on the same topic, for example, using the "teams-tournament" technique, will allow students to better remember and assimilate the proposed educational material.

The text for such a lesson is prepared in advance and divided by the teacher into several semantic parts. In this case, the topic is divided into three parts: general concepts and definitions of the differential equation and its elements, general concepts, definitions of the theorem on the first-order differential equation and the composition of the differential equation of the first equation. Depending on the number of semantic parts, the number of students in a small group is



determined. The maximum variation can be up to 6 parts. Let's assume that the text is divided into 3 parts. Let's imagine the stages of conducting a class through a tournament.

1. First, the participants are divided into small groups of 4 people. The training group of 15 people includes 4 small groups. Each student of the small group was assigned an ordinal number (from one to four).

2. Students, having received their part of the text, work with it for 15 minutes. If necessary, the teacher comes to the rescue. The fourth group - "experts" from among students who evaluate the answers of their friends on a ten-point system. Two criteria are evaluated - the complete answer and the answer to the questions asked by the experts.

3. The teacher, at the end of the lesson, conducts a summary, based on a table that is provided to him by a group of "experts". The results of the lesson are summed up.

Currently, more than 50% of the time provided for in the curricula of training specialists at the university is devoted to independent work, as one of the main factors in the development of the creative potential of students. In these conditions, it is very important to monitor its progress, so that this work, first, is carried out in a timely manner, and secondly, it is effective, that is, it allows you to achieve your goals. There are several areas, each of which requires its own control system:

- ✓ Independent preparation of students for each practical lesson or laboratory work, during which the study of lecture material, educational literature recommended by the teacher is required.
- ✓ Control is carried out in the form of a current cross-section of students' knowledge, writing small (for 10-15 minutes) control papers or test tasks;

One of the weaknesses in the training of specialists is the inability of students to use the information obtained in lectures and practical classes to solve specific problems.

In order to improve the quality of knowledge and eliminate this shortcoming, it is necessary to develop a system of individual tasks that also allow you to exclude cheating when registering and submitting ratings.

The ability of students to improve themselves independently, to gain knowledge is important, because modern society and production need employees and managers who are able to think quickly and correctly solve specific problems that arise, conduct a dialogue with colleagues and partners, and make decisions independently. Therefore, it is necessary to use technologies related to modern requirements in the classroom.

This one of the interactive methods is "*project technology*". The essence and idea of it is to organize independent, creative, search activities of students.

The "technology of projects" is based on the idea of the orientation of the student's educational and cognitive activity on the result that is obtained when finding a solution to a particular practical or theoretical problem. The external result can be understood, applied, and seen in real practical activity.

The internal result – the experience of activity-becomes the property of the student, combining all the knowledge and skills, competencies and values.

The project method in the learning process allows us to develop educational skills, the student's communication potential, solve information problems, organize the interaction of all participants in the educational process, and activate the students' mental activity. Their creative activity is the creation or discovery of something previously unknown to this student.

The work on the research project is carried out under the guidance of a teacher, but his role is to organize and adjust the independent activities of students.

Project activities of students can give the best results in the development of the student's creative potential. Preparation for a serious student activity begins with the very first year of study.

We offer an example of a project work on the subject "Mathematical analysis". Project topic: "First-order differential equations, and ways to solve them".

***Project participants:*** students of the 2nd year of the Faculty of Mathematics.

***Project implementation timeline:*** 2 months.

***Result:*** defending projects, and then helping fellow students who have difficulties with this training material. Tasks for groups (each group has 4-5 people):

**Task for group 1.**

1. Collection of information on the topic "First-order differential equations (general concepts). Equations with separated and separable variables of the first order", methods and methods of their solution" (using materials from textbooks and textbooks on mathematical analysis, reference books, the Internet).
2. Selection of 25-30 equations on this topic; explanations with solutions.
3. Making a report on the work done: theory + practical tasks.
4. Project protection. (Presentation), ("paper" version).

**Task for group 2.**

1. Collection of information on the topic "Homogeneous equations, linear equations", "Equations reduced to homogeneous ones and methods for their solution". (Use of materials from textbooks and textbooks on mathematical analysis, reference books, and the Internet).
2. Selection of 25-30 equations on this topic (together with the solution).
3. Making a report on the work done: theory + practical tasks.
4. Project protection. (Presentation), ("paper" version).

**Task for group 3.**

1. Collection of information on the topic "Differential equations in full differentials". Methods and methods of their solutions. (Use of materials from textbooks and textbooks on mathematical analysis, reference books, and the Internet).
  2. Selection of 25-30 equations on this topic (together with the solution).
  3. Making a report on the work done: theory + practical tasks.
  4. Project protection. (Presentation), ("paper" version).
-

**Task for group 4.**

1. Collection of information on the topic "First-order differential equations not resolved with respect to the derivative". The Lagrange, Celera, and Riccati equations and their solutions. (use of materials from textbooks and textbooks on mathematical analysis, reference books, and the Internet).
2. Selection of 25-30 equations on this topic (together with the solution).
3. Making a report on the work done: theory + practical tasks.
4. Project protection. (Presentation), ("paper" version).

**REFERENCE**

1. Юцявичене П.А. Принципы модульного обучения / Советская педагогика. 1990. – № 1. – С. 55-60.
2. Давыдов В. В. Проблемы развивающего обучения. М.: Педагогика, 1986.
3. Давыдов В. В. Теория развивающего обучения. -М.:ИНТОР, 1996- 544с.
4. Ксезонова Г.Ю. Перспективные школьные технологии: учебно-методическое пособие. М.: Педагогическое общество России, 2000. 224 с

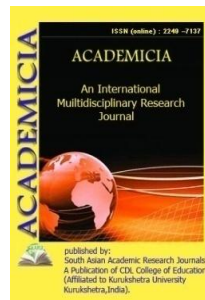

DOI: **10.5958/2249-7137.2021.01256.8**

## IMPROVING SEED STORAGE METHODS

Mirzaeva Mutabar Azamovna\*; Xolmatov Sohijjon Normatjon ogli\*\*

\*Associate Professor,  
Candidate of Agriculture Sciences,  
Fergana Polytechnic Institute, Fergana,  
UZBEKISTAN

\*\*Master's degree Student,  
Fergana Polytechnic Institute, Fergana,  
UZBEKISTAN

### ABSTRACT

*Methods of storage of seeds of harvested cotton seeds improving and improving the quality of stored cotton. Pay attention to the fact that it is stored indoors in order to maintain its fertility giving, as well as ensuring quality storage of seeds. This way the biggest drawback of based devices is the bottom of the camera Along with heavy mixtures of cotton also fall remains. To eliminate this, at the bottom of the camera in experiments the need to reduce the size of the pocket quality seeds as a result of its detection and elimination was found to be conservative. Such a situation in turn leads to deterioration in product quality. Increased humidity, extreme temperature drop or rise deterioration of seed quality, its forgetfulness, quantity, it also causes deterioration in fibre quality.*

**KEYWORDS:** *Product Quality, Seeds, Technology, Equipment, Fibre Quality, Temperature, Humidity, Processing, Climatic Conditions, Forgetfulness.*

### INTRODUCTION

Improving the efficiency of cotton harvest in cotton growing, from cotton increase the quantity and quality of cotton products depending on the quality of the seed and the seed being prepared. Improving the quality of seeds by the Uzpakhtasanoat Association in order to create new technology and equipment and clean them with cotton Great importance is attached to the introduction of plants.

## MATERIALS AND METHODS

Based on the above, we have hand-picked cotton to study the improvement of seed storage methods scientific research was conducted for this purpose. Cotton varieties grown in Uzbekistan are fast-ripening, high-yielding, The fibre yield is high, its fibre quality is good, seed oil and protein-rich in substances, resistant to adverse environmental conditions (soil salinity, low temperature, garmsel, drought, etc.) as well as disease and pest resistant, agrotechnical measures efficient use of row spacing adapted to mechanization, machine harvesting and other valuable farm characters and characteristics are required [1-3]. The quality of the seeds sown next year in cotton the timing of their collection in the field. Which is the harvest season level of organization, preparation for storage processes and planting to what extent the work is carried out in accordance with the requirements of the State Standard depending on the destination. Quality of cotton products in cotton mills many scientists, their own experiences as well as on further improvement has been making a huge contribution to the news. Develop these innovations there are enough opportunities by our state to introduce the issue being created. As a result, almost all of our country today cotton gins have been transferred to a cluster system and modernized again equipment is provided. This year our country in the regions of cotton 15 early ripening, 5 medium ripening, 8 promising it is planned to sow the seeds of varieties. This in turn is the sowing of seeds 55.0% of the planned total area, 30.0% medium-ripe, promising 6.5 per cent and new varieties 8.5 per cent means placed. Varieties are adaptable to environmental changes, including resistance to soil moisture deficiency, salinity and agrofon should contribute to the improvement. Distinguished by the quality of the fibre and high productivity The "Sultan" cotton variety is different in its adaptability to environmental changes. In the current year, this variety is higher than the varieties Republic of Karakalpakstan, Andijan, Samarkand, Surkhandarya, Tashkent and 20-50 per cent in the Syrdarya region. Cotton growers in Andijan, Namangan and Fergana regions produce 60-70% of cotton "Andijan-35", "Andijan-36", "Andijan-37", "Namangan-77", S-High-yielding varieties such as 8290, S-6524 are planned to be planted. Type IV fibre, which is distinguished by the quality of fibre in the cotton market Given that the demand for the S-6524 navigator is increasing, the current variety is grown in Jizzakh, Namangan, Sirdarya, Tashkent, Fergana planting in 15-35% of the cotton-growing areas of the regions intended. Jizzakh, Syrdarya and Navoi regions are also affected by 20-30 cotton fields of durable, fast-ripening variety "An-Boyovut-2" per cent, which is also abundant in the soil-climatic conditions of this region allows you to harvest [4-6]. Cotton selection, industry varieties and classes on the top is covered with a tarpaulin on special open areas stored in a special order in cages and covered warehouses. Seeds open areas for storing cotton 40 cm from the ground. Their high surface 25x14 m. or 22x11 m. will be. 150-400t for such open areas. Seed cotton can be stored up too. Overall dimensions of closed warehouses where seed cotton is stored 54x18x8 m. ; 54x24x8 m. their capacity is 600x750 t. and reinforced concrete should be assembled from pieces (blocks) or built of baked brick. Shelters from four-sided open sheds can also be used. Djaborov G. D., Baltaboev S.D. to the results of a research according to, with a change in the quality of the processed seed cotton the fibre residue of the seed also changes. To do this, it is cleaned of fibre the seeds flow over the vibrating net. Require a mesh hole The cleaned seeds fall to the level of. The fibre residue was 0.12-0.19% and seeds with a moisture content of 12% remain on the net for re-cleaning. It can be seen that well-dried seeds go into the sorting process has a negative effect. When storing seed cotton and seeds in cotton mills complex physiological-biochemical processes occur. In doing so, not only storage but also quality

improvement will be required. Khodjiev M.T., Tadjiev U.S., Mubarakov A.Ya. (1999) cotton processing plants and The cotton received from the farms in the settlements is different methods and conditions. Cotton in bunts, a variety of winter in the barns and warehouses under the covered shed a certain degree of moisture when stored in humid conditions attracts. In this case, the humid environment is exposed to cotton fibre and seeds (especially seeds) may be adversely affected. Such a situation in turn leads to deterioration in product quality. Increased humidity, extreme temperature drop or rise deterioration of seed quality, its forgetfulness, quantity, it also causes deterioration in fibre quality. Especially although the seeds need to be stored in closed warehouses, so second and third-generation due to lack of warehouses seed cotton and seeds are also stored in piles [5-7]. We know that Uzbekistan is not only in the world cotton industry weighted not only in quantity but also in fibre quality takes place. Climatic conditions in Uzbekistan are variable given that it has the property of collecting from the fields. The extracted cotton is stored in different conditions of autumn weather. This is due to the difference in the quality of cotton products received leads to Mannopov A., Boronov H. (2001) noted that the cotton ginning industry is the last stage in the Republican cotton complex is calculated. Therefore, improving the quality of work in the industry is mainly to organize his work with 5-2 modern tools depends on the equipment. After processing the prepared cotton and seeds dehydrated or a small amount of hair is left. They are such seeds that are shed in pots and stored at low pressure while exposed to a variety of natural conditions. The moisture content of cotton during storage and depends on it the effect of the temperature on the quality of the seed and fibre is one way or another important in terms of. If the temperature in the bath rises, a state of self-healing occurs, resulting in respiration of the seed accelerates, which is from the duration of the available energy reserve in the seed leads to pre-consumption. With the increase of machine harvesting in seed cotton the moisture and dirtiness of the cotton increases. Such a situation is clearing leading to increased drying and cleaning operations in factories. Iksanov MI, Egamberdiev A., Khalmanov B., for information first grade cotton with a moisture content of up to 11% and a moisture content of up to 13% The naturalness of fibre and seeds in the storage of low-grade cotton even if no measures are taken to preserve its properties. However, in practice, there are cases when the humidity is too high the upper bouts featured two cutaways, for easier access to the higher frets. In this case, some of the garam spontaneous heating of cotton occurs in places. Therefore 1-11 varieties with humidity up to 11%, low humidity up to 13 % opening tunnels and warm air during long-term storage of varietal cotton mentioned the expediency of removal. Mirahmedov S. M. et al (1989) of seed germination the humidity is of great practical and economic importance. In high humidity, the germination of existing seeds decreases and rots during storage. Seed production should not exceed 10% in Central Asia. Moisture, germination and other quality of seeds are divided into three classes depending on the indicators: first-class seed germination at least 95%, second grade-90%, the third class should be 85%. Fertility for planting was less than 85% mentioned that the seeds are considered invalid. Data obtained from observations showed that as the shelf life of the seed increases and as a result of heating, the protein in it also decreases to a certain extent observed, the amount of protein in the annual seeds averaged 2-3% decreased, in biennial seeds this figure is 5% found to have done. However, the total protease activity of the enzyme is slightly dependent on the shelf life of the seed activation was also detected. Stored for year seeds, germination and growth relative to 2-3-year-old seeds proves that it has a high energy index found Cleaning of heavy mixtures in cotton gins the devices are mounted on the horizontal side of the pneumatic transport is set to the side. In doing

so, lift the cotton in a vertical direction that is heavier than the speed of the air it can move allows the mixtures to separate. This way the biggest drawback of based devices is the bottom of the camera. Along with heavy mixtures of cotton also fall remains. To eliminate this, at the bottom of the camera in experiments the need to reduce the size of the pocket quality seeds as a result of its detection and elimination was found to be conservative. Fibre-separated seeds in ginning plants the products are collected in tanks and stored for 1-4 months. Save during the period, the temperature is basically the same. Seeds before firing and then 96 % with sulfuric acid depleted. Up to 30% of seeds to the required size in accordance with GOST requirements those who do not have them are sent to oil companies. Cotton removable fibre, lint and fibrous waste bales in sheds stacked on top of each other, if there are no special sheds, weddings the bottom is covered with wood, the top is covered with tarpaulin stored.

### CONCLUSION

According to the results of experiments, in the closed state, 3.7-4.1% of the stored cotton fiber is stored in the open state.

### REFERENCES

1. P.P.Posypanov, & at all. (1997). Rasteniievodstvo.M.Kolos.
2. K.Atabaeva., O.Qodirhojaev. Botany. (2006). New Century Generation. T.
3. ET Shaykhov, & at all. (1990). Cotton growing. T. Mehnat.
4. Azamovna, M. M., Shuhratjon O'g'li, A. S., & Nuritdinovna, A. D. (2020). Biology Of Sugar Beet, As Well As The Scientific Basis For The Cultivation Of Ecologically Pure Products. *The American Journal of Agriculture and Biomedical Engineering*, 2(11), 7-10.
5. Хасанов, А., Акрамов, Ш., Абдурахмонов, С., & Камолов, З. (2018). Разработка технологии получения ранних овощей без применения искусственного обогрева. *Современные научные исследования и разработки*, 1(4), 542-543.
6. Shodmonov, X., & Akramov, S. (2018). Sugar-beet is the most valuable technical plant. *Scientific journal of the Fergana State University*, 1(2), 94-96.



**ACADEMICIA**  
**An International**  
**Multidisciplinary**  
**Research Journal**  
 (Double Blind Refereed & Peer Reviewed Journal)

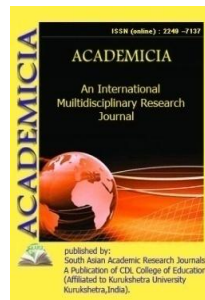

**DOI: 10.5958/2249-7137.2021.01257.X**

## THE REFLECTION OF MIGRATION PROCESSES IN THE FUNERAL RITES OF THE POPULATION OF ANCIENT USTRUSHANA

**Toshboev Furqat Eshboevich\***; **Ropiev Allayor Saydullaevich\*\***;  
**Jumaev Jo'rabek Boboqul oqli\*\***

\*PhD, Associate Professor,  
 Jizzakh State Pedagogical Institute,  
 Jizzakh, UZBEKISTAN

\*\*Teachers of Jizzakh State Pedagogical Institute,  
 Jizzakh, UZBEKISTAN  
 Email id: furqat7312@mail.ru

### ABSTRACT

*In this article, the authors have tried to determine the influence of tribes such as the Sarmatians, Yue-chji, Hun, Usun, who came from the Eurasian steppes in ancient times, by analyzing the burials in the Ustrushona tombs. It is also noted that the formation of the "Qovunchi" (Melon) culture and its ethnic basis was greatly influenced by the tribes that entered during this period.*

**KEYWORDS:** *Ustrushona, Sopollitepa, Gulbo, Sagonak, Lavender, Volga, Munchoktepa, Sarmatian Tribes, Yue-Chji, Kenkul, "Qovunchitepa", "Qovunchi" Culture, "Jetiasar" Culture.*

### INTRODUCTION

During the years of independence, large-scale archaeological research in the country has allowed collecting new information about the material and spiritual culture of the ancient population, its way of life, household items, traditional economy, etc. Of particular importance in these studies is the study of ancient burial structures and ceremonies in them.

According to the ideas of the ancients, breath, spirit, and shadow were related concepts that formed the basis of animism. Based on this notion, the idea of "living in the world" after the death of people is widespread among the herdsmen of Ustrushna. Therefore, many rituals were performed at the funeral, and "all the conveniences" were created in the tomb. Funeral rites become rituals formed over time, and they are mainly divided into rituals performed before, during, and after burial [Alyokshin, 1986. p.6]. This is reflected in the open burial mounds, the burial of household items, clothing, weapons, ornaments used in the life of the deceased, and the



placement of various foods in containers for his consumption in the world and their convenient placement in the cellar.

Accordingly, the funeral consists of several interrelated religious-spiritual processes. According to B.H. Matboboev, each of them organizes various ceremonies performed by his relatives to observe the deceased in the "other world". This process is long and involves the installation of a sign (monument) on the grave of a seriously ill patient, starting before his death, burying him after his death, and subsequent rituals "[Matboboev, 2006. P.156]. The most important of these is the ritual of burying (burying) a person after his death (digging a grave, bringing the deceased to the grave, burial, etc.). The funeral reflects the originality of the ideological views before the burial, the religious mythological system, the rites of burial and remembrance. Burial and burial beliefs include (J), burial and remembrance traditions (GD), and tombstone (E).

They, in turn, reflect the ideological scope of the funeral rites, the semantic (meaning) level, the stages of the process, the practical scope of the burial, the ideological scope of the funeral, and the practical manifestations of remembrance, uniting grave complexes and grave groups. Together, they form the tombstone (E1), which is an archaeological object [Olkhovsky, 1986. p.67].

From the above descriptions, it can be concluded that funerals contain the most ancient archaeological and ethnographic sources of mankind and it is difficult to bring them into a single system.

## **MATERIALS AND METHODS**

In all the graves in the Ustrushona cemetery, the deceased were buried in the grave individually or in pairs, sometimes in groups. The corpses were buried mostly lying down and folded. Funerals take different forms, and we want to begin the description with which side of the head of the deceased is placed. At the Gulbo cemetery in Ustrushna, it is common to place the heads of the dead to the north and south. On the right, in the north and south directions, in the Kulpisar and Karatash cemeteries, the head of the deceased is buried to the north, and in the Bekkeldi cemetery to the south.

Hence, in the burial traditions of the ancient inhabitants of Ustrushna, the burial of the dead was common in the south and north directions. South-facing burials of corpses found in the Ustrushan cemeteries have been reported in many other areas. In particular, Kuyimazor, Lavender, Oqjartepa of the II-I centuries BC [Obelchenko, 1956. P.119-220], Achamoyli near Tashkent, Usta Mullo and Langari Khojiyon studied in Isfara district, as well as in the III-I centuries BC in South Kazakhstan. The heads of the bodies were buried in the southern direction in the burial mounds around the roof, as well as in the Ural, Volga and Caucasus regions, which date back to BC. The structure of the tomb also seems to have played an important role in which direction the corpses were to be placed.

For example, in the tombs of the Oqjartepa cemetery in Sughd, the heads of the corpses were buried facing south, and in the tombs of Lhadli, facing east. O.V.Obelchenko notes that burials in the southern direction are more often observed in BC tombs [Obelchenko, 1992. p. 144].

M.I. Filanovich's custom of turning the head of the deceased to the south is "connected with the newly arrived peoples" [Filanovich, 2010. p. 85]. These ideas are also consistent with the periodicity of the material sources studied in the tombs. But there are other opinions on the

matter. According to B.H. Matboboev Munchoktepa, "it was not customary to place the dead in a strict direction at the funeral. The side of the head with the head of the deceased did not matter to the ancient population, because the burial structure itself is oriented, " he concluded. The material of the ancient period shows a very broad essence of the properties associated with the parties. For example, the warlike Turkic tribes in western China, the Rung-DI, and the DI in the north, according to Chinese sources, called themselves the Great DI, the Red DI, the White DI, and the Northern DI. Si Machyan, 1989. b. 28].

This means that the custom of the Turkic peoples to mark the sides with colour began 3,000 years ago with the DIs. To the east, those who lived on the east side of the sun were glorified and called "dust DI" (great, great DI). It seems that these Turkic peoples glorified the colour blue and called it "great" [Aytbaev, 2004. B. 25]. Because of the light in the south, those in the south are called "chi DI" (red DI) and those in the west are called "bay DI" (white DI). Only for some reason, the northerners were called "northern DI" instead of "black DI". Based on this information, we can say that in Ustrushna it meant a certain way to put the head of the deceased. Burial in the southern direction is also common in the burial customs of the Scythian and Sarmatian tribes. Scholars have found that this later became popular instead of burial in the northern direction [Grakov, 1947. p.143].

Hence, burial in the southern direction, observed in the tombs of Ustrushna, was more dependent on the newly arrived peoples. Although the southern direction was common in Central Asia in the III-I centuries BC, burial in the northern and eastern directions was also studied. According to archaeological data, the Yue-chji had a family grave or a cemetery belonging to a generation, and it was customary to bury the heads of the dead with skins facing north. The burial in the northern direction mentioned in Gulbo and the fact that the objects placed next to the body are very close to the Yue-chji culture further enhances our assumptions that they belong to the Yue-chji.

Our view is further enriched by the view that political power in Fergana was in the hands of the great Yue-chji in the second half of the first century BC [Anarboev, 2017. p. 66].

O.V. Obelchenko's research revealed that burials in the southern direction were more common in the burial mounds of the 1st and 1st centuries BC, but from the 1st century AD burials in this direction decreased [Obelchenko, 1992. p.144].

Analyzes show that south-facing burials are common in Central Asia in the 3rd-1st centuries BC, especially in tombs dating back to the 1st century BC. The burial of corpses in the eastern direction, as in Shirinsoy, is predominant. This situation is also observed in the tombs of Pskent, Kenkol, Borkorbaz, Khaniz, Kalandarkhana, which date back to the II-IV centuries AD [Obelchenko, 1962. p. 66].

Catacombs such as Shoshtepa, Yangi Yol, Qovunchitepa, Vrevskiy, Tuyaboguz, Achamoyli in the Tashkent oasis are buried in the east, north-east, south-east, north and south directions.

The heads of the dead were buried mainly in the northern and eastern directions in the graves and porches of the burial mounds in the Fergana Valley, such as Borkorbaz, Karabulak, Jangail, Gormiron, Isfara [Sorokin, 1954. p.134-141]. In general, burials in the northern and eastern directions are common in the "Melon" cemeteries in the neighbouring Tashkent oasis. Even in the I-VII centuries AD, the head of the corpses was buried in the northern and eastern directions.

Burial in the eastern direction was especially widespread among the Turks, and it also meant the worship of the sun (towards the rising of the sun). In our country, after the Arabs, only western burials have survived. Apparently, in the Ustrushona cemetery, before the Arab invasion, there was no single order in which direction the heads of the dead should be turned. It can be said that such cases were related to natural phenomena, seasons - the time of the deceased's death, the relief of the place (mountains), etc., rather than some religious ideas. In the Uchtepa cemetery in Ustrushna, the body was buried in a special coffin. The burial of the deceased in a coffin is considered local. This is because the tombs of the Sopollitepa monument of the Bronze Age in southern Uzbekistan contain the oldest wooden coffins in Central Asia [Askarov, 1977. p.40-41.].

In the Borkorbaz, Karabulak, Jangail, Gormiron, Isfara cemeteries of the first half of the 1st millennium AD in the Fergana Valley, corpses were laid individually, sometimes in pairs or groups, on wooden coffins (grob) and reed beds, with their backs to the body. Sorokin, 1954. p.134 -141].

Significantly, wooden coffins are found at the same time in the catacombs and terraced tombs of the first half of the first millennium AD in the Fergana Valley. The burial of the dead in such coffins is common in the burial ceremonies of the peoples of Central Asia. One of the catacomb tombs studied in the Kenkol Valley by A.N. Bernstam also mentions a wooden grob made of spruce. However, unlike the Uchtepa cemetery, this tomb is rich in burial objects. Along with the body of the corpse, there is a silk shirt, leather trousers and shoes (shoes), and next to it there are three-sided bow arrows made of ceramic jugs, iron and bone [Bernstam., Kenkolsky, 1940. p. 29].

In Shirinsay and Gulbo cemeteries, there is a special "bed" of pillows under the heads of some corpses. Such a "pillow" under the head of the body has been used since the Bronze Age [Matboboev, 2006. p.156].

The custom of putting a pillow under the head of the deceased is one of the signs of confidence that they will live in the "beyond" world. They tried to make the deceased as comfortable as possible in order to pass into this world. Hence, the convenient placement of the head of the deceased was also one of the conveniences made for the world beyond the deceased. The burial of the dead in Ustrushona cemeteries, individually or in pairs, on their backs, in an elongated or folded position, is no different from other parts of Central Asia. In the Sughd cemeteries, the bodies were buried more in the 1st group in the northern direction, in the 2nd group in the southern direction, and in the 3rd group mainly in the northern and eastern directions. There are cases of fire worship at the burial of corpses, traces of ingumation, the shape and patterns of pottery, the anthropological structure of the deceased [Pardaev., Toshboev, 2007, p. 54-58], as well as the structure of the tombs in the monuments "Melon-1" and the position of the body, laying a bed under them, such features as in the Ustrushona cemetery. Although it is common to bury corpses in all the cemeteries in Ustrushan, mainly by laying them on the ground, the corpses are buried in reeds or wooden beds (in Gulbo 2, 3 tombs) or in reed wrappers (baskets) (Gulbo 5 tombs). B.Kh. Matboboev, who studied the first medieval Munchoktepa cemeteries in the Fergana Valley, noted that "the dead were buried in three ways in the Sagans of Munchoktepa cemeteries: burial on the ground and on a special bed; burying the body in a basket; to bury in a coffin". Two comparisons emerge from this comparison, the first being the similarity of burial ceremonies in the Ettisuv, Fergana, and Ustrushna regions, and the second the fact that burial

customs in antiquity were somewhat polished even in the early Middle Ages. Reeds and underground sags, which were buried under the corpses at the time of burial, entered Northern Fergana under the influence of the Melon and Jetiasar cultures. Such sags are similar to the sags found and studied in Chach, Ustrushona, Aral Sea.

## CONCLUSION

Thus, in concluding on burial ceremonies, burials in the southern and northern directions observed in the tombs of Ustrushona were associated with ancient and early medieval migratory processes, and it was more associated with newly arrived peoples. The collected anthropological data also show that the last quarter of the 1st millennium BC and the beginning of our era were a period of intense tribal movement in Ustrushana.

## REFERENCES:

1. Алёкшин, В. А. (1986). *Социальная структура и погребальный обряд древнеземледельческих обществ: по археологическим материалам Средней Азии и Ближнего Востока*. Изд-во "Наука," Ленинградское отд-ние.
2. Аскарлов, А. А. (1977). *Древнеземледельческая культура эпохи бронзы юга Узбекистана*. Izdatel'stvo "Fan" Uzbekskoi SSR.
3. Айтбаев Абдухалиқ Абдурасул ўғли. (2004). Хитой манбаларида туркий халқлар аждоди рунг-дилар. «Ўзбек халқининг келиб чиқиши: Илмий методологик ёндашувлар, этногенетик ва этник тарих» мавзусидаги республика илмий- назарий семинар материаллари. Тошкент.
4. Анарбоев А.А. (2017). Фарғонанинг антик ва ўрта асрлар даври шаҳар маданияти. Маъруза шаклидаги докторлик диссертацияси. Тошкент.
5. Бернштам, А. Н. (1940). Кенкольский могильник//Археологические экспедиции Государственного Эрмитажа. Вып. II. Л.: Изд-во Ленингр. Эрмитажа.
6. Граков, Б. Н. (1947). Γυναικόκρατοῦμεῖοι. Пережитки матриархата у сарматов. ВДИ, (3), 100.
7. Матбобоев Б.Х. (2006). Фарғона водийси аҳолисининг илк ўрта асрлар даври диний қарашларини дафн маросимларида акс этиши (Мунчоктепа мисолида).
8. Обельченко, О. В. (1956). Кую-мазарский могильник. Тр. ИИА АН УзССР, (VIII).
9. Обельченко, О. В. (1962). Могильник Акджартепе. *История материальной культуры Узбекистана*, (3), 57.
10. Обельченко, О. В. (1992). *Культура античного Согда: По археол. данным VII в. до н. э.-VII в. н. э.* Наука.
11. Ольховский, В. С. (1986). Погребально-поминальная обрядность в системе взаимосвязанных понятий. *Советская археология*, (1), 65-76.
12. Пардаев М.Х., Тошбоев Ф.Э. (2007). Сўғд цивилизацияси тизимида кўчманчи чорвадор халқларининг ўрни. Самарқанд шаҳрининг умумбашарий маданий тараққиёт тарихида туган ўрни: Самарқанд шаҳрининг 2750 йиллигига бағишланган халқаро конференция материаллари. Тошкент, Самарқанд: Фан.

13. Сорокин, С. С. (1954). Некоторые вопросы происхождения керамики катакомбных могил Ферганы. *СА*, 20, 131-147.
14. Si Machuan. (1989). Historical memories. Urumqi.
15. Филанович М.М. (2010). Древняя и средневековая история Ташкента в археологических источниках. Ташкент: Узбекистан.
16. Омонов, А. (2020). The sel-ungur cave and its role in the paleolithic period of central asia. *Збірник наукових праць Логос*, 76-77.
17. Murodovich, O. A. (2021). Monuments and places of the early paleolithic period of uzbekistan. *Збірник наукових праць Логос*.

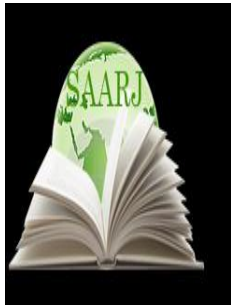

**ACADEMICIA**  
**An International**  
**Multidisciplinary**  
**Research Journal**  
 (Double Blind Refereed & Peer Reviewed Journal)

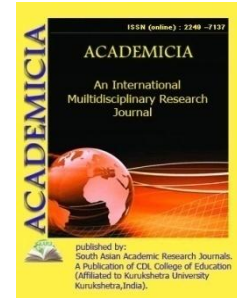

**DOI: 10.5958/2249-7137.2021.01180.0**

## **GENDER EQUALITY AND ITS IMPORTANCE IN UZBEKISTAN AND OTHER COUNTRIES OF THE WORLD**

**Khushbokova Nigora Ghayratqizi\***

\*Law Faculty of Jurisprudence Education,  
 Direction, Termez State University,  
 UZBEKISTAN

### **ABSTRACT**

*Women's rights have a special place in the human rights system, but in some countries women's rights are not fully realized, despite certain universally recognized guarantees. When it comes to women's rights today, it should be noted that in many countries it is a legally balanced category where men and women have equal conditions and opportunities to exercise their rights equally in political, social, cultural and other spheres, regardless of their gender. .*

**KEYWORDS:** *Law, Gender Equality, Convention, Declaration, Democracy, Equality, Legitimacy.*

### **INTRODUCTION**

Women are the successors of human life on earth. As long as they exist, life is lifelong. Human life has a history of many thousands of years, and it has traversed its own path of great progress and development, ascension. In this long and rich history, our women and girls have stood shoulder to shoulder with our men. As an example, we can mention the names of Tomaris, Nodirabegim, Zebiniso, Uvaysiy, Zebo Ganieva, Zulfiyakhanim and many other Uzbek women.

So, what is the attitude to women in our country today? Are their rights equal in all areas?

Unfortunately, today we cannot say that the equality of women and men is fully guaranteed. We can see in the example of the use of social networks that men and women are not equally active. Women and men are more or less equal, on the Internet: 78% of women and 80% of men use the Internet every day. However, older women and less educated women are lagging behind.

In addition, 25% of women aged 55-74 (compared to 21% of men) and 27% of women with low education (21% of men) did not have access to the Internet. Men are more likely to participate in professional networks, download programs, and search for online training materials.

In terms of gender equality indicators, the overall Gender Equality Index for the European Union in 2018 is 67.9 points, indicating the need for urgent development in all member states. Since 2017, scores have increased by only 0.5 points and since 2010 by 4.1 points. At this rate - 1 point every 2 years - it will take more than 60 years to achieve gender equality in the EU.

Today's global progress in the field of gender equality encourages us to look at the positives on this issue as well.

Today, gender equality in Norway is traditionally strong on issues such as the labor market and social state, family and care, health, violence, education and rural development. He is well represented in sciences such as history, literature, sociology, pedagogy, medicine, law, theology, and technology. Speaking of gender equality in India, women in India are thriving in all fields, including politics, business, medicine, sports and agriculture. History has shown that two female scientists from the Indian Space Research Organization conducted the country's Chandrayaan-2 monthly mission from the beginning to the end in 2019. Gender equality has taken another step after the Supreme Court of India increased the government's position towards women serving as army commanders in 2020.

Women were first enlisted in the armed forces in 1992 and have served in many positions, including fighter pilots, doctors, nurses, engineers, signalmen, and more. While the issue of women serving in combat roles has caused controversy around the world, Indian women continue to serve alongside men in the armed forces.

It is known from history that the Uzbek land has always been a country where women are cared for and respected. During the years of independence, a number of measures have been taken to protect the rights and legitimate interests of women, who are an equal part of our society. Article 46 of the Constitution, which is our main encyclopedia, states that "Men and women have equal rights."

As a proof of this, the Presidential Decree "On Amendments to the Decree of the President of the Republic of Uzbekistan dated June 10, 1999" On Support of Proposals for the Establishment of the State Prize named after Zulfiya "(March 29, 2018, No. PF-5389) was adopted. . According to the document, the Zulfiya State Prize is awarded twice a year to representatives of the Republic of Karakalpakstan, regions and the city of Tashkent on the eve of International Women's Day for talented people aged fourteen and not older than thirty. was given to the girls.

In addition, in order to further improve the legal framework for ensuring and protecting women's rights in Uzbekistan, in September 2019, the Law "On Guarantees of Equal Rights and Opportunities for Women and Men" and the Law "On Protection of Women from Oppression and Violence" were adopted. Laws were adopted. The basic principles of guaranteeing equal rights and opportunities for women and men are the rule of law, democracy, equality between women and men, non-discrimination on the basis of sex, openness and transparency.

Universal and universal recognition of women's rights, the Universal Declaration of Human Rights, the International Covenant on Civil and Political Rights, the International Covenant on Economic, Social and Cultural Rights, the Convention on the Elimination of All Forms of Discrimination against Women, The Declaration on the Elimination of Violence against Women, the Convention on the Political Rights of Women, and the European Convention for the Protection of Human Rights and Fundamental Freedoms.

The UN Charter enshrines basic human rights, the dignity and worth of the individual, and the equality of men and women. Indeed, in our country, our women are working effectively in all areas. In this regard, the Chairman of the Senate of the OliyMajlis of the Republic of Uzbekistan, as well as the Chairman of the Cycling Federation of Uzbekistan - TanzilaKamolovnaNorbaeva, the Chairman of the Women's Committee of Uzbekistan - Elmira Basitkhanova, the Minister of Preschool Education - Agrippina Shin, the Deputy Prosecutor General - Svetlana Artikova The hard work of our women, such as Boymirzaevna, is commendable.

On December 5, 1998, at the solemn meeting dedicated to the 6th anniversary of the adoption of our Constitution, our first President I. A. In his speech, Karimov declared 1991 the Year of Women: "Human history testifies that for thousands of years the cultural and spiritual life of every society has been determined by their attitude towards women. We value this value more because we treat women with oriental respect. " Indeed, the upbringing, culture, modesty and modesty of the Oriental women, which have been embodied in our grandmothers and mothers since ancient times, are reflected in our modern Uzbek sisters and mothers.

A country where a wife is happy in the family, a society that grows and prospers so much.

At present, the women of Uzbekistan are considered as equal, creative, active members of society, and their actions to realize their full potential, abilities, dreams and goals are personally supported by the head of our state.

At the first plenary session of the Senate on January 20, 2020, President Sh. Mirziyoyev said he was looking for women for the post of district governor and would try out suitable candidates in practice: "Why? I want to say again and again that our women can be an example to all with a deeper understanding of the problems, dedication, a strong sense of responsibility and diligence, "said the head of state.

The high confidence of the head of our state in women is reflected in the selfless work and responsible activities of our sisters and mothers, who have been working as many district governors.

In addition, the head of state spoke with satisfaction that 48 deputies of the Legislative Chamber of the OliyMajlis of the Republic of Uzbekistan are women.

"I believe that the election of 48 women to this parliament will bring justice, cleanliness, and the most difficult, difficult, delicate issues in the lower, lower, rural, aul, neighborhood, and once again I congratulate our women."

May there be more women in the Uzbek land, where women are consciously aware of their rights and have a legal culture, where their rights are so highly respected and the protection of their rights has risen to the level of state policy.

#### REFERENCES:

1. "Presidential Decree on Amendments to the Decree of the President of the Republic of Uzbekistan dated June 10, 1999" On Support of Proposals for the Establishment of the State Prize named after Zulfiya ". Tashkent, March 29, 2018, PF-5389;
2. The Constitution of the Republic of Uzbekistan. Tashkent - "Uzbekistan" - 2019;
3. "Humanrights". Tashkent. "Justice" -2013.



4. Gender Equality Index 2020 Digitalisation and the future of work. Luxembourg: PublicationsOfficeoftheEuropeanUnion, 2020
5. <https://gender.no/gender-equality> - GENDER in Norway

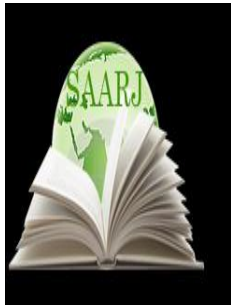

**ACADEMICIA**  
**An International**  
**Multidisciplinary**  
**Research Journal**  
 (Double Blind Refereed & Peer Reviewed Journal)



**DOI: 10.5958/2249-7137.2021.01179.4**

## SCARS ON THE LUNGS: PULMONOLOGIST ON HOW TO PREVENT FIBROSIS AFTER COVID PNEUMONIA

**Anvarzhon Dolimov\***; **Dilfuzahon Mamarasulova\*\***; **Nodirbek Yakubov\*\*\***

\*Doctor of the Andijan branch of the republican specialized,  
 Medical center for emergency care,  
 UZBEKISTAN

\*\*Md, Associate Professor,  
 Head Of The Department Of Oncology and Medical,  
 Radiology, Andijan State Medical Institute, Andijan,  
 UZBEKISTAN

\*\*\*\*Assistant,  
 Department Of Oncology And Medical Radiology,  
 Andijan State Medical Institute, Andijan,  
 UZBEKISTAN

### ABSTRACT

*This article examines the post-Covid state of patients who have undergone COVID-19 who have complications such as post-Covid fibrosis. The article gives recommendations to patients on the rehabilitation of the post-like state in order to fully restore health.*

**KEYWORDS:** *Rehabilitation, Complications*

### INTRODUCTION

Dangers of viral inflammation

They differ from bacterial pneumonia primarily in the prevalence and nature of inflammation. As a rule, these are bilateral poly-segmental pneumonia. The term “covid pneumonia” is even more suitable for the term “viral covid pneumonitis”. Such inflammation in the lungs proceeds differently - with the development of interstitial inflammation (that is, affecting the walls of the alveoli and the connective tissue of the lung. - Ed.) And thrombosis of small pulmonary vessels, the formation of such a complication as pneumo-fibrosis. And it requires longer treatment than bacterial pneumonia, an early start of rehabilitation measures, and their continuation even during

the period of aftercare and recovery.

Against the background of a viral infection, damage to the wall of the pulmonary alveoli, pulmonary interstitium, involved in a gas exchange of small vessels (which causes vasculitis, micro thrombosis). The nature of the inflammation is different than bacterial pneumonia - there the alveoli are filled with liquid or purulent secretion, but this is not the case here. It takes a certain amount of time to aggravate bacterial pneumonia, and with viral pneumonia, lung damage can be lightning-fast and lead in the future to severe fibrosis. The risk of developing fibrosis in the lungs is higher in patients with extensive lung lesions, in those who have undergone mechanical ventilation, in patients with concomitant pathology (diabetes mellitus, obesity, hypertension).

Fibrosis in the lungs can be accompanied by persistent coughing, fatigue and poor tolerance to normal physical activity.

The course of covid pneumonia is unpredictable, it is impossible to say in advance how the disease will develop in a particular person. Sometimes pneumonia with initially small lung damage is severe, with rapidly increasing symptoms and volume of damage to the lung tissue, up to life-threatening complications and death.

Scars can cause respiratory failure

The main target of coronavirus infection is the lungs, therefore, viral pneumonia, especially severe, with a large lesion, invasive ventilation of the lungs during treatment can result in fibrosis in the lungs. Fibrosis is a consequence of the inflammatory process when the lung tissue is replaced by a connective tissue scar. In common parlance, this is a scar on the lung. If it is small, then the lung function and gas exchange will not be affected. If fibrosis is extensive, bilateral, with damage to several segments or even lobes, then in the future this can lead to irreversible changes in pulmonary function, respiratory failure, up to disability.

After suffering Covid, patients complain of shortness of breath during normal physical activity, it does not go away for several weeks or even months (shortness of breath can still be a manifestation of a post-Covid asthenic syndrome). Also, fibrosis in the lungs can be accompanied by a constant unproductive cough, fatigue, and poor tolerance to normal physical activity. The most informative method for assessing the prevalence of fibrosis is computed tomography of the chest organs. In addition, doctors prescribe body plethysmography (study of the ratio of different lung volumes), spirometry (a method that allows you to estimate the volume of inhaled and exhaled air), since the vital capacity of the lungs with pneumofibrosis can be reduced.

There are no highly effective, universal drugs for the prevention of fibrosis; it is necessary to start non-drug prevention methods as soon as possible. First of all, it is therapeutic breathing exercises. There are many breathing techniques: remedial gymnastics according to Strelnikova, Buteyko, yoga breathing. You can use your own breathing simulators: blowing air through a tube into a glass of water. Do this exercise for 10 minutes three times a day.

It should be noted that the breathing exercise loved by many - inflating balloons - is prohibited in the acute period of the disease, since there is a risk of damage to the inflamed lung tissue, up to the development of pneumothorax. But during the aftercare period, chest massage, physiotherapy procedures (but taking into account contraindications) are very useful.

Physical activity should be dosed. During the aftercare period, walking, Nordic walking (where the upper shoulder girdle is involved, movements help to improve drainage function and blood flow in the lungs) are very useful. But heavy physical activity should definitely be avoided since the body needs to be given time to recover from a severe infection. It is also forbidden to breathe essential oils, which can settle in the lungs, disrupting blood supply and gas exchange in them. You can not breathe aggressive non-medicinal preparations, alcohol solutions, soda. And our people are very fond of self-medication. By the way, many of those who have had a hard time covid, subsequently quit smoking - due to pronounced respiratory discomfort and shortness of breath and even experienced smokers.

A third of the tests are false negative

Unfortunately, false-negative tests are not uncommon. Approximately every third patient with pneumonia we have with a false-negative PCR test for COVID-19, and there are patients who have been repeatedly tested. There may be several reasons: violation of the timing and technique of taking smears, the unpreparedness of the patient (certain conditions must be met). With the development of covid pneumonia, tests may well show a negative result, because the virus has already penetrated far into the lower respiratory tract and in the upper, where the smear is taken from, it may no longer be there.

About one in three pneumonia patients have a false negative PCR test for COVID-19.

Viral pneumonia is radiographically different from bacterial pneumonia. And from the picture, we can say with a high degree of confidence that this is covid pneumonia. It has certain radiological features, the so-called "ground glass" symptom, changes are bilateral, located subpleural, and affect several segments of the lungs. In addition, patients describe symptoms characteristic of coronavirus infection that cannot be confused with other viral diseases. All patients say: "This was the first time in my life." If a patient wants to make sure that he has suffered from coronavirus pneumonia, we recommend that he be tested for antibodies. And in 99 percent of patients, these antibodies are detected.

For the first 6-8 months after covid pneumonia, people are protected from re-infection, they develop antibodies and develop immunity. By the way, we also have another type of immunity - cellular, which also protects against viral infections. Against the background of weakened immunity after coronavirus, you can contract any other viral infection that has not disappeared from your life and spreads seasonally.

Based on a CT scan of the chest, doctors can say with a high degree of confidence that pneumonia is a coronavirus, even with a negative test for COVID-19.

It is extremely difficult to protect against infection, as well as to predict the course of coronavirus infection. I believe that the risk of developing complications from vaccination is lower than the risk of a severe course of coronavirus infection and its complications. And I meet with complications in my practice every day, and these are not only pneumonia but also myocarditis, pericarditis, cardiac arrhythmias, polyneuropathy, neuropathy of the facial nerve, venous thrombosis, and more.

Rehabilitation of patients

It is necessary to use therapeutic exercises, chest massage, physiotherapy procedures, if

necessary, drug therapy. These are not only patients after pneumonia, but also patients with the post-vein asthenic syndrome, mild post-vascular complications from the nervous, cardiovascular system.

If the patient is not suitable for the rehabilitation program. If there are decompensated chronic diseases of the lungs, heart, rhythm disturbances, any acute diseases until recovery. Already about 100 people are undergoing a rehabilitation course.

## CONCLUSION

To protect yourself from covid pneumonia and other lung infections, you need to:

- get vaccinated against influenza annually, get vaccinated against coronavirus infection, then get vaccinated against pneumococcal infection (pneumococcus - the most common causative agent of bacterial pneumonia);
- Stop smoking - the less aggressive effect on the respiratory tract, the better;
- Timely sanitize chronic foci of other infections;
- Play sports, if possible, lead an active lifestyle (athletes rarely get severe covid pneumonia, and they usually do not have fibrotic changes in the lungs);
- eat properly and fully, take preventive courses of vitamins and mineral complexes;
- humidify the air in the house;
- continue to wear masks, treat hands with antiseptic, avoid crowds of people.

## REFERENCES

1. Bersnev, V.P. Surgical treatment of tumors of the posterior cranial fossa in children / V.P. Bersnev, A.G. Zemskaya, Khachatryan V.A. // Problems of neurosurgery. - SPb., 2000. -- S. 166 - 168.
2. Gasparyan, S.S. On the mechanisms of hydrocephalus in patients with parasagittal meningiomas / S.S. Gasparyan, A.E. Razumovsky, A.R. Shakhnovich, G.A. Gabibov, V.N. Kornienko // Neurosurgical questions. - 1985. - No. 1. - P. 13 - 19.
3. Kim, Won Gi. Hydrocephalus in supratentorial brain tumors: Author's abstract. diss. ...Cand. honey. Sci. / Kim Won Gi. - SPb., 1996. -- 25 p.
4. Kim, A.V. Diagnostics and treatment of hypertensive-hydrocephalic syndrome in children with tumors of the posterior cranial fossa: Author's abstract. diss. ... Ph.D. Sciences / Kim A.V. - SPb., 2004. -- 25 p.
5. Kommunarov, V.V. The choice of the parameters of the implantable drainage system in the treatment of hydrocephalus: Abstract of the thesis. diss. ...Cand. honey. Science / V.V. Kommunarov. - SPb., 2003. -- 25 p.
6. Ozerov, S.S. Medulloblastomas. Complex treatment problems / S.S. Ozerova, S.K. Gorelyshev, E.A. Khukhlaeva et al. //
7. Fiorillo A. Shunt-related abdominal metastases in an infant with medulloblastoma: long-term remission by systemic chemotherapy and surgery. Fiorillo A, Maggi G, Martone A,

- Migliorati R, D'Amore R, Alfieri E, Greco N, Cirillo S, Marano I. // J Neurooncol. - 2001. - Vol. 52 (3). - P. 273-276.
8. Griwan M.S. Value of precraniotomy shunts in children with posterior fossa tumours / M.S. Griwan, B.S. Sharma, R.K. Mahajan, V.K. Kak // Childs Nerv. Syst. - 1993. - Vol. 9 (8). - P. 462 - 465.
  9. Inamasu J., Nakamura Y., Saito R., Kuroshima Y., Mayanagi K., Orii M. and Ichikizaki K. Postoperative communicating hydrocephalus in patients with supratentorial malignant glioma. ClinNeurolNeurosurg 2003; 106: 9-15
  10. Haas J. Ventricular shunts and drainage in the management of posterior fossa tumors. In posterior fossa tumors (ed. Raimondi A.J., Choux M., De Ricco E.), 1993, p. 80-85.
  11. Khachatryan W.A. On the pathogenesis of hypertensive hydrocephalus // 62nd Ann. Meet. Am. Ass. Neurol. Surg., San Diego. - 1994. - P.343-344.
  12. Kumar V. Ventriculo-peritoneal shunt requirement in children with posterior fossa tumours: an 11-year audit / V. Kumar, K. Phipps, W. Harkness, R.D. Hayward // Br J. Neurosurg. - 1996. - Vol. 10 (5). - P. 467- 470.

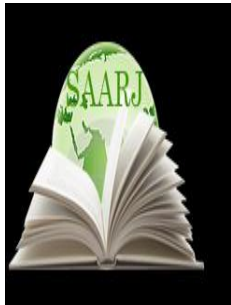

**ACADEMICIA**  
**An International**  
**Multidisciplinary**  
**Research Journal**  
 (Double Blind Refereed & Peer Reviewed Journal)



**DOI: 10.5958/2249-7137.2021.01178.2**

## THE ROLE AND IMPORTANCE OF ODR IN MODERN BUSINESS SOCIETY

**Dr Nasiruddeen Muhammad\*; Mokhinur Bakhranova\*\***

\*Assistant Professor at College of Law,  
 University of Dubai, DUBAI  
 Email id: nmuhammad@ud.ac.ae

\*\*Senior teacher at Intellectual Property,  
 Law department, Tashkent state university of law,  
 Tashkent, UZBEKISTAN  
 Email id: mokhinurbakhranova@gmail.com

### ABSTRACT

*ODR procedures involve the filing of electronic documents in which the parties can use encryption or electronic signatures to protect the integrity of documents and authenticate transactions. Typically, when parties turn to ODR for help, a service provider allows for the appointment of a neutral panel of judges or panelists. Parties generally prefer structured and clear procedures where the authorisation process is simple and well defined. Institutions such as WIPO, SIAC and ICC have positive track records in resolving online disputes through mediation or other alternative methods of dispute resolution.*

**KEYWORDS:** *ODR, Electronic Documents, WIPO, SIAC, ICC, UNCITRAL Model Law, New York Convention, WIPO Uniform Domain Name Dispute Resolution Policy, Electronic Consumer Dispute Resolution (ECODIR), Online Ombuds Office.*

### INTRODUCTION

The jurisdiction of online dispute resolution may involve the application of the conflict of laws rule to the server location or registration of the corresponding domain. If it is a company, then the place of registration is that of the company. It is ideal if the arbitration centre associated with the ODR platform uses its jurisdiction and the approval of the decision by the centre itself to ensure its execution. ODR can gain the most popularity and relevance within the framework of smart contracts. In this regard, it is necessary to adopt an international convention or amend the New York Convention as well as recognise national laws and the UNCITRAL Model Law, a rule

on the recognition and enforcement of ODR awards. Also, online arbitration needs to be described, the procedure is only online, and there are parties and arbitrators in it. In digital arbitration, everything is done by a computer and through artificial intelligence.

When filing a complaint, the applicant seeks compensation or another remedy, and the defendant, if he agrees to participate in the process, provides his detailed response. The process may or may not include an oral hearing via teleconference software or video conference rooms. Sometimes, automated software could be used to resolve a dispute without the need to appoint a third party.

Typically, the ODR service provider serves as the administrator and infrastructure provider rather than a judge who resolves disputes. ODR is known for its efficient and cost-effective dispute resolution that also reduces irritability between parties.

## RESULTS AND DISCUSSIONS

The origins of ODR can be traced back to 1996, when the Virtual Magistrate Project was created to offer an online arbitration system for resolving electronic defamation issues. For instance, the University of Massachusetts Online OmbudsOffice resolved a website dispute with the owner of a local newspaper associated with a copyright infringement through mediation.<sup>1</sup> Since 1999, many ODR service providers have actively addressed disputes in both the public and private spheres involving public and commercial entities.<sup>2</sup>

To provide another example, in India, ODR originated from alternative dispute resolution (ADR) processes in which family disputes were resolved by srenis (businessmen doing the same business) and parishads (a group of men with legal knowledge). In other jurisdictions, ODR was also based on ADR practices, adding technologies to the ADR process to make it more efficient and convenient for the parties. In India, the use of ADR techniques is explicitly encouraged in the Nyaya Panchayat, Lok Adalat, Arbitration and Conciliation Act 1996, based on the UNCITRAL Model Law on Arbitration, providing statutory arbitration among other initiatives. The Indian legal framework supports ODR, including Section 89 of the 1908 Civil Procedure Code, which promotes the use of alternative dispute resolution between parties. Likewise, Rule 1A of Bylaw X empowers the court to direct the litigants to select any ADR method to resolve disputes. In addition, the Information Technology Act 2000 legally recognises the use of electronic signatures and electronic records. Recently, in the State of Maharashtra v Dr Praful B. Desai,<sup>3</sup> the Indian Supreme Court ruled that video conferencing is an acceptable method of recording witness statements. In the case of Grid Corporation of Orissa Ltd v AES Corporation,<sup>4</sup> the Supreme Court ruled: 'When effective consultation can be achieved through electronic media and remote conferencing, there is no need for two people who need to act in consultation with each other to necessarily sit together in one place unless required by law or by the basic agreement between the parties'.<sup>5</sup>

Thus, the legal framework, as well as the precedents set by the Supreme Court of India, support the use of technology to resolve disputes and encourage the use of ODR practices.

Cost and time efficiency are typical characteristics of ODR, as opposed to litigation, which is a time-consuming and expensive method of resolving disputes. Brams, S.J. and Taylor, have clearly stated: 'The difficulty of using traditional dispute resolution methods in low-value cross-



border disputes has led to an interest in cheap cases, methods of resolving disputes between jurisdictions'.<sup>6</sup>

Jurisdictional issues have been studied in depth by western experts. In particular, Johnson examined the topic of borders on the Internet, countries in which the domain name is registered under the jurisdiction of the court.<sup>7</sup>

ODR offers plenty of flexibility, as it can be initiated at any point in a trial or even before a trial begins. The ODR may also be terminated if the parties mutually agree that it does not lead to a workable solution. The parties have the right to independently determine the methods and procedures for resolving disputes online in the event of disputes arising under a specific electronic contract. Even in the absence of a written contract declaring the ODR as a dispute resolution method, parties can use ODR methods to resolve their disputes when such disputes arise. In contrast to litigation, the parties are free to choose their governing contract law, dispute resolution procedure, ODR service provider and other related issues. The use of ODR also allows for the selection of a neutral third party from an experienced group of mediators and arbitrators, which increases impartiality and means that the parties can present their cases on their own without fear of their private disputes entering the public domain through legal precedents. Disputes and negotiations between the parties will always remain confidential. In B2C (Business to Consumer) transactions, ODR encourages customer loyalty, while in C2C (Consumer-to-consumer) transactions, it minimises dissatisfaction and the risk of fraudulent transactions between stakeholders.

Another definition of international jurisdiction is analysed by Fedotov. In his opinion, the country in which the Internet server is located depends on the criterion of jurisdiction. The author believes that every server that is materially located in a particular state and on the territory of that state is subject to its laws.<sup>8</sup>

The state establishes its jurisdiction over a person if there is a specific connection between his territory and that person. A connection to a region is particularly evident when the information is located on a specific server that allows Internet users to access it. Obviously, a state can, at any time, establish its jurisdiction over persons who store information on its territory, and it is inappropriate for a person operating on the Internet to ignore the legislation of the state in which the information is posted. However, this precedent does not mean that other states should abandon their jurisdictions in favor of the jurisdiction of the state in which the server is located.<sup>9</sup>

Referring to the jurisdiction of the country in which the server is located for a person who publishes a relevant item on the Internet is, without a doubt, convenient, as acknowledging the legislation of the 'host' country can resolve vexing issues. However, this also raises a serious concern; the opportunity for a person to create and use a document himself is especially convenient for keeping the level of protection of absolute right slow, and no special legislation on the Internet may decide the jurisdiction described. At the same time, it is important to remember that the domain name of the country in which the server is located may not be compatible with the country of registration, in which case a user that accesses the Internet from one domain name and switches to another computer thousands of miles away does not pose a problem for the domain name owner.<sup>10</sup>

A variety of dispute resolution methods may be involved in ODR, including negotiation, conciliation, mediation, arbitration and hybrid mechanisms such as final offer arbitration, Medola,

mini-trial, med-arb, and neutral evaluation. ODR can be adjudicated or out of court. An example of a litigation is arbitration in which the award by the arbitrator is binding on both parties. In contrast, in a non-adjudicated process, the main goal is to arrive at a settlement of a dispute between parties without ruling on its merits. Mediation by a neutral third party offers options for resolving disputes between the parties and active participation in the dispute resolution process.

In Canada, the Cyber Tribunal in Montreal has successfully resolved electronic disputes using ODR, while in the United States, the Online Ombuds Office has used electronic mediation. SquareTrade is a well-known ODR provider that resolves disputes between sellers and buyers who use online commercial services by adopting methods of negotiation and mediation. Financial and insurance disputes may be resolved in the USA through Cybersettle and Click'NSettle. Other ODR service providers include [www.mediate.com](http://www.mediate.com), [www.novaforum.com](http://www.novaforum.com), [www.icourthouse.com](http://www.icourthouse.com) and [www.tribunal.com](http://www.tribunal.com). Smartsettle uses negotiation software to resolve disputes between parties as well as give priority to various interests affected by disputes.

Deutscher Bundestag put forward his proposal to regulate the considered sphere of relations.<sup>11</sup> According to the author, non-contractual obligations on the Internet should be governed by the legislation of the country of permanent residence, the main place of business of the operator of the site or an individual or legal entity who has posted the results of intellectual activity on the Internet. However, the level of protection afforded under the relevant law cannot be lower than the level of protection afforded under the Berne Convention and the Agreement on Trade-Related Aspects of Intellectual Property Rights. Otherwise, the laws of the country containing the server hosting the illegally used intellectual property shall apply. The author proposes the use of the proximity principle as a criterion for correction.<sup>12</sup>

One of the most successful ODR initiatives is the WIPO Uniform Domain Name Dispute Resolution Policy (UDRP). The policy, adopted by ICANN on 26 August 1999, provides for an administrative procedure to resolve domain name disputes through accredited service providers that follow the UDRP along with their own additional rules. WIPO, the National Arbitration Forum and the Asian Domain Name Dispute Resolution Center are among the most highly accredited ODR service providers. In administrative proceedings, it is stipulated that disputes are subject to resolution. Within a certain time frame, procedures can be initiated before the trial continues. The decision of the administrative board can be appealed within 10 days. Disputes have been resolved through the UDRP on the transfer of domain names registered in bad faith by the respondent, which has no legitimate interest if the domain name is deceptively similar or identical to the complainant's trademark. At *Tata Sons Ltd. v Advanced Information Technology Association*,<sup>13</sup> WIPO ordered the transfer of the [Tata.org](http://Tata.org) domain name to the plaintiff *Tata Sons Ltd.*, as all three criteria of the UDRP policy were established in the case.<sup>14</sup>

Conflicting rules regarding 'law of location', 'law of structured place' and 'law of damaged place', which are usually used to define rights in private international law, have different meanings when applied to legal disputes arising on the Internet in accordance with the criterion 'server location'.<sup>15</sup> Server location is the location of the physical communications system (hardware and software), and the physical location of the server hosting the information (website) cannot be considered as a criterion for this type of dispute. The location of the equipment qualifies as the location of the server if the tools and software installed on it belong to a specific person and are used to perform activities that are critical to legal disputes that arise on the Internet.<sup>16</sup>

In online dispute resolution, many complex issues may arise – including commercial and legal ones – and their consequences follow. As a rule, when accessing the ODR process, mutual consent between the parties is required, whether through an explicit clause in the contract or by mutual agreement of the parties after a dispute that may arise. The service provider must be legally binding or enforceable. Most jurisdictions recognise and enforce the standard ODR clause on a B2B website; however, in the case of B2C contracts, especially in the European Union, consumers cannot be deprived of the additional rights available to them by the law of their place of residence through an agreement restricting the jurisdiction of the court to the country of the ODR service provider if it provides lower standards of protection that the consumer is entitled to in his country of residence.<sup>17</sup> Maintaining the confidentiality and secrecy of negotiations as well as of any subsequent transactions between the parties when resolving disputes is one of the most important tasks of online international arbitration. The Internet is still considered an unsafe medium for arbitration, as cybercriminals have several methods with which to intercept data and messages between parties, and any information passing through Internet networks can be illegally stored or used by cybercriminals. In light of this, increasingly sophisticated methods of security on the Internet are emerging, such as the use of digital signatures. Furthermore, technology can be used to combat any Internet security loopholes and strengthen the ODR process. Stanieri A. and Zeleznikow J.<sup>18</sup> also believed that technology is a fourth party in the ODR process and noted that ODR can be used not only to effectively resolve online disputes but to build trust in virtual spaces as well. The use of cookies often violates Internet users' privacy and increases security concerns. E-litigation employs multiple layers of security, including a sophisticated server, complex passwords and software that backs up the complete data of its servers and stores information provided by parties in a secure environment. Such technical infrastructures are required to address any concerns about confidentiality breaches in the ODR process. Many paralegal rights, such as money back guarantees, buyer protection clauses and authentication stamps, are becoming popular on e-commerce websites. This only serves to generate more trust in ODR practices and promote consumer confidence in e-commerce.

Another significant concern for most parties is that their disputes should be independent and decisions should be impartial. To this end, they tend to prefer institutional ODR providers, which are more structured and transparent, reducing the chances of bias affecting panelists' decision-making process.

In cyberspace, there are no uniform laws for ODR, which creates challenges regarding the application of substantive and procedural law to the resolution of electronic disputes. To decide on the jurisdiction that applies to online disputes, the effects test<sup>19</sup> and the Zippo sliding scale approach<sup>20</sup> can be used. In private international law, the place of performance of a contract is an important parameter for determining the substantive law or jurisdiction that will be relevant to the circumstances of the case. Consumer protection law provides stronger consumer protections in Europe and the enforcement of binding legal regulations in *lex situs*, some of the challenges stemming from the lack of uniform cyber laws. Could there ever be an International Court of Justice that resolves disputes of any nature by enacting homogeneous cyber laws regulating the ODR process and procedures? Here, I draw an analogy between ODR and the application of *lex mercatoria* to international trade. It will be beneficial, though homogeneous, to formulate law on ODR or the basic legal principles of ODR legislation and practice. Major international legislative texts, treaties, conventions and national initiatives can add certainty to ODR law and practices in

cyberspace. In fact, this mission is thought to be halfway complete, as several initiatives have been implemented to bring more clarity to ODR. These initiatives include the United Nations Convention on the Recognition and Enforcement of Foreign Arbitral Awards 1958, the Brussels Convention on Jurisdiction and the Enforcement of Judgments in Civil and Commercial Matters 1968 and the Rome Convention on the Law Applicable to Contractual Obligations 1980. In 1999, the Organisation for Economic Co-operation and Development (OECD) published its guidelines for consumer protection in the context of electronic commerce.<sup>21</sup> The guidelines stipulate that the consumer should have access to fair and cost-effective means of resolving disputes and explain the importance of information technology when using ADR systems.<sup>22</sup>

In the European Union, letter E of Article 17 of the Trade Directive<sup>23</sup> provides that, in the event of an electronic dispute, Member States are required to ensure that parties are not prevented from using ADR procedures, 'including appropriate electronic means', to resolve a dispute. The National Alternative Dispute Resolution Advisory Board developed standards for ADR in 2001 and established ODR guidelines in 2002.<sup>24</sup>

Thus, some legislative initiatives aimed at promoting ADR and the use of technology to provide rapid dispute resolution services already exist. This is an issue of introducing new ideas and solutions to promote and optimise ODR laws, including the legal principles proclaimed by international initiatives and fair adaptation, which will lead to the unification of ODR legislation and practices.

Some critics, such as Drake and Mober<sup>25</sup> and Wilson, Aleman and Leatham,<sup>26</sup> have expressed fears arising from a lack of personal interaction between the parties of the dispute. Physical presence, body language and tone of conversation are important when resolving a dispute. Along these lines, Goffman<sup>27</sup> developed 'face theory', which explains that the process of resolving a dispute and its success directly depend on the communication between the parties and any negative or positive statements made during communication.

Nevertheless, in most cases of ODR, the parties are not familiar with one another, and a face-to-face meeting between the parties may reduce the likelihood of a dispute resolution. In ODR, multiple technical methods, such as automated software, are used to resolve disputes between the parties, and the parties may not be required to participate in person or even in video conferencing hearings in which the parties can exchange negative comments. If the theory of faces can be correctly applied to ODR, hostility between the parties diminishes, as in many cases, automated online processes help to resolve disputes. Additionally, if any language or cultural barriers exist, it is common practice to use translation and interpretation services during ODR. In terms of enforcement, critics may be of the opinion that when ODR is not binding, it is useless. However, in my opinion, if the optional ODR is successful and results in a binding settlement agreement, it is enforceable in court. ODR also offers fair solutions, as it recognises the principles of fairness and natural justice in addition to statutory rules for resolving a dispute.

Over time, discussions about 'self-regulation versus government interference' in ODR have arisen. Self-regulation has been challenged by consumer groups due to a lack of credibility, leading to the role of government in the ODR process. Initially, the American Arbitration Association, ICC and Better Business Bureau laid out principles for ODR regulation and emphasised the use of the seal of confidence.

Companies such as Verisign and TRUSTe were then formed, and SquareTrade and BBB Online implemented the concept of trust marks as a self-regulatory initiative in ODR practice. At the government level, Electronic Consumer Dispute Resolution (ECODIR) and other ODR projects were implemented as measures of e-governance, as ODR proved to be an effective means of dispute resolution. Schultz<sup>28</sup> was of the opinion that the role of the state is more important than the self-regulatory approach. According to Schultz, 'symbolic capital' – that is, the social reputation of the ODR provider – lends credibility and authenticity to the ODR process that the government is able to provide. The government also provides financial assistance to ODR projects and assists in setting up the technical and administrative infrastructure needed to perform ODR. In addition, Schultz suggests that accreditation is imperative when providing ODR services, as well as acting as a certifier and clearinghouse, helping parties select a service provider, facilitating electronic filing of forms and overseeing the ODR process. He also advocated for an online appeal system of verifying decisions by ODR providers that will provide greater transparency and accountability in the ODR system. Likewise, Rule states: 'To a large extent, the government is the ideal place to resolve disputes because the government has a strong incentive to resolve disputes so that society can function normally. The government is also a good place to resolve disputes, as it is usually not interested in the outcome of most of the issues that are entrusted to it'.<sup>29</sup>

## CONCLUSION

After analysing these two approaches, we have come to believe that ODR growth can be realised to its fullest potential through public-private partnerships. The role of government will be to instill trust and credibility, and the private sector will contribute to cutting-edge technology. In public-private partnerships, ODR best practices can be successfully established and implemented, and greater awareness and participation in the ODR process can be realised. In the US, Australia, New Zealand, Singapore, Canada and the UK, special funding provided by the government may help to initiate ODR projects.

In the Netherlands, the e-commerce platform is a joint initiative of the business community and the Dutch Ministry of Economy, which developed a Code of Conduct for Electronic Commerce.<sup>30</sup>

In Singapore, e-ADR has been launched and is jointly administered and controlled by the lower courts of Singapore, the Ministry of Law, the Singapore Mediation Centre, the Singapore International Arbitration Court Centre, the Trade Development Council and the International Economic Development Council to resolve commercial disputes. Electronic courts in India also seek to promote ODR, judicial review and judicial ODR using online resources, and the CBI (Central Bureau of Investigation) is in the process of establishing electronic courts.<sup>31</sup>

An analysis of the issue of digital arbitration and its jurisdiction in electronic dispute resolution showed that digital arbitration can be considered on the basis of artificial intelligence and become an effective mechanism for resolving disputes arising primarily on the Internet and with regard to smart contracts. Additionally, a proposal on digital arbitration jurisdiction has been developed to introduce special conflict-of-law rules on the subordination of the relevant domain to the law of the place of registration. It was also concluded that the introduction of digital arbitration by existing arbitration centers and their subordination to their jurisdiction is an ideal

situation, and the formalization of decisions by the arbitration center will facilitate its implementation.

### THE LIST OF USED LITERATURES

1. Maharashtra v Dr Praful B. Desai (2003) 4SCC 601
2. Grid Corporation of Orissa Ltd v AES Corporation 2002 AIR SC 3435
3. Brams, S.J. and Taylor, A.D. 1996, Fair division from cake cutting to dispute resolution, Cambridge University Press, Cambridge, U.K.
4. Johnson, D.R. (1996) Law And Borders – The Rise of Law in Cyberspace // Stanford Law Review. pp. 34 <https://files.grimmelman.net/cases/JohnsonPost.pdf>
5. Fedotov, M.A. (2002) 'Legal protection of works in cyberspace'. *Electronic libraries*, 5(4), p. 54. [http://www.evarussia.ru/upload/doklad/doklad\\_330.doc](http://www.evarussia.ru/upload/doklad/doklad_330.doc)
6. Leanovich, E.B. 'Problems of legal regulation of Internet relations with a foreign element'. Internet resource: <http://www.evolution.info>
7. Stanieri A., Zeleznikow J., Gawler M. and Lewis B, 1999 A hybrid-neutral approach to automation of legal reasoning in the discretionary domain of family law in Australia, *Artificial intelligence and law*, 7(2-3).
8. Brams, S.J. and Taylor, A.D. (1996) *Fair division from cake cutting to dispute resolution*. Cambridge: Cambridge University Press.
9. Thiessen, E.M. and McMahon, J.P. (2000) 'Beyond win-win in cyberspace'. *Ohio State Journal on Dispute Resolution*, 15, 643
10. Stranieri, A., Zeleznikow, J., Gawler, M. and Lewis, B. (1999) 'A hybrid-neutral approach to automation of legal reasoning in the discretionary domain of family law in Australia'. *Artificial intelligence and law*, 7(2-3).
11. Goffman, E. 1967. *Interaction ritual*. Garden City, NY: Doubleday.
12. Thomas Schultz, Does Online Dispute Resolution Need Governmental Intervention? The Case for Architectures of Control and Trust, *NORTH CAROLINA JOURNAL OF LAW & TECHNOLOGY VOLUME 6, ISSUE 1: FALL 2004*.
13. Drake, B.H. and Moberg, D.J. (1986) 'Communicating influence attempts in dyads: Linguistic sedatives and palliatives'. *Academy of Management Review*.
14. Yuldashov, A. (2012). Government policies related to social protection of disabled persons in Uzbekistan: National and international aspects. *Teise*, 84, 186-191. <https://doi.org/10.15388/Teise.2012.0.23>;
15. Yakubova I. "Civil-law protection of honor, dignity and business reputation in the civil legislation of Uzbekistan and Japan" *Review of law sciences*, no. 3, 2018, pp. 79-85. doi:10.24412/2181-1148-2018-3-79-85;
16. Khujayev, S. A. (2018). Judgments under the law of the Republic of Uzbekistan «On banks and bank activity» in the new edition. *International Journal of Legal Studies (IJOLS)*, 4(2), 295-301;

17. Mokhinur, B. (2020). A thorough review of the common law concept of "arbitrary termination" and "unfair dismissal"(including DIFC&ADGM. Review of law sciences, (NOVEMBER);
18. Бобур Мукумов (2020). Оценка регулирующего воздействия нормативно-правовых актов на предпринимательскую деятельность в условиях пандемии коронавируса (на примере Торгово-промышленной палаты Республики Узбекистан). Review of law sciences, (2), 74-77. doi: 10.24412/2181-1148-2020-2-74-77.

**Internet resources**

1. <https://www.legislation.gov.au/aghome/advisory/nadrac/technology-ADRno.2.htm>
2. <https://www.wipo.int/amc/en/domains/decisions/html/2000/d-0049.html>
3. <https://www.wipo.int/amc/en/domains/decisions/html/2000/d2000-1038.html>
4. [www.nmi.mediation.nl/en/nmi/mediationframed.http](http://www.nmi.mediation.nl/en/nmi/mediationframed.http)
5. <http://www.wipo.int/amc/en/domains/decisions/html/2000/d2000-1038.html>
6. <http://www.ombuds.org/narrative%201.html>
7. <http://www.adr.online.org>

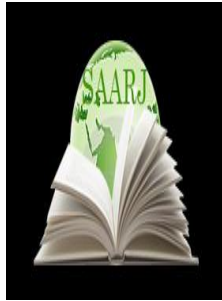

**ACADEMICIA**  
**An International**  
**Multidisciplinary**  
**Research Journal**  
 (Double Blind Refereed & Peer Reviewed Journal)



**DOI: 10.5958/2249-7137.2021.01177.0**

## THE ROLE OF MULTIMEDIA IN EDUCATION

**Xakimboyeva Ozoda\*; Xurramova Maftuna\*\***

\*Teacher,  
 State World Languages University,  
 UZBEKISTAN

\*\*Fourth year student of Uzbekistan State World Languages University,  
 UZBEKISTAN

### ABSTRACT

*This can present a challenge to educators wishing to engage students in the classroom while still providing required content in order to enhance learning outcomes. In Teaching and learning communication skills, we have a lot to choose from the world of technology: TV, CD Rom, Computers, the Internet, Electronic Dictionary, Email, Blogs and Audio Cassettes, Power Point, Videos, DVD's or VCD's. The last two decades have witnessed a revolution due to onset of technology, and has changed the dynamics of educational institutes, and has also influenced the educational system and the way people interact and work in the society. This rapid rising and development of information technology has offered a better pattern to explore the new teaching model. Using multimedia to create a context to teach communication skill has its unique advantages. As a result technology plays a very important role in teaching communication skill.*

**KEYWORDS:** *Multimedia, Education, Media, Image, Graphics.*

### INTRODUCTION

It is probably one of the most exciting innovations in the information age. The rapid growth of multimedia technologies over the last decade has brought about fundamental changes to computing, entertainment, and education (Norhayati& Siew 2004). Multimedia technologies and applications are probably one of the most exciting innovations in the age of information evolution. They helped and got help from the Internet and other communication and computer inventions. Multimedia has the potential to create high quality learning environments, with the capability of creating a more realistic learning context through its different media. It also helps allowing a learner to take better control of the classroom especially when the class size is large.



Multimedia has the potential to create high quality learning environments. With the capability of creating a more realistic learning context through its different media and allowing a learner to take control, interactive multimedia can provide an effective learning environment to different kinds of learners (Margie & Liu, 1996).

### **The history of multimedia**

The term "multimedia" was coined by Bob Goldstein to promote the July 1966 opening of his "Light Works at L' Oursin" show at Southampton, Long Island. On August 10, 1966, Richard Albarino of Variety borrowed the terminology, reporting: "Brainchild of song scribe-comic Bob Goldstein, the 'Light works' is the latest multi-media music-cum-visuals to debut as discothèque fare". Two years later, in 1968, the term "multimedia" was re-appropriated to describe the work of a political consultant, David Sawyer, the husband of Iris Sawyer one of Goldstein's producers at L'Oursin.

This term is said to date back to 1965 and was used to describe a show by the Exploding Plastic Inevitable. The show included a performance that integrated music, cinema, special lighting, and human performance. In the 1993 first edition of McGraw-Hill's *Multimedia: Making It Work*, Tay Vaughan declared "Multimedia is any combination of text, graphic art, sound, animation, and video that is delivered by computer. When you allow the user – the viewer of the project – to control what and when these elements are delivered, it is interactive multimedia. When you provide a structure of linked elements through which the user can navigate, interactive multimedia becomes hypermedia."<sup>1</sup>

In common usage, the term multimedia refers to an electronically delivered combination of media including video, still images, audio, text in such a way that can be accessed interactively. Much of the content on the web today falls within this definition as understood by millions. Some computers which were marketed in the 1990s were called "multimedia" computers because they incorporated a CD-ROM drive, which allowed for the delivery of several hundred megabytes of video, picture, and audio data.

Accordingly, it is media and content that uses a combination of different content forms. The term can be used as a noun (a medium with multiple content forms) or as an adjective describing a medium as having multiple content forms. The term is used in contrast to media which use only rudimentary computer display such as text-only or traditional forms of printed or hand-produced material. Moreover it includes a combination of text, audio, still images, animation, video, or interactivity content forms.

Multimedia is usually recorded and played, displayed or accessed by content processing devices, such as computerized and electronic devices, but can also be part of a live performance. Multimedia as an adjective also describes media devices used to store and experience multimedia content.<sup>2</sup> Besides multiple types of media being integrated with one another, multimedia can also stand for interactive types of media such as video games, CD ROMs that teach a foreign language, or an information Kiosk at a subway terminal. Other terms that are sometimes used for multimedia include hypermedia and rich media.

Once the media elements have been digitized and stored in the PC, they can then be edited or modified in software packages. In these packages, the media elements are modified to include special effects and filters to further enhance its look and perspective. The group members who

were designated as graphic designers had the responsibility to edit images in image-editing packages. Many chose to use Adobe Photoshop for this purpose. Adobe Photoshop is a sophisticated image-editing tool that is popularly used to modify and edit digital images. Other media elements like animations were digitally created in animation software like Macromedia Flash and 3D packages like Kinetix 3D Studio Max. Authoring is the stage where all the media elements that have been created or modified and stored digitally in the PC are brought together into one final application and integrated into a cohesive presentation for the purpose of conveying a specific message to the audience. It is also at this stage that elements of interactivity and navigation are incorporated to involve the user in the application and to create a multi-sensory experience.

### **The role of multimedia in education**

The world in which we live is changing rapidly and the field of education is experiencing these changes in particular as it applies to Media Services. The old days of an educational institution having an isolated audio-visual department are long gone! The growth in use of multimedia within the education sector has accelerated in recent years, and looks set for continued expansion in the future.

The use of multimedia in education has been extensive, as it has been effective in increasing productivity and retention rates, where research has shown that people remember 20% of what they see, 40% of what they see and hear, but about 75% of what they see and hear and do simultaneously. This is especially significant in the CBT (Computer-Based Training) modules in corporations like Ernst & Young, and Union Pacific, where employees are trained in organizational procedures and in flight simulations in the aviation industry to train pilots. It is now permeating the educational system as a tool for effective teaching and learning. With multimedia, the communication of the information can be done in a more effective manner and it can be an effective instructional medium for delivering information. A multi-sensory experience can be created for the audience, which, in turn, elicits positive attitudes toward the application. Multimedia has also been shown to elicit the highest rate of information retention and result in shorter learning time. On the part of the creator, designing a multimedia application that is interactive and multi-sensory can be both a challenge and a thrill. Multimedia application design offers new insights into the learning process of the designer and forces him or her to represent information and knowledge in a new and innovative way.<sup>3</sup>

Multimedia, defined, is the combination of various digital media types such as text, images, sound and video, into an integrated multi-sensory interactive application or presentation to convey a message or information to an audience. In other words, multimedia means “an individual or a small group using a computer to interact with information that is represented in several media, by repeatedly selecting what to see and hear next”.

Multimedia is changing the way we communicate with each other. The way we send and receive messages is more effectively done and better comprehended. The inclusion of media elements reinforces the message and the delivery, which leads to a better learning rate. The power of multimedia lies in the fact that it is multi-sensory, stimulating the many senses of the audience. It is also interactive, enabling the end-users of the application to control the content and flow of information (Vaughan, 1998). This has introduced important changes in our educational system and impact the way we communicate information to the learners (Neo & Neo, 2000). The

evolution of multimedia has made it very possible for learners to become involved in their work. With multimedia technologies, they can create multimedia applications as part of their project requirements. This would make them active participants in their own learning process, instead of just being passive learners of the educational content.

Teachers primarily require access to learning resources, which can support concept development by learners in a variety of ways to meet individual learning needs. The development of multimedia technologies for learning offers new ways in which learning can take place in schools and at home. Enabling teachers to have access to multimedia learning resources, which support constructive concept development, allows the teacher to focus more on being a facilitator of learning while working with individual pupils. Extending the use of multimedia learning resources to the home represents an educational opportunity with the potential to improve pupil learning.

The elements used in multimedia have all existed before. Multimedia simply combines these elements into a powerful new tool, especially in the hands of teachers and pupils. Interactive multimedia weaves five basic types of media into the learning environment: text, video, sound, graphics and animation. Since the mode of learning is interactive and not linear, a pupil or teacher can choose what to investigate next. For example, one does not start on the first page of a linear document and read to the end. Interactive multimedia learning mode is more like constructing a spider's web, with one idea linked to another, allowing choices in the learner's path.

The multimedia technologies that have had the greatest impact in education are those that augment the existing curriculum, allowing both immediate enhancement and encouraging further curriculum development. For example, the WWW serves as a storehouse of information that individual learners can search for subject matter content that specifically fits their learning agendas. Multimedia applications for computers have been developed for single computing platforms such as the PC, Apple Mac and games machines.

It is very tempting to use the latest computer wizardry to represent information and develop computer enhanced learning materials. However, the instructional design of these systems should be based on a careful examination and analysis of the many factors, both human and technical, relating to visual learning. When is sound more meaningful than a picture? How much text is too much? Does the graphic overwhelm the screen? For a pupil, this allows them to test all of their skills gained in every subject area. Pupils must be able to select appropriate multimedia tools and apply them to the learning task within the learning environment in order for effective learning to take place.

In teaching English for Kids, multimedia is used to produce computer-based training courses (popularly called CBTs) and reference books like encyclopedia and almanacs. A CBT lets the user go through a series of presentations, text about a particular topic, and associated illustrations in various information formats. Edutainment is an informal term used to describe combining education with entertainment, especially multimedia entertainment.<sup>4</sup>

Learning theory in the past decade has expanded dramatically because of the introduction of multimedia. Several lines of research have evolved (e.g. Cognitive load, Multimedia learning, and the list goes on). The possibilities for learning and instruction are nearly endless.

The idea of media convergence is also becoming a major factor in education, particularly higher education. Defined as separate technologies such as voice (and telephony features), data (and productivity applications) and video that now share resources and interact with each other, synergistically creating new efficiencies, media convergence is rapidly changing the curriculum in universities all over the world. Likewise, it is changing the availability, or lack thereof, of jobs requiring this savvy technological skill.

English teaching today has gone into the vicious circle. Teachers need to consider how to perfect the teaching system to improve pupils' practical ability of English. Therefore an efficient way should be used to make the class vivid. Multimedia teaching will bring pupils into a class where they can interact with the teacher and the subject. Multimedia teaching is more intuitive than old ways; teachers can simulate situations in real life. More importantly, teachers will have more approaches to stimulating pupils' passion of learning

A *Multimedia Learning* environment involves a number of components or elements in order to enable learning to take place. Hardware and software are only part of the requirement. As mentioned earlier, multimedia learning integrates five types of media to provide flexibility in expressing the creativity of a pupil and in exchanging ideas

**Text.** Out of all of the elements, text has the most impact on the quality of the multimedia interaction. Generally, text provides the important information and acts as the keystone tying all of the other media elements together. It is well written text that makes a multimedia communication wonderful.

**Sound.** Sound is used to provide emphasis or highlight a transition from one page to another. Sound synchronized to screen display, enables teachers to present lots of information at once. This approach is used in a variety of ways, all based on visual display of a complex image paired with a spoken explanation. Sound which is used creatively becomes a stimulus to the imagination, or which is used inappropriately it becomes a hindrance or an annoyance. For instance, a script, some still images and a sound track, allow pupils to utilize their own power of imagination without being biased and influenced by the inappropriate use of video footage. A great advantage is that the sound file can be stopped and started very easily.

**Video.** The representation of information by using the visualization capabilities of video can be immediate and powerful. While this is not in doubt, it is the ability to choose how we view, and interact, with the content of digital video that provides new and exciting possibilities for the use of digital video in education. There are many instances where pupils who are studying particular processes, may find themselves faced with a scenario that seems highly complex when conveyed in purely text form, or by the use of diagrams and images. In such situations the representational qualities of video help in placing a theoretical concept into context.

Video can stimulate interest if it is relevant to the rest of the information on the page, and is not 'overdone'. Video can be used to give examples of phenomena or issues referred to in the text. For example, while pupils are reading notes about a particular issue, a video showing a short clip of the author/teacher emphasizing the key points can be inserted at a key moment; alternatively, the video clips can be used to tell readers what to do next. On the other hand, it is unlikely that video can completely replace the face-to-face lecture: rather, video needs to be used to supplement textual information.

One of the most compelling justifications for video may be its dramatic ability to elicit an emotional response from an individual. Such reaction can provide a strong motivational incentive to choose and persist in a task.

The use of video is appropriate to convey information about environments that can be either dangerous or too costly to consider, or recreate, in real life. For example: video images used to demonstrate particular chemical reactions without exposing pupils to highly volatile chemicals, or medical education, where real-life situations can be better understood via video.

**Animation.** Animation is used to show changes in state over time, or to present information slowly to pupils so they have time to assimilate it in smaller chunks. Animations that are combined with user input enable pupils to view different versions of change over time depending on different variables.

Animations are primarily used to demonstrate an idea or illustrate a concept. Video is usually taken from life, whereas animations are based on drawings. There are two types of animation: Cell based and Object based. Cell based animation consists of multiple drawings, each one a little different from the others. When shown in rapid sequence, for example, the operation of an engine's crankshaft, the drawings appear to move. Object based animation (also called slide or path animation) simply moves an object across a screen. The object itself does not change. Pupils can use object animation to illustrate a point – imagine a battle map of Gettysburg where troop movement is represented by sliding arrows.

**Graphics.** Graphics provide the most creative possibilities for a learning session. They can be photographs, drawings, graphs from a spreadsheet, pictures from CD-ROM, or something pulled from the Internet. With a scanner, hand-drawn work can be included. Standing commented that, “the capacity of recognition memory for pictures is almost limitless”. The reason for this is that images make use of a massive range of cortical skills: color, form, line, dimension, texture, visual rhythm, and especially imagination.

Employing multimedia tools into the learning environment is a rewarding, but complex and challenging task. All of the multimedia formats available: text, sound, video, animation and graphics, already exist in one form or another in most libraries. Pupils can explore an almost infinite variety of information. All these explorations can certainly lead to new discoveries, but unless consumption is followed by production, the story ends. Without a chance to use their new discoveries and demonstrate what they have learned, the knowledge gained soon becomes the knowledge forgotten.

The technology needed to support classroom teaching has increased in complexity. Until only a few years ago all that a lecture room needed were some seats for the pupils, and a blackboard and a lectern or table for the teacher. Then came the overhead projector, slide projector and the return of TV with video player. Now there is the computer, networks and related display tools. From having a next to zero maintenance cost, the teaching room is becoming not only costly to equip, but costly to run and maintain, including the escalating costs of security such as typical multimedia based educational environment. The main teaching spaces are equipped with a standard set of presentation equipment, and full details of what is, and is not, available in each room.

Many school reform models focus on a significant restructuring of the classroom. They propose a shift from a teacher-centered didactic model to a learner-centered constructivist model. While details of these constructivist models vary, they typically include an emphasis on cooperative learning and on the use of project-based learning. Most types of school reform models recognize that multimedia brings a new dimension to reading and writing, and the need for pupils to develop basic skills in information retrieval in multimedia environments.

Pupils respond to information differently. Thus, it is often to our advantage as teachers to use many different formats and modes to teach the subject matter of a lesson. This is why teachers normally use some combination of lecture, text and hands-on laboratory for conveying information. With the advent of the Internet and the multiple formats that can be communicated over the World Wide Web, we now have several new and exciting ways to present information. The Web allows the incorporation of animation, moving pictures, and sound into lessons, which extends our abilities to present materials that encourage pupil interaction with the subject matter. Pictures and animations help bring to life scientific principles, and multimedia allows pupils to take a more active role in learning: they can watch experiments in action, see microorganisms up close, and use a mouse or keyboard to navigate images, simulations and interactive material. One of the advantages of using multimedia is to convey information quickly and effectively to all pupils – and keep them interested in learning.<sup>5</sup>

School-purchased multimedia such as videos and CDs work well, but these can be limited by school budgets. Another drawback of these tools is that given the hectic schedule teachers are often forced to keep, it can be a significant strain on our time to review multimedia materials and seamlessly incorporate them into a lesson plans. Finally, juggling a VCR and TV for video, a CD-ROM player, computer, projector, and textbook can be technically, as well as financially, challenging. Ideally, what teachers needs is a singlesystem that blends text, images, simulations, video, audio and other multimedia material into a single, coherent environment that is available from school or home.

One of the goals of Visionlearning is to provide just such a resource. Visionlearning provides clearly written, concise online multimedia modules that focus on core scientific principles in biology, chemistry, earth sciences, and physics. Our modules make it possible for you to reach out to pupils and allow them to view engaging presentations repeatedly. Our modules provide core, text-based lessons written to conform to the National Science Education Standards. These modules also offer original photographs, scientific illustrations, Flash animations, educational videos, audio recordings, interactive quizzes, and ask-a-question areas through a series of external hyperlinks on the right and bottom menu bars.<sup>6</sup>

Photographs and scientific illustrations appear embedded within our learning modules. Photographs of scientists on the right menu of our modules link to biographies to provide historical context to the lesson. Within the text of the lessons, center-aligned, hyperlinked text loads interactive animations or short movies that help convey the core topic discussed in the lesson. For example, our Scientific Method module contains an interactive experiment in which pupils are virtually transported to Pisa, Italy where they can simultaneously drop different sized objects off of the Leaning Tower. For more examples of our interactive animations, visit our sample animations page. Many of our illustrations and animations are reproduced in an overheads area of the 'Resources' section (bottom menu) of our modules to provide teachers an easy way to show these materials to a class without having to search through a module.

Near the top of the right menu, all Vision learning modules contain an ‘Experiment’ section. This section contains links to educational videos and online interactive experiments that help augment the subject of the lesson. For example, our Cell module contains a link to a virtual tour of an animal cell. Our right-menu ‘Classics’ section contains links to journal articles, audio recordings and videos of scientists that have made key contributions to the field. In addition, interactive quizzes are contained in the bottom left ‘Resources’ section to provide pupils a way to self-assess their learning.

As a teacher, you can use Vision learning’s multimedia materials on and off the Internet. Using the Internet, you can project a computer screen to your class, slowly scrolling through text and clicking on graphics and animations within a lesson. Alternatively, you can work offline with an overhead projector. Our overhead pages (available in the bottom left Resources section) are formatted to be printed on transparencies for classroom use.

Multimedia presentations keep pupils alert and focused. It would benefit your pupils immensely if they could hear a researcher’s opinions, and read their original work. For example, Vision learning’s Atomic Theory I module “Atomic Theory: The Early Days,” has links to J.J. Thompson, a renowned physicist, speaking about his work in the early 1900s. In addition, we provide links to a biography of Thompson and a history of his work, and information about how Thompson went on to mentor other atomic scientists, including Ernest Rutherford.

## CONCLUSION

It is true that one of the ultimate goals of multimedia language teaching is to promote students’ motivation and learning interest, which can be a practical way to get them involved in the language learning. Context creation of ELT should be based on the openness and Accessibility of the teaching materials and information. Concerning the development of technology, we believe that in future, the use of multimedia English teaching will be further developed. The process of English communication learning will be more student-centered but less time-consuming. Therefore, it promises that the teaching quality will be improved and students’ applied English communication can be effectively cultivated, meaning that students’ communicative competence will be further developed. In conclusion, we believe that this process can fully improve students’ ideation and practical language skills, which is helpful and useful to ensure and fulfill an effective result of teaching and learning. Barring a few problem areas multimedia technology can be used effectively in classrooms of ELT with proper computer knowledge on the part of teachers, overcoming the finance problems in setting up the infrastructure and not allowing the teachers to become technophobes. Technology is advancing rapidly and is beginning to provide educators with a wealth of potential tools. The future of education is in finding those technologies that enable active learning experiences for students.

## REFERENCES

1. Richard Albarino. Goldstein's Light Works at Southhampton (1966) Variety 213.
2. Vaughan Tay. Multimedia: Making it work (1993) Osborne/McGraw-Hill, Berkeley.
3. David Roberts. TEDx Talks (2013) Visual feasts of the mind: matching how we teach to how we learn.

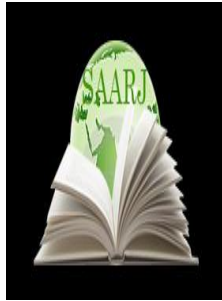

**ACADEMICIA**  
**An International  
Multidisciplinary  
Research Journal**  
(Double Blind Refereed & Peer Reviewed Journal)



**DOI: 10.5958/2249-7137.2021.01199.X**

## **THE EFFECT OF COMBINED STRATEGY INSTRUCTION ON READING COMPREHENSION**

**Turdimatova Gulchiroy\***

\*Fourth year student of Uzbekistan State World Languages University,  
UZBEKISTAN

### **ABSTRACT**

*This study investigated the effectiveness of combined strategy instruction on reading comprehension, students' perceptions of combined strategy training in reading instruction, and teachers' perceptions about combined reading strategy instruction and their experiences during strategy instruction. Four upper-intermediate classes (two as control groups and two as experimental groups) participated in the study. The experimental group received four-week long combined strategy instruction while the control group followed the current reading syllabus without strategy instruction. During the four-week study, Chamot and O'Malley's (1994) strategy instruction model, Cognitive Academic Language Learning Approach (CALLA), was followed for the most part. Prior to and after the four-week study an International English Language Testing System (IELTS) reading test was given to the students to assess their reading comprehension. Retrospective think-aloud protocols were used after the post-reading test in order to gather evidence on the use of strategies during the post-test. Following the treatment, a questionnaire was administered to the experimental group students in order to explore their perceptions of the strategy instruction program. Finally, the instructors of the experimental classes were interviewed about their experiences during the treatment period. The data analysis showed that the experimental group showed significantly greater improvement on the reading test after the four-week study. Furthermore, the retrospective think-aloud protocols demonstrated that experimental group students employed a broad range of strategies during the post-reading test. The analysis of the questionnaire and interviews revealed that combined strategy instruction had a positive impact on both teachers and students.*

**KEYWORDS:** *Reading Strategies, Top-Down Reading Strategies, Bottom-Up Reading Strategies, Reading Strategy Instruction, Strategic Reader, Scaffolding.*



## INTRODUCTION

The era in which we are living has been described as the information age. An important feature of this age is the speed with which information is created, processed, stored or retrieved. This development has made reading an essential skill to acquire wherein readers need to employ strategies to assimilate information. Studies show that reading strategies, which have been defined as plans developed by a reader to assist in comprehending texts (Koda, 2005; Urquhart & Weir, 1998), have a positive influence on reading comprehension (Auerbach & Paxton, 1997; Urquhart & Weir, 1998). Therefore, while performing their reading tasks, students should learn to work strategically (Bimmel & Schooten, 2004; Janzen, 2002; Kern, 1989). A study by Block (1992) revealed that the difference between proficient and less proficient learners is that proficient readers make use of a larger variety of strategies and they can determine which strategy to use for different tasks. In order to develop strategic readers, the main goal of strategy instruction should be to employ a wide range of strategies in combination rather than instruction in a single strategy (Anderson, 1999; Bimmel, 2001). This study sets out to explore the effects of combined strategy instruction on students' reading comprehension. It will also examine the beliefs and perceptions of students and teachers about the use of reading strategies. The findings may be of benefit to Our University, School of Foreign Languages in terms of providing new insights for the syllabus.

Reading is a complex system of deriving meaning from a text, which involves skills like inferencing, guessing and prediction. Analysis of the reading process raises awareness of the demands of different texts and the need for strategy use to meet those demands. Three reading models, the bottom-up, top-down and interactive approaches, have been described to explain how reading occurs (Urquhart & Weir, 1998). According to Anderson (1999), the bottom-up process of reading is a piece-by-piece mental decoding of the information in the text. Readers start processing information from the smallest units (e.g., letters, words, sentences), decode them to sound, recognize words, and decode meaning (Carrell, 1998a; Grabe & Stoller, 2002). In contrast to the bottom-up model, in the top-down model the reader's main aim is to comprehend the overall meaning of the text. Readers start with the whole language, such as their background knowledge and their predictions, aiming for the overall comprehension of the text (Anderson, 1999; Grabe & Stoller, 2002). The interactive model was developed by theorists as a result of criticism against the bottom-up and top-down models. The interactive model provides a compound of bottom-up and top-down models (Carrell, 1998b). It emphasizes both what is on the written page and what a reader brings to it. Several studies have shown that proficient readers employ top-down and bottom-up processing simultaneously, whereas less proficient readers depend primarily on bottom-up processing (e.g., Auerbach & Paxton, 1997; Carrell, 1998b; Eskey, 1998). Schema theory is important in explaining how prior knowledge contributes in the acquisition of new knowledge. According to the theory, prior knowledge is stored in schema and later it is used to assist the reader to fill gaps in the new knowledge (Carrell, 1984). The crucial role of background knowledge on reading comprehension is highlighted by Anderson (1999) and reading problems related to the lack of schema were emphasized in Carrell's study (1987). Studies conducted with proficient and non-proficient readers revealed that proficient readers are reported to be making more use of their background knowledge and a higher frequency of reading strategies than non-proficient readers (e.g., Anderson, 1999; Janzen, 2002). According to Anderson (1991), reading strategies are conscious actions that learners take to improve their

language learning. Many reading researchers classify reading strategies into two main groups: cognitive and meta-cognitive. The results of a study conducted by Carrell, Pharis and Liberto (1989) show that metacognitive strategy instruction was effective in enhancing reading comprehension. Bimmel (2001) stated that reading comprehension instruction should aim at developing both cognitive and meta-cognitive competence. He further indicated that if students are given only separate reading strategy instruction, they will not be able to achieve reading comprehension successfully. Strategies are related to each other and therefore should be viewed as a process and not a singular isolated action (Anderson, 1999). A study conducted to find out whether poor and good readers make use of different reading strategies showed that good readers use a wider range of strategies and they determine the strategies according to their needs and interests. This suggests that students should have knowledge of a wide variety of reading strategies. Thus, they will be able to decide which strategy meets their learning styles and goals. Bimmel (2001) points out that not every strategy is equally useful and suitable for every student, so students should observe their reading processes and when an obstacle occurs they should be able to shift from one strategy to another while performing their reading tasks. Students must monitor their reading processes and choose reading strategies that are appropriate for them (Carrell et al., 1989; Casanave, 1988). In order to be able to shift from one strategy to another, students should be taught a wide set of strategies. Reading strategies can be taught explicitly by providing guidance on the use of the strategy (Chamot & O'Malley, 1994). The teacher names the strategy, and explains how it is used with a specific task. It would be beneficial to instill some rationale for the necessity of strategies in trying to comprehend a text. Bimmel (2001) emphasizes that strategy instruction should provide students with a wide repertoire of strategies and that students should be asked to use strategy combinations which they find to be useful for a particular activity.

Statement of the Problem Researchers continually attempt to understand the factors affecting success in reading comprehension. Studies conducted on reading comprehension have indicated that reading strategy instruction is an effective way of enhancing reading comprehension (e.g., Auerbach & Paxton, 1997; Bimmel, 2001; Bimmel & Schooten, 2004; Block, 1992; Goodman, 1998). Within the literature a variety of studies that examined strategy use can be found (Grabe & Stoller, 2002; Grellet, 1981; Koda, 2005). As no one strategy can fit the needs of students and as different types of texts require different strategies (Bernhardt, 1998; Eskey, 1998; Janzen, 2002; Masuhara, 2003), a combined set of reading strategies should be given to the students. Thus, students will develop the ability to decide which strategies are appropriate with different text types. Although evidence from empirical research for the effectiveness of reading strategies and combined strategy instruction in L1 exists, there is a lack of research conducted on the effectiveness of combined strategy instruction in the L2 setting (Grabe, 2004). Because the research on combined strategy instruction is limited in L2 settings, information is mainly obtained from the studies conducted on L1 reading. This study intends to investigate the effectiveness of combined reading strategies in the L2 setting. At our University, School of Foreign Languages, students are required to take reading courses in order to be prepared for the academic reading they will encounter in their future university courses. It is crucial for the students to develop reading strategies and techniques which will aid in learning, understanding and retaining concepts. However, in spite of their participation in reading courses, students still perform badly on reading comprehension activities and their results on reading comprehension tests are unsatisfactory.

The literature would suggest that there is a need to train the students to use reading strategies effectively in order to improve efficiency in reading courses. Reading strategies should be incorporated into the curriculum so that the students will be well equipped to deal with the language demands of their continuing academic study.

The purpose of this study will be to investigate the effectiveness of combined reading strategy instruction and then to explore our University, School of Foreign Languages teachers' and students' perceptions about reading strategies and strategy instruction.

### **Significance of the Study**

Although there has been much research conducted on combined strategy instruction, little research has focused on combined strategy instruction in an L2 setting (e.g., Carrell et al., 1989; Kern, 1989) and none of the research has explored the effects of combined strategy instruction in an EFL setting. The data obtained from this study will provide empirical evidence as to the effects of combined reading strategy instruction in an EFL setting. This study may also contribute to the literature by revealing tutors' and students' perceptions of how combined reading strategies are effective in promoting reading skills. Since the use of combined reading strategies in L2 is not only a local issue, it is hoped that the findings of this study will be of guidance to other educational institutions. This study may provide data for the reconsideration of the approach applied in reading courses at our University. It may provide additional insights on reading skills, and data that will lead to the reconsideration of the curriculum objectives related to reading courses. Moreover, it may assist the school in planning ways to incorporate combined reading strategies into the curriculum. This study also sets out to reveal teachers' perceptions about reading strategies, and determine to what extent they encourage reading strategies.

The results of the study may be valuable for my institution, as it may raise awareness for the teachers in understanding that they have a role in promoting learners' use of reading strategies.

### **Reading Strategies Research**

There is a general agreement that strategy training in reading strategies improves comprehension of readers. Silberstein (1994) emphasizes that in order to promote successful reading teachers should present reading strategies not only at high level English classes but also at beginning proficiency level classes. There are many studies in the literature that have concentrated on reading strategies and their effects on overall reading comprehension. Carrell et al. (1989), for example, examined the effects of meta-cognitive strategy instruction on reading comprehension. Intermediate level ESL students from varied native language backgrounds were the participants in the study. Participants were trained in either semantic mapping or the experience-text-relationship method. In semantic mapping training, students were asked to think of ideas related to the topic. This brainstorming made the students use their prior knowledge. As the students read the text, they altered their semantic maps accordingly. Thus, new information was integrated with prior knowledge. In the experience-text-relation method, the teacher first asked questions and guided the students to activate their background knowledge and make predictions about the text. While reading the text, students stopped at appropriate points to discuss the text and determine whether their predictions were confirmed.

A study by Palincsar & Brown (1984) also provided students with a set of strategies. They taught students four reading strategies: summarizing, questioning, clarifying and predicting. The study

reported that strategy training was effective in enhancing the reading ability of the students. However, this study was conducted with native speakers of English, not in an L2 setting. There has been a gap in the literature about the effects of combined reading strategy instruction in the EFL setting. Therefore, the current study will be a unique one in this respect. By providing EFL readers with a set of specific strategies this study examines the effectiveness of combined strategy instruction in fostering students' reading comprehension.

Finally, when the students finished reading, the teacher guided the students to relate ideas from the text to their own experiences.

Both groups showed enhanced reading comprehension, in comparison to a control group. In other words, the results of this study showed that metacognitive strategy instruction was effective in enhancing reading comprehension.

### **CONCLUSION**

In this research, the background of the study, statement of the problem, research questions, and significance of the problem have been discussed. The next chapter reviews the literature on reading, reading strategies, good reader strategy use, teaching reading strategies, strategic learners, and research on reading strategies. In the third chapter, the research methodology, including the participants, instruments, data collection and data analysis procedures, is presented. In the fourth chapter, data analysis procedures and findings are presented. The fifth chapter is the conclusion chapter which discusses the findings, pedagogical implications, limitations of the study, and suggestions for further research.

### **REFERENCES**

1. Abraham, R. G., & Vann R. J. (1990). Strategies of unsuccessful language learners. *TESOL Quarterly*, 24, 177-198.
2. Aebersold, J. A., & Field, M. L. (1997). *From reader to reading teacher: Issues and strategies for second language classrooms*. New York: Cambridge University Press.
3. Alderson, J. C. (1984). Reading in a foreign language: A reading problem or a language problem? In J. C. Alderson & A. H. Urquhart (Eds.), *Reading in a foreign language* (pp. 1-27). London: Longman.
4. Anderson, N. J. (1991). Individual differences in strategy use in second language reading and testing. *Modern Language Journal*, 75, 460-472.
5. Anderson, R. C., & Pearson, D. P. (1998). A schema-theoretic view of basic processes in reading comprehension. In P. L. Carrell, J. Devine & D. E. Eskey (Eds.), *Interactive approaches to second language reading* (pp. 37-55). New York: Cambridge University Press.
6. Anderson, N. (1999). *Exploring second language reading: Issues and strategies*. Canada: Heinle & Heinle.

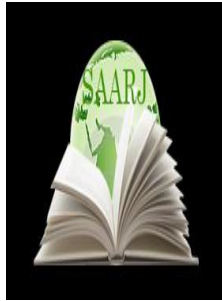

**ACADEMICIA**  
**An International**  
**Multidisciplinary**  
**Research Journal**  
 (Double Blind Refereed & Peer Reviewed Journal)



**DOI: 10.5958/2249-7137.2021.01198.8**

## ADVANTAGES AND DISADVANTAGES OF INTERACTIVE PRONOUNCING METHODS WHILE TEACHING PRONUNCIATION

**Nosirova Umida\*; Yuldosheva Vazira\*\***

\*Teacher,  
 State World Languages University,  
 UZBEKISTAN

\*\*Fourth year student of Uzbekistan State World Languages University,  
 UZBEKISTAN.

### ABSTRACT

*This paper presents a research carried out to x-ray the effects of using interactive multimedia on the English language pronunciation performance of pupils in the Nigerian primary School. The simple observation technique and a well-structured questionnaire were used coupled with class test to show whether the effect is negative or positive. Pupils from grade one to grade five were randomly selected and all the class teachers responded appropriately to the questionnaires administered to them. A well-structured formative test was also given to the pupils in order to ascertain the status of effect and the level of impact of interactive digital multimedia on English Language pronunciation performance of pupils. This paper illustrates that adopting the interactive multimedia technology in education makes it possible to achieve effective teaching and training in multiple domains which was not possible in the traditional text based environment.*

**KEYWORDS:** *Interactive Digital Multimedia, English Language Pronunciation, Performance.*

### INTRODUCTION

#### **Theoretical Basis of teaching pronunciation**

Pronunciation is important in English as communication purpose because, if we mispronounce a word, it will lead into misunderstanding. Pronunciation is how the way we pronounce the word. Unfortunately, some English learners think that basic vocabulary and grammar are enough for communicative with English native speaker, but they are wrong. We need to pronounce well so people can understand what we are talking about. Audio visual media is one of media that can be

used as the tool in learning and teaching process, but it is not enough to make the students interest in class, teacher need something special here. One of the way that teacher can use is game. There are so many kinds of games and teacher can combine it with audio visual media. This combination can create an interactive class. This article is about Teaching Pronunciation by Using Games and Audio Visual Media, to know how to used games and audio visual media then combine it in learning. It is important because by using games and audio visual media in fact are able to create fun and relax situation of the students in learning process, the students more able to answer teacher's questions and more active to give suggestion to the teacher. They will not refuse to read dialogue in front of the class, cheerful, pay attention to the learning, and active during the teaching and learning process.

### **Practical Aims of the Subject**

Pronunciation is important form of communication, wrong pronounce can make the mistake of words' meaning. Most of the students have difficulties in learning pronunciation, they feel bore and lazy to learn it. They also afraid of making mistake when they pronounced the words and they still passive in the classroom. It makes students achievement in learning English low.

At school, students are lack of pronunciation while Nurhayati (2008), states that the pronunciation means knowledge of knowing to produce word which is very essential in oral communication. When speakers mispronounce some words or phrases, people can be misunderstanding. To reduce it, the teacher must equip the learner with English certain degree accuracy and fluency in understanding, responding and in expressing himself in the language in speech in other the learners communicatively in using the language. In pronunciation, there are vowels and consonant.

### **Educational aims of the Subject**

In relation to the language teaching, there are some ways that can be used to motivate the students in learning English. English teacher can use some possible and successful media, strategies, approach, or methods for the classroom activities such as audio, audio visual, game, picture, etc. For the students, learning English as a foreign language is not easy.

One of the effective media in teaching pronunciation is by using audio media. Audio media has very significant roles to motivate the students to learn pronunciation. Those ways of teaching and learning will not make students bored. But it is not enough. Audio visual media is very kind of usual in daily class. In this article, teacher can combine it with something interesting, something fun. If we talk about something fun, it must be relate with "games". Games provide language teachers with many advantages when they are used in classroom. One of these advantages is that learners are motivated to learn the language when they are in a game. Mc Callum (1980:9) emphasizes this point by suggesting that "games automatically stimulate student interest, properly introduced game can be one of the highest motivating techniques." Avedon (1971; QuotedinDeesri, 2002:2) further argues that "games spurmotivation and students get very absorbed in the competitive aspects of the games; moreover, they try harder at games than in other courses". In other words, games stimulate students' interest in classroom activities and as a result, students become motivated and willing to learn. In this article, we will discuss about how to combine games and audio visual media. Pronunciation is the production of sound by using our speech organs for communication. According to Mahuda M. and Endang Sri. S (2011:1) says that "Pronunciation is the production of speech sound for communication". English

pronunciation has problem also, for example a native speaker of English most often have to grapple with the spelling system of the language as writer, words whose meaning and pronunciation are well-know have to be writer down, and it is this situation that native speakers become very conscious of the intricacies of the English spelling system. Only occasionally do we have attempted to write an unknown word. With non-native learners of English the predominant problem is usually how to pronounce an unknown word in a written text. According to Kenworthy Joanne, et.al (2002:97) says that “The English spelling system is rich in both regularities and irregularities which present problems to non-native learners (and to English-speaking children learning to write their language)”.

General observation suggests that it is those who start to learn English after their school years are most likely to have serious difficulties in acquiring intelligible pronunciation, with the degree of difficulty increasing markedly with age.

### **Pronouncing as a Process**

Historically, pronouncing skills have received less attention in language teaching than have the productive skills of speaking and writing. Die in part to a lack of knowledge about receptive skills, teachers often failed to devote explicit attention to devoting pronouncing abilities, assuming that comprehension would occur on its own. More recently, however, the profession has recognized that merely exposing learners to oral or written input is not sufficient and that explicit teaching of comprehension strategies is needed.

Pronouncing is an interactive process that goes on between the speaker and the speech, resulting in comprehension. The speech presents letters, words, sentences, and paragraphs that encode meaning. The speaker uses knowledge, skills, and strategies to determine what that meaning is.

Speaker knowledge, skills, and strategies include

- **Linguistic competence:** the ability to recognize the elements of the writing system; knowledge of vocabulary; knowledge of how words are structured into sentences
- **Discourse competence:** knowledge of discourse markers and how they connect parts of the speech to one another
- **Sociolinguistic competence:** knowledge about different types of speeches and their usual structure and content
- **Strategic competence:** the ability to use top-down strategies, as well as knowledge of the language (a bottom-up strategy)

The purpose(s) for pronouncing and the type of speech determine the specific knowledge, skills, and strategies that speakers need to apply to achieve comprehension. Pronouncing comprehension is thus much more than decoding. Pronouncing comprehension results when the speaker knows which skills and strategies are appropriate for the type of speech, and understands how to apply them to accomplish the pronouncing purpose.

### **Advantages and Disadvantages of interactive pronouncing methods**

#### **Teaching Pronunciation**

According to Kelly (2000:13), a lot of pronunciation teaching tends to be done in response to errors which students make in the classroom. It seems that the teaching is not planned before. He

adds that the fact that pronunciation tends to suffer from neglect may not be due to teachers lacking interest in the subject but rather to a feeling of doubt as to how to teach it. However, to make students able to speak fluently and their pronunciation achieve what the experts call as minimally intelligible, pronunciation instruction needs to be promoted to students. Moreover, in the standard of competence and basic competences of SMP students grade VII state that students need to master linguistic competences including pronunciation. It can be one of basic things that students need to master since pronunciation plays an important role in language teaching.

### **Games**

Games are student-focused activities requiring active involvement of learners. In Crookall's (1990) opinion, learner and teachers change their roles and relations through games and learners are encouraged to take active role in their learning process. As a result, games provide learners with a chance to direct their own learning. From an instructional view point, creating a meaningful context for language use is another advantage that games present. By using games, teachers can create contexts which enable unconscious learning because learners' attention is on the message, not on the language. Therefore, when they completely focus on a game as an activity, students acquire language in the same way that they acquire their mother tongue, that is, without being aware of it, Cross (2000:153).

Games bring real-life situations to the confinement of the classroom which provides learners with an opportunity to use the language. Celce-Murcia (1979:54) argues that "in games, language use takes precedence over language practice, and in this sense games help bring the classroom to the real world, no matter how contrived they may be. "To state this differently, by putting learners in real life situations, games make a connection with the real usage of language. There are many advantages of games such as the fact that they...

1. Focus students' attention on specific structures, grammatical patterns, and vocabulary items.
2. Can function as reinforcement, review and enrichment.
3. Involve equal participation from both slow and fast learners.
4. Can be adjusted to suit the individual age and language levels of the students.
5. Contribute to an atmosphere of healthy competition, providing an outlet for the creative use of natural language in a non-stressful situation.
6. Can be used in any language teaching situations and with all skill areas (reading, writing, speaking or listening).
7. Provide immediate feedback for the teacher.
8. Ensure maximum student participation for a minimum of teacher preparation.

### **Kinds of Games**

Teachers should be careful about choosing games if they want to make them advantageous. First of all, the teacher should decide on the purpose of a game. A game may seem appropriate and useful.

However, when its value is considered from the view point of foreign language teaching, it may have little or no purpose. Nedomová (2007:19) underlines the fact that we "should consider



whether the game-like activity is for children only to make the lesson more attractive and protect them from being bored or whether we tend to revise and practice some particular part of grammar, vocabulary, etc.” when they choose a game.

Considering the level of the game is equally important while choosing games. Teachers must decide whether the level of the game fits students’ language level because a game may become difficult when it is beyond the learners’ level or it may become boring when learners find it too easy to carry on. When a game’s value in grammar teaching is considered, teachers tend to use them for practice or to reinforce a specific grammatical aspect of language only if a game is suitable for learners’ level so that the grammatical knowledge can be used easily as they are playing the game.

Teachers should be well aware of their roles while using games in their classes. Since it is rather difficult to find a game that meets all the needs of the learners, careful preparation of the teacher is necessary. McCallum (1980:10) suggests that the teacher should organize the game before the instruction. The teacher may need some extra equipment or materials to play the game and most of the time these equipment and materials are not available in the classroom. Before explaining the rules to the class, the teacher should first understand how the game is played. Especially when working with children, the teacher should always be prepared to adapt the game to the given soft he class. After choosing the game, the teacher should explain its rules to the learners in a direct and non-complicated way. Especially for young learners, it may be necessary to use them other tongue because if these learners can not understand how to play the game, there is no educational purpose in playing it. Therefore, demonstrations may be beneficial because they can help young learners understand the rules clearly and easily. Moreover, the teacher is not recommended to interrupt a game to correct the mistakes of young learners. According to Celce-Murcia (1979:54), “interruptions should be as infrequent as possible so as not to detract from the student’s interest in the game. An alternative to immediate correction is to make note of errors and discuss them when the game is over”. In other words, as sudden interruptions may distract learners’ attention, it is better to wait until the game is over to discuss and correct the mistakes of the learners. In addition, appropriate class organization increases the success of a game. Many games require the class to be divided in to groups or pairs. This gives the teacher a chance to monitor the activity of the learners while they are playing the game. McCallum (1980:12) asserts that learners should be in the same team during the year because it both saves the teacher’s time and helps learners develop team spirit that promotes exchange of ideas among themselves. Pair work is also beneficial as it develops learners’ communication skills. In short, dividing class into pairs and groups enables learners to improve their language and communication skills while promoting competition among the teams or pairs. As such, the teacher may find more time to focus on students’ language development.

### **Media**

According YudhiMunadi (2013: 6) the word ‘media’ comes from Latin language namely “medius”, literally “middle”, “introductory” or “intermediate”. Because of the position in the center, it is also could be called as an introductory or conjunction, which is delivering or connecting something from one side to the other side. Thus, the purpose of the use media in learning process is to make learning process effective and efficient.

According to Wright (1976:1) many media and many styles of visual presentation are useful to the language learner. That is to say, all audio-visual materials have positive contributions to language learning as long as they are used at the right time, in the right place.

### **Audio Visual Media**

According to YudhiMunadi (2013: 56) audio-visual media is media that involves the senses of hearing and vision at the same time in one process. According to YudhiMunadi (2013: 113) the audio visual media can be divided into two types. The first type, equipped with sound and image equipment functions in a single unit, called pure audio visual media, such as movies, television and video. The second kind is not purely audio visual media that what we are familiar with slides, opaque, OHP and other visual equipment when given the sound elements of the recording tapes are used simultaneously in one time or the learning process.

In teaching English foreign language for primary students is not easy. The teachers should provide pleasant atmosphere to invite the motivation and interest of the students. The motivation and interest of students are very important in learning achievement. That is why we need motivational and interesting media in teaching English.

According to Hemei (1997:45). Students like it because video presentations are interesting, challenging, and stimulating to watch. Video shows them how people behave in the culture whose language they are learning by bringing into the classroom a wide range of communicative situations. Another important factor for teachers that makes it more interesting and enjoyable is that it helps to promote comprehension.

One of the first things that students should know in learning English is pronunciation. Knowing its pronunciation will also cover the knowing of its spelling, stressing and how to speak correctly and fluently in communication. Using audio visual will help students to learn English pronunciation easily and enjoying it. The students not only hear the sound but also see some interesting sights simultaneously. Teacher can use many kinds of audio visual to teach students in the class; such as MP3, Video Cassette, Cassette Recorder, Computer Program, Audio Book, or the teacher him/herself.

### **CONCLUSION**

Pronunciation instruction can be adjusted according to what level our learners belong to. One of the aims that students need to achieve is that they are able to develop the communication ability inform of spoken and written forms so that they can achieve functional level. Functional level means that students need to be able to overcome daily problems. The language that is used for that matter is not so complicated. It is considered to be simple. So, what teachers need to promote in pronunciation instruction is simple or basic activities for pronunciation.

In relation to the language teaching, there are some ways that can be used to motivate the students in learning Pronunciation. English teacher can use some possible and successful media, strategies, approach, or methods for the classroom activities such as audio, audio visual, game, picture, etc. For the students, learning English as a foreign language is not easy.

Using audio visual media has old and sometimes not work; now teacher can combine more than one way in teaching pronunciation. Add another activity. Ask the students watch the audio visual media such as a movie then make the games base on the movie will very affective. The class will

active, the students will happy and automatically the teaching and learning will achieve a good goal.

Using audio visual will help students to learn English pronunciation easily and enjoying it. The students not only hear the sound but also see some interesting sights simultaneously. Teacher can use many kinds of audio visual to teach students in the class; such as MP3, Video Cassette, Cassette Recorder, Computer Program, Audio Book, or the teacher him/herself.

#### **REFERENCES**

1. Abbas P. G (2012): The Significant Role of Multimedia in Motivating EFL Learners' Interest in English Language Learning. *I.J.Modern Education and Computer Science*, 2012, 4, 57-66.
2. Astleitner H. and C. Wiesner, "An integrated model of multimedia learning and motivation," *Journal of Educational Multimedia and Hypermedia*, 13, 3-21, 2004 Bax, S. (2000):
3. Putting technology in its place; ICT in modern foreign language learning. In Field, K. (ed.). *Issues in modern foreign language teaching*; London, Harvey press Bilash C (2012):
4. Importance and ways of correct English pronunciation. *Issues in modern foreign language teaching*; in Zöe Handley (2012)
5. Selecting technologies for use in the language classroom: Examining the added value of multimedia and interactive whiteboards Coombs, P.H. (1970).

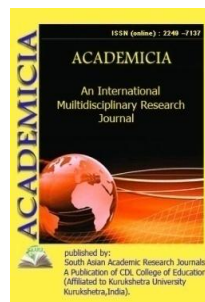

DOI: **10.5958/2249-7137.2021.01197.6**

## CONDITIONS FOR EFFECTIVE IMPLEMENTATION OF INNOVATIVE ACTIVITIES IN A PRESCHOOL EDUCATIONAL ORGANIZATION

**Muminov Shermuhammad Karimovich\***

\*Independent Researcher,  
Institute for retraining and advanced training of directors and,  
Specialists of Preschool Education organizations,  
Tashkent, UZBEKISTAN

### ABSTRACT

*The article addresses issues such as the effective conditions for the implementation of innovative activities in preschool education and their content. The ongoing seminars were devoted to identifying the optimal forms of interaction, developing the content of activities that would enrich the knowledge of parents on the issues of psychosocial development of the child. The effectiveness of the work, expressed in the intermediate results of monitoring, was coordinated by constant and purposeful psychological and pedagogical support of the participants of the innovation project. During the implementation of the innovation project, constant monitoring of the results of innovation activities was carried out. The effectiveness of the work, expressed in the intermediate results of monitoring, was coordinated by constant and purposeful psychological and pedagogical support of the participants of the innovation project.*

**KEYWORDS:** *Innovative Activity, Creative Process, Preschool Organization, Innovative Project, Educator, Parents.*

### INTRODUCTION

In pedagogy, the concept of "innovative activity" has a wide semantic range. This is a purposeful pedagogical activity based on comprehending one's own pedagogical experience by comparing and studying the educational process in order to achieve better results, obtain new knowledge, introduce new pedagogical practice; it is a creative process for planning and implementing pedagogical innovations aimed at improving the quality of education. This is a socio-pedagogical phenomenon that reflects the creative potential of a teacher-educator. Currently, innovative activity is one of the decisive factors in the development of a modern preschool education institution. Each teaching staff has the right to such activities. But in this case, he must take on

certain obligations for the preparation and organization of the innovation, since children become the object of the pedagogical initiative.

State of preschool educational organizations in Tashkent is working in an innovative project "Implementation of a model for the formation of effective parenthood as a condition of social well-being of pupils of preschool educational organizations. institutions ". The work on the innovative project is carried out in the "teacher-child-parent" triad. The implementation of an innovative project involves the gradual formation of all structural components of the parental position in the families of pupils: from a conscious through a responsible one to an effective parental position. According to the general opinion of experts, family education is unique and unique in its effect. It is interfamilial relations that mediate the social well-being of the child, since they are primary, long-lasting, related by kinship and affect the age sensitivity of children. At the same time, modern teachers and psychologists emphasize that a preschool institution is the first institution that enters into open interaction with the families of pupils. And the teacher often becomes a socially significant adult for the child. Based on the fact that the social well-being of a preschool child is directly interconnected with the characteristics of child-parent interaction, the goal of teachers was to establish close and trusting (partner) interaction with various categories of families of pupils. Large, young, single-parent families, as well as families in a socially dangerous situation have become participants in our innovative project. Building interaction with this category of families has a number of specific features due to the low quality and content of family education, the manifestation of alienation of parents and children, the family's unpreparedness for a healthy lifestyle, and a low level of pedagogical culture. At the same time, the use of the experience of a family with positive parent-child relationships contributes to the prevention and correction of social ill-being.

## **MATERIALS AND METHODS**

During the work on the innovative project, methodological, psychological and pedagogical support of all participants was carried out. Diagnostics of teachers at the preparatory stage revealed that among the project participants there is an innovative personality potential associated with the following main parameters: creative ability to generate and produce new ideas and ideas, and most importantly - to design and model them in practical forms; openness of the personality to a new one, different from one's own ideas, which is based on personality tolerance, flexibility and panoramic thinking; cultural and aesthetic development and education; willingness to improve their activities, the presence of internal means and methods that ensure this readiness; developed innovative consciousness (the value of innovative activities in comparison with traditional ones, innovative needs, motivation for innovative behavior).

By the teacher's readiness for innovative activity, it is customary to understand the formation of the personal ones necessary for this activity (great working capacity, the ability to withstand the action of strong stimuli, high emotional status, readiness to creativity) and special qualities (knowledge of new technologies, mastering new teaching methods, the ability to develop projects, the ability to analyze and identify the causes of shortcomings) [1, p. 17]. In the work on the project in a preschool institution, a special place was given to increasing the level of professional competence of teachers as one of the criteria for the effectiveness of project activities. An important direction in the implementation of project activities is working with teachers through constructive communication in the implementation of individual research activities. Collective discussion of the content side of pedagogical research allowed us to

determine a wide field for research activities, where attention is paid to organizational and managerial support, methodological support, psychological support, provision of social, pedagogical and legal assistance, the formation of partnerships, the preservation of family traditions, the activation of paternal and grandparent education.

## **RESULT AND DISCUSSION**

Methodological support for the professional growth of educators using the ideas of tutoring has also yielded positive results; all teachers have acquired the skills to work with e-mail, educators and specialists have created individual methodological piggy banks; members of the creative group are more involved with colleagues. The ongoing seminars were devoted to identifying the optimal forms of interaction, developing the content of activities that would enrich the knowledge of parents on the issues of psychosocial development of the child. At the round table meetings, teachers analyzed the results of monitoring innovative activities, shared their experience in interacting with parents, and creative ideas. At the meetings of the creative group, which we held once a quarter, the project participants discussed aspects related to individual research activities, determined the priority areas of pedagogical diagnostics and correction within the designated topics. Scientific and methodological support of teachers' activities is of particular importance in the work on an innovative project. Participation in various kinds of conferences, seminars, webinars, the possibility of online communication with scientific consultants, raises the efficiency of work to a new level.

During the implementation of the innovation project, constant monitoring of the results of innovation activities was carried out. The effectiveness of the work, expressed in the intermediate results of monitoring, was coordinated by constant and purposeful psychological and pedagogical support of the participants of the innovation project. This type of support in the "parent-teacher" dyad allowed us to vary pedagogical techniques to improve the psychological culture of parents, as one of the criteria for effective parenting, as well as outline further promising areas of methodological work with teachers based on the results obtained.

The effective solution of problems aimed at creating conditions for the successful socialization of pupils by increasing the psychological culture of parents in the process of partnership between the preschool institution and the family and the implementation of activities, the content of which contributes to the formation of effective parenting, is facilitated by the reference to the following criteria: social well-being of preschool children; manifestation of effective parenting; increasing the level of professional competence of teachers; increasing the social activity of participants in innovative activities; improving the quality of management of innovative processes in the institution of preschool education. In this aspect, promising is the innovative transformation of the educational process of a preschool institution through the optimization of all its subjects of interaction [2, p.194].

## **CONCLUSION**

Thus, the priority conditions for the effective implementation of innovative activities in a preschool institution are the validity and relevance of the project topic, taking into account the specifics of the educational process as a whole; the use of effective management mechanisms of coordination and leadership in the implementation of innovation; purposeful increase in the professional competence of educators by achieving the goals and objectives of the innovative project, taking into account individual interests and needs.

**REFERENCES**

1. Kuznetsov E.B. Implementation of innovations is a prerequisite for reforming preschool educational institutions // Management of a preschool educational institution. - No. 6. - 2007. - S. 16-18.
2. Pedagogical innovations: traditions, experience, prospects: materials of the IV International scientific and practical conference, Vitebsk, December 5, 2013 / Vit. state un-t; editorial board: N.A. Rakov [and others]. –Vitebsk: Voronezh State University named after P.M. Masherova, 2013 .--282p.



**ACADEMICIA**  
**An International  
 Multidisciplinary  
 Research Journal**  
 (Double Blind Refereed & Peer Reviewed Journal)

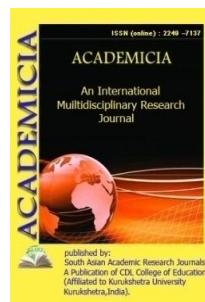

**DOI: 10.5958/2249-7137.2021.01196.4**

**PROFESSIONAL PERSONAL DEVELOPMENT IN THE EDUCATIONAL  
 SPACE**

**Jumanazarova Zuxra Kosimjonovna\***

\*Namangan Engineering-Technology,  
 Institutes, Namangan, UZBEKISTAN

**ABSTRACT**

*This article reveals the essence of issues such as professional development of the individual in the educational environment, approaches to personal development, abilities, special and general abilities, talents. Inclinations are natural prerequisites that are a condition for the development of abilities, not only in the sense that they give originality to the process of their development, but also in the sense that, within certain limits, they can determine the content side and influence the level of achievement.*

**KEYWORDS:** *Personality, Individuality, Learning Environment, Subject, Personality Development, Ability Professional Development, Individual, Temperament.*

**INTRODUCTION**

*In psychology, there are many definitions of personality. In relation to a person, the concepts of "individual", "personality", "subject of activity", "individuality" are used. Often these concepts replace each other. So, speaking about personality, researchers can emphasize the individual characteristics of a person or characterize his individuality.*

*Most Russian psychologists include in the concept of personality a complex of natural properties, the psychological ambiguity of which is determined by the system of social relations in which the person is included.*

*A.G. Kovalev identifies the following substructures in the structure of personality:*

- Temperament (structure of natural properties);*
- focus (system of needs, interests and ideals);*
- Abilities (a system of intellectual, volitional and emotional properties).*



---

## MATERIALS AND METHODS

*V.N.Myasishchev characterizes the unity of personality by orientation, level of development, personality structure and dynamics of neuropsychic reactivity (temperament). The personality structure is a more particular characteristic of the personality, which includes motivation, attitudes and personality tendencies. K.K. Platonov identifies the following levels in the personality structure:*

- *Socially determined characteristics (orientation, moral qualities);*
- *Biologically determined characteristics (temperament, inclinations, instincts, the simplest needs);*
- *experience (volume and quality of existing knowledge, skills, abilities and habits);*
- *Individual characteristics of various mental processes.*

*According to B.M.Teplov's definition, abilities are individual psychological characteristics that distinguish one person from another and are related to the success of an activity. When talking about abilities, keep in mind the following:*

1. These are the features that distinguish one person from another. B. M. Teplov considers the most important sign of abilities to be the individual uniqueness of productive activity, the originality and uniqueness of the techniques used in the activity.
2. Abilities serve the successful performance of the activity. Some researchers, for example N.A.Menchinskaya, believe that it is more logical to talk about learning as success in acquiring skills, knowledge, and skills.
3. Abilities are characterized by the possibility of transferring the developed skills and abilities to a new situation. In this case, the new task should be similar to the previously solved tasks not by the sequence of methods of action, but by the requirements for the same mental properties of a person.

## RESULT AND DISCUSSION

Abilities are based on inclinations. Inclinations are natural prerequisites that are a condition for the development of abilities, not only in the sense that they give originality to the process of their development, but also in the sense that, within certain limits, they can determine the content side and influence the level of achievement. The inclinations include not only anatomical, morphological and physiological properties brain, but also mental properties to the extent that they are directly and directly determined by heredity.

Ability is a dynamic concept. They are formed, developed and manifested in activity. General and special abilities.

Special abilities - the ability for certain types of activity (mathematical ability, musical ability, teaching, etc.).

General abilities are the ability to develop special abilities.

Giftedness is a qualitatively unique combination of abilities, on which the possibility of achieving more or less success in performing one or another activity depends.

The concept of ability is usually associated with mental activity. But there are no grounds for such a narrow interpretation of abilities, although traditionally it is the sphere of mental activity that has been studied and continues to be studied in connection with abilities.

High general mental development may not be accompanied by the manifestation in any special area of abilities or any kind of special giftedness. However, the manifestation and achievement of high special abilities, special giftedness is unthinkable without the presence of general abilities, general giftedness.

As reality shows, the priority of the student's creative development, highlighted at the level of state policy in the field of education, is still often far from real implementation.

However, the opinions of psychologists who conducted long-term experiments coincide: the properties of the human psyche, the basis of the intellect and the entire spiritual sphere arise and are formed mainly in preschool and primary school age, although the results of development are discovered later. Lack of creativity, as a rule, becomes an insurmountable obstacle in professional education, when it is required to solve non-standard problems, interpret materials from primary sources, etc.

In the psychology of professions, one of the acute problems is the interaction of multifaceted factors that determine the professional development of the individual. The main factors include the natural environment (geographic location of a person and climatic conditions), biological and social factors, one's own personality activity and a random confluence of circumstances and events. The interaction of these factors occurs against the background of age-related changes during most of a person's life.

To solve the problems of professional development of the individual, due to the need for professional self-determination and choice of a profession, professional education and advanced training, professional growth and career, professional adaptation and reaching the heights of professionalism, as well as many others, it is necessary to determine the leading semantic factors.

These include age-related changes in a person over time, development and education of the personality.

Professional development develops in time from the beginning of the formation of professional interests and inclinations until the end of active professional activity. Age-related changes in a person over a long period of life are an important basis for the professional development of an individual. The system of continuous vocational education is of great importance in ensuring and supporting professional development. General education is a leading factor in personal development and a prerequisite for successful professional development.

Thus, the movement of an individual in a developing professional space is determined by the following three factors:

- age-related changes that determine periods of personality development;
- the system of continuous education;
- leading professionally oriented activities.

**CONCLUSION**

The resultant interaction of these three factors is the professional formation of the personality - its movement in the professional and educational space and time of professional life. It covers the period of personality development from the beginning of the formation of professional interests and inclinations to the end of a professional biography.

**REFERENCES**

1. Kovalev A. G., Myasishchev V. N. Mental characteristics of a person. T. 2. Abilities / A.G. Kovalev - L.: LSU, 2014-98p.
2. Platonov K.K. Problems of abilities / KK. Platonov - M.: Enlightenment, 2013-45 p.
3. Teplov B.M. Problems of individual differences / BM Teplov. Teplov - M., 2014 - 33p.

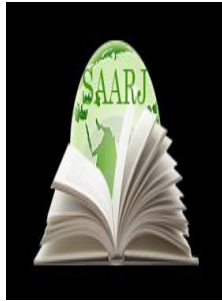

**ACADEMICIA**  
**An International**  
**Multidisciplinary**  
**Research Journal**  
 (Double Blind Refereed & Peer Reviewed Journal)



**DOI: 10.5958/2249-7137.2021.01195.2**

## INTEGRATED APPROACH TO ORGANIZATION OF INDEPENDENT WORK OF STUDENTS

**Nurova Oliya Salomovna\***

\*Senior Lecturer of the Institute,  
Counter Engineering Economics,  
Karshi city, UZBEKISTAN

### ABSTRACT

*The article highlights the essence of the integrated approach to the organization of independent work of students, the fact that independent work is an important part of the educational process. It is possible to complete assignments by a small group of students. Before the project is completed, roles are assigned in the group and each student completes his part of the task. This form of performing independent work is preparation for work in a team.*

**KEYWORDS:** *Independent Work, Creative Initiative, New Forms Of Education, Creative Activity, Student, Teacher, Integrative Approach.*

### INTRODUCTION

*One of the leading requirements of the State Educational Standard is the development of students' independent work skills.*

*The implementation of this requirement dictates the need for students to manifest their creative initiative, foster their need for self-education, strive to increase the level of their theoretical training, as well as to improve the skills of self-education.*

### MATERIALS AND METHODS

*Independent work is one of the most important components of the educational process. Independent work is the planned work of students, carried out according to the assignment and with the methodological guidance of the teacher, but without his direct participation. The teacher only organizes the cognitive activity of students, while the student himself carries out cognition.*

*Independent work completes the tasks of all types of educational work. It contributes to:*

- *deepening and expanding knowledge;*
- *the formation of interest in cognitive activity;*
- *mastering the techniques of the cognition process;*
- *the development of cognitive abilities.*

*To increase interest in students' independent work, it is necessary to improve existing and find new forms of education.*

*As an experiment, we decided to use an integrated approach. Namely, students of the specialty Programming in computer systems should be offered tasks for independent work simultaneously in two disciplines - the discipline Effective behavior in the labor market and MDK.03.01 Software development technology.*

## **RESULT AND DISCUSSION**

*Independent work includes reproducing and creative processes in the student's activity. Depending on this, three levels of independent educational activity of students are distinguished:*

- 1) Reproductive (training) - independent training work is performed according to the model. The student's cognitive activity is manifested in recognition, comprehension, memorization. The purpose of this kind of work is to consolidate knowledge, develop skills;*
- 2) Reconstructive - in the course of such independent work, decisions are restructured, a plan, abstracts, annotated. Abstracts can be performed at this level;*
- 3) Creative, search - creative independent work requires an analysis of a problem situation, obtaining new information; the student must independently make a choice of means and methods of solution (project assignments, coursework and final qualification works)*

An integrated approach involves completing tasks related to the third level. This level involves the use of the project method, since it is always focused on the independent activity of students - individual, pair, group, which they perform for a certain period of time.

Tasks for independent project activities of students are developed jointly by teachers of two disciplines. For example, disciplines Effective behavior in the labor market and MDK.03.01 Software development technology. Independent work of students is organized according to the following plan:

1. Students receive assignments of different types. For example:
  - Create a presentation using Microsoft PowerPoint on the topic "Sign language".
  - Develop a version of the test using Microsoft Excel on the topic "Types of temperament".
  - To develop a program in the Delphi 7 environment "Correspondence of temperament and type of professional activity" (tasks of this type are the most preferable and often used - the topics are varied).
2. Based on the task received, the student develops an algorithm for solving the problem.
3. The task is performed according to the developed algorithm.
4. The last stage of work is the student's defense of the project (open defense is possible).

The process of completing such tasks takes place in the form of a business game:

- The teacher of the discipline Effective behavior in the labor market acts as a customer of the project and a consultant on psychological issues.
- Teacher MDK.03.01. Software Development Technologies - in the role of project development leader.
- The student is in the role of the performer.

It is possible to complete assignments by a small group of students. Before the project is completed, roles are assigned in the group and each student completes his part of the task. This form of performing independent work is preparation for work in a team. This is especially important for students of the specialty "Programming in computer systems". This form of organization of independent work simulates his subsequent professional activity.

An integrated approach to the organization of independent work has another big plus - the results of students' project activities can be used to conduct classes in the discipline Effective behavior in the labor market, as well as in extracurricular work by group curators.

The application of this approach is universal and can be applied in teaching any specialty - it all depends on the experience, qualifications and creative potential of the teacher. The technology of educational design makes it possible to form students' skills in effective behavior in the labor market, stimulates the development of key competencies of students, forms the ability for self-employment and obtaining additional (reserve) professional competencies.

## CONCLUSION

Correctly organized independent work of students is focused on the development of their personal and educational resources in order to enhance their adaptive potential and increase the chances of effective employment and the formation of a professional career.

## REFERENCES

1. Bashmakov A.I. Intelligent information technologies: textbook. allowance / A.I. Bashmakov - M. : Publishing house of MSTU im. N.E. Bauman, 2005 .-- 304 p.
2. Kolechenko A.K. Encyclopedia of Pedagogical Technologies: Textbook. allowance / A.K. Kolodchenko - SPb. : KARO, 2006 .-- 368 p.
3. Kruglikov G.I. Methods of vocational training with a workshop: Textbook. allowance / G.I. Kruglikov - M. : Publishing Center "Academy", 2007. - 288 p.
4. Purin V.D. Pedagogy of secondary vocational education. / V.D. Purin - Rostov n / a. : Phoenix, 2006. - 256 p.

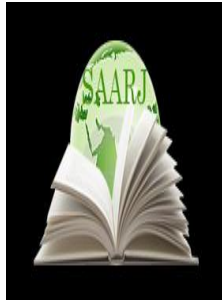

**ACADEMICIA**  
**An International  
 Multidisciplinary  
 Research Journal**  
 (Double Blind Refereed & Peer Reviewed Journal)



**DOI: 10.5958/2249-7137.2021.01194.0**

## USE OF INNOVATIVE PEDAGOGICAL TECHNOLOGIES IN TEACHING ECONOMIC DISCIPLINES

**Kanglibekov Kuatbai\***

\*Applicant for the Institute of Pedagogical Innovation,  
 Retraining and Advanced Training of Leading and,  
 Pedagogical Personnel of Professional Education,  
 Tashkent, UZBEKISTAN

### ABSTRACT

*The article covers issues such as the teaching of economics in vocational education institutions, the content of the use of pedagogical technologies in their teaching. A cluster is a graphical form of organizing the presentation of information, when the main semantic units are highlighted, which are fixed in the form of a diagram with the designation of all connections between them. One of these methods is the "Fish Bone" method. This method is based on a schematic diagram in the form of a "fish skeleton", in the head of which the indicated problem is placed, the elements of the problem are written on the upper bones, the results of the study are recorded on the lower bones.*

**KEYWORDS:** *Market Economy, Economics, Pedagogical Technology, Case Technology, Small Group Work, Creativity, Fish-Bone Method.*

### INTRODUCTION

In modern economic conditions of management on the labor market, highly qualified specialists are more and more in demand who are able to carry out the tasks of their self-development and self-improvement, who are able to acquire the necessary knowledge and acquire the necessary competencies themselves. Society sets new tasks for professional education to train a modern specialist who will be not just a professional in a particular field, but a person, a citizen who has such socially necessary personal qualities as tolerance, professional responsibility, creativity of thinking, culture of health and a healthy lifestyle. life.

At the same time, a special role is assigned to innovative pedagogical technologies, since only an innovative approach to the process of teaching and upbringing will make it possible to form students' professional competencies of a future specialist.

---

## MATERIALS AND METHODS

In professional educational institutions (colleges, technical schools) of the Republic of Uzbekistan, for many years, he has been training specialists in economic profile, paying great attention to the quality of training students. The teaching staff of our college is constantly working on the implementation and use of innovative teaching technologies.

Currently, a variety of educational technologies are being implemented in secondary vocational education. The analysis showed that the modern and most demanded of our teachers are the following: technology for the development of critical thinking, game technologies, case technologies, problem-developing education, natural-reflective technology for the development and self-development of a person, information and communication technologies, and others.

The choice of certain teaching methods depends on many factors: on the didactic goals of the lesson, on the discipline being studied and the professional module, on the level of training of students and the professional competencies of teachers.

At the moment, we consider it quite relevant for ourselves to introduce and use the technology of critical thinking in the learning process.

### Result and discussion

One of these methods is the "Fish Bone" method. This method is based on a schematic diagram in the form of a "fish skeleton", in the head of which the indicated problem is placed, the elements of the problem are written on the upper bones, the results of the study are recorded on the lower bones. The ways of solving the posed problem, as a result of research, are written in the tail of the fish. The use of this method develops students' ability to analyze the text, highlight the main events, concepts, definitions and look for the reasons for their relationship, generalize and draw conclusions. The main goal of the method is to stimulate creative and develop critical thinking in students. We use the "Fish Bone" method in teaching the disciplines of Economics, Economic Analysis, Taxes and Taxation.

Another, no less interesting method of critical thinking used in the classroom is the "cluster method". A cluster is a graphical form of organizing the presentation of information, when the main semantic units are highlighted, which are fixed in the form of a diagram with the designation of all connections between them. The cluster can be designed as a model of a planet with satellites. In the center is the main economic concept, term, thought, on the sides are designated large semantic units, connected to the central concept by straight lines. And already around the "satellites" of the central planet there may be less significant semantic units that more fully reveal the topic and expand logical connections. Depending on the method of organizing the lesson, the cluster can be drawn up on the board, on a separate sheet or in a notebook for each student when completing an individual assignment. So, for example, with the help of a cluster in the lesson in the discipline "Fundamentals of accounting", students systematize and generalize their knowledge on the characteristics of the balance sheet, and in the discipline "Economic analysis" they form a scheme of factor analysis of economic indicators. The cluster method contributes to the systematization and generalization of educational material.

Experience shows that when solving economic problems, the most effective is the use of role-playing games. When carrying out a role-playing game, one or another production situation is imitated, real production conditions are taken into account, specific specific operations are



worked out, the corresponding work process is modeled [2, 35]. For example, when analyzing the balance sheet of an enterprise, it is possible to organize a role-playing game that simulates a meeting of the balance sheet commission of the enterprise. For this, a set of roles is created, which is distributed among the students of the group (chief accountant, deputy chief accountant, economist, director of an enterprise, etc.), the goal of the game is set, a specific task is given to analyze financial statements and identify reserves for effective financial management. The results of the analysis are then heard and discussed at a meeting of the balance sheet commission, where subsequently certain management decisions are made. Thus, role-playing games make it possible to activate the thinking of students, increase the independence of future specialists, and bring them as close as possible to the real conditions of production.

Quite an effective teaching method used in practical training is the solution and analysis of specific production situations [3,32]. At the same time, the group of students is divided into five or six microgroups. The composition of the group is determined independently by the students themselves, which creates comfortable conditions for their activities. In each microgroup, a leader is allocated who leads the work, distributes responsibilities between the group members. Each group is given a production situation, sources of information are selected to solve the assigned task, and time is given to complete the task.

For example, when completing a practical exercise on the topic "Assessment of the financial condition and business activity of an organization", each group is given the following assignments:

- to give an overall assessment of the financial condition of the enterprise according to the balance sheet data;
- to assess the solvency and liquidity of the company's assets;
- to assess the financial stability of the enterprise;
- to assess the business activity of the enterprise.

All these tasks are carried out by a group of students according to the data of the main forms of annual accounting statements and production and financial plans of various organizations. Based on the calculations performed, conclusions are drawn, reports are prepared, all results are discussed both within the group and with all participants in the lesson. Such activity of students allows them to stimulate the development of their self-esteem and self-control, and most fully to show their abilities and capabilities in the development of professional competencies. The activities of a teacher in such classes are reduced to the activities of a leader, assistant, controller and is aimed at encouraging and stimulating students' independent work.

The method of cases or the method of case studies (UCS) is used quite successfully in practical classes in the discipline "Management". The teacher, already at the stage of organizing the target space, acquaints students with the content of the case, identifies the problem, and forms micro-groups of students. Then, working in micro-groups, the students analyze the situation, deepening their understanding of the content of the case, develop solutions and present a report in the form of presentations. The case method combines search, problem and research teaching methods and allows students to master the general and professional competencies of their future specialty.

Teachers of economic disciplines practice integrated classes in their activities. An integrated lesson allows you to identify interdisciplinary connections between disciplines, MDC and deeper understand the importance of your future profession. For example, the disciplines of Economic Analysis and Information Technology in professional activities, professional modules in the specialty "Economics and Accounting" and Audit, and others are successfully integrated.

The use of active teaching methods involves the use of innovative teaching aids, namely, computer programs, presentations, electronic textbooks, manuals, workbooks. So, when performing practical calculations in the discipline "Economics of the organization" and "Economic analysis" students use the program "MicrosoftExcel", when solving problems in the discipline "Taxes and Taxation", "Audit" reference and legal system "Garant".

The optimal combination of active methods and innovative teaching aids allows students to form the professional competencies of the accounting profession.

Thus, the use of innovative pedagogical technologies contributes to:

- improving the quality of students' performance;
- an increase in motivation to study academic disciplines and professional modules; - the formation of professional competencies of a future specialist;
- Awareness of the importance of their future profession.

## **CONCLUSION**

I believe that the use of active teaching methods is aimed at the end result, namely, at improving the quality of training of specialists, at the students' awareness of the importance of their future profession, at the ability of graduates to make the most of their professional capabilities. As the results of reflection carried out in the framework of training sessions and research of the psychological service of colleges and technical school show, the goals have been achieved.

## **REFERENCES**

1. Simonenko, V.D. General and professional pedagogy. / V.D. Symonenko - M.: Ventanagraph, 2006.
2. Skobeleva, T.M. Modern teaching technologies in professional educational institutions. / T.M. Skobeleva - M.: Publishing house "New textbook", 2004.
3. Chernilevsky, D.V., Moiseev V.B. Innovative technologies and didactic means of modern professional education. / D.V. Chernilevsky, V.B. Moiseev - M.: MGITs, 2002.

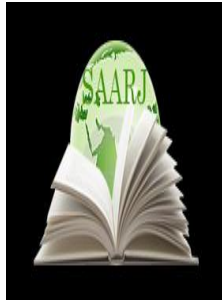

**ACADEMICIA**  
**An International**  
**Multidisciplinary**  
**Research Journal**  
 (Double Blind Refereed & Peer Reviewed Journal)



**DOI: 10.5958/2249-7137.2021.01193.9**

## NATIONAL FEATURE-CRITERION OF LABOR ORGANIZATION

N.Urinbaev\*

\*Associate Professor, Senior Lecturer,  
 Candidate of Philosophical Sciences,  
 Institute of Advanced Training under the Fergana Regional Department of Public Education,  
 UZBEKISTAN

### ABSTRACT

*This article discusses important issues related to the organization and management of labor. In the transition to market relations in Uzbekistan, great attention was paid to the national features of the organization of this labor. One of the important issues facing the requirement to take into account national specifics in the organization of labor in the process of transition to market relations is the priority development of trade and services. Unlike others, Uzbekistan is committed to investment, first of all, to the protection of the labor interests of our people, to establish cooperation with them on the basis of equal rights and mutual interests.*

**KEYWORDS:** *Market, Labor, Ethnopsychological, Lifestyle, Activity, Village, Population, Attitude, Socio-Economic Problems, Economy, Need, Degree, National Tradition, Method, Creativity, Property, Value.*

### INTRODUCTION

In the transition to market relations, it is important to take into account the characteristics of the ethnopsychological norm of labor organization, which is inherent in the national psyche. These features are characterized by the fact that the Uzbek nation has always been closer to the land at the level of social consciousness, the desire to have a private farm near his home is the basis of his lifestyle. It is this vital value that dominates all work-related skills. At a time when the natural demand for arable land among the local population is extremely high, the limited availability of arable land and its low quality composition pose serious socio-economic problems.

### MATERIALS AND METHODS

Only 10% of the total area of the country, which is more than 447.4 thousand square kilometers, is arable land. The number of people working on agricultural land is particularly high. Uzbekistan is the most densely populated region in Central Asia. 51.4 people per square kilometer of the territory of the Republic. However, this figure is several times lower in other republics.

This situation shows that we are absolutely overwhelmed by the demand and need of our able-bodied people living in rural areas. Also, due to the escalation of environmental problems, the level of land use is declining from year to year also sets the task of comprehensive study and application of national traditional methods in the organization of labor.

This state of the socio-economic situation is mainly explained by the lack of attention paid to this important issue in the way labor organization and management has been introduced in the recent past. While the republic views the national economy as a one-sided raw material base, it also has a technocratic approach to the organization and management of labor, and has not allowed the people to freely engage in the professions formed over the centuries. As a result, the creative and creative values of labor in the social consciousness have disappeared, and the process of alienation from labor has intensified year by year. People were forced to pursue their chosen professions secretly and semi-secretly.

The path chosen by the Republic of Uzbekistan in the transition to a market economy is based on national characteristics, "... in many respects, the processing of economic traditions and customs on a qualitatively new basis, to get rid of the old, unchanging path and to enlighten the economic thinking and psychology inherent in market relations among the population[1].

In the transition to market relations in Uzbekistan, great attention was paid to the national features of the organization of this labor. The family contract and lease method, which is based on different forms of ownership in land management, has developed as the most acceptable and most advanced method of labor organization.

This method of labor organization leads to the establishment of a new type of social relations based on ensuring the right of the farmer to own land, combining the economic freedom of each working person with his own success and personal responsibility for the welfare of his family.

## **RESULT AND DISCUSSION**

One of the important issues facing the requirement to take into account national specifics in the organization of labor in the process of transition to market relations is the priority development of trade and services. Market relations are not new for the Uzbek people, as for many Eastern nations. Our generation and ancestors have long been engaged in trade. Therefore, the history of our people has accumulated a great deal of experience in this area. Because market relations in our country have been developed since ancient times, in which "... patriarchal-feudal relations are explained by the fact that they are interrelated with the specific market relations that are emerging.

Despite the low level of maturity of market relations at that time, they left a deep mark. Even the harsh conditions of a planned-centralized economy have not been able to eradicate these traces". [1]

Another important factor that reflects national characteristics in the organization of labor is that "... the form of social cohesion is historically unique to the Uzbek people, which is closely linked to its traditional way of life." [2]. This factor is clearly reflected in the priority of family interests in our people, the commitment of the population to the community, the careful preservation of the shape of the neighborhood. In order to mobilize it, it is necessary to pay close attention to the priority of economic change, the abandonment of the administrative command system of distribution, the comprehensive consideration of the specific conditions and characteristics of the local people, traditions, customs and way of life.

The specific path of development produced should in practice prevent a sharp decline in production, provide social protection to the population in transition, and, most importantly, form a national traditional commodity production system. Rather than other independent CIS countries, Uzbekistan creates favorable conditions to support producers.

The population is divided by the ability to fill the consumer market with locally produced products. Commenting on this path of development, the first President of our country I.A.Karimov wrote: "We did not look for an easy way. In the early stages of the reform, we had to limit the consumer market somewhat. At the same time, we have spent money and resources on structural changes in the economy, building modern enterprises that produce products abroad, equipped with advanced technology, and fill the domestic market with our own goods. [2].

Based on the emerging socio-economic and natural conditions, the approach to the organization of labor, based on the annual characteristics, once again demonstrates its correctness in the conditions of cooperation with the investments that are being studied.

Unlike others, Uzbekistan is committed to investment, first of all, to the protection of the labor interests of our people, to establish cooperation with them on the basis of equal rights and mutual interests. That is why dozens and hundreds of manufacturing enterprises, such as the Asaka Automobile Plant, the Bukhara Oil Refinery, the Andijan and Fergana spinning and hosiery factories, are opening the way for the people of Uzbekistan to study world standards of labor organization.

One of the main ways to ensure the national characteristics of the organization of labor in the conditions of market relations is to open up the creative and labor potential of man through the radical reform of property relations, is to change the psychology of dependency that has been formed and to pave the way for the restoration in every worker of the sense of mastery which he has tried to lose in relation to his labor.

## CONCLUSION

Entrepreneurship and entrepreneurship, the ability to own property are in the blood of our people. Therefore, in the organization of labor, special attention is paid to the diversity of forms of ownership, the inviolability of private property and the formation of a class of owners who can be the economic and political basis of society.

Because only in this way, in the unique socio-natural conditions of the Republic, the irrational location and abundance of labor, the traditions and mentality of the population can be effectively directed to the activities of small and medium-sized businesses.

It is scientifically and practically based on the fact that in all spheres of the national economy of the republic, based on the roots and psyche of the people's historical labor traditions, small and medium business is considered as a dynamic, fast-paced leading development path that can fully meet modern requirements.

**REFERENCES:**

1. Karimov IA Uzbekistan - a unique way of transition to market relations. Uzbekistan for a great future.-Т .: Uzbekistan.1998.-94 pages, 92 pages.
2. Karimov I.A. Uzbekistan on the threshold of the XXI century: threats to security, conditions of stability and guarantees of development.-Т .: 1997.-370 pages.
3. Ilkhom Abdirakhimov. Development of effective demulsifiers on the basis of local raw materials // Universum: технические науки: научный журнал. – № 2(83). Часть [4] М., Изд. «МЦНО», 2021. DOI: 10.32743/UniTech.2021.83.2-4.36-39.

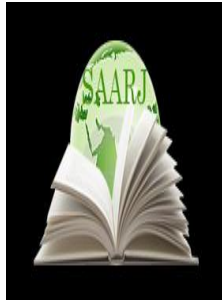

**ACADEMICIA**  
**An International**  
**Multidisciplinary**  
**Research Journal**  
 (Double Blind Refereed & Peer Reviewed Journal)



DOI: **10.5958/2249-7137.2021.01192.7**

**REGIONAL PRETRACHEAL LYMPHATIC THERAPY OF  
 PULMONARY COMPLICATIONS COVID-19**

**Saidkhodjaeva Djurakhon\* ; Djumabaev Ekin\*\* ; Madazimov Madamin\*\*\* ;  
 Madazimov Komil\*\*\*\***

\*Ph.D., Docent,  
 Department of Faculty and Hospital Surgery,  
 Andijan State Medical Institute,  
 UZBEKISTAN

\*\*Professor,  
 Head of Department of Faculty and Hospital Surgery,  
 Andijan State Medical Institute,  
 UZBEKISTAN

\*\*\*Professor,  
 Department of Faculty and Hospital Surgery,  
 Andijan State Medical Institute,  
 UZBEKISTAN

\*\*\*\*Ph.D., Assistant,  
 Department of Faculty and Hospital Surgery,  
 Andijan State Medical Intitute,  
 UZBEKISTAN

**ABSTRACT**

*According to the latest data of radiation diagnosis and sectional studies, it became known that the most common clinical manifestation of a new version of COVID-19 coronavirus infection is pneumonitis or intersticiopathy. The scheme of pathomorphological changes in the lungs seems to be as follows: interstitial inflammation → Interstitial fibrosis (NSIP) • Fibrin → Organization → Interstitial fibrosis (OIP) • Metaplasia of the alveolar epithelium (Fig1,2), [2, 4,4].*

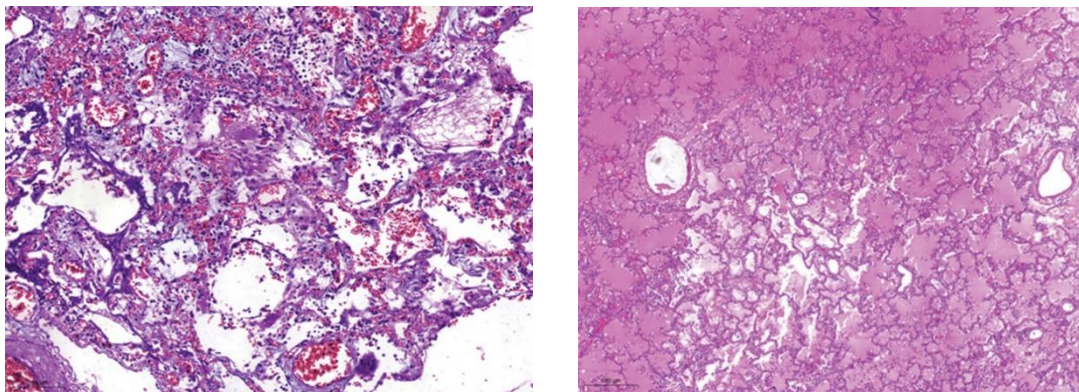

Fig. 1 Interstitial inflammation: Elemental myxoid stroma in the interstition of interalveolar partitions. Coloring hematoxylin and eosin,  $\times 130$ .

Fig. 2 Intraalveolar expressed edema. Coloring hematoxylin and eosin,  $\times 25$ .

At the same time, traditional methods of anti-inflammatory and antibacterial therapy are often not effective, due to the pronounced edema and the impossibility of creating therapeutic concentrations of drugs in the lungs and the lymphatic system of affected mediastinal organs, which leads to a severe course of pathology accompanied by high death [1].

### Purpose of the study

The study of gentamicin pharmacokinetics with pretracheal lymphotropic antibiotic therapy and regional stimulation of the lungs' interstitial space's lymphatic drainage.

**KEYWORDS:** *Pretracheal Lymphatic Therapy, Covid-19, Pulmonary Complications*

## INTRODUCTION

### MATERIAL AND RESEARCH METHODS

Experimental studies consisted of three stages. The first stage consisted of a one-time administration with 50 gentamicin, in a dose of 30 mg/kg., One of the studied methods: lymphotropic is pretracheal, using lymphodases and intramuscularly as a stimulator - lidases and intramuscularly, with subsequent thoracotomy, undertaken to withdraw the chest organs. cavities, paratracheal lymph nodes, and puncture of femoral veins, for blood collection. The second stage was to dynamically determine the concentration of gentamicin in the blood and the elevated tissues. The third stage is 10 outlets, the radionuclide method of Kety, using albumin I-131, the rate of lymphatic lung drainage was studied, with a pretracheal administration of a not concentrated lidase solution.

### RESULTS AND ITS DISCUSSION

Analysis of the dynamics of gentamicin concentration during pretracheallymphotropic administration showed (Table 1), which the maximum concentration in the blood and tissues of respiratory organs is observed after 1 hour, as with intramuscular administration. In the serum, the concentration was 1 hour and  $40.9 \pm 0.49 \mu\text{g} / \text{ml}$ , and after 3 hours  $-25.9 \pm 0.49 \mu\text{g} / \text{ml}$ . After 5 hours, the concentration exceeded such with intramuscular administration of 7 times, constituting,  $2.9 \pm 0.1 \mu\text{g} / \text{ml}$ , ( $P < 0.001$ ). The area of concentration under curve  $-15.2 \text{ cm}^2$  in



the tissues of paratracheal lymph nodes, in all times of the study, the antibiotic concentration significantly exceeded that observed with intramuscular administration (Fig. 3). The maximum concentration of gentamicin in an hour was equal to  $90.5 \pm 12.4 \mu\text{g} / \text{mg}$ , ( $35.5 \pm 1.2 \mu\text{g} / \text{mg}$  - at V / m), after 3 hours -  $56.3 \pm 8,4 \text{ mg} / \text{mg}$  ., ( $26.8 \pm 0.2 \mu\text{g} / \text{mg}$ ), in the future, during the day, the concentration decreases evenly. After 24 hours, the subtherapeutic level was maintained -  $3.6 \pm 0.19 \mu\text{g} / \text{mg}$ , ( $1.4 \pm 0.12 \mu\text{g} / \text{mg}$ ), ( $p < 0.005$ ). The total area of concentration under the curve under the paratracheallymphotropic administration is  $41\text{cm}^2$ ., The area of concentration under the curve with intramuscular administration -  $28.7 \text{ cm}^2$

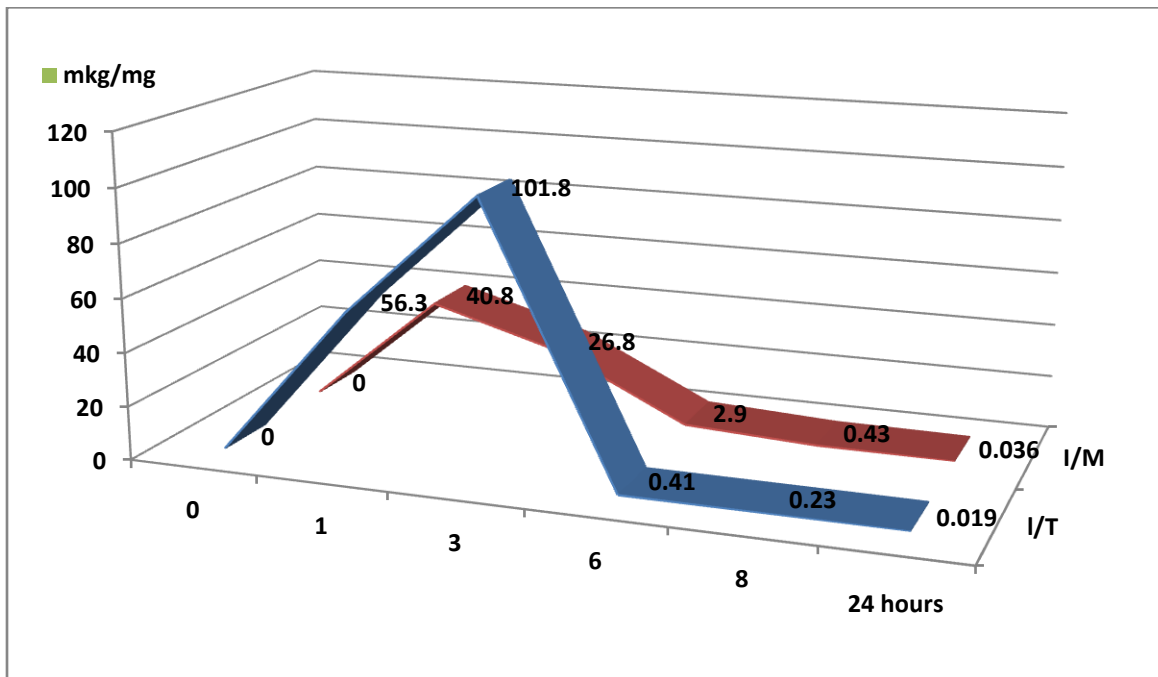

Fig.3. Dynamics of gentamicin concentration in paratracheal lymph nodes after single preaching lymphotropic and intramuscular administration.

In the tissues of the tracheal and bronchi, the maximum concentration of gentamicin after 1 hour is  $80.3 \pm 10.5 \mu\text{g} / \text{mg}$ , after 3 hours -  $72.4 \pm 9.3 \mu\text{g} / \text{mg}$ ., (Fig. 4). After 5 and 8 hours, high therapeutic concentrations are held, after 24 hours the antibiotic content is maintained at the subtherapeutic level and equal to  $4.9 \pm 0.3 \mu\text{g} / \text{mg}$ , ( $3.7 \pm 0.2 \mu\text{g} / \text{mg}$  at a per / m administration). The area of concentration under the curve is  $47.0 \text{ cm}^2$ ., (At a per / m administration -  $24 \text{ cm}^2$ ).

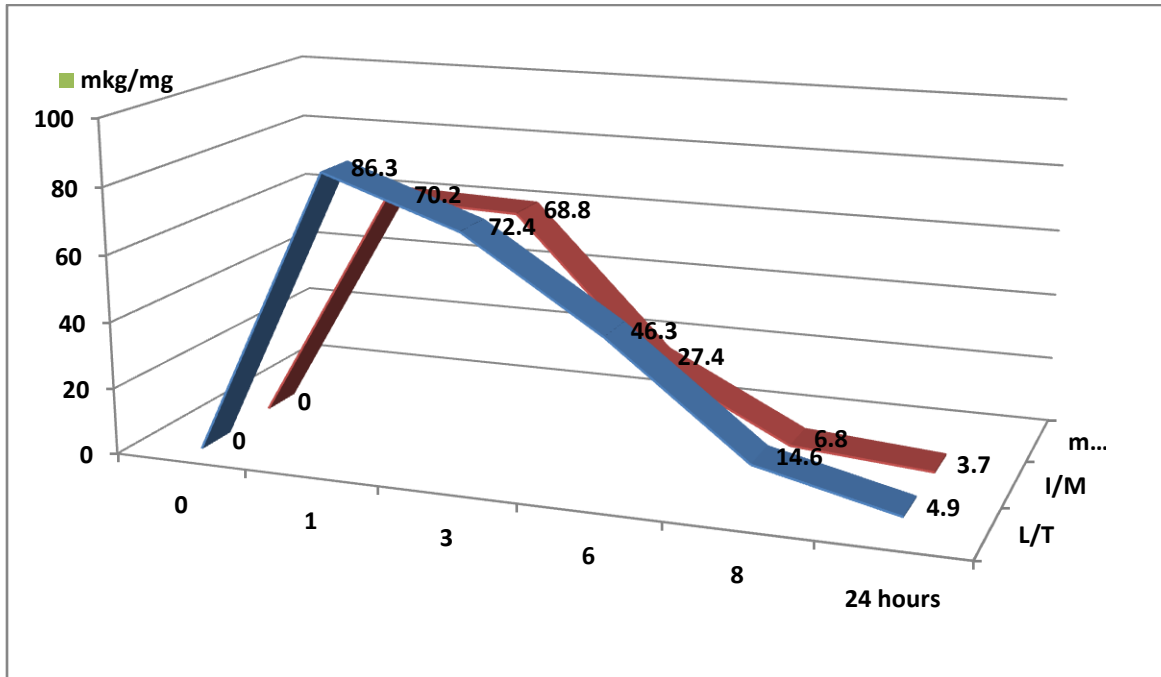

Fig.4 The dynamics of gentamicin concentration in trachea and bronchi after a single paratracheallymphotropic and intramuscular administration.

In the lungs, under pretracheallymphotropic administration, the content of gentamicin was 1 hour  $102.4 \pm 13.3 \mu\text{g} / \text{mg}$ , decreasing 3 hours to  $63.3 \pm 2.3 \mu\text{g} / \text{mg}$ ., (Fig.5). During the day, its concentration decreases smoothly, after 24 hours it was  $9.8 \pm 0.44 \mu\text{g} / \text{mg}$ . and exceeded as 2 times compared with intramuscular administration. The concentration area under the curve is  $50.9 \text{ cm}^2$ ., (At the I / M of the introduction -  $21 \text{ cm}^2$ ), ( $p < 0.005$ ). In the pleural tissue, the antibiotic content after 1 hour -  $38.6 \pm 3.2 \mu\text{g} / \text{mg}$  ( $23.9 \pm 0.49 \mu\text{g} / \text{mg}$  at V / m), after 3 hours -  $18.9 \pm 0.97 \mu\text{g} / \text{mg}$ ., ( $6.2 \pm 0.49 \mu\text{g} / \text{mg}$ ), and within the remaining duration of observing the concentration of gentamicin at both methods of administration amounted to approximately the same values.

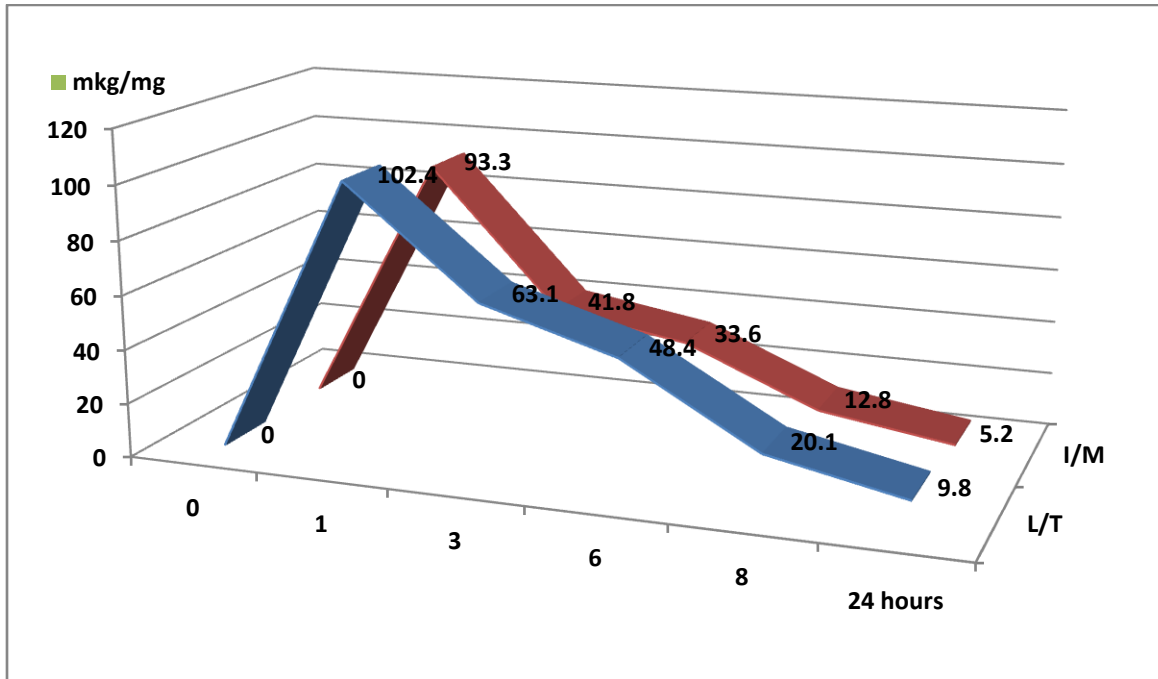

Fig.5 Changing the concentration of gentamicin in the pulmonary tissue after one-time paratracheallymphotropic and intramuscular administration.

**TABLE 1 THE CONCENTRATION OF GENTAMICIN IN BLOOD SERUM (MG / ML) AND TISSUES (MG / MG) IN ONE-TIME INTRAMUSCULAR AND LYMPHOTROPIC PREACHING INTRODUCTION AT A DOSE OF 30 MG/KG**

Biological substrate		Time after administration (h)				
		1	3	5	8	24
Blood in	i/m	238,2±18,2	101,8±7,8	0,41±0,06	0,23±0,02	0,019±0,004
	l/t	40,9±0,49	25,6±0,49	2,9±0,1	0,43±0,1	0,036±0,002
Paratracheallymphnodes	i/m	35,5±1,2	26,8±0,2	7,4±0,2	5,1±0,49	1,4±0,12
	l/t	90,5±12,4*	56,3±8,4*	13,9±1,2	6,7±1,02	3,6±0,19*
Trachea bronchi	i/m	70,2±7,3	68,8±10,1	27,4±0,5	6,5±0,1	3,7±0,2
	l/t	80,3±10,5*	72,4±9,3	45,3±2,4*	14,6±0,7*	4,9±0,3
Lungs	i/m	93,3±3,2	41,8±2,3	33,5±0,6	12,8±1,2	5,2±0,46
	l/t	102,4±13,3	63,3±3,3*	48,9±0,5*	20,1±1,2*	9,8±0,44*
Pleura	i/m	23,9±0,49	6,2±0,49	1,8±0,19	1,7±0,22	0,48±0,05

	l/t	38,6±3,2*	18,9±0,9 *	1,5±0,12	1,4±0,1	0,58±0,05
--	-----	-----------	---------------	----------	---------	-----------

Note B-external-free, L-lymphotropic method: \* -duppottically different values at compared methods of administration (P <0.05).

The area of concentration under the curve is 13.2 cm<sup>2</sup>. The introduction of lidase into the preaching cellular space, as shown by our radionuclide studies, increase the lymphatic drainage of the interstitial space of the lungs by 120-180% (P< 00.5).

In the first clinical trials, on volunteers, the method of pretracheallymphotropic antibiotic therapy with regional lymph stimulation turned out to be very encouraging.

## CONCLUSIONS

Analysis of data of pharmacokinetics and radionuclide study of lymph flow showed that the method of lymphotropicpretracheal administration of antibiotics and regional lymph stimulation may have advantages over the traditional methods of administering drugs in the treatment of pneumonitis (intersticiopathy) at COVID-19, due to higher and prolonged content of the latter in tissues and The lymphatic system of the bronchopulmonary system is the place of the largest cluster and the spread of infection, as well as the stimulation of the lymphatic lung drainage.

## REFERENCES

1. Zaitsev A.A. Patient conducting algorithms with a new COVID-19 coronavirus infection in the hospital (Methodical recommendations, M., 2020.54 p.).
2. Mikhaleva L. M., Zaishyanz O. V., Varyasin V. V. and others. Magazine Archive of pathology. 2020; 82 (4): 32-40.
3. Diao B., Wang C., Tan Y., et al. Reduction and functional exhaustion of t cells in patients with coronavirus disease 2019 (covid-19) Frontiers in Immunology. 2020; 11 DOI: 10.3389 / FIMMU.2020.00827. - DOI - PMC - PubMed
4. Qian z, travantyea, oko l, et al. Innate immune response of human alveolar type ii cells infected with severe acute respiratory syndrome-coronavirus. Am j respir cell molbiol2020; 48: 742-748. Doi: 10.1165 / rcmb.2020- 0339oc.
5. NodirbekYakubov, NataliyaDadamyants, DilfuzahonMamarasulova. (2020). Optimization of Methods for The Prevention of Pulmonary Embolism. The American Journal of Medical Sciences and Pharmaceutical Research, 2(10), 122-132.
6. D.Z Mamarasulova. Personalized medicine: new or well-forgotten old?/European science review-2017-№3-4.DOI: <http://dx.doi.org/10.20534/ESR-17-3.4-52-54>



**ACADEMICIA**  
**An International  
 Multidisciplinary  
 Research Journal**  
 (Double Blind Refereed & Peer Reviewed Journal)

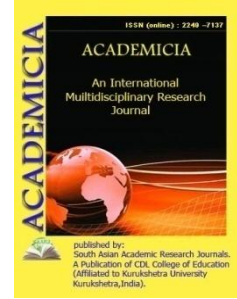

**DOI: 10.5958/2249-7137.2021.01230.1**

**“MODERATION EFFECT OF ORGANISATIONAL POLITICS WITH  
 REFERENCE TO PRIVATE ENGINEERING COLLEGE FACULTY”**

**Dr Kota Neela Mani Kanta\*; Dr. P Srivalli\*\***

\*Asst professor,  
 Department of Tourism Management,  
 Vikrama Simhapuri University, Nellore,  
 Andhra Pradesh, INDIA  
 Email id: kotamani2003@yahoo.co.in.

\*\*Associate Professor,  
 Dept of Management Studies,  
 S. Chavaans Institute of Computer Application, Nellore,  
 INDIA  
 Email id: kotasrivalli87@gmail.com

**ABSTRACT**

*The teaching effectiveness of a faculty is assessed on various criteria such as professional competencies, student feedback, interpersonal relationships with students and peers, personality of the teacher and last but not least teaching capabilities. There are abundant studies on teaching effectiveness, organisational politics and employee engagement, however this research is the first of its kind to discuss about the relationship and its influence on teaching effectiveness. The researcher has collected the primary data source through structured questionnaire collected from 410 college teachers working in various private engineering colleges operating in Rayalaseema Region of Andhra Pradesh. Since the study is sought to understand the relationship and influence among the variables, the study adopts descriptive research design. The sample selected from the total population through convenience sampling method in selection of college teachers in collecting the primary data. The results revealed are as follows:*

- *The study findings reveal that college teachers have mediocre perception levels towards organizational politics and employee engagement.*
- *The study finds significant association organisational politics, employee engagement and its influence on teaching effectiveness.*

- *In addition the study finds negative association of organizational politics and Teaching Effectiveness.*
- *However the study fails to prove significant moderation effect of organizational politics on the relationship between employee engagement and teaching effectiveness.*

*Even though study fails to prove the moderation effect of organisational politics, it should be considered as critical variable in influencing teaching effectiveness. Consequently the study suggests management of private engineering colleges need to design appropriate policies and programmes to free the institutions from politics.*

**KEYWORDS:** *Employee Engagement, Organisational Politics, Teaching Effectiveness, Private Engineering Colleges.*

---

## 1. INTRODUCTION

Organisational politics is a quest of individual agendas and self-interest in an organization without regard to their effect on the organization's efforts to achieve its goals. Hence it is treated as a negative variable that affects environment, morale, culture and employee behavior. Private engineering colleges too cannot be exempted from Organizational politics, which can influence the overall teaching effectiveness. Hence the researchers in human resource domain are more interested in understanding the characteristics and momentous of organizational politics and its influence on performance of the institution. It is evident from the literature that organizational politics has among the various variables in negatively affecting the growth of the organization in many areas.

At the other end employee engagement is a noteworthy behavioral variable that has become essential and expected by the management. In order to enhance employee engagement the management has to think and implement those schemes pertaining to the welfare and growth of employees in the organization. However the organizational politics is one variable that has negative effects on the employee who is engaged in his work.

After the effects of prolonged recession and at the foot hills of growth of global economy, the colleges and universities are been questioned and facing greater scrutiny on their efficiency as well as concerns about teachers ability to educate a highly diverse population. The teachers in private engineering colleges in particular are been facing enquires and reports on their productivity, rigor and contributions to the economic development and intellectual vitality, at the outset coping with reduced public funding and assuming larger academic workloads. Consequently the teachers in private engineering colleges have reported professional isolation, higher levels of occupational stress and decreasing levels of job satisfaction and retention. The present levels of economic and demographic conditions, teachers are expected to contribute higher levels of accountability pertaining to their teaching and research efforts and also to cater the needs of higher diverse and globalised society. Consequently the study is assumed to be important in understanding the various employees and organizational factors that influence teaching effectiveness. Hence the present research is sought to understand the association between Organizational Politics, Employee Engagement and Teaching Effectiveness.

## 2. REVIEW OF LITERATURE

**Massimo Garbuio, Dan Lovallo, (2017)**, in their paper titled "Does organizational politics kill company growth?", has discussed about the organisational politics and its negative effects on organisation growth. The basic question behind the research is that whether the organizational politics is positively associated to organisation performance. It is observed from the literature though there are ample studies on the above research question, but are limited to the elaboration in the form of case studies, apart from a niche set of studies in international business.

Hence the above research is been aimed to investigate the above said question through a survey among managers and executives working around the world and across industries. The study was successful in determining the association between politics and the ability of a company to achieve the higher heights. The study was conducted among the 382 executives from across the world. It is evident from the study that alternative explanations of slow speed to growth are explained by power centralization and decision making layers and conflicts.

It is evident from the present study that covert action of executives in influencing the internal decision has direct negative effect on a firm's ability to reach higher growth rates. That is, not only is politics time-consuming but it may also have a detrimental impact on the selection of the best growth opportunities. Hence it can be understood that politics has negative influence on growth, it slows down the ability and creates hurdle in reaching higher growth rates of market. It is also evident from the study that the reasons for slow pace to market is not only because of too many decision making layers but also because of consultative processes in resource allocation decisions and conflicts.

**Zinta S. Byrne, Steven G. Manning , James W. Weston, Wayne A. Hochwarter, (2017)**, in their paper titled "All Roads Lead to Well-Being: Unexpected Relationships Between Organizational Politics Perceptions, Employee Engagement, and Worker Well-Being" has been initiated to investigate the perceptions of organizational politics and its negative influences on detrimental outcomes of the organization and employees. The recent past demand for literature on more balanced treatment, the present study is been extended to know how the positive and negative organizational politics perceptions are reasons for stressors and affecting the employee efforts through the effect on social environment. The study assumes that employees appraise of positive and negative politics is either a challenge or hindering stressors or they respond with engagement and disengagement as problem or emotion focused coping strategies. In particular employees perceiving negative politics as hindrance use both problem and emotion focused coping strategies such as (1) decreasing their engagement, (2) narrowing the focus of their engagement, or (3) disengaging. Consequently these strategies result in negative impacts on organization, but if the employees coping with negative politics leads to their positive well being.

Conversely the employees perceiving positive politics as a challenge stressors use problem focused coping strategies such as increasing their engagement to reap the perceived benefits of a positive political environment. However positive politics perceptions may be perceived as hindrance stressors in certain situations and therefore employees resort to adopt emotion focused coping wherein they use a disengagement strategy. In disengagement process they deal with negative effects of politics perceptions and resulting in positive well being. Thus the study conceptual framework suggest that any unexpected turn to the stress process of politics can lead strain provoking component of employee work environments.

**Erin M. Landells, Simon L. Albrecht, (2017)**, in their paper titled “Positive Politics, Negative Politics, and Engagement: Psychological Safety, Meaningfulness, and Availability as “Black Box Explanatory Mechanisms” has been initiated to investigate on the psychological mechanisms that can explain the influence of negative organizational politics on individual employees and organisational performance. Since majority of the literature is inclined towards understanding the negative outcomes such as stress, burnout and turnover intentions. Hence the present study is sought to describe more about the positive conceptualizations of organizational politics and investigate the potential associations between both positive and negative politics and employees engagement. The outcome of the present study is to propose a model exhibiting how psychological conditions such as safety, availability and meaningfulness explain the relationship between perceptions of positive and negative politics and employee engagement. Therefore it is concluded and suggested that practical interventions that support organizations developing a more positive organisational political climate.

**Aviv Kidron, Hedva Vinarski Peretz (2017)**, "Organizational political climate and employee engagement in political behavior in public sector organizations: a mixed methods study", The study is sought to know the association between organisational politics climate and individual engagement in political behavior. Further the moderating role of organisational commitment and trust in local government organizations. Mixed and explanatory methods design were adopted and data is collected from 217 managers and employees, in addition 16 interviews were conducted.

The findings of the study suggested that political climate is associated with political behavior, further associated with trust and affective commitment and negatively associated to political climate. The moderating role of trust between political climate and political behaviors is evident from the study results. In addition it is observed that the moderation effect of affective commitment moderated by political climate and political behavior in the case of women. It is also evident that men perceive more positive than women regarding the organizational politics.

**Usman Aslam, Farwa Muqadas, Muhammad Kashif Imran, Ubaid Ur Rahman, (2018)** in their paper titled "Investigating the antecedents of work disengagement in the workplace" has proposed that organizations are anxious in knowing the causes of work disengagement and effecting the desired level of performance. The predictors and levels of work disengagement differ among organizations and sectors, the reason could be the differences in organisational culture Galit Meisler, Eran Vigoda-Gadot, Amos Drory, (2017). Hence the aim of the present study is to determine the predictors of work disengagement. The study is conducted among 303 employees of the public sector organizations through self administered questionnaires and cluster sampling technique. Hayes's (2013) moderation model and regressions statistical techniques reveal that work disengagement is increasing because of manager's personal preferences, unfairness, over the rule practices, negative political influence, work overload, and a lack of accountability in the workplace. It is also evident that there is positive relation among organizational injustice, organizational politics, work overload, and work disengagement. In addition it is also observed that organizational injustice is a strongest antecedent of work disengagement. Bureaucratic culture of the public sector organizations has a strong strengthening effect on above-stated relationships. The mixed methods design for studying the contextual-organizational antecedent (perception of political climate) for politicking and individual



engagement in political behavior may serve to expand the theory of organizational politics Mohammed Y.A. Rawwas, Basharat Javed, Muhammad Naveed Iqbal, (2018).

### 3. Objectives

The following are the objectives of the study:

1. To investigate the demographic profile of faculties working in private engineering colleges in Andhra Pradesh
2. To determine the negative effects and moderations of organisational politics on relationship between employee engagement and teaching effectiveness.

### 4. Hypothesis Development

**H1:** *There is significant association between employee engagement and Teaching Effectiveness*

**H2:** *There is negative association of Organisational Politics on Teaching Effectiveness*

**H3:** *Organisational Politics negatively moderates the relationship between employee engagement and Teaching Effectiveness.*

### 5. Research Design

The aim of the present study is determine the perception levels of engineering colleges teachers and direction of relationship between Employee Engagement, Organizational Politics and Teaching Effectiveness. Consequently the study assumes employee engagement, organisational politics and teaching effectiveness as independent, moderating and dependent variables. The engineering college teachers are the respondents of the study. Hence the study is sought to describe the levels and relationships between the study variable, descriptive research design is adopted.

#### Sample Design and size:

Andhra Pradesh is a geographically dispersed state, classified with two regions –Rayalaseema and Coastal with 13 districts. Convenience sampling techniques is followed to select the respondents among the populations. Since the faculty members working in private engineering colleges working are geographically dispersed, it is difficult to get access, because of their availability during the visit to the colleges; hence the study adopts convenience sampling method.

Even though convenience sampling method is adopted at most care is taken in selecting the colleges and faculty members for collection of the primary data. The study in the first stage divides Andhra Pradesh into Rayalaseema region comprising of four districts and Coastal region comprising of nine districts, then among the two regions Rayalaseema Region is selected for the study. Rayalaseema region is selected since the density of private engineering colleges to area is high comparatively to Coastal region. In Rayalaseema region, i) Kadapa (21 colleges), ii) Chittoor (32 Colleges) iii) Kurnool (21 colleges) and iv) Anantapur (15 Colleges) have 89 private engineering colleges are selected as sample in first stage.

The researcher has visited the above engineering colleges as stated in the above towns randomly, before visiting the colleges the faculty members and principals of the respective

colleges are been requested for permission to conduct the survey. Hence the survey is conducted only in those colleges where the permission is granted.

The sample size of the study is calculated using [www.raosoft.com](http://www.raosoft.com) website. The inputs to be given for calculating sample size are i) Margin of error accepted ii) Confidence level iii) Population size and iv) Response distribution.

The study considered a Margin of error equal to standard of 5%, Confidence level 95%, Population size of 20,000 (Assumed value, since the exact number of faculty members is not known) engineering faculty members in Andhra Pradesh and Response distribution of 50%. Finally the calculated value of sample size is 377. Hence the study collected primary data from 400 engineering college faculty to the nearest value. The 400 sample is been distributed equally among the four districts of Rayalaseema Region, Hence from each district the study has collected the primary data from 100 engineering college faculty members. The details are as follows.

**TABLE 1: SAMPLE DISTRIBUTION**

SL.No	District	Sample Size
1	Kadapa	110
2	Chittor	100
3	Anantapur	100
4	Kurnool	100
<b>Total Sample Size</b>		<b>410</b>

### **Data Collection:**

The present study has collected the primary data by distributing structured questionnaire among engineering college faculty members working in Andhra Pradesh. Enough care has been taken so that the data collected is not biased. We have distributed questionnaires to each and every faculty and the opinions given by them are truly confidential.

### **Statistical Tools:**

Data is analyzed by using SPSS 16.0 version. Statistical tools like correlation and regression analysis were employed for this study.

### **6. Data Analysis**

The study states Organizational Politics negatively moderates the relationship between Employee Engagement and Teaching Effectiveness. The hypothesis is tested by conducting regression analysis, Teaching Effectiveness is considered as dependent variable, Organizational Politics as moderating variable and Employee Engagement as independent variable. Results are summarized in the following **Table 2**.

**TABLE 2: MODERATION EFFECT OF ORGANIZATIONAL POLITICS ON EMPLOYEE ENGAGEMENT AND TEACHING EFFECTIVENESS**

Regression Parameters	Employee Engagement(EE)	Organisational Politics(OP)	EE*OP	Model Summary
R <sup>2</sup>			.0017	.119
Df			406	406

<b>F</b>			.791	18.44
<b>P</b>			.374	.000**
<b>B</b>	.459	-.203	.0989	4.204 (Constant)
<b>T</b>	6.407	-2.947	.889	103.129
<b>P</b>	.000**	.003**	.374	.000**

\*\*Significance at  $P < 0.01$ .

\* Significance at  $P < 0.05$ .

**Model:** Employee Engagement (Predictor), Organisational politics (Moderating Variable) and Teaching Effectiveness (Dependent Variable).

The regression of Organizational Politics on teaching effectiveness is significant at  $\beta = -.203$ ,  $t(406) = -2.947$ ,  $p = .003$ . The regression of Employee Engagement on Teaching effectiveness is significant in presence of Organisational Politics at  $\beta = .459$ ,  $t(406) = 6.407$ ,  $p = .000$ . The total model summary is significant at  $R^2 = .119$ ,  $F(406) = 18.44$ ,  $p = .000$ . Interaction effect of Organisational Politics and Employee Engagement is insignificant at  $R^2 = .0017$ ,  $F(406) = .791$ ,  $p = .374$ ,  $\beta = .0989$ ,  $t(406) = .889$ ,  $p = .374$ .

**Chart 1: Interaction Effect of Employee Engagement and Organizational Politics**

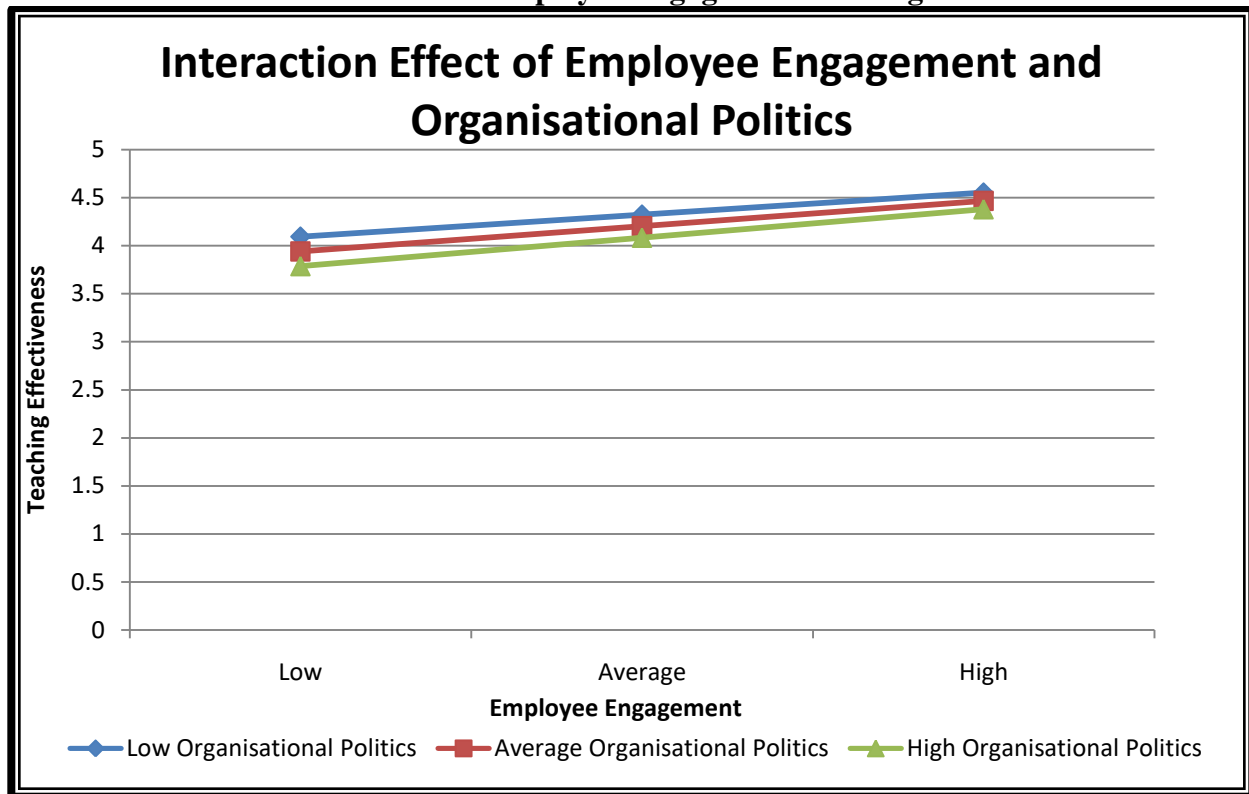

It is observed from the above interaction plot chart 1, Teaching Effectiveness is low at High Organisational politics and Low Employee Engagement. Further, it is inferred that Teaching Effectiveness is high in the conditions of Low Organisational Politics and High Employee Engagement. However, study fails to prove statistically the moderation effect of Organizational

Politics on relationship between Employee Engagement and Teaching Effectiveness. Hence **H1 and H2 are accepted and H3 is rejected.**

## 7. DISCUSSION

The study find faculty has neutral opinions regarding organizational politics. Politics is a constraint for organisational development. In the context of private engineering college the study opines Organisational Politics being neutral as a positive setting. In the opinion of faculty and personal observation, Organisation rewards people working hard; favoritism is less in the organization. Conversely the faculty opine, they fear to speak due to retaliation of others; there are some influential group in organisation on which no one crosses.

The study finds relatively positive levels of Employee Engagement among faculty in engineering colleges. The faculty opines that they are fascinated being a member of their organisation; highly engaged in their job and they feel concern regarding the activities happening in their organization. Hence the study opines faculties are engaged in their job and organisational activities.

The study examines relationship between organisational politics, employee engagement and teaching effectiveness, finds that there is significant relationship. However the study fails to proves significant moderation effect of Organisational politics.

The study finding shows that Organisational Politics and Employee Engagement have significant variance in Teaching Effectiveness in isolation. Conversely interaction plot reveal unresponsive lines indicating Organisational Politics have insignificant moderation effect on Employee Engagement and Teaching Effectiveness. Additionally the statistical results reveal Organisational Politics have insignificant moderation effect. Hence the study opines Organisational Politics has no influence on the relationship between Employee Engagement and Teaching Effectiveness.

## 8. REFERENCES

1. Massimo Garbuio, Dan Lovallo, (2017) "Does organizational politics kill company growth?", Review of International Business and Strategy, Vol. 27 Issue: 4, pp.410-433, <https://doi.org/10.1108/RIBS-09-2017-0073>.
2. Zinta S. Byrne, Steven G. Manning, James W. Weston ,Wayne A. Hochwarter , (2017), All Roads Lead to Well-Being: Unexpected Relationships Between Organizational Politics Perceptions, Employee Engagement, and Worker Well-Being, in Christopher C. Rosen , Pamela L. Perrewé (ed.) *Power, Politics, and Political Skill in Job Stress (Research in Occupational Stress and Well-being, Volume 15)* Emerald Publishing Limited, pp.1 – 32.
3. Erin M. Landells ,, Simon L. Albrecht , (2017), Positive Politics, Negative Politics, and Engagement: Psychological Safety, Meaningfulness, and Availability as “Black Box” Explanatory Mechanisms, in Christopher C. Rosen , Pamela L. Perrewé (ed.) *Power, Politics, and Political Skill in Job Stress (Research in Occupational Stress and Well-being, Volume 15)* Emerald Publishing Limited, pp.33 – 49.
4. Usman Aslam, Farwa Muqadas, Muhammad Kashif Imran, Ubaid Ur Rahman, (2018) "Investigating the antecedents of work disengagement in the workplace", Journal of

---

Management Development, Vol. 37 Issue: 2, pp.149-164, <https://doi.org/10.1108/JMD-06-2017-0210>.

5. Aviv Kidron, Hedva Vinarski Peretz (2017), "Organizational political climate and employee engagement in political behavior in public sector organizations: a mixed methods study", International Journal of Organizational Analysis, <https://doi.org/10.1108/IJOA-09-2017-1243>.
6. Mohammed Y.A. Rawwas, Basharat Javed, Muhammad Naveed Iqbal, (2018) "Perception of politics and job outcomes: moderating role of Islamic work ethic", Personnel Review, Vol. 47 Issue: 1, pp.74-94, <https://doi.org/10.1108/PR-03-2016-0068>.
7. Galit Meisler , , Eran Vigoda-Gadot , , Amos Drory , (2017), Stress, Psychological Strain, and Reduced Organizational Effectiveness: The Destructive Consequences of the Use of Intimidation and Pressure by Supervisors, in Christopher C. Rosen , Pamela L. Perrewé (ed.) Power, Politics, and Political Skill in Job Stress (Research in Occupational Stress and Well-being, Volume 15) Emerald Publishing Limited, pp.51 – 80.

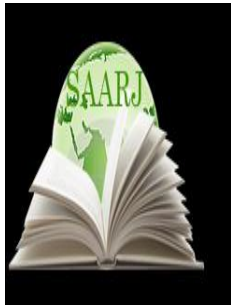

**ACADEMICIA**  
**An International**  
**Multidisciplinary**  
**Research Journal**  
 (Double Blind Refereed & Peer Reviewed Journal)



**DOI: 10.5958/2249-7137.2021.01242.8**

## TRANSLATION HYPOTHESIS SPECIFICS AND PROBLEMS OF TRANSLATION OF SCIENTIFIC AND TECHNICAL MULTI COMPONENT TERMS

**Nishonov Usmonkhon Ibragimovich\***

\*Head of the Department of Uzbek Language and Literature,  
 Fergana Polytechnic Institute,  
 UZBEKISTAN

### ABSTRACT

*In this article highlights of translation hypothesis. specifics and problems of translation of scientific and technical multicomponent terms. We divide it into two components: the total power and the directed rays. One of the most effective methods for testing a hypothesis is a search engine on the Internet. The dictionary includes only a limited set of values in each zone: not everything that is in the language, but only what may be needed for automatic processing of highly specialized texts and makes this processing less complex. In order to translate them correctly, you need to understand how the keywords are expressed in these terms. We see that all of them have a suffix-n, which most likely indicates that they belong to the verbal forms of the noun.*

**KEYWORDS:** *Transdict, Russian Terms, Dictionary, Search Engines Google And Yandex, Structure.*

### INTRODUCTION

As mentioned above, 4-component noun phrases are the most difficult to translate into English. This is due to the fact that they are not available in paper dictionaries, and such a developing and new science as opt informatics constantly requires competent translation, especially complex terminology.

There is a special algorithm for translating terms, which greatly simplifies the task of the translator.

1. Since we consider the specifics of the translation of a multicomponent terminology, and, as mentioned above, it is almost impossible to find such a term in a paper dictionary in its full

version. In this case, the translator must refer to the terminology dictionaries in order to find the translation of each n-gram component separately. For example, consider such a four-component term as the total power of the directed rays. We divide it into two components: the total power and the directed rays. One of the most effective methods for testing a hypothesis is a search engine on the Internet. It is such because, when we search for a term in the search bar, we see the frequency of use of terms in the texts of various fields of knowledge and can choose the one that is used in our own field. After translating the first component in the terminology dictionary, we get the full capacity translation. The translation of the second component in our hypothesis will sound like directed beams. Combining both elements, we get the translation: full capacity of the directed beams. To make sure that the translated name group is correct, enter the resulting translation of the term in the search bar. Sometimes, search engines can display a complete translation of one or even two components, but, in this case, you need to be extremely careful in the texts of what nature this term or part of it occurs. In our case, we see that 37 variant of the wording of the translation of the term is not found in the search engines Google and Yandex.

2. In cases where the terminology dictionary and search engines they cannot cope with the task, a good assistant in the translation of scientific and technical terminology, and, in particular, multicomponent vocabulary, can be the Transdict program, which is a bilingual lexicographic knowledge base. The dictionary includes only a limited set of values in each zone: not everything that is in the language, but only what may be needed for automatic processing of highly specialized texts and makes this processing less complex. The main advantage is that Transdict includes the translation of nominal phrases related to the area of knowledge we are studying. Another advantage of the program is the introduction and preservation of multicomponent terms, which are then checked by specialists in this field.

3. Turning to the dictionary Transdict, select the search field where you need to enter the desired 4-gram. We get the translation: the total power of the associated rays in order to check the correctness and use in scientific works on opt informatics, it will be correct to use any of the search engines again. Again, we enter the resulting translation of the total power of the connected rays in the search bar. The Google search engine produces a huge number of results, but the very first ones already make it possible to understand that there really is one and it is used in materials related to opt informatics - the theory of the optical waveguide-Page 71-The result from Google and the Book. According to the first sentence, which shows the user where the desired term is used, it becomes clear that we are looking at a scientific work, which is indicated by the keywords in this sentence. Consider, an immediate consequence of this definition is that fibers with the same profile volumes carry the same total power of the bound rays when illuminated by a diffuse source.

The translation will sound something like this:

An immediate consequence of this definition is that fibers with equal profile volumes carry an identical total transmission beam power when illuminated by a diffuse source.

Thus, thanks to the compilation of a translation hypothesis, which in most cases can be trusted, but always to question and verify the correctness of a particular term, as well as the use of specialized automatic translation dictionaries related to narrow areas of knowledge-makes the task of translating a complex, multi-component term much easier.

During the translation process, a specialist may encounter such a problem as a search for an English equivalent for a Russian term, since in English it can be interpreted in different ways, that is, it may have more than one syntactic structure. For example, take two multicomponent terms, the shape of the refractive index profile and the function of the refractive index profile. We see that the structure of these terms in the Russian language is the same and, moreover, the three components of this 4-gram are absolutely identical. But despite this, when translating two given multicomponent elements, their syntactic structure will differ. The refractive index profile function can be translated as a complex attribute group refractive index profile function, while in 4-gram-refractive index profile form-the defining word in the translation will stand at the beginning-shape of the refractive index profile, which makes the term for the translator much simpler in structure. Accordingly, the choice of a translation of terms that are identical in structure in Russian directly depends on the word being defined.

Another difficulty that can be identified when translating scientific and technical multicomponent terms is the variety of translation options for the same nominal group. In such cases, the choice of the equivalent of the term when translated into English is influenced by three other components that belong to this nominal group. For example, the following terms as a "system of coupled mode equations", it can be translated in two ways. The first option will sound like system of equations of the coupled mode, while another valid translation option may be the multicomponent term system of coupled mode equations.

In order to check which version of the translation is correct, really used in real texts of a scientific nature, you should again turn to the search engine. When checking the first term, we will make sure that it is used very rarely in texts, while the second version of the translation is found on the Internet about 40 million times. Another example is the 4-gram "field of higher-order modes". We can translate this term in two ways: field of modes of the higher-order and field of the higher-order modes, and referring to the texts in which these translation variants occur, we are convinced that several equivalents can correspond to the Russian term in English, and the most frequent in use, as a rule, are terms in which three components form an attribute construction.

Special attention should be paid to the problem of translating terms in the field of opt informatics in grammatical constructions. In the body of the text were such multicomponent terms as "use of three-dimensional photonic quasicrystals", "production of three-dimensional photonic crystals", and "violation of total internal reflection" are found. In order to translate them correctly, you need to understand how the keywords are expressed in these terms. We see that all of them have a suffix-n, which most likely indicates that they belong to the verbal forms of the noun. Only they, in turn, are translated into English by a gerund, which combines the features of a noun and a verb and carries the meaning of a process. This form is not inherent in the Russian language.

As a result, we get the translation using the three-dimensional photonic quasicrystals, acquiring three-dimensional photonic crystals and breaking of the total internal reflection, which once again confirms the difference in grammatical forms of the two languages, which can cause problems when translating. The text body contains multicomponent terms that should be translated from Russian into English using attribute constructions. Examples of the most frequent terms constructed on an attribute basis are presented in Table 1.



**TABLE 1 – TRANSLATION OF RUSSIAN TERMS INTO ENGLISH, BY ATTRIBUTE GROUPS**

форма профиля показателя преломления	15	refractive index profile form
параболический показатель преломления профиль	14	parabolic refractive index profile
эффективность основной моды возбуждения	14	fundamental mode excitation efficiency

In our study, we considered four-component terms, since they are the main difficulties in translating from Russian into English. Russian translation is based on the difference in the syntactic structures of the two languages, the variety of equivalents in English that fall on one Russian term, as well as the appearance of new components in the English equivalent when translated from Russian.

Further, a translation hypothesis was developed, which makes it easier for the translator to solve the problem and increases the chances of finding a more accurate equivalent of the term in English. Each term was translated using this technique, as well as checked in Internet search engines in order to identify the use of a particular term in the texts of technical fields of knowledge. Dictionaries such as Transdict, Google, and Prompt were among the main helpers in translating terms.

#### REFERENCES:

11. Ахметова, Г. Д. Некоторые сложности перевода английских технических терминов / Г. Д. Ахметова // Молодой ученый. Ежемесячный научный журнал. – 2015. – №4(84). – М. : ООО «Издательство Молодой ученый», 2015. – 15 с
12. Бархударов, Л. С. Язык и перевод (Вопросы общей и частной теории перевода) / Л. С. Бархударов. – М. : «Междунар. отношения», 1975. – 240 с
13. Нишонов У. И. Билингвизм и его использование в обучении //Достижения науки и образования. – 2018. – №. 15 (37).
14. Парпиева М. М., Нишонов У. И. Интеграция интерактивных методов в процессе образования //Вестник науки и образования. – 2019. – №. 19-2 (73).
15. Нишонов У. И., Парпиева М. М. Лингвистические проблемы перевода: текст как объект переводческой деятельности //Проблемы современной науки и образования. – 2019. – №. 11-2 (144).
16. Нишонов У. И. Методы обучения как компонент учебного процесса в национальных группах //Вопросы науки и образования. – 2018. – №. 7 (19).
17. Парпиева М. М. Самостоятельные задания поискового и творческого характера как способ активизации деятельности на уроках русского языка //Достижения науки и образования. – 2018. – №. 16 (38).
18. Парпиева М. М. Информационно-коммуникационные технологии в процессе обучения русскому языку как неродному //Вопросы науки и образования. – 2018. – №. 7 (19).

- 
19. Парпиева М. М. УПРАВЛЕНИЕ ОБРАЗОВАНИЕМ КАК ОТРАСЛЬ НАУЧНОГО ЗНАНИЯ И ПРАКТИКИ //Качество высшего и профессионального образования в постиндустриальную эпоху: сущность, обеспечение, проблемы. – 2016. – С. 224-228.
  20. Парпиева М. М., Израилова С. М., Мадумарова М. Д. Преимущества применения ИКТ (информационно-коммуникационных технологий) на уроках русского языка //Наука, техника и образование. – 2019. – №. 5 (58).

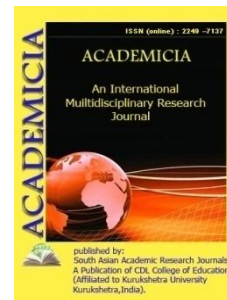
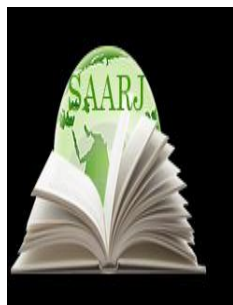

DOI: **10.5958/2249-7137.2021.01243.X**

## INVESTIGATION OF BACKGROUND RADIATION AND THE POSSIBILITY OF ITS LIMITATION IN A SEMICONDUCTOR IONIZATION SYSTEM

Yuldashev H.T\*; Mirzaev S.Z\*\*

\*PhD,  
Ferghana Polytechnic Institute,  
Ferghana, UZBEKISTAN

\*\*Assistant  
Ferghana Polytechnic Institute,  
Ferghana, UZBEKISTAN

### ABSTRACT

*The article presents the results of experimental studies of the phenomenon in a flat gas-discharge cell with a semiconductor electrode. The possibility of limiting the background, which is an obstacle to increasing the contrast of the output image, is shown.*

**KEYWORDS:** *Image Converter, Semiconductor Electrode, Ionization Chamber, Gas-Discharge Gap, Semi-Insulating Gallium Arsenide, Photodetector, Current-Voltage Characteristic, Photocurrent, Pulse Duration, Pulse Voltage.*

### INTRODUCTION

A semiconductor photographic system of the ionization type, in which one of the electrodes is a plate made of a high-resistance and photosensitive semiconductor, has found practical application in recent years. On its basis, so-called photoionization systems have been created, which are used for high-speed IR photography [1-2], silver-free photography, as IR image converters [3-4], as devices for visualizing electrical and structural defects in high-resistance semiconductors, as a source of uniform UV radiation over a large area, as a system where dissipative structures are formed in a gas plasma [5].

The semiconductor ionization system [6] operates in two modes: waiting and gating. In the standby mode, high-resistance semiconductors with  $p \geq 10^7$  ohm cm at direct current are mainly used. In the gating mode, relatively low-resistance photodetectors are also used in the pulse

mode. In the second case, the dark current and thus the background radiation on the output screen of the semiconductor ionization chamber is much larger.

The study of the dependences of the average current on various values (photocurrent, pulse duration, pulse voltage, gas pressure, etc.) in the system is of considerable interest not only for understanding the physical mechanism of phenomena, but also has applied significance.

Recent research suggests that a new approach to a flat gas-discharge cell with a semiconductor photosensitive electrode will lead to a new class of devices. In our next works, we will show that changing the configuration and location of the cell elements, as well as the use of new photodetectors, allows us to create a unique photographic system, or rather a modern type of night vision devices.

This paper presents the results of experimental studies of the phenomenon in a flat gas-discharge cell with a semiconductor electrode. As part of this work, the possibilities of limiting the background, which is an obstacle to increasing the contrast of the output image, and in general improving the characteristics of the system, are shown.

### SCHEMATIC DIAGRAM OF THE SYSTEM

The schematic diagram of a semiconductor ionization photographic system is shown in Fig.1. The photosensitive photodetector (2) is a semi-insulating gallium arsenide ( $\rho \cong 10^8 \text{ Ohm.cm}$ ), on one of the surfaces of which a translucent nickel contact (1) is filed. The inner surface of the plate is separated from the surface of the recording layer (4) by a gas gap (3). The recording layer (4) is located on a transparent conducting counter-electrode (5), made, for example, of a glass plate covered with a conducting film. When connected to the voltage system, a gas discharge breakdown occurs, characterized in that there is a distributed resistance of the semiconductor in the discharge cell, which contributes to the damping of current instabilities.

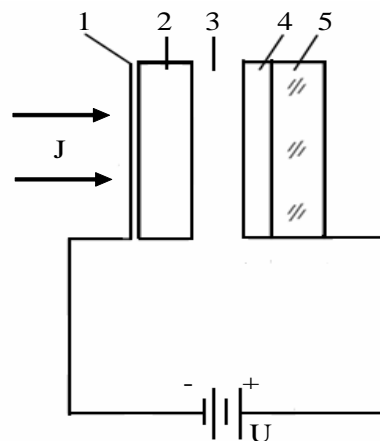

**Fig. 1. Schematic-ionization system .**

**1 – translucent electrode, 2-semiconductor photodetector,  
3-gas-discharge gap, 4-recording layer, 5-transparent counter electrode.**

The resistance of a semiconductor completely determines the value of the current density over the cross-sectional area, and when the semiconductor is illuminated, it can control the value and distribution of the current in the gas gap.[7]

For the measurements, the usual scheme of an ionization system with a semiconductor photodetector made of compensated gallium arsenide with a dark resistivity  $\rho = 108 \text{ om}\cdot\text{cm}$  was used. Providing output voltage pulses with a duration of 0.5 – 30 ms, up to 1.6 kV. The measurements were performed at two values of the gas discharge gap-40 microns and 100 microns-and an air pressure of 0.2 atm.

## RESULTS AND DISCUSSIONS

When a rectangular voltage pulse is applied to a cell consisting of a gas – discharge gap contacting, on the one hand, a semiconductor electrode and on the other, a counter electrode, a gas breakdown occurs. The appearance of current pulses – the presence of an easily recorded delay time  $\theta$  relative to the moment of switching on the voltage. Another feature of current pulses is the presence of a statistical spread of the breakdown delay value  $\chi$  relative to some of its values.

Figure 2 shows a diagram of oscillograms of successive current pulses, illustrating the nature of the manifestation of the statistical spread of the moment of ignition of the discharge. Oscillograms of successive current pulses were taken in a semiconductor ionization chamber, illustrating the nature of the manifestation of the statistical spread of the discharge ignition moment.

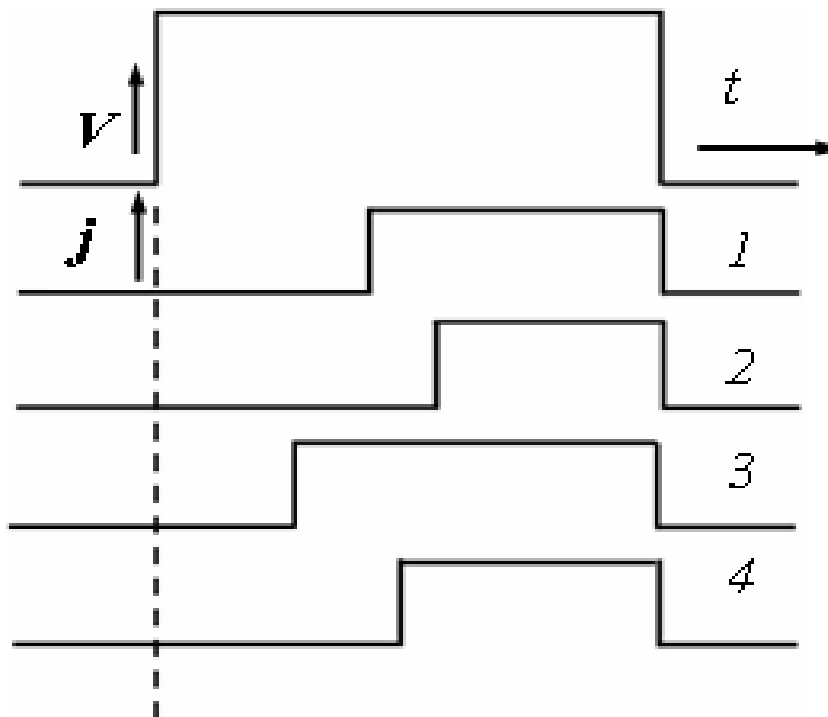

**Fig. 2. Diagram of the breakdown current  $j$  waveforms with voltage pulses  $V$  applied in series.**

Since the photographic effect on the recording medium is determined by the value of the average amount of electricity, we were interested not only in the values of the charge in each individual current pulse, but also in the average values of the charge and current over the period. Therefore, the first experimental task was to determine the average current averaged for each moment of time by the total number of pulses during exposure.

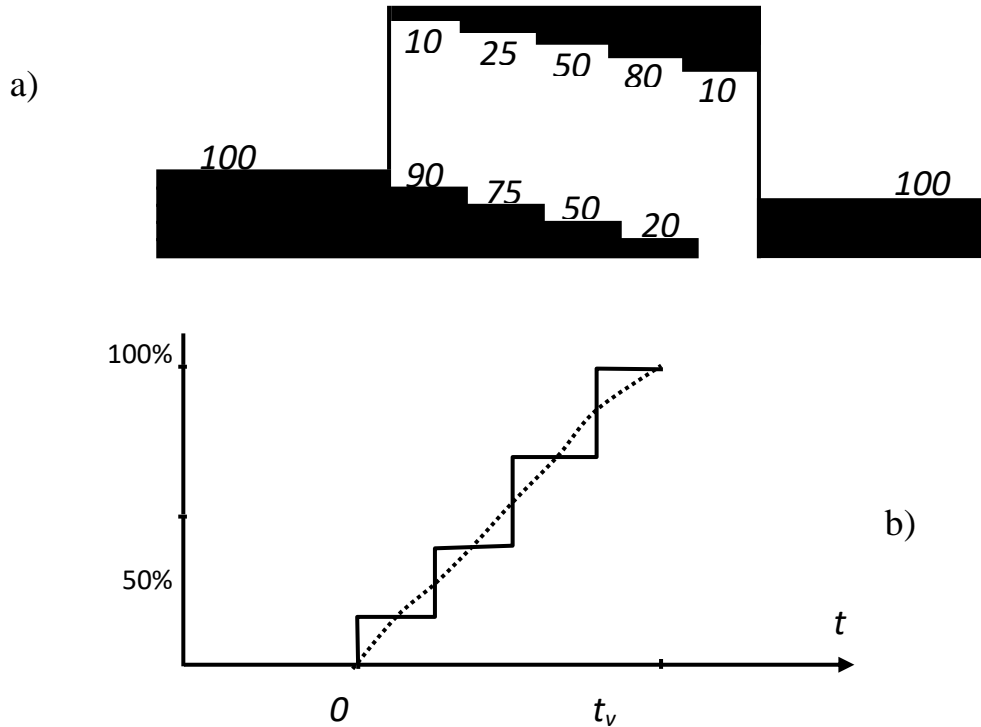
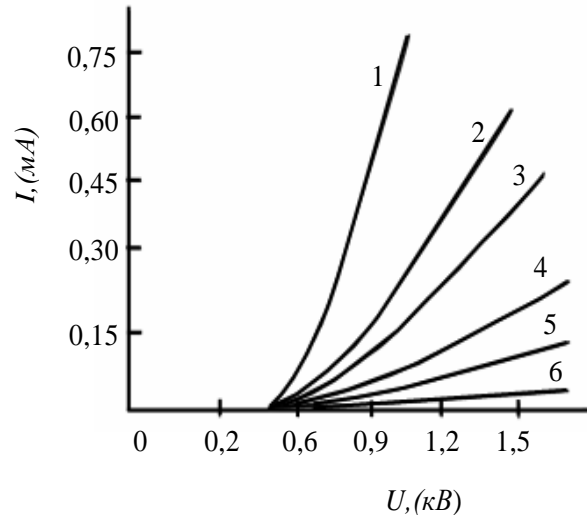

**Fig. 3. a). Schematically – the distribution of the optical density of blackening on the current pulse waveform. b). the time dependence of the average current obtained from the waveform (a).**

The method for obtaining the average current kinetics from densitometry of waveforms is schematically explained in Fig. 3, a, where the optical density on the waveform is conventionally represented by lines of different thickness, and the smooth curve in Fig. 3, b shows the resulting average current kinetics.

Thus, the total delay time is determined by two components: the delay time of the discharge gap capacitance through the illuminated semiconductor and the time of the statistical breakdown delay at a given voltage in the gap.

To determine the value of the stationary voltage, the stationary VAC was removed (Fig. 4), from which it follows that the value of the breakdown voltage is 500 V with a gap length of 100 microns. The value of the resistance under illumination varies from 50M to 790K.



**Fig. 4 Stationary VAC systems at different values of the semiconductor illumination. The light intensity is equal to (in rel. units.): 1 – 100%, 2 -72, 3 – 50, 4 – 25, 5 – 10, 6 – 0%.**

Figures 5a and b show the dependences of the average current in the pulse on the light intensity at different values of the voltage pulse duration. A characteristic feature of the curves is the "threshold" type of these dependencies, which is a consequence of the breakdown delay effect. With an increase in the duration of the voltage pulse, the threshold value of the illumination intensity decreases, below which the conduction current in the system, and therefore the discharge glow, is absent. Note also that starting from the threshold value, the current, as well as the past charge, sharply increase with increasing light intensity. Received "threshold values" the dependences of the average amount of electricity passed and the value of the average current with the adjustment of the threshold value are of considerable interest, being in principle a new method of background discrimination. Such a possibility of dynamic background discrimination is undoubtedly realized in independent gas-discharge cells with a distributed resistance of the semiconductor electrode in a semiconductor photographic system of the ionization type.

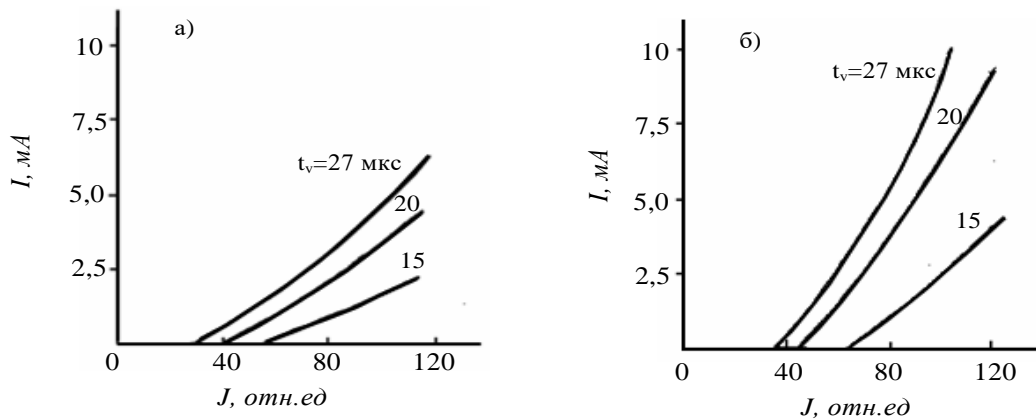

**Fig. 6. a). Lux-ampere characteristics of the system at different values of the voltage pulse duration with a gap thickness  $d = 40$  mm. b). The same is true for the gap thickness  $d = 100$  mkm.**

Studies of the dynamic background discrimination mode with photographic image registration at different values of the breakdown delay and different illumination of individual areas of the semiconductor photosensitive electrode area are carried out

## CONCLUSION

Thus, the shown breakdown delay in a gas-discharge cell with a semiconductor electrode during electrical and photovoltaic measurements generally confirms the possibility of implementing dynamic background restriction at a given level.

## REFERENCES:

1. З.Хайдаров, К.З. Хайдарова, Х. Т. Йулдашев Высококочувствительная полупроводниковая ионизационная фотографическая камера для инфракрасного диапазона. // Прикладная физика, 2017, № 1, ст. 65-69.
2. Х.Т.Йулдашев, З.Хайдаров, Ш.С.Касымов Кинетика пробоя в системе «полупроводник — газоразрядный промежуток. // Вестник СПбГУ. Сер. 4. Т. 4 (62). 2017. Вып. 1.
3. Х.Т.Йулдашев, Ш.С.Ахмедов, З.Хайдаров Исследование инфракрасной фотографической системы на основе кремния, легированного платиной. // Журнал физики и инженерии поверхности, 2017, том 2, № 1, сс. 12–19.
4. Лодыгин А.Н., Астров Ю.А., Порцель Л.М., Берегулин Е.В. Динамика таунсендовского разряда в аргоне // ЖТФ. 2015. Vol. 85(5). PP. 27-31.
5. Ю.А.Астров, А.Н.Лодыгин Л.М.Порцель Гексагональные структуры тока в системе “полупроводник-газоразрядный промежуток . // ЖТФ. 2011. Vol. 81(2). PP. 42-47.
6. Н.Н.Лебедева, В.И.Орбук, Е.Ю.Боброва, О формировании низкоомного состояния газа над поверхностью полупроводникового электрода в предпробойном режиме. // AZƏRBAYCAN MİLLİ ELMLƏR AKADEMİYASININ XƏBƏRLƏRİ Fizika-riyaziyyat və texnika elmləri seriyası, fizika və astronomiya 2005 №5 PP. 111-115.
7. А.Н.Лодыгин Л.М.Порцель Ю.А.Астров Газовый разряд в аргоне и азоте при криогенной температуре в тонких зазорах. // Письма в ЖТФ. 2008.Vol. 34(14). PP. 61-66.
8. Y.Sadiq, K.Aktas, S.Acar, B.G.Salamov Influence of the microstructure on the charge transport in semiconductor gas discharge electronic devices // Superlattices and Microstructures 47 (2010) pp 648-660.





**ACADEMICIA**  
**An International  
Multidisciplinary  
Research Journal**  
(Double Blind Refereed & Peer Reviewed Journal)



DOI: **10.5958/2249-7137.2021.01244.1**

## **APPLICATION AND RESEARCH OF ENERGY-SAVING LIGHTING DEVICES IN ENGINEERING NETWORKS**

**Obidov J.G\*; Ibrohimov J.M\*\***

<sup>1,2</sup>Ferghana Polytechnic Institute,  
UZBEKISTAN

Email id: jamshidobidov19@gmail.com

### **ABSTRACT**

*This system allows to control the flow of light by adding or subtracting light. Such actions can be performed via a remote control. This system is quite complex, but very convenient. With the help of this system, a special sensor that detects the level of light can be installed and it is possible to provide automatic lighting of lamps at the desired level. The article discusses the support of energy-saving systems in the technical regulation of public utilities, in particular, metrological regulation of ballast effect control.*

**KEYWORDS:** *Light Flux, Acoustic Noise, Acoustic Control System, General Control System, Optical Control System, Functional Circuit, Light Source.*

### **INTRODUCTION**

In today's world of energy, most of the electricity is used for lighting. Based on the facts on the topic, we can say that in most industries, agriculture, national economy, industry and utilities, energy conservation and energy conservation issues have become an urgent problem of modern lighting systems technologies. In 14 countries of the world there are state programs and fundamental projects on energy saving in green light systems, according to which practical and financial support is provided for the development of energy saving systems. [10]

EE consumption can be reduced due to a competent choice of lighting devices with the required light distribution, design, and optimal suspension height. Today, luminaires with fluorescent lamps (FL) are widely used for lighting public premises. When choosing lamps with FL, and other light sources, special attention must be paid to the optical efficiency, the higher it is, the better. [2]

The optical efficiency (CUA) of a luminaire largely depends on the reflector and diffuser used in the luminaire. Currently, for the production of diffusers for fluorescent lamps, polymethyl methacrylate, polycarbonate and light-stabilized polystyrene are used. During the operation of luminaires, the transmittance of diffusers decreases as a result of exposure to short-wavelength visible and ultraviolet radiation, which is present in the spectrum of lamps and in the spectrum of natural light.[5]

At the same time, the most effective now are fluorescent lamps of a new generation with a tube diameter of 16 mm (the so-called T5 lamps) for which only electronic high-frequency PRO (EPRO) are used. For example, an analogue of an FL in a T8 tube with a power of 36 W is an FL with a 16 mm bulb (T5) with a power of 28 W. The luminous fluxes of these lamps at an ambient temperature of 35 ° C, which corresponds to the actual temperature inside the lamp, are comparable. It is also worth noting the advantages of FL in the T5 tube: service life 24000 h; the decline in luminous flux by the end of the service life is no more than 10%; sharply reduced content of mercury in these lamps (from 30 to 3 mg); high color rendering index. The luminous efficiency of T5 fluorescent lamps is 105 lm/W. And the most promising at the moment are LEDs, the maximum achieved luminous efficiency is 303 lm/W. The luminous efficiency of serial samples at the moment is 140-150 lm/W. LEDs are gradually replacing other light sources, but price is a limiting factor for even more widespread adoption. [1]

A ballast is a lighting product, with the help of which the LS (light source) is powered from the electrical network, providing the necessary starting and operating modes of the LS. When choosing PRO, you need to understand that the LS parameters, including energy, depend on its quality. To facilitate the choice of PRO for FL from the point of view of energy efficiency, the Committee of the European Associations IMO and PRO (CELMA) proposed to classify PRO according to the energy efficiency index by EU directive 2000/55/EC. The EEI - Energy Efficiency Index - is applied to the PRO by the manufacturer (part of CELMA). For the consumer, this means that there are 7 classes depending on losses (table 1). The first 3 - A1 (most effective), A2 and A3 are EPRO, and the remaining 4 - B1, B2, C and D are electromagnetic PRO (EmPRO).

#### The efficiency of the ballast handling system

Lamp (code ILCOS)	Lamp power W		Ballast efficiency (Plamp/Pinput %)						
	EmPRO	EPRO	A1*	A2	A3	B1	B2	C	D
<b>FD 18-E-G13-26</b>	<b>18</b>	<b>16</b>	-	< 19	< 21	< 24	< 26	< 28	> 28
<b>FD 36-E-G13-26</b>	<b>36</b>	<b>32</b>	-	< 36	< 38	< 41	< 43	< 45	> 45
<b>FD 58-E-G13-26</b>	<b>58</b>	<b>50</b>	-	< 55	< 59	< 64	< 67	< 67	> 70

\* *dimmableEPRO* [9]

The above points give the efficiency of the main ballast system, which should be discussed with any supplier and a checklist has been formed.

For more information on how to ensure high efficiency of the energy saving system, a wide range of proposed resources for automated system management was analyzed.[8]

To assess the impact of the above recommendations on the technical and economic indicators of the educational institution, a comparison of the educational auditorium options was carried out. According to the current regulatory documents for classrooms, it is necessary to provide:

- illumination on the working surface 400Lx;
- illumination in the middle of the board  $E = 500Lx$ ;
- the combined indicator of discomfort UGR is not more than 21;
- the coefficient of pulsation of illumination is no more than 10%, for offices for working with computers no more than 5%.

Automatic control. Automatic lighting control can be done in two ways. The first is to install a lighting system on each console. The second way is full automation using special sensors. In this case, the lighting system is activated when a person enters the room, and turns off a few seconds after he leaves the room.[4]

Lighting brightness control. This system allows you to control the flow of light by adding or removing light. This can be done using the remote control.

Lighting control during daylight hours. This system is quite complex, but very convenient. In cloudy weather on summer days, natural light may not be enough to illuminate rooms. In this case, a special sensor can be installed that detects the level of illumination and provides automatic ignition of the lamps at the desired level.

Traffic lighting control. Such systems are one of the main factors in energy saving and are useful in everyday life and utilities.

The main feature of this lighting system is that it only burns in the dark and in the presence of acoustic noise. The functional diagrams of the device are shown in the following figures:

**Figure 1. Functional diagram of the acoustic control device**

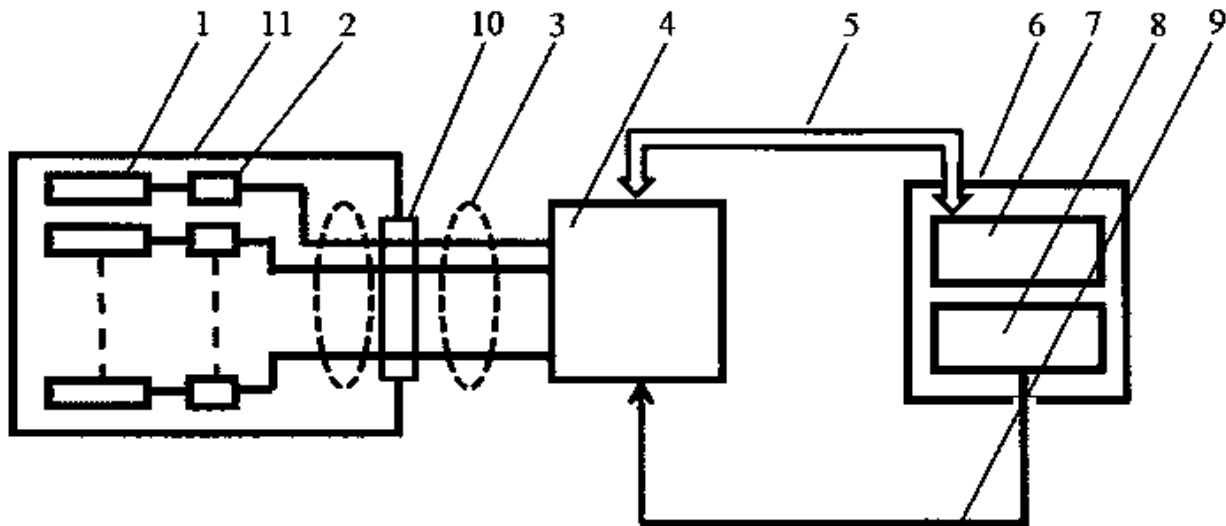

The acoustic control system along the main pipes is designed to automatically control the movement of the flow inspection device (cleaning piston and defect detectors) along the pipe.

The data transmitted in this functional diagram is transmitted to the external control system via telemechanics (TM) or GSM channels. In this case, the processed acoustic signal of the piston movement is recorded in digital form in the internal memory of the acoustic control kits installed on the crane platforms and in the control room computer. [7]

**Figure 2. Functional diagram of the optical control device.**

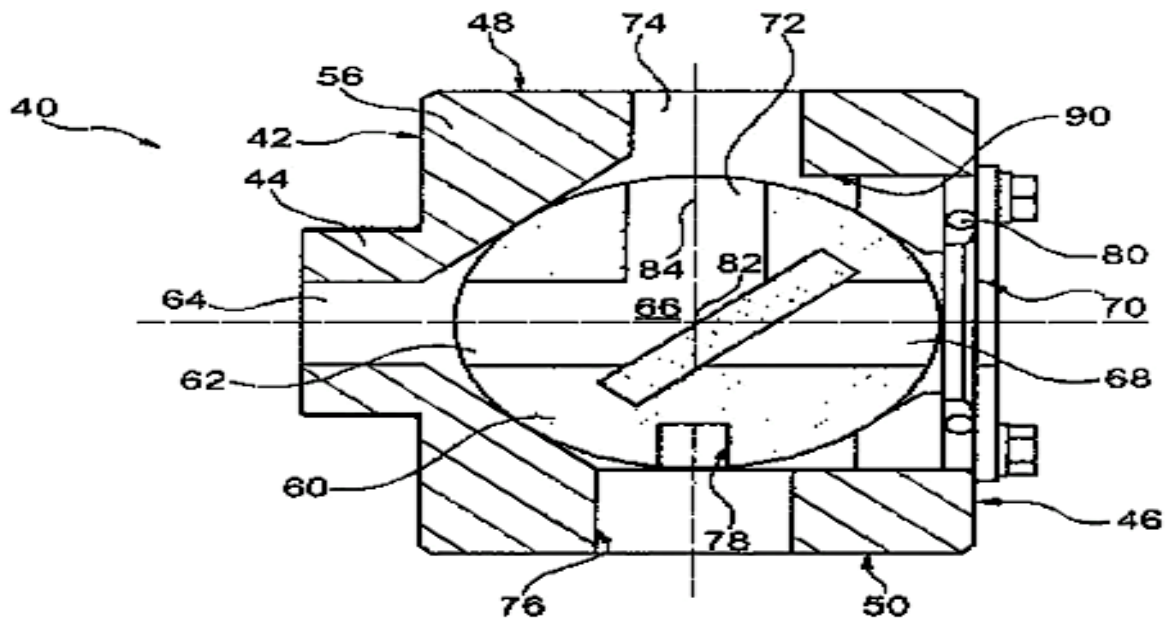

Optical inspection systems are usually designed to monitor 2D or 3D areas. Unlike conventional sensors, they have the ability to record and analyze detailed data over a fully observed area.

Optical surveillance systems provide a high level of security in a convenient sequence according to user requirements for various security processes and standard control functions.

**Figure 3. Control system for optical and acoustic devices.**

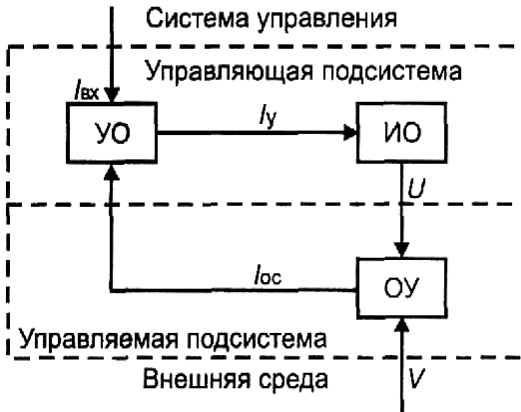

The principle of operation of the device is as follows: optical and acoustic changes affect the sensor, which generates signals at the outputs of optical and acoustic control systems. These signals are transmitted to the general control system and, in its turn, the general control system issues a signal that activates the light source.

**Figure 4. View of a light source on a schematic diagram.**

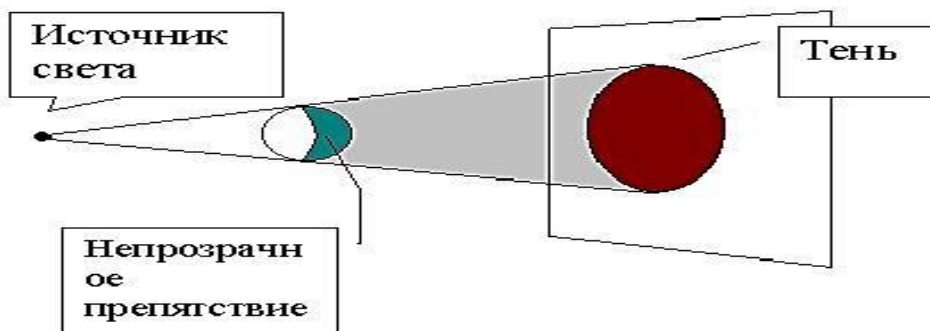

Conclusion. Most of the world's electricity is only used to drive binoculars. We can ensure the energy efficiency of buildings mainly by adopting and using factors to implement smart energy saving strategies. Without internal and external cooperation in the field of energy conservation, the technical regulation of many control strategies will not be successful, since energy savings cannot be achieved through their lighting conditions. Correctly designed and implemented energy efficient utility lighting systems do not violate working conditions. The following targets for progressive and industrial lighting systems are 1-3 W/m<sup>2</sup>/100 lx. In particular, saving energy is good. In this article, we've shown what energy efficient lighting can look like at a national or corporate level. [9]

#### REFERENCES:

1. Функциональные устройства систем электропитания наземной РЭА / В.В. Авдеев, В.Т. Костиков, А.М. Новожилов., В.И. Чистяков. Под ред. В.Г. Костикова. –М.: Радио и связь, 2000. –192 с.
2. Энергия тежамкорлик асослари. А.Раджабов., М.Ибрагимов., А.Бердышев. Ўқув қўлланма. – Тошкент, 2008.– 116-132 б.

3. Энерго - тежамкор иссиқхоналарни қуриш ва улардан фойдаланиш бўйича қўлланма. Н.Обломуродов., Б.Алимов., У.Ахмедов., А.Ашуров., Н.Дадаханова., М.Ниёзов. Ўқув қўлланма. – Тошкент, 2013. – 15, 26 б.
4. Потапкин Н.Н., Вишнеvский С.А., Ашрятов А.А. Повышение энергоэффективности осветительных установок общественных помещений // Современные проблемы науки и образования. – 2015. – № 2-1
5. Obidov, J. G. O. (2020). About safety technique and issues of supplying electricity of the textile industry. ACADEMICIA: An International Multidisciplinary Research Journal, 10(9), 123-127.
6. Умаралиев, Н., Матбабаев, М. М., & Эргашев, К. М. (2020). УСТАНОВКА ДЛЯ ИЗУЧЕНИЯ ОПТОЭЛЕКТРОННОГО ДАТЧИКА ВЛАЖНОСТИ ВОЗДУХА. Известия высших учебных заведений. Приборостроение, 63(3).
7. Ibrokhimov, J. M. (2020). Application of the solar combined systems consisting of the field of flat and parabolocylindrical collecting channels for hot water supply of the industrial factories. ACADEMICIA: AN INTERNATIONAL MULTIDISCIPLINARY RESEARCH JOURNAL, 10(12), 1293-1296.
8. Иброхимов, Ж. М. (2018). АСУ ТЕХНОЛОГИЧЕСКОГО ПРОЦЕССА НА ОСНОВЕ ИНТЕЛЛЕКТУАЛЬНОГО ОПТОЭЛЕКТРОННОГО СЕНСОРА. In Современные технологии в нефтегазовом деле-2018 (pp. 280-283).
9. Jamoldinovich, A. E. (2020). THE IMPORTANCE OF METROLOGY AND STANDARDIZATION TODAY Alikhonov Elmurod. INTERNATIONAL SCIENTIFIC AND TECHNICAL JOURNAL “INNOVATION TECHNICAL AND TECHNOLOGY”, 1(4), 1-3.

**Used websites:**

1. <https://lex.uz/>
2. <http://fizmat.by>
3. <https://www.dissercat.com/>
4. <https://uz.khanacademy.org/>
5. <https://www.indianjournals.com/ijor.aspx?target=ijor:aca&volume=10&issue=9&article=016>
6. <https://scholar.google.com/citations?user=lZTLeSYAAAAJ&hl=ru>

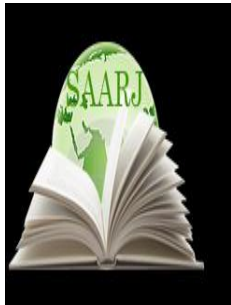

**ACADEMICIA**  
**An International  
 Multidisciplinary  
 Research Journal**  
 (Double Blind Refereed & Peer Reviewed Journal)



**DOI: 10.5958/2249-7137.2021.01246.5**

**DESCRIPTION OF SOCIAL PROBLEMS IN “CANNERY ROW” BY  
 JOHN STEINBECK**

**Ganieva Orzigul Khayriddinovna\***

\*Researcher,

English Literature and Stylistics department,  
 BSU Bukhara, UZBEKISTAN

Email id: ganieva\_orzigul@mail.ru

**ABSTRACT**

*John Steinbeck is the prominent literary representative who greatly contributed to the development of American literature. His works reflect the psyche of the period to which they belong, the contradictions of society, different characters and destinies, changes, disagreements or imbalances between society and man. In the following article some literary peculiarities of the work “Cannery Row” by John Steinbeck are discussed. In the novel the author shows the fate and feelings of people belonging to different classes in the society, besides he expresses the problems of the time, too. The novelist created his works at a time when the spiritual, moral and social situation in the country was complicated.*

**KEYWORDS:** *John Steinbeck, Short Novel, Style, Language, Narration, Character, Setting, Society, Person, Relationship, Protagonist, Identity, Peculiarity, Writer.*

**I. INTRODUCTION**

Social factors play a key role in human development. It is undoubted that in maturity of the person the ideology in the family, society, and time is crucial and in order to increase a sense of identity education, upbringing, knowledge, and life experience greatly matter. The role of literary works in the acquisition of knowledge and in drawing the necessary conclusions in the various stages of life is invaluable. “Cannery Row” by John Steinbeck is the work that is of great value in this aspect. A. Ulugov states, “Good works are always created on the basis of writer’s emotions or the experiences that bother him” []. John Steinbeck wrote about the serious issues, life stories and people around them and expressed their views on the events in depth.

John Steinbeck’s best short novels include “Tortilla Flat”, “Of Mice and Men”, “The Pearl”, and “Cannery Row”. Though there is a similarity between the themes of “Tortilla Flat” and “Cannery

Row”, the latter reveals the images more deeply than “Tortilla Flat”, characters’ sufferings and feelings are described in detail and the relationship between character and society is vividly depicted. S. Baturin notes that small community represented in the work can embody impression about American society []. Although the work is based on the relationship between the protagonist Doc and Mack with his friends, the reader will have a full impression of the people living in the area where the canneries are located, their occupations, and their lifestyles.

## II. Main part

“Cannery Row” was written at the end of World War II and published in 1945.

For a nation who was exhausted with the war, the work was at first glance a social comedy and a light satire, while a closer look reveals the dominance of death and deep sorrow in society. The story takes place in Monterey, California, on what is now called “Cannery Row” in honor of the book. Each building and the unique world of the people living in it are depicted with Steinbeck’s pathos. Commenting on his work, the author described it as a ‘nostalgic’ work designed to lift the mood after the emotional turmoil of his career as a reporter in the war. [] In fact, the story is dedicated to a real street in the town where he lived for several years and a close friend Ed Ricketts (a prototype of the protagonist Doc, so readers recognized him as soon as the book was published). Although the author begins the work with *“The people, places and events in this book are, of course, fictitious and fabrications”*, several real people, places, and events in the book are embodied in the work. []

The story of Cannery Row illuminates Doc’s relationship with the people around him, in which various professions are described, who live in the street near the beach in Monterey. While getting acquainted closely with the life of such characters as the biologist Doc, a grocer Lee Chong, *“Mack and Hazel, a young man of great strength, Eddie who filled in as a bartender at La Ida, Hughie and Jones who occasionally collected frogs and cats for Western Biological, were currently living in those large rusty pipes in the lot next to Lee Chong’s. That is, they lived in the pipes when it was damp but in fine weather they lived in the shadow of the black cypress tree at the top of the lot. The limbs folded down and made a canopy under which a man could lie and look at the flow and vitality of Cannery Row”*. [] The protagonist of the story is Doc, a biologist, owner and manager of a Western Biological Laboratory, collects water animals from the shores of California and studies them. He is engaged in sending many living things he has collected to the Universities of the country, laboratories and museums. Throughout the story the author describes that Doc is ready to help the people around him. Therefore, Mack and his friends also want to cheer him up in order to thank in return. *“It is said that he has helped many a girl out of one trouble and into another, Doc has the hands of a brain surgeon, and a cool warm mind. Doc tips his hat to dogs as he drives by and the dogs look up and smile at him”*. [] The protagonist is a person who stretches out his hand of help to the people around him, able to make friendly compromises with everyone. Although his profession is a biologist, but people who know him are helped by him as a person aware of any field. But Doc is also a person with some lacks in his character, *“when passionate anger comes on him he can be very fierce.....He can kill anything for need but he could not even hurt a feeling for pleasure”*. [] The writer describes his protagonist as a person who, if he is angry, cannot behave, can bring anything to hurt if there is a need, but for fun he does not anything or anyone. Thanks to his spiritual support, the fate of many people changes to the positive side. The author points out that even a single person can



spread positive features as mutual respect, kindness, generosity and exaltation in society and change the social environment towards goodness.

### III. RESULTS AND DISCUSSIONS

All the characters in “Cannery Row” try to please Doc, with the hope to respond his goodness. The same goal unites all the people in the work. The fate of Frankie is poignant. Being dismissed from school for mental problem, the boy is alone in the street without any shelter. His mother gives up him as she thinks that he is a burden for her. Frankie finds warmth in relations with Doc and a 10-year-old boy steals a bronze statuette clock to please Doc in the party being organized by Mack and his friends. His mother, who has given up the responsibility of motherhood, blames Doc in this situation. With this episode the author describes human love, which is shown to a child who does not even have a relation in the society to anyone at all. It is clearly reflected that Doc is sincere and kind person to totally strange one. *“Frankie,” he said, “why did you take it?” Frankie looked a long time at him. “I love you,” he said*. [] The sentence “I love you” and a glance reflect real human features. The fate of this child, who has not yet reached adulthood, has not developed mentally, but is waiting for salvation in the face of cruelty of life, while having a living mother who cares for him, shakes each soul. In a society built on interests, the power that actually unites people, leading them to kindness is described in bright colors by the author through the episode about human kindness. The relationship of people living on the small street is opposed to the image of people who live in a big city.

In novel not only Doc’s characteristic features in uniting people around him, but also his inner world is reflected. Although those around him feel themselves indebted to, Doc feels very lonely. When he goes to the beach to collect marine animals, he spends his hours there. He listens to the soul of all characters and does not spare advice, support. But there is not any person who Doc can share his problems with. Because in this small team, both in terms of knowledge and in terms of life experience, only Doc has an advantage. However, he is not ventilated from this and therefore all people around him do not avoid from him. As he behaves the way that the others accept, it makes him become the person who unites together all people in Cannery Row. By describing Doc’s relation with the surrounding simple and sincere people, Steinbeck criticizes the people of his own time who are interested in wealth and do not help others at all.

One of the noticeable female characters is Dora. She also lives in Cannery Row, though her behavior is always under discussion in this small society, but she follows the rules strictly. As the owner of the Bear Flag restaurant she does not sell any alcohol drinks, or she controls the costs of the services and tries to do them affordable for the indigenous people of the street. Beside she always keeps under control not to use any vulgar words in the restaurant. She is treated well by mostly men in the street, because women hate her. But she helps to all people who are in difficult situation not paying attention whether this is a man or woman. During economic crisis in the country she made great charities, paid some peoples’ debts, brought up some children herself, supported the families where men could not provide the members. As a result of it she nearly went bankrupt. *“Dora who, madam and girl for fifty years, has through the exercise of special gifts of tact and honesty, charity and a certain realism, made herself respected by the intelligent, the learned, the kind”*. [] Dora is one of the complex characters in the novel. Steinbeck points out that each person living in the world has his or her own responsibilities. She is also the woman who is not only mother but also nurturer to the men of the street. She always helps the men who could not cope with their responsibilities spiritually and materially in their life.

#### IV. CONCLUSION

John Steinbeck described characters and their relations towards each other in Cannery Row. Doc is depicted as a person who unites Lee Chong, Mack and his friends, Dora and her girls, Frankie and others. The author reiterates that only personal features as kindness, generosity, sincerity can lead the members of any society towards goodness. In “Cannery Row” through the characters’ relationship the writer proves this truth.

#### REFERENCES:

1. American literature of the XX century. A group of writers (2005) USA: Boston University Press.
2. Baturin, S. (1984) Djon Steynbek i tradisii Amerikanskoy literaturi. Khudojestvennaya literatura. S. 351.
3. Benson, Jackson (1977) John Steinbeck's Cannery row: a Reconsideration. - Western American Literature. Vol. 12, No.1. - P. 11-40.
4. Ganieva, O. K. (2020). The essential literary criticism of John Steinbeck’s “The pearl” and Odil Yakubov’s “Mukaddas”. ISJ Theoretical & Applied Science, 05 (85), 747-750.
5. Ganieva Orzigul Khayriddinovna and Chariyeva Mekhriniso Jahonovna, “DESCRIPTION OF THE RELATIONSHIP BETWEEN PEOPLE AND SOCIETY IN JOHN STEINBECK’S ‘THE GRAPES OF WRATH’”, IEJRD - International Multidisciplinary Journal, vol. 6, no. TITFL, pp. 75-78, Apr. 2021.
6. Mulyarchik A.S. (1988) Sovremenniy realisticheskiy roman SSHA. 1945-1980. Moskva: Visshaya shkola. C.177
7. Osmukhina O.Y. (2018) “Problema cheloveka v romanax Dj. Steynbeka “Grozdy gneva” i “Zima trevogi nashey”” Filologicheskiye nauki. Voprosi teorii i praktiki. Tambov: Gramota,. № 3(81)
8. Ulughov A. (2011) Images of the heart in the stories. Shark yulduzi. № 4. P 137-141.
9. Steinbeck J. (1993) The Grapes of Wrath. Introduction by Brad Leithauser. UK.: David Campbell Publishers Ltd. P.578.
10. <https://www.6lib.ru/books/Cannery-Row-198401.html>

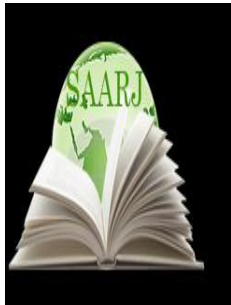

**ACADEMICIA**  
**An International  
 Multidisciplinary  
 Research Journal**  
 (Double Blind Refereed & Peer Reviewed Journal)



**DOI: 10.5958/2249-7137.2021.01245.3**

## THE IMPORTANCE OF INTRODUCING INNOVATIVE EDUCATIONAL TECHNOLOGIES IN SOCIAL DEVELOPMENT OF SOCIETY

**Diloram Kambarova\***

\*Associate professor,  
 Candidate of pedagogical sciences,  
 Fergana State University,  
 UZBEKISTAN

### ABSTRACT

*The analysis of pedagogical research conducted in the country shows that the technologicalization of the educational process is closely linked with innovative ideas that reflect the status of pedagogical innovations. Improving the effectiveness of education and the introduction of innovative developments in the field of science will serve to increase the intellectual potential of consumer students and learners. This article scientifically examines the importance of the introduction of innovative educational technologies in the social development of society.*

**KEYWORDS:** *Civil Society, Pedagogy, Innovation, Educational Efficiency, Innovative Education, Information Technology, Pedagogical Skills.*

### INTRODUCTION

It is known that the formation of spiritual maturity in young people is one of the foundations of the formation of civil society. Today, the upbringing of a spiritually and physically harmoniously developed generation is an urgent task for us on a national scale. Consistent and decisive continuation of our work on the way to this noble goal is today at the center of our policy.

Educating young people in the spirit of patriotism and respect for our national values, protection from various ills and threats, increasing the effectiveness of propaganda work is one of the pressing problems of today.

In the process of reforming the development of a new society in Uzbekistan, it is important to study the theoretical and practical aspects and experiences of the creation of the foundations of civil society in different countries of the world at different levels and periods. Civil society is a

certain social system that guarantees every citizen of this country full freedom to build his economic and political life at his own discretion. Civil society is formed in harmony with the increase in self – awareness of people, their ability to feel a sense of responsibility in the object.

### **Main part**

Nowadays, in our society, everyone has the right to receive education in any field, regardless of his level of primary education. It is known that such concepts as innovation in pedagogy, innovative activity, innovative pedagogy, management of innovation processes in computer education appeared in the 60s of the XX century while the concept of "Educational Technology" was recognized in the United States and Western Europe. These concepts arise as a result of technologicalization of the education system, reform of the education system through the introduction of new innovative pedagogical technologies in the computer education system, increasing the effectiveness of education, ensuring socialization of the individual, trying to form student-friendly relations in the educational process.

“For thousands of years, the history of mankind has neglected young people as a separate social class, an equal member of society. Finally, with the emergence of buds and elements of civil society, the issue of the role of youth in society began to rise”[1, 312]. In line with the requirements of today’s rapidly evolving era, many pressing challenges have arisen due to the need for a new approach to achieving educational effectiveness. Therefore, the teacher must have professional skills, be able to use new modern educational technologies that meet modern requirements. While participating in the process of educating a harmoniously developed generation, a teacher should not only be an example to others with his spiritual and moral culture, but also be able to demonstrate his pedagogical skills, make a worthy contribution to the training of qualified personnel as a mature teacher. “Any pedagogically correct activity affects the mental and volitional development of an individual. This means that as a child grows up, his activities change in form and content”[2, 35].

### **DISCUSSION**

An educator is a highly qualified specialist, who has a deep knowledge of his subject, a good knowledge of general and student psychology, and a perfect knowledge of teaching methods. “The activity of a modern teacher should be evaluated not from the point of view of an ordinary methodologist who transmits knowledge, but from the point of view of a “Teacher technologist”. Technology is a pedagogical activity that incorporates the laws of teaching, educating and developing the individual and ensures the end result”[3, 290]. “All countries strive to innovate as much as possible in education... Innovation is a long-term investment for the future ...”[4, 26]. Thus, the reliance on pedagogical technologies and the pursuit of innovation in education, the use of various interactive methods aimed at the active participation of students, contribute to the effective implementation of educational goals.

New information and innovative technologies involve the use of new methods and approaches to increase and strengthen students' knowledge in the educational process. At the same time, in the context of the evolving process of informatization of society, issues aimed at preparing students for independent living, the formation of their talents, abilities, aspirations and interests play an important role.

Today's globalization process, along with the modernization of society, bypasses any society or state. Therefore, their positive and negative effects are seen in social life, especially in the case of young people who have the power to influence the country's future. Particularly the currents that are trying to influence our youth in various ways, the so-called "mass cultures" are aimed at provoking youth in such a way as national identity, patriotism. The ability to withstand such modern threats is a time-consuming use of national spiritual heritage and Islamic culture, which is a national idea and its basic principles in the implementation of the country's strategic goals and objectives.

The genesis of socio-cultural technologies in scientific management of society is the development of science, the rise of human thinking and scientific knowledge. The solution of existing problems in the society is related to innovative activities. The genesis of socio-cultural technologies is also closely linked to the development of "technology". The Decree of the President of the Republic of Uzbekistan dated September 8, 2017 "On approval of the concept of administrative reform in the Republic of Uzbekistan" was important.

Innovations are up-to-date, important, new approaches formed in a system. They are born on the basis of initiatives and innovations and are promising for the development of educational content. It also has a positive impact on the development of the education system as a whole. Innovation is the end result of a technology, form, and method in a particular field of activity or production, a new approach to solving a problem, or the application of a new technological process that is known to lead to greater success than ever before.

Improving the effectiveness of new innovative technologies in the educational process largely depends on the creative pursuit of teachers. Therefore, for the lesson to be interesting and effective, it is necessary to find new ways of pedagogical innovation, to select the most effective under in-depth analysis and apply it in practice. In fact, the term "advanced pedagogical experience" is used in two different senses to mean a teacher's high skill in a broad sense, i.e., a teaching practice that provides high pedagogical effectiveness. The concept of advanced innovative experience in a narrower, more rigorous sense combines elements of creative research, originality, in other words, innovation.

Today, there is a growing interest in the use of innovative technologies and interactive methods in the educational process. The use of such methods increases the effectiveness and efficiency of teaching, develops in students the ability to deepen the understanding of the content of the lesson.

Innovative methods of education allow students to use and activate the enormous educational power, to incorporate elements of competition into the learning process. Interactive teaching methods are among the innovations in education. According to Angelevsky, "all countries are trying to innovate education as much as possible". Today's news requires an organized, planned, public approach to them. News is a long-term investment for the future. In order to arouse interest in innovation, to cultivate a person who strives for innovation, education itself must be rich in innovations, in which the spirit and creativity of creativity prevail"[3, 26]. The tasks of new innovative pedagogical technologies include:

- development of new forms and methods of organizing the educational process in the acquisition of skills to work with modern teaching aids;

- conduct various tests from time to time on the organization of the educational process and the problems of research methodology;
- joint development and implementation of scientific and scientific-pedagogical methods with foreign educational institutions in the framework of international cooperation programs;
- implementation of the program of generalization of the accumulated foreign experience in training.

The organization of major changes and innovative processes in the educational institution will be aimed at achieving the main goal, in particular, should always be based on the implementation of a model of training educated and talented young people in line with socio-economic needs of society. The introduction of innovative approaches to the process of formation and development of pedagogical culture of students (updating educational programs) is also important.

### CONCLUSION

In general, the organization of innovative processes raises issues of research and application of modern pedagogical technologies, which are based on subject-subject, student and teacher relations. These relations are the basis for determining the general conditions of development, aimed at understanding the interests, abilities and qualities of the individual, and undoubtedly play an invaluable role in the development of society, especially in the development of pedagogical culture and environmental protection.

### REFERENCES:

1. Development strategy of Uzbekistan. Civil Society (Methodological Manual). Tashkent, Into Capital Group. 2019 y.
2. Mavlonova R. and others. Pedagogy: a textbook for students of faculties of primary education methods of higher education, students of pedagogical lyceums and colleges. Tashkent, "Teacher", 2001.
3. N.Boymurodov. Applied psychology. Study guide. Tashkent, 2008
4. S.Maxkamova. Pedagogical technologies: concepts, principles and methods of implementation. Tashkent, 2003.
5. Karimov, U., Kaxarov, S., Yokubjonov, S., &Ziyodov, D. (2018). USING NEW INFORMATION TECHNOLOGIES IN DISTANCE LEARNING SYSTEM.In *НОВАЯПРОМЫШЛЕННАЯРЕВОЛЮЦИЯВЗЕРКАЛЕСОВРЕМЕННОЙНАУКИ* (pp. 9-11).
6. Abdurakhmonova, M. M., ugliMirzayev, M. A., Karimov, U. U., &Karimova, G. Y. (2021). Information Culture And Ethical Education In The Globalization Century. *The American Journal of Social Science and Education Innovations*, 3(03), 384-388.
7. Karimov, U., &Abdurakhmon, A. (2017). INNOVATIVE INFORMATION TECHNOLOGY IN EDUCATION. *Форуммолодыхученых*, (5), 9-12.
8. Yahyo, Muhammad Amin. Protection from internet threats.Supporting tutorial.Tashkent, 2016.
9. Ziyomukhammadov B. Pedagogy. Toolkit. Tashkent, 2006, p. 37.

10. Karimov, U., & Ergasheva, D. (2020). EDUCATIONAL ISSUES IN THE PERIOD OF AMIR TEMUR AND TEMURIDS. *Теория и практика современной науки*, (5), 18-20.
11. M. Tojiyev, R. Salaxutdinov. Modern information technologies in the educational process. Tashkent, 2001.
12. Karimov, U., & Kasimov, I. (2018). THE IMPORTANCE OF MODERN INFORMATION TECHNOLOGIES IN DEVELOPMENT OF DISTANCE EDUCATION. In *Перспективные информационные технологии (ПИТ 2018)* (pp. 1186-1187).
13. Каримов, У. У. (2017). РОЛЬ СРЕДСТВ МАССОВОЙ ИНФОРМАЦИИ В ПРОЦЕССЕ ГЛОБАЛИЗАЦИИ. In *Перспективные информационные технологии (ПИТ 2017)* (pp. 1189-1192).
14. Каримов, У., Хакимова, Д., & Халилов, Л. (2018). ИНФОРМАЦИОННОЕ И КОММУНИКАЦИОННОЕ ТЕХНОЛОГИИ ВЛИЯНИЕ НА ОБРАЗОВАНИЕ В ТЕХНИЧЕСКОМ ОБСЛУЖИВАНИЕ. *Мировая наука*, (10), 193-197.
15. Каримов, У., & Каримова, Г. (2018). ГЕОПОЛИТИЧЕСКАЯ КОНКУРЕНЦИЯ В ИНФОРМАЦИОННОМ ПРОСТРАНСТВЕ. In *Перспективные информационные технологии (ПИТ 2018)* (pp. 1368-1372).
16. Каримов, У., Хакимова, Д., & Тулкинов, З. (2018). ЗАДАЧИ ПОСТРОЕНИЯ ГРАЖДАНСКОГО ОБЩЕСТВА. *Теория и практика современной науки*, (10), 193-195.
17. Sh. Azizov. Human and society. Textbook. Tashkent, 2010.
18. Каримов, У. (2017). ИНФОРМАЦИОННЫЕ ТЕХНОЛОГИИ (ИКТ) ФОРМИРОВАНИЕ ДУХОВНЫХ ХАРАКТЕРИСТИК ЛИЧНОСТИ. In *Перспективные информационные технологии (ПИТ 2017)* (pp. 1160-1163).
19. Normatova D. E. PECULIARITIES OF ANTHROPOCENTRISM AND HUMANISM OF THE SOCIO-PHILOSOPHICAL THOUGHT OF WESTERN EUROPE IN THE ERA OF RENAISSANCE // *Scientific Bulletin of Namangan State University*. – 2019. – Т. 1. – №. 5. – С. 168-173.
20. Normatova, D. E. (2021). The Development Of Socio-Philosophical Thought In Western Europe On The Eve Of The End Of The Renaissance. *The American Journal of Social Science and Education Innovations*, 3(03), 371-377.
21. Normatova D. E. THE SOCIAL AND MORAL VIEWS OF MICHELLE ECKEM DE MONTEN // *Scientific Bulletin of Namangan State University*. – 2019. – Т. 1. – №. 10. – С. 184-187.
22. Abdullaev M., Abdullaev A. History of spirituality and culture. Fergana, 1998.
23. Otamuratov S., Khusanov S., Ramatov Yu. Basics of spirituality. Toolkit. Tashkent, 2002.
24. Imomnazarov M., Eshmukhamedova M. The foundations of our national spirituality. Texts of lectures. Tashkent, 2001.

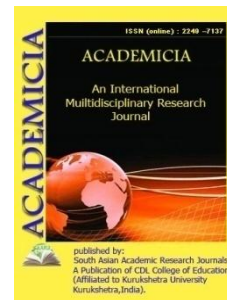
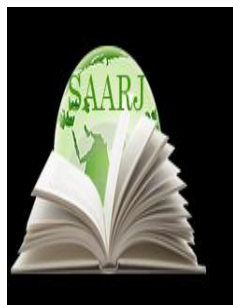

DOI: **10.5958/2249-7137.2021.01247.7**

## INTERDISCIPLINARY BINARY LECTURE AS A METHOD OF TEACHING AT TECHNICAL UNIVERSITY

**Avdeeva A. N\*, Filimonova L. Yu\*\***

\* PhD Associate Professor,  
Candidate of technical sciences,  
Department of Materials Science and Mechanical Engineering,  
Tashkent State Transport University, UZBEKISTAN  
Email id: nyusik22@mail.ru

\*\*Assistant,  
Department "Foreign Languages",  
Tashkent State Transport University,  
UZBEKISTAN  
Email id: victor\_p54@mail.ru

### ABSTRACT

*The article discusses the joint teaching of a technical discipline and English as an option for conducting an interdisciplinary binary lecture. The stages of preparation and implementation of this model of the classroom lesson are considered, as well as the positive and negative aspects of conducting a lesson by two teachers simultaneously. An opinion is expressed on the obligatory presence of the lesson plan, in which all possible bifurcation moments of the lecture are spelled out. It is concluded that an interdisciplinary binary lecture is a modern interactive teaching method that allows you to activate the audience's attention, increases the percentage of assimilation, reveals the potential of teachers, increases the professional competence of teachers, and motivates students to further study.*

**KEYWORDS:** *Lecture, Binary Lecture, Interdisciplinary Binary Lecture, Psychological Compatibility, Interactive Lecture, Bifurcation Moments Of The Lecture, Pedagogical Scenario.*



## INTRODUCTION

In Uzbekistan, on the background of a radical reform of higher education, the number of talented students studying in prestigious foreign educational, scientific and other institutions is increasing every year. Since April 1, 2021, the number of young people sent to study for Master's and Doctoral degrees at prestigious foreign universities through the 'El-Yurt Umidi' Foundation, which was created in accordance with the Decree of the President of Uzbekistan dated September 25, 2018 [1], has increased by 5 times. To obtain fundamental knowledge of the world science, undergraduates and doctoral students must not only know the basics of their specialty and be fluent in general English, their vocabulary must include the terms of the specialty being studied. Uzbekistan is located in the post-Soviet space, and all training is conducted either in Russian or in Uzbek. The volume of the school and university curriculum of the English language is sometimes not enough, and requires additional improvement of the technical vocabulary for a student who decides to continue his studies abroad. Therefore, it would be advisable to combine the study of the specialty with the study of the English language directly at the lecture in the disciplines of the studied specialty. One of the methods for studying specialized, for example, technical English vocabulary, is an interdisciplinary binary lecture. This teaching methodology will allow all students of technical universities to use the world technical literature in its original source, written in English.

## LITERATURE REVIEW

The very idea of inter disciplinary teaching is not new; great teachers of the past, such as Ya.A. Komensky, K.D. Ushinsky, N.K. Krupskaya, A.A. Smirnov, G.K. Selevko, Yu.A. Samarin were interested and considered this issue in their works. The teachings of Ivan Pavlov, the great Russian physiologist introduced the psychological foundations of interdisciplinary relations. He wrote that our mental activity is a chain of irritations and associations. L.S. Vygotsky argued that any new stage of generalization arises only on the basis of the previous ones [2, p.59-73]. The naturalness of the use of interdisciplinary lectures is based on the principles of thinking ability of a student, as well as of any person, and should be structured according to the laws of both physiology and psychology. A binary lecture is a lecture delivered by two teachers at the same time and at the same place. The main goal of a binary lecture, as well as an interdisciplinary one, is the active involvement of students into the thinking process. There are several varieties of this type of classroom activity, depending on the type of specialist duo. It can be a mentor-lecturer and an intern-teacher leading practice, or there can be two highly qualified professors, but having different points of view on the topic of the lecture. The union of lecture presenters may consist of a lecturer and a student, who prepared presentation on the given topic, or there may be two teachers of related disciplines, or one of the specialists is invited from the factory, who is a highly qualified practitioner. In this article, it is proposed to combine the study of the specialty with the study of "technical" English vocabulary, and accordingly the lecturer of the technical discipline and the teacher of the English language act as the leading binary lecturers.

**Methodology for preparing and delivering an interdisciplinary binary lecture.** When preparing and conducting an interdisciplinary binary lecture, numerous difficulties arise, therefore, at the present stage teachers practice only one or two lectures per semester. It is most advisable to choose an overview as introductory, overview as final lecture or, at the discretion of the lecturer in the specialty, the most important lecture of the discipline, in the content of which there is a maximum number of new terms and a high degree of complexity. Already at this stage,

the first difficulty arises, since when choosing the "central" topic of the subject, the English teacher needs to master not only the terms, but also the general technical meaning of the selected material.

At the second stage of preparation, for an effective classroom lesson, it is necessary to select two teachers who are intellectually and psychologically compatible, since an interdisciplinary binary lecture is a mini performance in which students receive not only knowledge, but also acquire the skill of communication culture and dialogue. At the same time, the manner of material presentation among teachers can be completely different. For example, one of the teachers is used to explaining emotionally, using gestures and facial expressions, and the other, gains attention by quietly and calmly conducting the lesson. Mixing styles will add intrigue, which will attract the maximum number of listeners to the process of mastering new material. Transferring a lecture from a passive to an active level is one of the main methodological tasks of the proposed method. Another goal of a binary lecture is the inevitable exchange of experience between teachers.

At the third stage of preparation, a lesson plan for the lecture is developed: the volume of scientific material is determined, which is immediately divided into blocks, according to content and time [4]. It is preferable to conduct the first lessons with a written script, but with the acquisition of experience, you can get by with a verbal agreement. When giving a lecture, simultaneous translation into English is not done so as not to waste almost half of the classroom time. To check the technical material acquisition, after each block, the English teacher, using one of the question and answer methods, for example, the "funnel" method, in English, asks questions from the most general to more specific, using new terms [5, 6]. Each question that will be asked, as well as possible answers, are written in the script. If errors arise in the understanding of terminology, then the correction continues in English, and if the student does not have an understanding of the lecture material meaning, then there is an extended explanation of the technical meaning of the topic in Russian.

Let's take an example, the lecture on the discipline "Theory of mechanisms and machines" is being conducted and after the block of material on "geometrical dimensions of gearing", provided at the lecture in the Russian language, the teacher asks in English: "Which of the listed parameters is the main one through which all the rest can be calculated?". The student replies in English that this is a "engagement module", but he did not understand why it can be assigned and calculated. In this case, the explanation continues in Russian. If the respondent in the answer used not "engagement module", but "engagement unit", then the incorrect use of the term is clarified in English. And only after that clarifying the main lecture can go on with the next block of new topic material, but meanwhile giving way to the English teacher, who can check understanding of the previous block once again.

Initially, it is assumed that a binary lecture is a constant improvisation in the behavior of the presenters. Yes, teachers' speeches should be natural and unconstrained, but before the start of the lesson, they must have a behavioral scenario, especially the bifurcation moments of the lecture [7]. Putting it differently, we can say, that every improvisation must be carefully prepared. An experienced teacher will always keep in mind several possible variants of the present material explanation, and he or she can use two or three of them at the same lecture.

The behavior patterns of students are quite predictable, and there are many pedagogical and psychological techniques of interaction with the students at the lecture. Now any kind of lecture is interactive as the teacher will never leave the classroom without arranging feedback of the students in any form: oral or written, questions and answers, completing some statements by the students, etc.

### **Main results and conclusions**

An interdisciplinary binary lecture is a special lecture in which two teachers of different disciplines participate. The purpose of the interdisciplinary binary lecture is to activate the thinking process of students. On the one hand, when perceiving a binary lecture, difficulties arise, since the focus of attention is bifurcated, on the other hand, it is the differences in behavior styles that increase concentration of attention and give a large percentage of residual knowledge. In such classes, the ability to adequately reflect on non-standard situations increases, the creativity of both students and teachers develops, reveals new forms of professional communication, creates conditions for the implementation of the creative potential of teachers, in other words, increases all aspects of professional competencies of teachers.

An interdisciplinary binary lecture is definitely an up-to-date and interactive method for preparing bachelors for further training in prestigious foreign educational and scientific institutions. This is an effective way of non-traditional organization of the educational process. "Lecture for two" is an impulse for the personal and professional growth of lecturers for whom classical teaching methods are not enough.

### **REFERENCES:**

1. NormaUz information and legal portal <https://www.norma.uz/> novoe\_v\_zakonodatelstve / rasshireny\_zadachi\_fonda\_el-yurt\_umidi
2. Kutuzova G.I. Interdisciplinary Relations in Teaching Foreign Students), St. Petersburg: Poltekhn. University, 2008.-379 p. (Education and pedagogy at the Polytechnic University). ISBN 5-7422-1716-1
3. Ibragimov G.I. Lecture at the university: theory, history, practice: monograph / G.I. Ibragimov, R. G. Gainutdinov; ed. G.I. Ibragimov. - Kazan: Editorial and Publishing Center "School", 2017. - 196 p.
4. Avdeeva A.N. Principles of constructing and conducting an interactive lecture // Bulletin of science and education. - 2020. - No. 8-1 (86).
5. Avdeeva A. N. SOME ASPECTS OF THE METHOD FOR ASKING QUESTIONS AND ANSWERS WHEN CONDUCTING AUDITING LESSONS // Bulletin of Science and Education. 2020. No. 20-2 (98). URL: <https://cyberleninka.ru/article/n/nekotorye-aspekty-metoda-postanovki-voprosov-i-otvetov-pri-provedenii-auditornyh-zanyatiy> (date accessed: 04/26/2021).
6. Avdeeva A.N. Questioning as a teaching method // ACADEMICIA: International interdisciplinary research journal. - 2020. - T. 10. - No. 4. - P. 627–630.

7. Avdeeva Anna Nikolaevna INTERACTION WITH PROBLEM STUDENTS IN THE PROCESS OF AUDITING TRAINING // SCIENTIFIC RESEARCH AND DEVELOPMENT 2020. - 2020. - pp. 57-60
8. Avdeeva A. N. Strategy for attracting attention in the process of classroom training // SCIENCE 2020. THEORY AND PRACTICE. - 2020. – p.36-38
9. Avdeeva A. N. Techniques of constructive influence in the process of interactive learning at the university // World Science 2020. Problems and Prospects: Materials of the II International Scientific and Practical Conference (April 9, 2020, Moscow) Saratov: Publishing House of the Center for Contemporary Arts "Academy of Business", 2020. pp. 31-33. ISBN 978-5-907199-74-3

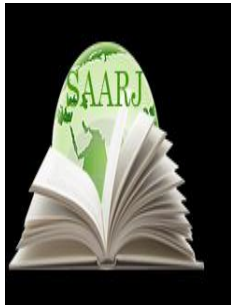

**ACADEMICIA**  
**An International**  
**Multidisciplinary**  
**Research Journal**  
**(Double Blind Refereed & Peer Reviewed Journal)**



**DOI: 10.5958/2249-7137.2021.01248.9**

**BIO ECOLOGICAL CHARACTERISTICS OF CLIMATIC LANDSCAPE  
PLANTS OF FERGANA CITY**

**D.M.Akhmedova\* ; N.Turdieva\*\***

\*Associate Professor,  
Fergana State University, Fergana,  
UZBEKISTAN

\*\*Master's Degree Student of Fergana State University,  
Fergana, UZBEKISTAN

**ABSTRACT**

*Today, more and more attention is paid to the creation of green areas in cities, and in our hot and dry climate, the importance of trees and shrubs, especially conifers and evergreens, is very high. In recent years, the number of ornamental coniferous trees and evergreen shrubs has increased in the city's greening system. Beautification of cities and villages in Uzbekistan in a modern style is an important state measure aimed at dramatically improving the living standards of the population.*

**KEYWORDS:** *Ecology, Vegetation, Landscape Design, Ornamental Plants, Nature, Ecological Culture.*

**INTRODUCTION**

In the early stages of human development, ecology plays an important role among people of this period. Ecology is a science much more ancient than the various drawings left by ancient people in caves and rocks. Every person who lived at that time knew about the state of the environment in order to avoid hunger, cold and heat, collect seeds and fruits of plants, catch animals and expose themselves to danger. They knew how to avoid and hide from enemies, natural disasters. Studying the power of nature, its laws and the influence of environmental factors on adaptation to these laws, people have been collecting information for years and centuries. Ancient Greek scientists such as Hippocrates and Aristotle described the ecological nature of approximately 500 plant species and 454 animal species. For example, in his scientific works, Aristotle described the life and distribution of more than 500 species of animals, birds and fish, as well as their migration from one place to another. Galen and Theophrastus also written valuable information

about the life of different animals and their adaptation to nature.

### **Main part**

Today, it is advisable to solve the issues of environmental education and training when developing measures to prevent various environmental conflicts arising in the environment:

- 1) deeply teach everyone the laws of development of society and nature, teach the relationship between them, educate a person who can think in a modern way; take into account the ecological state of various natural areas in the direction of the productive forces of socio-economic development;
- 2) developing of environmental plans for the future and training of environmental specialists who will implement these plans;
- 3) continuous communication of each person, society and various groups and categories within society with the environment in which they live, aimed at preserving nature and its resources, as well as training qualified personnel in this area;
- 4) the importance of the beauty of the place where they live, valleys, groves, hills, mountains and streams, their importance for human life and health in the development of their social, cultural, religious views and traditions. Explain to the younger generation in order to instill in them a love of nature;
- 5) explain to the population the causes of various environmental conflicts, conduct environmental education and training among them, teach to develop and implement measures, methods to overcome environmental conflicts;
- 6) the fulfillment of the above tasks of educational work by educators of kindergartens, schools, higher and secondary specialized educational institutions in the course of various games, films, natural and social sciences in response to natural disasters and environmental conditions in their places of live.

### **DISCUSSION**

It is known that one of the main components of landscape design is ornamental shrubs. Trees and shrubs are not only a source of raw materials and various products, but also one of the main factors that improve the environment. The vital activity of the plant world affects the climate, i.e. it absorbs and neutralizes CO<sub>2</sub> and other harmful gases and smoke in the air, reduces the amount of dust in the city air, phytoncides emitted by trees kill pathogenic bacteria.

One of the main directions of development of ornamental horticulture in Uzbekistan is to increase the number of species of trees and shrubs that are biologically resistant to urban conditions for landscaping. Evergreen and flowering shrubs are also one of the most important components of landscape design.

Landscape endemic and introduced plants are the beauty of alleys, parks and gardens, which are widely used as green adornments of architectural structures in cities, districts and villages.

Today it is necessary to reduce the impact of man-made factors in cities, improve the environment, protect human health, create new urban landscapes with unique architectural beauty, and introduce new trees and shrubs adapted to the climate of the region.

Chestnut, oak, tulip tree, black pine, Crimean pine, bird cherry, dzhuka, magnolia plants introduced on city streets, as well as chestnuts, oak, Crimean pine, meta grown in the climatic conditions of Uzbekistan in order to study the bioecological properties of aboriginal plants, such like sequoia, linden, virgin spruce.

During the observations, the tree branches were observed, which make up the bulk of the experimental areas. At the beginning of the year, phenological observations were carried out at the experimental sites, the results obtained were recorded in the established table of phenological observations.

A comparative analysis of the growth of branches according to the method of F.N. Rusanov (1970) was carried out at different ages in the ontogeny of species of the genus *Picea*.

The association of trees with low winter and high summer temperatures was determined twice a year during the tree inventory in the autumn and spring months.

The relation of spruce to light was studied on trees of different ages. The level of illumination was determined by natural and artificial dimming (umbrellas, gauze). The effect of light on the growth and development of trees was determined by the order and number of branches, the annual growth rate of branches, the size of the upper and side branches, as well as the number of leaves in branches aged 5-7 years.

In 2014-2015, with the introduced forms of chestnut, oak, tulip plants, the growth and development of local plants, adaptability to the environment, morphological, biological, ecological characteristics of plants were monitored.

According to the observation results, it can be noted that in September-October 2014, the ecological mortality of chestnut plants imported from abroad increased by 15%, which is associated with a decrease in temperature in winter and spring 2015 by 20% in oak. 5% in 2014, 15% in 2015, 18% in tulips in 2014 and 20-25% in 2015.

It was found that local chestnuts 10% in 2014, 15% in 2015, 3% and oaks lost 5% in 2014 and 2015.

In addition, the growth and development of local and introduced shrubs, such as black and red barberry, David's budley, Japanese beech, Magonia, Chubushnik, Pyrrakanta Smarodina, Elderberry, Tobulga, Sirena, Kalina, Veige, imported in the course of our research, showed resistance to external factors, climatization of plants were observed in the indicated order.

Revealed the need to examine the root and root collar of the plant to determine the symptoms of root cancer. With sharp changes in temperature day and night, cracks were found on the surface of some leaves.

In view of the above, the cause of the disease can be attributed to a change in the water regime and temperature. As a result, the plant suffers from metabolic disorders, first of all, spots that do not contain chlorophyll, which leads to yellowing and darkening of the leaf surface, slowing down the growth of the stem. In order for the seedlings to germinate well, first of all, it is necessary to take into account the soil and climatic conditions, and also after each watering the seedlings should be thinned and loosened. An excess of water and a solution of mineral fertilizers used to preserve the greenery of these lawns will fill the first hole or well when preparing ornamental trees for planting, slightly moistening the root system of the seedlings,

affecting the circulation of root air, reducing metabolism and, ultimately, leading to yellowing of the leaves slowing down the growth of annual plant stems.

Because this is due to the fact that in some of the surveyed areas the soil in the pits under the seedlings turned out to be in a sticky clay state, despite the fact that the lawn was watered for several days. It should be noted here that ornamental trees brought in for the alley require special care for their full development. When they are fully developed, they need to be brought to the lawn.

In the fall and winter, when the seedlings were transplanted from one place to another, the trees were found to dry out in early spring due to shallow planting of trees and successive floods and, in some cases, sudden cooling of the air. Therefore, when planting on seedlings, if the root collar is covered with 5-10 cm of excess soil, the above situation is not observed. This is due to the fact that one of the main reasons that some chestnut, oak and pine seedlings of the same species grow and dry out is that the wrong agrotechnical measures were taken when they were planted.

### CONCLUSION

It is necessary to pay attention to suitable for planting in cities, which has a valuable scenic view, strong and durable, like conifers, such as pine, spruce, biota, metasequoia, spruce, linden, artificial chestnut, scarlet, coniferous oak, suitable for planting in cities, strong and durable and with a valuable scenic look, Norway maple, tulip tree, magnolia, catalpa, linden, sophora, small-leaved linden, ornamental shrubs, magnolia, common lilac, Indian lilac, fortification, yucca, viburnum, buldanezh, rosemary.

### REFERENCES:

1. G.H. Hamidov, R.S.Makhsudova, M.Yuldasheva. "Industrial Botany". Fergana, 2011.
2. A.Muhamedjanov, E.Berdiev. "Ornamental trees and shrubs". Tashkent, 2018.
3. A.Kayumov. "Landscaping of residential areas". Tashkent, 2013.
4. A.Ergashev, T.Ergashev. Ecology, biosphere and nature protection. Tashkent. New Generation, 2005.
5. Zokirov T.C., "Ecology of cotton field". Tashkent, 1991.
6. Majidov T. Unconventional and renewable energy sources. Tashkent, 2014.
7. Shodimetov K. Use of alternative energy sources and its economic prospects. Tashkent – "ILM-ZIYO" – 2014.
8. Shodimetov K. The development of alternative energy is a strong social protection factor. Tashkent, 2013.
9. Allaev K. Electric power industry of Uzbekistan and the world. Tashkent, 2009.
10. Ibrahimov O., "Cotton fructification and its control factors". Tashkent, 1992.
11. Abdurakhmonova, M. M., ugliMirzayev, M. A., Karimov, U. U., & Karimova, G. Y. (2021). Information Culture And Ethical Education In The Globalization Century. *The American Journal of Social Science and Education Innovations*, 3(03), 384-388.



12. Butaboev, M. T., & Karimov, U. U. (2020). «ЗЕЛЁНАЯ ЭКОНОМИКА». МИРОВОЙ ОПЫТ И ОСОБЕННОСТИ РАЗВИТИЯ В УЗБЕКИСТАНЕ. *Theoretical&AppliedScience*, (2), 704-710.
13. Бутабоев, М. Т., & Каримов, У. У. (2020). ПЕРЕХОД К «ЗЕЛЁНОЙ ЭКОНОМИКЕ» И ОСОБЕННОСТИ ЕЁ РАЗВИТИЯ В УЗБЕКИСТАНЕ. *Интернаука*, 23(152 часть 2), 41.
14. Каримов, У. У. (2017). РОЛЬ СРЕДСТВ МАССОВОЙ ИНФОРМАЦИИ В ПРОЦЕССЕ ГЛОБАЛИЗАЦИИ. In *Перспективные информационные технологии (ПИТ 2017)* (pp. 1189-1192).
15. Каримов, У., & Каримова, Г. (2018). ГЕОПОЛИТИЧЕСКАЯ КОНКУРЕНЦИЯ В ИНФОРМАЦИОННОМ ПРОСТРАНСТВЕ. In *Перспективные информационные технологии (ПИТ 2018)* (pp. 1368-1372).
16. Akhmedova D., Nazarov M. Influence of environmental factors on bio-ecological features and its productivity". Ferghana, 2019.

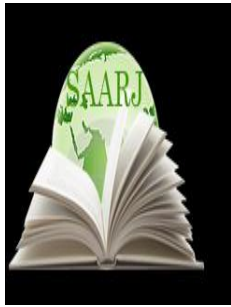

**ACADEMICIA**  
**An International  
 Multidisciplinary  
 Research Journal**  
 (Double Blind Refereed & Peer Reviewed Journal)



**DOI: 10.5958/2249-7137.2021.01249.0**

## TIPS AND TRICKS FOR LEARNING ENGLISH

**Ataeva G.B\* ; Kurbanova M.M\*\***

<sup>1,2</sup>Lecturers,  
 Tashkent State Transport University,  
 Tashkent, UZBEKISTAN

---

### ABSTRACT

*How to learn English using hypnosis and NLP methods in just 2 months from this article you will not learn. But we will tell you what features of the psyche can be used for more effective and faster learning of the English language. These techniques will not harm your mental health, but can also make it much easier to learn and remember new information.*

**KEYWORDS:** *Psychological Phenomenon, Psychological Effect, Learn In A New Way, Memory, Perception*

---

### INTRODUCTION

In the 21<sup>ST</sup> of century methods of learning language has been changing dramatically. Not only linguists and philologists develop methods but psychologists also do different investigations in this field. And researches show these effects are showing its efficiency. Psychological effects and tricks to help you learn English:

#### ***1. The effect of the "yellow marker" or the effect of isolation***

This psychological phenomenon lies in the fact that we perfectly remember an object that stands out against the background of other identical objects. For example, when you walk down the street, dozens of people pass by. In the evening, you hardly remember passers-by in office suits or ordinary outfits, but you will not forget a strange girl in an acid-colored dress and with a mohawk on her head for at least a couple of days.

By the way, this method is actively used by the media to manipulate our consciousness. So, some insignificant events are sometimes inflated to unprecedented proportions with the help of interesting reports, impressive photographs, etc. Usually this is done to divert our attention from some more important topic that they want to "hush up".

How to use: Suppose you have a word that you cannot remember, such as comb (comb). Try to "incorporate" this word into a selection of contrasting words: write yourself a list of 9 words on "food" (or any other non-beauty topic), and the last one is comb. Now learn these ten words the way you are used to. You will see that the "contrasting" word comb was the first to be remembered and firmly entrenched in memory. This way you can learn all the words that you often come across, but cannot remember.

In addition, you can use this effect in other ways, the main goal of which is to make the learning process memorable, clearly standing out against the background of the techniques that you have used before. Try:

Underline or highlight the phrases you want to learn. The simplest but very effective technique. And some linguists advise writing with a colored pen or typing in bright colors new vocabulary or words that you cannot remember the spelling. The brain will gladly perceive the brightly highlighted information.

Speak or hum the words you are learning loudly. This method is recommended by many linguists. Remember, as a rule, when studying words, we say them to ourselves or quietly pronounce them. If you try to learn in a new way, your memory will learn the material faster.

Study in an unfamiliar place. Psychologists recommend using this method when preparing for the exam. So, the material will be assimilated better if you study it in an unfamiliar environment for yourself, even if it will be a different room in your apartment. Better yet, go to study English in nature: according to studies, observing nature increases attention, memory, concentration by almost 20%. So, get off your monitor and head to the nearest park to learn English.

Draw what you are learning. This method is especially suitable for beginners who need to master basic vocabulary. Draw the word you are learning, for example, next to umbrella, draw an umbrella, next to door, a door.

## ***2. Audience effect***

This psychological effect works differently for all people. For example, some people calmly work in a separate office, where no one is watching them, where there is no "audience". Others, on the contrary, are activated when they are in the same room with colleagues and the boss, that is, in fact, they work in full view of the audience.

How to use: First, determine if you are motivated by the presence of people around you or, on the contrary, you are ashamed of them. Based on this, you can choose the most productive way to learn English. So, if you love the spirit of competition and are not afraid to sometimes make mistakes in public, go to study English in a group course. If the presence of outside observers confuses you, learn the language with a personal teacher or on your own.

## ***3. The charisma effect or the Dr. Fox effect***

This is a very interesting phenomenon that is often used by salespeople, sales managers, marketers and other people who want to sell you something. The effect is that the charisma of the person who tells you something is much more important than WHAT he tells you. That is, a charming salesperson can easily sell you a "hello from the 90s" style carpet, even if you came to the store for sausage.

How to use: Carefully weed out all the information that comes to you about learning English. For several years now we have been observing a tendency for skilled speakers to confidently sell dubious products to those wishing to learn English: a super method of learning 999 words in 30 minutes, an English course "for the weak-minded", etc. These people speak so interestingly that they just want to buy another "super-tablet for problems with English" and solve all the problems in one fell swoop. At this moment, we need to remember about the Dr. Fox effect and think about whether it is worth believing the beautiful speeches. Remember the Russian proverb "All that glitters is not gold."

#### ***4. Authorship effect or generation effect***

This psychological feature is best manifested in adults and consists in the fact that a person best remembers the material that he himself invented. For example, if you write an essay, you will remember it better than the read text of someone else's authorship. And all because in the process of creating an essay, your brain was actively working and information was stored in your memory.

How to use: This effect can be used when learning new words or grammar structures. For example, you need to learn 7 new words. Make up a story with them, and you will remember them well. Studied they would rather construct - compose 10 examples of your own using this construct. In both cases, it is desirable that both the story and the examples concern you, give up abstract phrases.

#### ***5. Effect of unfinished action or Zeigarnik effect***

This phenomenon lies in the fact that we are better at remembering unfinished actions than completed ones. That is, if you did not complete something and were distracted, after a while you will perfectly remember what you were doing. If you have completed the task and only then switched to the next task, after a while the memory will erase the memories of the first task. That is why at school and university all our knowledge disappeared immediately after the exam.

How to use: In order for the information not to be forgotten, it is necessary that it remains relevant to you. That is, you cannot stop learning English, even if you have reached the desired level of knowledge. For example, keep watching movies and TV shows to get modern vocabulary from there, read books in English so as not to forget how to build English sentences correctly, etc.

#### ***6. Law of interest***

We think it is difficult to argue with this law: indeed, we easily remember what is interesting to us. For example, we can easily forget to buy bread, but we can tell the content of our favorite TV show, even if we are woken up in the middle of the night.

How to use: Only you can make English interesting. To do this, choose such methods of studying it that are pleasant to you. For example, you can learn English from movies and TV shows, songs and games.

#### ***7. The law of the beginning and the end or the law of retroactive and proactive inhibition***

According to this law, when studying any material, it is best to remember the first and last blocks of information. The fact is that each subsequent block of information worsens the perception of

the previous block, and at the same time, each previous block worsens the perception of the next one. For example, if you are reading some text in which some bright unusual events do not occur, then it is best for you to remember its beginning and end.

The Stirlitz method is based on these laws. This is the name of the manipulation technique when you state the most important information at the very beginning and end of a conversation. For example, if you ask the waiter to recommend you some dishes, then in most cases, stop at the first and last. Be careful: some restaurateurs are well aware of this law and force waiters to name stale dishes first and last in order to quickly sell them to guests.

How to use: First, you can separate blocks of information so that they don't follow one after the other. For example, learn 10 new words in the morning, as soon as you wake up, the first information that arrives in the brain will be well remembered. It is also effective to study something before bedtime: the last block of information received on that day will be stored in memory.

Secondly, you can structure your independent English lesson so that the most important exercises occur at the beginning and end.

### ***8. The paradox of choice***

You've probably all heard about this psychological phenomenon: the wider the assortment, the more difficult it is to make a choice. For example, you came to a cafe and decided to order a dessert. You open the menu hoping to quickly find your favorite cheesecake and ... you see 29 types of this delicacy. A simple and time-tested "Napoleon" modestly sheltered nearby. Psychologists say that in most cases you will choose "Napoleon" and do not want to understand the many varieties of cheesecakes.

How to use: A similar situation of choice constantly arises for an English learner: first, you must choose a way of learning the language. As soon as we have coped with this, we face another choice. If you decide to study with a tutor, you must choose courses or a personal tutor. If you study on your own, you need to choose resources for learning, and there are hundreds of them on the Internet. To make it easier for you to choose, we have written an article "How to learn English on your own and for free", in which we have selected for you the best learning sites and resources from the whole variety of the Internet.

Now take a break from reading for a few minutes and watch a great TED video on the paradox of choice.

### **9. The effect of the choice made or the distortion of the perception of the choice made**

So, you have already made a choice, and now it is important not to fall into an interesting trap. We always zealously defend what we have chosen ourselves: shoes with uncomfortable heels (you don't understand anything, they are so cute!), A disgusting place of work (what do you mean, I have a stable income!), Etc. It's so difficult for us to refuse from old habits, things and beliefs that we spoil our own lives.

How to use: We cling to our beliefs about learning English as tightly as we cling to beautiful but uncomfortable 15-centimeter heels. Therefore, we suggest that you do not use this psychological effect, but fight it. If you still have a three-column vocabulary and memorize grammar rules, read

our article “13 Essential School English Learning Principles You Need to Forget” to get rid of outdated academic stereotypes.

### ***10. The principle of "first is right" or the principle of priority***

Our psyche is designed in such a way that we most of all trust the information we received first. Even if after that we find more reliable and useful information, our brain will refuse to accept it. The fact is that it is almost impossible to immediately assess the reliability of the first information received, so we accept it as correct. And then it is very difficult to question your attitudes and change them.

How to use: Be careful with your choice of knowledge sources and instructor. So, an unqualified teacher or a low-quality textbook may incorrectly give you knowledge, and this information will firmly sit in your head, and retraining is always more difficult than learning.

For example, our teachers often encounter students who pronounce clothes like / kləʊðəz / instead of / kləʊðz /. It is very difficult to retrain them, because at school they were taught the wrong pronunciation, which was deposited in their memory.

### ***11. The method of associations or mnemonics***

You've probably heard of this method of learning new words. Mnemonics (or mnemonics) are used by world champions from memory - people who memorize information in fantastically large volumes. This method consists in the fact that when learning a new word, you select an association for it, which helps to remember the information.

How to use: Mnemonics work in different ways. First, you can try to associate English words with Russians: owl / aol / (owl) - an owl flies around the aul.

Secondly, you can try visual associations: learn the word ring (ring) and imagine Frodo with the Ring of Omnipotence.

Third, you can try the method of the Roman room or the Cicero chain, which was used by Julius Caesar. This trick seems a little strange, but the world champion in memory Andy Bell uses it, so check it out, maybe it will work for you. Take 10 words or phrases that you need to learn, walk around your room and mentally “put” each word or phrase on a subject. Then walk around the room and try to remember where each word “lies”. Then close your eyes and imagine the room in your mind, try again to remember all the words, they should be well fixed in your memory.

### ***12. Effect of mechanical actions***

Movement is not only life, but also a good memory. Mechanical actions activate the brain, and we begin to memorize information more actively. So, many schoolchildren, when studying poetry, walk around the room, while pronouncing the lines in time with the steps. Blood circulation improves, the brain is better supplied with oxygen, therefore, the memorization process is faster.

How to use: Try walking around the room or doing some simple exercise as you learn new words or grammar. So, you will improve not only your knowledge, but also your physical fitness.

This psychological trick may have a small side effect. Some people can remember learned information only if they follow the same steps as when learning it.

### ***13. Method of "written in pen"***

At school and university, we were forced to write hundreds of pens. The idea of the teachers was not to enrich stationery stores, but to get mechanical and visual memory to be included in the work at the same time.

How to use: It is not necessary to write everything in a row, so you will only overload your brain and start to dislike us for such advice :-) Write down only what you cannot remember: difficult words, examples of sentences with difficult grammar, etc.

### ***14. The principle of visibility***

For the most part, people are visuals, so it is much easier for us to perceive visual diagrams and tables than solid text. For example, if you need to find a building, it will be much easier to do this by looking at the map than by reading the description of the road from your house to the desired point.

How to use: It is not for nothing that we always advise using textbooks by English-speaking authors instead of Uzbek manuals, in which grammar is explained in a difficult way and undersigns several pages. While authentic textbooks usually use short explanations, diagrams, tables to highlight the grammatical topic. Despite the lack of explanations in Uzbek, such a manual is easier to understand than a textbook in your native language. So, if you want to learn from clear materials try to learn from English Grammar Textbooks.

### ***15. The principle of repetition***

Repetition is not only an important principle for learning something new, but also a very cunning psychological technique that is widely used to manipulate our consciousness. Thus, repeated repetition of information makes a person unconsciously memorize it and find application for it. Gradually, this information seems to us no longer received from the outside, but our own conviction. That is why, although we do not like advertising, we still buy yoghurts with live bacteria and toothpaste with a 3D whitening effect.

How to use: Be sure to repeat what you've learned. Only geniuses with a unique memory can memorize material at first glance, while ordinary people need to repeat information several times so that it will be deposited in memory for a long time.

### ***16. The principle of "memory is not rubber"***

Experimentally, scientists managed to find out that our memory perfectly assimilates 7 +/- 2 units of information in one approach. That is why, despite the popularity of the "Learn 999 New Words a Day" methodology, we see very few examples of people who actually did it. This is because short-term memory is not infinite.

How to use: Learn no more than 5-9 new words a day, then they will be memorized normally and you will have time to repeat them. Pursue the quality of memorization, not quantity.

So, in conclusion we can say that there are different psychological effects that help us to learn foreign language. Thinking way of every person differs that's why one tip helps to some people, others not. Every person should choose the appropriate one. It seems learning English in near future will be more simply as every sphere is developing rapidly including psychology. Researchers have been trying to investigate the way of thinking human being and the functioning

of brain in order to facilitate more efficient ways of learning foreign languages. Interesting features of human psychology can help us learn English effectively and much faster improving knowledge and being able to acquire new ones.

#### **USED LITERATURE:**

1. Parygin B.D. Social Psychology: Problems of Methodology, History and Theory. - SPb .: Publishing house IGUP, 1999.
2. Shakurov R.Kh. Barrier as a category and its role in activity // Questions of psychology. - 2001. - No. 1. - P. 3–18.
3. Bozhovich L.I. Selected psychological works // Problems of personality formation / otv. ed. DI. Feldstein. - M .: International Pedagogical Academy, 1995.
4. Rogers C. Client-Centered Therapy: Its Current Practice, Implications, and Theory. - London: Constable & Robinson Ltd., 2003.
5. Kunitsyna V.N., Kazarinova N.V., Pogolsha V.A. Interpersonal communication. - SPb .: Peter, 2001.
6. Chaplina E.I. Strategies for overcoming psychological barriers among students in the study of a foreign language: dis. ... Cand. psychol. sciences. - Kursk, 2006.





**ACADEMICIA**  
**An International**  
**Multidisciplinary**  
**Research Journal**  
 (Double Blind Refereed & Peer Reviewed Journal)

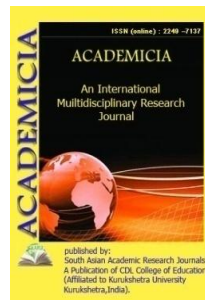

**DOI: 10.5958/2249-7137.2021.01191.5**

**THE MAIN TAXONOMIC FEATURES OF THE CAUSATIVE AGENTS  
 OF URINARY TRACT INFECTIONS AND A DESCRIPTION OF THEIR  
 VARIABILITY**

**Dilfuza Isanova\*; Yuriy Azizov\*\***

<sup>1</sup>Ph.D., Docent, Senior Teacher,  
 Department of Phthisiology and Pulmonology,  
 Microbiology, virusology, Immunology,  
 Andijan State Medical Institute,  
 UZBEKISTAN

\*\*Professor, Ph.D., Docent,  
 Department of Phthisiology and pulmonology,  
 Microbiology, virusology, Immunology,  
 Andijan State Medical Institute,  
 UZBEKISTAN

**ABSTRACT**

*After evaluating the microbial landscape of the cultured microorganisms, they analyzed and evaluated the results of Scientific work on taxonomic traits and their changes, ie the manifestation of atypical traits that are not specific to the species. We found it necessary to differentiate each generation and species separately in order to facilitate the evaluation of the results obtained, to characterize the taxonomic characteristics of the grown pathogens, and to strengthen the identification results.*

**KEYWORDS:** *Escherichia coli. microorganisms., pathogen strains*

**INTRODUCTION**

The description of the microorganisms was given in sequence according to their growth rate.

Escherichia coli. Escherichia coli has been identified as a genus of Escherichia coli. They grew in their own universal (meat-peptone agar) and differential-diagnostic nutrient media. All studied strains of this gram-negative bacterium did not differ from each other in morphological and tinctorial properties. When observed under a microscope (7x90 = 630), the field of view

appeared to be medium-sized, short, rod-shaped (100%), irregularly spaced (100%), and stained red (100%) with control dye (aqueous fuchsin) when stained on Gram[1,4,6,8,9].

As for the cultural feature, the colonies grown in the Endo environment were bulging, the edges smooth, the surface smooth, C-shaped, mostly fuzzy (100%), metallic radiant, reddish, and sometimes dark pink. All strain colonies were of solid consistency (100%).

### Result and methods

Study of the biochemical properties of E.coli strains isolated from the urine sample of women of childbearing age showed that it utilizes glucose, lactose, maltose, arabinose, mannitol, sodium citrate, does not break down sorbitol, inositol, sodium Malone, does not produce hydrogen sulfide, urease, arginine dehydrola (Table 1).

According to the results of the analysis, practically half of the pathogen strains isolated from women diagnosed with UTI did not break down the enzyme sucrose. All studied strains (except 19 strains of E.coli) did not have hemolytic activity.

Strains that did not fully represent all taxonomic traits were assessed as atypical strains, however, their scarcity and the fact that there was only a change in 1-2 taxonomic traits allowed us to describe this pathogen as Escherichia coli[5,9].

Proteus srr. We did not find it necessary to identify the species because they are not pathogenetically different from each other. All strains of this microorganism were similar to other enterobacteria in morphological (100%), tinctorial (100%), and cultural (100%) properties. In this respect, similar characteristics were observed in other members of the family he represented.

**TABLE 1 INDICATORS OF BIOCHEMICAL PROPERTIES OF E.COLI STRAIN ISOLATED FROM URINE SAMPLE (FROM N = 12)**

Characteristics of strains	Acute UTI	Chronic UTI
Fermentation of carbohydrates		
Glucose utilization	+	+
Lactose fermentation	+	+
Mannitol fermentation	+	+
Sucrose fermentation	+	+(58,3%)
Inositol fermentation	-	-
Sorbitol fermentation	-	-
Arabinose fermentation	+	+
Maltose fermentation	+	+
Citrate Na Fermentation	-	-
Malonate Na	-	-
Fermentation		
Lysin decarboxylase	+	+
Ornithine decarboxylase	+(50,0%)	+(75,0%)
Arginine dehydrolase	-	-
Phenylalanine deaminase	-	-
Urease	-	-

B-galactosidase	–	–
Hydrogen formation	–	–
Hemolytic activity	+ (66,7%)	+ (41,7%)

Note: the percentage is given the number of strains with these characteristics; in the percentage not specified (+) the result was 100.0%.

According to Shukevich, the main differentiating features are "creeping growth" (100%), lactose fermentation (100%), sorbitol degradation ( $83.3 \pm 15.2\%$ ), lysine decarboxylase activity ( $83.3 \pm 15.2\%$ ), indole we can cite positive results of additional bacteriological tests such as formation (100%), malonate activity ( $83.3 \pm 15.2\%$ ). Bacteriological studies did not reveal pathogenic factors (0%). Apparently, the percentage of atypical strains is low, so there was no doubt that they belonged to the Proteus family.

Klebsiella SRP. In terms of morphological, tinctorial, cultural, and enzymatic properties (100%) showed taxonomic traits specific to this generation, as with other gram-negative bacteria analyzed, no atypical strains, i.e. no generational taxonomic traits were observed, no pathogenic factors were identified (0%).

Thus, strains of uropathogenic enterobacteria (Escherichia coli, Proteus SRP, Klebsiella SRP) collected from the urine of sick women were typical strains of all genera and species-specific to all studied taxonomic traits. detected.

Pseudomonas aeruginosa. This microorganism, which belongs to the genus Pseudomonas, along with other non-fermentable gram-negative bacteria (NFGNBs) has good growth properties in all nutrient media, so we did not choose a separate nutrient medium and grew it in Endo medium. we have described.

Colonies suspected of being the causative agent were replanted on 2% glycerin-containing oblique frozen agar. On its surface, Pseudomonas aeruginosa grew abundantly and densely, forming oily green pigmented (pyocyanin) colonies and distinguished by its distinctive 'blooming purple' odor.

For differentiation from other gram-negative microorganisms, especially enterobacteria, Pseudomonas aeruginosa was evaluated for the following characteristics:

- good growth (100%) in normal nutrient media (meat-peptone agar);
- mobility (100%);
- formation of green pigment (piocyanin) (100%);
- solubility of gelatin at 22°C (100%);
- Positive result of the Hugh Leifson test ( $90.9 \pm 8.7\%$ );
- Occurrence of the phenomenon of "rainbow lysis" ( $90.9 \pm 8.7\%$ ).

The phenomenon of "rainbow lysis" (formation of a mucous membrane of different colors on the surface of a colony of microorganisms) was recommended as an additional test in the identification of Pseudomonas aeruginosa in the bacteriological diagnosis of UTI. Since the atypicality of the strains was associated only with additional tests - the Hugh-Leifson positive

test and the “rainbow lysis” phenomenon, we relied on key taxonomic features in identification[1].

*Staphylococcus aureus*. When the described stimulus was stained on Gram, it was observed in the field of view that it was stained with the primary dye in 100% of cases. Under a microscope (7x90 = 630) it was observed that they were ball-shaped and arranged in a “grape bunch” shape (100%).

The following taxonomic characteristics of cultured strains were identified: bulging, dull, larger than 5 mm in diameter, large, C-shaped colonies (100%) grew on the surface of the nutrient medium; the presence of the causative colony in the golden pigment (100%); Growth in a nutrient medium containing 10% NaCl ( $83.3 \pm 15.2\%$ ); the colonies were found to be of solid consistency (100%).

Based on the above morphological, tinctorial, and cultural characteristics, the strains described were identified as belonging to the *Staphylococcus* genus.

The results of the identification of strains of the genus *Staphylococcus* by type are given below:

- coagulase activity of strains (coagulase-positive strains) was detected ( $83.3 \pm 15.2\%$ );
- Growing in nutritious juice ( $83.3 \pm 15.2\%$ );
- fermented mannitol in the Giss series under anaerobic conditions (100%);
- showed sensitivity to novobiocin ( $83.3 \pm 15.2\%$ );
- One of the signs of pathogenicity of the strain is the activity of lecithovetilase or the breakdown of lecithin, which forms the appearance of a "rainbow circle" around the colony ( $83.3 \pm 15.2\%$ );
- breaks down glucose (100%), lactose (100%), mannose (100%), sucrose ( $83.3 \pm 15.2\%$ ) (enzymatic activity).

The results show that basically all strains exhibited taxonomic traits specific to the genus *Staphylococcus aureus*. In some cases, i.e., in reactions, less than 100%, strains that showed atypical reactions that differed from typical strains specific to the *Staphylococcus aureus* species were also identified. However, the percentage of these cultures was low, and these strains differed from typical strains by only 1–2 characters. With this in mind, strains with an atypical reaction were also recognized as belonging to the genus *Staphylococcus aureus*[2,3,9].

*Staphylococcus epidermidis*. Morphologically, it is difficult to distinguish this microorganism from *Staphylococcus aureus* in terms of tinctorial properties, so it was not difficult to identify the generation by these taxonomic traits, in all strains (100%) these features were fully manifested.

The percentage of typical and atypical strains relative to *Staphylococcus acc* did not differ significantly.

The Main differential taxonomic features that distinguish *Staphylococcus epidermidis* from *Staphylococcus aureus* are the absence of golden pigment formation, the absence of coagulase activity (coagulase-negative), and the absence of hemolytic activity of pathogenicity.

Thus, *Staphylococcus epidermidis* was close to *Staphylococcus aureus* in morphological, tinctorial, cultural, enzymatic properties, differentiated by some cultural properties (absence of

golden pigment), lack of coagulase activity and a low percentage of pathogenic factors and closeness to healthy women.

*Staphylococcus saprophyticus*. In the identification of these strains, differences in their typical properties were not observed in practice. While it was acknowledged that staphylococcal traits were observed during microbiological identification, there was no difficulty in bacteriological identification.

*Enterococcus faecalis*. These identified enterococci were differentiated using tests used in the following microbiological diagnosis: gram-positive, chain-like in the visual field; grass-esculin agar formed C-shaped, dark-colored colonies, grown in a nutrient medium with 6.5% NaCl, on obliquely hardened meat-peptone agar (this test was used to differentiate from streptococci); fermented lactose, glucose, and mannitol to acid but without gas[1,9].

*Candida* spp. The overgrown strains were spherical and oval in shape, they did not break down lactose, they broke down sucrose to acid. The main differential signs - no ascospores, formed pseudomycelium, verticillas, chlamydo spores, without breaking down lactose, breaking down glucose, maltose, and sucrose, sprouting from the tip.

*Bacteroides* spp. Identification of this anaerobic microorganism was based on gram-negative, rod-like, inactive, sequential location in the visual field, growth under strict anaerobic conditions, C-shaped, pale, small colonies on blood agar, no hemolysis, hydrogen sulfide, glucose, lactose, sucrose breakdown.

The pathogenic properties of strains grown as large uropathogenic pathogens were characterized by the percentage of detection of pathogenic factors.

A total of 35 strains of acute UTI pathogens and 25 strains of chronic UTI pathogens were studied as pathogenic factors.

Strains with plasma coagulase, lecithinase, hyaluronidase activity accounted for a large percentage.

It is noteworthy that the hemolytic property was detected in low percentages only in *E.coli* (n = 19).

No significant differences were found between gram-negative bacteria and gram-positive cocci in the detection of pathogenic factors, and no similar convincing differences in this parameter were observed between acute and chronic UTI.

Thus, there were no significant differences in the identification of the main taxonomic features between strains that are considered uropathogenic pathogens and strains of microorganisms belonging to the same species derived from other biotopes. The variability of biological properties was also low, which did not prevent the identification of pathogens by generation and type.

## CONCLUSION

No practically convincing differences were found in the biochemical and pathogenic properties of the strains in the acute and chronic forms of UTI. This suggests that the main taxonomic features of uropathogenic strains that cause UTI in women of childbearing age are that there are

no changes to the extent that can be included in the diagnostic algorithm of microbiological studies on the characteristics of their variability.

This situation showed that the results obtained differed significantly from the results of Scientific studies published by the other researchers mentioned above.

## REFERENCES

1. Boltaeva R.Sh. To study the variability of taxonomic symptoms and resistance to antibiotics in female urinary tract infections. A dissertation is written for a master's degree. - Tashkent, 2014. - 76 p.
2. Valyshev A.V., Elagin N.N., Bukharin O.V. Anaerobic microflora of the female reproductive tract // ZhMEI. - Moscow, 2001. - No. 4. - P.78-84.
3. Vilyukha A.I., Voshchula V.I., Nitkin D.M. Clinical validity of immunoprophylaxis of recurrent lower urinary tract infection in women // Collection of materials of the Republican scientific-practical conference of young scientists "Minsk council". - Minsk, 2014. - P.27-28.
4. Voshchula V.I., Vilyukha A.I. Uncomplicated lower urinary tract infection in women and its prevention // Arsmedica. - 2012. - No. 5. - S.98-104.
5. Hajiyeva Z.K. Features of the approach to the diagnosis and treatment of recurrent infections of the lower urinary tract // Urology. - Moscow, 2013. - No. 3. - S.84-90.
6. Gadzhieva Z.K., Kazilov Yu.B. Features of the approach to the prevention of recurrent lower urinary tract infections // Urology: Appendix. - Moscow, 2016. - No. 3. - S.65-76.
7. Galeeva E.V., Samarina O.Yu. Experience of using the test system DipStrik for bacteriological express-analysis of urine at the stage of the standardized technology "Bacteriological analysis of urine" // Clinical laboratory diagnostics. - Moscow, 2012. - No. 9. - S.48-52.
8. Glazovskaya L.S. Epidemiology and prevention of nosocomial urinary tract infections in surgical and obstetric hospitals: the dissertation, PhD, docent - Kemerovo, 2005.-- 136 p.
9. Dilfuzahon Mamarasulova, et al., : Comparative Analysis of Mortality Structure among the Population of Andijan Region for 2016– 2018.,//Journal of Cardiovascular Disease Research, Vol 11, Issue 2, April June, 2020:P. 01 - 03



**ACADEMICIA**  
**An International**  
**Multidisciplinary**  
**Research Journal**  
 (Double Blind Refereed & Peer Reviewed Journal)

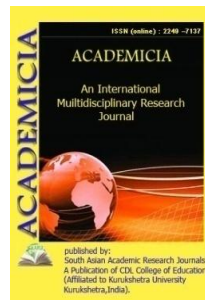

**DOI: 10.5958/2249-7137.2021.01190.3**

## ADVANTAGES AND DISADVANTAGES OF AUDIO-LINGUAL METHOD IN TEACHING

**Shayusupova Kamola\*; Mamatova Feruza\*\***

<sup>1,2</sup>Uzbek-Israel Joint Faculty,  
 National University of UZBEKISTAN  
 Email id: skamola@list.ru  
 Email id: mamatovaf@gmail.com

### ABSTRACT

*This article is devoted to the study of the audio-lingual method of teaching English. The author indicates the relevance and practical significance of the research topic. The content of the concept of "teaching method" in the system of teaching English is considered. It is concluded that the audio-lingual method should be the basis for the formation of a methodology (strategy development) of teaching English, and not be an autonomous teaching method. The history, essence, key principles and criteria for the effective use of the audio-lingual method of teaching English have been studied. As a conclusion, the main advantages of the method are indicated, in the case of its application as an integral part of the methodology of teaching English, and the disadvantages that may appear in the case of its autonomous or remote use.*

**KEYWORDS:** *Audio-Lingual, Methodology, Teaching English, Advantages, Disadvantages, Foreign Language.*

### INTRODUCTION

The audio-lingual teaching method is one of the most popular methods for learning foreign languages. Most often it is used by those who intend to independently learn a particular foreign language. Although in the educational environment, it has its own popularity.

To understand what an audio-lingual language learning method is, we refer to a dictionary entry. The dictionary of methodological terms says that the audio-lingual teaching method is a method of teaching a foreign language, which provides for the use of the auditory channel of perception in the course of classes and repeated listening and reproduction following the speaker of strictly

selected structures, sample sentences, which leads to their automation (Vogt W. Paul., Johnson R. Burke, 2015).

The audio-lingual method is the product of three historical circumstances. It drew on the work of American linguist such as Leonard Bloomfield (Bloomfield Leonard, 1984). It was based on repeating simple patterns in a foreign language. In short, the linguist, not knowing the language, was trained to perceive its basic structure from an informant/native speaker and, together with the students, "gradually learned to speak this language and also to understand most of its basic grammar. The primary task of American linguists in the early decades of the twentieth century was to document all the indigenous languages spoken in the United States. However, due to a shortage of trained native speaker teachers who could provide theoretical descriptions of native languages, linguists had to rely on observation. For the same reason, a strong emphasis on speaking has been developed.

At the same time, behavioral psychologists such as B.F. Skinner, formed the belief that all behavior (including language) is learned through repetition and positive or negative reinforcement (Skinner, 1957).

The third factor is the outbreak of World War II, which made it necessary to deploy large numbers of American troops around the world. Therefore, it was necessary to give these soldiers at least basic verbal communication skills. Unsurprisingly, the new method relied on the prevailing scientific methods of the day, observation and repetition, which were also excellent for mass learning. Due to the influence of the military, early versions of the audio language became known as the "military method." At that time, the US government felt it was imperative to create a special language training program to provide language personnel for the war. Therefore, the government has instructed American universities to develop a foreign language program for military personnel ([https://en.wikipedia.org/wiki/Audio-lingual\\_method](https://en.wikipedia.org/wiki/Audio-lingual_method)).

Thus, in 1942, the Army Specialized Training Program (ASTP) was established. The method used was known as the "informant method" as it used native speakers, informant and linguist. The informant served as a source of language for imitation, and the linguist controlled the learning process. The intensive system adopted by the military has produced excellent results (Rivers, 1981).

## LITERATURE REVIEW

This method is one of the least studied in the system of scientific knowledge and is taken as a subject of analysis only in conjunction with other methods of teaching English. In addition, its use in the educational process "armed us with an understanding of the importance of speech patterns and training on them" (Markova, 2015). Developed in the 40s of the last century, the audio-lingual method was the basis for the practice of teaching English.

The evolution of English language teaching has a relatively short history when viewed in the context of its formation as an independent scientific discipline. At the same time, in essence, the history of language teaching is the history of teaching methods, whose supporters and opponents were either in a state of constant struggle and opposition (this is especially characteristic of the period the birth and development of direct and grammatical-translation methods at the end of the 19th and the beginning of the XX century). Today, the concept of "method" is also present in the name of the discipline - methodology, which gives grounds to talk about classifying teaching



methods among the main categories of methodology, and the choice of a method that meets the goals and objectives of training provides the most rational and effective way of mastering the language.

It should be noted that in modern linguo-didactics there is no unified approach to the interpretation of the concept of "teaching method". This, of course, makes it difficult to understand in what sense the term is used in the pedagogical process. On the one hand, the teaching method is a direction in teaching that determines the teaching concept (strategy) chosen by the teacher. On the other hand, in a broader sense, the teaching method can be understood as the way of teaching any aspect of the language (vocabulary, phonetics, grammatical structure, etc.), through which the practical aspect of the teacher's work in the specific conditions of language teaching is determined.

M.V. Lyakhovitskii wrote that the method gives an idea of the general concept of teaching, since it is based on "the dominant idea of solving the main methodological problems" (Lyakhovitskii, 1981). E.I. Passov defined the teaching method as "a system of interdependent methodological principles, united by a single strategic idea and aimed at mastering any type of speech activity" (Passov, 2009). In this case, the authors consider a broader approach to the definition of the term in question.

Thus, a specific feature of the method as a methodological concept is the leading idea, which determines the ways and means of achieving the set educational goal.

At the same time, to overcome the existing in the understanding of the term dualism, you can use the level approach, which was first spread thanks to the publications of D. Richards and G. Rogers. According to their approach, we can talk about three levels of using the concept of "teaching method": the level of approach to teaching, the level of development and the practical level. So, the first (theoretical) - defines the method as a direction in teaching, which determines the concept of teaching and language acquisition; the second - determines the tactical side of language teaching and implies the choice of the method and method of teaching in the context of the concept of the method, i.e. directions; the third one determines the ways of applying the method chosen for the work in the form of the teacher's labor technology, which in turn form a model of language teaching.

Based on the three-level approach presented by the English methodologists, the hierarchy of key categories of the methodology within the framework of using the concept of "teaching method" can be represented in the following way: the first level (from the standpoint of the approach to teaching) implies the use of direct, conscious and combined methods; the second (from the standpoint of development) - direct, conscious, combined and intensive methods; third (from the point of view of application) we mean the choice of teaching methods, the totality of which forms the content of the teaching strategy, corresponding to the teaching method chosen by the teacher (Shchukin, 2013).

## **DISCUSSION**

The audio-lingual method is based on two main theories: Structuralism: language is a system of structurally related elements such as phonological units, grammatical units and lexical units to convey meaning. So, to study the target language means to master the elements of the target language system.

Behavioral psychology claims that people are accustomed to learning many forms of behavior, including language, through learning or conditioning.

The five slogans that were established for the educational process and used by teachers who adopted this method were as follows:

1. Language is speech, not writing. The audio-lingual method mostly focused on speaking skills before written form (pronunciation, intonation, and colloquial forms).
2. Language is a set of habits. The audio-lingual method is based on habit formation. Language is learned in childhood in the same way that children acquire other social habits through imitation and memorization. Students learn the language automatically using conversational material.
3. Learn a language, not a language. This slogan is a reaction against the basic principle of the grammar translation method (the allotted time for communication in the target language without grammar analysis).
4. A language is what its native speakers' say, not what someone thinks they should speak. Teachers do not have to impose grammar scores according to certain criteria, but in order to learn, students must speak the language spoken by native speakers.
5. Languages are different. In this case, the concept of universal grammar was rejected. Thus, each language is analyzed according to its own characteristics without any relation to another language (Al-Mutawa N, Kailani T, 1998).

Methods and actions used by the audio-lingual method. The audio-lingual method is different from the grammatical translation method and the direct method. He emphasizes mimicry as a basic technique. This is achieved through memorization of dialogues and imitation repetition. The practice of using drills and templates includes the following:

1. Repetition: When a student repeats a statement as soon as he hears it, without looking at the printed material.
2. Kink: when one word in a sentence appears in a different form when repeated.
3. Substitution: when one word is replaced by another word.
4. Repeat Utterance: The student paraphrases the utterance and refers to someone else as instructed.
5. Completion.
6. Transpose: changing the word order is necessary when adding a word.
7. Extension. When a word is added, it occupies a specific position in the sequence.
8. Abbreviation: One word designates a phrase or sentence.
9. Transformation: The sentence is transformed by becoming negative or interrogative or through a change in time, mood, voice, aspect or modality.
10. Integration: Two separate statements are combined into one.

11. Remark: the student makes an appropriate answer to the given pattern. (politely, answer a question, agree, disagree, express surprise, etc.)
12. Recovery: This is one of the most common patterns found in English as foreign textbooks.
13. Using minimum pairs.

How is the audio-lingual method so different from traditional ways of learning a language?

The first and main distinguishing feature of the audio-lingual method is the assignment of oral speech to a primary role in learning. The ability to understand foreign speech at a normal pace is developed, as well as on such material that the student himself cannot reproduce - "I understand everything, but I cannot say."

The second feature is the colossal load on the student's memory and the method of analogy. The student must memorize (memorize) the basic set of sentences that are most often used in colloquial speech. By analogy with these sentences, the student will build other sentences for oral reproduction or listening.

It is also recommended to memorize entire dialogues and communication situations. At the initial stage of training, the student's vocabulary practically does not develop. A small set of words is used, which allows you to work out the basic grammatical structures through speech and repetition-pronunciation.

The third feature of the audio-lingual method is the sheer amount of practice. Only 15% of the lesson time is devoted to explaining grammatical, lexical, phonetic foundations. The rest of the time is devoted to practical exercises. However, such classes can quickly bore the student, with their monotony and monotony of approach. Therefore, it is recommended to immediately assess the student's actions - did it right - praise, wrong - correct.

The fourth feature is the dictionary. The audio-lingual method divides words into categories of different levels of difficulty with their own subgroups in each. The easiest ones include prepositions, adverbs, conjunctions, interrogative particles, articles. The most difficult - words for objects, words for actions, words for quality, that is, nouns, adjectives and verbs. Learning vocabulary is based on the principle from simple to complex.

However, at the initial stage of learning, words from a complex category are used, but they are selected in such a way that in form and meaning they correspond as much as possible to the equivalents of the native language.

The role of the teacher in the audio-lingual method is like an orchestra leader. "He guides and guides students in their language learning style. He is also responsible for providing students with good role models. Whereas the role of the student is seen as an imitator of what is said in front of him by the teacher or record. They follow their teacher's directions and respond as quickly as possible (Freeman, 2000).

*Advantages and disadvantages of the audio-lingual method.*

Advantages:

1. Availability. Indeed, this method of language learning is extremely accessible. There are app stores which help to find language learning programs based on the audio-lingual method. The

most popular are DUOLinguo and Memrise. Some of them are paid, some are not. But even paid apps turn out to be much cheaper than a lesson with a teacher.

2. Ease of use. Everything here is just straight up to disgrace. Set of words, pictures, cards and cubes-blocks are listened repeatedly which are related to each other to get a phrase by clicking on them or dragging them.

3. Stability and consistency of the teaching method. Training always takes place according to the same scenario. Set of words is seen, acting and pictures are voiced for them, and usually no more than 2-3 words are given per lesson. Then these words are practiced by choosing the translation, writing, speaking, constantly listening and repeating aloud. Each card is read out, so that other people can hear one word or expression many, many times. Further complication occurs. New words are added and phrases are expanded. They become more detailed and complex. For example, the phrase "A cat drinks milk", then after a couple of lessons this phrase turns into "A little cat drinks milk on the roof."

4. Comfort and duration of the lesson. There is no need to talk about convenience. Practice is required when it is convenient. The urge to repeat English pronouns overwhelmed at midnight. Controlling the duration of the lesson should be done by the student. It can be 5 minutes a day or 2 hours. It all depends only on students' desire and time possibilities.

Other advantages:

1. This was the first theory-based method.
2. It made language learning accessible to large groups of ordinary learners.
3. It was the first method to focus on the development of the syntax of a language, while other methods focused on morphology and vocabulary.
4. Developing simple methods and using a language lab.

Disadvantages:

1. Availability. One should not be surprised that good on the one hand is just as bad on the other. What cost invaluable for us is usually not appreciated by us. Therefore, very often after purchasing a particular program, after a couple of weeks, when the enthusiasm ends, we simply forget about it.

2. Stability. If at first the substitution of words, their pronunciation and listening seems to be the best that it can be, then after a while we begin to miss the variety. Where an experienced teacher would have suggested reading a magazine article that is interesting or discussing the taste preferences, students continue to "roll their "snowball"". And this is what often begins to tire and reduce motivation to the point of its complete absence.

3. Limitedness. The audio-lingual method does have its limits.

- A limited set of words and phrases that are comfortable to memorize through the auditory canal.
- The use of one type of memory for learning a foreign language, which may entail the impossibility of using the written language of the target language.
- Absence of a partner for practicing dialogical speech - the most common type of speech.

• Experience. The audio-lingual method is excellent for those who have experience in learning a foreign language, a very deep and consistent experience. What does it mean? Students will start asking “why,” for example, in the sentence “She eats cake every day” the verb eat has a –s ending, but the sentence “I eat cake every day” does not. It is simply impossible to get an answer to this question without understanding the presence of temporal structures of the language, grammatical and lexical forms of a word. Therefore, students will have to look for answers to the questions themselves, working through tons of different grammatical information. While, studying with a living person, they can always ask questions that interest them.

Thus, the audio-lingual method is a good addition when teaching English or another foreign language with a teacher, either individually or in a group.

Other disadvantages:

1. No creativity. Students repeat and remember what they do not understand.
2. The methods used by this method become "tedious and tedious, causing fatigue."
3. Make advanced learners bored.
4. There are many students in the class.

In the 1960s, many linguists criticized audio-lingual method, arguing that the theoretical basis of this approach was weak, and it turned out that students could not use the skills learned in the classroom in real communication. In 1966, Chomsky criticized behaviorist theory, which was the mainstay of audio-lingual method. He argued that this theory cannot serve as a model for how people learn languages. Chomsky presented an alternative theory of language learning (Chomsky, 1966).

He explained that languages are not acquired through repetition and imitation, but “are generated by the basic competencies of the learner”. With the advent of Chomsky's theory of transformational grammar, audio-linguism lost its popularity. (Richards and Rogers, 1987).

## CONCLUSION

In general, we can say that the audio-lingual method will be a significant addition to the general methodology of teaching English. Among the advantages of this method, one can note a clear formulation of learning goals, defining ways to achieve these goals through various exercises, mastering grammar through models and speech patterns, consistent inclusion of country-specific information in classes, widespread use of technical means and the development of special exercise. However, if it is used autonomously, a certain range of disadvantages will affect, for example, the monotony of speech exercises, the predominance of mechanical teaching methods, meaningless memorization of structures, which can lead to a misunderstanding of the purpose of the lessons by students, as well as the lack of interconnection in teaching the main types of communicative activity. In addition, the audio-lingual method can be effectively implemented exclusively in the system of full-time educational process, in audiovisual systems included in distance learning platforms, replacing a teacher - a native speaker with a computer significantly reduces the communicative efficiency of learning any foreign language, in particular, English.

**REFERENCES**

1. Al-Mutawa N, Kailani T. Methods of Teaching English to Arab students. Longman: Harlow. 1998.
2. Bloomfield L. Cree-English lexicon. Ed. Charles F. Hockett. New Haven: Human Relations Area Files. 1984.
3. Chomsky N. The logical foundation of the linguistic theory. Problems of Modern linguistics. Warsaw. 1966.
4. Freeman D.L. Techniques and principles in language teaching. Oxford University press: Oxford. 2000.
5. Lyakhovitskii M.V. Methods of teaching foreign languages. Moscow: Vysshaya shkola Publication. 1981.
6. Markova E.M. Foreign methodology of teaching foreign languages - to the modern teacher of RCT. Filologicheskii klass, 4 (42), 2015. pp. 27-30
7. Passov E.I. The terminology of methodology, or How we speak and write. St. Petersburg: Zlatoust Publication. 2009.
8. Richards J.C., Rogers Theodore S. Approaches and Methods in language teaching. Cambridge University Press: USA.1987.
9. Rivers W. M. Teaching foreign language skills. Chicago: University of Chicago Press.1981.
10. Shchukin A.V. Methods of teaching in the history of teaching Russian as a foreign language (theory and practice). Prepodavanie inostrannykh yazykov, 40.2013. pp. 107-118
11. Skinner B. F. Verbal behavior. New York: Appleton-Century-Crofts.1957.
12. Vogt W. Paul., Johnson R. Burke. The SAGE Dictionary of Statistics & Methodology. A Nontechnical Guide for the Social Sciences. 5th edition. USA, 2015.
13. [https://en.wikipedia.org/wiki/Audio-lingual\\_method](https://en.wikipedia.org/wiki/Audio-lingual_method)

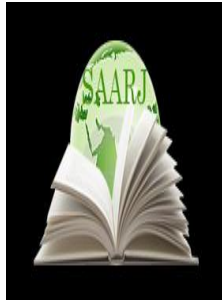

**ACADEMICIA**  
**An International**  
**Multidisciplinary**  
**Research Journal**  
 (Double Blind Refereed & Peer Reviewed Journal)



**DOI: 10.5958/2249-7137.2021.01189.7**

## TEACHING VOCABULARY IN CONTEXT FOR A1 LEVEL LEARNERS

**Xakimboyeva Ozoda\*; Djurayeva Dilnavoz\*\*; Turg'unova Dinara\*\*\***

\*\*Teacher of Uzbekistan State World Languages University,  
 UZBEKISTAN

\*\*\*Fourth year student of Uzbekistan State World Languages University,  
 UZBEKISTAN

### ABSTRACT

*Teaching vocabulary in the English as a foreign language (EFL) context is challenging. Incidental vocabulary learning is limited due to a lack of second language (L2) input, and most words are learned through classroom instruction. Overall, research has shown marginal L2 vocabulary growth in many EFL situations. Such research indicates a need for a more effective and efficient approach to teaching vocabulary in the EFL context. This chapter discusses how to optimize vocabulary learning in the EFL context. It touches on the following questions: Which words should be taught? How should vocabulary be taught? How many words do EFL learners need to know? What should a vocabulary-learning program include? How can vocabulary learning be fostered given limited classroom time? Which activities might be useful in indirect vocabulary learning?*

**KEYWORDS:** *Vocabulary Size, Vocabulary Learning, Extensive Reading, Extensive Viewing, Vocabulary-Learning Program.*

### INTRODUCTION

Hornby defines vocabulary as the total number of words in a language: “vocabulary is a list of words with their meanings”<sup>1</sup>. While Ur states as follows:

“Vocabulary can be defined, roughly, as the words we teach in the foreign language. However, a new item of vocabulary may be more than just a single word: for example, post office, and mother-in-law, which are made up of two or three words but express a single idea. A Useful convention is to cover all such cases by talking about vocabulary “items” rather than “words”<sup>2</sup>

In addition, Burns defines vocabulary as the stock of words which is used by a person, class or profession<sup>3</sup>. According to Zimmerman in Coady and Huckin vocabulary is central to language

and of critical importance to the typical language learning<sup>4</sup>. Furthermore, Diamond and Gutlohn in [www.readingrockets.org/article](http://www.readingrockets.org/article) state that vocabulary is the knowledge of words and word meanings<sup>5</sup>. From the definitions above, it can be concluded that vocabulary is the total number of words which are needed to communicate ideas and express the speakers means. That is the reason why it is important to learn vocabulary.

### **Kinds of Vocabulary**

Some experts divide two types of vocabulary: active and passive vocabulary. Harmer distinguishes between these two kinds of vocabulary<sup>6</sup>. The first kind of vocabulary refers to the one that the students have been taught or learnt and which they are expected to be able to use. Meanwhile, the second term refers to the words which the students will recognize when they meet them, but which they will probably not be able to pronounce. Haycraft, quoted by Hatch and Brown, divides two kinds of vocabulary, namely receptive vocabulary and productive vocabulary<sup>7</sup>.

#### **a. Receptive Vocabulary**

Receptive vocabulary is words that the learners recognize and understand when they are used in the context, but which they cannot produce. It is vocabulary that the learners recognize when they see or meet in reading text but do not use it in speaking and writing.

#### **b. Productive Vocabulary**

Productive vocabulary is the words which the learners understand, can pronounce correctly and use constructively in speaking and writing. It involves what is needed for receptive vocabulary plus the ability to speak or write at the appropriate time. Therefore, productive vocabulary can be addressed as an active process, because the learners can produce the words to express their thoughts to others.

### **Vocabulary Mastery**

In order to understand the language, vocabulary is crucial to be mastered by the learner. Vocabulary mastery is needed to express our ideas and to be able to understand other people's saying.

According to Webster mastery refers to (1) a. the authority of a master: dominion, b. the upper hand in a contest or competition; superiority, ascendancy and (2) a. possession or display or great skill or technique, b. skill or knowledge that makes one master of a subject comment<sup>8</sup>. While Hornby defines mastery as complete knowledge or complete skill. From that definition, mastery means complete knowledge or great skill that makes someone master in a certain subject<sup>9</sup>.

The specificity of any individual's vocabulary knowledge depends on the person and his motivation, desires, and need for the words<sup>10</sup>. Vocabulary mastery refers to the great skill in processing words of a language. It is an individual achievement and possession<sup>11</sup>. For that reason, the biggest responsibility in increasing the knowledge is in the individual himself. The success in widening the vocabulary mastery requires their own motivation and interest on the words of a language.

From the definition above, we can conclude that vocabulary mastery is an individual's great skill in using words of a language which is acquired based on their own interest, need and motivation.



Vocabulary mastery plays an important role in the four language skill and it has to be considered that vocabulary mastery is one of the needed components of language.

### **Teaching Vocabulary To Children**

One of the factors bringing to the unsuccessful teaching of English could be the students lack of vocabulary. Vocabulary is one of the vital elements in constructing meaningful communication. Without knowing the words needed to convey their ideas and feeling the learners can't speak and write well. A student who masters a good structure seems to lose its function whenever it is not supported by the abundance of words. In other words, it can be said that no matter how well students learn grammar and sounds of words, without words to express wide range of meanings, communication will become meaningless. In teaching vocabulary, the significant point is the selection of words the teachers want to teach. In teaching children, it is quite easy to teach concrete words and then become more abstract. The frequency also must be considered by the teacher. The teacher can decide which words to teach on the basis of frequency, how often the words are used by the speaker of the language. The teacher should teach the words that young learners are familiar with. How often words are taught depend on the themes and topics. A lot of books provide vocabulary according to the themes. For example, when there is a theme "Animals", then we can find words like names of animals, where they live, what they eat, etcetera.

Vocabulary mastery in elementary school especially at the third grade students still in the level of receptive use. They able to identify the words when they meet them but they are not able to produce or use the words speaking or writing. ado (1979: 121-126) gives some steps in vocabulary learning, namely: (1) listening the words, (2) pronouncing the words, (3) understanding the meaning, (4) making illustration in the form of sentence, (5) doing practice in expressing the meaning, (6) pronouncing the words in loud voice, (7) spelling the words. Based on this theory, the third grade students are able to master vocabulary in listening the words, pronouncing the words and spelling the words. Another expert, Ur (1998: 60-63) states the learners need to be taught the form of the words, then grammar, collocations, meaning and word formation. In the form of words, pronunciation and spelling should be mentioned. Ur states "The learner has to know what word sound is like (its pronunciation) and what it looks like (its spelling)." The grammar of a new item needs to be taught but it depends on what level the learners are. For example young learner in earlier age will find it difficult and confuse to be taught past forms when teaching verbs. Ur adds that the meaning of a word is primarily what it refers to in the real world, its denotation. It is important to inform learners about the meaning of the word as well as their form and grammar. Learners find this sometimes very difficult and discouraging because some words do not have just one meaning. Context helps them to find the right meaning. In word formation, using prefixes and suffixes, using hyphenated words etcetera, is too difficult for young learners.

It can be summarized that knowing the word and understanding its meaning go hand in hand. It is also easier to remember concrete words like a chair or a dog than abstract words. Young learners often put words together with what they can see, hear or with what they can touch. But as said above they also need to know other aspects of the words they learn. The third grade students able to master vocabularies in the form of listening the words, pronouncing the words and understanding the meaning of the words.

## **The Techniques in Teaching Vocabulary**

To get the best result on language learning, it is important to choose good and appropriate technique in teaching vocabulary. Here are some techniques of teaching vocabulary as stated by Brewster, Ellis, and Girard (1992: 90-91):

### **a. Using Objects**

Objects can be used to show meanings when the vocabulary consist of concrete nouns. Introducing a new word by showing the real object often helps pupils to memorize the word through visualization. Objects in the classroom can be used or things brought to the classroom.

### **b. Drawing**

Objects can either be drawn on the blackboard or drawn on flash cards. The latter can be used again and again in different contexts if they are made with cards and covered in plastic.

### **c. Using Illustrations and Pictures**

There are plenty of vocabularies that can be introduced by using illustrations or pictures. The teacher can use learning materials provided by school. They can also make their own visual aids, or using pictures from magazines. Visual support helps pupils understand the meaning and helps to make the world more memorable.

### **d. Contrast**

Some words are easily explained to student by contrasting it with its opposite, like the word *good* contrasted with *bad*. But some words are not. It is almost impossible to contrast the words whose opposite is the gradable one. When the word *white* contrasted with *black*, there is an “in between” word *grey*.

### **e. Enumeration**

We can use this to present meaning. We can say clothes and explain this by enumerating or listing various items.

### **f. Mime, Expressions and Gestures**

Many words can be introduced through mime, expressions, and gestures. For example, adjectives: sad, happy; mime: taking a hat off your head to teach hat and so on.

### **g. Using Opposites**

This technique allows pupils to associate words with a concept they already understand in their mother tongue and often pupils will learn two words instead of one. For example, long/short, big/little, straight/curly, town/country, ill/well, and so on. Meanings can also be conveyed using simple line drawings.

### **h. Guessing from Context**

This technique encourages pupils to take risks and guess the meanings of words they don't know as much as possible. This will help them build up their self-confidence so that they can work out the meanings of words when they are on their own. There are many clues pupils can use to establish meanings for themselves, such as illustrations, similarity of spelling or sound in the mother tongue, and general knowledge.

**i. Eliciting**

This technique is more motivating and memorable by simply giving pupils a list of words to learn.

**j. Translation**

There are always some words that need to be translated and this technique can save a lot of time. Other techniques of introducing new vocabulary are suggested by Gairns and Redman (1986: 76) as follows:

**a. Visuals****1) Visuals**

Visual techniques can be in the form of flashcards, photograph, blackboard drawings, wall charts, and realia. All of these techniques are extensively used for conveying meaning concrete nouns like animals or fruits, and certain areas of vocabulary such as professions, places and description of people and activities.

**2) Mime and Gesture**

These are often used to supplement other ways of conveying meaning. When teaching an item such as *to chew*, a teacher might build situation to illustrate it, make use of the blackboard and gesture to reinforce the concept.

**b. Verbal Techniques****1) Use of Illustrative Situations (Oral or Written)**

This could be the most helpful ways when the items become more abstract. The teacher often uses more than one situation or context to check that learners have grasped the concept.

**2) Use of Synonymy and Definition**

Teacher often use synonymy with low level students, where inevitably they have to compromise and restrict the length and complexity of their explanation.

**3) Contrasts and Opposites**

A new item like *big* is easily illustrated by contrasting it with *small* which is already known by the students. In this case, the teacher must have known exactly which vocabulary has been mastered by the students and which has not.

**4) Scales**

After the students have learnt two contrasted or related gradable items, this can be a useful way of revising and feeding in the new items.

**5) Examples of the Type**

To illustrate the meaning of subordinates, such as *flower*, *vegetables*, and *foods*, it is a common procedure to exemplify them e.g. rose, jasmine, and orchid are all *flower*. But the technique cannot be applied in delivering the words that belong to more than one ordinate.

**c. Translation**

---

This technique can be a very effective way to convey the meaning because it is not time consuming that might otherwise be spent on a complicated and largely unsuccessful explanation in English, and it can be a very quick way to dispose of low frequency items that may worry the students but do not warrant significant attention. The teacher give the meaning directly, so the students did not need to get involve in the process in finding the meaning.

Schmitt and McCarthy (1997: 11) propose strategies to learn vocabulary as follows: (1) guessing from context, (2) using word parts and mnemonic techniques to remember words, and (3) using vocabulary cards to remember foreign language-first language word pairs. It is supported by Decarrico in Murcia (2001: 290) who also propose three strategies to learn vocabularies. The first is guessing meaning from context; she says that a context is rich enough to adequate clues to guess word's meaning. The second is mnemonic devices: she proposes keyword technique. When seeing or hearing the target word, the learner is reminded of the keyword. The third is vocabulary notebooks; she suggests a memory aid in independent learning by setting up vocabulary notebooks. Based on the techniques used for presenting new vocabulary, the experts suggest lots more of techniques that are claimed to be helpful for students to learn vocabulary in an easier way. What the researcher sees as the better way to teach vocabulary is by learning in rich contexts.

## CONCLUSION

The research has made some findings. It had been found that before the action the students' vocabulary mastery was low. As identified from the result of pre-observation and pre-test. The pre-research showed that the teacher did not use appropriate method in presenting the materials. She taught the students by translating the vocabulary. This method did not give an opportunity for the students to show their ability and potential. There was also no media used in teaching and learning process. It made the students easily get bored and pay poor attention to the lesson.

From the research, teaching vocabulary using contextual teaching and learning can improve the students' vocabulary mastery and change the students' behavior. The improvement after CTL is applied in the teaching and learning process could be seen in the increasing students' participation in learning English.

Those improvements are as follows:

1. The improvement of students' participation in attending the lesson. The students participate well in following all the procedures of the teaching learning process. They love to take part in every single activity held in teaching and learning process. They are able to make a discussion with their group. They are also good in pair and individual activity. The better participation from the students is also indicated by their willingness in asking and answering questions.
2. The improvement of learning situation. The students learn in an enjoyable situation. They find that contextual teaching and learning is not boring. They could collaborate well with other students. Contextual teaching and learning is not always held by sitting in the chair and listening teachers' explanation for a long time, but the students have wider space to learn and this method creates a non-threatening situation which automatically made them consider that English is not a difficult subject.
3. The improvement of the students' spelling. Since the poorest component of vocabulary in the result of the first post test is spelling, the researcher and the teacher gave more spelling activities.

As the result, the students could practice to write the English word and had courage to speak up in English.

4. The improvement of students' score. One of the indicators that the action is successful is the improvement of the students' mean-score.

Before using CTL, the students tend to be passive. When the teacher asked some questions, nobody wanted to answer the questions. But after CTL was applied in the class, almost all of the students raised their hands as a sign for willing to answer the questions. The students were interested and motivated in learning English. Since CTL was done in group work activity, there was no problem of shy students. The students did not feel reluctant to ask to their own friends. They worked together as a team and there was also no domination of some students. The students were more enthusiastic and active in joining the lesson. Besides, their achievement also improved, as shown by the mean score of post-test an increase of the students' achievement from pre-test. Based on the research finding above, the researcher conclude that teaching vocabulary using CTL can improve the students' vocabulary.

#### REFERENCES LIST

1. Brewster, Jean, Gail Ellis, and Dinis Girard. 1992. *The Primary English Teacher's Guide*. London: Penguin Press.
2. Brumfit, C., Moon, J., and Tongue, R.. 1997. *Teaching English to Children. From Practice to Principle*. Collins ELT: Longman.
3. Burns, Anne. 1999. *Collaborative Action Research for English Language Teacher*. Cambridge: CambridgeUniversity Press.
4. Coady, James, and Huckin, Thomas. 1997. *Second Language Vocabulary Acquisitions*. UK: CambridgeUniversity Press.
5. Deen, IfrajShamsid and Bettye P. Smith. 2006. *Contextual Teaching and Learning Practices in the Family and Consumer Sciences Curriculum*.
6. *Journal of Family and Consumer Sciences Education*, Vol. 24, No. 1, Spring/Summer.

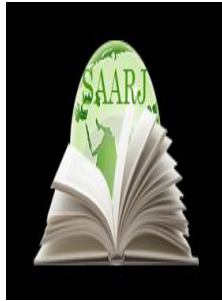

**ACADEMICIA**  
**An International**  
**Multidisciplinary**  
**Research Journal**  
 (Double Blind Refereed & Peer Reviewed Journal)



**DOI: 10.5958/2249-7137.2021.01188.5**

**FOCUS ON PRESCHOOL EDUCATION - TODAY'S DEMAND**

**Parmanov Abdulla Esanturdievich\***; **Mukhammadiev Kahramon Sodikovich\*\***;  
**Esanturdieva Shahlo Abdullaevna\*\*\***

\*PhD, Associate Professor,  
 Institute of Retraining and Advanced Training of Directors and,  
 Specialists of Preschool Educational Organizations,  
 Head of the Department "Pedagogy and Psychology",  
 UZBEKISTAN

\*\*Senior lecturer of the Department of "Pedagogy and Psychology",  
 UZBEKISTAN

\*\*\*3rd year student of the Tashkent Institute of Irrigation and,  
 Agricultural Mechanization Engineers,  
 UZBEKISTAN

Email id: ap523e@mail.ru

**ABSTRACT**

*This article notes that the system of education and upbringing in the Republic over the years of independence and the upbringing of a harmonious generation have been elevated to the rank of the main priorities of state policy. In addition, the essence of the law "On Preschool Education and Training", approved on December 16, 2019, is presented. In particular, the law clearly defines the main directions of the state policy in the field of pre-school education and vocational training, as well as State guarantees for pre-school education and vocational training. The article also stipulates in the law that the state guarantees the right of every child to compulsory one-year education in the system of general secondary education in state preschool institutions one year before entering the organization of general secondary education. Preschool educational organizations are organized by such types as the general type of preschool educational organization, a multidisciplinary specialized preschool educational organization, a preschool educational organization with inclusive groups, a joint type of preschool educational organization and its functions. The article noted the participants of the educational process under the law: the rights and obligations of children, their legal representatives and the teaching*

*staff, guarantees of social protection of preschool children, the organization of their nutrition and the procedure for protecting their health, the procedure for paying for the weekly workload and the work of educators, and also made conclusions about the development of social protection of preschool children. This article notes that during the years of independence, the system of education and upbringing of the harmoniously developed generation in the republic has risen to the main priorities of state policy. The following is the content of the law ZRU-595 "On Preschool Education and Upbringing", approved on December 16, 2019. In particular, the law clearly defines the main directions of state policy in the field of preschool education and upbringing, as well as state guarantees of preschool education and upbringing. The article also states that the State guarantees the right of every child to complete one year of compulsory general secondary education in State preschool institutions one year before entering general secondary education. Preschool educational organizations are organized by such types as the general type of preschool educational organization, a multidisciplinary specialized preschool educational organization, a preschool educational organization with inclusive groups, a joint type of preschool educational organization and its functions. The article noted the participants of the educational process under the law: the rights and obligations of children, their legal representatives and the teaching staff, guarantees of social protection of preschool children, the organization of their nutrition and the procedure for protecting their health, the procedure for paying for the weekly workload and the work of educators, and also made conclusions about the development of social protection of preschool children.*

**KEYWORDS:** *System Of Education And Upbringing, Healthy And Developed Personality, System Training, System Training, Advanced Training, Modern Educational Programs And Technologies, Main Directions Of State Policy, State Guarantees, Mandatory One-Year Training, Special Educational Needs, Alternative Forms Of Education And Upbringing, Research Institutions, Preschool Educational Organization Of General Type, Multidisciplinary Specialized Preschool Educational Organization, Inclusive Groups, Preschool Educational Organization Of The Joint Type, Non-Governmental Preschool Educational Organization, State Standard, Professional Standard Of The Teacher.*

***"If you want to be my friend, focus on preschool."***

**Sh.M.Mirziyoev**

## **INTRODUCTION**

During the years of independence, the education system and upbringing of a harmoniously developed generation in the country have risen to the level of the main priorities of state policy.

Preschool education is the primary part of lifelong learning. It ensures that the child develops into a healthy and developed person, stimulates the desire to learn and prepares for systematic learning.

The purpose of pre-school education is to prepare children for school, to form a child as a healthy, developed, independent person, to reveal their abilities, to cultivate a passion for learning, systematic education.

### **MATERIALS AND METHODS**

Further improvement of the integrated system of continuing education as an important part of the system of pre-school education, expansion of the network of preschool educational institutions and strengthening their material and technical base, providing them with qualified teaching staff. Our main goal is to radically increase their school readiness.

On December 16, 2019, the President signed the Law ZRU-595 "On Preschool Education and Upbringing." The law clearly defines the main directions of state policy in the field of preschool education and upbringing, as well as state guarantees for preschool education and upbringing [2].

In particular, the state guarantees the right of every child to undergo one year of compulsory one-year preparation for general secondary education in state pre-school educational institutions one year prior to enrollment in general secondary education.

Article 5 of the law sets out the main directions of state policy in the field of preschool education and upbringing.

They include: ensuring the right of every child to pre-school education and upbringing;  
creating conditions to ensure full coverage of children in preschool education and upbringing;  
to provide comprehensive assistance to the family in the development of the child, pre-school education and upbringing;  
creation of conditions for quality pre-school education and upbringing of children, including children with special educational needs;  
creation and development of alternative forms of education and upbringing;  
state support for the development of preschool education and upbringing;  
introduction and development of public-private partnership mechanisms aimed at expanding the network of preschool educational institutions;  
introduction of modern innovative and information and communication technologies for the comprehensive development of preschool children;  
development of international cooperation.

The system of pre-school education includes:

- preschool education organizations;
  - alternative forms of education;
  - Research institutions and educational organizations operating in the field of preschool education and upbringing;
- public administration bodies in the field of preschool education and upbringing, as well as organizations under their jurisdiction.

By law, a preschool organization can be a government or non-government organization.

---



Preschool education organizations are organized in the following types:

- General type of preschool education;
- Multidisciplinary specialized preschool education organization;
- Preschool education organization with inclusive groups;
- Joint type preschool education organization.

## **RESULT AND DISCUSSION**

The implementation of the state educational program of preschool education and upbringing will be ensured in the general development groups of the general type preschool education organization.

The implementation of the state educational program of preschool education and upbringing for children with physical or mental disabilities in the development of a multidisciplinary specialized preschool education organization will be ensured.

A preschool with inclusive groups provides equal opportunities for children to receive education and upbringing by adapting them to a healthy environment, taking into account their individual learning needs and individual capabilities.

The state educational program of pre-school education and upbringing aimed at organizing the joint study and upbringing of children with physical or mental disabilities and children with developmental disabilities in separate groups, as well as in inclusive groups in a single type of preschool education organization.

The groups are divided into age-appropriate categories of early development (1 to 3 years), small (3 to 4 years), medium (4 to 5 years), large (5 to 6 years) and pre-school (6 to 7 years). Completion of groups and transfer of children from one group to another is done every year until the beginning of the school year. According to the agreement with the Ministry of Preschool Education, it is allowed to organize groups with the maximum amount of their filling. The procedure for filling groups in non-governmental preschool educational institutions shall be established by their founder, taking into account the sanitary and hygienic requirements for the maintenance of preschool educational institutions, their structure and organization of their work regime.

The law sets out the rights and responsibilities of the participants in the educational process: children, their legal representatives and teachers. Social protection of preschool children is guaranteed, the order of organization of their nutrition and health protection, the order of weekly workload and remuneration of teachers are established. The governing bodies of public kindergartens: the powers of the pedagogical council, the supervisory board and the heads have been regulated.

From the point of view of recipients of educational services, it is important to ensure the quality of the educational process. The following public administration programs are used for this purpose:

- State accreditation of preschool education organizations is carried out in 5 years, the activities of private organizations are licensed. In both cases, the procedure is established by the Cabinet of

Ministers, and the State Inspectorate for Quality Control in Education under the Cabinet of Ministers is the competent authority;

- The state standard, which is mandatory for all preschool educational institutions, is adopted and revised at least once every 5 years, the state educational programs are approved;

- The professional standard of the teacher is approved by the Cabinet of Ministers, the professional standard of the teacher sets inseparable requirements to the personal qualities of the teacher from his knowledge, skills and abilities. Teachers are certified at least once in 5 years. Persons with incapacity or limited legal capacity, diseases or physical disabilities that impede the implementation of pedagogical activities, as well as persons previously convicted for intentional crimes may not engage in pedagogical activities in preschool education institutions.

The Address of the President of the Republic of Uzbekistan ShavkatMirziyoyev to the OliyMajlis on December 29, 2020 stated that the coverage of young children with preschool education has doubled in four years to 60%, and the number of kindergartens has tripled to more than 14,000 [2].

In his speech, the President noted that from the moment a child is born, it is at the pre-school age that mental activity increases, moral, aesthetic and physical qualities are formed. Therefore, our strategic goal for the development of preschool education in the coming years is to create the necessary conditions for the full coverage of every child of kindergarten age in this area of education.

At the same time, a number of tasks have been set for the preschool education system. In particular, by the end of 2021, the coverage of preschool education should reach 65%, and by the end of 2023 - 75%. An additional 2,000 non-governmental kindergartens will be established with a budget subsidy of 600 billion soums, and the share of the private sector will increase to 25 percent. Also, in 2021, 560,000 6-year-old children or 82% of them will be covered by the free school preparation system.

Alternative forms of pre-school education will be further expanded in remote villages. At the same time, in cooperation with UNICEF and the World Bank, a model of home pre-school education for children with disabilities will be launched.

## CONCLUSION

Therefore, today we must pay special attention to the preschool education system, dramatically increase the coverage of preschool education, create a healthy, active, harmonious, socially adapted child's personality, as well as conditions for future successful learning activities and quality preparation of children for primary education. required. We also need to ensure the coherence of primary education curricula, the use of modern forms of teaching, new pedagogical and information technologies in the preschool education system. These issues are among the most pressing and urgent tasks of today.

## REFERENCES

1. Law of the Republic of Uzbekistan "On Preschool Education and Training" ZRU-595 (December 16, 2019).

2. Address of the President of the Republic of Uzbekistan Shavkat Mirziyoyev to the Oliy Majlis of December 29, 2020.
3. Resolution of the President of the Republic of Uzbekistan dated November 6, 2020 No PP-4884 "On additional measures to further improve the education system."
4. Resolution of the Cabinet of Ministers of the Republic of Uzbekistan dated March 3, 2020 No 132 "On measures to further develop the system of compulsory one-year preparation of children for primary education."
5. Resolution of the Cabinet of Ministers of the Republic of Uzbekistan dated December 22, 2020 No 802 "On approval of state standards of preschool education and upbringing."

**Electronic sources:**

1. <http://google.co.uz/>,
2. <http://www.lex.uz>,
3. <http://www.MDO.uz>,
4. <http://www.mdomoi.uz>.

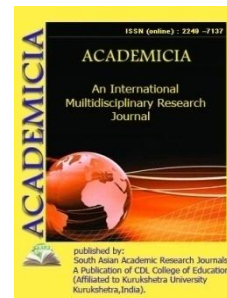
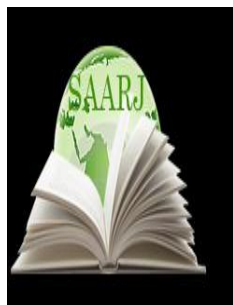

DOI: **10.5958/2249-7137.2021.01187.3**

## PROBLEMS AND THE MAIN ERRORS IN TRANSLATION

**Anypa Taekeeva\***; **Dilnoza Jaksulikova\*\***; **Utebaeva Bibizada\*\*\***

<sup>1,3</sup>Karakalpak State University,  
Nukus, UZBEKISTAN

### ABSTRACT

*The article examines the problems and errors of interpretation and translation of texts that students face when teaching foreign languages. Translation theory not only formulates the goals and objectives of translation, but also suggests ways to resolve the translation problems listed in this article. The importance of establishing correspondences and discrepancies in two languages - lexical, grammatical and stylistic - is emphasized.*

**KEYWORDS:** *Translation Studies, Translation Theory, James Holmes, Translation, Transformation, Homophones, Non-Equivalent Vocabulary.*

### INTRODUCTION

Despite the fact that translation theory as a science emerged only in the 20th century, many of its problems were recognized and considered many centuries ago. This is evidenced by the statements of translators, poets and writers, who often acted as translators themselves, as well as the reviews of political figures preserved by history. For several centuries, everyone who was directly involved in translation turned to the practical problems of their work, giving them theoretical understanding.

Initially, translation studies were based mainly on the practice of translating the Bible, philosophical and natural science works, and literary works. Translation helps people overcome language and cultural barriers. In our time, the importance of translation activity has increased, and the requirements for its quality have increased. The accuracy and quality of translation is constantly being improved. To date, translators have come to create a text that is fully consistent with the original in another language.

### Materials and Methods

For more than 50 years, translation has existed as an academic discipline, and its achievements are used to teach a foreign language using a communicative approach. In 1972 in Copenhagen, at

the III International Congress of Applied Linguistics, James Holmes announced the need to change focus and study translation within the framework of an integrated approach. Holmes identified three main obstacles to the further development of this theoretical discipline:

- scientists and researchers are "scattered" in different fields of science, and they do not have common channels of communication;
- "Trivial question" - no name for this area of study;
- there is no consensus on the scope and structure of the discipline.

Also J. Holmes proposed a scheme for his integrating concept. The scientist identified two main areas of research: "pure" and "applied" translation studies. The first was subdivided into theoretical and descriptive, which should be focused on: 1) the synchronous or diachronic study of the translation product, 2) the psychological study of the translation process, and 3) the sociological study of the functions of translation.

The applied branch consisted of translation didactics, translator aids, translation criticism and translation policy, which determined the place and role of translation and translator in society. The resources of a professional translator are knowledge of languages and cultures, specific translation skills, as well as their own personal characteristics and cognitive abilities. Cognitive elements and processes during translation are subject to multiplication, since an additional cognitive element appears between the speaker and the observer - the translator. The translator has to analyze and model the cognitive scheme of the author of the original text and recreate it in the translated text, thereby involving the cognitive levels of all three participants in intercultural communication in interaction.

So, when using transformation in translation, that is, paraphrasing, the translator should not only not simplify the meaning of the translation, which is functionally assigned only to the speaker, but also take into account the linguo-ethnic barrier that is present in the everyday life of any people. We are talking about a different perception of the world around us, the manner of communication, national traditions and habits, attitudes towards elders, work, holidays, their social responsibilities, etc.

Interpretation can be simultaneous and consecutive. Consecutive is performed in the pauses between the phrases of the speaker. Simultaneous translation by ear is the pinnacle of translation art. The translating language preserves the style and vocabulary of the speech. There must be a strict differentiation of the language by genre style. The translator in no way shows his attitude to the text he is translating, the ceremony taking place and the persons present.

Written translation differs from oral translation in that the text can be repeatedly altered and the desired translation option can be selected. The subtleties laid down by the author in the content are analyzed and transferred to the system of the translating language.

Translation methods are divided into automated and manual. Today there are a large number of programs - "translators" and sites that offer online text translation services. Students try to apply these programs to translate texts. However, this method of translation cannot often be called successful.

**Main Part**

An electronic translator may well make a translation of a specific word. But it is impossible to enter all cases of correct translation into dictionaries, and first of all this concerns technical terms. The inability to convey the associative array and the inadequacy of the analysis of the context of phrases is one of the main and practically unavoidable shortcomings of the "electronic translator". He gives out a literal translation, since he is not able to determine the figurative meanings of words or choose an appropriate translation option from several that are suitable on formal grounds. As a result, errors occur that distort the meaning of the text.

Translation is a complex process consisting of several, closely related and transitioning stages:

1. Preparatory stage. It is necessary to read the entire text or at least a part of it to yourself in order to get an idea of what is being said, to understand the main idea, the general meaning of the message.

2. Draft translation. Having understood the general content of this passage, you need to make its semantic analysis. After that, the text is marked up, difficult terms, grammatical constructions, lexical expressions, as well as Anglo-American measures (for conversion to metric) are identified.

It is recommended to write out all the core terms, as they appear in the text, on a separate sheet along with their Russian equivalents and use them throughout the translation process. Then you should proceed to work on individual sentences, dividing each into elements and links, realizing the connections between individual words and groups of words. After the connections between words are established, it is necessary to determine the corresponding meanings of unfamiliar words in the dictionary, but not in the order they appear in the text, but depending on the functions they perform in the sentence. You need to start with the disclosure of the meanings of the main members of the sentence - the subject and predicate. The title should be translated after the entire text has been translated. A draft translation can be done both in writing and orally.

3. Working translation. After the draft translation is completed, the sentences (paragraphs) of the text of your own translation are checked against the original so that each phrase of the translation corresponds to the original text, the uniformity of the terminology used, and the logic of presentation. The text of the translation is freed from expressions and phrases unusual for the Russian language, stylistic and semantic corrections are introduced into it. A working translation is a full-fledged, stylistically competent translation that correctly conveys the content of the original, in which some terminological and stylistic inaccuracies are allowed.

4. Final translation. This is the last stage of translation - literary processing and scientific editing. Without looking into the original, relying on the correctly revealed meaning with all its shades, it is necessary to convey all of its content into literary Russian. At the same time, if necessary, you can change the order of words, turn complex sentences into simple ones, and vice versa, develop simple ones into complex ones. Such a translation is complete, stylistically competent, it correctly conveys the content of the original and accurately uses special terminology.

It should be noted that when expressions are encountered that cause difficulties in translation, it is not always a matter of poor vocabulary or poor grammar knowledge. The ability to translate correctly is a whole science. English and Russian languages differ in their structure and system

of images, so the correct translation from English is often not an easy task. There are some major translation difficulties to consider.

The first of them is the polysemy of words. Many constructions of the Russian language turn out to be cumbersome in comparison with English phrases. It so happens that in the Russian language there is no meaning at all for any word. This may affect the nature of the translated sentence from English.

The verb to get is one of the most polysemantic verbs in the English language. For example, in the sentence We got the dress to our mother, the verb is used to mean "buy". And in the example: She got us tea - translated as "brought". Here are some more examples:

I'll get the translation by tomorrow. - I'll finish the translation by tomorrow.

I want to get the sofa to the sitting-room. - I want to move the sofa to the living room.

The next trap in translation is phrasal verbs. It is important to know that prepositions or postpositions that occur in stable verb combinations absolutely change the original meaning of the verb:

to call - call, call, call to call for - required

to call up - call

to call - enter (visit)

The example shows that the same verb with different prepositions acquires new meanings, which may be completely unrelated to the root word. Words that can be different parts of speech are also a problem in translation. So, a word can be an adjective, a noun, or a verb. And since there are no endings in English, the nature of such words can be determined based on their place in the sentence (syntax)

The main reason for translation errors is the translation of individual words or phrases; violation of the logical connection between parts; inability to distract from specific forms of words and inability to use context to understand their meaning. This needs to be learned. It should also be borne in mind that old words sometimes acquire qualitatively new meanings, and individual words outside the context do not have a definite meaning and therefore cannot be translated. It is not words that are translated, but what they express.

## CONCLUSION

In conclusion, it should be noted that for the translator, it is not so much knowledge of the vocabulary that is important, but knowledge of the peculiarities of its functioning in various situations. Therefore, it is important to develop in oneself the skills of analytical and critical work on the text of the translation, in every possible way to develop a sense of language and style, without which a qualified translation from any language is generally impossible.

## LITERATURES:

1. Komissarov VN General theory of translation: Problems of translation studies in the coverage of foreign scientists / VN Komissarov. - M.: Chero, 1999 .

2. Sdobnikov V.V., Petrova O.V. Translation theory: A textbook for translation faculties and faculties of foreign languages. - N. Novgorod: Publishing house. NGLU them. N.A. Dobrolyubova, 2001 .
3. Romanova O.N., Dolinskaya A.V. Fundamentals of technical translation. - Volgograd: VolgGASU, 2011 .
4. Semenova M.Yu. Basics of text translation. - Rostov-n / D: Phoenix, 2009 .





**ACADEMICIA**  
**An International  
 Multidisciplinary  
 Research Journal**  
 (Double Blind Refereed & Peer Reviewed Journal)



**DOI: 10.5958/2249-7137.2021.01213.1**

## TECHNOLOGY OF WATERMELON AND PAINTING IN FINE ART AND EXPRESSION OF COLORS

**Yurdanidze Mehrali Kholisovich\*; Ismonov Khurshidbek Bakhtiyorovich\*\***

<sup>1,2</sup>Lecturer,

Department of Fine Arts and Engineering Graphics,  
 Andijan State University  
 UZBEKISTAN

Email id: yurdanidze78@gmail.com

### ABSTRACT

*This article discusses the introduction of interactive technologies and distance learning in the educational process, as well as the creation of a wide range of watercolors, watercolors, technologies, the use of which can be used to achieve effective results in fine arts classes. 'he said. Hierarchical technologies are reflected in students' visual abilities, contribute to the formation of introspection, thinking skills.*

**KEYWORDS:** *Fine Art, Watercolor, Watercolor, Coloring, Color Gamut, Paper, Canvas, Primer, Baguette.*

### INTRODUCTION

Man always lives in harmony with art. If we look closely, we are surrounded by the beauties of various artists, natural landscapes and magnificent buildings. There are so many types of art. They are music, cinema, theater, choreography, fine arts and more. Art that usually depicts an object in pictorial images, shapes, spatial latitudes, or planes (on a paper surface, a wall surface, etc.) is called fine art. As long as the artist depicts a real being in his works, he will never copy it mechanically. Otherwise, the works of art he creates will be no different from the pictures created by the photographer. The task of the artist is higher. As he describes the events and happenings in life, he puts forward any idea that excites him through the image, seeks to reveal the essence of the events and happenings in social life, expresses his attitude to them, makes judgments. For example, when an artist paints a picture of a person, he is never limited to just trying to imitate it. Through this working image, the artist first of all tries to convey his thoughts and feelings to the audience. The spectator sees the image of the noble, courageous people

depicted in the picture, is proud of him, imitates him, takes an example from him. Just as the beauty of music and song cannot be described in words, so the artist's work cannot be described in words.

### MAIN PART

When looking at works of fine art, it is also important to be able to accurately show how the psychological experiences of each image are resolved, and their relationship to the environment. Therefore, both the color scheme used by the artist and the composition of the event, the artist's workmanship, the nature of each selected shape, the overall color gamut - the color, the nature of the surface (for example, the smoothness or roughness of the surface) It is necessary to try to find an answer to why they were taken. Only then can one understand the true nature of works of fine art and learn to analyze them correctly.

As each artist shapes his or her work, he or she is inspired to discover new horizons. Expressing works of fine art in painting makes the work more vivid. Paintings are made using different colors. Schools and high schools teach more watercolor painting

**FIGURE 1**



**Water color**



**Water color**

Watercolor technology is then taught in colleges and universities (Figure 1).

### RESULTS

Requirements for painting work:

The following requirements apply to a colored still life:

- The image is placed correctly on the paper surface;
- The correct proportions of the described objects are obtained;
- The line image is found correctly;
- The hunger-saturation ratios of the items, as in nature, are correctly expressed using colors;
- The sharpness of the ratio of shadow and light in the image is accurately expressed;
- The ratio of shade and light colors of the colors in the image is reflected in accordance with the intensity of light;
- Correct local color saturation of objects in still life;
- The choice of color direction corresponding to the material of each item in the still life;

- The size of each item;
- The color perspective is a free expression of the distance between the objects placed in nature;
- Effective use of watercolor technology;
- The brightest and darkest of the colors involved in the still life;
- General integrity is found;
- Skillful depiction of shadows in bright, reflective, semi-shadow, blur and falling shadows in color media;
- Different description of items with full and empty interior;
- The correct placement of all objects in the plane of the object;
- Ensuring the general symmetrical construction of circular objects.

Watercolor painting opens up a wide range of possibilities for the artist. It takes a lot of skill and attention to work with watercolors. Because the colors go from light to dark. It will be difficult to correct the mistake and correct the mistake. The colors are stacked on top of each other in a watery state (Figure 2).

**FIGURE 2**



**Stage 1**

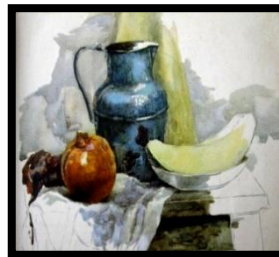

**Step 2**



**Stage 3**



**Step 4**

The colors dry out and move from one stage to the next Color matching. The work is completed by expressing the falling shadows, paying attention to the collisions, the proportions, and the shadows.

Watercolor painting is partially easier and more versatile than watercolor. First, make a frame of the right size for the picture. Then draw a size that fits the frame. We also need to make sure that the canvas (a special fabric for watercolors) is not too tight and flat. The finished surface is then primed. We can draw the picture we want to draw on it in pencil on the plane of the picture. Unlike watercolors, this painting should be done from hunger to hunger, not from hunger to hunger. We pay attention to the compatibility of dark colors with each other, their perspective (reduction or opening of colors as they move away). In the final stages of the work, we finish the work by putting the brightest colors (Figure 3). When working with watercolors, you can also correct any incorrect color.

**FIGURE 3**



**Stage 1****Step 2****Stage 3****Step 4**

When the picture is completely painted and the work is completed, a suitable baguette will be placed on the picture. The baguette (outer frame of the work) is also selected depending on the overall color of the work - color, size (Figure 4).

**FIGURE 4****CONCLUSION**

When everything and an event are described, it is impossible to portray it as it really is. This has always been emphasized by many art theorists, artists, and practitioners. Nevertheless, if we can use all our knowledge and show the way to the next generation, their interest in art will increase and they will be able to contribute to the development of our independent Uzbekistan. mature professionals who will be trained.

**REFERENCES**

1. Xolmatov B.Q. Composition. Textbook. - Tashkent.: "Economics and Finance", 2007.
2. Saibov T.Rangtasvir.Textbook.-Tashkent.:2007.
3. Bolatov S.S. Coloring. - Tashkent.: "Uzbekistan", 2007.
4. Abdirasilov S, Tolipov N, Oripova N. Color image.-T.: "Uzbekistan", 2006.
5. Nazilov D. Fundamentals of composition.-Tashkent.: "New Century Generation", 2009.
6. Khasanov R. Fundamentals of Fine Arts. -T.: "Ghafur Ghulam", 2009.

7. Pulatov D. Art of Uzbekistan. (Textbook) - Namangan.: "Namangan", 2018.
8. Yu.M.Kirzer. Drawing and painting. High School, 2005.
9. Xakimov A.A Art in Uzbekistan. –T.:InfoCapital Group, 2018.
10. Khakimov A. Art criticism of Uzbekistan. –Tashkent.: “OOO Blik”, 2003.
11. Egamov A. Fundamentals of composition. - Tashkent.: “Art”, 2005.
12. Khasanov R. Methods of teaching fine arts at school.-T.: "Science", 2004.
13. Painting (still life in watercolor). Textbook. –Tashkent.: 2019.
14. Boymetov B. Qalamtasvir. - Tashkent.: “Music”, 2006.

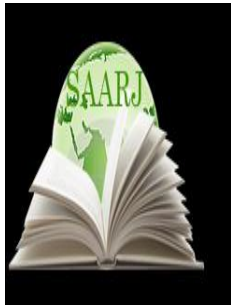

**ACADEMICIA**  
**An International  
 Multidisciplinary  
 Research Journal**  
 (Double Blind Refereed & Peer Reviewed Journal)



**DOI: 10.5958/2249-7137.2021.01214.3**

## YOUTH MENTALITY: SCIENTIFIC AND TECHNICAL KNOWLEDGE AND OBJECTIVE LAWS OF SPIRITUAL DEVELOPMENT

**Rajabboev Jurabek\***

\*Student,  
 Department of National Idea,  
 Fundamentals of Spirituality and Legal Education,  
 Urgench State University, Urgench, UZBEKISTAN  
 E-mail id: sv997710@gmail.com

### ABSTRACT

*In this article discussed the spiritual changes that have changed the mentality of today's youth of the socio-cultural space in the era of globalization. The main characteristics and basic parameters of modern globalization are analyzed. It also analyzes the emergence of social ties, solidarity and originality in uniting the world in all areas and on an interethnic scale. It has been concluded that all of these processes affect the change in the mentality of today's youth.*

**KEYWORDS:** *Innovation, Creation, Creativity, Superior, Modern Education, Cognitive, Processes, Harmonious View, Globalist Worldview, Expanded Youth Mentality, Youth Value Orientations, Youth Consciousness.*

### INTRODUCTION

Although we clearly see today that there can be no social development without scientific and technical discoveries, no work on spirituality mentions the importance of scientific and technical knowledge, the methodology of their study does not reveal. Scientific and technical knowledge is also a reflection of the objective laws and requirements of spiritual development. Actually, there is no place in our spiritual heritage to solve this problem, but the present time requires scientific and technical research; the effective use of the achievements of the scientific and technological revolution in all spheres of social life has become a necessity. Undoubtedly, such qualities as social justice, ideal society, perfect man, high spirituality, humanity, patriotism, faith, good behavior, community, unity, humility, generosity, peace-loving, diligence, family-oriented, which are glorified in the spiritual heritage of our people, are immortal. It is our duty to assimilate and inculcate it in the hearts of the younger generation. However, it is also true that

the objective laws of social development, the requirements of innovative development expect from us scientific and technical knowledge, discoveries. At the same time, it should be noted that historicalism and traditionalism prevail in spiritual-moral imperatives, which can sometimes lead to stagnation, conservatism. This historianism helps to ensure stability and unity in society, in interpersonal relations, strengthens the ties between the individual and society, it makes intergenerational diachronic ties into important values. However, they can also be an obstacle to innovative changes.

So we need to focus on deciding on a certain consensus, conformity, between traditionalism and modernization. Where historicism prevails, any innovation remains a dry desire. Therefore, it is necessary to pay due attention to young people who are active subjects of innovation, to form in them not only the ability to master innovations and creative activity, but also the ability to live with moral imperatives embedded in the spirituality of our people. Reconciling these two hypocritical, contradictory sides, no matter how complex and difficult the task is an objective requirement of our national development.

### **MATERIALS AND METHODS**

Spiritual and moral imperatives are, in essence, the values created by our ancestors, inherited from them, the mentality, way of life and cultural life of our people and nation. Their connection with different interests and hobbies has formed the categories of "I" and "We" in the spiritual and moral life. "Rituals, traditions, and customs that have been formed and developed in a society over the centuries are also a manifestation of the moral relationship that exists between the individual and society. Based on these, the relationship between the individual "I" and the collective "We" is harmonized [1].

Many literatures emphasize the predominance of "We" in the spiritual and moral imperatives of the East. The fact that this communism has risen to the level of tradition is not a negative, conservative case, of course. But in the development of society, the category of "I" or "We" has never been absolutely dominant, it was impossible to live without harmonizing them. It is natural that there is a contradiction between these categories. Because "the development of the relationship between the individual and society is not just about commonalities; There will also be contradictions in this relationship;

The basis of these contradictions is the disproportion in the understanding and formation of the relationship between the individual and society. A individual is a special person. And society is the unity of such individuals formed on the basis of certain goals. Conflicts occur as a result of society not understanding the individual, the individual not understanding society. Take the life of Maria Curie Skladovskaya, a two-time Nobel laureate, for even major social tragedies, such as the contradictions that arise as a result of personal selfishness or, conversely, the complete shadowing of personal interests. Having a unique scientific ability, the genius creator is so devoted to her interests and researches that she do not even think that a woman should have at least three or four dresses. Her "I" is Polonia, in search of radius. She wants to be alone all the time in this quest. Only her partnership with her husband, Pierre Curie (who is also a Nobel laureate), gives her peace of mind and satisfaction in life. It can be called creative (positive) selfishness, but still selfishness [2].

Many great artists are obsessed with one or another flaw, arrogance, as if glorifying their "I"[3]. That is why the Italian psychiatrist Lombroso notes the encounter of conceit, even

madness, in great creators [4]. Discovering something new, giving in to creativity is something that can lead to indifference. But this creative psychological state is unique to some individuals, and the whole society cannot live in such a state. In innovative mentality, there is a surge of creativity, but this is also typical of true inventors. The pain and joy of creating something activates the "I", sometimes making it a rival to those around him. That's why the great creators are introvert; don't like the circles, the crowds and the hassles. We find these qualities in Beruni, Ibn Sina, and mystics. The "I" is not limited to Western artists; we observe it in the qualities of almost all great personalities. However, the traditions of the East have always embodied the "I", and it is rare to go beyond the "We", even in the most talented people. In our opinion, this is the reason why scientific and technical mentality in the East is not sufficiently developed. This can be seen in the following reasonable thoughts of E. Yusupov: "Social moral duty and responsibility sometimes contradicts a individual's personal interests.

Man sometimes seeks to circumvent traditions, customs, which are part of social moral duty and responsibility. The tendency to deviate from certain traditions in the context of social problems is more common in young people who are influenced by emotions and passions. They sometimes tend to adapt them rather than adapt to a particular social, moral environment. In the field of love, there are times when parents try to achieve their goals without taking into account public opinion, and emotions sometimes lead a person astray. Some people go so far as to commit suicide when they cannot find a way to resolve the conflict between public opinion and personal interests" [5]

According to the scientist, the spiritual life of young people should be in line with public opinion, a reflection of the requirements of "We". Giving personal interests to the public is seen as a sign of spiritual maturity. Eastern traditionalism does not allow the individual to go beyond its own limits; it keeps it within the bounds of spiritual-moral imperatives. Is it good or bad? If there is a positive case, what are the positive aspects, and if there is a negative event, what are these aspects? What do these aspects have to do with the topic, innovative mentality? On the first question, academician E. Yusupov states the following: "Morality is the result of the fact that each person feels responsible and accountable to others.

Based on this, it can be concluded that moral maturity is the understanding, reliance and development of spiritual values that have been formed over the centuries in the course of one's life and activity. The key issue is not only what moral heritage each nation has, but also to what extent new generations adhere to and develop it. For this reason, it has always been a sign of morality that every person should follow the rules of behavior, manners, treatment and attitudes that exist in society. Deviation or disregard for traditions and values in this regard is considered immoral. Immorality is a violation of the balance between "I" and "We"[6].

## RESULTS AND DISCUSSION

It turns out that the values that have been formed over the centuries determine a person's behavior that following them is moral, that violating them is considered immoral. The centuries-old balance between 'I' and 'We' is transformed into a firm moral imperative that cannot be broken.

From a spiritual and moral point of view, this idea is remarkable, but there is a danger of translating it into all human behavior, including creative activity, innovative research. If we remember that almost all human activity in the East has been measured according to spiritual-



moral imperatives, we find that the above danger is not unfounded. At the same time, there is a positive side of this idea, the spiritual-moral imperative. The scientific and technological revolution in the West rejected the traditions formed over the centuries; saw the intellectual power of man, his scientific potential as the only factor that ensures social development. As a result, Western civilization has made great strides, rescuing man from muteness in the natural environment, making his life prosperous, his mind free and his possibilities wide, colorful and enjoyable.

But wealth, money, and prosperity, which the West worships as its core values, have become, according to E. Fromm, "universal arguments that will overthrow the world, change and destroy all natural things and human qualities"[7]. The scientific and technological revolution and that it gave birth the life ideals, lifestyle and way of thinking to play an important role in this. It is widely acknowledged that the scientific and technological revolution has caused global environmental, demographic and spiritual crises, and that it has brought humanity to the brink of destruction. These tragic consequences of the addiction to the development of scientific and technical mentality should not be transferred to innovative development. This can be prevented, first of all, by our spiritual and moral traditions, oriental traditionalism. This is where the conditionality of the dialectical relationship between spiritual and moral imperatives and innovative mentality is manifested. This is the answer to the first and second question above.

## CONCLUSION

Eastern traditionalism is based on the principles of "seven measures, one cut" and "thanks for everything." It is a priority to rely on traditions, to measure behavior in accordance with the norms and views decided in the social environment, to support only the initiative that conforms to these norms and views. The novelty seems to be atheism, even a violation of existing routines, traditions. Innovative mentality cannot be limited to such norms and views; it is characterized by constant restless research, creation of something, striving to improve existence. Continuous improvement is its element and demand.

## REFERENCES

1. Yusupov E. Spiritual foundations of human perfection - Tashkent: University, 1998. 79-p.
2. Curie E. Marie Curie. Translated from French. Ed. 3 e- Moscow: Atomizdat, 1973.
3. Secret passions of the great-Moscow: AST: Zebra E, 2008.
4. Lombroso C. Genius and insanity -Saint Petersburg, 1992.
5. Yusupov E. Spiritual foundations of human perfection - Tashkent: University, 1998. 79-p.
6. Yusupov E. Spiritual foundations of human perfection - Tashkent: University, 1998. 80-p.
7. Fromm E. Art of Moscow: AST, 2014 -S.315.

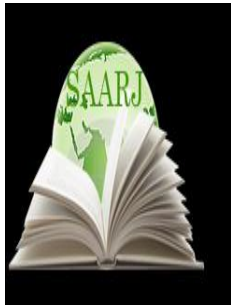

**ACADEMICIA**  
**An International**  
**Multidisciplinary**  
**Research Journal**  
 (Double Blind Refereed & Peer Reviewed Journal)



**DOI: 10.5958/2249-7137.2021.01167.8**

## INFLATION IN LAW MAKING: DEEP ANALYSIS OF UZBEK LEGISLATION

**Akmal Sodikov\*; Islomjon Nabijonov\*\***

\*The lecturer of Tashkent State University of Law,  
 UZBEKISTAN

Email id: akmalsodikov81@gmail.com

\*\*The student of Tashkent State University of Law,  
 UZBEKISTAN

Email id: nabijonovislomjon04@gmail.com

### ABSTRACT

*In the following paper the notion of normative inflation and its signs have been analyzed by the authors. The pace and efficiency of law making in the Republic of Uzbekistan have been discussed with the exact statistics found out with the aid of National Database of Legislation of the Republic of Uzbekistan (lex.uz) of Uzbekistan. The results of social survey, which was conducted among the professors-teachers staff and students of Tashkent State University of Law, have been revealed with a reasoned conclusion. In the conclusion the authors came into the point that the balance of adoption of normative legal acts and efficiency of law enforcement should be followed by the subjects of primarily and secondary law making.*

**KEYWORDS:** *Law Making, Pace Of Law Making, Normative Legal Acts, Legislation, Parliament, Statistics Of Law Making, Law Enforcement.*

### INTRODUCTION

Competent state bodies and officials adopt normative legal acts that are the product of law making process in the interests of the development of society and citizens. Because of these normative legal acts, the relevant sector is regulated and development prospects are determined.

Normative legal acts adopted today are growing intensively. They are widely accepted, but studies have shown that one of the main causes of failure in public administration today is normative inflation. Normative inflation is an inadequate increase in the number of legal acts, which leads to negative consequences for the development of legal relations and it negatively

effects on the quality of legislation, as well as the incorrect implementation of acts, especially by competent authorities. The study offers solutions to address this situation, the most important of which is to review the existing normative legal acts, simplify legislation, improve the quality of the law making process, especially compliance with legal requirements.

In order to broaden the research, it is essential to focus on the following questions, which shall be answered thoroughly in the discussion part.

- How useful is the acceleration of the law making process for the life of society?
- Are the people benefiting from this process?
- How fast are the legislative processes in Uzbekistan and what is the reason for its pace?
- Does the pace of legislation in Uzbekistan correspond to the legal consciousness and development of society?

Without going back to the long history, it is expedient to analyze the ongoing reforms in the legislative sphere of “New Uzbekistan”, to assess the volume of normative legal acts and their practical (effective or ineffective) impact.

## **METHODOLOGY**

The object of this study is to research the theoretical and practical problems of inflation in law making of the Republic of Uzbekistan. The main goal of the study is to develop definitions regarding the research as well as decide whether inflation in legislation is negative or positive event.

In order to achieve these goals, the authors have applied methods of scientific research, such as statistical analysis, chronological, sociological, analysis, synthesis, and comparative. In addition, to analyze public opinion on normative inflation in the country the authors carried out online questionnaire among professors and students of Tashkent State University of Law (TSUL), Uzbekistan.

## **LITERATURE REVIEW**

A lot of scientists and lawyers studied national law making process in term of improvement the activity. In particular, Sh.Khayitov [1] researched the legal experiment in law making process. A.Sodikov [2] analyzed the role of information in rule making process. The condition and problems of scientific theoretical and methodological bases of adoption of normative legal acts in Uzbekistan are analyzed in the scientific works of Sh.Saydullaev [3]. Use of modern technology in law making process and public control has been researched by Sh.Yakubov [4].

If we focus on the Russian scientists, they also discussed the law making process in various aspects. In detail, the monitoring of rule making process was conducted with practical statistics by Y.Arzasov [5]. In addition, several aspects touching our topic have discussed in the scientific world by other Russian scientists such as normative legal acts of executive branch of Russian federation by T.Kucherova [6], comparison of two law making centuries’ practice by M.I Baytin [7], law making techniques by E.Usmanova [8], differences of law making from law making by E.Yarmanova [9], problems of modern law making by A.Krasavin [10].

Additionally, foreign scholars who studied law making process in terms of different aspects such as scrutiny in law making by Lanny W. Martin, Georg Vanberg [11], quantitative analysis of German Legislature by Jasmin Riedl [12], Italian law making by means of sequence analysis by

Enrico Borghetto [13], the quantitative assessment of the timing of European legislation by Laszlo Kovats [14].

Although a broad range of lawyers, scientists and scholars, who studied law making process, focused on general problems of law making, the following paper is the first complex research covering the quantitative and qualitative assessment of Uzbek normative legal acts.

## DISCUSSION

In the scientific literature, legislative inflation is defined as “continuous intensification of lawmaking activities, which includes two interrelated areas: firstly, a steady increase in regulatory arrays (that is, the adoption of new legal norms, normative legal acts) and, secondly, permanent novelization, that is, regular amendments to the current legislation” [15].

In principle, both journalists and politicians base their statements regarding the pace of legislation on (subjective) judgements. Science, for its part, analyzed the pace either qualitatively or employed variables to measure the speed of legislation that cannot inform about single processes pace. What is lacking is an appropriate objective measure for the pace of law making that works if one takes single processes as the unit of analysis. That is unfortunate, since said debates on legislative acceleration and deceleration are generally heated [16].

Some scholars suggest that one of the way to minimize inflation in law making by codification. However, there are already acting Uzbek 21 codes [17]. In addition, 5 codes such as the Code on Non-governmental non-profit organizations, Environmental Code, Healthcare Code, Entrepreneurial Code, Information Codes were suggested to adopt by the President of the Republic of Uzbekistan [18]. If we look at German experience in codification, there are 5 codes in total such as Civil Code (Bürgerliches Gesetzbuch), Commercial Code (Handelsgesetzbuch), Criminal Code (Strafgesetzbuch), Code of Criminal Procedure (Strafprozessordnung), Code of Civil Procedure (Zivilprozessordnung) [19]. Some countries develop overviews regarding the volume of law making process take an example of Austria, the Austrian Parliament provides a detailed overview on its legislative processes, but more detailed research is necessary to check if all events are listed [20].

The national database of the legislation of the Republic of Uzbekistan was studied based on personal legal research in determining the inflation rate of normative legal acts. To come into conclusion about whether there is inflation in law making of Uzbekistan; indeed, we should compare the statistics of two years (2014 and 2020). In 2020, 2015 normative legal acts were adopted, of which 60 are laws, and 1955 are bylaws. If we look at the statistics for 2014, a total of 588 normative legal acts were adopted, of which 16 are laws and 572 are bylaws. From these facts, we can see that the volume of normative legal acts increased 3,4 times in 2020 compared by 2014 [21].

If we focus on the experience of the Russian Federation over the past six years (from 2011 to 2017), the State Duma of the Russian Federation adopted an average of 462 laws per year [22].

According to paragraph 1 of the Decree No. 6075 of the President of the Republic of Uzbekistan “On measures to improve the business environment in the country through the introduction of a system of revision of obsolete legislation”, adopted on September 27, 2020, about 2.5 thousand old normative legal acts were identified [23].

As a statistic, we will consider how many normative legal acts were adopted from January 1, 2020 to December 31, 2020. A total of 2015 normative legal acts have been adopted, and their classification can be seen in **Table No. 1** below.

**TABLE NO. 1 [24]**

The subject of law making	Resolution	Decree	Order	Other normative legal acts
<b>Oliy Majlis (Parliament)</b>	–	–	–	60 laws
<b>The legislative chamber of Oliy Majlis</b>	449	–	–	–
<b>The Council of the legislative chamber of Oliy Majlis</b>	68	–	–	–
<b>The President of Uzbekistan</b>	303	125	20	–
<b>Cabinet of Ministers</b>	615	–	34	–
<b>Ministries</b>	57	–	–	109 orders
<b>State Committees</b>	58	–	–	–
<b>Other governmental agencies</b>	10	–	–	12 orders

In order to draw conclusions by comparing the above figures, we calculate the number of normative legal acts adopted from January 1, 2014 to December 31, 2014. A total of 2015 normative legal acts have been adopted, and their classification can be seen in **Table No. 2** below.

**Table No. 2 [25]**

The subject of law making	Resolution	Decree	Order	Other normative legal acts
<b>Oliy Majlis (Parliament)</b>	–	–	–	16 laws
<b>The legislative chamber of Oliy Majlis</b>	50	–	–	–
<b>The Council of the legislative chamber of Oliy Majlis</b>	21	–	–	–
<b>The President of Uzbekistan</b>	23	27	2	–
<b>Cabinet of Ministers</b>	165	–	34	–
<b>Ministries</b>	78	–	–	60 orders
<b>State Committees</b>	64	–	–	–
<b>Other governmental agencies</b>	16	–	–	44 orders

If we compare the two tables above, there is a significant difference in the number of acts adopted in 2014 and 2020. It should be noted that in 2020, more normative legal acts were adopted than in 2014.

We can also observe that in recent years the number of laws and decisions adopted by the Parliament and the President and other regulations has increased. For example, in 2014, the Legislative Chamber of the Oliy Majlis adopted 50 resolutions, the President 23 resolutions, 27 decrees, 2 decrees, and in 2020 the Legislative Chamber of the Oliy Majlis 449 resolutions, and the President 303 resolutions, 125 decrees, 20 orders were adopted. As can be seen, we can see that law making has increased significantly in these two subjects.

In addition, the level of adoption by the Cabinet of Ministers in 2020 increased by 3,4 times compared to 2014. The secondary law making activity of state committees and ministries, agencies has not changed dramatically. In short, in 2020, more normative legal acts were adopted than in 2014.

If we look at the last five years, a lot of normative legal acts have been adopted. We all know how these processes affect the lives of citizens. It is becoming a habit for people today to hear every day about a new law, decision and similar norms. The important task now is to ensure the implementation of the adopted laws.

If we look at law making in China, the whole process is guided by a principle that asserts that broad legislation is always better than detailed legislation [26].

First of all, in the hierarchy of each acts, it is advisable to do it from top to bottom, not from bottom to top. As all developing countries enter the stage of development, lawmaking accelerates so much that you can't count them. Today, you can directly observe this situation in our country. We will consider the confirmation of our opinion on the basis of the table shown below.

Also we conducted social research with the aid of survey. 108 people took part in the survey. The questions were answered by the respondents as follows.

1. Do you know the concept of normative inflation?

Yes – 58.3 %

No – 33.3 %

I do not know – 8.3 %

2. What do you think about normative inflation?

Good. – 19.4 %

Satisfactory. – 57.4 %

Bad. – 23.1%

3. Do you think normative inflation is necessary for the development of society?

I do not think so. – 31.5%

Definitely needed. – 24.1%

I never thought about it. – 44.4%

4. Do you think that normative inflation has been observed in Uzbekistan in recent years?

Yes, it has been increasing lately. – 38.9%

No, I did not observe it. – 26.9%

I do not know. – 34.3% [27]

It is possible to conclude that not only students but also scholars of the Tashkent State University of Law have sufficient knowledge and understanding about normative inflation and its effect on the society.

How useful is the acceleration of the law making process for the life of the society? Are the people benefiting from this process?

Logically, the speedy adoption of normative legal acts does not mean that these problems will be solved at once. In fact, the laws that are passed must be of high quality and weighty sufficient to last a long time and maintain their position.

As can be seen, more than two thousand normative legal acts were adopted in a year. At this point, let's talk a bit about speed in legislation. The rapid development of laws leads to a slowdown in the adoption of democratic laws. That is, rapid adoption affects everyone differently, because one legislative process can be slow for one and faster for another. speeding up legislation and slowing it down is a contentious debate. continuous and regular lawmaking and changing the former does not lead to the resolution of problems. As mentioned above, it affects everyone differently. The main issue here is that there must be an objective measure, for instance it depends on the law being enacted in a working and regular, long-term.

At this point, let us discuss two concepts, namely the speed of law making and the operative law making, and distinguish them a little. Moreover, when taking a closer look at the scientific debate, we find that analyses often focus on the number of bills passed, or the simple duration of their law making procedure, as a measure of legislative pace [28].

These two concepts are directly related to each other, but there are also differences. That is, the adoption of new laws on a large scale, every day or at a certain time, but in large numbers. Rapid adoption, on the other hand, can be said to be very short-lived, for example, relative to the speed that the president or MPs will adopt as the election approaches.

In the process of legal creation, new legal rules are developed and approved. At the same time, first of all, the defined tasks of the state activity are reflected in the law. Consequently, the law making is carried out by the state, regardless of the function, type, forms of exercise and organization of state power. Therefore, the rule of law is a process that involves the identification and assessment of the legal needs of society and the state, the formation and adoption of legal documents in the prescribed manner by the competent authorities.

This definition emphasizes the following important aspects: understanding, study and analysis of the situation or process that requires legal regulation, identification of the body (subject) authorized to adopt this or that legal act, selection of the form of the act to be adopted, preparation, adoption or amendment of the act. [29]

According to the Decree No. 5505 of the President of the Republic of Uzbekistan “On approval of the concept of improving the rule making activity”, adopted on August 8, 2018, by using the

model of “Smart regulation” the normative legal acts of governmental agencies should be decreased. [30]

It is also important to strengthen parliamentary control over the secondary law making activities, based on foreign experience. It is known that it is not possible to regulate all relations in the law; some issues related to its application may be regulated by secondary legislation. In these cases, it is necessary to introduce a new form of parliamentary control in the form of a study of the bylaw in terms of assessing the content of the by-law, its compliance with the goals and objectives of the law, the full implementation of the reference norm.

Today, there is a great deal of disagreement about the conflict that arises between expert scholars and members of the public between those who accelerate law making and those who advocate discussion. We can come across a lot of this in the media, on social media.

Today, the legislative process in Uzbekistan is accelerating, and we can see their speed in all areas. If you read the scientific works and articles of foreign scientists and professors, they have gone into detail about why these processes is accelerating, negative, and positive consequences.

In cases where the legislative process is accelerating, in most cases, we can observe this situation in developing countries. This is natural because states are adopting new laws to regulate all areas and to end or eliminate stagnant processes.

Of course, this process is based on the development of the state and society. But there are also downsides to this, people are dissatisfied with the fact that they do not understand the laws being passed and their implementation is not fully implemented. The general problem is that the speed of legislation in Uzbekistan does not correspond to the legal consciousness and development of society.

The purpose of passing laws is to find and solve major problems. There are a lot of normative legal acts being adopted today, the main purpose of which should be to regulate the problems that have arisen, are coming and may come. In many cases, the adopted laws do not serve to solve the problems in our society, because it is a matter of ensuring their adequate implementation. Analyzes show that we need to look at the number of bills being passed or the duration of their legislative procedures and as a means of measuring the speed of legislation.

The second question addresses another research field of Political Sciences: How does the legislative term effect legislative performance?

This is where research on the “political legislation cycle” sets in. In short, “political legislation cycle” means that the election period creates patterns of legislative action. Following the presumptions of political economy, political actors compete for constituency and align their actions accordingly [31].

## **CONCLUSION**

This, along with instability in the legislature, not only leads to a decline in the quality of the law, as in the current legislative environment, but also strengthens confidence in its power to ensure justice, promote and protect individual rights. Excessive production of laws leads to serious distortions in the application of laws, sometimes even making it impossible to apply, thus leading to an imbalance between rules and their application.



Firstly, legislative inflation leads to a significant decrease in legal certainty, which is an essential element of the rule of law. Legal certainty implies that legal provisions are readily available and predictable, as well as clear and precise.

Secondly, in conditions of legislative inflation, the addressees of legal norms are forced to assimilate the rapidly increasing volume of legal information, while adapting to its constant change. Eventually, the level of legal mind and consciousness of citizens will decrease dramatically.

Thirdly, legislative inflation can be viewed as a significant factor in erroneous lawmaking.

Fourthly, this may lead to inefficient mechanism of monitoring the execution. It is another matter that such a high pace of work will most likely lead to a weakening of control over the law enforcement process. The lack of appropriate control, in turn, turns into a haphazard “correction” of previously made law making mistakes, as a result of which previously made mistakes are not eliminated, but new ones multiply.

Fifthly, legislative inflation forms a negative image of the legislator among the population, as well as a negative attitude towards law in general.

Sixthly, due to normative inflation direct effect of laws may possibly underestimated and by law, acts will be major source of legal regulation.

Seventhly, the government should stipulate main responsible body, which regulates the state of law making inflation possibly it could be Ministry of Justice or the Constitutional Court of Uzbekistan.

## REFERENCES

1. Khayitov Sherzod Rahmatullayevich, Legal experiment: its concept, classification and role in improving norm-making. *European Journal of Molecular & Clinical Medicine*. ISSN 2515-8260 Volume 7, Issue 2, 2020. P. 701-708
2. Sodikov Akmal, Norm-making based on evidence and science is one of the main factors of development. *Review of law sciences*. 4.
3. Шахзод Алихонович Сайдуллаев, [Shaxzod Alixonovich Saydullayev] 2019/12/18. *Studia Politologiczne*. P. 52
4. Yakubov Shuhrat Ummatalievich, 2021, *Psychology and education*, 58(2), P. 1346-1352, ISSN: 00333077.
5. Ю.Г. Арзамасов [Y. Arzamasov], *Концепция мониторинга нормативных правовых актов*, 2011, М.: Юрлитинформ
6. Кучерова Т.Е. *Нормативные акты федеральных органов исполнительной власти (вопросы общей теории): Дис. ... канд. юрид. наук. – М., 2006. С. 124.*
7. Байтин М.И. *Сущность права. (Современное нормативное правопонимание на грани двух веков). Изд. 2-е, доп. – М., 2005. С. 63.*
8. Усманова Елена Фанильевна *Юридические конструкции как прием правотворческой техники // Гуманитарные, социально-экономические и общественные науки. 2015. №3-*

1. URL: <https://cyberleninka.ru/article/n/yuridicheskie-konstruktsii-kak-priem-pravotvorcheskoj-tehniki> (дата обращения: 15.03.2021).
9. Ярмонова Елена Николаевна Отличие нормотворчества от правотворчества как одна из основных проблем юриспруденции // Концепт. 2016. №S16. URL: <https://cyberleninka.ru/article/n/otlichie-normotvorchestva-ot-pravotvorchestva-kak-odna-iz-osnovnyh-problem-yurisprudentsii> (дата обращения: 15.03.2021).
10. Krasavin Aleksandr Vadimovich Problems of law-making in the area of technical regulation // Law and modern states. 2013. №6. URL: <https://cyberleninka.ru/article/n/problems-of-law-making-in-the-area-of-technical-regulation> (дата обращения: 15.03.2021).
11. Martin, L. W., & Vanberg, G. (2004). Policing the Bargain: Coalition Government and Parliamentary Scrutiny. *American Journal of Political Science*, 48(1), 13–27. Available from < <https://onlinelibrary.wiley.com/doi/abs/10.1111/j.0092-5853.2004.00053.x>>
12. Riedl, J. (2018). Time to legislate: A Database to Analyse the Temporal Dynamics of the German Legislature. In N. Edelmann, P. Parycek, G. Misuraca, P. Panagiotopoulos, Y. Charalabidis, & S. Virkar (Vol. Eds.), *Lecture Notes in Computer Science: Vol. 11021. Electronic participation: 10th IFIP WG 8.5 International Conference, ePart 2018, Krams, Austria, September 3–5, 2018, Proceedings. Vol. 11021. Lecture Notes in Computer Science: Vol. 11021. Electronic participation: 10th IFIP WG 8.5 International Conference, ePart 2018, Krams, Austria, September 3–5, 2018, Proceedings* (pp. 117–128). Cham: Springer International Publishing. Available from < [https://link.springer.com/chapter/10.1007%2F978-3-319-98578-7\\_10](https://link.springer.com/chapter/10.1007%2F978-3-319-98578-7_10)>
13. Borghetto, E. (2014). Legislative processes as sequences: Exploring temporal trajectories of Italian law-making by means of sequence analysis. *International Review of Administrative Sciences*, 80(3), 553–576. Available from < <https://journals.sagepub.com/doi/10.1177/0020852313517996>>
14. Kovats, L. (2009). Do elections set the pace? A quantitative assessment of the timing of European legislation. *Journal of European Public Policy*, 16(2), 239–255. Available from < <https://www.tandfonline.com/doi/abs/10.1080/13501760802589255>>
15. Демин А. В. Законодательная инфляция и судебный активизм как способ ее преодоления: на примереналоговых споров // Право и образование. 2016. № 2. С. 88.
16. Jasmin Riedl Uncovering legislative pace in Germany: A methodical and computational application to answer temporal questions of law-making. *Government Information Quarterly* 36 (2019) 101390. Available from < <https://reader.elsevier.com/reader/sd/pii/S0740624X19302126?token=472A0F721C43A2A604C5DD22C84CD520AE03A96B89A4BC0F009D9EE17D7FB6EE06CD3E398365FB5532FE751458E74150>>
17. [https://lex.uz/search/nat?form\\_id=3964&lang=1&status=Y](https://lex.uz/search/nat?form_id=3964&lang=1&status=Y)
18. <https://kun.uz/ru/news/2020/06/29/v-uzbekistane-primut-pyat-novyx-kodeksov>
19. Official web page of Georgetown Law Library. <https://guides.ll.georgetown.edu/c.php?g=363443&p=245528>

20. Österreichisches Parlament (2019). Parlament Aktiv: Dokumentation der Verhandlungsgegenstände. Retrieved from <https://www.parlament.gv.at/PAKT/VHG/>.
21. The authors found out the statistics by filtering the official web page (lex.uz) of National Database of Legislation of the Republic of Uzbekistan.
22. Сехин Иван Викторович Законодательная инфляция как актуальная проблема правового регулирования // Актуальные проблемы российского права. 2019. №1 (98). P. 22. URL: <https://cyberleninka.ru/article/n/zakonodatelnaya-inflyatsiya-kak-aktualnaya-problema-pravovogo-regulirovaniya> (дата обращения: 29.03.2021).
23. Қонун ҳужжатлари маълумотлари миллий базаси, 28.09.2020 й., 06/20/6075/1330-сон.
24. Lex.uz – миллий базаси 02.03.2021 йилда ҳолат бўйича.
25. Lex.uz – миллий базаси 02.03.2021 йилда ҳолат бўйича
26. Ting Xu The Legitimacy of Extralegal Property: Global Perspectives and China's Experience. The Northern Ireland legal quarterly · January 2016. Available from <[https://www.researchgate.net/publication/317952782\\_The\\_Legitimacy\\_of\\_Extralegal\\_Property\\_Global\\_Perspectives\\_and\\_China%27s\\_Experience](https://www.researchgate.net/publication/317952782_The_Legitimacy_of_Extralegal_Property_Global_Perspectives_and_China%27s_Experience)>
27. [https://docs.google.com/forms/d/1EbfmH8sdktYgS\\_gjle36s-lweOQe-dtmSOjUC-9a-04/edit#responses](https://docs.google.com/forms/d/1EbfmH8sdktYgS_gjle36s-lweOQe-dtmSOjUC-9a-04/edit#responses)
28. Bohsem, G. (2009, March 17). Demokratie im Härtetest. Süddeutsche Zeitung, 4. Borghetto, E. (2014). Legislative processes as sequences: Exploring temporal trajectories of Italian law-making by means of sequence analysis. International Review of Administrative Sciences, 80(3), 553–576.
29. Хужаназаров А. Адлия органлари фаолияти ва норма ижодкорлиги функциясини амалга ошириш таҳлили// юридик фанлар ахборотномаси –Т.: – 2020. Б.15 (13-21)
30. Сафаров Ж. Қонун ижодкорлиги: замонавий тенденциялар ва истикболдаги вазифалар// юридик фанлар ахборотномаси –Т.: – 2020. Б.194 (192-195)
31. Brechler, J., & Geršl, A. (2014). Political legislation cycles in the Czech Republic. Constitutional Political Economy, 25(2), 137–153. <https://doi.org/10.1007/s10602-013-9149-4>.
32. Пкхом Abdirakhimov. Development of effective demulsifiers on the basis of local raw materials // Universum: технические науки: научный журнал. – № 2(83). Часть [4] М., Изд. «МЦНО», 2021. DOI: 10.32743/UniTech.2021.83.2-4.36-39.

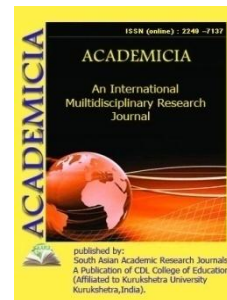
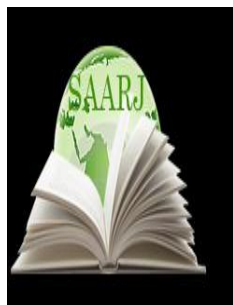

DOI: **10.5958/2249-7137.2021.01151.4**

## THE GERMINATION OF SALSOLA ORIENTALIS S. G. GMEL SEEDS IN THE CONTEXT OF CULTURE

**Baltabaev Muratbay Torebayevich\***; **Karlibaeva Miyassar Abdinasir kizi\*\***

\*Associate Professor,

Candidate of Biological sciences, Department of Botany,  
Ecology and Teaching Methods, Nukus State Pedagogical Institute named after Ajiniyaz  
Nukus, the Republic of Karakalpakstan, UZBEKISTAN

\*\*Master Student,

Nukus State Pedagogical Institute named after Ajiniyaz,  
Nukus, the Republic of Karakalpakstan,  
UZBEKISTAN

### ABSTRACT

*The article describes the study of the germination of Salsola orientalis S.G.Gmel seeds in the conditions of culture. The literature highlights laboratory germination - this is the percentage of the number of normally germinated seeds. Germination is the main indicator of the quality of the seeds, it is used to determine the yield of seeds, as well as their biological and economic significance. This plant is found in all deserts and semi-deserts of Central Asia. Along with it grow such forage plants as black saxaul, white saxaul, wormwood, salsola arbuscula, ephemera and ephemeroïds.*

**KEYWORDS:** *Laboratory Germination, Germination Of Seeds, Ground Germination, Phenological Observations, Growth And Development, Cotyledons, Hypocotyl, Real Leaves, Aboveground Part, Seed Viability, Branching, Growth, Seedlings, Seed Sowing Time.*

### INTRODUCTION

Salsola orientalis S.G.Gmel (local name – keyreuk) belongs to the family of Chenopodiaceae. Salsola orientalis (keyreuk) is a semi-shrub plant with a height of 35-55 cm. Strong branching begins at the base and forms a bush with a dense branching in the lower part. The stem and leaves are strongly pubescent. This plant is found in all deserts and semi-deserts of Central Asia. Together with them grow such forage plants as black saxaul, white saxaul, wormwood, salsola arbuscula, ephemera and ephemeroïds.

In Uzbekistan, keyreuk is widely spread in all regions and in the Republic of Karakalpakstan (figure 1).



**Figure 1. General view of *Salsola orientalis* (keyreuk)**

On the Ustyurt plateau, keyreuk grows on gypsum-saline soils and is considered the main component of various plant layers.

Keyreuk is eaten by animals in all seasons and is a good fattening feed for sheep. The eaten part of the plants is annual shoots with leaves, flowers and fruits, and often the lower parts of the bushes are woodier. Therefore, it is difficult to find plants in grazed areas that are not damaged by animals, so *Salsola orientalis* is quite suitable for hay harvesting [2].

According to M. M. Sovetkin [5], the eaten mass of *Salsola orientalis* leaves, young twigs, and fruits contains 17.4% ash, 9.7% protein, 23.7% fiber, and no alkaloids.

Keyreuk grows in various soil conditions, having a wide adaptability to a variety of edaphic and hydrological factors [3].

In the conditions of the Karakalpak part of Kyzylkum, the biology of *Salsola orientalis* in culture is almost not studied. Therefore, this is our task to identify the dynamics of growth and development of the vegetative organs of *Salsola orientalis*.

The first experiments on the study of the biology of keyreuk were conducted in 2014 at the experimental site at the department of Biology of the Karakalpak State University named after Berdakh.

It is a semi-shrubby plant, prone mainly to overgrowth on saline and gypsum soils. In 2014, it was planted in the ground with gray-brown soil on which lichens grow, using two plowing methods (using moisture-accumulating furrows and strips) [4].

## MATERIALS AND METHODS

In the field, germination varies according to seeding rates. With an increase in the seeding rate, their germination rate in the field also increases. When determining laboratory germination, all conditions are created. As for the field, the possibilities for seed growth are quite different, for example, the water regime and lighting are different from the laboratory conditions. Thus, field germination directly depends on the weather conditions in the spring, the characteristics of soil fertility, agro technical methods, physical and mechanical properties of the soil.

The formation and viability of seeds depends on several factors, in particular, on meteorological conditions.

The first experiments on the biology of *Salsola orientalis* were conducted in 2014 at the experimental site at the Department of Biology of the Karakalpak State University named after Berdakh.

In our experiments, *Salsola orientalis* S.Gmel already had a generative phase in the first year and produces full-fledged fruits. The height of the plants by the end of the growing season reaches up to 43 cm. In the conditions of the culture in the Karakalpak part of Kyzylkum, *Salsola orientalis* S.Gmel passes the entire life cycle and gives seed reproduction.

## RESULTS AND DISCUSSION

At the end of March 2014, there was a general germination of plants in the area with moisture-accumulating furrows. There were 360 plants per 100 square meters. In the first decade of April, the length of the leaves was 0.6-0.8 cm, and the width 0.3 cm. In mid-April, two true cylindrical leaves appear, the surface of which is covered with hairs. They are stored for 18-22 days, after which the remaining leaves begin to appear. In early May, the main shoot appears, and by the end of the month, the side shoots appear. By the end of June, the lower leaves turn yellow and dry up in early July.

By the end of the year, the height of plants in the area with moisture-accumulating grooves is 6.5-26.9 cm, and in the areas plowed by the method of dividing the field into strips 7.3-14.5 cm. The growing season of two-year-old keyreuk plants begins at the end of March and the first buds appear. In April, branches are formed, the best time of development begins in May and lasts until mid-June. The height of plants in fields plowed by the strip was 9.2-18.6 cm, and in areas with moisture-accumulating furrows 14.2-36.3 cm, the length of annual branches 3.2-22.3 cm [1].

The height of an adult keyreuk is 64.3-69.45 cm. In the third year, due to the drought, the height of the keyreuk did not reach the previous year's size, but there were many branches. In 1985, the height of the plant reached 30.0-49.0 cm.

**Seed germination.** The quality of the material plays an important role in increasing the feed base. The quality of the seed material includes its freshness, germination and varieties.

Laboratory germination is the percentage of the number of normally germinated seeds. Germination is the main indicator of the quality of the seed material, it is used to determine the yield of seeds, as well as their biological and economic significance.

For the experiment, plant seeds were collected from special sites.

Laboratory germination of seeds in the conditions of the Chartak hills of the Fergana region in dry years was 10% (2017) and 61.2% in 2018, and meteorological conditions had a strong impact on seed germination in the soil (table 1). According to our experiments, laboratory germination was determined at room temperature (16-18 °C) using Petri dishes, filter paper is placed in a clean Petri dish and moistened with 2-3 drops of water, then counting 100 seeds are laid out in threefold repetition. Daily observation is carried out, the seeds sprouted on the 5th day, the laboratory germination rate was 50.1%.

**TABLE 1 GERMINATION OF KEYREUK SEEDS**

	<b>% in the lab</b>	<b>% in the field</b>
2017	10	5,0
2018	61,2	29,5
2019	23,0	9,5
On average	27,7	14,5

The germination of keyreuk seeds decreases after 5 months of storage, the seeds have good germination within a month after harvesting.

**TABLE 2 GERMINATION OF KEYREUK SEEDS DEPENDING ON THE PERIOD OF STORAGE**

Storage period (month)	Germination %	
	Of seeds of 2017	Of seeds of 2018
1	10,2	61,2
2	23,0	27,0
3	19,0	23,0
4	30,0	33,0
5	15,0	18,0

As can be seen from table 2, the germination rate of seeds stored for one month decreases to 61.2%, and after 5 months to 18.0%, so it is advisable to use freshly harvested seeds when sowing. The field germination of the keyreuk was determined on a special area in the Berdakh farm, Amudarya district. To do this, in the fall, the field is plowed to a depth of 25-30 cm, and then the field is prepared for sowing, after it is loose and leveled with a rake and harrow.

On November 9 2017, the seeds were sown on an area of 5 to 15 m<sup>2</sup>, these seeds were sprouted on our experimental area. To determine the optimal time of sowing, the seeds were planted in 2 terms (table 3).

**TABLE 3 GERMINATION OF KEYREUK SEEDS IN THE CONDITIONS OF A VARIETY OF BERDAKH FARMS IN THE AMUDARYA REGION (2018)**

	Germination of seeds
--	----------------------

Sowing date	The number of sprouts on an area of 1m <sup>2</sup>	The number of planted seeds
9.XI.2018	30	30
2.III.2019	7	7

As can be seen from table 3, the seeds planted in November gave good germination. In contrast to this, the seeds planted in the spring sprang up poorly, because the seeds have to go through a dormant period during the long wintertime.

Consequently, it will be advisable to plant the keyreuk in October and November. In the conditions of the Fergana region, the degree of germination of the keyreuk plant is much higher than in our conditions.

In the field, germination varies according to seeding rates. With an increase in the seeding rate, their germination rate in the field also increases. The reason for the low level of germination in the field compared to the indicators of laboratory germination is a sharp change in the conditions for seed growth. When determining laboratory germination, all conditions are considered. In contrast to this, in the field, the possibilities for seed growth are quite different, for example, the water regime and lighting are different from the laboratory conditions. In the field, after the seeds germinate, sprouts should appear on the ground surface. For this reason, unlike in the laboratory, field germination is very difficult to predict. As a result, field germination directly depends on the weather conditions in the spring, the characteristics of soil fertility, agro technical methods, physical and mechanical properties of the soil.

#### REFERENCE LIST:

1. Baltabaev M.T., Karlibaeva M. Growth and development of orientalis L. in the conditions of the Southern Aral Sea region. Scientific and Methodological Journal "Problems of Modern Science and Education" 2017 №17 (99), ed. "Problems of Science" Moscow. p. 20-22
2. Erejepov S., Baltabaev M. Ecological and biological features of *Salsola orientalis* S.Gmel (Keyreuk) in the conditions of the North-Western Kyzylkum.// In ed. Some questions of enrichment of natural pastures of the Karakalpak part of Kyzylkum. Nukus, 1983. p.17-18
3. Mamasaliev I. Botanical characteristics and economic significance of keyreuk. Keyreuk (*Salsola orientalis* SS Gmel) and its variability in Uzbekistan. - Thesis of the PhD dissertation - Tashkent, 1970 p. 20
4. Tajimuratov P. Ecological and biological features and productivity of plants in experiments on phyto melioration of pastures of the Karakalpak Ustyurt. - Thesis of the PhD dissertation – Tashkent, 1981 p. 29
5. Sovetkina M.M. Pastures and hayfields of Central Asia Tashkent, UzState Ed. 1938





**ACADEMICIA**  
**An International  
 Multidisciplinary  
 Research Journal**  
 (Double Blind Refereed & Peer Reviewed Journal)



**DOI: 10.5958/2249-7137.2021.01142.3**

## IMPROVING THE METHODS OF DEVELOPING THINKING ABILITY OF PRIMARY SCHOOL STUDENTS IN MATHEMATICS

**Shabnam Yusufzoda\*; Sitora Ortiqova\*\***

\*Teacher,

Department of Primary Education Methods,  
 Bukhara State University, Bukhara,  
 UZBEKISTAN

Email id: shabnamyusufzoda@gmail.com

\*\*Stage 2 Students,

Bukhara State University, Bukhara, UZBEKISTAN

---

### ABSTRACT

*This article discusses ways to develop students' thinking skills in primary school, ways to explain how to solve initial problems, and effective methods. The first problem on the picture is created by the teacher. He teaches children to look at the pictures, to distinguish the given numbers and the life actions that led to the change of quantitative relations.*

**KEYWORDS:** *Problem, Simple Problem, Complex Problem, Arithmetic Operations, Staged, Visual, Ability, Method.*

---

### INTRODUCTION

Various issues play an important role in the development of thinking skills of primary school students in mathematics. We will discuss some of these types below.

Staged issues. Great attention is paid to staged issues. These issues reflect the actions of children, often directly observed. Instead of answering the question here, these given numbers can be seen on a visual basis. First graders often do not know how to solve a problem because they do not understand the meaning of the words that describe this or that action (spent, shared, donated, etc.). Therefore, in school, in the preparatory group, special attention should be paid to the meaning of the words that express this or that action. To this end, it is necessary to take into account what practical actions should be taken at the heart of the matter. In this case, it is expedient to compare the issues of finding the sum and the remainder, which implies the

opposite action: coming and going, coming and going, moving, buying and selling, bringing and taking, flying.

Demonstration issues. First, the children are told about the content of the topic, and are shown pictures depicting the given numbers. The first problem on the picture is created by the teacher. He teaches children to look at the pictures, to distinguish the given numbers and the life actions that led to the change of quantitative relations. For example, the picture shows a boy holding 5 balloons, he gives 1 balloon to a girl. Looking at the picture, the teacher: What is depicted here? What is the child holding? How many balls does it have?

What is he doing? What do we know? Create the condition of the matter. What can I ask about? he asks. By changing the numbers, the teacher encourages the children to create a problem based on a picture of any content that they use to teach them to think and tell stories about finding sums and residues of different content on the same topic.

## II. MATERIALS AND METHODS

Mathematical problems are divided into simple and complex problems. Problems that can be solved in one operation are called simple problems. Problems that are composed of several simple problems and therefore can be solved using two or more operations are called complex problems.

For example: there were 6 birds on a tree branch. 2 of them flew away? There are 2 inverse problems to this problem.

- 1) There were several birds on a tree branch. After 2 birds flew away, 4 birds remained on the tree branch. How many birds are left on the tree branch?
- 2) There were 6 birds perched on a tree branch, and after a few birds flew away, 2 birds remained. How many birds flew?

A simple problem is distinguished from a simple problem.

Issue 1. There are 8 apples in one box, which is 5 more than the second box.

How many apples are in the second box?

Solution:  $8 - 5 = 3$  (apples)

Answer: There are 3 apples in the second box.

Issue 2. Vali drew 6 rabbits. Vali's drawings are 2 more than Zokir's drawings. How many rabbits did Zokir draw?

Solution:  $6 - 2 = 4$ .

Answer: Zokir drew 4 rabbits.

Summation and remainder problems from simple problems.

Problem 3. Ahmad drew 3 dolls and two balls. How many toys did Ahmad draw?

Solution:  $3 + 2 = 5$ .

Answer: Ahmad drew 5 toy pictures.

Issue 4. Zokir took 7 apples from an apple tree and had 3 of them. How many apples are left in Zokir?

Solution:  $7 - 3 = 4$  (apples).

Answer: There are 4 apples left in Zakir.

Problem 5 There were 4 red pencils on the table and 4 blue pencils were added to it. How many pencils were on the table:

Solution:  $4 + 4 = 8$

Answer: There were 8 pencils on the table.

Another type of simple problem is how many units increase or decrease a number.

1. Ahmad has 6 pens and Salim has 2 more. How many pens does Salim have?

Solution:  $6 + 2 = 8$  (pens)

Answer: Salim has 8 pencils.

2. Salim drew 4 red cars and Ahmad drew 3 green cars. How many cars did the two draw?

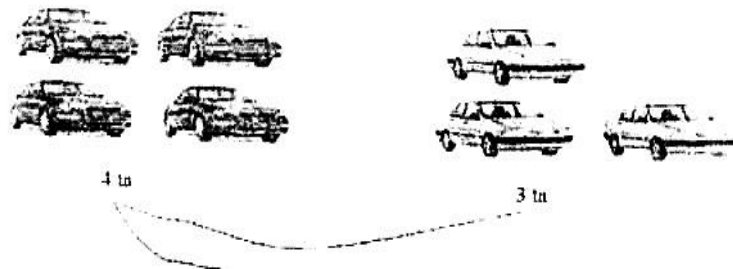

Solution:  $4 + 3 = 7$  pieces.

Answer: Both drew 7 car pictures.

2. Vali drew 5 carrot pictures and Nadir drew 3 carrot pictures. How many carrots did the two draw?



Solution:  $5 + 3 = 8$  pieces.

Answer: Both drew 8 carrot pictures.

### III. CONCLUSION

The terms of simple problems should be clear to children, and residual finding problems are part of such a set of questions. By solving simple problems, one of the basic concepts of an elementary course in mathematics is the concept of arithmetic operations, and a number of other concepts. Once they have mastered the ability to solve simple problems, they learn to solve complex problems. Because complex problems consist of several simple problems.

Masala. There were 2 green and 3 red apples on the plate. After eating 2 red apples. How many apples are left on the plate?

Solution:  $3 + 2 = 5$  (pieces)

$5 - 2 = 3$  apples.

Answer: There are 3 apples left on the plate.

2. Karim has 3 pens and Sabir has 6 more. How many pens does the patient have? Karimda - 3 Patience -? -More than 6.



Solution: 3  
(pencil)

$+ 6 = 9$

Answer: Patience has 6 pencils.

3. Elyor cut 7 watermelons from the melon. Nadir cut 3 watermelons from the melon. How many watermelons did the two cut?



Solution:  $7 + 3 = 10$  (watermelon).

Answer: Both cut 10 watermelons.

**REFERENCES:**

- 1) Yunus Y. S. Methodology Of Teaching Assignments To Work With Non-Standard Solution In Primary School Mathematics Education //The American Journal of Social Science and Education Innovations. – 2021. – Т. 3. – №. 02. – С. 439-446.
- 2) Косимов Ф. М., Ярашов М. Ж. ТВОРЧЕСКИЕ САМОСТОЯТЕЛЬНЫЕ РАБОТЫ НА УРОКАХ МАТЕМАТИКИ В НАЧАЛЬНЫХ КЛАССАХ //ИННОВАЦИОННЫЙ ПОТЕНЦИАЛ РАЗВИТИЯ НАУКИ В СОВРЕМЕННОМ МИРЕ: ДОСТИЖЕНИЯ И ИННОВАЦИИ. – 2020. – С. 178-181.
- 3) Саидова Г. Э. Ситуация свободного выбора на уроках математики в начальных классах //Вестник науки и образования. – 2019. – №. 7-3 (61).
- 4) Xoliqulovich J. R. Toponymics-a Linguistic Phenomenon in The Work of Sadridin Aini //Middle European Scientific Bulletin. – 2021. – Т. 8.
- 5) Raximqulovich, Ismatov Sobirjon; ,METHODS OF WORKING WITH TEXT IN LITERARY READING LESSONS IN ELEMENTARY SCHOOL,EPRA International Journal of Multidisciplinary Research,1,,345-347,2020,EPRA Publishing
- 6) Rustamova G. B. THE INTERPRETATION OF THE WILLOW IMAGE IN UZBEK FOLKLORE //ЛУЧШАЯ НАУЧНАЯ СТАТЬЯ 2020. – 2020. – С. 53-57.
- 7) YARASHOV M. BOSHLANG ‘ICH SINF МАТЕМАТИКА ТА’LIMINI IJODIY TASHKIL ETISHDA TA’LIM TAMOYILLARINING O ‘RNI //ЦЕНТР НАУЧНЫХ ПУБЛИКАЦИЙ. – 2020. – Т. 1. – №. 1.
- 8) YUSUFZODA S. O‘QUVCHI MANTIQIY TAFAKKURINI SHAKLLANTIRISH OMILLARI //ЦЕНТР НАУЧНЫХ ПУБЛИКАЦИЙ. – 2020. – Т. 1. – №. 1.
- 9) Olloqova M. O. Intensive education and linguistic competence in mother tongue //ACADEMICIA: AN INTERNATIONAL MULTIDISCIPLINARY RESEARCH JOURNAL. – 2021. – Т. 11. – №. 1. – С. 580-587.
- 10) Хамраев А. Моделирование деятельности учителя при проектировании творческой деятельности учащихся //Педагогічні інновації: ідеї, реалії, перспективи. – 2018. – №. 2. – С. 23-26.
- 11) Yusufzoda, Shabnam. "Organization of independent work of students in mathematics." Bridge to science: research works. 2019.
- 12) ogli, Yarashov Mardon Jobir; ,THE IMPORTANCE OF USING DIGITAL TECHNOLOGY IN PRIMARY SCHOOL MATHEMATICS EDUCATION,ACADEMICIA,1,11,5,2021,ACADEMICIA: An International Multidisciplinary Research Journal
- 13) Yunus Y. S. DEVELOPMENT OF LOGICAL THINKING IN MATHEMATICS LESSONS AS THE BASIS FOR IMPROVING THE QUALITY OF THE EDUCATIONAL PROCESS.
- 14) Yunus Y. S. et al. Use of innovative technologies in improving the efficiency of primary school students //Middle European Scientific Bulletin. – 2021. – Т. 11. – №. 1.

- 15) YUSUFZODA S. O‘QUVCHI MANTIQIY TAFAKKURINI SHAKLLANTIRISH OMILLARI //ЦЕНТР НАУЧНЫХ ПУБЛИКАЦИЙ. – 2020. – Т. 1. – №. 1.**
- 16) Yunus Y. S. Features of Logical Thinking of Junior Schoolchildren //Middle European Scientific Bulletin. – 2021. – Т. 10. – №. 1**



**ACADEMICIA**  
**An International**  
**Multidisciplinary**  
**Research Journal**  
 (Double Blind Refereed & Peer Reviewed Journal)



**DOI: 10.5958/2249-7137.2021.01162.9**

## ABDUNAZAR POYONOV VERSION EPIC OF THE ALPOMISH

**Jumagulova Dilafuz Xushmurotqizi\***

\*2nd Year Student,  
 Language and Literature named after Alisher Navoi,  
 Tashkent State University of Uzbek UZBEKISTAN  
 Email id: dilafuzjumagulova@gmail.com

### ABSTRACT

*Folklore is a reflection of the worldview, knowledge, spirituality and glorious past of all nations. Among them, the epic genre in particular stands out for its complexity and perfection, its unique features. This article compares the variants of the epic "Alpomish", a masterpiece of the history of the Uzbek people, with the version written by AbdunazarBakhshiPoyonov, and highlights their similarities and differences.*

**KEYWORDS:** "Alpomish", Kungrad, Shahimardonpir, Childless Motif, Alp.

### INTRODUCTION

Samples of folklore, including epics, have been recorded and studied since the first half of the twentieth century. As a first step, G'ozim Olim Yunusov's services in this area are considered effective. He was one of the first to write the epic "Alpomish", the heroic epic of the Uzbek people, from his son FozilYo'ldosh, and made it known to scholars with some abbreviations. Later, Hodi Zarif, Mansur Afzalov, Muzayyana Alaviya, To'ra Mirzayev and a number of other folklorists from different regions of our people, FozilYo'ldoshog'li, ErgashJumanbulbulo'g'li, IslomShoir, MardonaqulAvliyoqulo'g'li, Samples of epics from poets such as Umir were written and studied scientifically. As a result, more than forty versions of the epic "Alpomish" became known to scientists, and the second, in written form, began to live. Recording of epics continued during the years of independence. One of them is recorded by f.f.d. JabborEshonqulov from AbdunazarPoyonov, a representative of the South Uzbek School of Epic.

### MATERIALS AND METHODS

Today, when we study the variants of the epic, the version of FozilYo'ldoshog'li, a representative of the Bulungur School of Epic, as the most perfect and classic version has been noted and republished by scholars. However, it should be noted that each of the variants of the

epic has its own characteristics, artistic value and great scientific significance. In particular, the version of AbdunazarPoyonov is noteworthy for the fact that it is still alive today, and at the same time recorded, published and won wide public recognition.

Along with most folk epics, the epic "Alpomish" consists of an introductory, main and concluding parts. The beginning will feature the birth of the protagonists, an epic depiction of space and time, as well as knots to untie as events unfold. In the main part, it is the process of removing those nodes, the obstacles in the way. In the end, the knots are untied and the heroes achieve their goals. All versions of the epic "Alpomish" are based on this plot. Only in expression, in the objects of the image, they differ from each other.

"Evaluate the beginning, not the end," says the Kazakh poet Abay. As we think about the epic Alpomish, we want to make a comparative study of how its beginnings unfold. In this regard, we analyzed the most popular versions of the epic FozilYo'ldosho'g'li and AbdunazarPoyonov, a representative of the School of Epic of South Uzbekistan.

The beginning of the epic genre begins, first of all, with the homeland of the heroes and their description. This is reflected in the version of FozilYo'ldosh: "In the past, sixteen tribes were called Dobonbiy in Kungrad. Dobonbi gave birth to a son, Alpinbi. Alpinbi had two more sons: the eldest was named Boybori and the youngest was named Boysari. Boybori and Boysari - both grew up. Boysari was rich and Boybori was rich, and they both had no children"<sup>1</sup>. No words in the story, especially in the beginning, are used for surfing. The very beginning introduces the listener to the epic reality of the epic.

The word "former" is used in reference to a past event. Bakhshi uses this word to indicate that the events of the epic took place in the past. JabborEshonqulov, a doctor of philology, "The past tense" as "the transformation of chaos into space." "... This is a pure, artistic history of any nation, free of numbers." The use of the word "sixteen seeds" is further proof of the historical truth.

## RESULT AND DISCUSSION

The Uzbek people have long been engaged in agriculture and animal husbandry, spread over a large area. According to some sources, this nation is 92, and according to some sources, it is 96 tribes. The bells mentioned in the epic are 16 tribes, which have a worthy place in the history of the statehood of the Uzbek people. The names of the trees in the poem are not only numerous, but also express the traditions of the people in governing the country, the cream of their knowledge. The people consider him to be a perfect man in every way. The epic says that people like Dobonbiy and Alpinbiy ruled the state. It is important to note that each name in the story is used to express a specific meaning. The name Dobonbi is used at the beginning of the epic and seems to be forgotten later. But Dobonbi is an important figure for the bell tribe. The word dobanbi is used in the dictionary to mean "a great work that leads to success."<sup>2</sup> The word "biy" is also a modified form of the word "bek" and refers to a person's social status. The word biy is also added to nouns in Khorezm dialect. Dobonbi is also mentioned in the bell tribe as a bek who did great things at the beginning of the statehood.

The second name is Alpinbi. The word alpine is used in the dictionary to mean "a hero of supernatural strength and courage."<sup>3</sup> The epic also mentions that the bright bow, which was the first of the fourteen batmans, was left by Alpinbi. The birth of an alpine, like an alpine, did not



happen by itself. It was because of Dobonbi's hard work and wisdom.

Boysari and Boybori are the sons of Alpinbi. The very word "rich" in their name indicates their ancestry. The birth of Alpomish, the protagonist of the epic, also indicates that he was not of ordinary people, but of Alpine descent.

It is no coincidence that Alpomish was originally called Hakimbek and later became known as Alp. The word "judge" means "wise." The fact that being an alpine requires not only strength but also wisdom is evident in the events of the epic.

The beginning of the epic is described in more detail in the version of AbdunazarPoyonov, a representative of the Sherabad School of Poetry. In this epic, which begins, "In the past, on the side of the bell," the bell is used as a place name, not a seed. The location of this area is also known. It is said that "from Alatag to Narmon, from Kokcha to Berman", that is, in a beautiful place between two mountains. The number of seeds in the Kuriroiroa tribe is sixty-six. The fact that Alpomish is mentioned in the poem as a representative of nineteen generations is found in the works of the South Uzbek School of Epic. AbdunazarPoyonov's version lists seven generations of heroes. These are: Doltanbiy, Arkonbiy, Orkanbiy, Dobonbiy, Alpinbiy, Boybori, Alpomish, Yodgor<sup>4</sup>.

All versions of the epic "Alpomish" contain the infertility and birth motives of Boybori and Boysari, and are analyzed differently in different versions. In FozilYo'ldosh, for example, the influence of Islam is noticeable. The two brothers' lack of respect at the wedding and their humiliation by the rich are highlighted by their childless motives. Two brothers are waiting for help from ShahimardonPir, who wants children. "From here, the window of ShahimardonPir comes for three days, and everyone goes to bed: the state demands the state, the child demands the child, the hereafter demands the faith, and the person who spends forty days returns to his destination. If we go, if we give our necessities, if we go to the window of ShahimardonPir, if we also want a child<sup>5</sup>.

The role of the Pirs in the life of Alpomish, the protagonist who was associated with the Pirs from birth, can be seen from the very beginning of the saga. In our opinion, the owner of the ravza, Shahimardon, who wanted two brothers and children, was one of the forty chiltons. According to religious beliefs, Chilton is one of 40 legendary spirits with supernatural powers. In the wisdom of Ahmad Yassaviy, it is said that the Chiltons are forty bodies, that is, forty people. These forty have the power of sainthood and act on God's command to solve the world's problems. The dead will be replaced by the living.<sup>6</sup> Doctor of Philology, Professor ShomirzaTurdimov calls chiltonseran and considers erans to be the cause of the alpine system embedded in the whole epic plot of Alpomish. The scholar notes that in the epic, the patron saint portrays one of his partners as a companion to the hero<sup>7</sup>. The naming of children at birth, the leaving of five claws on Hakimbek's shoulders, the removal of Boychibor's smiles, and so on, all testify to the constant support of the hero Alpomish by ShahimardonPir, one of the chiltons (patron erans).

In AbdunazarPoyonov's version, the motive of infertility is described as popular and convincing. Boybori and Boysari are not told that someone is childless, but after the captain's party at the wedding, people point to their brothers and whisper to each other: "... people push each other, whispering, pointing to Boybori and Boysari, "The centurion told the truth, what is there at a wedding without a man's lamp, fruit, children, sons and daughters? The wedding is at the

wedding, the sarpo, the wedding is back. How will the brothers return to Boybori and Boysari? If they don't have children, if they don't get married, the wedding they brought will be a doomsday debt for Togonbi, how will he repay it? The throne, the happiness, the possessions will be gone in a day. Who will reach the bottom of this world? ”- he whispers<sup>8</sup>.

The brothers' grief for the child was not only after this wedding, but was already there, and at the wedding it was even more: The young men lined up, their hearts were broken, and the old man, who was sitting, understood the gestures of the people, and his heart was broken, and his hopes were shattered.<sup>9</sup>

## CONCLUSION

AbdunazarPoyonov's version, like FozilYo'ldosh's version, is motivated by devotion to ShahimardonPir and asking for a child. But in contrast, there is a hunting motive associated with totemistic views. As a result of Boysari's failure to shoot the mother deer and her six cubs in the hunt, the mother deer pleads: “This man has climbed the mountains, he has a dream, he has mercy on my child, O Lord who created him, give him his intention, have mercy on him. Be kind, fill in the gaps”<sup>10</sup>. That is why the prayer is given to the brothers and sisters: “You did the right thing, God gave it to us. If you have mercy on the mother deer, may God have mercy on us, too.”The brothers slept that night, walking in the mountains. In the night, the grandfather of the saint appeared in a dream and said: May your children multiply and grow, amin.”<sup>11</sup>

It is known that in 1999 the 1000th anniversary of Alpomish was widely celebrated in our country. The story may have been written earlier. If we consider that the places related to ShahimardonPir in the epic originated after Islam, the aspects related to hunting can be understood as pre-Islamic views.

The childlessness of the parents before the birth of the Alpine hero is in fact symbolic, and it is about the birth of a new generation, the Alps, who will strengthen the kingdom and reunite the scattered people.

Among the variants of the epic "Alpomish", the version of AbdunazarPoyonov differs from other variants, including the version of FozilYo'ldosh, with the details of the plot and the details of the events, with new interpretations. The size of this option also proves our point. AbdunazarPoyonov's manuscript is more than 600 pages long. In this version, the poetic verses are 14,230 verses. In addition to hearing from his teachers, Bakhshi also read and studied epics. In the version of AbdunazarPoyonov, the individual skill of the bakhshi, his unique interpretation of a number of motives demonstrates his creativity and mastery.

## REFERENCES:

1. Alpomish. The narrator is AbdunazarPoyonov. Tashkent .: Akademnashr, 2018
2. Ahmad Yassavi. Devonian wisdom. Tashkent: GafurGulam Publishing and Printing Association, 1992
3. Folklore is the eternal history of the nation. JabborEshanqul, “Yoshlar”, 2014.
4. Genesis and evolutionary stages of "Gorogly" epics. Tashkent .: Fan Publishing House, 2011
5. Monuments of Uzbek folk art. 100 vols., 1 vol. Alpomish. The narrator is the son of FozilYo'ldash. Tashkent .: GafurGulam Publishing House, 2015.

6. Explanatory history of the Uzbek language. Tashkent .: National Encyclopedia of Uzbekistan Publishing House, 2020.
7. PkhomAbdirakhimov. Development of effective demulsifiers on the basis of local raw materials // Universum: техничекиенауки: научныйжурнал. – № 2(83). Часть [4] М.,Изд. «МЦНО», 2021. DOI: 10.32743/UniTech.2021.83.2-4.36-39

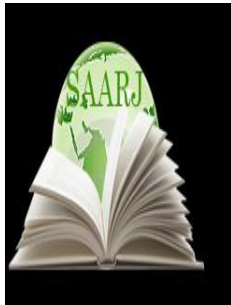

**ACADEMICIA**  
**An International**  
**Multidisciplinary**  
**Research Journal**  
 (Double Blind Refereed & Peer Reviewed Journal)



**DOI: 10.5958/2249-7137.2021.01263.5**

**ANALYSIS OF THE DROPOUT TREND IN GOVERNMENT GIRLS  
 PRIMARY SCHOOLS IN DISTRICT MARDAN (PAKISTAN)**

**Dr. Syed Wajid Ali Shah\*<sup>\*</sup>; Syed Muhammad Amir\*\*<sup>\*\*</sup>; Dr. Raisat Ali\*\*\*<sup>\*\*\*</sup>;  
 Dr. Sajjad Hayat Akhtar\*\*\*\*<sup>\*\*\*\*</sup>**

\*Assistant Professor,  
 Abdul Wali Khan University,  
 Mardan PAKISTAN  
 Email: syedwajid15@yahoo.com

\*\*Student of M.Sc, Rural Development,  
 Institute of Development Studies,  
 Khyber Pakhtunkhwa Agricultural University Peshawar,  
 PAKISTAN  
 Email id: amirrd876@gmail.com

\*\*\*Chairman Department of Education,  
 Abdul Wali Khan University,  
 Mardan, PAKISTAN  
 Email id: dr\_raisatali@yahoo.com

\*\*\*\*Mohallah Shamgunj Mardan,  
 PAKISTAN  
 Email id: akhtarsajjad@yahoo.com

**ABSTRACT**

*In this paper the dropout trend in Government Girls Primary Schools in District Mardan was analyzed through a descriptive research study. This study has investigated the class wise trend of dropout in Government Girls Primary Schools in District Mardan, analyzed the reasons of the dropout trend and determined a strategy for minimizing the dropout trend. The research was conducted by using systems analysis as theoretical framework of this study. Population for the study consisted of all the 10324 dropouts. A stratified random sample of 300 dropouts was drawn out of total population. Survey and questionnaires were used as tools for collecting data. Data regarding enrolment, dropouts and dropout rate was collected through survey. The researcher*

*administered a self assessment Questionnaire on sampled dropouts to gather their perceptions regarding the dropout phenomenon in Government Girls Primary Schools in District Mardan. The study found the highest dropout rate(15.98%) in Kachhi which gradually falls down in class 2. But in class 3 it jumps to(8.64%) and then it keeps on increasing up to class 5. The perceptual analysis of the responses of the Questionnaires revealed that the factors were divided into three main categories i.e. the institutional problems and procedures: including; frequent failure in classes, unpleasant teaching learning processes, high level of difficulty of courses, harsh behavior of teachers and insecurity in schools; Home based factors: including; high poverty level of the parents, frequent migration of their families, and community factors such as Lack of immediate returns of schooling. The study recommended: Teachers' training focused on enhancing teachers' competency to retain students in schools; introducing academic monitoring system; adopting strategies for reducing absenteeism of students; Mass mobilization of parents towards schooling of their kids; provision of stipends; special schooling arrangements for migrating families and introduction of individualized teaching strategies for slow learners.*

**KEYWORDS:** *Enrolment, Competency, Unpleasant*

## **INTRODUCTION**

One of the major problem of primary education is that a considerable number of students dropout without completing their schooling. In Pakistan the participation rate in primary education is 50% to 60% and the dropout rate is estimated at 48 %.( Pakistan academy of educational planning and management, 1985). This phenomenon results in educational wastage. Dropping-out is undesirable because it indicates wastage of resources allocated to education sector and it also indicates the poor internal efficiency of that particular educational institution. Ajayi and Ayodele (2002) are of the view that the primary education is a key to success. So the researcher launched study to find out the causes of dropout.

## **LITERATURE REVIEW**

Wastage is a burning issue of the system of education. Wastage has been defined by salami as degree to which the human and material resources developed and made available are grossly under utilized or neglected. To Wijk T.V.(1983, p.432) pointed out that dropping-out is complete but also partial withdrawal, interruption as well as cessation. More often the students leave school due to their personal problems rather than academic, over which the institution has little control. Inadequacies of the education system to retain pupils until the completion of the educational levels is one out of the five major components of wastage in education system. (Brumer and Paul, 1971) According to Hewyood J.A. (1971, p. 190) "students wastage" provides two indications; the inefficiency of an education process and the individual's reaction to the process. Ayodele (2000) determined relatively higher wastage rates in lower classes of primary schools. However, these wastage rates decreases in upper classes. The study of Reis, New and MC Guire, (1997) has found that in a number of cases, the severity of learning disability decreases as adolescents mature into adults. Reiff et al : Sitloington and Frauh (1990) found that the severe learning disability has influenced the dropout phenomenon.

Rumberger (1987) has found that a number of factors strongly correlate with dropping out. Some of these factors remain constant, such as socioeconomic and racial minority status. Other factors are amendable to interventions, e.g. absenteeism, course failure and peer influences. Factors that push students out are repeating grades, low academic achievement and insufficient teachers care.

### OBJECTIVES OF THE STUDY

Objectives of the study were to:

1. Investigate the class wise trend of dropout rate in Government Girls Primary Schools in District Mardan in the academic year 2005-06.
2. Analyse the reasons of the dropout trend in Government Girls Primary Schools in District Mardan.
3. Determine a strategy for minimizing the dropout trend.

### METHOD

It was a descriptive study. Systems analysis was used as the theory basis of this study, using the adaptation of Coombs-Zwaenepoel Systems Model as a framework. Data was collected through survey and questionnaires. The school records were surveyed to find out enrollment & wastage situation. The researcher administered a self assessment questionnaire on sampled dropouts to gather their perceptions regarding the causes of their dropping out. For demographic profile, percentages, mean and standard deviation were used. Population for the study consisted of all the 10324 dropouts. A stratified random sample of 300 dropouts was drawn out of total population. A separate interview protocols was designed to verify and supplement the data gathered from dropout and to identify what students bring to school, how they studied, and their reasons for dropout.

### PRESENTATION AND ANALYSIS OF DATA

**TABLE 1 ENROLLMENT & WASTAGE SITUATION IN THE ACADEMIC YEAR 2005-06**

	Kachhi	Pakki	Class 2	Class 3	Class 4	Class 5
Enrollment	25038	19886	15734	13824	10094	9637
Dropouts	4001	1561	1222	1194	1096	1250
Dropout rate(%)	15.98	7.85	7.77	8.64	10.86	12.97

**Result:** Table 1 shows the highest dropout rate (15.98%) in Kachhi which gradually falls up to class 2. But in class 3 it jumps to (8.64%) and then it keeps on increasing up to class

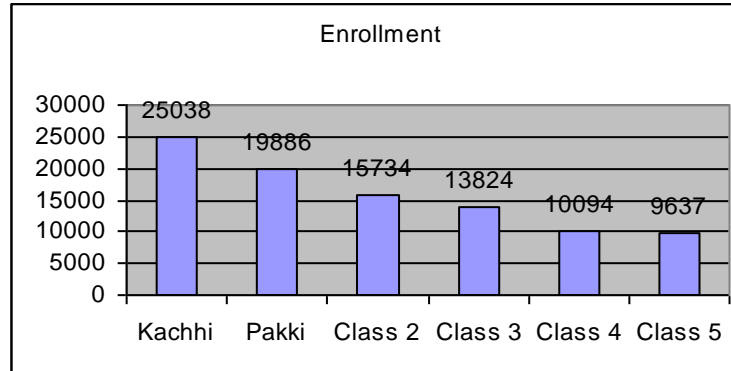

Figure No.1 shows decreasing trend in enrolments from Kachhi up to class 5.

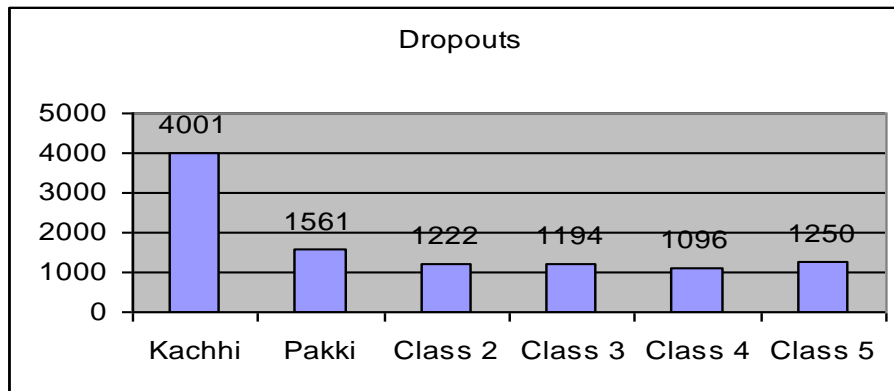

Figure No.2 shows the number of dropouts.

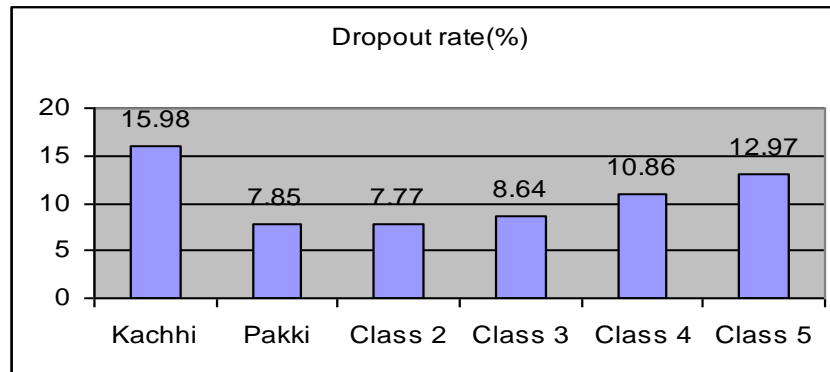

Figure No.3 shows dropout rates in percentages.

**TABLE2 PERCEPTIONS OF DROP OUTS REGARDING THE CAUSES OF THEIR DROPPING OUT**

S.No.	Statement	Yes	TSE	No	Mean	S D
1	High poverty level was the cause of your dropout.	212 (70.7%)	27 (9%)	61 (20.3%)	1.4967	.81170
2	Lack of transport facilities was the cause of your dropout.	55 (18.3%)	34 (11.3%)	211 (70.3%)	2.52	.78634
3	Frequent migration of your family in	177	20	103	1.7533	.93563

	search of a livelihood resulted in your dropout.	(59.0%)	(6.7%)	(34.3%)		
4	You need to assist your mother in house hold activities.	101 (33.7%)	15 (5.0%)	184 (61.3%)	2.2767	.93615
5	Frequent absenteeism of teachers caused you me to leave schooling.	119 (39.7%)	66 (22.0%)	115 (38.3%)	1.9867	.88455
6	Lack of parental interest in your schooling was the cause of your dropout	115 (38.3%)	88 (29.0%)	97 (32.7%)	1.9433	.84211
7	Lack of immediate returns of schooling was the reason of your drop out.	164 (54.7%)	57 (19.0%)	79 (26.3%)	1.7167	.85567
8	Frequent failure in classes compelled you to dropout.	211 (70.3%)	43 (14.3%)	46 (15.3%)	1.4500	.74567
9	Courses were quite difficult.	198 (66.0%)	27 (9.0%)	75 (25.0%)	1.5900	.86278
10	Teaching learning process was quite unpleasant.	201 (67.0%)	42 (14.0%)	57 (19.0%)	1.5200	.79480
11	Teachers' harsh behavior in classes compelled you to leave schooling.	178 (59.3%)	34 (11.3%)	88 (29.3%)	1.7000	.89405
12	Remote school was the reason of your drop out.	101 (33.7%)	9 (33.7%)	190 (63.3%)	2.2967	.94071
13	You left school due to your illness.	166 (55.3%)	61 (20.33%)	73 (24.3%)	1.6900	.83840
14	Tight school discipline was the reason of your dropout.	98 (32.7%)	68 (22.67%)	134 (44.7%)	2.1200	.87262
15	Poor building and material facilities in the school were the reason of your drop out.	118 (39.3%)	72 (24%)	110 (36.7%)	1.9733	.87283
16	You feel insecure in school.	158 (52.7%)	37 (12.33%)	105 (35.0%)	1.8233	.92102

Table 2 shows the The highest ranked statements were No.1“High poverty level was the cause of your dropout.” with a mean (1.4967) and standard deviation (.81170) and No.8 “Frequent failure in classes compelled you to dropout.” with a mean (1.4500) and standard deviation (.74567). While the lowest ranked statement was No.2 was “Lack of transport facilities was the cause of your dropout” with a mean (2.52) and standard deviation (.78634).

**Results:** the highest dropout rate(15.98%) in Kachhi and it gradually falls from Kachhi to class 2.but class 3 it jumps to(8.64%) then it keeps on increasing from class 3 to class 5.

70.7% respondents perceived that high poverty level of the parents compels students to leave schooling, with a mean, (1.4967) and standard deviation (.81170).

70.3% respondents perceived that frequent failure in classes compelled them to dropout, with a mean, (1.4500) and standard deviation (.74567).



67.0% respondents perceived that they left school because the teaching learning process was quite unpleasant, with a mean, (1.5200) and standard deviation ( .79480).

67.0% respondents perceived that they left school because the teaching learning process was quite unpleasant, with a mean, (1.5200) and standard deviation ( .79480).

66.0% respondents perceived that courses were quite difficult, with a mean, (1.5900) and standard deviation (.86278).

59.3% respondents perceived that teachers' harsh behavior in classes compelled them to leave schooling, with a mean, (1.7000) and standard deviation (.89405).

59.0% respondents perceived that frequent migration of their families in search of a livelihood resulted in their ultimate dropout. 11 on of dropout with a mean, (1.7533) and standard deviation (.93563).

55.3% respondents perceived that they left school due to their illness. 7 I left school due to my illness was found at rank 2 as a reason of dropout with a mean, (1.6900) and standard deviation(.83840).

54.7% respondents perceived that Lack of immediate returns of schooling was the reason of your drop out. The study found at rank 1that the Lack of immediate returns of schooling motivated students to dropout with a mean. (1.7167) and standard deviation (.84211).

52.7% respondents perceived that they feel insecure in school, with a mean, (1.8233) and standard deviation (.92102).

Table 1 shows the highest dropout rate(15.98%) in Kachhi and it gradually falls from Kachhi to class 2.but class 3 it jumps to(8.64%) then it keeps on increasing from class 3 to class 5.

## FINDINGS/RESULTS

### Findings

The study determined that the highest dropout rate(15.98%) in Kachhi and it gradually falls from Kachhi to class 2.However in class 3 it jumps to(8.64%) and then it keeps on increasing from class 3 to class 5.

70.7% respondents perceived that high poverty level of the parents compels students to leave schooling, with a mean, (1.4967) and standard deviation (.81170).

70.3% respondents perceived that frequent failure in classes compelled them to dropout, with a mean, (1.4500) and standard deviation (.74567).

67.0% respondents perceived that they left school because the teaching learning process was quite unpleasant, with a mean, ( 1.5200) and standard deviation( .79480).

66.0% respondents perceived that courses were quite difficult, with a mean, (1.5900) and standard deviation(.86278).

59.3% respondents perceived that teachers' harsh behavior in classes compelled them to leave schooling, with a mean, (1.7000) and standard deviation(.89405).

59.0% respondents perceived that frequent migration of their families in search of a livelihood resulted in their ultimate dropout. 11 out of dropout with a mean, (1.7533) and standard deviation(.93563).

55.3% respondents perceived that they left school due to their illness. 7 I left school due to my illness was found at rank 2 as a reason of dropout with a mean, (1.6900) and standard deviation(.83840).

54.7% respondents perceived that Lack of immediate returns of schooling was the reason of your drop out. 1. The study found at rank 1 that the Lack of immediate returns of schooling motivated students to dropout with a mean. (1.7167) and standard deviation(.84211).

52.7% respondents perceived that they feel insecure in school, with a mean, (1.8233) and standard deviation(.92102).

## CONCLUSIONS

- i. The study revealed an increasing dropout trend in Government Girls Primary Schools in District Mardan.
- ii. It was found that the high poverty level of the family causes the student to dropout.
- iii. The study revealed that frequent failure in classes compelled them to dropout.
- iv. The teaching learning process was found quite unpleasant in this study.
- v. The study showed that the courses were quite difficult.
- vi. It was found that the teachers' harsh behavior in classes compelled them to leave schooling.
- vii. The study showed that the frequent migration of families in search of a livelihood resulted in students' ultimate dropout.
- viii. The study found that students left school due to their illness.
- ix. The study revealed that Lack of immediate returns of schooling was the reason of their drop out.
- x. It was found that students feel insecurity in school.

## Recommendations;

The researcher recommends the following measures for dropout rates may be reduced

- i. Teachers' training may be focused to enhance teacher's competency to retain students in schools.
- ii. Academic monitoring system may be introduced for adequate supervision of teaching learning process.
- iii. Strategies may be adopted to reduce frequent absenteeism of students from school.
- iv. Mass mobilization campaigns may be launched for motivating parents for the schooling of their offspring.
- v. Stipends may be given to the poor students for the purchase of stationary and school uniform.
- vi. Special schooling arrangements may be made for the children of migrating families.

vii. Individualized teaching strategies may be introduced for slow learners.

viii. Pleasant school systems may be introduced with attractive delivery methods.

## REFERENCES

Academy of educational planning and management, 1985 *Retraining of Primary Education Personnel*, Pakistan.

Ajayi, I.A. and J.B. Ayodele, 2002. *Fundamentals of Educational Management*. Ado-Ekiti: Green Line Publishers

Ayodele, J.B., 2000. *School size, class size and teachers' quality as correlates of internal efficiency in Primary schools in Ondo State*, Nigeria An unpublished PhD thesis, University of Ibadan

Brumer, M.A. and I. Paul, 1971. *Wastage in Education: A world problem*. Paris: UNESCO IBE Geneva.) ,

Reis, S.M., Neu T.W., & Mc Guire, J.M. (1997) *Case studies of high-ability students with learning disabilities who have achieved*. *Exceptional Children*, 63, 463-479.

Rumberger, R.W. (1987). *High school dropouts: A review of issues and evidence*. *Review of Educational Research Journal*, 32, 583-625.

Salami, A., 1993. *Concept of wastage in relation to human resources*. An unpublished PhD thesis in vocational technical education, University of Nigeria Nsukka

Sitlington, P.L., & Frank, A.R. (1990). *Are adolescents with learning disabilities successfully crossing the bridge into adult life?* *Learning Disability Quarterly*, 13, 97-111.

Wijk T.V., 1983. *Evaluation of Higher Distance Education Results*, Madrid: International Congress of Open and Distance Teaching Universities. , p.432),

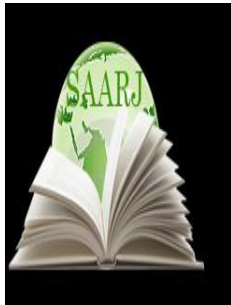

**ACADEMICIA**  
**An International**  
**Multidisciplinary**  
**Research Journal**  
 (Double Blind Refereed & Peer Reviewed Journal)



**DOI: 10.5958/2249-7137.2021.01250.7**

## ABOUT THE FEATURES OF ECONOMIC RELATIONS BETWEEN BUKHARA KHANATE AND INDIA

**A. A. Erkuziev\* ; R. Mahkamov\*\***

\*Docent,  
 Candidate of History, UZBEKISTAN

\*\*Master of sciences,  
 Namangan State University,  
 UZBEKISTAN

### ABSTRACT

*On the arrival of Anthony Jenkinson in Bukhara, the Bukhara Khanate had established active trade and economic relations with India. In his memories, Jenkinson wrote that there was an annual gathering of traders in Bukhara, which was visited by the traders from India with large caravans.*

**KEYWORDS:** *Economic Relation, Bukhara Khanate, India, Caravan.*

### INTRODUCTION

Admitting that Bukhara was one of the world's trade centers, the English traveler gave information about the foreign traders in the city, particularly, about the importance of trade by the Indian traders. Jenkinson pointed out that these traders were poorly dressed, and despite the fact that they had brought very little goods, these goods stayed unsold for 2-3 years.

However, a number of sources deny this information. According to them, Jenkinson deliberately discriminated against the activities of foreign, especially, Indian traders and the sale of Indian goods in Bukhara. The English traveler, who was well aware of the lack of demand for woolen fabrics woven in British manufactories in Central Asian markets, did not like the fact that the trade in Bukhara Khanate, in general, in Central Asian markets seemed to be important to another foreign country.

According to Jenkinson, Indian traders brought to Bukhara thin white fabrics used for turbans, as well as various white fabrics used for clothing and headwear. And they took silk cloths, unbleached hides, slaves and horses from Bukhara.

Jenkinson noted that Indian traders underestimated red and other mohair fabrics, and even though the traders from India and its distant lands, even from Bengal and the Ganges Valley were offered to exchange karasea for their goods, they did not want such mohair.

It is difficult to say that Jenkinson's information about the Bukhara trade was completely true. Because he could not sell woolen fabrics woven in British manufactories in Central Asia, so he deliberately tried to downplay the activities and role of Indian traders in Bukhara. Apparently he might have wanted to distract the traders who might be competitors in the trade from this trade.

Based on Jenkinson's data, it can be said that stable trade relations were established between the Bukhara Khanate and India. One of the main commodities in this trade was indigo (the Nile dye). There is also evidence that trade and diplomatic relations between the two countries revived in the XVI century. In particular, during the reign of Abdullakhan II, diplomatic relations were established between the Bukhara Khanate and Russia. In 1589, the ambassador Muhammad Ali from Bukhara brought gifts to the Russian Tsar Fyodor Ivanovich on behalf of Abdullakhan II, and the gifts included 40 pounds of the Nile dye.

This information indicates that at that time Bukhara served as a market for transit goods in trade between the Bukhara Khanate and India. N. I. Kostomarov and M. V. Fekhner, wrote in their works that Indian goods were import to Russia via Bukhara.

India was actively involved in international trade during the Baburids dynasty. However, India was gradually losing the opportunity to trade by sea with Western countries. V. V. Barthold writes, "The Portuguese began to occupy the most important coastal lands as early as the beginning of the XVI century in order to maintain profitable trade with India."

Such changes in India, in general, in the life of the Eastern states were associated with great geographical discoveries. In the early of XVI th century, the Portuguese occupied the port cities of India such as Diu, Daman, Gao, and took the control of the maritime trade of India. The fact that most of the country's maritime trade was passed into the hands of Europeans caused a great damage to the local traders. The Indian traders who were deprived of maritime trade began to turn their attention to Afghanistan and Central Asia.

Anthony Jenkinson said about the activities of Indian traders in the markets of Bukhara, "The Indians (to Bukhara) do not bring gold, silver, precious stones or spices. I tried to figure out the reason for this and found out that these goods were traded by the ocean. Because all the areas where these goods were produced (in India) were controlled by the Portuguese."

Jenkinson's opinion that the Indians did not bring gold, silver, precious stones, or spices to Bukhara is far from the truth. Because spices were one of the main exports from India to Bukhara.

In Russia in the XVII century gradually began to collect information on trade relations between Bukhara and India. For example, in 1671, Mullah Farrukh, the ambassador of Bukhara to Moscow, in meeting with Artamon Sergeevich Matveev, the head of the embassy in Russia, noted about the establishment of the constant trade relations between Bukhara and India and informed that precious stones, pearls and various floral fabrics were brought to Bukhara from India.

According to M. V. Fekhner, Rheum was brought to Bukhara from India.

The data about Bukhara-India relations given in Russian sources can also be found in the works of Western European authors. One of the foreign authors, the French traveler François Berne (1625-1688), lived in India for 12 years. According to him, there was a great demand for wet fruits in India. Wet fruits: melons, apples, pears, grapes were transported from Samarkand, Bukhara and Iran to Delhi and sold at high prices throughout the winter. In India, dried fruits, such as almonds, pistachios, hazelnuts, plums, apricots, raisins and other dried fruits were sold throughout the year.

According to F. Berne, because of the high demand for Central Asian horses in India, twenty-five thousand horses were brought to India every year from Central Asia, particularly, from the Bukhara Khanate. According to I. M. Reisner, the majority of the goods imported to India in the XVII century were horses imported from Central Asia and Arabia.

Afghan nomads, commonly known as "povinda", also took an active part in trade relations between the Bukhara khanate and India. In particular, the trade caravans coming from India to Central Asia, particularly, to the Bukhara Khanate, were guarded by the members of the Afghan povinda tribe. Povinda included the tribes such as lokhani, nasiri, haroti, miyahel, dutani, niyazi and they had more than 35,000 camels. Povinda members brought the goods belonging to the traders to Central Asia by their camels.

In the XV-XVIII centuries, the members of the povinda, who lived on caravan routes, took an active part as an intermediary in the India-Iran-Central Asia (Bukhara Khanate) trade. The data about the Afghan traders acting as intermediaries in trade between Bukhara and India can be found even in the sources of the XIX century. For example, in the article entitled "Afghanistan" it was noted as "They (members of the povinda) traded by their horses and camels between India, Khorasan and Bukhara. They joined an armed caravan to prevent looting on the road. They traveled to Bukhara and India twice a year. In March, they would return to their families and then to the Gilzai Mountains to prepare caravans for Kabul, Bukhara, Kandahar and Herat".

Thus, based on the above evidence, it can be said that in the XVI-XVIII centuries, trade and economic relations between the Bukhara Khanate and India continued despite all obstacles.

#### REFERENCES:

1. Дженкинсон Антоний. Путешествие в Среднюю Азию в 1558 – 1560 гг. // Английские путешественники в Московском государстве в XVI веке / Пер. с англ. Ю. В. Готье. – М.: ОГИЗ, 1937. – С. 184; Путешествие Антония Дженкинсона в Бухару (1558-1560) // История Узбекистана в источниках. Известия путешественников, географов и учёных XVI – первой половины XIX в. / Сост. Б. В. Лунин. Кн. 1. – М.: Фан, 1988. – С. 29.
2. Дженкинсон А. O'sha asar. – С. 184; Путешествие Антония Дженкинсона в Бухару (1558-1560) ... – С. 29.
3. Дженкинсон А. O'sha asar. – С. 184; Путешествие Антония Дженкинсона в Бухару (1558-1560) ... – С. 29.
4. Дженкинсон А. O'sha asar. – С. 184; Путешествие Антония Дженкинсона в Бухару (1558-1560) ... – С. 29.
5. Юлдашев М. Ю. К истории торговых и посольских связей Средней Азии с Россией в XVI – XVIII вв. –Т.: Фан, 1964. – С. 18-19.

6. Материалы по истории Узбекской, Таджикской и Туркменской ССР. Часть 1. – Л.: Изд-во АН СССР, 1932. – С. 9.
7. Костомаров Н. И. Очерки торговли Московского государства в XVI и XVII столетиях. – С.Петербург, 1862. – 299 с; Фехнер М. В. Торговля Русского государства со странами Востока в XVI веке. – М., Изд. Государственного исторического музея, 1952. – 138 с.
8. Бартольд В. В. Рец. на кн.: Жуковский С. В. Сношения России с Бухарой и Хивой за последнее трехсотлетие. – Пг., 1915. – 215 с. Отд. оттиск из “Записок Восточного отдела Императорского Русского Географического общества”. Т. XXII. – С. 341-343.
9. Дженкинсон А. O‘sha asar. – С. 184; Путешествие Антония Дженкинсона в Бухару (1558-1560) ... – С. 29.
10. Запись “разговора” думного дворянина Артамона Матвеева с бухарским послом муллою Фаррухом (1671) // История Узбекистана в источниках. Известия путешественников, географов и учёных XVI – первой половины XIX в. / Сост. Б. В. Лунин. Кн. 1. – М.: Фан, 1988. – С. 69.
11. Фехнер М. В. O‘sha asar. – С. 81.
12. Бернье Ф. История последних политических переворотов в государстве Великого Монгола / Перев. с франц. Б. Жуховецкого и М. Тамара. – М-Л.: Соцэкгиз, 1936. – С. 184.
13. Бернье Ф. O‘sha asar. – С. 184.
14. Рейснер И. М. Народные движения в Индии в XVII – XVIII вв. – М.: Издательство восточной литературы, 1961. – С. 32.
15. Бабаходжаев М. А. Русско-афганские торгово-экономические отношения в второй половине XVIII – начале XX в. – Т., 1965. – С. 15.
16. Афганистан (переведено из британской энциклопедии. Изд. 1878 г.) // Сборник географических, топографических и статистических материалов по Азии. Вып. 15. – СПб., 1885. – С. 224.

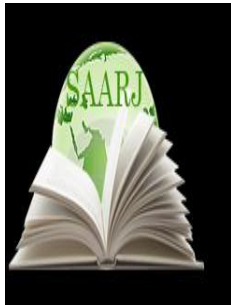

**ACADEMICIA**  
**An International  
Multidisciplinary  
Research Journal**  
**(Double Blind Refereed & Peer Reviewed Journal)**



**DOI: 10.5958/2249-7137.2021.01252.0**

**RELATIONSHIP BETWEEN THE EXPRESSION OF PAIN SYNDROME  
AND THE SIZE OF THE INTER VERTEBRAL HERNIA OF THE  
LUMBAR SPINE**

**Fayzulin Ruslan Vadimovich\* ; Pavlanova Matlyuba Satvaldiyevna\*\* ;  
Ismailov Bakhromiddin Zakhridinovich\*\*\***

\*Applicant of the Department Histology and Pathological Anatomy,  
Fergana Medical Institute of Public Health,  
UZBEKISTAN  
Email id: pyc77@mail.ru

\*\*Assistant Teacher,  
Department Histology and Pathological Anatomy,  
Fergana Medical Institute of Public Health,  
UZBEKISTAN

\*\*\*Lecturer of the department Histology and pathological anatomy,  
Fergana Medical Institute of Public Health,  
UZBEKISTAN

**ABSTRACT**

*The article highlights the experience of observing more than 500 patients with vertebral pain syndrome. The data of MRI and MSCT of patients with hernias of the lumbar spine were analyzed. The obtained data were compiled with the results of the survey of the observed patients on the questionnaires of pain and the questionnaire of Oswestri. Based on the results of the observation of patients, a conclusion was made about the absence of a clinically significant relationship between the size of the disc herniation and the size of the light bulb.*

**KEYWORDS:** *Herniated Disc Of The Lumbosacral Spine, Severity Of Pain Syndrome, Size Of The Lumbar, Correlation Of The Size Of The Hernia With Pain Syndrome*



## INTRODUCTION

The prevalence of vertebral back pain (VBP) is quite high. Often in the work of a neurologist, up to 85% of visits are associated with this disease. Also, back pain (in the lumbar region) is often the most common cause of disability and medical seeking [1,2,3,16].

According to the definition of the North American Society for the Study of Diseases of the Spine (NASS) [4,5] a herniated disc with symptoms of radiculopathy (discogenic radiculopathy) is a displacement of the components of the intervertebral disc outside the normal boundaries, manifested by pain and / or sensory disorders in the corresponding dermatomes, weakness in the corresponding myotomes (indicator muscles). According to foreign literature, in particular, epidemiological studies within one month on average, 20-30% of the population suffer from back pain on average [1,6,12,13]. Over the course of a year, 40-50% of adults over 22 years of age experience an episode of back pain, and 60 to 80% of people experience it during their lifetime, with a recent trend towards an increase in the prevalence of back pain among the younger population and disease progression over time.. The prevalence of chronic back pain reaches 20% [13,14,15].

According to the accepted diagnostic triad [9,10,17], the most common cause of back pain is musculoskeletal (nonspecific) sources, the second most common cause is discogenic lumbar radiculopathy. When lumbalgischeskom syndrome discogenic etiology with radiculopathy are used as surgical and various conservative therapies. Research data on their comparative effectiveness are contradictory [18,19,20,21,22].

At the same time, despite the high prevalence of pathology and the associated huge economic and labor-hour losses, the optimal algorithm for choosing tactics between conservative and surgical methods of treatment has not been determined [1, 12, 13]. Doctors of polyclinics and related specialties often focus on the size of the hernia when consulting patients with pain syndromes, forgetting about the possibility of a natural reduction in the size of a disc herniation, but with the preservation of the pain syndrome. However, the statistics that have emerged with the development of imaging technologies and screening research methodology force us to reconsider the emphasis.

Intervertebral hernia until relatively recently was considered almost the main cause of all dorsalgia (see "Back pain and other terms"). In some cases, a hernia is detected in people who did not even know about its existence, and vice versa: a lot of severe pain syndromes localized in the back area have nothing to do with an intervertebral hernia.

Of great scientific and practical interest is the identification of the relationship between MRI and MSCT, signs of degeneration and clinical manifestations of pathology of the lumbar spine.

**The main purpose** of the study was to identify the relationship between the size of the disc herniation and the severity of pain in patients with disc herniation of the lumbosacral spine, detected by imaging methods of examination.

## MATERIAL AND METHOD

The study was carried out on the basis of the department of the Central Multidisciplinary Polyclinic (CMPP) of the Fergana City Medical Association. By the method of continuous sampling, from March 2018 to March 2020, a group of 547 patients was formed (279 women [51%] and 268 men [49%], aged 18 to 69 years ( $38.8 \pm 11.8$  years)) The group did not include patients with mental illness (3), metastases in the spine (1), acute infectious disease (2), rheumatoid arthritis (3), acute trauma (4), instability of the spinal motion segments of the lumbar spine caused by spondylolysis and spondylolisthesis (16).

**TABLE 1. GENERAL CHARACTERISTICS OF THE GROUP OF PATIENTS WHO PARTICIPATED IN THE STUDY**

Indicators		Number	%
Education	Bachelor	187	34
	High school	360	56
Job	Employed	282	51
	Unemployed	265	49
Unemployed	Pensioner	81	15
	Housewives	132	24
	Students	43	8
Stage of the disease	Acute	128	23
	Exacerbations	257	47
	Chronic without exacerbation	162	30
Nosology	Nonspecific pain in the lower back	122	23
	Discogenic radiculopathy	425	77

All patients underwent MRI or MSCT examination of the lumbar spine to clarify the presence and size of the hernia.

Depending on the size of the hernia revealed during examination (MRI and / or MSCT) of the disease, the patients will be divided into 4 groups - the first group - with a disc herniation of 9 mm or more, the second - with dimensions from 6 mm to 8 mm, the third - with sizes from 2 mm to 5 mm, the fourth - with sizes up to 2 mm or without pathology when visualizing the lumbar spine.

**TABLE 2. DISTRIBUTION OF PATIENTS DEPENDING ON THE SIZE OF HERNIATED DISC**

Hernia size in mm	2018	2019	2020	Total	%
9 mm or more (extra large)	35	59	48	142	26
6 mm to 8 mm (large)	46	55	45	146	27
2 mm to 5 mm (medium)	52	44	41	137	25
up to 2 mm or without pathology (small)	48	35	39	122	22
<b>TOTAL</b>	<b>181</b>	<b>193</b>	<b>173</b>	<b>547</b>	

To compare the presence and severity of pain in patients with disc herniation, a questionnaire was conducted using 3 pain questionnaires;

- VAS and NAS - Visual and numerical analogue scale of pain (determination of the intensity of pain, estimated from 0 to 10 points, where 0 is no pain, and 10 is the maximum pain that a person can imagine)
- CPOT (Critical-Care Pain Observation Tool), from 0 to 8 points
- Oswestry questionnaire (index of disability due to pain in the lower back) from 0 to 50 points.

### Results

In the period from March 2018 to March 2020, 547 patients with herniated intervertebral discs of the lumbosacral spine were observed. Based on visualization diagnostic methods (MRI and MSCT), as well as as a result of questionnaires on pain questionnaires, data on the size of disc herniation and the severity of pain in patients were analyzed and compared.

According to the questionnaire VAS and NAS in the group of patients with disc herniation more than 9 mm (very large), the average result was 6.4 points, in the group from 6 mm to 8 mm (large) - 7.2 points, in the group from 2 mm to 5 mm (average) - 6.3 points, and in the group up to 2 mm or without pathology (small) - 4.8 points. According to the CPOT questionnaire, in the group of patients with disc herniation more than 9 mm (very large), the average result was 4.9 points, in the group from 6 mm to 8 mm (large) - 5.6 points, in the group from 2 mm to 5 mm (average) - 4.6 points, and in the group up to 2 mm or without pathology (small) - 3.8 points. According to the Oswestry questionnaire, in the group of patients with disc herniation more than 9 mm (very large), the average result was 43 points, in the group from 6 mm to 8 mm (large) - 35 points, in the group from 2 mm to 5 mm (average) - 36 points points, and in the group up to 2 mm or without pathology (small) - 42 points.

**TABLE 3. RESULTS OF THE QUESTIONNAIRE SURVEY ON PAIN QUESTIONNAIRES**

Hernia size in mm	Average score in the group						
	VAS/ NAS	% of max pain	CPOT	% of max pain	OSWE STRY	% of max pain	Total pain score in%
9 mm or more (very large)	6,4	64	4,9	61	43	86	<b>70,3</b>
6 mm to 8 mm (large)	7,2	72	5,6	70	35	70	<b>70,7</b>
2 mm to 5 mm (medium)	6,3	63	4,6	57	36	72	<b>64,0</b>
up to 2 mm or without pathology (small)	4,8	48	3,8	52	42	84	<b>61,3</b>

As you know, pain syndrome is considered to be directly proportional to the size of the disc herniation. However, the analysis of our data showed that in patients who deal with pain in the lower back, pain syndrome does not directly depend on the size of the disc herniation. Patients can have equally pronounced pain sensations, both with a large hernia (9 mm or more), and with a smaller hernia or in the absence of one. Pain intensity ratios and an index of disability due to lower back pain are practically at the same level, regardless of the size of the hernia. (Fig 1.)

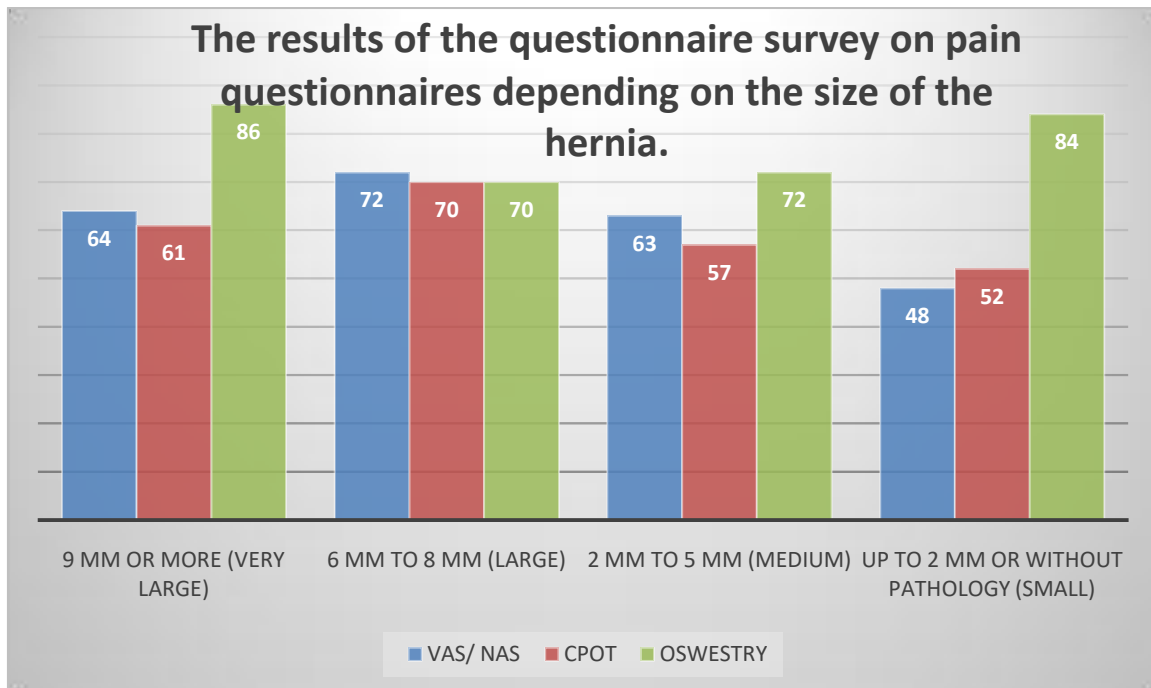

The results are summarized in table. 3. When comparing the results of treatment in all four groups of patients, there were no clinically significant differences in the values of the intensity of pain syndrome and the index of disability due to pain in the lower back in the observed group of patients, which confirms the correctness of our assumption that there is no direct the relationship between the severity of the pain syndrome and the size of the intervertebral hernia of the lumbar spine.

## DISCUSSION

The current state of the problem of conservative treatment is such that there are many methods that do not have an evidence base.

The first and most controversial question in the treatment of herniated intervertebral discs is what treatment tactics to choose for the patient, whether an operation is needed or it is possible to “cure a herniated disc” with conservative methods. The aim of this work was not to analyze all the existing variants of neurological deficit in a herniated disc. The logical position of a practicing neurologist, who daily faces the question of choosing a treatment tactic, based on the presence of radicular pain syndrome and confirmation of compression of this root according to MRI data, to emphasize that pain syndrome often does not depend on the size of the hernia, that patients, regardless of the size of the hernial protrusion, experience comparable painful sensations. And from this it follows that many conservative methods allow you to completely

eliminate radicular pain syndrome, and in this case, the meaning of the operation is lost. That is why the choice of tactics for treating a large hernia cannot be based only on the results of MRI and the presence of complaints of back pain.

The second debatable issue is the choice of the method of conservative treatment in each particular case and its criteria. The use of only one technique, in our opinion, is not constructive. Different methods have their own niche. ” This is due to the technical limitations of the institution, contraindications for carrying out certain manipulations and methods (allergies, concomitant pathologies, etc.), on the one hand, and serious economic costs, on the other. Among other things, it should be noted that an important issue is the doctor's experience in carrying out one or another manipulation. The so-called “learning curve” indicates that when mastering techniques, there is always a fairly significant percentage of complications and unsuccessful outcomes.

The third debatable issue is the complications of surgical treatment. The most pronounced neurological complication that we encountered during the study was transient monoradicular paresis in the leg (21 cases). The most probable cause of this complication is mechanical “pressing” of the outgoing spinal nerve by the endoscopic port. Given the transient nature of the disorders, the anatomical integrity of the root was not compromised, and the symptoms were caused by a transient disturbance of blood circulation in the spinal nerve.

Of the surgical complications of the operation, it is necessary note the two most significant - recurrent disc herniation and damage to the dura mater. Only recurrence of a herniated disc, causing symptoms, is an indication for reoperation, in other cases conservative therapy is continued. In 13 cases, during portal discectomy, damage to the dura mater occurred, which did not lead to any symptoms.

## CONCLUSION

Based on the analysis of the results of intervertebral disc hernias and their size revealed by MRI and MSCT, as well as the use of various pain questionnaires, it was concluded that there was no clinically significant relationship between the size of the disc herniation and the severity of pain symptoms. The data obtained allow us to conclude that the choice of surgical tactics and treatment methods for patients with hernia sizes of more than 8-9 mm should not be based solely on the results of MRI and the presence of pain syndrome and take into account that the intensity of pain in the lower back does not directly depend on the size herniated disc.

## REFERENCES

- Casey, E. Natural History of Radiculopathy. // Phys Med Rehabil Clin N Am. - 2011. - VOL.22. - №1 . - P.1-5.
- Schoenfeld, A.J., Laughlin, M., Bader, J.O., Bono, C.M. Characterization of the incidence and risk factors for the development of lumbar radiculopathy. //J Spinal Disord Tech. -2012. - VOL.25. - №3 . - P.163-167
- Korovessis, P., Repantis, T., Zacharatos, S., Baikousis, A. Low back pain and sciatica prevalence and intensity reported in a Mediterranean country: ordinal logistic regression analysis. //Orthopedics. - 2012. - VOL.35. - № 12. - P.e1775-e1784

- Kreiner, D.S., Hwang, S.W., Easa, J.E., et al. An evidence-based clinical guideline for the diagnosis and treatment of lumbar disc herniation with radiculopathy. //Spine J. 2014. - VOL.14. - №1 . - P.180-191.
- Kreiner, D.S., Hwang, S.W., Easa, J.E., et al. Diagnosis and Treatment of Lumbar Disc Herniation with Radiculopathy. - North American Spine Society- 2012.
- Driscoll, T., Jacklyn, G., Orchard, J., Passmore, E., Vos, T., Freedman, G., Punnett, L. The global burden of occupationally related low back pain: estimates from the Global Burden of Disease 2010 study. //Ann Rheum Dis. - 2014. - P.1-7.
- Bardin, L.D., King, P., Maher, C.G. Diagnostic triage for low back pain: A practical approach for primary care. // Med J Aust. - 2017. - VOL.206. - №6 . - P.268-273.
- Hush, J.M., Stanton, T.R., Siddall, P., Marcuzzi, A., Attal, N. Untangling nociceptive, neuropathic and neuroplastic mechanisms underlying the biological domain of back pain. // Pain Manag. - 2013. - VOL.3. - №2013 . - P.223-236.
- Stafford, M.A., Peng, P., Hill, D.A. Sciatica: A review of history, epidemiology, pathogenesis, and the role of epidural steroid injection in management. //Br J Anaesth. - 2007. - VOL.99. - №4 . - P.461-473.
- Yang, X., Zhang, Q., Hao, X., Guo, X., Wang, L. Spontaneous regression of herniated lumbar discs: Report of one illustrative case and review of the literature. // Clin Neurol Neurosurg. - 2016. - VOL.143. - P.86-89.
- Driscoll, T., Jacklyn, G., Orchard, J., Passmore, E., Vos, T., Freedman, G., Punnett, L. The global burden of occupationally related low back pain: estimates from the Global Burden of Disease 2010 study. //Ann Rheum Dis. - 2014. -P.1-7
- Manchikanti, L., Singh, V., Falco, F.J.E., Benyamin, R.M., Hirsch, J.A. Epidemiology of low back pain in Adults. //Neuromodulation. – 2014. – VOL. 17. -№ S2. – P. 3-10.
- Stubbs, B., Koyanagi, A., Thompson, T., Veronese, N., Andre, F. The epidemiology of back pain and its relationship with depression , psychosis, anxiety, sleep disturbances , and stress sensitivity: Data from 43 low- and middleincome countries. //Gen Hosp Psychiatry. - 2016. - VOL.43. - P.63-70.
- Meucci, R.D., Fassa, A.G., Muller, N., Faria, X. Prevalence of chronic low back pain: systematic review. //Rev Saúde Pública. - 2015. - VOL.49. - №73 . - P.1-10.
- Shmagel, A., Foley, R., Ibrahim, H. Epidemiology of Chronic Low Back Pain in US Adults:Data From the 2009–2010 National Health and Nutrition Examination Survey.// Arthritis Care Res. - 2016. - VOL.68. - №11 . - P.1688-1694.
- Vos, T., Alemu Abajobir, A., Hassen, A.K., et al. Global, regional, and national incidence, prevalence, and years lived with disability for 328 diseases and injuries for 195 countries, 1990-2016: a systematic analysis for the Global Burden of Disease Study 2016. //Glob Heal Metrics - 2017. - VOL.390. - P.1211-1259.

- 
- Подчуфарова, Е.В. Дискогенная пояснично-крестцовая радикулопатия. //Неврология, нейропсихиатрия, психосоматика. - 2010. - Т.3. - С.22-29.
  - Haro, H. Translational research of herniated discs: Current status of diagnosis and treatment. //J Orthop Sci. - 2014. - VOL.19. - №4 . - P.515-520.
  - Jacobs, W.C.H., Van Tulder, M., Arts, M., Rubinstein, S.M., Van Middelkoop, M., Ostelo, R., Verhagen, A., Koes, B.P.W., et al. Surgery versus conservative management of sciatica due to a lumbar herniated disc: A systematic review. //Eur Spine J. - 2011. - VOL.20. - №4 . - P.513-522.
  - Lequin, M.B., Verbaan, D., Jacobs, W.C.H., et al. Surgery versus prolonged conservative treatment for sciatica: 5-year results of a randomised controlled trial. // BMJ Open. 2013. - VOL.3. - №5 . - P.1-14.
  - Lurie, J., Tosteson, T., Tosteson, A., et al. Surgical versus Non-Operative Treatment for Lumbar Disc Herniation: Eight-Year Results for the Spine Patient Outcomes Research Trial (SPORT) // Spine (Phila Pa 1976) - 2014. - VOL.39. - №1 . - P.3-16.
  - Weinstein, J.N., Lurie, J.D., Tosteson, T.D., Tosteson, A.N.A. Surgical versus Non-Operative Treatment for Lumbar Disc Herniation: Four-Year Results for the Spine Patient Outcomes Research Trial (SPORT) // Spine (Phila Pa 1976). - 2009. - VOL.33. - №25 . - P.2789-2800.

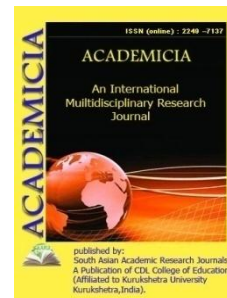
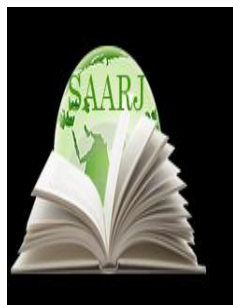

DOI: **10.5958/2249-7137.2021.01253.2**

## THE USAGE OF ICT IN THE CLASSROOMS OF PRIMARY SCHOOL

**N.U. Abraimova\***

\*Foreign Languages Department,  
Jizzakh State Pedagogical Institute,  
UZBEKISTAN

### ABSTRACT

*Traditionally, it is believed that a child receives literacy in primary school, where he is taught to write, read and count. This is undoubtedly the case. But modern society needs new ways of activity, which requires a person to develop a whole range of skills and abilities - finding the necessary information, processing it, providing it to other people, modeling new objects and processes, self-planning and building their actions. Along with teaching reading, writing and numeracy skills, starting from the first grade, it is important to teach children how to use digital technology as a working tool in their studies and everyday life.*

**KEYWORDS:** *Multimedia Products, Interactive Technologies, Educational Effects, Information And Communication Technologies, Modern Technologies, The Teacher And Pupils.*

### INTRODUCTION

Modern man is surrounded by so much information that he is not able to process and use for the development of society without the help of new information technologies. Every year more and more information technologies, computer breaks into our life. Proceeding from the fact that “information and communication technologies are a set of methods, devices and production processes used by society to collect, store, process and disseminate information”, the main thing in the teacher's practice is to understand the role of ICT application in educational activities. The success of the reform of Uzbek education largely depends on the human factor: the teacher and his professionalism. It is the level of qualifications of the teaching staff, their readiness to use modern technologies in professional activities that will be the main ones in the complex process of bringing education to the level of the needs of modern society. Information technologies provide a unique opportunity for development not only for the pupils, but also for the teacher. The development and expansion of the information space of children and adolescents, encourages the teacher to study together with pupils, mastering new previously unexplored



spaces. Let me emphasize that the simple use of computer technology in the classroom does not automatically entail an increase in the level of the teacher's professional skill and an increase in the quality of education. The firstly, the determining role is played by the personality of the teacher and his motivation. Therefore, in schools it is necessary to create such working conditions in which the teacher would like to apply the knowledge, he has in the field of ICT use and replenish it. At the same time, the introduction of modern technologies in pedagogical activity should not be just a necessity, but be a conscious process in the continuous education and self-education of a teacher in this area. The directions of modernization of education should be determined not so much by the presence of computer equipment and software in the school, as by the readiness of primary school teachers to change in accordance with the needs and problems of society. According to the website of statistics, 18% of teachers in grades 1-4 have a negative attitude to the usage of computer technologies in the classroom, do not show interest in computers, avoid training in computer literacy courses, preferring to resort to the help of their "advanced colleagues". The teaching experience of this group of teachers is over 20 years. More than half of primary school teachers (54%) have a positive attitude towards computers, show interest in new ICTs, usage them in their practice, including both young teachers (work experience up to 5 years) and experienced teachers. About a third of primary school teachers (28%) have a positive attitude towards IT, are interested in it, but do not use it in their lessons. This group also included teachers with different experience. And among primary school teachers who own computer technologies, 18% do not use them in class, 27% use them, but rarely, 36% use them 2-3 times a week, and 19% constantly, practically in every lesson. Table 1 shows data about why importance and using of ICT is decreasing.

**TABLE 1. THE USAGE OF ICT BY PRIMARY SCHOOL TEACHERS**

1	Electronic processing of documents
2	Use of off-the-shelf multimedia products
3	Using Internet resources to prepare for lessons or for self-education
4	Using e-mail for correspondence, communication with colleagues
5	The use of computer technology outside school hours
6	The use of computer technology in work with parents
7	Using your own multimedia products
8	Professional forums, work in network professional associations
9	Using the Internet to participate in distance competitions, olympiads, conferences of various levels
10	Distance education

From this table, it can be seen that teachers are more focused on the consumption of the finished product, the usage of a computer for reasons of convenience. They practically do not see its importance for self-education, professional communication, distance exchange of experience and distance learning. Now everyone understands that a computer cannot replace a living teacher. But it will help to facilitate his work, to interest children, to provide a more visual, completely new perception of the material. Therefore, topic of article was chosen for self-education "Using ICT in the classroom in primary school as a means of improving the quality of learning". It was trained in courses, studied literature on this topic and began to use ICT in the lessons. The usage of ICT in the educational process allows:

- To enhance educational effects;
- To improve the quality of assimilation of the material;
- To build individual educational trajectories of students;
- To imply a differentiated approach to students with different levels of readiness to learn;
- to organize at the same time children with different abilities and capabilities.

One of the most successful forms of preparation and presentation of educational material for lessons in primary school is the creation of multimedia presentations [1].

Moreover, the presentation allows the teacher to independently compose the educational material based on the characteristics of a particular class, topic, subject, which allows you to build a lesson in such a way as to achieve the maximum educational effect. The usage of interactive technologies is becoming commonplace in education. Interactive equipment such as interactive whiteboards create sustainable motivation for learners to acquire knowledge and help creatively solve learning problems, thereby developing the imaginative thinking of learners. With the help of an interactive whiteboard, you can demonstrate presentations, create models, actively involve students in the process of mastering the material, improve the pace and flow of the lesson[2]. The electronic board helps children to overcome fear and embarrassment at the blackboard, to easily involve them in the educational process. The class does not remain indifferent. Due to the great clarity, the use of an interactive whiteboard allows you to draw the attention of children to the learning process, increases motivation. Everything that is on the computer is demonstrated on the interactive whiteboard. It allows you to move objects and labels, add comments to texts, pictures and diagrams, highlight key areas and add colors. The teacher had the opportunity to model his lesson together with the students in the brainstorming mode, demonstrate the educational material, make written comments over the image on the screen, write down the students' ideas and thus create a general summary with the educational material together with the students. At the same time, what is written on the interactive whiteboard can be transmitted to pupils, saved on magnetic media, printed, and sent by e-mail.

Also, in the classroom, it is possible to access the Internet, where pupils can independently obtain new information. While working on interactive whiteboards, the concentration of pupils' attention is improved, the learning material is absorbed faster, and as a result, the academic performance of each of the pupils is increased, which qualitatively increases the level of modern education. Using an interactive whiteboard, the teacher can not only show and comment on paintings and graphics, but also create their own drawing.

Despite all the difficulties that the teacher is able to solve, new technologies open up more opportunities for the teacher to be creative. The little experience already available has shown that working with ID improves the perception of the material by pupils, especially in primary grades. Pupils find that working with ID is much more fun than working with a whiteboard or printed handout. They recognize that an interactive approach helps them take an active part in the lesson.

The main problem a teacher faces when preparing lessons is finding materials. Commercially available multimedia discs can be used as sources for demonstrations. Among the multimedia discs, firstly it should be noted is the "Cyril and Methodius Children's Encyclopedia" disc. It's an exciting journey into the world of knowledge. Lively interesting presentation, bright colorful

design, ease of use - all this make an indispensable assistant in understanding the world with little “why”. The encyclopedia contains a lot of useful information about the world around, about existing and disappeared civilizations, great eras and distant worlds, outstanding figures of the past and present, about unusual natural phenomena, animals and plants. A variety of illustrated information in a playful way will help to awaken a thirst for discovery in a child, explain and acquaint one with serious encyclopedic knowledge, and help to master school subjects. “Children's Encyclopedia of Cyril and Methodius” is more than 10,000 amazing facts and phenomena, the richest treasury of knowledge about everything.

The Internet is a new information phenomenon, before which we - teachers - found ourselves like a fabulous hero at a crossroads: there are many roads, a wide choice, and we have not had time to understand what it is and why we need it [3]. The global computer network for the educational process is a powerful tool that should organically fit into the subjects of educational areas.

Working with the Internet develops confidence, allows you to feel part of the big real world, spurs curiosity, increases communication skills, creates an element of competition, allows you to diversify the activities in the lesson. Often pictures from the Internet become the only source for children to see a portrait of the writer, photographs, Uzbek and other national folk costumes, masterpieces of Uzbek and other nations' art. It becomes a vivid visual aid and a source of inspiration in the lessons of fine art, the world around, literary reading and art work.

### **PERFORMANCE OF EXPERIENCE**

The effectiveness of this experience includes:

- Growth of positive motivation in the classroom using ICT;
- Increasing the level of use of clarity in the lesson;
- Increasing the productivity of the educational process;
- Qualitative change in the relationship between the participants in the educational process;
- Increasing in the quality of knowledge.

### **REFERENCES**

1. Sa'dullayeva M.V. Using media lessons to develop the thinking of younger students. Primary school teacher community library. Educational portal “Creative Teachers Network”, 2008.
2. Zaparova N.I. The introduction of information technology in the educational process. Magazine “Primary School” №1, 2008.
3. Study materials: lessons, pictures, widgets. [Electronic resource]. Access mode: <http://www.smartboard.ru/> (date of access 15.06.2016).

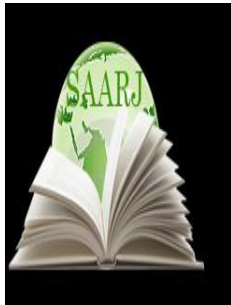

**ACADEMICIA**  
**An International**  
**Multidisciplinary**  
**Research Journal**  
 (Double Blind Refereed & Peer Reviewed Journal)



**DOI: 10.5958/2249-7137.2021.01254.4**

## THE ROLE OF THE SOCIAL ENVIRONMENT IN THE FORMATION OF PERSONALITY

**Rakhimbayeva Dilbarkhon\***

\*Associate Professor of Social Sciences,  
 Candidate of Philosophical Sciences,  
 Namangan State University,  
 UZBEKISTAN

### ABSTRACT

*This article discusses the role of the social environment in personality formation. The author analyzed the social environment separately from the factors influencing the individual in the process of self-awareness. According to the definition widespread in psychology, a role is a program that meets the expected behavior of a person in the structure of a particular social group; it is a given, non-free way of his participation in the life of society.*

**KEYWORDS:** *Personality, Identification, Society, Social Groups, Sociology*

### INTRODUCTION

The formation of personality occurs in the process of assimilation by people of the experience and value orientations of a given society, which is called socialization. A person learns to fulfill special social roles, i.e. learns to behave in accordance with the role of a child, student, employee, spouse, parent, etc.

The social personality develops in the communication of people, starting with the primary forms of communication between the mother and the child. The child is constantly involved in some form of social practice; and if there is no special organization for it, then the child's upbringing effect is exerted by its traditional forms, the result of which may be in conflict with the goals of upbringing. The formation of a person as a person requires from society a constant and consciously organized improvement of the system of social education, overcoming stagnant, traditional, spontaneously formed forms.

Personality is a system of socially significant qualities of an individual, a measure of his mastery of social values and his ability to realize these values.

As a person, a person is characterized by the level of development of his consciousness, the correlation of his consciousness with social consciousness, which, in turn, is determined by the level of development of a given society.

An essential aspect of the personality is its relation to society, to individuals, to oneself and to one's social and labor duties.

A human being becomes a human only thanks to social heredity - thanks to the assimilation of the experience of previous generations, enshrined in knowledge, traditions, objects of material and spiritual culture, in the system of social relations.

But the formation of a person as a person occurs only in specific social conditions. The requirements of society determine both the models of people's behavior and the criteria for assessing their behavior.

As the starting point for understanding the nature of personality, one can take the statement of A. N. Leont'ev. Describing the subject of personality psychology, he wrote: "Personality is an individual; this is a special quality that is acquired by an individual in society, in the totality of relations that are social in nature, in which the individual is involved.

Personality is a systemic and therefore "supersensible" quality, although the bearer of this quality is a completely sensible, bodily individual with all his and acquired properties".

The essence of the personality is manifested in the study of the position, the position of a person in his relationship with other people, is revealed in his life goals and the motives behind them, in methods of behavior and means of action in relation to his general goals and objectives. The concept of personality is closely related to the concept of position and related concepts of social role and social status.

According to the definition widespread in psychology, a role is a program that meets the expected behavior of a person in the structure of a particular social group; it is a given, non-free way of his participation in the life of society. Status determines the behavior of a person included in the system of established social relations, where the place and mode of action, the type of normative behavior, are given for him. In the status system, there are always norms that govern our relations, our actions.

The concepts of status and role are related to the definition of personality. It is no coincidence that in everyday consciousness, a person's personality is identified with his social position, social status; a person is judged by his social actions, by his social role.

The place of a person in social life can be assigned, prescribed to him by chance, birth, circumstances. A person's place in life can be chosen, found, conquered by him, by his own will and free, conscious choice. In this case, they talk about the subject's choice of a position in life, about his personal self-determination. Position is the most integral characteristic of a person as a person. Personality is a person who freely, independently and responsibly determines his place in life, in society, in culture. Therefore, the personality is an entirely socio-cultural formation. You can also find such a definition: personality is a subject, freely defined, developed its position in the space of culture and time of history.

The social environment is, first of all, people united in various groups with which each individual has a specific relationship, in a complex and varied communication system. The social

---

environment surrounding the person is active, affects a person, exerts pressure, regulates, subordinates to social control, carries away, “infects with the corresponding“ models” of behavior, encourages, and often compels, a certain direction of social behavior.

A person draws a complex of scientific knowledge, rich life experience, motives of his actions from a direct source, which is the social environment. In the foreground are those opportunities that objectively exist in society that allow an individual to express himself as a person. The content of this impact lies in the fact that the realization of the rights, freedoms and duties of an individual should take place on the basis of a combination of the interests of the whole society as a whole and of each individual individually. This is possible only in a society where the free development of everyone is a condition for the free development of all. In addition to the state-social environment, social in the broadest sense of the word, one should also highlight the microenvironment, which includes relations that arise in a small social group, in a work collective, of which a person is a member, a set of interpersonal relations.

It cannot be assumed that, under the influence of the social environment in the broad sense of the word, representatives are unified, that they all become completely identical. Each personality has its own specific features that distinguish it.

A specifically human form of interactions and relationships is created by interconnections between people. Another person has a very peculiar effect on the individual. On the basis of a number of experimental studies, it is known that the presence of another person in a situation has a specific effect on the behavior of an individual. In social psychology, the effects of “coexistence”, “cooperation”, “social reinforcement”, “co-activity”, etc. have been noted. They cannot be explained in one way, only by the peculiarities of the subject-object relationship. Personal interactions are of a much more complex nature. Some of their features can be identified by analyzing social expectations.

Human activity involves the use of complex mental mechanisms. In the theory of the installation, some of their aspects have been studied experimentally. The analysis of experimental data showed that when “constructing behavior” by means of the setting mechanism, not only the needs of the individual and the corresponding situation are taken into account, but also those possible transformations that are expected with high probability. This feature of attitudinal activity was investigated from the physiological point of view by I.M. Feigenberg, and was designated by him as the ability of the brain to make probabilistic prediction.

Setting forecasting as a primitive form of expectation is one of the manifestations of the specificity of a person's attitude to reality (its reflection). Such expectations can act completely unconsciously. Moreover, as experimental studies show, the maturation of the abilities of objectification and awareness is not enough for the formation of social expectations. Their formation begins only at a transitional age, and only at the last stage of human socialization do they become determinants of behavior. It should also be noted that their formation requires the participation of consciousness and objectification, however, once formed, they can function at an unconscious level.

Although a person is born with many biological inclinations, the formation of his personal properties is determined by social interactions and patterns. As the classics of Marxism point out, the essence of man is created by the totality of social relations. Human needs, his conscious and unconscious relationship to reality, personal relationships should be considered as phenomena

---

that are the result of differentiation and concretization of an integral system of socio-cultural values. When studying the patterns of formation and action of social orientations of people, the principle of “differentiation - concretization of primary wholes” was used as a methodological principle, as opposed to the principle of “integration - linking of elements”, which is characteristic of associationist and behaviorist theories.

#### REFERENCES:

1. Hakimovich, H. N., Khodiyevna, R. R., Mustafakulovna, M. O., & Narzulloevna, A. S. (2020). EDUCATION SYSTEM MISSION IN THE CONDITIONS OF CIVIL SOCIETY DEVELOPMENT. *Journal of Critical Reviews*, 7(5), 832-837.
2. Narzulloevna A. S. et al. MODERN PEDAGOGICAL METHODS IN EFFECTIVE ORGANIZATION OF LESSONS // *Journal of Critical Reviews*. – 2020. – Т. 7. – №. 9. – С. 129-133.
3. Olimov, Q. T., Sayidaxmedova, M. S., Jalolova, D. F., Bozorova, M. Q., Boltayeva, M. L., & Alimov, A. A. (2012). Pedagogik texnologiyalar o'quv qo'llanmasi. T.: «Fan va texnologiya», 300.
4. Boltaeva M. L. et al. ANALYSIS OF TRADITIONAL AND INTERACTIVE TEACHING AND MODELS OF ITS APPLICATION // *Journal of Critical Reviews*. – 2020. – Т. 7. – №. 7. – С. 1577-1587.
5. Тургунов С. Т. СТРАТЕГИИ И СТРАТЕГИЧЕСКОЕ УПРАВЛЕНИЕ–ОСНОВА ЭФФЕКТИВНОЙ ДЕЯТЕЛЬНОСТИ ОБРАЗОВАТЕЛЬНЫХ УЧРЕЖДЕНИЙ // *ЯЗЫК И АК*. – 2016. – С. 48.
6. Тургунов С. Т., Ахмаджонова Н. М. Особенности управления дошкольными образовательными учреждениями // *Вопросы гуманитарных наук*. – 2012. – №. 2. – С. 80-82.
7. Тургунов, С. Т., & Хакимова, Д. М. (2017). Координация деятельности субъектов в процессе формирования и развития у учащихся рефлексивных навыков. *Педагогическое образование и наука*, (2), 97-100.
8. Abdullaeva Nasiba Burronovna. (2020). Integration Of Scientific And Rational And Artistic And Aesthetic Aspects In Design And Art. *International Journal of Advanced Science and Technology*, 29(8s), 1334 - 1336.
9. Nafosat Zikirova, Nasiba Abdullayeva, Ozoda Nishanova, Baktior Djalilov, Enajon Nishanbayeva. (2020). Issues On Using Interactive Strategies In Teaching Process. *Journal of Advanced Research in Dynamical and Control Systems*, 12 (02), 2753-2756.
10. Nafosat, Z., Nasiba, A., Ozoda, N., Baktior, D., & Enajon, N. (2019). Interactive strategies and methods of education.
11. Abdullaeva, N. B. (2015). THE ESSENCE AND CONTENT OF THE AESTHETIC COMPONENT IN DESIGN. *ISJ Theoretical & Applied Science*, 9(29), 169-171.
12. Абдуллаева, Б. (2014). Диалектическое видение эстетического компонента в дизайне. *Credonew*, (3), 14-14.

13. Абдуллаева, Н. Б. Дизайн как фактор формирования культурного пространства. Фалсафавахукук, 2/4/2017, 70-72.
14. Tuyboevna, K. S. (2020). Interactive method – one of the most popular types of today’s pedagogical technologies. European Journal of Research and Reflection in Educational Sciences, 8 (11), Part II, 83-92.
15. KarimovaSanobarTuyboevna. (2020). Using the educational electronic resource phet in the teaching of physics. ACADEMICIA: AnInternationalMultidisciplinaryResearchJournal. 10 (6). 1424-1426.
16. KarimovaSanobarTuyboevna. (2021). About the use of interactive method and phet electronic resource in educational process. MiddleEuropeanScientificBulletin, 8. <https://doi.org/10.47494/mesb.2021.2.164>





DOI: **10.5958/2249-7137.2021.01255.6**

## THE ROLE OF SMALL BUSINESS IN THE DEVELOPMENT OF THE SERVICE SECTOR

**Mahmudova Nozimakhon Baxriddinxonovna\***

\*Lecturer,  
Department of Social Sciences,  
Namangan Engineering-Construction institute,  
UZBEKISTAN

### ABSTRACT

*This article discusses the concept and essence of service activities. The activities of small businesses in the service sector were analyzed. Innovative forms of small business organization in the service sector have been studied.*

**KEYWORDS:** *Service, Small Business, Innovation, Franchising, Market Economy*

### INTRODUCTION

The colossal effect of using small business as a market instrument abroad has been noted for a long time. The phenomenon of its influence on the political, economic, social and technological development of the country and the ability to stabilize the processes taking place in these areas is receiving close attention.

Small business mitigates the consequences of structural changes in the economy, quickly adapts to changing market requirements, makes a significant contribution to regional development, and has the ability to generate and use technical and organizational innovations. Organically linked with big business, it is the basis for the country's sustainable development and increasing the competitiveness of its economy. Small business plays a special role in the development of the service sector, which serves as a kind of indicator for assessing the level of economic development of any country.

The relevance of the chosen topic does not raise doubts, since at the present stage one of the main trends in the development of the economy is advanced development of the service sector, which predetermines the constant search for its quantitative growth and qualitative improvement. An important role in solving these problems is assigned to small business, which, by its very nature, is able to flexibly respond to the needs and demands of the service market, better and

sooner saturate it with high quality services. In this regard, it is becoming increasingly important to create a small business management system in this area, as an objective necessity for the country's further movement along the path of economic and social progress.

Service activity is a type of activity aimed at meeting the needs of people through the provision of individual services. Service activities are carried out by individual entrepreneurs and service organizations. The result of their labor is service. A service is a product of labor, the purpose of which is to meet the specific needs of people.

The service is the result of direct interaction between the contractor and the consumer (customer), as well as the contractor's own activities to satisfy the needs of a person. A service is an activity aimed at satisfying the needs and requirements of people.

This activity can be embodied in products (material services) or exist as a useful effect of labor consumed in the labor process itself (non-material services). For example, the service of a tailor is that he sews a suit. The transformation of the material into a suit is the tailor's service. The tailor's activity is embodied in a suit (material service).

An important feature of a service is a useful action for the consumer, and this action can be provided by both living labor (intangible service) and labor embodied in a tangible product. This is the fundamental purpose of services, their social function - direct service to the population, creating comfortable living conditions: in transport, in public places, during rest.

The useful effect of a service is a set of useful properties of a service, directly aimed at satisfying a particular human need.

A consumer of a service is a citizen who receives, orders or intends to receive or order services for personal needs.

Service provider - an enterprise, organization or entrepreneur providing a service to a consumer.

The result of the service is the restoration (change, preservation) of the consumer properties of the goods, the creation of a new product by order, the movement, the creation of conditions for consumption, the provision or maintenance of health, the spiritual or physical development of the personality, the improvement of professional skills.

In serviceology, there are concepts of ideal and real services. An ideal service is an abstract, theoretical model of a particular type of service activity. It includes the rules for serving the population, quality standards, technology for the provision of services.

A real service is a specific material action aimed at meeting the needs of the consumer. These services are individualized for performers, consumers, specific conditions for their provision.

Service organizations provide material and socio-cultural services. Material services are services that satisfy the material needs of people. Material services provide the restoration (change, preservation) of consumer properties of products or the manufacture of new products according to the orders of consumers, as well as the movement of goods and people, the creation of conditions for consumption. In particular, material services include household services (services for the repair and maintenance of products, buildings and structures, photography services, hairdressing services), housing and communal services, catering services, transport services, agricultural services, and so on.

Social and cultural services are services that satisfy the spiritual, intellectual needs of people and support their normal life. Social and cultural services ensure the maintenance and restoration of health, the spiritual and physical development of the individual, and the improvement of professional skills. Social and cultural services include medical services, cultural services, tourism and education.

The result of material services is the work or product performed. The result of social and cultural services (services proper) has no material form (the result of tourist or excursion services).

Material and socio-cultural services are complementary. Often the purchase of goods is accompanied by the consumption of services (for example, after-sales services), and the consumption of services is accompanied by the purchase of related goods. For example, when consuming public catering services, a consumer receives a product - food products, a place of consumption of food products, a service for serving food and drinks, and psychological relief.

Services are provided to consumers in the process of servicing. The provision of a service is the activity of the service provider necessary to ensure the performance of the service. The provision of the service is divided into separate stages: provision of the necessary resources, the technological process of execution, control and evaluation, the process of service. Services are inseparable from consumers and performers.

The service life cycle is divided into several stages:

- 1) Provision of information on services offered to consumers;
- 2) Acceptance of an order for a service;
- 3) Performance of the service;
- 4) Quality control of the performance of the service;
- 5) Issue of the order to the consumer.

The interaction between the consumer and the service provider takes place in the process of service. The nature of the interaction depends on the form of service provision and can be direct (face-to-face) and mediated (correspondence). With direct interaction, there is a direct contact between the contractor and the consumer, and with indirect interaction, the contact can be carried out through intermediaries or auxiliary personnel of the service provider.

Service is the activity of the service provider in direct contact with the consumer. The service process is provided by means of production and personnel of the service organization. The service includes the analysis of the consumer's order, the development of projects for the provision of services (technical specifications and the process of rendering services), the search for compromise solutions in the conditions of the multivariance of methods of providing services, the establishment and provision of the required quality of the service, coordination, registration and delivery of services to the consumer.

The efficiency of the service enterprise depends on the correct organizational and management activities of the managers.

Organizational and managerial work includes:

- planning the service activities of the organization, forecasting the development of the organization when the market or the range of services changes;
- Assessment of production and non-production costs;
- optimization of the composition of technological equipment and technical means, taking into account the range and level of quality of services;
- organization of the contact area for communication with the consumer of the service;
- selection of employees with psychological abilities to work with consumers.

Thus, the service activity is a complex multifaceted process, which is ensured by the competent management of the personnel and resources of the enterprise, the observance of the requirements of service standards, and the correspondence of the services provided to the requests of consumers.

#### REFERENCES:

1. Кулибанова, В.В. Маркетинг сервисных услуг / В.В. Кулибанова. – СПб.: Вектор, 2006. – 192 с.
2. Лапуста, М.Г. Малое предпринимательство: учебное пособие; 2-е изд. / М.Г. Лапуста, Ю.А. Старостин. – М.: ИНФРА-М, 2002. – С. 68Гэлбрейт Дж. Экономическая теория и цели общества. М.: Прогресс, 1976.
3. Nafosat, Z., Nasiba, A., Ozoda, N., Baktior, D., &Enajon, N. (2019). Interactive strategies and methods of education.
4. Abdullaeva, N. B. (2015). THE ESSENCE AND CONTENT OF THE AESTHETIC COMPONENT IN DESIGN. ISJ Theoretical & Applied Science, 9(29), 169-171.
5. Ёкубжанова, Х. Ё., Байтураев, О. У., &Умарова, Г. Ш. (2016). Проблемы привлечения инвестиций в экотуризм. Молодойученый, (4), 327-329.
6. Yokubovna, Y. H. (2019). Evaluation of the economic impact of local population in the development of regional economy: an example of Chadak village. American Journal of Economics and Business Management, 2(3), 83-93.
7. Tuyboevna, K. S. (2020). Interactive method – one of the most popular types of today’s pedagogical technologies. European Journal of Research and Reflection in Educational Sciences, 8 (11), Part II, 83-92.
8. KarimovaSanobarTuyboevna. (2020). Using the educational electronic resource phet in the teaching of physics. ACADEMICIA: An International Multidisciplinary Research Journal. 10 (6). 1424-1426.
9. KarimovaSanobarTuyboevna. (2021). About the use of interactive method and phet electronic resource in educational process. Middle European Scientific Bulletin, 8. <https://doi.org/10.47494/mesb.2021.2.164>

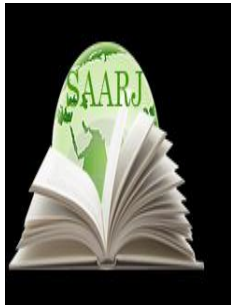

**ACADEMICIA**  
**An International  
 Multidisciplinary  
 Research Journal**  
 (Double Blind Refereed & Peer Reviewed Journal)

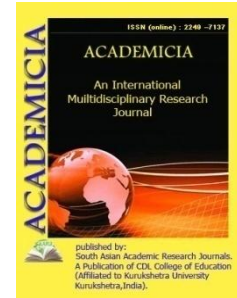

**DOI: 10.5958/2249-7137.2021.01251.9**

## SOCIAL FACTORS OF ENTREPRENEURSHIP SUPPORT IN UZBEKISTAN

**Qozoqov Sobirjon Zokirovich\***

\*Independent Researcher

Namangan State University, UZBEKISTAN

Email id: sqozaqov@mail.ru

### ABSTRACT

*The government's encouragement to support business activities in Uzbekistan is analyzed in this article. The aim of the article is to investigate the objective reasons for the role of the government in promoting business affairs and examine the conditions created by the state and socio-economic directions of the business in the context of ongoing reforms. Additionally, the writer emphasizes the contribution of enterprises that are embarking on new innovations, due to which export capacities can be increased. In a state of market economy, Uzbekistan has paid great attention to establishing entrepreneurial activities. In turn, this has required the foundation and improvement of property relations, which are considered as the legitimacy of market relations and entrepreneurial activities. Indeed, entrepreneurship is thought to be the driving force of every society's economy. Moreover, small business and entrepreneurship is the most flexible area in technology and management plans which helps adapt to minimum losses and respond to changes in market relations.*

**KEYWORDS:** *The Government, Entrepreneurship, Export, Innovation, The Monopolization Of The Economy, The Promotion Of Business By The State, Credits And Investments.*

### INTRODUCTION

Business holds an important role in each and every society. Therefore, supporting business affairs is one of the crucial activities of the government. As business affairs are the main income stream of all members of the community because of which every country encourage entrepreneurship consistently. Promoting businesses motivates entrepreneurs, the reason is that feeling the sense of trust towards the government, their business with the deep proprietary responsibility. Thus, some research is required in promoting entrepreneurship by the

government. The core of this study is to scientifically investigate the social indicators of governmental support for entrepreneurship in Uzbekistan.

Social indicators of the support for the entrepreneurship is characterized with host of objective reasons. Firstly, the fact that it has been less investigated in Uzbekistan, in the sphere of sociology, makes business activities more extensive for analysis. Secondly, the outcomes of investigations can be the practical and analytical base of state support for business activities in Uzbekistan. Thirdly, in the field of study, conducting research of governmental encouragement and examining the essence, makes it possible to designate the prospective directions of socio-economic processes in the course of ongoing reforms.

In a state of market economy, Uzbekistan has paid great attention to establishing entrepreneurial activities. In turn, this has required the foundation and improvement of property relations, which are considered as the legitimacy of market relations and entrepreneurial activities. Indeed, entrepreneurship is thought to be the driving force of every society's economy. Thus, depending on the capabilities, every country boosts entrepreneurial affairs. Private entrepreneurship is considered one of the key sectors of our economy and ensures the socio-economic stability, therefore, in the Republic of Uzbekistan, governmental encouragement for business affairs can be carried out in the following procedure:

Supporting at the expense of the state budget

Supporting at the expense of different associations and funds

Supporting at the expense of subsidy or giving facilities in the credit system

Supporting with providing with information

Provision in regional economic and social programs

Moreover, small business and entrepreneurship is the most flexible area in technology and management plans which helps adapt to minimum losses and respond to changes in market relations. Small businesses and private entrepreneurship help to active innovations, development of regions, development of scientific and technical space prevent socio-economic problems, reduction of unemployment, as well as bring additional income to the public and opposes to monopoly.

For this reason, in the context of market relations, special committees and councils have been set up for the development of entrepreneurial activities and government support. They are as follows:

Reform and investment coordination center under the President of Uzbekistan. Budget and economic committee of Supreme Assembly. Special agencies such as state committee for demopolization, support for entrepreneurship. To provide state support for entrepreneurial activities in developed countries, there are several programs and organizations. For example, in the USA, small businesses are developed by National Science Foundation, established in 1973, which carries out small innovative firms and researches. The firm that passed the competition takes 50,000\$ for preliminary investigations for a half year. Upon successful completion, it receives 500,000\$ subsidy. At the same time, it helps small and large enterprises work jointly, that assists to be subsidized by large companies.

In comparison with the USA, Japan strives to implement new scientific works, there the cost Arge is twice as high. A common feature of Japanese national policy is to create financial incentives for small firms that are at the stage of scientific technology researches.

To make inventions, France founded a national agency which covers nearly 35 % small firms' expenses and 50% of the cost of introducing and mastering new technologies.

Support for entrepreneurship in Uzbekistan has been implemented with taking national characteristics of the population of our country into account. To demonstrate, in 2018 alone, according to the programs such as "Every Family is an Entrepreneur" or «Youth is Our Future" our government allocated two trillion sums to implement more than 2600 business projects. State support for entrepreneurship has a positive impact on the economic development of each country. For this reason, each state implements governmental programs. The essence of these programs is to increase entrepreneurial activity at higher rates. In the Republic of Uzbekistan, the above mentioned programs, "Every Family is an Entrepreneur" and «Youth is Our Future" were created on the basis of world experience to support entrepreneurial activities. To develop business activities, along with abovementioned state programs, it is good to implement the following programs:

Developing tax and financial incentives for exporting organizations. This, in turn, ensures that the price of the product remains cheap and helps have regular customers. Businessmen need to have more date on information structure, market conditions, the sales of goods and services and foreign buyers. Because the larger the database, the more information the entrepreneur has about the size of the product and the time of sending and the cost. Only when the businessmen organize their activities in this way, can there be an increase in their work.

Providing credits to private businesses to increase the export potentials. Since capital is necessary to encourage business activities. If only the businessmen have enough fund, there will not be any disruption in their work.

Encouraging innovations and business activity. The peculiar feature of business is the creation of the basis of new ideas and inventions. Therefore, it differs with the fact that it does not need a huge amount of money.

It is necessary to provide entrepreneurs with regular training in the field of foreign economic activity. This is because the entrepreneur studies the supply and the demand of the external market and thus guarantees the future of the business.

Based on abovementioned programs, state support for entrepreneurial activities helps implement encouragement policy as well as allows to do the following:

Keeping high employment rates and by this to increase the social stability and welfare of the population. As a result of implemented reforms in our country, this ensures able-bodied population to be employed in this sector. Contributing to decrease the unemployment rate, provides social stability in society, because of which the income of population will increase

Supporting the production of new types of products for the needs of society through the financing innovative ideas. Promotion of innovative ideas plays an important role in business. This, on the one hand, is not costly for small businesses which are testing innovative ideas. On the other hand, small businesses have the opportunity to rapidly change production processes.

Stimulating the inevitable processes. Funding is an important factor in the development of entrepreneurship. Therefore, the entrepreneur focuses on financing the profitable part of his business based on his own interests. This, in turn, will facilitate the further development of the production potential.

Based on the experience of developed countries, in our country, constitutional basis of supporting entrepreneurial activities were created and the President's decisions and decrees can be a typical example of this. It includes the President's decree "Improving the system of the support and protection of entrepreneurial activities" and the president's decision «Organizing the implementation of business initiatives and projects “. In particular, in previous years, large-scale work was done in the field of developing entrepreneurial activities and strengthening legal guarantees of the protection of the legitimate interests of the entrepreneur. In the first quarter of 2019, 16.4 trillion sum- credit was allocated to implement the projects of entrepreneurs, as a result the number of new established entrepreneurial firms increased 2.3 times.

Moreover, it was observed in the world experience that private business is one of the crucial factors that decide economic growth in developed countries. For instance, the contribution of small and medium-sized businesses in the gross domestic product of EU member states is 67%, in Germany 65%, in the USA it accounts for 52%. In Japan 80 % of the employed population are engaged in small or private businesses while it accounts for 70% in the European Union. Private entrepreneurship is an important sector of the economy of Uzbekistan. Today there are more than 525,000 businesses and it can be a good instance. The following innovators show that the majority of manufacturing sectors falls on business sector in our countries. The share of entrepreneurial activity in the gross domestic product has reached 60%. 78% of the population work in this area and develop this sector. It also accounts for one third of country's industrial output and 90% of agricultural output. In many other regions it accounts for 70-90%.

Tax policy is also important in supporting the economy of our country. That is because we can see some benefits by reducing the tax burden of entrepreneur:

Firstly - it will be uncommon for an entrepreneur to hold income. This leads to high taxes paid by entrepreneurs.

Secondly- the entrepreneur starts his business with a new type of activity. For example, it provides new opportunities for entrepreneurs to engage in virtual activities in a new type of business that is needed for our country. The trend of emergence of modern markets, globalization of markets, the significance of the increasing prices, their costs and the rate of customers' need, the importance of the relations with consumers and the utilization of information affect to this form of entrepreneurship.

Thirdly- the entrepreneur creates new jobs. In this way, entrepreneurs help our country solve social problems like unemployment and so on.

Taking these factors into account, special attention was paid to the tax policy of our country with the help of our country's President's Shavkat Mirziyoyev the entrepreneurs received tax incentives and broadened their activity. The year 2019 has already been successful in this sphere. For example, the income tax on individuals doubled to the state budget. Additional



571,000 tax payers were identified at the beginning of the year. Also, the reduction of value added tax from 20% to 15% as of October 2019 is an opportunity for entrepreneurs.

To summarize, many opportunities have been provided to our entrepreneurs after Independence. That is because the ownership layer is the main driving force of the economy in the context of market relations. We can see it on the example of developed countries in the world. Therefore, the support of private entrepreneurship in the country increased to the level of state policy. The working population, the largest share of gross domestic product and the main part of investments are in this sector.

It is also important to organize entrepreneurship based on centuries-old national handicrafts in our country. Because they allow us to pass our national values to future generations. Important festivals or conferences are organized by the government. International Handicraft festival was held between 10 and 15th September of 2019 in Kokand, Fergana region. This can also indicate that craft-based entrepreneurship is supported and our national traditions are becoming widespread.

Based on the above, it is advisable to implement the following recommendations to improve further entrepreneurship support:

For the improvement of protection of intellectual property rights to support innovations in entrepreneurial activity. Because entrepreneur creates and implements innovations throughout his or her career and meets the financial and emotional needs of the members of society. For this reason, it is expedient to protect the intellectual rights of entrepreneurs.

Establishment of specialized organization for the legal and financial support of private entrepreneurship activity. It is advisable to establish financial, organizational and improved banking business advisory centers in our country.

Establishment and development of infrastructure to support private entrepreneurship. Material and technical support of an entrepreneurial activity contributes to its development and the strengthening of its faith in the future.

Development of a credit system for the development of private entrepreneurship. The business is directly related to the financial and credit system. It would be advisable to establish entrepreneurs' branches of the bank, because it helps the businessmen find the solutions to the problems that await them, while saving their excessive time.

Further simplifications of the registration system and taxation of private business, etc.

It is clear that in our country particular attention is paid to the organization and support of entrepreneurial activity. Because the more business people in our country, the better the economic welfare of the country along with the economic performance of the country. And this is one of the important factors that will help our country gain a foothold in the world community.

#### **THE LIST OF USED LITERATURE:**

1. "Foreign experience of supporting small business" URL: <https://www.bestreferatru/referat-217239.html> (20.11.2019)

2. Mirziyoyev Sh. “Address to the Supreme Assembly” the newspaper «People’s word”. 29th December in 2018. № 271-272
3. President’s decree “On measures to radically improve the system of the support and protection of entrepreneurial activity. URL:<http://uza.uz/oz/documents/tadbirkorlik-faoliyatini-qollab-quvvatlash-va-himoya-qilish-tizimi-15-05-2019> (22.11.2019)
4. Usmonov Q. “The history of Uzbekistan”. “Teacher publishing house” – Tashkent 2008. B-144
5. Mirziyoyev Sh. “We will continue our national entrepreneurship path to a new level”. Tashkent –Uzbekistan-2018. B-68
6. Mirziyoyev Sh. “Address to the Supreme Assembly” “the newspaper People’s word”. 29th December in 2018. № 271-272
7. Tax policy. The changes are aimed at supporting entrepreneurs URL: <http://uza.uz/oz/business/soliq-siyosati-ozgarishlar-tadbirkorlarni-qollab-quvvatlashga-qaratilgan-30-09-2019> (25.11.2019)
8. <http://www.sba.gov/adousba/> - Administration of Small Business under the President (Small Business Administration - SBA)
9. Small business: foreign experience. <https://msb.khabkrai.ru/malyi-biznes-zarubezhnyi-opyt/>
10. The role of small business and private entrepreneurship in the innovative development of the Republic of Uzbekistan. <http://www.biznes-daily.uz/ru/birjaexpert/65421-rol-malogo-biznsa-i-chastnogo-prdprinimatelstva-v-innovativenom-razvitii-presidentialuzistan>
11. H. Hamroev. Basics of business. New Edition, Tashkent-2010. Page 127.
12. Sh. Baeva. Foreign experience of financing small business and private entrepreneurship. // Economics and Education. No. 3. Page.
13. Lapusta M. G. Maloe predprinimatelstvo: Textbook. -M .: INFRA-M, 2008. p. 23-24.
14. A. Groth, K. Bhasin. 18 Amazing Facts About Small Businesses In America. Business Insider, 2011.
15. O.A. Aripov. Development of small business and private entrepreneurship in foreign
16. Lapusta M.G. Maloe predprinimatelstvo: Textbook. -M .: INFRA-M, 2008. p. 512.
17. <http://www.mispnsk.ru/articles> // Small Business: international experience. 2012.

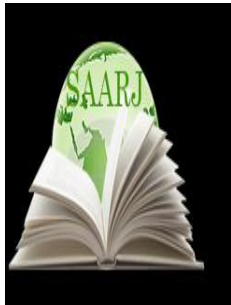

**ACADEMICIA**  
**An International  
 Multidisciplinary  
 Research Journal**  
 (Double Blind Refereed & Peer Reviewed Journal)



**DOI: 10.5958/2249-7137.2021.01264.7**

## THE WORLD IMPORTANCE OF THE TEACHINGS OF KHOJA AHROR VALI

**Rakhmatova Kholida Kholikovna\***

\*Associate Professor of the Department "Social Sciences",  
 candidate of philosophical Sciences,  
 Buxoro Engineering - Technology Institute,  
 UZBEKISTAN

### ABSTRACT

*Each religion in its time made a sharp change in the thinking of people, turning the principle of the realization of the desire and happiness of living on the basis of divine blessings into a way of life. However, the role of the Islamic factor in the current situation, which has escalated the conflict of interests between the states and the regions, is significant.*

**KEYWORDS:** Religion, Humanism, Khoja Ahror Vali, Value, Spiritual Heritage.

### INTRODUCTION

Referring to this historical process, the president of the Republic of Uzbekistan Sh.M.Mirziyoev said at the 72nd session of the UN General Assembly “we consider it the most important task to convey the true humanitarian essence of Islam to the world community. We value our sacred religion as an expression of the incarnation of our age-old values. We strongly condemn those who put our holy religion in a row with violence and bloodshed, and we will never be able to reconcile with them. The religion of Islam encourages us to peace with kindness, to preserve the original human qualities. I would like to emphasize the invaluable contribution of many bright figures of the period of Central Asia to Islam and world civilization”, he said.

Today, thanks to the happiness of self-awareness, we have been eager to study the life, activities and creations of the great saints, who have grown up on the ground. Among such great leaders, Khoja Ahror Vali's services before humanity were also recognized. Khoja Ahror was a scholar who lived and worked in the time of the crown prince - Temurids, had his place in the development of the Eastern philosophical thought of the XV century, was a great representative, reformer and follower of the doctrine of naqshbandia, made a worthy contribution to the transformation of naqshbandia into a world doctrine.

One of the greatest services of Khoja Ahror Vali is his contribution to the transformation of the doctrine of naqshbandia into the world doctrine. It is impossible to imagine the socio-political, religious - scientific and ideological scenes of Movarounnahr and Khorasan in the XV century without the image of the first-class naqshbandi pir-Khoja Ubaydullah Ahror Vali. On the one hand, Khoja Ahror Vali was the leader of the sect – Khoja Bahouddin Naqshband's faithful caliph of that time, on the other hand, if he was a religious figure who fought for the stability of the hanafi sect with all his body. If it is permissible to interpret, in the ideological regions of the Timurids' principality it is the commandment of the coming into the world of an idea without judgment and permission. On the third hand, one of the great services of Khoja Ahror Vali – those who made a worthy contribution to the transformation of the doctrine of naqshbandia into a world doctrine.

On these services of the teacher, Alisher Navoi thought in the work “Nasayim – ul muhabbat”, glorifying the person not only in Movarounnahr, but also in Khorasan, Iraq, Azerbaijan, even Rum and Egypt, China and India as a great representative of the famous sheikh, orif, coach, teacher and mysticism teachings. In the game it is called: “Ҳазрат Хожаға онча мукнат даст бердики, маълум эмаски, машойихдин ҳеч кимга ул даст берибдур, ё йўқ. Мулкка ажаб исило ва салотин ва мулукка ғариб исрофу ҳукм, Мовароуннаҳр салотини ўзларин аларнинг муридзодалари ва маҳкуми ҳукми тугорлар эрди. Йўкки, ёлғиз Мовароуннаҳр салотини, балки Хуросон ва Ироқ ва Озарбайжон, ҳаттоки бир соридин Рум ва Мисрғача ва бир соридин Хито ва Ҳиндғача барча мулук ва салотин ўзларин Хожанинг маҳкуми ҳукми ва маъмури фармони тугорлар эрди ва руқбалари бу салотинга онча муассир эрдиким, аларнинг аҳкоми ўз худдомиға бўлмағай ва Ҳазрат Хожага зоҳир жамияти барча абнои замондин кўпрак воқеъ эрди”.

In every Egypt written by Alisher Navoi, there is a sense of world. This means that Khoja Ahror's services in spreading the world of the sect of pattern making are matter of study. Professor Alexander Knish in his book “Musulmanky misticism” separately notes the role of Khoja Ahror in the penetration of non-materialism in Iran and Turkey. In the north west of Iran, the pattern of knitting is slowly spreading in relation to Movarounnahr and Herat. In the city of Kazvin, located in the north west of Iran, the disciple of the sect was sheikh Ali Kurdiy, the disciple of Khoja Ahror Vali.

The teaching of knitting began to spread among the Western Turks a century after the death of the Great founder of the sect, naqshband. This pattern has been a very important step in the way that the banditry deviates from the Movarounnahr circle. In the kingdom of the Usmons, the naqshbandian sect was able to attract a large number of supporters among the Turkish population in the short term, which led to the loyalty of Islam to the direction of sunnism, consistent adherence to sharia traditions.

In Turkey, the first propagandist of the sufism methods of naqshbandia was Mullah Abdullah Ilohi Samovi (death 1490). He studied in the Khoja Ubaydullah Ahror in Samarkand. At the end of his education, Mullah Abdullahi Ilahi spread the sect in the city where he was born for several years, and then in the Istanbul. Zeyrek was one of the first in mosque and established the center of naqshbandiya and attracted many supporters of the sect. Nevertheless, Mullah Abdullah had the choice to live in the divine and preferred to devote himself to the religious sciences. The disciple of the divine Amir Ahmad Bukhari(v.1516). Since the time of the divine presence in Samarkand, Khoja sought to take Ahror lessons from Murshid.

Amir Ahmed Bukhari's movement laid the foundation for three centers of knitting and the ranks of the sect were filled with many scholars and writers. One of them was Mahmoud Lali Chulobi (death 1532y) from the city of Burs. The center, founded by Buhari, operated until the beginning of the twentieth century. Another disciple of Khoja Ahror in Turkey was grandfather Heydar Samarkand (death 1550y). Since he had the honor of Sultan Suleiman Kanuni, the Sultan gave the man a tekka in Ayyub. This center was destroyed by fire in 1912 year. The center was in its time a settlement where the Sufis from Central Asia settled. From those times, the names of tekkas "Bukhara", "Qashgar", "Uzbeks" were still preserved. Among the sufis from Central Asia, there was also a treasury. In India, the pattern of knitting began to spread from the XV century.

Khoja Ahror achieved a certain degree of reformation and especially socialization of the teaching of naqshbandiya, and in its composition also established its branch named "ahroriya". Through the mutasavvif and his followers, the doctrine of naqshbandia came out of the Movarounnahr territories and penetrated into the territories of Khorasan, the Caucasus, the North Caucasus, the Usmon Turks, India (along with present Pakistan). In particular, the connection of historical figures such as Jami, Navoi and Hussein Boyqaro to Khoja Ahror was a great event for the teaching of naqshbandi. In a short period of time, the teaching of naqshbandiya was studied separately in the studies of the Sufi scientist Jafar Holmominov, who as a result of the activities of Ahmad Sarhindiy, famous for the name of Khoja Ahror Vali and the bishop of the Indian naqshbandiy – Imam Rabbani, became a means of unification of representatives of different states and nationalities around a single ideology.

The spread of naqshbandi in India is associated with the name of Muhammad Zahiriddin Babur. Mirzo Babur calls the person "Mullo Bobo", hide the incomparable kindness in this word, which is said to be naive. In their memoirs, Mirzo Bobur writes about the fact that their father, Umarshayh Mirzo naqshbandiya, was the disciple of Khoja Ahror, the bishop of the sect, and they themselves recognized Khoja Ahror as a spiritual pir and received spiritual support from ul-zot.

Khoja Ahror's work "Anfosi Nafisa" is devoted to the statement of the issues that the people of the sect should follow. This treatise was also published in India along with the works of other thinkers. About the work "Risolai Validiya", the Afghan scientist Shafiq Bright wrote: "the theme of the prose work" Risolai Validiya "of Khoja Ahror consists in the purification of human appearance and botini and Abul Fazl Allomi considers it "the pearl of the sea of enlightenment". The author of the work "Masmuot" Mir Abdulavval came from Nishopur and for seven years they will be in the service of Khoja Ahror and will study the science of tariqat. Mir Abdulavval managed to promote the world doctrine in Nishopur(Iran)with the direct help of Khoja Ahror.

Another Services of Khoja Ahror Vali – that man is famous as a reformer of the doctrine of knitting. Until the XV century, the people of mysticism did not go with the statesmen, each other. It is worth to say that the guard of honor is a strategic turn in the pattern, closely connected with the idea of reconciliation with the statesmen, the way of reconciliation, the transition from conflict to conflict, the active participation of the sufi in society. The way of conflict with the kings, revealed by Khoja Ahror Vali, led to an increase in sectarianism and prestige, and created an opportunity for the rulers to have a positive influence, to control their statehood activities on the basis of the criterion of justice for the citizens.

This event gave a social tone to the activities of Khoja Ahror Vali, turned the sectarian into a great public figure. And the sect connected with society and secular life, becoming a great socio-political force. Such a look was a reform in the pattern. The event of disagreement with the kings came from the motto of naqshbandi "dialogue", Khoja Ahror Vali developed it and raised it to the level of active participation in socio-political life, participation in public affairs.

Above we have mentioned Khoja Ahror Vali as a continuation of the doctrine of knitting. It is in this place to recognize the great services of Khoja Abdulkhalik Ghijduvani in the history of sufism, who laid the foundation stone for the doctrine of khodjagon. By means of the sect of khodjagon, he generally coordinated the sect with the sunnah of the Prophet Muhammad, cleansing it from various heretics and superstitions. The observance of the sharia turned the abstinence from it into the main rule. Abdication world having rejected nook, made it obligatory to be with the church.

Allah has called on not to give up the world as love. The honesty of the bite is defined as the main desire of the sect that everyone should see the day with his own efforts. This sect does not approve of extremes as fear. The issue of morality has been firmly established. All this became important in the development of mysticism. Bahouddin Naqshband is famous for giving a ratio "Dil ba yoru dast ba kor!" Let your hand be at work with a heartfelt heart felt. It is also not surprising that the slogan as an idea was originally put forward by Abdulkhalik Ghijduvani. Khoja Bahouddin Naqshbandi, who was brought up from Abdulkhalik Ghijduvani spirit and founded the naqshbandiya sets band this slogan was adopted as the main rule of his sect (the story is that Naqshbandi himself grew up from the khodjagon sets and is referred to as khodjagon-naqshbandi, and Abdulkhalik Ghijduvani is considered his initiator (Sarhalkai silsila). The real-life conditions of khodjagon-naqshbandi, the fact that it is based on the existing capabilities of a person, indicate that it is a solid sect with a floor that meets the demand of all times and all strata. The fact that Abdulkhalik, who has been subjected to sharia and without superstitions and defects, has been recognized as an acceptable document for centuries and in all groups, and the reasons why the khodjagon-naqshbandi sect, which is widely spread in Turkestan, Iran, Afghanistan, India, Turkey, Iraq and even in North Africa, is now functioning in many countries of the world.

The services of the outstanding Abdulkhalik Ghijduvani and Khoja Ahror in front of our people are very friendly to our history, today the philosophical and social views of the outstanding, the advice of great importance in the integration of ideas that inspire kindness and spiritual perfection in the hearts and minds of the younger generation. At present, recognizing the services of our great ancestors and thinkers directly in respect of the doctrine of knitting in different parts of the continent as a progressive spiritual doctrine is a symbol of boundless respect for them.

#### REFERENCES:

1. Мирзиёев Ш.М. Танқидий таҳлил қатъий тартиб интизом ва шахсий жавобгарлик ҳар бир раҳбар фаолиятининг кундалик қоидаси бўлиши керак. – Тошкент: Ўзбекистон нашриёти, 2017 йил. -104 б.
2. Мирзиёев Ш.М. Миллий тараққиёт йўлимизни қатъият билан давом эттириб, янги босқичга кўтарамиз. – Тошкент: "Ўзбекистон" НМИУ, 2017. – 1-жилд. – 592 б.
3. Мирзиёев Ш.М. Миллий тикланишдан - миллий юксалиш сари. – Тошкент:

- Ўзбекистон, НМИУ, 2020. 4-жилд – 456 б.
4. Ўзбекистон Республикаси Президенти Шавкат Мирзиёевнинг Ўзбекистон ёшлари форумида сўзлаган нутқи // Халқ сўзи, 2020, 26 декабрь.
  5. Ўзбекистон Республикаси Президенти Шавкат Мирзиёевнинг Олий Мажлисга мурожаати // Халқ сўзи, 2020, 30 декабрь.
  6. Navruzova G.N. Khojagon education and the specifics of this way. ACADEMICIA An International Multidisciplinary Research Journal. ISSN: 2249-7137 Vol.11, Issue1, January 2021 Impact Factor: SJIF 2021=7.492 1131-1137.
  7. Navruzova G.N. Bahauddin Naqshband-the seventh pir of Bukharai Sharif (Noble Bukhara). Islom tafakkuri (Maxsus son) 2020. B. 5-8.
  8. Navruzova G.N., Ubaidova V.E. Pharaoh of the weavers of Bahauddin Naqshband. Academicia. An International Multidisciplinary Research Journal. Vol. 10 issue 5, May 2020. Impact Factor: SJIF 2020=7.13. 922-926 pages.
  9. Наврўзова Г., Зоиров Э. Бухорои Шарифнинг етти пири. Тошкент: Muharrir, 2018. 80.
  10. Наврўзова Г.Н., Рахматова Х. Нақшбандия тушунчалари генезиси. Бухоро: “Бухоро, 2010. 150 б.
  11. Назаров Қ. Жаҳон фалсафаси қомуси. 1-китоб – Тошкент: «Маънавият» нашриёти, 2019. – 920 б.
  12. Назаров Қ. Жаҳон фалсафаси қомуси. 2-китоб – Тошкент: «Маънавият» нашриёти, 2019. – 856 б.
  13. Хожа Убайдуллоҳ Аҳрор. Фақароту-л-орифийн. Табаррук рисоалар../ Таржимонлар Маҳмуд Ҳасаний, Баҳриддин Умрзоқ, Ҳамидуллоҳ Амин. Т.; Адолат. 2004. – Б. 13.
  14. Саъдиев Садри. Нақшбандия тариқатининг улуғ ислоҳотчиси. // Сино. –Тошкент, 2004. -№ 13. – Б.21.
  15. Холмўминов Жаъфар. Ваҳдат ул-вужуд фалсафаси ва Нақшбандия таълимоти (Ибн-ал-Арабий, Хожа Муҳаммад Порсо, Хожа Аҳрор Валий ва Мавлоно Абдурахмон Жомий қарашлари асосида). Монография. / Масъул муҳаррир: Н.Жўраев. – Т.: “Yangi nashr”, 2020. – 324 бет.
  16. Алишер Навоий. Насойим – ул муҳаббат. Т.2001. 20 – томлик. 17-том. 280 – б.
  17. Кньш А.Д. Мусульманский мистицизм. Москва – Санкт-Петербург. “Диля”, 2004 г, 254 стр.

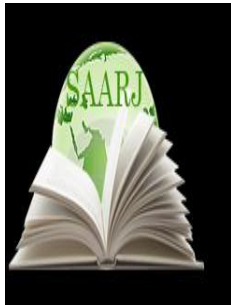

**ACADEMICIA**  
**An International  
 Multidisciplinary  
 Research Journal**  
 (Double Blind Refereed & Peer Reviewed Journal)



**DOI: 10.5958/2249-7137.2021.01265.9**

**ABOUT THE OBJECTS OF CULTURAL HERITAGE AND THE STATE  
 OF THEIR PRESERVATION IN THE 20-30 YEARS OF THE XX  
 CENTURY (EXAMPLE OF FERGANA VALLEY)**

**Mansur Mahmudov\***

\*Teacher,  
 Namangan State University,  
 UZBEKISTAN

**ABSTRACT**

*In this article, an analysis of the objects of cultural heritage in the Fergana Valley in 20-30 years of the XX century and the state of their preservation is given. In various sources in Namangan and Fergana regions, information about mosques and madrasahs in Turkistan, which were built by Muslims and functioning as scientific centers, was given.*

**KEYWORDS:** *Mosque, Madrasah, Tower, Caravan Palace, Culture, Cultural Heritage, Museum, Education, Sect.*

**INTRODUCTION**

It is known that in the appeal of the president of the Republic of Uzbekistan to the Oliy Majlis on December 29, 2020, it was noted that it is necessary to adopt a separate program to ensure the maintenance, preservation and protection of objects of cultural heritage[1]. Proceeding from this, it should be noted that today more than 8 thousand monuments of cultural heritage are registered in Uzbekistan.

It is known from history that during the Soviet period there was a misconception that every sample of local culture was accepted as backward and foreign. And in 1920-1930, politically incorrect slogans of the tribe of “national, socialist in content” and the decision “on the elimination of silence in architecture and construction” adopted in 1956 year were aimed at quickly putting artistic creativity and architecture into one common mold.

In its place it should be noted that the 20-th years of the twentieth century were a special stage in the study of the history of material culture of Uzbekistan. The committee on the preservation of monuments of art and nature, antiquity and museum works (Turkomstaris), which was established in 1921 under the people's education Commissariat of Turkistan, was of great



importance in this regard. In 1925 year, that is, after the conduct of the policy of national state borders, this organization was called Sredazkomstaris (on the territory of Central Asia), and it operated until 1928 year. Thanks to the efforts of this organization, a number of works have been carried out on preservation of material and cultural monuments of Central Asia, Study of their history and organization of museum Affairs.

It is important that not only Russian scientists, but also National intellectuals could actively work with them in the identification and restoration of historical-cultural monuments. Because they correctly understood that the historical past of the nation will reach the next generation through its material and spiritual monuments. Important work has been carried out to study the history and state of construction of historical monuments existing in the country by nationalists who are part of scientific expeditions organized by this organization. They published their observations in the form of articles of reporting quality. It is also necessary to emphasize the service of the national press in this regard. Because, they had become the pulpit of the intelligentsia, which protects the interests of the nation, which appeals to the people, who died for the development of society.

In particular, the magazine “education and teacher”, which is owned by the people's education commissariat, published in these years, gained a special place in the press of that period not only a number of articles devoted to the issues of public education, but also the development of Turkistan culture and spirituality. On the pages of this magazine are the most prominent national intelligentsia of that period M. Abdurashidkhanov, Sh. Rahimiy, Fitrat, M. Saidjonov, Chulpon, Botu, G. Zafari and other progressives raised in their articles the problems of preservation and protection of the history, material and cultural heritage of the nation as the actual issues of their time, the analysis of them from the point of view of today was considered one of the important tasks.

For example, the famous progression M. Saidjonov's scientific article “the city of Bukhara and its old buildings” covered ancient monuments in Bukhara, which mainly covered historical places in the city, buildings and structures of the era of Ark, Shahristan, Registan, Somoni and Ashtarakanids were studied. This article by M.Saidjonov provides valuable information on the topography of Bukhara in the Middle Ages, the study of the history of some monuments in the city.

In this regard, it is also necessary to emphasize the article “examination of historical works in Uzgen” belonging to the pen of another progressivist Shokirjon Rahimiy. This author refers not only to handcrafted works under the guise of historical monuments, but also architectural monuments. It reflected the issues of the state of material and spiritual heritage in the country and the need for study. This article was published in the journal “Education and teacher”, enriched with photos. In this work, which was written as a report, the historical-geographical location of Uzgen, which was the capital during the Karakhanid period, the structures built there, especially the tower of XI-XII centuries, which was erected until the Mongol invasion, small tombs around it (in the article they are called Tombs – M. M.), information on sources and documents on the history of Uzgen is given that they also have significant scientific value for today's researchers.

For example, in the 1925 issue of the magazine "education and teacher", the following information was given about the city of Uzgen and its architectural monuments: "it is known that

Uzgen was a great city in Central Asia, and even if it was known on the dates that Fergana was the center of muzofot, now this city is known as a village Uzgen is a village in the north of Osh, between Osh and Jalal-Abad, which is very important on the trade route with the Qashqar region of Turkistan and China. Even if you go by car 25 km from Khanabad railway station on the Jalalabad railway and 45 km from then on, the first road is difficult as it is through a few large passes through Karadarya, which is the head of Sirdarya, and the 2nd Road is through a pass called 33 steppe.

In Uzbekistan there are 25 neighborhoods and its people are considered to be 7-8 thousand. There is also a nation close to Uzbek, whose people are Uzbek and Kashgar, a little bit Turkish (this people came to these sides 600-700 hundred years ago from Turkmenistan in their own words, and then stayed, "banned" from their horses and became Turkish suckers). In the village there is a caravan with several shops-a girls school, 2 land school (Shuroi), a club, a school of literacy, 2 co-operative shop. The air is even higher than that, it is incredibly pure and pleasant.

The landscape of the city is beautiful, on one side of which is the Black Sea and the beautiful hills that burn it, and then the snowy mountains stretch. But, it is not known to many people that the people of ABOM, upon being unaware of the culture, are due to the fact that he himself is on the verge from the center[2].

The village is incredibly rich in historical things, the buildings that are in it now, the works of the building that are found all the time under the ground, the old scrape and the coins show that there was no doubt a cultural land before (about this book the famous tourist Nushiravon in his touristic book the Sheikh rubbed this book without giving it three days). In addition to historic buildings there is now a churchyard consisting of 3 tombs, which improved in one great tower. It is about this book that the famous traveler Nushiravon in his travelogue asks in the content "the sheikh did this book without giving it 3 days ago".

Here in the last 32 years 27 bath, many abrasions and other instruments have come out. The Uzbeks call these midges "Popok midge". They take a lot of bricks that come out from under the ground and use them to the building.

The most famous in the old works of Uzgen is the huge minaret, which is longer than 25 gas. This tower is not currently connected to a mosque or a honeycomb, but around it is empty, on one side is a large embankment. On the one hand, where there is a bazaar, he stands alone giving his chest to the chest. The appearance is incredibly repulsive and dignified.

Although it is not clear when this minaret was built, it is suspected that it was built 700-800 hundred years ago in the form of old minarets laid before the arrival of Isfahan and the Mongols in the Marv from Uzbek ornaments and structural oil.

The tower remained in its old form until last year, standing unchanged. It was taken 43 years ago and made of millet. From the picture, too, it is clearly known that the head side of the minaret was extinguished, the bottom was cut and some of the husbands were in a state of a kiss. But in the last year (1923), a man called the son of Obid Rasul, who disappeared with six months of effort from may (if only he had been left in his own way) remount the minor. The kissed husband under the minaret was fixed by a Russian brick. On top of the 8 dacha dome was built, but left incomplete.

Walking from the great minaret to the south, there is a madrasah laid out a hundred years earlier than that. The people of Uzgan call it “the tombs of the Sultan”. Three tombs (tomb-small tomb, Sagana – M.) adjacent to each other, the back of which is turned to the east on Earth, which is the Tomb of Hazrati Sultan. M) there is. The shrines extend from the south to the North.

One of the tombs is the Tomb of Sultan Ilig, the other is the monument memory of Sanjar bin Malikshah, the middle one is the pea. Inside all three of the tombs there is also a tomb, similar to each other. But, to some extent, there are no gravestones. Now, when it comes to tombs, the northern and the southern tombs are very decorated with ornaments and patterns, and the middle is then placed in the middle, keeping both buildings (tombs) intact. The decoration of the building is artistically designed to amaze the mind, and the art that is in it makes the person interested for hours. The professor comrade who was next to us said that this art was not there except from the Tomb of the famous Ismail Somoni, who was on the side of Bukhara alone in the whole East.

The entire structure of the building consists of silt, earthenware and stones, and even if the structure was several hundred years old, the tops were completely demolished and demolished. But the patterns, on which the side is still solid, are an elegant form and a phrase from 1 lines, some of which are inscriptions in different forms, and some are made by observing the latest (fashionable) of the Eastern-style architect. The patterns and inscriptions on the surface of these buildings we divided into 14 parts and took samples from each of them. (That is, in order to check how beautiful the buildings are, it is necessary to pay attention to the picture put on it). The slats used in these buildings are in different molds, the smallest of which is in a simple match box, the largest of which is made by 4 contributions to an ordinary Muslim brick. But, the size of the knitting stalks goes up to 4 meters with jam. I must also say that the patterns of the building are completely on the surface and on the side of the view, slightly decorated with a hollow. But the sides and the back are in a simple mold[3].

When it is mentioned about madrasahs at the end of the XIX – early XX centuries, it should be noted that they served as the first embodiment of Turkistan culture[4]. Madrasahs were secondary and higher educational institutions. In accordance with the conditions of his time in the madrasahs, various specialists of the field were trained, including mudarris, qozi, imam and mirzas, based on the needs of the people. During this period, young people who received education in madrasahs were educated together with religious and secular science, that is, as components of the unified science. According to the archival documents about Muslim institutions, in 1898 in the Turkistan region there were 452 mudarris and 7903 students in 348 madrasahs[5]. It can be concluded that no matter how much the Russian Empire resisted the opening of Muslim madrasahs for various reasons, their attempts did not yield in most cases.

However, such cases as the weakening and overthrow of the Tsar's power in the first quarter of the XX century, the transition of power into the hands of the Soviets, the overthrow of the national independence movement in the Fergana Valley have their negative impact on the development of madrasahs[4]. In particular, in the article titled “madrasa reform in Namangan” by the correspondent of the Turkistan newspaper, which operates under the pseudonym “Uzbek”, The views on the madrasah “Saidkulibek”, which is located next to the madrasah of Mulla Kirghiz in this city.

This article was written at the beginning of the 1920 years and is important in highlighting the policies of the Soviets in relation to Muslim madrasahs. When writing about the madrasah of

Saidkulibek, the author also gives information about the state of the psyche of other madrasahs of that time in the article. In accordance with his comments, madrasahs described him as having hardened his condition during this period as frozen rivers in the North, having become silent as cemeteries in terms of their spirituality, while recognizing that they were deprived of the rights necessary for them to function in accordance with the requirements of the times in the following centuries, they were left behind for various It also shows that madrasahs became a place where specialists, including engineers, doctors, scientists, etc., needed for their period, instead of growing up, surrounded their bodies with spiritlessness, the body grew weak poppies[4].

From author's views on this matter, it can be seen that the madrasahs were somewhat behind the social life as a result of the fact that initially the Tsar rulers, and then the Soviet authorities looked at the madrasahs of Muslim countries with a low point of view, tried to eliminate them as a furnace of superstition and declared the properties of the

In the information about mosques and madrasahs in Turkestan, which were built by Muslims in various sources and functioning as scientific and scientific centers, by the Soviet period they were converted to red soldiers as accommodation, horses as a stables[6], cultural places of recreation. For example, about himself "M.N." according to the information written by an unknown author who signed the contract, in 1925, the Kokaldash madrasah was rented to the leased cinema for thirty-three days with thirty-day fasting and a three-day committee on the condition that the Soviets left the equipment to the foundation[7]. The reason for this was the activity of the Soviets to form an atheistic worldview in the minds of people in relation to religion, Islam, and, consequently, all religions, as well as their view of our religious belief as an outdated idea, which is the basis of national education, as an old.

When writing about the madrasah of Saidkulibek, the author says that it was one of the oldest and richest madrasahs of Namangan. In the period after the October coup, the Taliban of the same madrasa became the head, and gathered the Taliban of the whole madrasa of Namangan into one association and supported the new government, providing many services. In those who have tried to attract other madrasahs to this work, too, many cannot achieve their goal, which causes resistance. At a later time, this Madrasah will come to life again, expressing confidence in the Soviet state and striving for the implementation of new reforms. The Taliban say Akromkhan Tara, who is in danger at Koson madrasah with the condition of introducing lessons in sciences and a number of other reforms to Madrasah, is in danger.

Observing such actions of the madrasa Taliban, the author observes their actions by drawing up new working plans, acknowledges that in 1917 the madrasa was also demanding the membership of some of their insiders in the legal courts, which caused the tragedies of young people, and that every effort of the eshons and the rich, who tried to return them, was also fruitless. Informing about the further activities of Madrasa, the author gives information about the fact that the Taliban recently held opening ceremony of the madrasa and began taking lessons with a six-day plan for the Week[4].

In place of the conclusion, the author addressed the taliban of madrasah and said that your initiative is to open the right way for our people to go out into the light in the future. But do not forget that the work of reform consists not only of taking lessons from two to three subjects per week. After that, you must continue in your own good work and enter into your program the various sciences that are necessary for our lives and completely cleanse the old superstitions

from the madrasahs and do not strive to find real educational nutrients for your soul, and also to immerse the foundation's work in ways that are useful in your own scientific and On this you need to set an example to others[4] – concludes his article with the comments.

In the sources, almost no other information on Saidkulibek madrasah in Namangan is encountered. Information about when, at what time, in what situation the madrasa was in crisis is unknown. Recognized as one of the oldest and richest madrasahs of Namangan during the initial period of the Soviet rule, this madrasah was destroyed by the order of the Soviets from 1930-1935 years.

#### REFERENCES:

1. Мирзиёев Ш. М. Олий мажлисга мурожаатномаси // Халқ сўзи. 2020 йил 30 декабрь.
2. Ш. Раҳимий. Ўзганда бўлган тарихий асарларни текшириш // Маориф ва ўқитувчи.
3. Маориф ва ўқитувчи. – 1925. – №1.
4. Ўзбек. Наманганда мадраса ислоҳати// Туркистон газетаси. 1922 йил 27 ноябрь. – №35.
5. ЎзРМДА. Ф. И-1. 18-рўйхат, 29-иш, 565–566 varaқлар.
6. DSCF3550 расм файл дисс. 27 бет.
7. М. Н. Мадрасада кино театр // Қизил Ўзбекистон газетаси. 1925 йил 9 апрель.
8. Ўзбек. Наманганда мадраса ислоҳати// Туркистон газетаси. – 1922 йил 27 ноябрь. – №35.
9. Sodikjonov, M. M. (2020). EDUCATION AS THE MOST IMPORTANT FACTOR OF HUMAN CAPITAL DEVELOPMENT. Theoretical & Applied Science, (4), 901-905.
10. Bobomurodovich, B. M., & Makhamadaminovich, S. M. (2020). Human capital is made in the family. ACADEMICIA: An International Multidisciplinary Research Journal, 10(2), 144-150.
11. Mahamadaminovich, S. M. (2020). THE ESSENCE OF SOCIAL CAPITAL CONSEQUENCES AND THEIR INFLUENCES TO THE MODERN SOCIETY. Вестник науки и образования, (2-2 (80)).

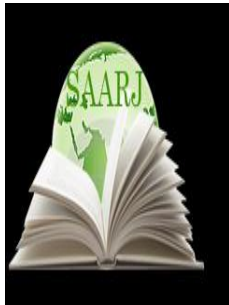

**ACADEMICIA**  
**An International  
 Multidisciplinary  
 Research Journal**  
 (Double Blind Refereed & Peer Reviewed Journal)



**DOI: 10.5958/2249-7137.2021.01266.0**

## TAX POLICY IN THE YEARS OF INDEPENDENCE IN UZBEKISTAN

**Omonov Izatillo\***

\*Teacher,  
 Namangan State University,  
 UZBEKISTAN

---

### ABSTRACT

*In this case, the tax structures in Uzbekistan, tax rates, the principles of setting tax rates, the transfer of corporate income to insurance funds, the main percentage of the state budget, the obligations of taxpayers, the legal framework and the tax code 'information is given.*

**KEYWORDS:** *Tax Code, Proportional, Progressive And Regressive Rates, Fiscal Function, Social Function, Regulatory Function.*

---

### INTRODUCTION

The origin of the tax is closely related to the emergence of the state. After the Republic of Uzbekistan also achieved its state independence, many reforms were carried out in order to reform its national tax system. The establishment of the state tax office of the Republic of Uzbekistan in our country in 1994 has literally started a new era in the formation of the national tax system.

1995-2005 years coincided with the stage of rational maintenance of the tax system, in this process the basis of the tax legislation of the Republic was laid and its legal base was strengthened. In 1997, the law of the Republic of Uzbekistan “on the state tax service” was adopted in order to give legal status to the activities of the bodies of the state tax service, to establish its legal bases and to clearly formulate the rights and obligations of taxpayers. In accordance with this law, the most important state duty is assigned to the state tax authorities as taxes and mandatory payments fall into the budget in full and on time. Also, in 1997, the tax code of the Republic of Uzbekistan was adopted as the only legal basis in the system [14].

Even in the current period, the problem of funding the tasks that the state performs comes out of the necessity of the tax burden.

The tax object is legal evidence that stipulates the obligation of the taxpayer to pay taxes. In 1998, paragraph 392(2) of the tax code of the Republic of Uzbekistan; in contrast to Article 89 of

the tax code of the Republic of Uzbekistan, it is said that the tax is “paid by individuals with property at their disposal”[2.95].

According to the method of recovery, the right and the curve are divided into tax. The correct tax is introduced directly into the property and income and is paid by the taxpayer without intermediate intermediaries. Common types: value added tax, income tax, inheritance and gift tax, turnover tax, sales tax, export tax and other curved tax (excise) the tax that is intended to be included in the prices or tariffs of goods (services) and which is subsequently loaded on the consumers of the goods according to the characteristics of the state system, the tax system consists of taxes and fees

There is also a tax deduction. Tax benefits are divided into two depending on the nature and nature of benefits [3.14]:

- 1) Tax exemption from taxes;
- 2) Taxable income tax;

The tax deduction is divided into three categories, depending on what is indicated in the accountant's account:

- 1) Permanent benefits;
- 2) Temporary benefits;
- 3) targeted benefits;

The legal basis of the tax system in the Republic of Uzbekistan, the rights and obligations of its payers, the procedure of tax proceedings 1997 24 April accepted at and 1998 1 January the tax code of the Republic of Uzbekistan, which is entered into from the tax code of the Republic of Uzbekistan. The general tax introduced in the Republic of Uzbekistan is the income (profit) tax from legal entities; income tax from individuals; value added tax; excise tax; tax for the use of underground resources; ecological tax; tax for the use of water resources. The general tax is distributed annually between the relevant budgets according to the norms established by the legal procedure. Local taxes and levies - property tax; land tax; advertising tax, tax on the sale of motor vehicles, social infrastructure development tax, levies for the right to trade; levies and other local taxes and levies for landscaping work are transferred to the local budget.

The tax levied by the state is redistributed through the budgetary means, and the socially necessary public services to taxpayers, such as health care, education, science development, defense, protection of rights, are returned by indirect means.

With the help of tax, the corresponding part of the national income is distributed and redistributed. Taxes levied by the state, as well as forms and methods of their organization together constitute the tax system. In the national economy, taxes perform the following three important functions:

1. financing public expenditure (fiscal function);
2. mitigation of social tension (social function);
3. the task of regulating (regulating) the economy.

Although public expenditure is carried out on the account of tax revenues, the increase in the volume of public expenditure, in turn, dictates the growth of taxes and determines its level. In the current period, the growth of public spending, which is a general trend, and, accordingly, the volume of taxes, are dictated by the following factors.

- Population growth.
- Increased demand and urbanization for the quality of services of the social sphere.
- Pollution of the environment.
- Implementation of programs to reduce income inequality.
- Increase in the volume of costs of national defense, state security.
- Tax regulation of the activities of enterprises is carried out on the basis of the following general principles:
  - the obligation to collect taxes from all incomes, regardless of their source;
  - single general policy for all tax levies;
  - to provide a stimulating role of tax standards in productive enterprises and advanced forms of economic conduct;
  - Financial control over the obligation of all subjects on the tax fee.

The Association of enterprises, organizations and firms allocate 24% of their salaries to the pension fund, transfer 0,3% to the Employment Fund and 0,2% to the Social Insurance Fund.

Taxes accounted for about 90% of the state budget revenue. The collected taxes are spent on various sectors of the country in a manner and the money turnover in the country is consistently adjusted.

Taxes come first of all the social relations of the state, as well as the need to provide financial resources. The functions of the state in front of it are as follows:

- Social protection of low-income sections of the population (students, pensioners, invalids, etc.);
- ensuring the country's welfare;
- ensuring peaceful employment and free living protection of citizens of the country;
- Implementation of continuous social, cultural activities (education, health, culture, Social Security, etc.) within the country;

The tax rate plays a major role in the calculation of taxes. Tax rates are divided into the following types: proportional, progressive and regressive rates[4.65].

Proportional rate – is determined by the object of taxation in a single percentage. For example, in the property tax, a single tax rate is imposed on the value of fixed assets.

The progressive rate – with an object value or revenue growth, the rate will grow. For example, in the income tax on wages of citizens starting from 1 January 2007, up to 4 times the minimum wage of the amount of income is taxed by 13%, and with an increase in income, the tax rate also increases by 25%.



The more income increases at regressive rates, the tax also decreases. This is the opposite of the progressive rate.

According to the tax declaration, the tax authorities determine the cost of the taxpayer's income from net income (that is, the taxable income), support the tax rate, calculate the amount of tax.

The definition of the tax rate is based on a number of principles.

1. Principle of carnal desire-means that a tax must be levied from different persons, depending on the degree of their use of programs financed on the account of taxes.
2. Principle of solvency-it is necessary that the amount of tax corresponds to the level of wealth and income of the taxpayer. In other words, Taxation should be subject to a fair distribution of income.
3. The principle of fairness is that those whose income and level of use of government programs are equal should pay an equal amount of tax.

Tax benefits are established on the basis of the procedures and conditions established in legislative agreements. In practice, the following types of tax benefits are common: – the designation of the minimum level of non – taxable objects; – the exemption of a particular person or certain groups of persons (for example, war veterans) from paying taxes; – the reduction of the tax rate (rate); – deduction from the amount to which the tax is levied; – tax credit (delay in taxing or reduction of the

It should be noted that with a thorough tax policy in Uzbekistan, the provision of unique rates of economic growth, the prosperity of the country through the modernization of the economy and the further improvement of the welfare of the population serve as one of the most important factors.

#### REFERENCES:

1. Parkinson S. Zakon i doxodi. - M. PKK Interkontakt, 1992. - B.14-15.8
2. Yo'ldoshev A. Soliq va soliqqa tortish.–T.:Fan.1996 –130 bet
3. ГАТАУЛИН Ш. СОЛИҚЛАР ва СОЛИҚҚА ТОРТИШ Ўқув қўлланмаси Т.:Fan–304 бет
4. Malikov T.S. Soliqlar va Soliqqa tortishning dolzarb masalalari.–T.:Adliya.2002.–204-b
5. Yo'ldoshev M., Tursunov Y. Moliya huquqi.—T.:Mehnat.1999
6. Pariyev B. Soliq siyosati: ijtimoiy-iqtisodiy rivojlanishning eng muhim omili\ Soliq solish ba buxgalteriya hisobi. 10(24)2016.–T.:Sharq.– 120-bet

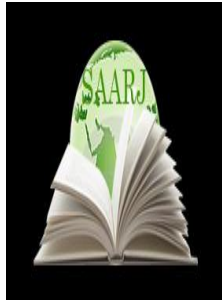

**ACADEMICIA**  
**An International**  
**Multidisciplinary**  
**Research Journal**  
 (Double Blind Refereed & Peer Reviewed Journal)



**DOI: 10.5958/2249-7137.2021.01272.6**

## ANALYSIS OF PATHOMORPHOLOGICAL CHANGES IN THE LUNG TISSUE IN PULMONARY EMBOLISM IN MALIGNANT TUMORS

**Abadjan Avezov\*; Daniyar Nishanov\*\*; Ulugbek Ruzmetov\*\*\*;  
 Nizom Ermatov\*\*\*\***

\*Urgench branch of the Tashkent Medical Academy,  
 UZBEKISTAN

\*\*Republican Specialized Scientific and,  
 Practical Medical Center for Radiology and Oncology,  
 UZBEKISTAN

\*\*\*Urgench branch of the Tashkent Medical Academy,  
 UZBEKISTAN

\*\*\*\*Tashkent Medical Academy,  
 UZBEKISTAN

### ABSTRACT

*Autopsies and retrospective analysis revealed several diseases of the risk group. It can be chronic hepatitis, arterial hypertension, diabetes mellitus, and obesity, and chronic bronchitis, varicose veins of the legs, coronary artery atherosclerosis, coronary heart disease, and atherosclerosis. Therefore, in patients with malignant tumors, it is necessary to pay attention to existing risk factors, such as hepatitis, obesity, arterial hypertension, coronary heart disease, varicose veins of the legs, chronic bronchitis, diabetes mellitus, atherosclerosis, and coronary heart disease.*

**KEYWORDS:** *Thromboembolism, Venous Thrombosis, Malignant Tumors, Pulmonary Embolism.*

### INTRODUCTION

Actuality of the topic: 6 million people in all countries of the world are diagnosed with a new primary form of cancer. The incidence and mortality from malignant tumors vary from country to country. Morbidity and mortality from malignant tumors in European countries have now come to the fore at the expense of stomach and lung cancers. The practical significance of the

problem of pulmonary artery thromboembolism is currently determined by the apparent increase in the frequency of pulmonary artery thromboembolism in various diseases, a significant increase in the frequency of postoperative and posttraumatic embolisms that occur frequently during complex surgical interventions; in addition, deaths from pulmonary artery thromboembolism in highly developed countries are the third leading cause of death after ischemic heart disease and stroke.

The purpose of the study: to improve the assessment of pathomorphological changes and causes of death in malignant tumors complicated by pulmonary artery thromboembolism

## MATERIALS AND METHODS

We made extensive use of data from a retrospective study of autopsy statements and medical history of 128 corpses who died during treatment in the treatment departments of the Republican Specialized Scientific-Practical Medical Center of Oncology and Radiology from 2004 to 2018.

## THE MAIN FINDINGS AND RESULTS

Retrospective analysis of the autopsy data copy revealed that the thromboemboluses were directed from the right ventricular cavity of the heart to the pulmonary artery shaft and that the vessel was completely occluded or occluded, with small pieces of thromboembolus located in different parts of the small and segmental capillaries of the lung. In particular, 39 (30.5%) corpses reported the presence of thrombus particles in the right pulmonary arteries, while 75 (58.6%) corpses reported the presence of thrombus fragments in the arteries of both lungs. In 14 (10.9%) cases, only small capillaries of the left pulmonary artery were occluded with small fragments of a thrombus stuck in the pulmonary trunk. In the small and segmental branches of the pulmonary arteries, 77 (60.2%) corpses were found to have small thrombus fragments.

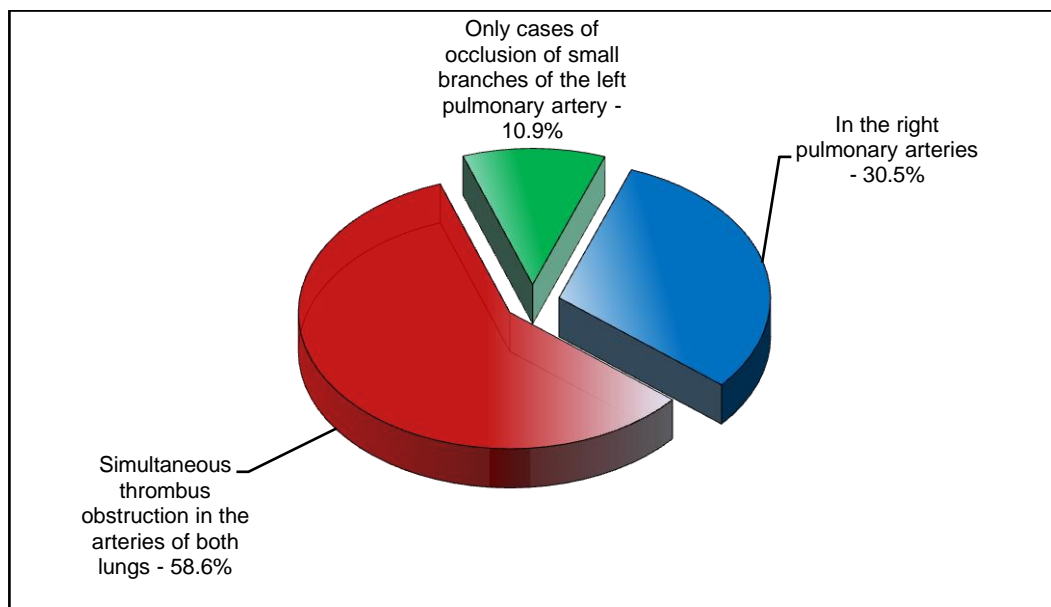

**Figure 1. The degree of occurrence of thromboembolic fragments on the localization in the pulmonary arterial branches**

According to the results of retrospective studies conducted in the study, hemorrhagic infarction in the lungs developed from macroscopic changes in lung tissue. The infarct is conical in shape, clearly demarcated from the surrounding tissue, with the base facing the pleura. Fibrin deposits are seen in the pleura of the infarct area. The dead tissue is dense, granular, dark red in color. The lungs are enlarged, the edges are sharp, the pleura is clear, the lung tissue is soft, elastic in consistency, pale red, airy, pinkish-red on the incision surface when cut, a large number of small or large foamy secretions. There was venous stagnation in the tissues, plasma saturation, edema, stasis in the capillaries, and numerous diapedesis hemorrhages. As a result of acute venous stasis, the alveolar capillaries dilate (lung tumor), and there is blood flow into the alveoli. These changes intensify and fibrosis develops.

Looking at the results of the data analysis, macroscopic changes were observed mainly in the lung fragments. In 26.8% of observations, signs of necrosis developed in the lung tissue of the corpses. These changes were found in 18.8% of corpses in one piece, 6.3% of corpses in two or more pieces, and 10.1% of corpses in polysegmental injuries. Injuries to the lower extremities accounted for 21.8% and in the upper extremities to 5.1%. The total injury of lung tissue in each part of the lung ranges from 60% to 70%.

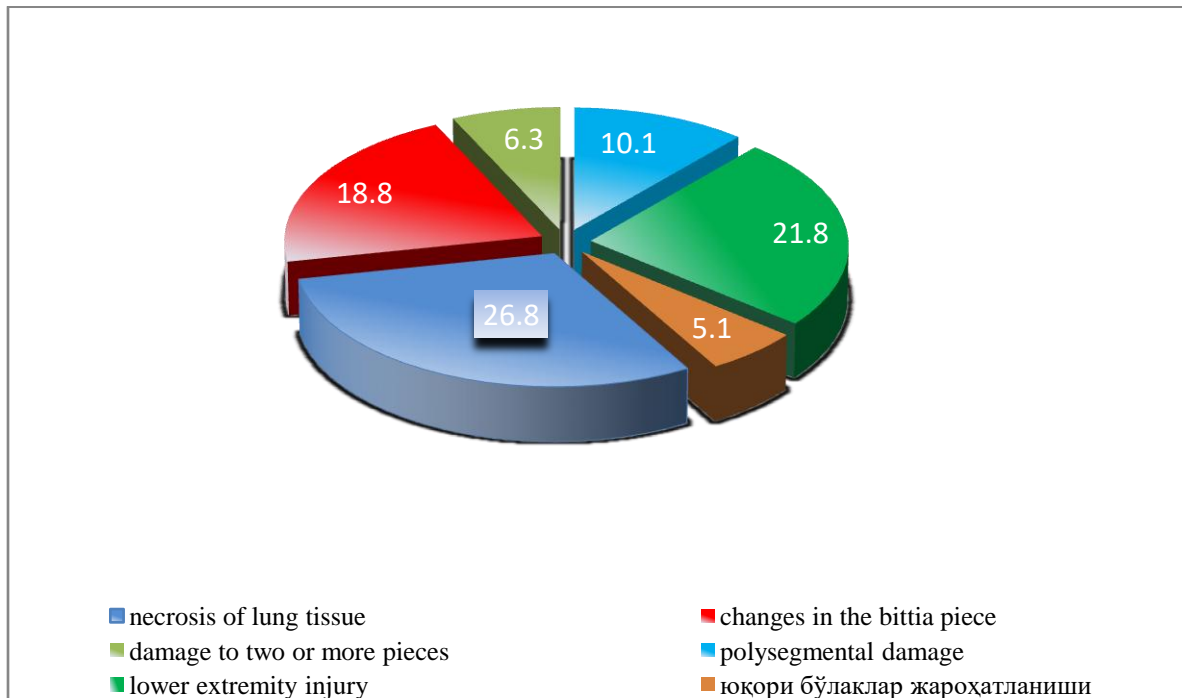

**Figure 2. Analysis of macroscopic changes in lung tissue**

In the histology of lung tissue in 76.6% of cases there is an enlargement of the alveolar cavity, in some places there is a violation of the trophism of alveolar cells, an increase in volume; hypochromic staining of the nuclei, broad and bright cytoplasm, vascular richness of the stroma of the alveolar barrier, flattening of the endothelium; eccentric location of the nuclei and richness of fibrocytes. Lymphocytes accumulated in some areas of the interstitial tissue and erythrocytes leaked from the blood vessels.

Interstitial tumor of the alveolar-capillary membrane consists of erythrocytes, a tumor consisting of a small number of segmented nuclear leukocytes, lymphohistiocytic, macrophage infiltrations, increased permeability of arterial vessel walls, venous blood stasis in the vessels, plasmorrhagia, interstitial edema of interstitial endothelial lesions, I. Erythrocytes, neutrophils, and macrophages are often found in alveolar fluid, hyaline membranes are located along the alveolar barriers. The walls of the alveoli are fibrous, fibrous interstitial pneumonia is observed. Sometimes bronchopneumonia was added and found to be fatal.

On histological examination of the bronchial walls, the mucous layer was composed of multilayered squamous cell epithelium; the submucosal layer is composed of fibrocytes. The mucous layer is full, swollen, mucus production in glandular and goblet cells is sharply increased, the covering epithelium of the mucous membrane is displaced, the walls of the bronchi and bronchioles thicken due to cellular infiltration and edema, leading to impaired bronchial drainage activity.

In the vascular wall of the bronchial wall, hypoxia also increased vascular wall permeability, plasmorrhagia developed, and intima layer suffocation resulted in injury to endothelial cells, basal membranes, muscle tissue, and vascular wall fibrous structures.

The results of histological examination show that the tumor in the lung tissue - 76.6% (98 people), interstitial tissue tumor - 52.3% (67 people), pulmonary hemosiderosis - 25.7% (33 people), pulmonary anthracosis - 57, 1% (73 people), bleeding into the lung tissue - 64.8% (83 people), inflammation of the lung tissue - 30.5% (39 people), the presence of fluid in the alveolar cavity - 69.5% (89 people) .

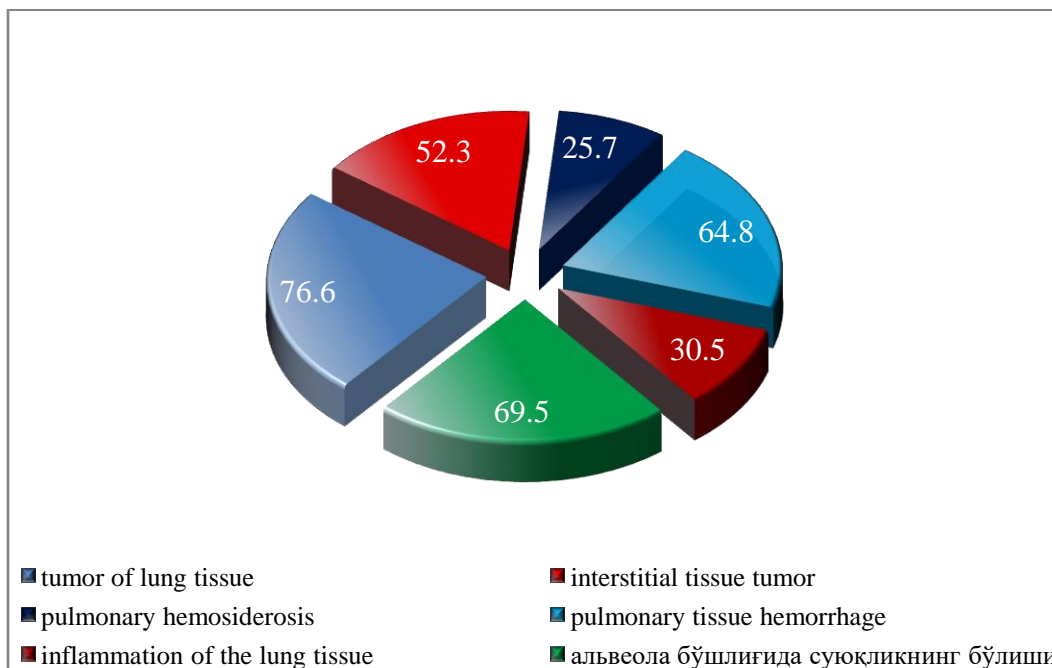

**Figure 3. Occurrence rates of microscopic changes in lung tissue.**

Analysis of macroscopic and microscopic changes in the endothelium of the pulmonary vascular wall in corpses who died of pulmonary artery thromboembolism in malignant tumors showed

that, macroscopically, the vascular wall mucosa was thickened, swollen, bruised, and microscopically viewed in some places narrowing of the endothelial spaces was observed.

Histological examination revealed the development of tumors due to disruption of the movement of plasma fluids through the alveolar-capillary walls as a result of suffocation of endothelial cells in the pulmonary vessels. In all the corpses examined, fully formed and developed emboli were found. When the detected thrombus composition was observed, it was observed that it consisted of platelets, erythrocytes and a small number of leukocytes, and that they were located not only in the anterior position of the vascular wall, but also in the free state in the vascular cavity. Cases of changes in erythrocytes as a result of changes in blood properties due to complete cessation of blood flow in the arteries have been observed.

As a result of these advanced pathomorphological changes, deaths from various causes have been observed in malignant tumors. If we compare the prevalence of deaths from malignant neoplasms among young people, the number of deaths from COPD in the age group of 30-39 years is 3 (2.3%), and the number of deaths from other complications is 10 (7.8%); Deaths from COPD in the age group of 40-49 years - 23 (18.0%), deaths from other complications - 10 (7.8%); In the age group of 50-65 years, 39 (30.5%) deaths were due to COPD, and 6 (4.7%) deaths from other complications; Among 66-year-olds and older, deaths from COPD were 33 (25.8%) and deaths from other complications were 4 (3.1%).

**TABLE 1 AGE-RELATED PREVALENCE OF CAUSES OF DEATH IN MALIGNANT NEOPLASMS**

Age of patients	The main cause of death was pulmonary embolism (n = 98).		Deaths from other causes (n = 30)	
	abs.	%	abs.	%
	57,8±3,5		56,6±3,5	
30-39 years old	3	2,3	10	7,8
40-49years old	23	18,0	10	7,8
50-65years old	39	30,5	6	4,7
66 and older	33	25,8	4	3,1

Thus, pathomorphological changes in the formation of thromboembolic complications in the lungs were found to occur in the perivascular areas. In the alveolar walls there is an increase in vascular wall permeability, dominated by clearly developed interstitial tumors containing erythrocytes, platelets, a small number of leukocytes; impaired movement of fluids through the alveolar-capillary membranes; led to tumor development and severe arterial hypoxemia.

Based on the results obtained, it was found that those who died of pulmonary artery thromboembolism in malignant neoplasms developed signs of necrosis in the lung tissue of 26.8% of corpses from macroscopic changes in lung tissue. Histological examination revealed tumors in the lung tissue - 76.6%, bleeding into the lung tissue - 64.8%, inflammation of the lung tissue - 30.5%, the presence of fluid in the alveolar cavity - 69.5%.

## CONCLUSION

To conclude based on the data of macroscopic and microscopic and hemostatic changes obtained in our research, in order to prevent deaths from COPD complicated by malignant tumors in the postoperative period, it is necessary to prescribe treatments that improve blood circulation, as well as dangerous tumors, special attention should be paid to the rheological changes in the blood that occur during the treatment of patients with chemical drugs and radiation, as well as risk factors such as chronic hepatitis, obesity, diabetes. The practical use of these indicators allows timely diagnosis of pathological changes in blood components, their level, prevalence and hemodynamic significance.

## REFERENCES

- 1) Abdurakhmanov M.M., Abdullaeva M.A. (2015) Nonspecific aortoarteritis: hereditary risk factors in the Uzbek population. *Journal of Theoretical and Clinical Medicine*. # 2. Institute of Immunology of the Academy of Sciences of the Republic of Uzbekistan. – pp. 126-129.
- 2) Barbarash O. L., Boytsov S. A., Vaisman D. Sh., Et al. (2018) *Problems of assessing mortality rates from individual causes position statement*. Complex problems of cardiovascular diseases. 7 (2).
- 3) Boytsov SA, Samorodskaya IV, Nikulina NN, et al. (2017) Comparative analysis of the mortality rate of the population from acute forms of coronary heart disease over a fifteen-year period in the Russian Federation and the USA and factors affecting its formation. *Therapeuticarchive*. 89 (9)
- 4) Davydov M.I., Matveev V.B., Volkova M.I. et al. (2016) Surgical treatment of kidney cancer complicated by neoplastic venous thrombosis of III-IV levels. *Oncourology*. No. 4 (12). – pp. 21-34
- 5) KarimovSh.I., KhakimovM.Sh., Adylkhodzhaev A.A., Rakhmanov S.U., KhasanovVr. (2015) *Treatment of complications of transhepaticendobiliary interventions in obstructive jaundice caused by periampullary tumors*. *Annals of Surgical Hepatology*; 20 (3): - pp. 68-74
- 6) KarimovSh.I., Sunnatov R.D., Irnazarov A.A., Yulbarisov A.A., Asrarov U.A., AlidzhanovKh.K., Muminov R.T., Tsai V.E., Murodov A .M. (2018) Principles of surgical treatment of patients with combined lesions of the carotid and coronary arteries. *Emergency Medicine Bulletin*. Volume 11, No. 2. – pp. 75-76
- 7) KarimovKh.Ya., Boboev K.T. (2019) Efficiency of using biological microarrays in the study of specific chimeric oncogenes. *BulletinofHematology*.
- 8) Kamalov I.A., Tukhbatullin M.G. (2015) Right ventricular failure and pulmonary hypertension in recurrent thromboembolism of small branches of the pulmonary artery in patients with malignant neoplasms. *KazanMedicalJournal*. T. No. 4. – pp. 492-497.
- 9) Kamalov I.A. (2016). Interrelation of echographic signs of idiopathic venous thrombosis and malignant neoplasms. *VolgaOncologicalBulletin*. No. 2. – pp. 71-76
- 10) Kamalov I.A., Tukhbatullin M.G. (2015) Right ventricular failure and pulmonary hypertension in recurrent thromboembolism of small branches of the pulmonary artery in patients with malignant neoplasms. *KazanMedicalJournal*. T. No. 4. – pp. 492-497.

- 11) KarimovKh.Ya., Boboev K.T. (2019) Efficiency of using biological microarrays in the study of specific chimeric oncogenes. *BulletinofHematology*.
- 12) KirienkoA.I., ChernyavskyA.M., AndriyashkinV.V. (2015) Pulmonaryembolism. How to treat and prevent. – Moscow: LLC “Publishing House“ Medical Information Agency”. – p. 280.
- 13) Nikulina N.N., TerekhovskayaYu.V. (2019) Epidemiology of pulmonary embolism in the modern world: analysis of morbidity, mortality and problems of their study. *RussianJournalofCardiology*. – pp. 103-108.





**ACADEMICIA**  
**An International  
 Multidisciplinary  
 Research Journal**  
 (Double Blind Refereed & Peer Reviewed Journal)

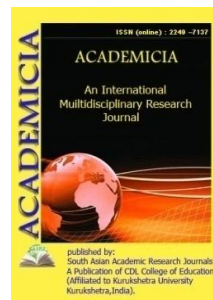

**DOI: 10.5958/2249-7137.2021.01273.8**

**CREATING A BIOPHYSICAL TRAPPING DEVICE BASED ON AN  
 OPTICAL RADIATION SOURCE WITH A LIGHT-EMITTING DIODE**

**Abdurashid Khamidillaevich Yusupov\***

\*Doctoral Student,  
 Andijan Machine-Building Institute,  
 UZBEKISTAN

**ABSTRACT**

*The article addresses the problems of using semiconductor LEDs in the creation of environmentally friendly, high-efficiency, energy-efficient biophysical trapping device and their introduction into agriculture. The use of semiconductor LED lamps that are compatible with the spectrum of solar light in the device is preferred over other methods in that it is effective in combating pest flying insects and does not harm beneficial insects. The proposed device is environmentally friendly compared to chemical and biological methods of pest control. The device consists of an energy-saving circuit, which does not require high energy in use. This prevents inconveniences when used in field conditions, and the efficiency of useful work in the fight against flying insects is higher than other methods.*

**KEYWORDS:** *Semiconductor LED, High Voltage, Circuit, Semiconductor Transistor, Transformer, Conductors, Energy Consumption, Light Spectrum, Power Supply, Solar Photo Element, Battery, Biophysical Trap, Flying Insects, Sexual Pheromone.*

**1. INTRODUCTION**

It is known that there are more than 80,000 species of pests of agricultural crops, of which more than 10,000 species cause significant economic damage to agricultural crops. According to the United Nations, one-third of crop yields are lost to pests each year. This figure is 50-60% in developing countries and 10-12% in developed countries.

The productivity of agricultural crops, the quality of the harvest increases the efficiency of production, ensures the economic and food security of the country, increases the material well-being of the population. At present, the use of technologies based on innovative technical solutions that meet modern requirements is a key factor in the development of agriculture.

There are several widely used methods of pest control in the world: chemical, biological and physical. Of these, the method that combines biological and physical methods is the biophysical method, which is technically distinguished by its effectiveness. Currently, extensive research is being conducted on the use of this method, in particular, on various models and mechanisms of its operation. They are a high-voltage grid device based on optical radiation according to their structure and mode of operation [1,2]. The main mechanism that attracts insects in such devices is a source of optical radiation. It is surrounded by a high-voltage net in the form of a net, and the insects that seek the light are destroyed in this net. A common disadvantage of such devices is the extinction of all types of insects, including beneficial insects, the use of a special lamp as a source of optical radiation, ie, such a lamp does not attract large numbers of insects due to limited service life, high energy consumption, slow light wave propagation. Another device [3] has also been developed, a biophysical trapping device for killing harmful flying insects. This device is surrounded on three sides by a transparent wall of the sex pheromone, the fourth side by a high-voltage mesh, and the optical radiation source is mounted on its front. The main disadvantage of the device is that in field conditions, beneficial insects are killed by colliding with a high-voltage net at the expense of wind. Surrounded by a transparent wall on three sides, which reduces the scattering of optical rays in this direction, a special shaped fluorescent lamp was used as the optical radiation lamp. The required 220 V power supply is required for the device to work. This poses a problem in power supply in field conditions. Given the shortcomings of these methods, one of the current challenges is to create an environmentally friendly, inexpensive and highly efficient, energy-efficient biophysical trapping device to protect agricultural crops from various pests, to study its physical mechanisms. The newly developed device by us [4] illuminates the physical nature of the energy-saving biophysical trap device based on an optical source semiconductor LED, free from the above shortcomings.

## 2. STRUCTURE OF THE DEVICE

Figure 1 illustrates an energy resource-efficient biophysical grip device. According to the structure of the device, the base of the device consists of a cap, a bag for insects and electrical circuit elements. The upper part of the base of the device is in the form of a bath (1), on the surface of which is mounted a fighter device (2) in the form of a high-voltage grid. Beneath it are placed sex pheromones (3). Dead insects fall into the bag (4) through a hole in the bottom of the tub. The bag is located on the closed part of the device base (5). Inside the closed part of the base of the device are the elements of the electrical circuit. The electrical circuit consists of a low-power energy-saving transformer, a switch, a transistor, a conductor. The device cover (6) is fixed to the base by means of threaded rods (8) through the troupe (7). The semiconductor LED lamp (9) is located between the hood and the bath. To supply it with power, electrical conductors pass through the troupe.

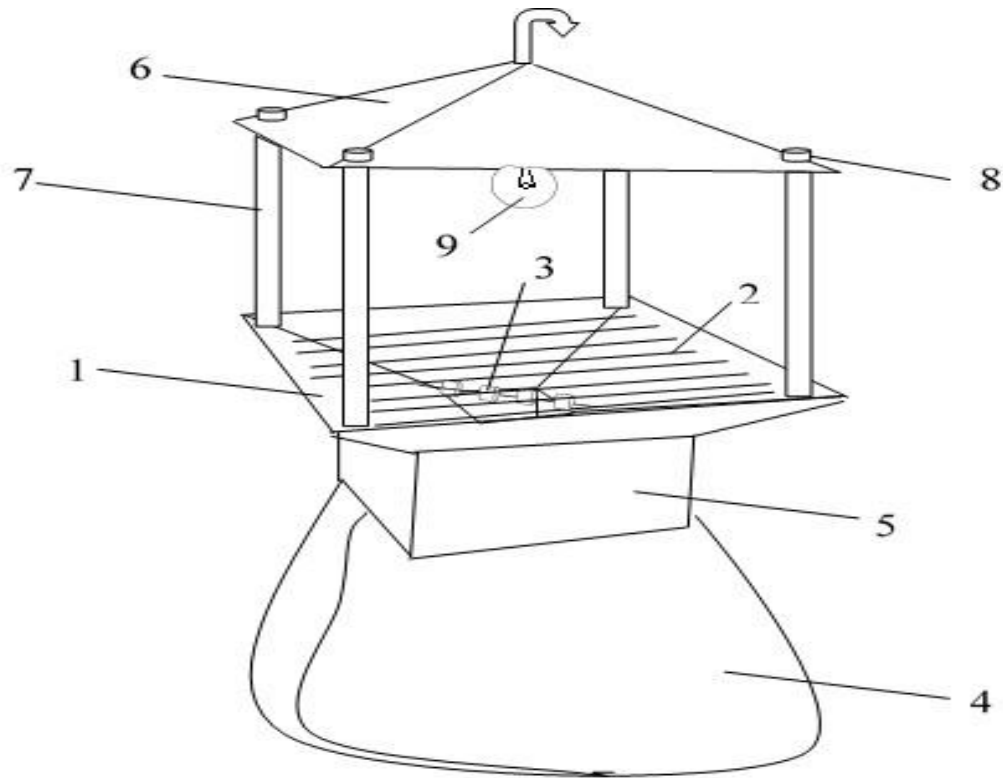

Figure 1. Simplified scheme of energy-saving biophysical trap device.

### 3. TECHNICAL CHARACTERISTICS OF THE ELECTRICAL CIRCUIT OF THE DEVICE.

Figure 2 shows the electrical block scheme of the device, which consists of an electrical amplifier transistor [5-7], an energy-saving high-voltage transformer, switch-off switches, a semiconductor LED lamp, and conductors.

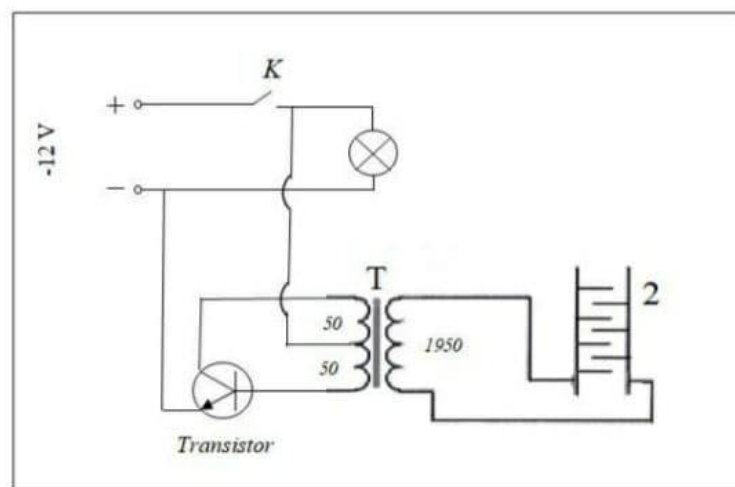

Figure 2. Electrical block scheme of the device.

The transistor converts an alternating 12-volt voltage from the current source into alternating current and transmits it to the transformer. The first winding of the transformer consists of 50 to two windings of copper wire with a cross-sectional area of 50 mm<sup>2</sup>. The second winding consists of 1950 copper wire windings with a cross-sectional area of 30 mm<sup>2</sup> [8-10]. A high voltage of ~3000 volts is generated in the secondary winding of the transformer, which is transmitted to the wire mesh. The range of the device to attract insects ranges from 500 m to a radius of 1000 m. Power supply capacity (duration of operation) 1 day.

#### 4. THE WORKING PRINCIPLE OF THE DEVICE.

The device consists of a low-power energy-saving electrical circuit, the power supply voltage required for the operation of the device is constant 12 V. Batteries with such a parameter can be used to operate the device. It is not necessary to bring the battery to the mains to recharge, it is possible to recharge the battery during sunny days of the day using solar panels while standing in the field. In the device, an energy-saving low-power light bulb with a high luminous flux is placed under the cover of the device. The optical radiation lamp attracts insects. In ancient times, local farmers widely used the color of fire to collect insects, which was done by lighting a fire. Flame color has the property of dissipating heat as well as light. It has attracted a large number of insects under natural conditions. With this in mind, the underside of the cap of this device will be red and the surface of the tub will be yellow. Due to the fact that the lamp is located between the two surfaces, the light returning from them is mixed with the light of the lamp and diffuses in the form of a flame color. This attracts a large number of insects. This allows the identification of all types of insects in the area. A high-voltage net designed to kill insects is mounted horizontally on the surface of the bath-shaped kit, along with the base of the device. Beneath the destructive device in the form of a high-voltage grid mounted on the surface of the bath is a sex pheromone, which acts as a trap. Its essence is that the pheromone separator under high voltage attracts the main pest insect, as a result of which the pest insects that seek it are destroyed in a high-voltage net barrier. Another important aspect of the device is the vertical placement of the semiconductor optical radiation lamp, the high-voltage mesh and the pheromones. It is known that pheromones attract insects by spreading odors. The infrared light in the color of the flame, which is seen above, that is, returning from two surfaces and diffused by mixing with the light of the lamp, enhances the odor-scattering property of the pheromone. The odor rises to the top through a high voltage mesh. This is amplified in the range of the optical voltage lamp as well as the high voltage mesh and increases the attractiveness of the insects. Insects that seek out the odor-spreading pheromone are destroyed in a high-voltage net. Dead insects fall into the bag through the crack. Does not harm beneficial insects. Their destruction is prevented. The area of influence of one device ranges from 500 m<sup>2</sup> to 1 hectare.

It should be noted that pheromones in the device can be used for any type of insect. This, in turn, allows the device to be used in any area of agricultural crops in the fight against pests.

The efficiency of the device is determined by the intensity of the optical source attracting a large number of flying insects. The light sensitivity of flying insects corresponds to the wavelength range ~460–650 nm [11]. It is important to select suitable light sources that take into account the distribution of light intensity in the environment at a certain wavelength, as well as the increase or decrease of the light power effect when propagating in the environment.

Known light sources include incandescent lamps, fluorescent lamps, and semiconductor LED types. They differ from each other in lighting intensity, performance efficiency, power consumption, operating time, and the fact that they emit a certain wavelength. At present, semiconductor LEDs are mainly used in manufacturing, industry and the national economy. Semiconductor LEDs differ from other types of lighting in quality and light distribution ability, low power consumption, long service life, ability to emit different light spectra, control the emitted light power, high durability, environmental and fire safety [12, 17-19]. Depending on the type of semiconductor LED, the wavelength of the light emitted can range from 0.4  $\mu\text{m}$  to 1  $\mu\text{m}$  [13, 18]. Another important aspect of semiconductor LEDs is that the illumination does not change even when the operating voltage drops below the required voltage.

### RESEARCH METHOD

In addition to the parameters listed above, in order to increase the efficiency of the device when choosing an optical source for a fishing lighting device, it must meet requirements such as lighting efficiency, light wavelength propagation in the environment and attracting large numbers of insects. Therefore, lamps with the same luminous flux of 1200 lumens [14] were selected as the source of optical radiation for the study. Determining the wavelength of light in the air is one of the most important scientific and technical problems in research. Figure 3 illustrates a simplified scheme of the research method.

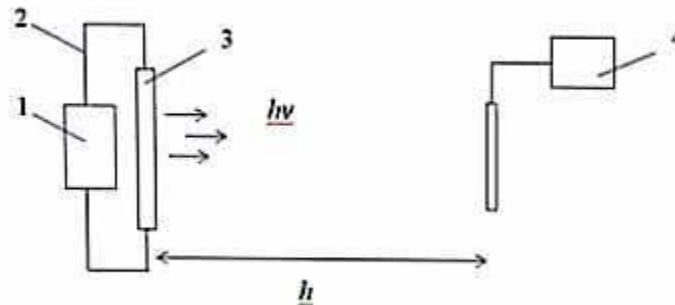

Figure 3. Simplified scheme of the research method. 1 - light source, 2 - light source, 3 - light source, 4 - luximeter, h - distance from the lamp to the luximeter.

The studies were carried out in the process of changing the distance from the optical radiation source to the luximeter in the range  $h=50 \div 600$  cm. The resulting light intensity was measured using a luximeter brand LX1330B. The LX1330B luximeter receiver sensor type silicon photodiode filter is made of selenium semiconductor material and has a large light measuring range. The experiment was performed several times between 6pm and 4am and the results were found to be consistent.

### RESULTS AND THE MECHANISM OF INTERPRETING THEM

Figure 3 illustrates the dependence of the luminous intensity of optical sources on  $h$ . We can observe the different distribution of light rays from optical radiation sources in the air. In all cases, it was found that the luminosity decreases exponentially with increasing distance from the

optical radiation source to the luximeter. The value of light intensity in an incandescent lamp takes smaller values in all cases than in a fluorescent lamp and a semiconductor LED. We can see that the luminous power of a semiconductor LED is higher in all cases than that of a fluorescent lamp and an incandescent lamp. This is because the flux of white light emitted from a semiconductor LED source is close to the spectrum of sunlight and has a wide spectrum range [15, 16, 18], it propagates in light spectra of different wavelengths.

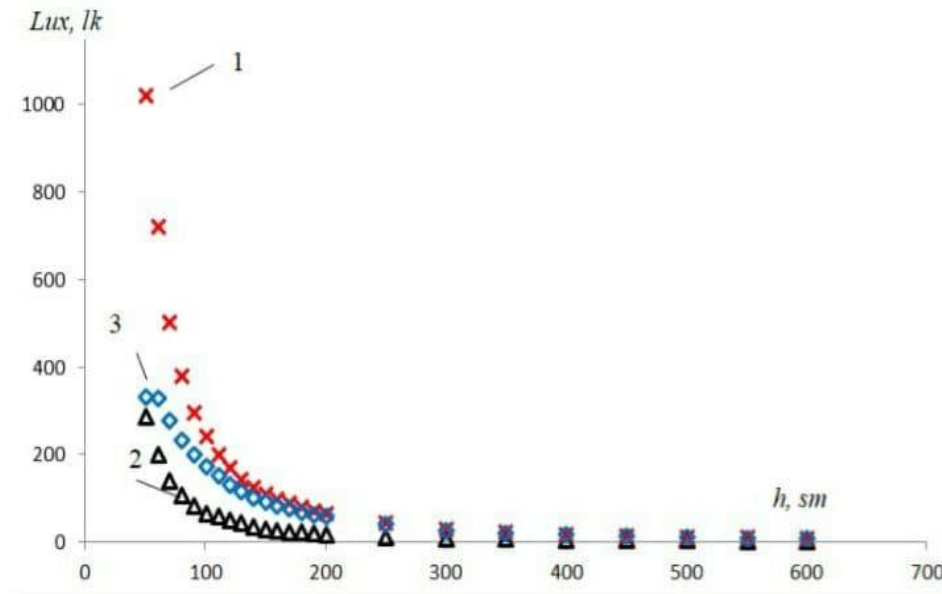

Figure 4. Dependence of optical source light power on h. 1 - LED, 2 - incandescent lamp, 3 - fluorescent.

The use of semiconductor LEDs in comparison with incandescent lamps and fluorescent lamps in the development and implementation of biophysical trapping devices against agricultural pests indicates that they attract large numbers of flying insects and are the preferred source of optical radiation with a wide wavelength of propagation in the air.

## RESULTS OF THE EXPERIMENT

Preliminary research results were used against cotton plant pest flying insects. The experiment was conducted between 00<sup>00</sup> and 4 p.m., and found that 62 caterpillars were caught in more than 1,000 biophysical traps, and no beneficial insects were harmed.

## CONCLUSION

In summary, such a modern improved physico-technical solution of a biophysical grip device based on a semiconductor LED lamp has not been recorded in the literature to date. The device is energy efficient and effective in combating agricultural pests, plays an important role in increasing the productivity of agricultural crops, the quality of products.

## REFERENCES

1. SU 880382, 1981; <http://www.insan.kiev.ua>;

2. JIADUO frequency trembler pests-killing lamp. JIADUO Science, Industry and Trade CO. Ltd., Xitoy, 3-5 b.
3. Zararliucharhashoratlarniqirishqurilmasi. UZ FAP 00332
4. L.Olimov, A.Yusupov, Zararliucharhashoratlarga qarshikurashqurilmasi. Patent UZ FAP № 01356.
5. U.Tittse, K.SHenk. poluprovodnikovayaxematexnika. 12-eizd. Tom I: Per. s. Nem-M.: DMK 52 b, 308 b.
6. N.V.Burbaeva, T.S.Dneprovskaya. Osnovipoluprovodnikovoyelektroniki. I.P. Fizmatlit. Moskva 2012. 92 b.
7. A.A.SHuka. Elektronika 2-eizdanie. I.P. BXV-Peterburg. Sank-Peterburg 2008. 203 b.
8. A.I.Voldek, V.V.PopovElektricheskieshimashini. Vvedenievelektromexaniku. Mashinipostoyannogotokaitransformatori. Piter, 2007. 242-302 b
9. G.F.Bistritskiy, B.I.Kudrin. Elektrosnabjenie. Silovietransformatori. Moskva «Yurat» 2018. 13 b, 18 b.
10. I.P.Kopilov. Elektricheskieshimashini. Moskva «Yurat» 2012. 206 b.
11. “Kursobsheyyentomologii” Yu.A.Zaxvatkin. izdatelstvo: M.Kolos 2001 g
12. F.E. SHubert, Svetodiodi. – M.: Fizmatlit, 2008. – S. 77-79. – 496. ISBN 978-5-9221-0851-5.
13. Jim Breithaupt. New understanding physics for Advanced Leve. Cheltenham : Nelson Thornes, 2000. P 364-368.
14. Sravneniesvetodiodnixlampstraditsionnimiosvetitelnimipriborami. Kompaniya «KVARTA-RAD». <https://www.quarta-rad.ru>
15. IvanovA. V., FyodorovA. V., SemyonovS. M. Energoberegayushiesvetilnikinaosnovevisokoyarkixsvetodiodov // Energoobespechenieenergoberejenie – regionalniyaspekt : XII Vserossiyskoesoveshanie: materialidokladov. — Tomsk: SPBGrafiks, 2011. — S. 74—77
16. V.B. Kozlovskaya, V.N. Radkevich, V.N. Satsukevich. Elektricheskoeosveshenie. Spravochnik. – Minsk, 2007 ISBN 978-985-6591-39-9, S. 37.
17. Olimov L. O.,Yusupov A. Kh., Alijanov D. D.. (2019). Problems of Introduction of Innovative Technologies and Modern Equipment in the Fishing Industry. International Journal of Research Studies in Electrical and Electronics Engineering (IJRSEEE) , 23-25.
18. Olimov L. O., Yusupov A. Kh.. (2020). Problems Of Implementation Of SemiconductoredLeds For Fishery Lighting Devices. The American Journal of Engineering and Technology, Pages: 189-196
19. Olimov L. O., Yusupov A. Kh.. (2021). The Influence Of Semiconductor Leds On The Aquatic Environment And The Problems Of Developing Lighting Devices For Fish Industry Based On Them. The American Journal of Applied sciences, Pages: 119-125

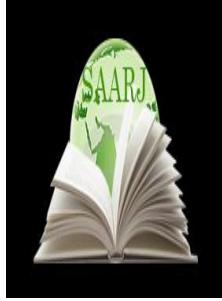

**ACADEMICIA**  
**An International**  
**Multidisciplinary**  
**Research Journal**  
(Double Blind Refereed & Peer Reviewed Journal)



**DOI: 10.5958/2249-7137.2021.01274.X**

**PROFESSIONAL COMPETENCE OF FUTURE ENGINEERS IN HIGHER  
EDUCATION INSTITUTIONS SOME ASPECTS**

**Avazov J.D\***

\*Lecturer,  
Termez State University Termez,  
UZBEKISTAN

**ABSTRACT**

*The article describes the content of some aspects of the professional competence of future engineers related to the application of intellectual abilities in higher education institutions. The practical results of this process are clearly reflected in all spheres of our lives today, and most importantly, in the consciousness, aspirations and actions of our people. In particular, the goal of the national training program is to radically reform the education system, to free it from the ideological stereotypes of the past, to create a national system of training qualified personnel at the level of developed democracies, meeting high spiritual and moral requirements. As one of the general technical disciplines, "Descriptive Geometry and Engineering Graphics" is the main discipline in the training of engineers. Each of its sections contains materials related to the content of other disciplines and involved in their study.*

**KEYWORDS:** *Youth, Education, Upbringing, Future, Professional, Engineering Graphics, Computer Graphics, Design, Competence, Intellectual, Integration, Intellectual, Creative, Cognitive, Future, Ability, Efficiency.*

**INTRODUCTION**

Educating young people, educating them, educating them as worthy personnel for the future has always been one of the top priorities of every state. In our country, too, such work is constantly in the spotlight of the leaders of our state - we can say the same truth. The Action Strategy on the five priority areas of development of the Republic of Uzbekistan, adopted on the direct initiative and under the leadership of President Sh.M. Mirziyoyev, has launched a new stage of development in the republic. The practical results of this process are clearly reflected in all spheres of our lives today, and most importantly, in the consciousness, aspirations and actions of



our people. Particular attention is paid to the improvement of the education system, which is one of the priorities of the fourth strategy of action - the development of the social sphere.<sup>1</sup>

In the meetings and speeches of the head of our state during his visit to each region, in various meetings, in his speeches and conversations educating a harmoniously developed generation, following a healthy lifestyle of young \_\_\_\_\_

1. Decree of the President of the Republic of Uzbekistan. On the strategy of further development of the Republic of Uzbekistan. Tashkent, February 7, 2017 PF - 4947

people living issues are seen as a topical issue on the agenda is coming. As the President said: "If we do not bring up our children properly, if we do not pay attention to their behavior every day, every minute, if we do not teach them science, if we do not find a decent job, we will lose this deposit."<sup>2</sup>

It is known that the laws "On Education" and "On the National Training Program" also set the task of training highly qualified specialists in our country who can meet the requirements of world standards. In particular, the goal of the national training program is to radically reform the education system, to free it from the ideological stereotypes of the past, to create a national system of training qualified personnel at the level of developed democracies, meeting high spiritual and moral requirements. In the current period of gradual reforms in the field of education in our country, based on the requirements of the National Training Program, there is a need to put into practice the existing conclusions and recommendations to improve the effectiveness of education.

In particular, one of the main goals of the "National Training Program", which is being implemented in three stages, is to form competitive, active and creative individuals who can adapt to the transition to a market economy. Therefore, the Decree PF-6108 "On measures to develop education and science in the new period of development of Uzbekistan" signed by President Islam Karimov on November 6, 2020 also states that "the country is able to come up with new initiatives and ideas for development. Training of a new generation of high intellectual and spiritual potential, formation of skills and knowledge necessary for graduates of educational institutions to become modern professionals" is one of the main directions in this field.<sup>3</sup>

This issue, along with other disciplines, is a key task in teaching technology. This requires the effective and rational use of teaching methods in the teaching process, as well as the improvement of these methods, the search for new ones, increasing the effectiveness of technology education. Therefore, the main issue in the field education today is the training of qualified teachers who are well versed in the methods and forms of education and can easily apply them in practice. Because the teacher's personality and his activity are of special importance in educating students, directing them to professions. Consequently, nothing else can overwhelm the teacher's open communication-style learning process. Therefore, improving the quality and effectiveness of education is an important factor for the training of qualified teachers, to improve their professional skills.

Radical changes in all spheres of society require the search for and use of effective technologies for the training of highly qualified personnel. Success in the economic development of the country is inextricably linked with the quality of training engineers for various purposes. In such conditions, professionals in professional and other fields of activity as a creative person The

formation is the main task. The qualification of an engineer is characterized by the ability to creatively solve problems of creating new equipment, developing modern high technologies, optimizing the production and operation of technical facilities.

In our country, these needs are strengthened by a number of factors. A set of problems related to the ability of people to use their mental and professional abilities in rapidly changing environments has been identified. (*A set of problems related to adapting people to rapidly changing conditions to apply their intellectual and professional abilities has been identified.*) The process of transformation of the traditional mechanisms of development of society expands the range of issues related to the change in the emphasis on priorities in the social, cultural, practical policy of the state. Depending on these situations, the quality of education is the focus of leading educators and society as a whole.

The situation has in many respects set new requirements for the training of highly qualified, competent specialists in mechanical engineering, energy, production technology, construction and other fields. Scientific substantiation of the integrity of the higher education system is required, the importance of optimizing various forms of organization of the educational process, the development of criteria for assessing the competence of future professionals in the profession is growing. In a changing society, modern trends in economic development place new demands on the field of professional qualities of the specialist.

The main reasons for this process are as follows: education does not respond to the challenge posed by a changing economy. As a result, society is dissatisfied with the quality of education; increasing the independence of educational institutions and teachers is not always positive; normative-legal uncertainty often regulates relations in the field of education in the opposite way. Laws and bylaws change frequently; Often, innovative innovations do not improve the performance of educational institutions, but rather worsen them;

In recent years, the active participation of our country in the integration process, joining the Bologna process, the organization of the educational process of 43 higher educational institutions of the Republic in the credit-module system as a test requires effective and mandatory quality control. An effective system of support is needed in the training of qualified professionals. These include: collecting data from personnel consumers; order formation in personnel consumers; selection of educational paradigm; selection of parameters for evaluating learning outcomes; predict the goal; comparison of expected results with existing ones, etc.

The transformation of educational technologies and methods of organization of educational activities, depending on the changes in the forms and technologies of the educational process, the criteria for assessing the quality of training of engineers, provides ample opportunities for pedagogical researchers, and the gradual implementation of forms. The teaching process involves directing students to what unites and forms the basis of the professional competence activities of future engineers. Such an order of society required pedagogical research to identify key changes in the development of professional competence of future engineers during their studies at the university. General engineering training at a university can help solve these problems. Issues of professional training of future specialists in the higher education system SI Arkhangel'sky, VP Bepalko [8, 111], VA Slastenin, UN Nishonaliev, AA Abdukadirov, AR Khodjaboev, R . It forms the basis of scientific research of such scientists as Khasanov, N.Saidahmedov, K.O.Tolipov, SSBulatov. Graphic training as a basis of professional training in

the system of higher technical education R.Khorunov, Yu.Kirgizbaev, K.Kobuljanov, Sh.Muradov, J.Yodgorov, A.Akbarov, I.Rakhmonov, P.Odilov, R. Scientists such as Ismatillaev, DF Kuchkarova, TJ Azimov, E. Sobitov contributed to the development of the theory of graphic sciences (in particular, descriptive geometry) with their textbooks and manuals. Pedagogical scientists from many independent Commonwealth countries, including A.D. Botvinnikov, D.M. Borisov, E.I. Valpas, K.Ya. Vazina, A.A. , V.A.Xerver, G.F.Gorshkov, E.A. Gnatishina, N.M. Kathanov, Yu.F. Kathanova, V.V. Karpov, A.F.Kaseev, A.S.Meshcheryakov, S.G.Marfin, V I.Nilova, A.A. Pyatyshkin, et al. G.A.

To the problems of optimizing teaching practice, developing creative thinking in the process of graphic preparation. Ivashchenko, D.V.Matveev, L.G, I.A. Roitman, S.A. Frolova, N.F. Chetveruxin, A.A. Chekmarev, V.I. Dedicated to the works of Yakunin and others.

However, descriptive geometry; engineering graphics; basics of design; the problems of studying engineering and computer graphics and other geometric-graphic sciences have not been sufficiently analyzed in relation to the teaching of general sciences, taking into account the characteristics of future professional activity. It should be noted that quantitative and qualitative criteria for assessing the level of professional suitability at the stage of mastering the graphic sciences, which combine the organizational - pedagogical, methodological and technological bases of the educational process, have not yet been developed.

The above considerations lead us to the need for theoretical substantiation and experimental verification of the effectiveness of the system of general engineering-graphic training of university students, which is especially relevant in the context of high demand for the quality of professional competence of future engineering training.

Generalization of practical experience of students' graphic training and analysis of scientific-methodical work in the process of graphic training of highly qualified future specialists **shortcomings and contradictions** allowed to determine. **First:**

- Over the past decade, the results of numerous studies on the preparation of engineering graphics by professors and teachers of higher education institutions have been published. They addressed the problems of general engineering graphics focused on the chosen profession;
- There is no integrated methodological theory of the formation of professional skills in the field of engineering work and education of production technologies;
- There is no research that can increase the motivation in the study of descriptive geometry and engineering graphics to ensure a high level of use of graphic knowledge in the course work and graduation work;
- Problems of graphic training are not analyzed in the process of adaptation of young professionals to practical, design and production activities.

The most important feature of the level of professional competence of future engineers during their studies in higher education is the quality of graphic training. This requires the creation of pedagogical conditions in which students can ensure the effectiveness of graphic activities, taking into account modern requirements.

In the design and implementation of the teaching process of "Drawing Geometry and Engineering Graphics" it is very important that the knowledge gained is taken into account at a

higher level of education, which is especially relevant in this regard. all the subjects studied in the disciplines are highly interdependent. The shortcomings in the preparation of the previous topics of the course begin to show immediate negative results in the subsequent topics of teaching.

The development of new science-based forms of improving professional competence in the teaching of graphic geometry and engineering graphics in higher education is based on the analysis of the purpose, structure and interrelationships in the education system. Recently, the following trends have emerged: ўқув ахборот ҳажмининг ўсиши;

- significant limitation of study time;
- complicated educational content.
- Significant limitation of study time;

The integrity of the level of education and the implementation of new methodological methods in the structure of teaching graphics allows the science of "Descriptive Geometry and Engineering Graphics" to be integrated into the general system of training. The formation of intellectual, creative and cognitive abilities of students plays a leading role in teaching based on the principles of continuity of educational materials.

Consistency, harmony of the nature of educational and cognitive activity of students in the forms and methods of teaching are currently used by leading specialists - teachers, and the issues of professional training of future specialists UN Nishonaliev, AA Abdukadirov, AR Khodjaboev, R. . Khasanov, N.Saidaxmedov, Q.O.Tolipov, S.S.Bulatov; It forms the basis of scientific research of scientists from the CIS countries, such as SI Arkhangelsky, VP Bespalko, VA Slastenin.

After in-depth study of qualification requirements, curricula, sample and working programs, 5310600 - Territorial transport systems and their operation, 5340600 - Operation of transport facilities, 5340800 - Roads and airfields, 5320300 - Technological machinery and equipment and other specialties After analysis, we came to the following conclusion: intensive targeted training of specialists in technical universities is based only on the traditional curricula that we use, cannot be based on business plans. It seems that the interdisciplinary connection in the professional orientation of education has remained. Each department teaches students their subject in higher education, and none of them teaches them to apply in a comprehensive way the knowledge they have acquired in solving the professional problems facing university graduates in life.

In the subject of 'Descriptive Geometry and Engineering Graphics', almost all subjects are traditionally described at the same level, and it is difficult for students to know exactly what they need to master in order to successfully pursue their studies and subsequent careers. Apparently, we are training "knowledgeable" professionals, but not "talented" professionals. Students view the final controls as a benefit to themselves. In the minds of many of them, the notion of passing knowledge and skills, rather than passing tests and trials, dominates.

In order to eliminate these contradictions, we tried to analyze the experience of designing, conducting and researching the educational process on the example of the subject "Descriptive Geometry and Engineering Graphics" for students of specialties. This process reveals new

aspects of the importance and place of descriptive geometry and engineering graphics in professional development, allows to study the interdependence of this discipline and the special disciplines of the program, including the graphic part, and improves the professional competence of future engineers.

As one of the general technical disciplines, "Descriptive Geometry and Engineering Graphics" is the main discipline in the training of engineers. Each of its sections contains materials related to the content of other disciplines and involved in their study. Therefore, in the process of studying the subject of descriptive geometry and engineering graphics, it is very important to ensure an integral connection between this subject and the future professional activities of students in the senior courses of the University. Such coordination increases the importance of the subject of "Descriptive Geometry and Engineering Graphics", arouses interest in reading and studying the chosen profession.

In our research, we relied on the experience gained in teaching different subjects in secondary schools, vocational schools, technical schools and colleges with different specialties, universities in different disciplines. At the same time we have I.Rahmonov, Sh.A.Abdurahmonov, T.D.Azimov, N.J.Yodgorov, K.A.Zoyirov, R.Q.Ismatullaev, P.O.Odilov, M.H.Pirimjarov, IT Rakhmonov, EI Ruziev, and foreign scientists: James D. Bethune, GS Phull, HS We referred to the experience reflected in the works of Sandhu [16, 164], R.B.Gupta, N.D.Bhatt, presented to a certain extent in their scientific and methodological work. In the research of TV Chemodanov, the concept of "professional graphic training" is very interesting and sufficiently expressed - this allows the training professional to solve educational and professional problems using geometric modeling methods of flat and three-dimensional images and to perform them adequately for future training. This graphic cycle is a combination of geometric, engineering-graphic, information-technological, methodological knowledge, skills and abilities in the field of general engineering sciences, there is no methodology for selecting material that actively enhances the student's professional interest. The existing forms of organization of the educational process in descriptive geometry and engineering graphics do not fully correspond to the potential for solving problems in teaching this subject, with an emphasis on the specialty under study.

One of the ways to overcome these contradictions is to look for new content and forms of teaching that fully realize the potential of teachers and students.

The problem under consideration is relevant both in terms of preparing students for educational activities in the departments of general engineering and graduate, as well as in terms of increasing the efficiency of the educational process and increasing the mental activity of students.

***Second:***

The leading activity of the student is his educational and cognitive activity, and for the teacher - educational work. All of this requires the teacher to think deeply and reflect on the didactic support of preparation for lectures and practical sessions.

Today it is necessary to further democratize the society, to raise the activity of higher technical education institutions to a new level of quality in the conditions of wide opportunities for the activities of private higher education institutions. This should be reflected, first of all, in the rejection of the principle of uniformity in education, in the organization of different types of

educational institutions, in the creation of new curricula and textbooks, the content of which corresponds to the field of higher education, in the revision of teaching methods and tools.

Modern trends in the development of higher education institutions pose a number of new theoretical and practical problems for professors and teachers working in technical universities. One of them is the reflection of the integration and differentiation of knowledge in the content, essence and activities of education.

This problem cannot be solved without taking into account the results of the interdependence of the studied disciplines. scientists R.H.Djuraev, N.J.Isakulova, M.X.Lutfillaev, I.V.Makhukhina, A.Musurmonov, M.Q.Muxliboev, B.N.Oripov, A.A.Salomov, N.I .Taylakov, N.S.Fayzullaeva, N.I.Hurboev; and others studied in the works of educators.

The future engineer must be able to apply a set of knowledge in various disciplines in their professional activities. In the scientific and pedagogical literature, the concept of "interdisciplinary integration" is vaguely interpreted, thus defining its various roles and place between pedagogical categories (categories). According to EB Shoshtaeva, interdisciplinary communication is a unit of professional activity, reflecting the continuous and integrated phenomena, represents the process of community of educational sciences E.V.Perexosheva defines interdisciplinary integration as a process of combining educational sciences on the basis of cognitive (knowledge) and technological problems in the light. For us, interdisciplinary integration represents a set of educational goals, principles, and meanings in creating a broad-based interaction of all academic disciplines. Therefore, professional competence begins to develop in the first stage of student education, aimed at giving senior students quick optimal decisions in any complex professional situation, in which the formation of skills to perform certain actions independently can be achieved through interdisciplinary communication.

In short, higher education achieved faster and better results if it abandoned less effective forms of teaching. Research based on the current reality is needed. One of the tools that have a positive impact on the training of professionals is to increase their interest in the profession.

#### REFERENCES:

1. Decree of the President of the Republic of Uzbekistan. On the strategy of further development of the Republic of Uzbekistan. Tashkent, February 7, 2017 PF - 4947.
2. 2.Mirziyoev Sh. Let us be more united and work resolutely for the fate and future of our country. // "Xalq so'zi" gaz., 2017, June 16.
3. Decree of the President of the Republic of Uzbekistan "On measures to develop education and science in the new period of development of Uzbekistan." T., November 6, 2020 PF-6108
4. Laws of the Republic of Uzbekistan "On Education" and "On the National Training Program". // - T.: Sharq, 1997.
5. 5.Azizxo'jaeva N.N. Pedagogical technology and pedagogical skills: Textbook. - T.: TDPU, 2003. - 174 p.
6. 6.Babanskiy Yu.K. Teaching methods in modern general education school. T.: Teacher, 1990. - 232 p.

7. 7.Ball G.A. Theory uchebnyx zadach: Psychologo-pedagogical aspect. M .: Pedagogika, 1990. - 184 p. 120.
8. 8.Bespalko V.P. Slagaemye pedagogical technology. M .: Pedagogika, 1989. - 192 p.
9. 9.Ziyomammedov B. Advanced pedagogical technology: theory and practice. T .: Abu Ali Ibn Sina Medical Publishing House, 2001. - 78 p.
10. 10.Yuldashev J.G', Usmonov S.A. Fundamentals of pedagogical technology. T .:Teacher, 2004. - 236 p.
11. 11.Golish L.V. Active methods of education: content, selection and implementation. Methodical manual. T .: O'MKHTRI, 2001. - 128 p.
12. 12.Chekmarev A.A. Nachertatel'naya geometry and cherchenie: Ucheb. for stud. vyssh. ucheb. zavedeniy. - 2-e izd., Pererab. and dop. - M .: Humanities. izd. VLADOS center, 2003.- 472 p.
13. Yurin V.N. Kompyuternye tekhnologii v uchebnom protsesse injenernogo obrazovaniya // informatsionnye tekhnologii. 1999.-№ 3 - p. 45.
14. Yakovlev E.V. Upravlenie kachestvom obrazovaniya v vysshey shkole: teoriya i praktika. - Chelyabinsk, 2000.- 427 c.
15. G.S Phull, H.S. Sandhu. Schools for the 21st Century. - San Francisco, 1990. - P.164.
16. Guy R. Lefrancois. Psychology For Teaching. - USA, 1991.- P.449.
17. Farfiyeva K. A. Social Media as a factor in formation of scientific thinking in youth. European Journal of Research and Reflection in Educational Sciences. Vol. 8 No. 10, 2020. – Pp. 52-56.

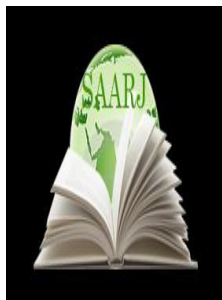

**ACADEMICIA**  
**An International**  
**Multidisciplinary**  
**Research Journal**  
 (Double Blind Refereed & Peer Reviewed Journal)

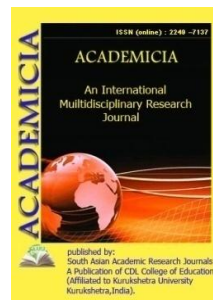

**DOI: 10.5958/2249-7137.2021.01275.1**

**FIVE INITIATIVES IN EXTRACURRICULAR EDUCATION**

**Dildora Turgunovna Pulatova\***; **Nargiza Kabulova\*\***

\*Doctor of Pedagogical Sciences (PhD),  
 Scientific Research Institutenamed after A. Avloniy,  
 UZBEKISTAN

\*\*Director,  
 Children's School "Harmoniously developed generation" in Samarkand,  
 UZBEKISTAN

**ABSTRACT**

*The article provides information on the upbringing of children in out-of-school education in Uzbekistan, the importance of five initiatives in child development, the qualities of a child's readiness for public life in a rapidly developing society. It also focuses on the implementation of five initiatives put forward by the President in children's schools "Barkamol Avlod", international assessment programs, as well as an integrated approach to this system.*

**KEYWORDS:** *Generation, Society, Five Initiatives, Life, Education, Circle, Program, Education, Complex, Management, Efficiency.*

**INTRODUCTION**

Education and its place in the world civilization are essentially determined in the end by a high and always urgent problem. The main goal of any public policy is the intelligence of future generations and spirituality. Rewarding the next generation is spiritually mature, well rounded, intellectuals are a priority in any country. The World Educational Forum (World Educational Forum), "WorldSkills" plays a special role in creating an innovative system based on a comprehensive framework. Currently, the priority of education is characterized by improving life skills, harmony with theory and practice, and self-sufficiency skills in harmony.

When we look at the international experience, the school education of a child is explained by the level of preparation for life and is also important for the active development of public life, and this is one of the urgent tasks facing educational institutions. In the process of education reform, the complex unit of theory and practice is explained by the interaction of education and other institutions in the formation of the child as a comprehensive mature person.



The system of extracurricular education in Uzbekistan has been one of the most common types of education in recent years. Activities of children's schools "BarkamolAvlod" children's schools consist in the profession, the development of talents and abilities, the implementation of life skills, the meaningful organization of their leisure skills. However, it is necessary to develop research models aimed at providing a comprehensive, bold, developer generation in a global society, activating a harmonious generation and self-development.

Resolution of the President of the Republic of Uzbekistan "On measures to radically improve the effectiveness of extracurricular education in the public education system" 30 September 2019 in PP-4467, Resolution of the President of the Republic of Uzbekistan "On additional measures to further improve the education and upbringing system" 6 November 2020 PP-4884, Decree of the President of the Republic of Uzbekistan "On measures to develop the spheres of education and upbringing, and science in the new period of development of Uzbekistan" 6 November 2020 UP-6801 these are important documents for current education.

Young people who are our future in every way, communicative, wise, intelligent, can find a decent sunny life in life, is one of the most aspiring challenges in our community. Consequently, a number of decisions and arrivals are made to serve as programs in reproducing these functions. The main purpose of the internship is to improve the effectiveness of education, which is a pressing issue that is critical to this modern teacher ability.

In addition to school education in Uzbekistan, extracurricular education is a unique system, which is a large school that develops children's development, efficiency, ability. A number of decisions and decisions of the President of the Republic of Uzbekistan, the number of decisions made in this system will be determined in order to find their children in the world society, as well as our children in the world society. Research in the system serves to improve the efficiency of the industry, improve the development of the industry, improving the quality of scientific and implementation of scientific and implementation of scientific and implementation of quality of scientific and implementation.

In accordance with the decision of the President of the Republic of Uzbekistan "On measures to further improve the effectiveness of the President of the Republic of Uzbekistan" on measures to radically improve the effectiveness of the President of the Republic of Uzbekistan "On measures to improve the effectiveness of the President of the Republic of Uzbekistan "Action Strategy for 2017-2021, President

It is known from history that before the ancient parenting is important to society and takes this problem seriously. It can read a lot of information in ancient works. In particular, Farabi is Fozil's own team for grouping people according to different attributes. No need to pay attention to people, abilities, abilities, psychic talents, not to religious sects or the race of people. The state also needs to be regulated by a local person; That is, he says that he is fair and wise, create laws and create laws and take care of the future, care for concerns of the Republic of Uzbekistan" " Creation of modern methodology, improvement of state requirements and development and implementation of a new generation of educational and methodological complex, further improvement of the effective organization of the activities of extracurricular educational institutions.

Despite the fact that education about conducting education in the service of Farabi is a close education, it emphasizes that every place and feature is in the development of a person.

Beruni can beautifully make any morally harmonious person of human weakness. Beruni is important for human qualities-if it is purity, and the closest thing to a person says that his nature and spirit. That is why man shows that his nature is to make things pleasant by his pleasure. At the same time, with the inner world, the outer beauty, the harmony of beauty is a way of life. It has been noted that the work of strollers, words, words, hearts, their daily lives, to this, and everything they do in their daily lives, is beautiful.

The possibility of separating religious and spiritual requirements, this possibility gradually becomes characteristic of human behavior. Ibn Sina plays a special role in shaping a person, the people who surround him around a person who is not only to the external environment, and people know the world around them, but also to find the formation of access or evidence in his behavior. Therefore, it does not require children to be careful in raising children, so as not to teach the child bad habits, you need to keep it away from the bad environment.

Scientists of the CIS countries R. Meminsky, S. A. Shakova, E. Mitina, N. V. Chit, L. P. Shopina, E. Bredis, O. Shkapovar, P. V. Gornostaev, V. A. Gorokhov, L. A. Kokhanova, V. K. Tebiev and additional education conducted research on the regular development of the child's creative skills and creative languages. V. N. Tersky, A. S. Makarenko noted that a person should be educated in an integrated system of the system. He says that the role of outstanding educational institutions for the knowledge he gained in school is invaluable and definitely in practice. Therefore, they were eager for young people to study and nurture.

Our children are engaged in independent thinking, modern knowledge, and their profession, has a solid vital position, and rising that of a true patriot nation is important.

The 5 initiatives that were sent to the president were met with great interest by our people and young people. Deep thoughtful goals and objectives are given in the content of each initiative.

The first initiative serves to raise his talents in music, fiction, literature, theater and art, to create the necessary conditions for young people to show the skills of young people, their ability in sports. The third initiative is aimed at organizing the use of computer technologies and the Internet between the population and young people. The fourth initiative, in turn, is aimed at increasing the spirituality of young people and organizing systematic work to promote communication between them. The fifth initiative involves the problems of women's employment.

The Five initiative fulfills the spirit of modernity in the wishful mind of the younger generation to launch them into new areas of creativity. Indeed, the scope of work carried out in our country, the scope of work carried out related to young people, is very wide. This process is based on the designated responsibilities for education managers, staff, and education. Young people are the successors of our future, their attention to them today, attention to the future of our state and the future of our people.

It is this five initiative that requires the integrated functioning of children's schools "BarkamolAvlod" in the system of extracurricular education. The role of children's schools "BarkamolAvlod" is of great importance in the significant free time of the child. It shows that cooperation with such schools, special sports schools, neighborhood and high schools, as well as a number of other institutions. The child will find it worthy to find his place in life to make the theoretical knowledge that the practitioner wants to make it. In a child from young adults, the

scan itself provides its own activity in social relations. From childhood, the initial skills and skills of any profession play an important role in the growing master of their profession in the future. Cooperation with production enterprises in the field of children's schools "BarkamolAvlod" will allow the child to develop in a complex society. Cooperation between sports complexes of children's schools and special sports schools "BarkamolAvgans and special sports schools provide the meaning and potential of the learning process.

President of the Republic of Uzbekistan "On measures to improve the effectiveness of extracurricular careers in public education" schools of the scope of the scope of BarkamolAvlod in children's schools "BarkamolAvlod" will again cooperate with your teacher, allowing you to create a free environment in the place where he is familiar to himself.

Children's schools of "BarkamolAvlod" prepare the child not for the exam, but for life. Concept of the President of the Republic of Uzbekistan 29 April 2019 " Concept b by Decree No. PF-5712 notes the main directions of long-term development of the public education system, including:

Achievement of the PISA (The Program for International Student Assessment) of The Republic of Uzbekistan. International Student Assessment Programs International student development programs at the international level is one of the top 30 leading countries;

The objectives of the system of continuing education are put aside in the direction of the quality of the content of the system, as well as training, retraining and advanced training of professional personnel.

The participation of the Republic of Uzbekistan in international programs and studies (PISA, TIMSS, PIRLS, etc.) in the public education system was revealed. "Tasks are registered in international programs and studies.

The child's theoretical knowledge will be transformed into entertainment in non-school educational institutions. It is self-evident that the child is ready for life, and not directly for the exam. Life skills develop and manifest as a person.

Conclusion it can be said that the child's focusing skills are reflected in the practice, acquired and formed in the child's mind on the spot. In addition, at the time of school, the meaning of a child's life is a leading tool in his future marriage and will become an active enterprise for society. The development of the future of the motherland is determined by the abundance of such active people in society.

## REFERENCES

1. Mirziyaev Sh. M. We will build our great future with our courageous and noble people. T.: Uzbekistan, 2017. - 488 p.
2. President of the Republic of Uzbekistan Sh. M. Mirziyoyev April 29, 2019 No. PF-5712 " Concept of the state education system of the Republic of Uzbekistan by 2030.
3. Aesthetic education of students in extracurricular institutions: manual for teachers. - M.: Prosveshchenie, 1986.
4. Saleev, V. A. Esthetic perception and children's fantasy / V. A. Saleev, O. V. Ivashkevich. - Minsk: NIO, 1999.

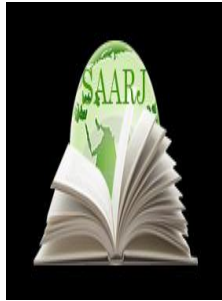

**ACADEMICIA**  
**An International**  
**Multidisciplinary**  
**Research Journal**  
 (Double Blind Refereed & Peer Reviewed Journal)



**DOI: 10.5958/2249-7137.2021.01276.3**

## FROM THE HISTORY OF STUDYING ALISHER NAVA'S LYRIC POETRY

**Dilnoza Ahmad qizi Rustamova\***

\*Researcher,  
 State Museum of Literature of the Academy of Sciences,  
 Republic of UZBEKISTAN

### ABSTRACT

*Alisher Nava'i's lyric poetry has been studied in Uzbekistan and abroad. The process of studying the literary heritage of the poet in Uzbekistan began in the thirties and forties of the last century on the occasion of the five hundredth anniversary of Nava'i. Research on Nava'i's poetry was conducted mainly in two directions: theoretical research and textual research. The article provides information on the beginnings of theoretical research. M.Shaykhzoda, A.Hayitmetov, Y. Ishakov's fundamental research aims to study the lyrical hero of Nava'i, used poetic arts, the characteristics of the genre (genres of ghazal, qit'a, tuyuk, fard), the characteristics of the subject and the main images. After independence, Nava'i scholars studied religious themes in the poet's poetry (ghazals praise be to Allah and prophet), they conducted research within the framework of Nava'i's Sufi views. Nearly a hundred years of research have given rise to the science of Nava'i studies.*

**KEYWORDS:** *Ghazal, Nava'i Studies, Diwan, Nava'i Lyrics, Lyrical Hero, Genre, Image, Poem, Poetics.*

### INTRODUCTION

While the study of Nava'i's lyrics began in the 1930s, it was conducted mainly in two directions. The first direction was the textual examination of the poet's works. At the same time, the literary critic Hamid Suleiman worked on the preparation of an academic edition of "Hazoin ul-Maoniy" and a scientific critical text. The first theoretical researches on lyricism can be observed in the scientific works of academicians Oybek, E. Bertels, M. Shaykhzoda and A. Hayitmetov.

In general, to express the study of Nava'i's poetry from the point of view of the laws of art began while the poet was still alive. His contemporaries such as Jami, Lutfi, Babur, Sayyid Hasan Ardehir, Pakhlavon Muhammad gave him a neutral and objective assessment.

The emerge of the science of fundamental Nava'i studies can be divided into two historical periods: pre-independence and post-independence scientific research.

**The main part.** Maksud Shaykhzoda's research and a series of articles on "Nava'i's lyrical hero" is the first and special stage of pre-independence scientific research. Although the research is based on the "Gharoyib us-Sighar", it contains general theoretical views on Nava'i's lyric poems. The study provides theoretical insights into the identification of the poet's lyrical protagonist, some poetic methods of lyricism, the distinctiveness of the Eastern Diwanian tradition and the Nava'i diwans, and the role of science bade in the study of classical poetry.

As in all diwans, the "main organism" of the "Gharoyib us-Sighar" is the ghazal, the scientist assesses his creative skills as follows: "The main and first characteristic of Nava'i's ghazal is its logical structure, the birth of one moment from another". In the poems of the poet, the principle of creating a perfect event, a lyrical situation with a plot, that is, the principle of evolution is also felt in the development of the image. In a deeper understanding, analysis and study of the essence of Nava'i's lyrics, Maksud Shaykhzoda dwells in detail on the contrast and contrast of spiritual arts, and quotes unique examples of the poet's lyrical monument.

Prof. A. Hayitmetov's fundamental research of a monographic nature called "Nava'i lyrics" was also one of the important steps in Nava'i studies. The scholar conducted research on the genre features of Nava'i's lyrics, the features of the creative method, the topics addressed in the ghazal, which is considered the most active genre and the characteristics of the main lyrical images. In particular, the issue of determining the true chronology of the poems included in "Hazoin ul-Maoniy" was scientifically concluded by Doctor of Philology Hamid Suleiman – Both Maksud Shaykhzoda and A.Hayitmetov confirmed that the manuscripts copied while Nava'i was alive were not written in the four seasons of his life. In addition, the study of the genre features of Nava'i's lyrics is considered a key issue in the study of the creative lyrical heritage. Therefore, the monograph notes that the genres of qit'a, fard, sokiynoma, chiston, problem, rubai, tuyuk were enriched with new features in the poet's lyrics and developed in all directions. The genre of ghazel is also specifically mentioned. Poet who wrote ghazals before Nava'i's Sa'di, Hafiz, Lutfi, Otoy, Jami, Khusrow Dehlawi followed the literary traditions of the time, his incomparable success in ghazal writing was reflected in the weight, theme and specific new details. Maksud Shaykhzoda describes the lyrical hero as Nava'i himself, while A. Hayitmetov focuses on the main characters, the lyrical hero - the admirer, the beloved, the poet himself, the sheikh and other characters.

The poetry of the protagonist also cited three main characteristics: "... he is, firstly, a fiery lover, secondly a rind, a drunkard, and, thirdly a poet-thinker, about life and being, about science and art, when he is overwhelmed by the sufferings of his lover and fails. a thinker, intellect person, a person who writes poems about it."

There are some considerations in the research of Shaykhzoda and A. Hayitmetov, which we have seen above. In particular, when Shaykhzoda writes about genres, we don't see a qasida on the divan. He said: Nava'i did not consider official poems worthy of a lyrical diwan (although it is known that he wrote several poems about Bayqarah). However, A. Hayitmetov emphasizes that

the poem "Hilaliya", which is present in almost all manuscripts of "Badoe ul-vasat", is a very original and least studied genre. Of course, this comment is correct for the Shaykhzoda's object of study, "Gharoyib us-Sighar", but its general character shows that the phrase "unworthy" is problematic. Ishakov's first study was dedicated to the "First Diwan" composed by Nava'i's fans and was called "Alisher Nava'i's first lyrics". In it, for the first time, the ideological and artistic features of the first lyric were analyzed, and the poet's attitude to the lyrical traditions of his time was determined. These helped to understand the essence of Nava'i's work. After all, the observation of his complex creative path, which he traversed before his ascent to supreme, focuses on the fact that the first manifestations of humanity were manifested in his very first poetry by studying each stage. The scholar's work "Nava'i Poetics" provides a detailed analysis of the poetics of genres and the poetics of artistic imagery of the work "Hazoin ul-Maoniy". In the history of classical literature, the development of lyrical genres and their rise to a new level is directly related to Nava'i's work, each genre is its own object of image, one genre can not perform the function of another genre. In the section "Some methods and means of poetic image" analyzes the specific description of the content of the poem on the basis of stylistic and compositional means.

Y. Ishakov also addresses the subject of ghazels such as Shaykhzoda and A. Hayitmetov, and in contrast to them, ghazels on a romantic theme are divided into descriptive ghazels, descriptive-type ghazels, discussion-type ghazels, descriptive ghazels, and plot-based ghazels.

The literary critic summarizes his opinion on the poetics of Nava'i's ghazals as follows: "through his ghazals, Nava'i demonstrated in practice the various possibilities of this genre; Nava'i's ghazel's is distinguished by its large number in the history of ghazel; ghazels are created in different weights of aruz; their integrity and perfection in content and form is a special phenomenon; the individual biographical basis plays an important role in the ghazels. The scholar divides the main styles of medieval Uzbek poetry into Turkic, classical, high or Nava'i style. Brings the Nava'i style as a completely new phenomenon, consisting of a synthesis of the most characteristic features that are unique to all styles. He argues that its emergence is influenced by such factors as the philosophical and social essence of lyricism, pathos, internal evolution of genres, dynamics.

Nava'i scholars of the independence period paid attention to the little-studied aspects of the poet's work. N. Kamilov, I. Hakkulov, A. Abdukodirov, Dilorom Salohiy, S. Olim, K. Mullakhojaeva and other scholars based on the mystical aspects of the poet's poetry, the symbols of Sufism, imposed prohibitions. In particular, N. Kamilov's analysis of Nava'i's works on the basis of mystical and sectarian ideas, commentaries on ghazels, I. Hakkulov's series of articles "Return to Nava'i" on some topical issues of Nava'i poetry, analysis of ghazals, qit'as, rubai, comparative analysis of Dilorom Salohi's ghazel texts, researches on the gradual development of the poetic style of the poet, K. Mullakhojaeva's researches on meaning, symbolism and art, expression of Sufi views in hymns of praise and praise are among them.

## RESULTS AND DISCUSSIONS

Throughout the history of the study of Nava'i lyrics, attention has been paid to the following aspects:

- The issue of lyrical heroism in Nava'i poetry was considered. It turned out that Shaykhzoda and Hayitmetov had different views.

- The genre features of ghazals, qit'as, tuyuks, and rubais from the Diwans were studied.
- The themes and images of the most active genres used by the poet were described.

## CONCLUSION

In short, during almost a hundred years the history of the study of Nava'i's lyrics has led to the formation of it as a fundamental science, expanding the scope of research. The object of study shifted from general to specific, and different interpretations emerged. Today, studying Nava'i is facing new interpretations of the poet's lyrics and the correction of errors in the publication.

## REFERENCES

1. Шайхзода. Сайланма. 4-жилд. –Т. Адабиёт ва санъат. 1972. 258 бет.
2. А.Хайитметов. Навоий лирикаси. –Т.Ўзбекистон. 2015.
3. Ё.Исҳоқов. Навоийнинг илк лирикаси. –Т. Фан. 1965.142 бет.
4. Ё.Исҳоқов. Навоий поэтикаси. –Т. Фан. 1983.167 бет.
5. Навоийнинг ижод олами. –Т. Фан. 2001. 198 бет.
6. Алишер Навоий қомусий луғат. 1-жилд. –Т. Шарқ. 2016. 556-бет.
7. Алишер Навоий қомусий луғат. 2-жилд. –Т. Шарқ. 2016. 556-бет.
8. К.Муллахўжаева. Алишер Навоий ғазалиётида тасаввуфий тимсол ва бадиий санъатлар уйғунлиги. –Т. Академнашр. 2019.
9. Ҳ.Жўраев. Алишер Навоий лирикасида ўзига хослик. Дисс. 2008. 247бет.
10. Д.Салоҳий. Алишер Навоий поэтик услубининг тадрижий такомил. Дисс.2001. 285 бет.

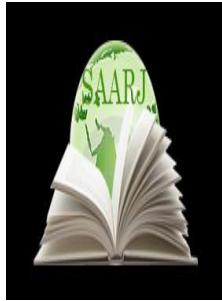

**ACADEMICIA**  
**An International**  
**Multidisciplinary**  
**Research Journal**  
 (Double Blind Refereed & Peer Reviewed Journal)



**DOI: 10.5958/2249-7137.2021.01277.5**

**EDUCATION OF YOUTH IN UZBEKISTAN, RAISING THEIR MORALE**

**Fakhriddin Joylovich Yormatov\***

\*Associate Professor,  
 Department of General History,  
 Termez State University, UZBEKISTAN

**ABSTRACT**

*In the Republic of Uzbekistan, a systematic, phased strategy of reforms in the field of education and improving the morale of young people has been developed, closely related to other spheres of life - socio-economic, life. The role of various organizations, institutions and foundations in solving youth problems in the Republic of Uzbekistan has also grown.*

**KEYWORDS:** *Education, High Spirituality, Reforms, Initiative, Social Protection, Youth Policy.*

**INTRODUCTION**

Since the first days of independence, childcare has become a priority in Uzbekistan, solving the problems of social protection, especially for young people.

Uzbekistan has done a lot to solve the problems of youth. The work done by the state to educate them, to educate them into mature professionals, to transform them into worthy members of society, has begun to bear fruit. Certain progress has been achieved in protecting the rights and interests of the younger generation. Indeed, one of the first international legal instruments ratified after the Republic of Uzbekistan gained independence was the Convention on the Rights of the Child. After joining the Convention in 1992, the Republic of Uzbekistan assumed a number of international legal obligations to ensure the rights and freedoms of the child.

The current legislation of Uzbekistan on the protection of children's rights is being developed in accordance with the requirements of the Convention on the Rights of the Child on the basis of the Constitution of the Republic of Uzbekistan. According to him, the basic rights of the child, their protection are enshrined in the Civil, Family, Labor, Criminal Procedure and other codes of the Republic of Uzbekistan. The adoption of these norms has made a great contribution to the development of legislation on the protection of children's rights.



To date, the UN Committee on the Rights of the Child has received two national reports on the work carried out in the Republic of Uzbekistan to fulfill the requirements of this convention. Uzbekistan has an excellent child protection system. [1]

From the first days of independence in the Republic of Uzbekistan, a systematic, phased strategy of reforms in the field of education of young people, raising their morale, closely related to other spheres of life - socio-economic, life.

According to him, reforms were carried out in the following priority areas of youth protection:

- creation and improvement of the legal framework that guarantees the protection of the rights of young people;
- to support the necessary institutional structures related to the protection of the rights of youth;
- improving the morale of young people, improving the quality of education;
- the formation of young people's aspirations for a healthy lifestyle;
- creation of a system of mass development of children and youth sports;
- prevention of delinquency among minors in need of social protection;
- creation of the necessary socio-economic conditions for the upbringing of a harmoniously developed generation [2].

Secondly, there are more than 950 thousand young families in the Republic of Uzbekistan. They make up 16 percent of all families. Comprehensive material and moral support is one of the priorities of the leadership of the Republic of Uzbekistan. [3.166.] It was important to resolve the issue of employment. It was also necessary to protect the rights and interests of young people in Uzbekistan, to create decent living conditions for them.

Fourthly, it was necessary to change the psychological and ideological outlook of youth, characteristic of the Soviet dictatorial system. In particular, the attitude towards young people in Soviet times was as follows:

1. Youth has become a political object of politics.
2. Young people were forced to participate in political life.
3. A single worldview connection, dependence.
4. Mental addiction.
5. Cases of spontaneous alienation.
6. A situation has developed when a false initiative, a sense of "brotherhood", "heredity", "subordination" to the party, communist ideas and views, were introduced into the minds and hearts of young people. [4.11.]

From the first years of independence, the policy pursued in the Republic of Uzbekistan in the interests of the population in need of social protection began to bear fruit. "Other forms of social protection for young people include additional payments that cover part of the cost of meals, part of the additional costs for school canteens and canteens from the budget, additional payments for those who live in private homes, low fares on public transport and other benefits. In accordance

with national traditions, a preferential procedure for the purchase of furniture and carpets for newlyweds has been established "[5.289.]

Such measures have proven to be very useful in the transition to a market economy. The society has ensured socio-political stability, possible economic and political crises, as a result of which the impoverishment of a certain part of the population has been prevented.

In this regard, certain positive work has been done in the Kashkadarya and Surkhandarya regions. The work carried out by regional authorities, various government agencies, trade unions, institutions related to social protection has instilled confidence in the citizens of the future. For example, on February 24, 1992, the Kashkadarya regional department of social protection of the population issued an order "On measures for the social protection of students and teachers." According to him, the issues of providing special social assistance to students, secondary specialized educational institutions and schoolchildren have been resolved. There have been established benefits for students and schoolchildren for food, medical care and the use of transport. In particular, 50 percent of school meals are covered by the republican and local budgets.[6]

In the first years of independence, the Government of Uzbekistan paid special attention to the difficulties of the transition period, in particular, the issues of social protection of large families in the context of price liberalization. For example, in 1992 alone, an additional 5.9 billion soums were allocated for the interests of children and compensation. In addition, 10 billion soums were allocated for bread, milk, yogurt, sugar, eggs, meat and other food products.[7]

The work of trade unions in social protection of the population, including youth, is also effective. The policy of social protection of young people and low-income families with many children was based on science, taking into account the existing conditions and opportunities, as well as the traditional way of life of the Uzbek people. It is known that the allowance paid before the child reaches the age of two plays a special role in the social protection system. In 1994, the number of such families in Uzbekistan was 60 680 people. Of these, 5018 are in the Kashkadarya region and 8162 in the Surkhandarya region. At the same time, out of 70,832 families with children under 16 years old living in the country, 3,527 - in Kashkadarya and 4,716 - in Surkhandarya regions [8].

**Methods.** Over the years of independence in the Republic of Uzbekistan, the mechanism of social protection of the population has undergone changes and gradually improved. Most of the social assistance consists of benefits. 30 types of benefits introduced in Uzbekistan exempted or provided benefits to 15 categories of citizens from the requirements and obligations of the adopted general rules. Benefits were provided, first of all, to all categories of disabled people, war veterans and persons equated to them, families of military personnel killed, lonely elderly people, citizens who have special services to the country and people. Various public organizations and institutions took an active part in solving the problems of youth in the Republic of Uzbekistan, their social protection. The Youth Fund of the Republic of Uzbekistan "Kamolot" has also done some work in this direction. The work carried out by the Foundation was carried out in different directions, especially in the field of material and moral support for young families, search, selection, training of talented youth, sending them to study and career growth. Work with low-income families with children and children with disabilities has also begun to bear fruit.

350,000 soums have been allocated for caring for fathers, landscaping and asphaltting school grounds in the district [9].

In the Kashkadarya region, the regional branch of the Kamolot Foundation provided sponsorship assistance in the amount of 50,000 soums for the opening of a business incubator in the Shakhrisabz region. 20,000 soums have been allocated for awarding the winners of various events [10].

In 2000, the Prosecutor's Office of the Republic of Uzbekistan studied the mistakes made by local self-government and self-government bodies in the field of social protection of young people and solving their problems. It turned out that the ministries of finance, labor and social protection of the population, the People's Bank, the Republican Agency of Post and Telecommunications, as well as local authorities are indifferent to the problems of youth and laws on social protection of families with children.

In 2000, 1,370 applicants for social assistance were provided in the Surkhandarya region, but they were rejected without study and analysis by the local labor, employment and social protection authorities. In Kashkadarya region, the rights of 45 large families to social assistance were violated.

The role and place of the youth public movement "Kamolot" in the social protection of young people and in solving their problems is growing. The work of the Kashkadarya branch of the movement turned out to be very effective. The Department carried out a large-scale work on all-round support of young people, realizing their potential, material and economic support for those in need of social protection. For example, in 2004 alone, work for this purpose was carried out in 12 directions. In particular, work was carried out to support youth and children's publications, measures to solve the socio-economic problems of youth, employment, participation in small and medium-sized enterprises, socially significant measures to protect the interests of young people, additional financial incentives. important in solving the problem.[11]

Similar work was carried out in the Surkhandarya region. For example, only in Termez region in 2004 small businesses spent 14 192 soums on solving youth problems, and in Termez - 46.1 thousand soums. The volume of voluntary contributions from sponsors in the Termez region amounted to 486 thousand soums [12]. During the training period, a lot of work was done on the social protection of orphans, their material and spiritual support. In the Surkhandarya region in 2005, survivor pensions and social benefits were received by 18,425 families. Of these, 43,288 children from 17,762 families received pensions on the occasion of the loss of the breadwinner, the monthly pension amounted to 4.89,154,400 soums, which were paid on time through post offices. In 2005, 742 children from 374 families of the region received social benefits for the loss of a breadwinner. 651 orphans lost their parents, 396 families were transferred to their care in accordance with the decision of the district akim on guardianship and custody. They were paid pensions and social benefits on time, and 360 people received clothing from South Korea. [13.5.]

Much exemplary work has been done in this direction in the Guzar district of the Kashkadarya region. In 2006, the district received a list of 14,488 pensioners and social beneficiaries, of which 226 were disabled, 264 were breadwinners and 1398 social pensioners. In this regard, in order to establish social justice, the district department of social protection of the population has taken a number of measures, the department regularly holds "Open Doors" days, once a month training

seminars are held. In 2006 alone, 120 disabled children received wheelchairs and orthopedic legs [14.15.]

## RESULTS AND DISCUSSION

The year 2008 played a special role in solving the problems of youth in the Republic of Uzbekistan. In Surkhandarya and Kashkadarya regions, as noted above, the role of the current legislation in solving youth problems was significant. In 2008, 68,235 young people graduated from 844 secondary schools and 30 specialized schools in the Surkhandarya region. Of these, 48,928 graduated from the 9th grade and 19,307 - the 11th grade. Within the framework of the state program "Year of Youth", the Forum of Culture and Art of Uzbekistan, "Kelajak Ovozi", the "Youth Initiative" Center and the "Mehr Nuri" Charitable Foundation were organized together with the youth public movement "Kamolot". We are the youth of Uzbekistan "" were held under the motto. At the Vesna restaurant a table was prepared for 500 people from low-income strata of the population and young people with disabilities, and gifts were handed out. In accordance with the signed agreement between the youth public movement "Kamolot" and JSCB "Microcredit Bank", a competition has been announced for obtaining microcredits for young entrepreneurs of the Surkhandarya region. The winners of the competition were provided with soft loans at 5%. In 2007-2008, 644 young families in the region applied for soft loans for the purchase and construction of housing. Their documents were reviewed by working groups, and 471 young families were provided with soft loans. 61 of them received loans from the regional administration of Ipoteka Bank in the amount of 963 million 102 thousand soums [15].

To provide social protection to low-income families, a generous entrepreneur from the Denau region donated a head of cattle to 38 young families and circumcised 38 children. [16]

In 2009, in Surkhandarya region, consumer loans were issued to 220 young families, microcredits - to 1,669 young families. Their total amount was 4.2 billion soums. In addition, 759 low-income young families of the region received free livestock for 979 million soums through sponsorship. In addition, 1465 young families were provided with preferential loans for the purchase of livestock at the expense of state commercial banks and the State Fund for the Promotion of Employment [17].

## CONCLUSIONS

The role of various organizations, institutions and foundations in solving youth problems in the Republic of Uzbekistan has also grown. In the Kashkadarya region, for example, the work of trade unions has also yielded results. According to the collective agreements signed by the trade unions in 2008, 15.5 million soums were allocated for spiritual and educational work in the region, 11 million soums were allocated to replenish the library fund by equipping the premises of the "spiritual and educational" one. 700 thousand soums, 26.5 million soums for sports events. soums were spent. 1 billion soums have been spent on protecting the health of the population and members of their families, children. Of this amount, 45 million UAH. soums were formed by trade union funds. 58 young people with disabilities and 127 low-income citizens received charitable assistance in the amount of 57 million soums [18].

In the Kashkadarya region, the most important direction was humanitarian aid, financial assistance to the poor, the disabled and lonely elderly people. In 2009, the amount of funds allocated for benefits and material assistance to low-income families increased. 54 billion soums

for mothers caring for their children under 2 years old, 51 billion soums for families with children under 18 years old and 4.3 billion for low-income families. [19]

## REFERENCES

1. Dawn of Surkhan. February 7, 2008.
2. Turkiston. June 14, 2008.
3. Karimov I. On the way to modernization of the country and sustainable development of our economy. T.16. - Tashkent: Uzbekistan, 2008. -p. 166.
4. Tangriev L. Subject of youth policy: The problem of employment: Abstract of the dissertation for the degree of candidate of political sciences. - Tashkent, 2001. - p.11.
5. Karimov I. Uzbekistan for a great future. - Tashkent: Uzbekistan, 1998.-p.289.
6. State archive of the Kashkadarya region. Fund 142, List 1, Case 459, p.177.
7. Central State Archives of the Republic of Uzbekistan. Fund M-15, op. 1, room 93, fol.37.
8. State archive of the Kashkadarya region. Fund 142, List 1, Case 471, p. 8.
9. Central State Archives of the Republic of Uzbekistan. Fund M-13, 1st list, 11th building, 2nd sheet.
10. Central State Archives of the Republic of Uzbekistan. Fund M-13, 1st list, 11th building, 21st sheet.
11. Central State Archives of the Republic of Uzbekistan. Foundation M-13, list 2, case 26, p. 176.
12. Central State Archives of the Republic of Uzbekistan. Fund M-13, 2 lists, 91 case, 1 sheet.
13. Current archive of the Main Department of Labor and Social Protection of the Population of the Surkhandarya Region. 2005 data folder.–p.5.
14. Sakhovat.-Tashkent, 2006. No. 5-6 .- p.15.
15. Dawn of Surkhan. March 29, 2008.
16. Turkiston. January 27, 2009.
17. Word of the people. February 25, 2009.
18. Society. April 17, 2009.
19. Confidence. March 3, 2009.

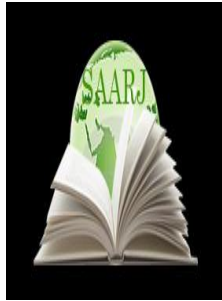

**ACADEMICIA**  
**An International**  
**Multidisciplinary**  
**Research Journal**  
 (Double Blind Refereed & Peer Reviewed Journal)



**DOI: 10.5958/2249-7137.2021.01278.7**

**ASSESSMENT OF THE BALANCE OF INTRA-CARDIAC  
 HEMODYNAMICS AND GLOMERULAR FILTRATION IN ANEMIA  
 WITH DIFFERENT HEMODYNAMIC TYPES OF CHRONIC HEART  
 FAILURE**

**Feruzha Abdusalolovna Xalilova\*; Mironshox Dilshodovich Kodirov\*\***

\*Assistant,  
 Department of “Pro-paedeutics of Internal Diseases”,  
 Bukhara Medical Institute,  
 UZBEKISTAN

\*\*5th Year Student,  
 Bukhara State Medical Institute,  
 UZBEKISTAN

---

**ABSTRACT**

*Renal fibrosis markers were evaluated in dynamics to study specific changes in the kidneys of patients with different hemodynamic types and functional classes of chronic heart failure with anemia and to evaluate the effectiveness of complex treatment. Renal fibrosis marker TGF- $\beta_1$  levels in the blood were  $2591.0 \pm 108.4$  and  $755.0 \pm 18.87$  pg / ml, respectively, in chronic heart failure with anemia and without anemia ( $p < 0.01$ ). This was indicative of a fibrosis process occurring in the kidney. After complex treatments with the addition of iron, the TGF- $\beta_1$  index decreased by 2.25 times ( $p < 0.01$ ), the clinical condition, quality of life and resistance to physical exertion changed significantly positively.*

**KEYWORDS:** *Chronic Heart Failure, Chronic Kidney Disease, Renal Dysfunction, Fibrosis Markers, Cystatin-S, TGF- $\beta_1$ , Ferro-Kinetic Indicators, Galectin-3, Hemodynamic Types.*

---

**INTRODUCTION**

Chronic heart failure is one of the leading causes of morbidity and mortality in the world and a disease of significant social and economic importance. Despite advances in the treatment of cardiovascular disease over the past 20 years, this serious complication remains an unresolved clinical problem. According to the epidemiological survey, the prevalence of chronic heart

failure ranges from 0.4% to 2% in the U.S. and European countries, a significant increase with age, reaching 10% in those over 60 years of age.

At the same time, the incidence of chronic heart failure on the planet has been steadily increasing, reaching a level comparable to the most dangerous infectious epidemic diseases in terms of scale and speed of spread (1). About 5.8 million people in the United States and 23 million in the world suffer from Chronic Heart Failure (7.S. 9-13).

It is known that the development of systemic organ damage in CHD, the remodeling of the left ventricle of the heart from its earliest period plays an important role (16. S 107-110).

### **THE MAIN FINDINGS AND RESULTS**

According to the recommendations of the European Society of Cardiologists (ESC 2016), from 2016, patients with CHD are divided into 3 groups, taking into account hemodynamic disorders. According to the indicators of the left ventricular hematopoietic fraction, its reduced (<40%), intermediate (40-49%) and preserved ( $\geq 50\%$ ) types are distinguished. The standard composition of pharmacological treatment gives a relatively positive result in patients with a decrease in blood drive fraction. In contrast, almost no positive effect is observed in standard pharmacological treatments, with the exception of nitrates in the CHD where the driving fraction is preserved. Therefore, the decompensation phase of the disease leads to negative consequences in almost all cases. Indeed, a number of authors have suggested that left ventricular diastolic filling disorders play a more important role in the pathogenesis of CHD than systolic dysfunction, the severity of the disease, and its consequences. The process of diagnosing diastolic SLE is complex and its pathophysiology has not been fully studied (12 pp. 1444 - 1451; 6 pp. 1-12; 3 pp. 36-46; 15 pp. 1742-1749; 10 pp. 1354-1360). ).

As mentioned above, in addition to the prevalence of CHD, it is distinguished from a number of other diseases by its adverse effects and high rate of disability [13]. The average 5-year mortality rate in the population of patients with CHD (I-IV FS) was 59% in men and 45% in women, and was 6-7 times higher than in the general population of the same age (5s.20-26 88s-99- 107.58 pp. 27-36). This is because the degree of damage to the myocardium, along with other organs and systems, ie comorbidity, plays an important role in this complication, which determines the fate of patients and the consequences of the disease (15 p.93-102). Among them, anemia has a special place and is often accompanied by CHD (2016; 11 (1): 37-46). Anemia not only exacerbates the symptoms of CHD, but also worsens quality of life by prolonging hospitalization, reduces resistance to physical exertion, and increases the risk of death by 2 or more times (175 pp.93-102). It should be noted that there is a weak (weak) feedback between hemoglobin and the left ventricular blood drive fraction (28.p.106).

A number of observations have shown that in patients with CHD, anemia is an independent risk factor, in which myocardial oxygen supply is significantly reduced (176 pp. 101-106).

It is known that in addition to anemia, a number of other polymorbid diseases are also detected in patients with CHD. Among them, renal dysfunction plays a leading role not only in the pathogenesis and development of CHD, but also in the exacerbation of anemia (48 pp. 13-24). (2014. T. 112. № 8. S. 7-37.)

## THE AIM OF THE STUDY

To evaluate the effectiveness of antianemic therapy based on standard therapy in renal and cardiac fibrosis processes in patients with different hemodynamic types of chronic heart failure with anemia (preserved interval and low).

## MATERIALS AND METHODS OF RESEARCH

The 120 patients with CHD involved in the study were divided into 2 groups (75 of them with anemia and 45 without anemia) and underwent excellent clinical and laboratory examinations. In order to carry out the tasks set before us, 75 patients with CHD anemia were divided into 3 groups (in each group there were 25 left ventricular hemorrhage fractions, intermediate and low ones). Their ages ranged from 50 to 70, with an average of  $64.0 \pm 5.0$ . All patients were followed up in an outpatient setting after treatment in a hospital setting. The clinical classification of the patients in follow-up is given in Table 1.

**TABLE 1 CLASSIFICATION OF PATIENTS INVOLVED IN THE STUDY**

№	Indicators	Group I n=75		Group II n=45	
		Absolutely	%	Absolutely	%
1.	Men	32	42,7	25	
2.	Women	43	57,3	20	55,5
3.	Ischemic heart disease	45	60,0	36	44,5
4.	Ischemic heart disease, post-infarction cardiosclerosis	25	33,4	8	17,8
5.	Hypertension	5	6,6	1	2,2
6.	Obesity	12	16	11	24,5

Group I patients were given 200 mg of iron III hydroxide sucrose complex (venofer) intravenously as an antianemic treatment based on standard treatment of CHD during hospital treatment. The total dose of the drug administered to eliminate iron deficiency, using a special formula adopted for the treatment of venofer [total iron deficiency = body weight, kg x (150 - patient hemoglobin index Hb, g / l) x 0.24 + 500 mg] calculated.

Group II patients were prescribed the generally accepted standard treatment for CHD.

As standard treatment for CHD, patients in both groups received angiotensin-converting enzyme inhibitors or angiotensin receptor antagonists, b-adrenoblockers, and mineralocorticoid receptor antagonists (as an eplerenone-antifibrosis drug).

The diagnosis of CHD and its functional classes in the patients included in the study were determined on the basis of their complaints, anamnesis, objective examination and laboratory-instrumental examinations, and according to the criteria of the New York Heart Association (New York Heart Association, 1964).

It was also based on the recommendations of the World Health Organization (hemoglobin <13.0 g / dl for men and <12.0 g / dl for women) as the primary criterion for anemia in group I patients.



## RESULTS AND ANALYSIS

Serum ferrokinetic parameters, cardiac and renal fibrosis markers, hemodynamic types, and the presence or absence of anemia were compared in all groups of patients involved in the study. Information about them is given in Table 2.

**TABLE 2 DIFFERENT HEMODYNAMIC TYPES OF CHRONIC HEART FAILURE ARE INDICATORS OF CARDIAC AND RENAL FIBROSIS AND GLOMERULAR FILTRATION RATE IN THE ABSENCE OF ANEMIA AND ANEMIA**

Indicators	Patients with chronic heart failure anemia and anemia								
	Patients with left ventricular hemorrhage and anemia n = 25 > 50%	Patients with left ventricular hemorrhage and n = 15 > 50%	P	Patients with left ventricular hemorrhage fraction intermediate and anemia n = 25 > 40% = < 50%	Patients with left ventricular hemorrhage fraction intermediate and incomplete n = 15 > 40% = < 50%	P	Patients with decreased left ventricular hemorrhage and anemia n = 25 < 40%	Patients with reduced left ventricular hemorrhage and incontinence n = 15 < 40%	P
Hemoglobin - g / l	98,5±1,2	139,9±2,0	<0,001	98,6±1,3	134,9±1,6	<0,001	98,5±1,2	139,9±2,0	<0,001
Iron - mk. mol / l	9,7±0,6	25,1±0,8	<0,001	9,4±0,8	22,7±0,6	<0,001	7,9±0,6	22,1±1,0	<0,001
Ferritin - mkg / l	202,3±14,9	332,5±30,5	<0,001	200,4±18,5	352,0±10,4	<0,001	101,0±3,3	363,0±15,9	<0,001
Transferrin - g / l	3,92±0,24	4,3±0,3	<0,001	4,2±0,2	3,7±0,2	<0,005	4,8±0,3	3,6±0,37	<0,001
Gale	22,54±1,	19,23±1,	<0,0	19,55±	18,48±	<0,0	19,02±	13,37±	<0,0

ctin - ng / ml	1	12	5	1,3	1,5	5	1,17	1,4	5
Alde stero ne- pg / ml	566,7±14 ,3	526,6±13 ,8	<0,0 5	529,04 ±15,4	468,7± 23,8	<0,0 5	485,2± 14,4	406,3± 20,3	<0,0 5
TGF -β1- pg/m l	2554,7±1 25,4	2209,4±1 22,2	<0,0 5	2832,7 ±176,0	2194,3 ±75,8	<0,0 5	2332,8 ±167,8	1994,2 ±73,1	<0,0 5
Cyst atin S mg /l	1,39±0,0 5	1,25±0,0 5	<0,0 5	1,58±0, 15	1,19±0 ,12	<0,0 5	1,32±0 ,12	1,26±0 ,02	<0,0 5
Ball filtra tion ml / min	65,6±2,4 5	68,4±2,3	<0,0 5	67,8±2, 64	72,8±1 ,17	<0,0 5	58,2±1 ,7	69,95± 1,05	<0,0 5
Sodi um - m.m ol / l	136,28±1 ,73	132,8±1, 6	<0,0 5	138,24 ±1,72	141,2± 1,2	<0,0 5	135,42 ±1,3	143,6± 1,14	>0,0 5
Potas sium - m.m ol / l	7,86±0,5	7,9±0,5	<0,0 5	7,47±0, 46	7,9±0, 6	<0,0 5	7,5±0, 5	7,9±0, 62	<0,0 5
Chlo rine ml.m ol / l	104,1±1, 56	103,4±1, 5	<0,0 5	105,32 ±1,5	108,7± 1,12	<0,0 5	106,2± 1,45	109,7± 1,13	<0,0 5

In the groups where the left ventricular hemorrhage fraction was maintained and anemic, hemoglobin, iron, ferritin, and transferrin levels were found to be 29.6%, 61.3%, 39.1%, and 8.8% lower ( $p < 0.001$ ), respectively, than in non-anemic groups. The left ventricular hemorrhage fraction was 26.9%, 55.8%, 43.1%, 13.5% in the intermediate group, and 29.5%, 64.2%, 72.1%, and 33.3% in the decreased ventricular fraction decreased, respectively, with a reliable difference ( $p < 0.001$ ). These indicators indicate that patients are reliably distributed in groups based on hemoglobin indicators.

In recent years, galectin-3 has been proven to be a reliable marker of fibrosis in pathological processes in the body and primarily in the heart. However, although this marker has been studied in CHD, there is no data in the available literature on its change in anemia. In the left ventricular

hemorrhage fraction observed in our observations, in the intermediate and decreased groups, when they passed with anemia and without anemia, the galectin-3 values were  $22.5 \pm 1.1$  and  $19.23 \pm 1.1$ ,  $19.55 \pm 1.3$  and  $18.5 \pm 1.5$ ,  $19.02 \pm 1.2$ , and  $13.2 \pm 1.4$ , respectively. ng / ml was equal to ( $p < 0.05$ ). At the same time, its indicators were 1.2, 1.1 and 1.4 times higher in different hemodynamic types, respectively, than in those who did not have anemia.

It is known that aldosterone is actively involved not only in water-salt metabolism in the body, but also in fibrous processes, which has been proven in numerous studies. In recent years, there have been reports that this hormone is produced not only in the adrenal glands, but also in other internal organs, including the kidneys and heart. Numerous studies have been conducted on the modification of CHD under the influence of various FS and a number of drugs. However, data on aldosterone levels in the blood are insufficient when this severe complication occurs in comorbidity with anemia. In this context, we studied its indications in patients with CHD anemia and anemia.

At the same time, aldosterone was 1.1, 1.1, and 1.2 times ( $p < 0.05$ ) significantly higher in patients with left ventricular hemorrhage, interstitial, decreased, and anemia than in non-anemic patients, respectively. The indicators confirm that not only the hemodynamic types of CHD but also the presence of anemia increases aldosterone in the blood, and therefore fibrous processes increase.

TGF- $\beta_1$  plays a leading role in the development of fibrous processes in the body and primarily in kidney tissue. However, there is insufficient data in scientific sources on the change of this cytokine in CHD with anemia. In patients with left ventricular hemorrhage fraction, intermediate, decreased, and anemia and anemia without follow-up, TGF- $\beta_1$  values were  $2554.7 \pm 125.4$  and  $2209.4 \pm 122.2$  ( $p < 0.05$ ),  $2832.7 \pm 176.0$ , and  $2194.3 \pm 75.8$  ( $p < 0.05$ ), respectively.  $2332.8 \pm 167.8$  and  $1994.2 \pm 73.1$  pg / ml ( $p < 0.05$ ).

Cytokine levels were 13.5%, 22.5%, and 14.5%, respectively, in the presence of anemia and in the absence of anemia.

It is known that in recent years, special attention is paid to cystatin-C in the assessment of renal function. It has a number of advantages over creatinine. Therefore, we determined cystatin-C levels in the blood of patients in our follow-up and assessed glomerular filtration using it. Cystatin-C rates were 10.1%, 24.6%, and 4.54% higher, respectively, in patients with left ventricular hemorrhage fraction, intermediate, decreased, and anemic groups than in anemic patients.

It has been shown that early development of fibrous processes in the kidneys of patients with anemia and the process adversely affects the functional state of the kidneys.

Cystatin-C-assisted glomerular filtration rates also confirm these changes, i.e., a significant decrease ( $p < 0.05$ ) of 4.3%, 7.4%, and 20.2%, respectively, compared with non-anemics when anemia was detected in all hemodynamic types.

In the next phase of our study, the correlation between cardiac and renal fibrosis markers and fibrosis markers with the identified ferrokinetic parameters was studied. The relationship between the 6-minute walking test and aldosterone levels among all hemodynamic types of CHD with anemia is shown in Figure 1.

FIGURE 1

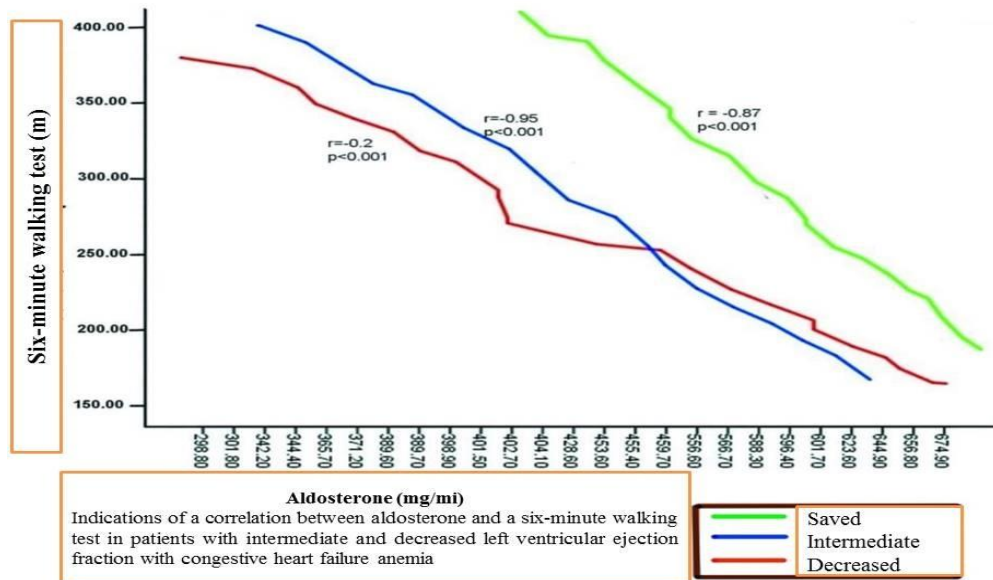

In which the left ventricular hemorrhage fraction was preserved, the correlation between the indicators recorded in intermediate and decreased patients was  $r = -0.87$ , respectively;  $p < 0.001$ ,  $r = -0.95$ ;  $p < 0.001$  and  $r = -0.2$ ;  $p < 0.01$ . In all cases, a reliable negative correlation was found between aldosterone and the 6-minute walking test. This confirms that an increase in aldosterone in the blood, which is one of the markers of fibrosis in the kidneys and heart, has a convincing negative effect on patients' resistance to loads.

Also, among all hemodynamic types of CHD with anemia, the correlation between the 6-minute walking test and galectin-3, which is a reliable marker of fibrous processes in the heart, was  $r = -0.95$ , respectively;  $p < 0.001$ ,  $r = -0.97$ ;  $p < 0.001$  and  $r = -0.89$ ;  $p < 0.01$  was equal to (Figure 2).

FIGURE 2

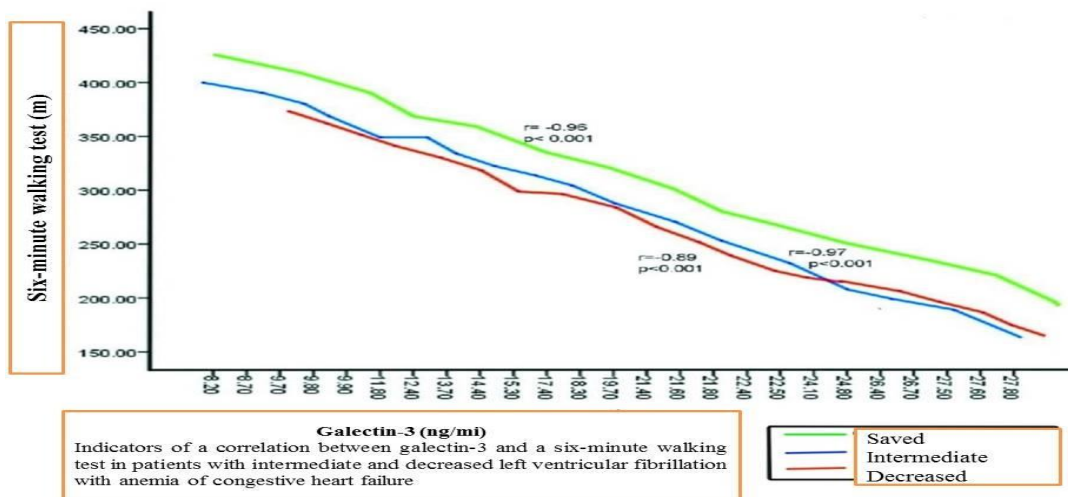

This analysis showed that there was a reliable inverse relationship with galectin-3 in all hemodynamic types and in 6-minute walking synapses.

Although the figures in Figures 1-2 above showed a reliable correlation between fibrosis markers in all types of CHD and patient resistance to physical activity, the high correlation was more pronounced in CHD left ventricular hemorrhage fraction preserved and in intermediate types (respectively  $r = -0.87$ ;  $p < 0.001$ ,  $r = -0.95$ ;  $p < 0.001$  and  $r = -0.95$ ;  $p < 0.001$ ,  $r = -0.97$ ;  $P < 0.001$ ). These results confirm the data in the literature on the fact that the diastolic type of CHD is accompanied by more fibrous processes.

In the next step, we studied the interaction between galectin-3 and aldosterone, which are reliable markers of fibrosis processes in the body (Figure 3).

**FIGURE 3**

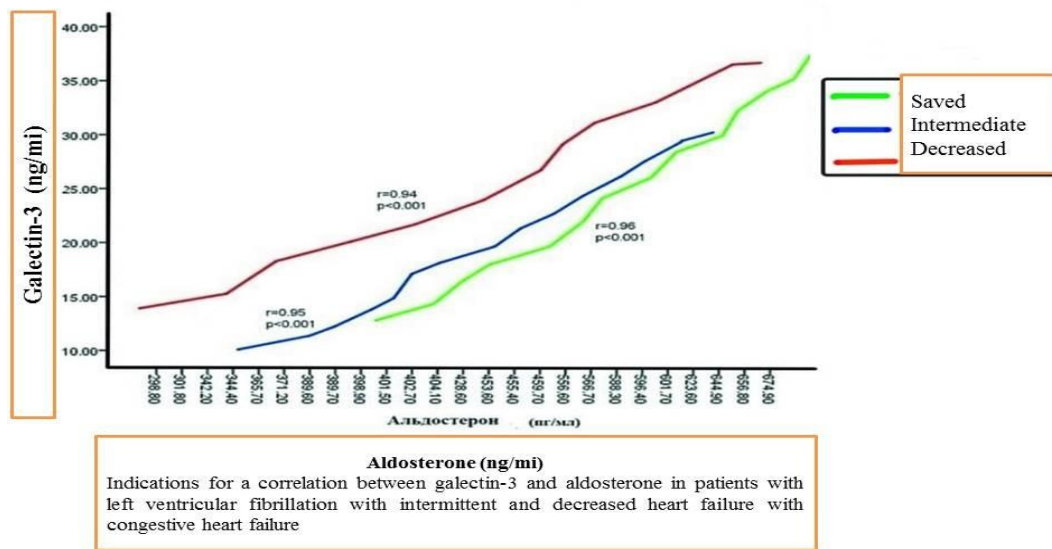

As shown in the diagram, these markers have a mutually reinforcing effect on each other, so an increase in one leads to an increase in the other. This process is confirmed by the existing positive correlation between them in all hemodynamic types of CHD ( $r = 0.94$ ;  $p < 0.001$ ,  $r = 0.95$ ;  $p < 0.001$  and  $r = 0.96$ ;  $p < 0.001$ , respectively). Therefore, when CHD is observed with anemia, fibrous processes in the body coexist and have a strengthening effect on each other.

A reliable negative correlation was also found between ferritin and fibrosis markers galectin-3 and aldosterone ( $r = -0.43$ ;  $p < 0.05$  and  $r = -0.42$ ;  $p < 0.05$ ) in the group with anemia in which the CHD hemorrhage fraction was preserved.

In the next stage, patients with CHD anemia and decreased left ventricular hemorrhage fraction were identified in the blood and correlated with ferrokinetic indicators and cardiac fibrosis marker galectin-3 and cystatin-C, widely used in recent years in the assessment of renal functional status; with TGF- $\beta_1$  we studied the dependencies (Figure 4).

FIGURE 4

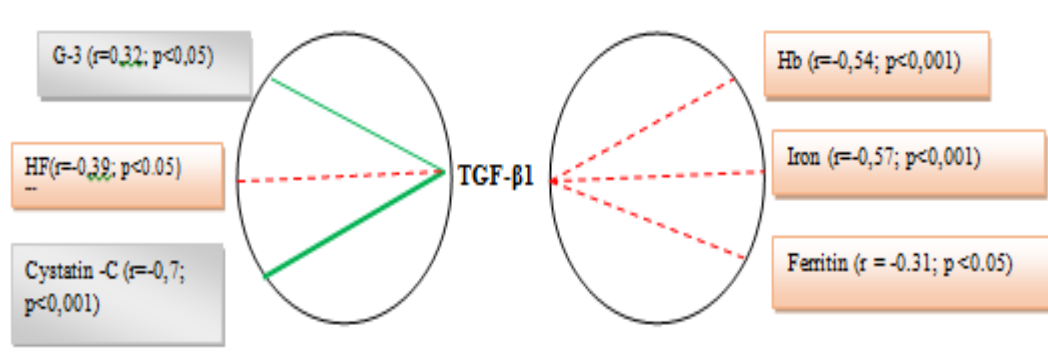

HF - hemorrhage fraction

### Correlation between TGF- $\beta_1$ and ferrokinetic parameters, galectin-3, cystatin-C, and hemorrhagic fraction in patients with decreased left ventricular hemorrhage fraction in chronic heart failure anemia

As shown in Figure 4, an increase in TGF- $\beta_1$  in the blood leads to a reliable decrease in the left ventricular hemorrhage fraction ( $r = -0.39$ ;  $p < 0.05$ ). It was also noted that TGF- $\beta_1$  is negatively correlated with ferrokinetic parameters. In this case, it is correspondingly with a hemoglobin index  $r = -0.54$ ;  $p < 0.001$ , with serum iron  $r = -0.57$ ;  $p < 0.001$ , with ferritin  $r = -0.31$ ;  $p < 0.05$  was detected. These indicators confirm that the renal fibrosis marker interacts with the markers confirming anemia, leading to the development of fibrous processes.

A study of ferrokinetic factors affecting ball filtration rate (BFR) revealed a number of correlations as shown in Figure 5. In particular, an increase in hemoglobin in the blood leads to a parallel increase in BFR ( $r = 0.517$ ;  $p < 0.01$ ). A similar correlation was observed between CFT and serum iron and ferritin ( $r = 0.66$ ;  $p < 0.001$ ) and ( $r = 0.45$ ;  $p < 0.05$ ), respectively. These figures confirm that a positive correlation between ferrokinetic parameters and BFR has a positive effect on renal function (Figure 5). Therefore, the elimination of iron and ferritin deficiency in the body has a positive effect on the functional state of the kidneys, stabilizes the general condition of patients and improves quality of life.

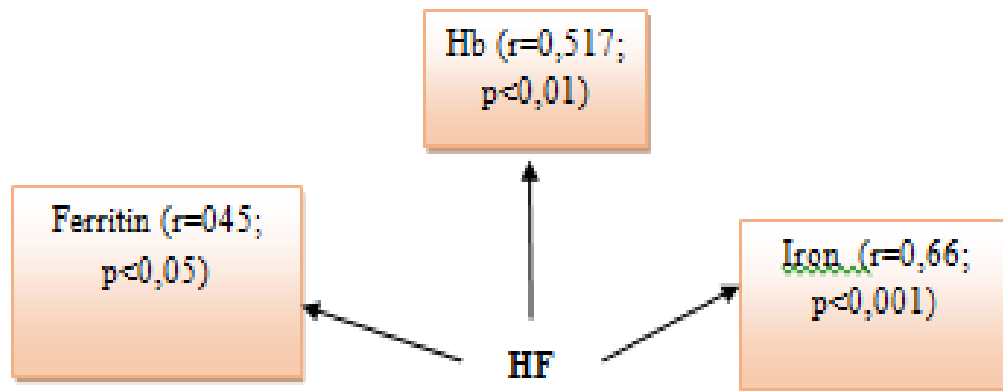

FIGURE 5

### Correlation between the rate of glomerular filtration rate and ferrokinetic parameters in patients with decreased left ventricular hemorrhage fraction in anemia with chronic heart failure.

The association between cystatin-C and ferrokinetic parameters, which have been widely used in the assessment of renal functional status in recent years, has shown that an increase in it in the blood leads to an increase in anemia.

In particular, an increase in cystatin-S in the blood leads to a reliable decrease in hemoglobin ( $r = -0.30$ ) and serum iron and ferritin ( $r = -0.48$  and  $r = -0.29$ ) ( $p < 0.05$  in all cases) (Figure 6).

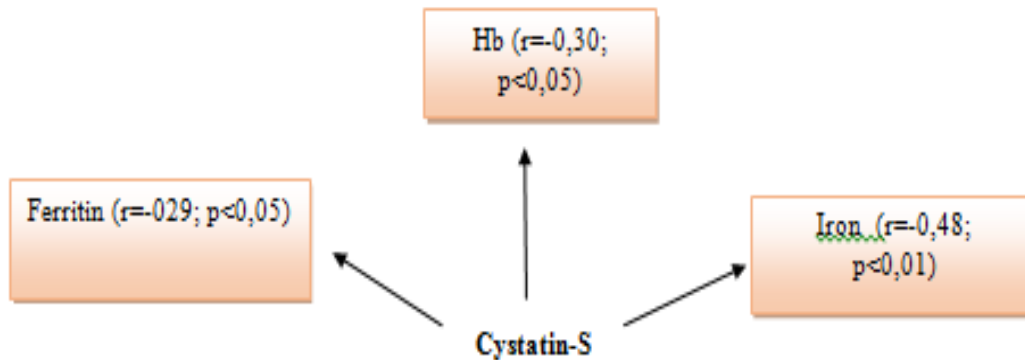

FIGURE 6

### Correlation between cystatin-C and ferrokinetic parameters in patients with decreased left ventricular ejection fraction with chronic heart failure anemia

The results confirm that anemia is synchronized with an increase in cystatin-C levels in the blood and that they have an aggravating effect on each other.

It was also found that there was a negative correlation ( $r = -0.96$ ;  $p < 0.01$ ) between the hemorrhage fraction and the endurance index in patients with decreased left ventricular hemorrhage fraction (Figure 7).

FIGURE 7

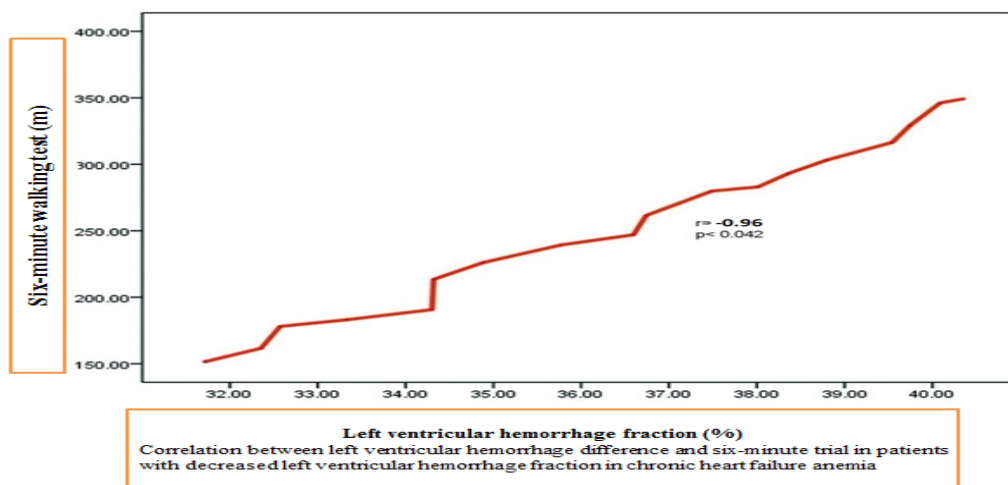

It has been proven in numerous studies that a decrease in the left ventricular hemorrhage fraction leads to a decrease in the level of endurance of patients to physical exertion.

The results confirmed that galectin-3 and TGF- $\beta_1$ , which indicates fibrosis processes in the heart and kidneys, and aldosterone, a marker of fibrosis in both organs, increased in parallel when CHD was associated with anemia. At the same time, the increase in the marked markers was more pronounced in the CHD hemorrhage fraction was preserved and in the intermediate hemodynamic types, ie diastolic dysfunction. In cases where CHD was accompanied by a decrease in left ventricular hemorrhage fraction, a clear reliable negative correlation between renal fibrosis marker TGF-b1 and cystatin-S and ferrokinetic parameters was found. This confirms that the development of fibrous processes when CHD is accompanied by anemia and an excess of cystatin-C in the blood leads to an exacerbation of existing anemia. The results show that mononitric and antifibrosis treatments should be performed on the basis of standard treatment in CHD with anemia.

## CONCLUSION

1. An increase in galectin-3 levels in the blood led to a reliable decrease in the six-minute walking test in all hemodynamic types (preserved, intermediate, and decreased) with chronic heart failure anemia.
2. A positive reliable correlation between aldosterone and galectin-3 confirmed in all hemodynamic types of chronic heart failure with anemia confirmed the synchronization of fibrous processes in the body.
3. An increase in galectin-3 in the blood resulted in a correspondingly reliable decrease in the six-minute walking test in all hemodynamic types (preserved, intermediate, decreased) with chronic heart failure anemia.
4. Negative correlation between TGF-b1 and ferrokinetic parameters, i.e. hemoglobin, iron and ferritins, they have been shown to have a mutually reinforcing effect.
5. High levels of aldosterone were detected in patients in the group where the left ventricular hemorrhage fraction was maintained.

## REFERENCES

1. Atroshenko E. S. (2007) *Patient with chronic heart failure and preserved systolic function of the left ventricle* / E. S. Atroshenko // Heart failure. – Tashkent: 8. - 6. –pp. 297-300. (Atroshenko Ye. S. Pasiient s xronicheskoy serdechnoy nedostatochnost'yu i soxranennoy sistolicheskoy funksiey levogo jeludochka / Ye. S. Atroshenko // Serdechnaya nedostatochnost'. – 2007. – T. 8. – 6. – S. 297-300.)
2. Belyalov F.I. (2012) *Treatment of internal diseases in conditions of comorbidity: monograph.* / F.I.Belyalov. - 8th ed. - Irkutsk: RIO Igiuva. – p. 285. (Belyalov F. I. Lechenie vnutrennix bolezney v usloviyax komorbidnosti: monogr. / F. I. Belyalov. – 8-e izd. – Irkutsk: RIO IGIUVA, 2012. – 285 S.)
3. Gadaev A.G., Turakulov R.I., Kurbonov A.K. (2019) Occurrence of anemia in chronic heart failure and its negative impact on the course of the disease // *Medical Journal of Uzbekistan.* 2. – pp. 74 - 77. (Gadaev A.G., Turakulov R.I., Kurbonov A.K. Surunkali yurak



- yetishmovchiligida kamqonlikni uchrashi va uni kasallik kechishiga salbiy ta'siri // O'zbekiston tibbiyot jurnali. – 2019 – 2. – S. 74 – 77.)
4. Gadaev A.G, Qurbonov A.K, Sabirov M.A, Sayfullayev M.B, Gadaeva N.A., Turakulov R.I. Assessment of Erythropoietin Levels and Correlation with Cytokines in Patients with Chronic Heart Failure // *International Journal of Pharmaceutical Research*. – 2021. - Vol 13P. 713-720.
  5. Naumova L.A., Osipova O.N. (2016). Comorbidity: mechanisms of pathogenesis, clinical significance // *Modern problems of science and education*. 5. - pp. 19-26. (Naumova L.A., Osipova O.N. Komorbidnost': mexanizmi patogeneza, klinicheskoe znachenie // *Sovremennye problemi nauki i obrazovaniya*. – 2016. – 5. – S. 19-26.)
  6. Ewans W. E. Pharmacogenomics – Drug Disposition, Drug Targets, and Side Effects / W. E. Ewans, H. L. McLeod // *N. Eng. J. Med.* – Vol. 3. – 2003. – Feb. – Vol. 48, N 6. – pp. 538-549.
  7. Bayliss E. A. Description of barriers to self-care by persons with comorbid chronic diseases / [et al.] // *Annals of Family Medicine*. – 2003. – Vol. 1. – 1. – pp. 15-21.
  8. Dickson V. V. A qualitative meta-analysis of heart failure self-care practices among individuals with multiple comorbid conditions / V. V. Dickson, H. Buck, B. Riegel // *J. of Cardiac Failure*. – 2011. – Vol. 17. – 5. – pp. 413-419.
  9. Fortin M. [et al.]. A systematic review of prevalence studies on multimorbidity: Toward a more uniform methodology // *Annals of Family Medicine*. – 2012. – Vol. 10. – 2. – P. 142-151.
  10. Longjian L. *Epidemiology of heart failure and scope of the problem* // *Cardiology Clinics*. – 2014. – Vol. 32. – pp. 1-8.
  11. Garganeeva A.A., Bauer V.A., Borel K.N. (2014) Pandemic of the XXI century: chronic heart failure - the time of modern society. Epidemiological aspects // *Siberian medical journal (Tomsk)*. – pp. 8-12; E-mail: borel.ks@ya.ru. (Garganeeva A.A., Bauer V.A., Borel' K.N. Pandemiya XXI veka: xronicheskayaserdechnayane dostatochnost' – vremyasovremennogoobshchestva. Epidemiologicheskiespekti // *Sibirskiy meditsinskiy jurnal (Tomsk)*. – 2014. – S. 8-12; E-mail: borel.ks@ya.ru.)
  12. Vertkin A.L., Romyansev M.A., Skotnikov A.S. *Comorbidity in clinical practice*. Part 1. - 2011. *Arxiv of Internal Medicine*. - 2011. - (1). – pp. 16-20. (Vertkin A.L., Romyansev M.A., Skotnikov A.S. Komorbidnost' v klinicheskoypraktike. Chast' 1. – 2011. *Arxivnutrenney medisini*. – 2011. – (1). – S. 16-20.)
  13. Fortin M., Bravo G., Hudon C. et al. (2005) *Prevalence of multi-morbidity among adults seen in family practice* // *Ann. Fam. Med.* 3. – pp. 223-8.
  14. Efremova Yu. E. (2015) *Treatment of edematous-syndromaprichronic heart failure*. Breast cancer. 27. – pp. 1622-1624 (Efremova Yu.E. Lechenie ot tehnogosindromaprixronicheskoy serdechnoy nedostatochnosti. *RMJ*. – 2015 – 27. S. 1622-1624.)
  15. Shah A.D., Langenberg C., Rapsomaniki E., et al. (2015) Type 2 diabetes and insides of cardiovascular diseases: a cohort study 1,9 million people. *Lancet Diabetes Endocrinol.* 3. – pp. 105-13.
  16. Lypez-Sendyn J. (2011) *The heart failure epidemic* // *Medio-graphia*. Vol. 33. – pp. 363-369.
  17. Shutov A.M., Efremova E.V. (2015) *Clinical features, quality of life, prognosis of patients with chronic cardiorenal syndrome* // *Nephrology*. – Tashkent: 19. - 2. - p. 64. (Shutov A.M.,

- YefremovaYe.V. Klinicheskieosobnosti, kachestvoizniiiprognozbolnix s xronicheskimbardiorenalnimsindromom // Nefrologiya. – 2015. – T. 19. – 2. – S. 64.)
18. Lazebnik L.B. (2005) *Aging and polymorbidity*// Medical Consilium. 12. - pp. 993-996. (Lazebnik L.B. Starenieipolimorbitnost' // Consiliummedicin – 2005. – 12. – S. 993-996.)
  19. Sharabchiev Yu.T., Antipov V.V., Antipova S.I. (2014) *Comorbidity - an actual scientific and scientific-practical problem of medicine in the XXI century* // Medical news. 8. - pp. 6-11. (SharabchievYu.T., Antipov V.V., Antipova S.I. Komorbidnost – aktualnayanauchnaya I nauchno-prakticheskayaproblemamedisini XXI veka // Medisinskienovosti – 2014. – 8. – S. 6-11.)
  20. Gubanova G.V., Belyaeva N., Shemetova G.N. (2015) Comorbid patient: stage of formation, risk factors and management tactics // *Modern problem of science and education*. 6. URL: [http:// science-education.ru/article/ view? Id = 23986](http://science-education.ru/article/view?Id=23986). (Gubanova G.V., BelyaevaYu.N., Shemetova G.N. Komorbidniypasient: etapiformirovaniya, faktoririskaitaktikavedeniya // *Sovremennie problem naukiobrazovaniya*. – 2015. – 6. URL:[http:// science-education.ru/article/ view?id=23986](http://science-education.ru/article/view?id=23986).)
  21. Shukurov R.T., Abdullaev T.A. (2017) Gender differences and comorbidity in patients with chronic heart failure // *Cardiovascular therapy and prevention*. 16 (6). –pp. 87-91. (Shukurov R.T., Abdullaev T.A. Gendernierazlichiyai komorbidnost u bolnix s xronicheskoyserdechnoy nedostatochnostyu // *Kardiovaskulyarnayaterapiyaiprofilaktika*. – 2017. 16(6). – S. 87-91.)
  22. Roig E. La anemiaEn La Insuficienciacardiaca. ¿EsOOHmarcadordegradadoobjetivoterapéuticoOOH? // *Rev EspCardiol*. – 2005. – Vol. 58. – P. 10-12.
  23. Sharma R., Anker S. D. (2001) The 6-minute walk test and prognosis in chronic heart failure- the available evidence // *Eur Heart J*. Vol. 22. - pp. 445-448.
  24. Ni H., Toy W., Burgess D. et al. Comparative responsiveness of short – Form 12 and Minnestota Living With Heart Failure Questionnaire in patients with heart failure // *J. Card. Failure*. - 2000. - Vol. 6, №2. - pp. 83-91.
  25. Mareev V. Yu. Results of the most interesting research on the problem of cardiac sufficiency in 1999 // *J. Heart failure*. - 2000. - Volume 1, No. 1. - pp. 8-17. (Mareev V. Yu. Results naibolee interesnyx issledovaniy po problem serdechnoyne dostatochnosti v 1999 godu // *J. Serdechnaya nedostatochnost*. - 2000. - Tom.1, №1. - S. 8-17.)
  26. Tosheva Khakima Bekmurodovna, Erkinova Nigora Erkinovna, Gadaev Abdigaffar Gadaevich, Djuraeva Nozima Oripovna, Khalilova Feruza Abdusalolovna. Comorbid States in Patients with Chronic Heart Failure. Regional Level of the Problem (Preliminary Study) // *Journal of Cardiovascular Disease Research*. – 2020 – Vol. 11, - pp. 59-65.
  27. ToshevaKh.B., Xalilova F.A., Gadaev A.G., Erkinova N.E., Djuraeva N.O. Impact Of Chronic Heart Failure On Comorbidities In Hot Climates On The Quality Of Life And Clinical Condition Of Patients // *European Journal of Molecular & Clinical Medicine*. -2020 – Vol. 7, - pp. 1080-1089.
  28. Gadaev A.G., Tosheva X.B., Elmurodov F.X., Xalilova F.A. Fibrous changes in the kidneys in patients XSN. *Therapy Bulletin of Uzbekistan*. 2018. - pp. 86 - 90.
  29. Gadaev A.G., Xalilova F.A., Elmurodov F.X., Tosheva X.B. Structural and functional changes in the kidneys and heart in patients with XSN. *Therapy Bulletin of Uzbekistan*. 2018. -1. – pp. 100-104.

30. Roig E. (2005) La anemia Yon La Insuficiencia sardias. ¿EsOOH marcador gegravedado having burned the UN therapy? // Rev Espardiol. Ох. 58. - pp. 10-12. (Roig E. La anemia En La Insuficiencia cardiaca. ¿EsOOH marcador degravedado objetiv oterapйutico OOH? // Rev EspCardiol. – 2005. – Vol. 58. – P. 10-12.)
31. Fortin M., Bravo G., Hudon C. etai. (2005) Prevalence of multi-morbidity among adults seen in family practice // Ann. Fam. Med. 3. – pp. 223-8.
32. O’Meara E, Clayton T, McEntegart MB, McMurray JJ, Lang CC, Roger SD, Young JB, Solomon SD, Granger CB, Ostergren J, Olofsson B, Michelson EL, Pocock S, Yusuf S, Swedberg K, Pfeffer MA [Anemia and Iron Deficiency in Heart FailureCurrent Concepts and Emerging TherapiesInder S. Anand andPankaj GuptaOriginally published2 Jul 2018https://doi.org/10.1161/CIRCULATIONAHA.118.030099Circulation. 2018;138:80–98;).
33. Mehta RL, Rabb H, Shaw AD, et al. Cardiorenal syndrome type 5: clinicalpresentation, pathophysiology and management strategies from theeleventh consensus conference of the Acute Dialysis Quality Initiative(ADQI). Contrib Nephrol. 2013;182:174–194).
34. Inder S. Anand and Pankaj GuptaAnemia and Iron Deficiency in Heart Failure, Current Concepts and Emerging Therapies/, in Depht, 10.1161/CIRCULATIONAHA.118.030099, Circulation July 10, 2018.
35. Gadaev A.G., Qurbonov A.K., Tosheva X.B., Erkinova N.A., Turakulov R.I. (2019) Principles of treatment of chronic heart failure with anemia // *Bulletin of the Tashkent Medical Academy*. №2. - pp.18 - 21. (Гадаев А.Г., Курбонов А.К., Тошева Х.Б., Эркинова Н.А., Туракулов Р.И. Сурункали юрак етишмовчилиги камқонлик билан кечганда даволаш тамойиллари // Тошкент тиббиёт академияси ахборотномаси. – 2019. - №2. - С.18 – 21.)
36. Gadaev A.G. Qurbonov A.K., Turakulov R.I. (2019) Occurrence of anemia in chronic heart failure and its negative impact on the course of the disease // *Medical Journal of Uzbekistan*.№2. - pp. 74 - 77. (Гадаев А.Г. Курбонов А.К., Туракулов Р.И. Сурункали юрак етишмовчилигида камқонликни учраши ва уни касаллик кечишига салбий таъсири // Ўзбекистон тиббиёт журнали.- 2019. - №2. - С. 74 – 77.)
37. Tosheva Kh. B.,Gadaev A. G. *Dynamics of Renal Fibrosis Markers on the Basis of Complex Treatment in Chronic Heart Failure with Anemia* // *Psychology and Education*. – 2021.- Vol. 3.- P. 1291-1301

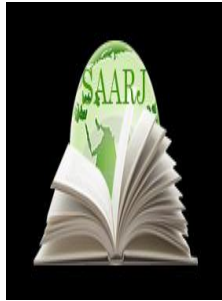

**ACADEMICIA**  
**An International**  
**Multidisciplinary**  
**Research Journal**  
 (Double Blind Refereed & Peer Reviewed Journal)



**DOI: 10.5958/2249-7137.2021.01279.9**

**PSYCHOLOGICAL SERVICE AND MODELS OF PSYCHOLOGICAL ASSISTANCE FAMILY AS A NECESSARY FACTOR OF FAMILY STRENGTHENING**

**Feruz Akmalovna Akramova\***

\*Associate Professor,  
 Doctor of philosophy (PhD) of Psychological Sciences,  
 Tashkent State Pedagogical University named after Nizami  
 Tashkent, UZBEKISTAN  
 Email id: akramova\_feruz@mail.ru

**ABSTRACT**

*This article analyzes the social features of the transformation of the family institution on the example of Uzbekistan. In order to solve and prevent family problems, a psychological service is offered, and models of psychological assistance are recommended as necessary factors for strengthening families. For psychological assistance, the need for explanatory work, psychological counseling and appropriate recommendations are substantiated.*

**KEYWORDS:** *Family, Types Of Family Transformation, Psychological Assistance To The Family. Psychological Service To The Family, Models Of Psychological Assistance, Psychological Counseling, Psychological Factors, Recommendations.*

**INTRODUCTION**

It is well known that the family is a miniature model of the state, the basis of society. Since the second third of the twentieth century, family issues have come to the fore in both science and politics, becoming one of the global problems.

Family and marriage is a complex social institution, the problems of which are studied and practically solved by specialists in various fields: lawyers, sociologists, demographers, psychologists, teachers, sexologists, narcologists. Family and marriage issues in the humanities are explained not only by the expansion of the problems and objects of these sciences, but also by the need to strengthen the family as the basis of society.

However, humanity has entered an era of radical change. The traditional institution of marriage is in crisis, the number of civil marriages is growing, family formation is giving way to career growth, people's traditional gender identity is being distorted, gender reassignment operations are being carried out, family formation and divorce are becoming commonplace, same-sex marriages are registered. etc.

It is known that the atmosphere in the family is a mirror of the state of society, forms the basis of a strong, stable and prosperous state. As a result of the transformation of social norms, the forms and functions of the family and its psychological characteristics change.

The world is divided into adherents of traditional values and radical liberalism.

Based on world practice, in recent decades in the development of the institution of the family there have been transformations: an increase in the number of divorces and single-parent families, a decrease in the number of children in families, the nuclearization of families. The modern type of marriage is characterized by a decrease in the share of registered marriages and the postponement of marriage to later ages, the only type of marriage is replaced by many types of marriage. All this affects the processes of family formation, family values, attitudes in interpersonal family relationships, etc.

It should be noted that the transformation of the family is illustrated by such an indicator as a change in family structure: mass nuclearization of the family, a decrease in the share of three-generation families, an increase in the share of elderly single people, an increase in divorces and single-parent families. families where one parent is not a relative.

The dynamics of the transformation of the institution of the family is influenced by the traditions of peoples, the preservation of the continuity of generations, the cohabitation of young families with their parents, grandparents, and an increase in the level of satisfaction with life related to children and grandchildren[18].

But in world practice, there are cases of a fall in the status of the institution of the family. According to experts, this is explained as the influence of social networks, high sexual liberation of modern youth, etc. As a result of this practice, the number of registered marriages is decreasing and the number of births of illegitimate children is growing.

To analyze the socio-psychological features of the transformation of families in Uzbekistan, Table № 1 is compiled, which provides statistics on family values: monogamy, divorce, early marriage, infidelity, multigenerational and the expected consequences of these family values on society.

**TABLE № 1 SOCIAL FEATURES OF THE TRANSFORMATION OF THE FAMILY INSTITUTION IN UZBEKISTAN**

<b>Family values</b>	<b>Unified marriage</b>	<b>Divorce</b>	<b>Early marriage</b>	<b>Treason</b>	<b>Multigeneration</b>
<b>The condition of families Of Uzbekistan</b>	Marriage as the first union: 92.0% men, 96.0% women	Divorces per 100 marriages: 10.4 Single-parent families:	Married before the age of 18: fourteen %	4.5% (Courts and Civil Registry Office)	together with parents, 68.0% young families

		1.8			
<b>Influence</b>	Born extramarital children	Social orphanhood is on the rise	Influences the growth of divorces	Affects divorce	Violation of the continuity of generations

**Source:** the table was developed based on the statistics of the State Statistics Committee of the Republic of Uzbekistan. and sociological surveys, within the framework of an applied project on the topic: "Research of priority areas of socio-economic development of the family in Uzbekistan" No. П3-2017-0928584, ID: C20140913000821 (2018-2020)

Cheating in marriage is becoming more common not only for men, but also for women. Compared to the last century, women have much more rights. The negative effect is associated with the fact that women are increasingly becoming "breadwinners of the family" and accept the model of behavior of men. Thus, among the most frequently named reasons for divorce, as shown by surveys, the majority of respondents consider regular infidelity or long-term extramarital affairs of one of the spouses to be a sufficient reason for divorce.

Nevertheless, in the context of globalization, no state is immune from the influence of transformations and negative phenomena associated with the institution of the family. In Uzbekistan, it is still not uncommon for such phenomena as: early and related marriages; divorces among young families; female crime, homelessness of minors.

## MAIN PART

We believe, given the aforementioned negative and crisis situations of families, it is necessary to introduce urgent necessary measures in the family policy of the state. Relying on state support, it is necessary to create centers for psychological assistance to families, where the main goal will be to help families in the spiritual and moral education of children and youth, to preserve marriages and family values, to support those families who need material, legal, social, psychological assistance.

Psychological assistance involves getting rid of suffering, restoring a person's ability to a normal life through various influences.

Socio-psychological service to families should be aimed at overcoming destructive social and psychological factors that impede the full functioning of the family, at supporting and strengthening families. Most often, the reasons for the need for psychological assistance to families are the following problematic issues of relationships: the uncertainty of the family roles of the husband and wife, the inconsistency of family values, marital fidelity, the problem of the style of relationships and communication with each other, overcoming conflicts, relations with the spouse's relatives, the problem of understanding each other.

Socio-psychological service to families should be aimed at overcoming destructive social and psychological factors that impede the full functioning of the family, at supporting and strengthening families. Most often, the reasons for the need for psychological assistance to families are the following problematic issues of relationships: the uncertainty of the family roles of the husband and wife, the inconsistency of family values, marital fidelity, the problem of the style of relationships and communication with each other, overcoming conflicts, relations with the spouse's relatives, the problem of understanding each other.

In Uzbekistan, for the first time, the scientific-practical and socio-psychological aspects of the psychological service in the education system were substantiated by Sh.R. Barotov [7, p. 37]. In the field of family psychological service, it is advisable to note the scientific work of such researchers as M. Argoil, A. Bodalev, V. Stolin, V. Karimova, G. Shoumarov, S. R. Barotov and others [8, c. 102]. It should be noted that at present, psychological assistance is carried out in the health care systems, physical education and sports, transport, family relations [12, p. 128].

An express survey was carried out among families to the question "Do you have conflicts in your family?" 17.0% of respondents answered that there are rarely quarrels, 76.0% - sometimes and 7.0% - constant conflicts. This result shows that families need psychological help, which is influenced by social, psychological, and economic factors. Social factors include a low level of legal literacy, a lack of knowledge about the true orders and norms of family relations, the rights and obligations of the parties, the conditions for divorce, etc.

In this direction, it is advisable to conduct explanatory work and provide assistance to the family:

- a) conduct educational work among adults and young people, form in their thinking, consciousness, the spiritual world a sense of responsibility in the family for its material well-being, education and upbringing of children, a favorable psychological climate in the family, etc.;
- b) to raise the level of the family according to family law;
- c) Explain to families about the psychological characteristics of family and marriage relations, etc.;
- d) To conduct explanatory work about the verses of the Koran, which regulated family relations;
- e) Introduce norms governing relations between spouses, moral and legal obligations of husband and wife, parents and children.

It should be noted that the types of counseling psychological assistance to families existing today in world practice are extremely diverse. They may differ in the nature of the assistance provided.

According to its orientation, psychological assistance can be carried out:

- a) Mainly to one family member due to problems that are directly or indirectly caused by his family life or its absence;
- b) a married or premarital couple;
- c) the family as a whole;
- d) parent or parents; parents and children; child or teenager [13].

Psychological assistance can be carried out in the form of psychodiagnostics, psychological counseling and psychological corrections [5].

Also, in practice, the following models of assistance are used: diagnostic, social, pedagogical, medical, psychological.

The psychological model considers family relationships, disharmony, including those associated with the development of the child's personality, his behavior. Psychological assistance involves

the analysis of the client's family situation and his personality and the creation of a "diagnosis" on its basis, which allows the counselor psychologist to help the family and its members. [3], [4].

In order [4] to effectively solve the problems of families, it is proposed:

1. Take measures to create state psychological centers to help families.
2. Take measures to form a positive image of the family and family traditions among the population.
3. In order to prevent divorce, practice the provision of psychological and practical assistance to families.
4. In cases of identification of problems (which is inevitable) to form a sense of responsibility for the preservation of the family and family values.
5. Organize constant psychological counseling in the prevention of stressful situations and the prevention of adverse situations in the family.

## CONCLUSION

In conclusion, we can say that psychological service to the family is a promising area of psychological practice, an important direction in the work of the family and marriage service. According to some reports, as a result of psychological help, 2/3 of married couples improved their relations, changed their decision to divorce, and began to treat their problems differently. Thus, the psychological service makes a real contribution to the overall social task of strengthening the family.

## REFERENCES

1. Akramova F.A. Socio-psychological attitudes of young families in Uzbekistan. // Materials of the International Scientific and Practical Conference "INNOVATIVE DEVELOPMENT AND POTENTIAL OF MODERN SCIENCE" February 17, 2020. - Prague, Czech Republic: Vydavatel "Osvi'Ceni", 2020. - p. 296-300.
2. Akramova F.A. THE DIVORCE FACTORS OF FAMILIES AND PSYCHOLOGICAL SERVICE TO THE FAMILY. International Scientific Journal ISJ Theoretical & Applied Science Philadelphia, USA issue 01, volume 81, 325-328. published January 30, 2020.
3. Akramova F.A. The main problems of conducting psychological counseling for families. // Materials of the International Scientific and Practical Conference "SCIENCE IN THE MODERN WORLD: THEORY AND PRACTICE" June 16, 2020. - Sofia, Bulgaria: Publishing House "CORoC", 2020. - pp. 268-274.
4. Akramova F.A. Socio-psychological features of strengthening the family in Uzbekistan. // Materials of the International Scientific and Practical Conference "Scientific Research of the XXI Century: Theory and Practice" ("SCIENTIFIC RESEARCH OF THE XXI CENTURY: THEORY AND PRACTICE") June 16, 2020. - Prague, Czech Republic: Vydavatel "Osvi'ceni", 2020. - p. 439-444.
5. Aleshina Yu.E. Family and individual psychological counseling / Yu.E. Alyoshina. - M.: Editorial and Publishing Center of the Consortium "Social Health of Russia", 2003. - 103 p.



6. Andronnikova O.O. The basics of psychological counseling. - M.: NITs INFRA-M, 2013. -- 415 p.
7. BarotovSh.R. Socio-psychological and scientific-practical foundations for the creation of a psychological service in Uzbekistan. Abstract of dissertation doctoral in psychology. - T. 1998. -37 p.
8. BarotovSh.R. and other Psychological service of education: from theory to practice. - Bukhara: Durdona, 2017.-172 p.
9. Boshormeni-Nagn I., Kresner B. The changing face of marriage // Journal of practical psychology and psychoanalysis. - 2007. - No. 26 (March). - S.26-34.
10. Gavrilyuk V.V., Trikoz N.A. Dynamics of value orientations during the period of social transformations (generational approach) // Sociological studies. 2002. No. 1. - P.15-24.
11. Gagai V. V. Family counseling. - S.-Pb.: Rech, 2010. - 320 p.
12. Druzhinina V.N. Family psychology. - 3rd ed. - SPb.: Peter, 2006.176 p.
13. Karabanova O.A. The psychology of family relationships and the basics of family counseling. - M.: Gardariki, 2008. -- 320 p.
14. Nartova-Bochaver S.K., BochaverS.Yu. Family living space: unification and division. - M.: Genesis, 2011. - 320 p.
15. Psychology of family relations: lecture notes // Comp. S.A. Velikova. - M.: AST; - SPb.: Sova, 2005. - 127 p.
16. Family in Uzbekistan (2013-2017). State Committee of the Republic of Uzbekistan on Statistics. Tashkent. 2018.p.43.
17. Socio-psychological and counseling work with the family: Reader / Comp. LB Schneider: at 2 o'clock - M.: Publishing house MPSI; Voronezh: NPO Modek, 2004. - 586 p.
18. Schneider LB Family psychology: textbook for universities. - Ed. 4th. - M.: Academic Project; Tricksta, 2008. - 736 p.

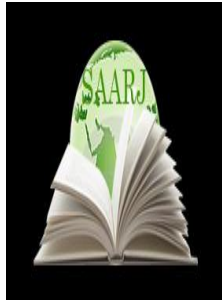

**ACADEMICIA**  
**An International**  
**Multidisciplinary**  
**Research Journal**  
 (Double Blind Refereed & Peer Reviewed Journal)



**DOI: 10.5958/2249-7137.2021.01280.5**

## METHODS OF DEVELOPING “CREATIVE THINKING” SKILLS IN TEACHING PHYSICS

**Ganiev A.G\***

\*Associate Professor,  
 Candidate of Physical and Mathematical Sciences,  
 Director of Shakhrisabz branch of Tashkent State Pedagogical University,  
 UZBEKISTAN  
 Email id: fizika.1011@mail.ru

### ABSTRACT

*The article discusses the psychological state of adolescents and opportunities for developing «creative thinking» skills in them. For indirect knowledge that is important for the natural sciences, including physics: - The role of idealization, modelling and scientific experimentation is great. These experiments deal with physical quantities. The values of the physical quantities are determined in units. The article presents an intellectual map of the International System of Units.*

**KEYWORDS:** *Methods, Developing, Interest, Opportunity, Imagination, Mind, Law, Quantity, Unit, System, Direct, Indirect, Measre, Skill, «Full Thinking».*

### INTRODUCTION

In this paper, we conseive modern methods of developing students' "creative thinking" in teaching physics to secondary school students.

10th and 11th form of pupils (teenagers) are more familiar with scientific concepts and can use them to solve some mathematical problems. This shows that theoretical and logical thinking skills have been developed in them. They have "adult" motives that require in-depth reflection on the goals and objectives of future activities. In other words, the "games" that were once the leader will begin to disappear and move to the next place. Activities such as education, communication and work will continue to grow. General intellectual abilities, especially comprehension and thinking, are formed.

As a result, jumping and sexual growth in psychological and physical development occur serious changes in the body. They become physically stronger, their abilities increase, their mental development continues, their identity develops, and their interests expand.

At this age, a new self-reliant development factor develops in children. As a result, the contradiction between his objective position and his inner world increases. They have a sense of their own ideas, proving their point, showing their growth. [1]The manifestation of creativity is curiosity. It serves as an incentive to explore the unknown world. Focusing on the unknown events provides a link between the outside and the inside. Involvement in the creative process helps to increase the activity of each person in all areas, to develop his creativity. Increased mental and physical activity during adolescence has a more positive effect on student activity. Now they are more interested in mind-numbing games and exercises that require effort and independence. This allows them to develop their mental abilities, ie "creative thinking" skills. At the same time, the "teaching methods" used in the educational process play an important role in the formation and development of "creative thinking". These styles should encourage students to think freely and increase their independence. Allowing students to enjoy their success will allow them to discover their creative talents and gain strength and confidence. This requires solving problems that require increasing levels of difficulty, a creative approach, discussing and analyzing problem situations, and so on[2]. Solving such problems allows students to assess their own creative potential, to activate their inner potential, that is, to understand themselves. The environment and science teachers in the educational institution will play an important role in the success of these processes.

The following elements should be considered in order to form a creative personality in the educational process:

- Believing that every student is gifted with creativity;
- to achieve a wide range of student development;
- increasing creative work in education;
- being the creative approach of the teacher.

### **Developing students' "imagination" and "creative thinking" skills in teaching physics**

Given the fact that adolescents' brains are well-formed, that is, they can analyze data well, and now they are taught foreign languages, natural subjects such as physics, chemistry, biology, English, German, Russian, etc. Applying existing knowledge in one subject to another gives good results[3]. In teaching most subjects in the natural sciences, including physics, have to rely on students' "imagination." Because they can only be studied indirectly, that is, by results or by some means. Indirect knowledge is knowledge gained by enhancing or facilitating the observation of human senses. An example of this is the knowledge gained through experimentation or modeling. At the same time, to analyze this knowledge, man is endowed with the ability to "think" and reason. These abilities do not mean that man is physiologically limited, and with his help man was able to look from a distance into space to the bottom of a nucleus 10-15 m in size. There are many ways to acquire indirect knowledge. These are:

- **idealization** - an ideal object is created with some limitations, and with its help the properties of a real object are studied. For example, the concepts of material point, ideal gas, absolute solid.

- **modeling**-analogy-based method. In this case, the object that is difficult to study is replaced by another object that is similar to it, but easier to study.

- The knowledge gained from studying the model is applied to the initial object. This method is used to study objects that are difficult to study directly. For example, the micro and macro worlds, which are difficult to see.

- **Experiment (a scientific experiment)** - a method of studying an object that is difficult to know directly. In this situation, human uses devices that enhance the human senses or make it easier to observe. This method transformed man from an observer of nature to a researcher. For example, Rutherford's experiment to determine the structure of the atom.

Imagination is proof that the human brain is the most advanced computer. The computer brain has "electronic literature" about many events. It is not surprising if these "electronic publications" are written in our computer brains through some genes. Our life experiences and knowledge awaken and activate these "e-books" that are "dormant". When we call this "electronic data", events unfold before our eyes. An inner voice describes events, and we can only write down what we hear and see on a piece of white paper.

Each artist depicts a scene differently. This is due to the fact that the landscape made a different impression on them. Similarly, the "electronic description" of a process in the brains of different individuals varies. This is due to the knowledge, experience and previously activated "electronic data" of the "computer brain" owner. Thinking hard about a problem, looking for something new, can activate new "information" that was previously unknown to anyone. This is called "creative thinking." These data can be proven in experiments and turned into "scientific discoveries". Einstein and Bohr's famous intellectual experiments are a good example of this. These experiments were performed in a "computer brain", their "electronic versions" were activated and only then tested in practice. Then it goes into a long memory and becomes "knowledge". As a result, this information creates a template in the brain. Subsequent information is compared with this template, and similarities and differences are noted and converted into new knowledge. The imagination divides and reconstructs the object until it finds the necessary "electronic information", which predicts the result of creation. In other words, it allows things and events that did not exist before to occur.

In addition to acquiring new knowledge using existing knowledge, imagination also helps a person to transfer knowledge from one field to another and use its conclusions to solve new problems. The elements of thought in imagination and imagination in thought complement each other.

According to A. Einstein, imagination is more important than knowledge. Knowledge is limited, "imagination" pervades the whole universe, creating development.

There is a close connection between 'creative thinking' and 'imagination'. Therefore, to improve 'creative thinking', it is recommended to practice painting, imagine the studying process, and draw a picture.

Physics is the study of the simplest and most important laws of natural phenomena, the properties of matter, its structure, and the laws of its motion.

The questions of why, why not, are the basic questions of physics.

Like all-natural sciences, the main goal of physics is to study the laws of the material world around us, the laws of nature.

What are the laws of nature?

It turns out that everything in the material world is closely intertwined. The most important of these connections are the laws of nature. The law shows exactly how changes in nature happen. For example, day alternates with night, summer with autumn, winter with spring. Why is that? It turns out that the reason for the change of day and night is that the Earth revolves around its own axis, and the reason for the change of seasons is that the Earth revolves around the sun. We know that the laws of physics are manifested by looking closely at natural phenomena.

Any physical body changes. For example, a tortoise moves, water evaporates or freezes. Such changes were noticed in ancient times: "It is impossible to enter the same river twice", - said Heraclius 544-583 BC.

**The changes that take place with physical objects are called events.**

**When the composition of a substance changes as a result of a change, such a change is called a chemical event.**

**If the changes do not change the composition of the substance, such changes are called physical phenomena.**

How to understand the meaning of physical phenomena. What methods do physicists use. The basic method of physics is the scientific method of investigation.

**Physics, not only in physics, but in all-natural sciences, has the function of a "window to the world" - to see, hear, feel (touch), feel, feel and taste.**

Because our senses are imperfect, the information we receive from them can be deceptive. One thinks about what one sees and hears and makes hypotheses. In other words, observation encourages thinking. How do you know if the Hypothesis is right for sure? To do this, special experiments are conducted, and as a result of these experiments, certain knowledge is gained.

Thus, not only physics, but also other natural sciences move along the chain of observation - thinking - experience - knowledge.

Visualization of processes in the teaching of natural sciences, including physics, to students is important in the educational process. Because visual information is recognized and recovered faster. The human brain analyzes visual information sixty thousand times faster than verbal information. Even when people were shown more than two and a half thousand images in 10 seconds, their image recognition rate was no less than 90 per cent. After a year, the figure was 63 per cent. If the information is given orally, after 72 hours, people will remember only 10% of it. If the text is presented in the form of an image, this figure increases to 65%. The colour, location, size, and movement of the image are striking. Therefore, it is advisable to use animations in the lessons. Therefore, it is advisable to use information technology to increase the productivity of education [4].

---

One of the most effective ways to visualize information and develop 'creative thinking' skills in education is through the 'Mind Map', which is widely used in education today. [5-7]

Teaching topics in all subjects using Mind Maps helps students to explore topics independently and develop their 'creative thinking' skills. The use of "intelligence maps" in activities activates the right hemisphere of children's brains, and they learn to work in the process of "full thinking". [8-9]

### **Results. System of international units of physical quantities**

#### **Mind map "System of units".**

As noted, the main method of verification in physics is experiment. Scientific theories are created in order to explain and justify the results of experiments. All this leads to the study of objective laws that exist in nature and, as a result, to the creation of physical laws related to them. The laws of physics are expressed through certain relationships between physical quantities.

**Physical size is a quantity that is quantitatively specific to each physical object, but qualitatively common to many objects and represents one of their properties. [10]**

A quantity that fully expresses a physical quantity, both quantitatively and qualitatively, is called its true value.

The values of physical quantities are determined by constantly improving experiments, and their comparison requires the introduction of agreed units (system of units).

The system of physical quantities consists of basic and derivative quantities. There are seven basic physical quantities, three of which represent the basic properties of the material world: length, mass, and time. The other four: current, thermodynamic temperature, amount of matter, and luminosity are derived from a branch of physics.

The value of a physical quantity indicates its magnitude and depends on the unit selected.

**A unit of physical quantity is a physical quantity that is used to quantify each physical quantity, conditionally denoted by a numerical value equal to one.**

Typically, the unit is denoted by the size symbol: [s] = 1m; [m] = 1 kg and so on. The set of basic and derivative units of physical quantities forms a system of units.

The International System of Units (SI) was adopted at the General Conference on Weights and Measures in 1960 and consists of seven basic units - meters, kilograms, seconds, amperes, kelvins, moles, candelas, and two -the unit is composed of radians and steradians:

meter (m) - the length of the path of light in the space at  $1/299792458$  s;

kilogram (kg) is the value of the kilogram determined using the Planck constant. [11]

second (s) is the time equal to  $9192631770$  of the radiation periods corresponding to the transition between the two ultra-thin surfaces of the basic state of the caesium-133 atom;

Kelvin (K) - a unit of temperature equal to one part of the thermodynamic temperature of the tertiary point of water from 273.15;

ampere (A) is the interaction force of  $2 \cdot 10^{-7}$  N per meter of length between these thin, infinitely long conductors located parallel to each other in space at a distance of 1 meter is the alternating current that generates;

mol (mol) - the amount of matter in the system, the components of which are equal to the components present in  $^{12}\text{C}$  nucleate with a mass of 0.012 kg;

Candela (cd) - light intensity in the direction of a source of monochromatic radiation with a frequency of  $540 \cdot 10^{12}$  Hz, energy intensity  $1/683$  W / sr;

radian (rad) - an angle between two radii and the length of the opposite arc is equal to the radius of the circle;

steradian (sr) is the spatial angle at the centre of a sphere, separating the surface from the surface of a sphere equal to the surface of a square whose side is the radius of a sphere.

Derivative units are determined according to the laws of physics.

There are two types of measurements:

- Indirect - the numerical values of physical quantities are determined directly using measuring instruments.
- Indirect - numerical values of physical quantities are calculated using the results of measurements of numerical values of other physical quantities.

Using a mind map to teach physics without putting a lot of information together can help students not only develop their “imagination” and “creative thinking” skills, but also their “full thinking” skills. [12-15]

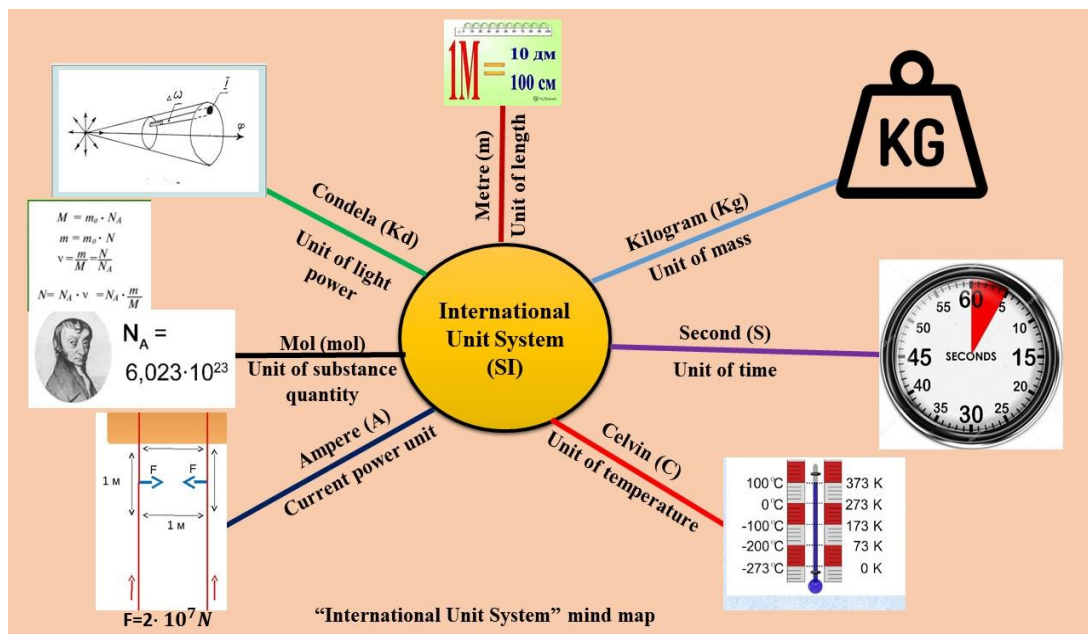

## CONCLUSION

The mental states of the 10th and 11th forms were discussed and their sense of greatness, self-demand, and interest in learning about the world.

- Given their interests, it is expedient to use indirect methods of learning, which are important in the teaching of physics, to develop the skills of "creative thinking".
- It is based on the importance of improving the "imagination" and visualizing information to improve the skills of "creative thinking".
- The main method of physics is experiments, in which the values of physical quantities are clarified. The International System of Units (SI) is used to determine the relationships between physical processes.
- The article provides a mind map of physical quantities "International System of Units". Instead of concentrating information on basic physical quantities on a mind map, it allows students to develop their "imagination," "creative thinking," and therefore "full thinking" skills.
- It is advisable to use the "mind map" to improve the methods of developing "creative thinking" skills in students.

## REFERENCES

1. Boldenko OA Palatkina GV Features of the development of creative activity of older boys. People and Education No. 1.2013, Articles 61-66.
2. Meerovich, M.I., Shragina L.I. Technology of Creative Thinking. HARVEST. MINSK. 2003 (15 pages).
3. Bono de Edward. Serious creative thinking. Minsk LLC "Potpourri", 2015
4. Medina D. "The Rules of the Brain". M. "Mann, Ivanov. And Ferber "2014 p. 240
5. T. Busen "Intellect Maps" Moscow "Mann, Ivanov and Ferver" 2019 (105 pages)
6. [www.imind map.com](http://www.imindmap.com).
7. [www.worldmindmappingcanol.com](http://www.worldmindmappingcanol.com)
8. Zdenek M. Development of the right hemisphere. Potpourri Publishing House, 2004
9. B. Edwards. Discover the artist in you. Minsk, Potpourri. 2012 r.
10. A. Ganiyev Physics 10th grade. 1st edition. Tashkent. - Niso Poligraf -2017 [www.world.mindmapping.com](http://www.world.mindmapping.com)
11. A. Ganiev. S. Normurodova. About the determination of kilograms using the Planck constant. Vocational education. №2, pages 2019.72-75
12. Ganiyev A. G. and others. THE ROLE OF "IMAGINATION" IN THE PROCESS OF "CREATIVE THINKING". DEVELOPING STUDENTS' "IMAGINATION" AND "CREATIVE THINKING" SKILLS IN TEACHING PHYSICS. Psy chology and education. (2021) 58 (1). 3569-3575 p.
13. Ganiyev A. G. and others. Biophysics of Brain activity In the Development Of "Creative Thinking" "Mind Map". Turkish Journal of Compyuter and Mathematics Education. Vol 12.№4 (2021) 1-6 p.



14. A.G.Ganiev (2021). Developing Students' 'Creative Thinking Skills in The Course of Law' Of Conservation'. The American Journal of Social Science and Education Innovations, 3(03), 564-573
15. A.G. Ganiev "Developing students' imagination and creative thinking" skills using the mind map to explain "The nature of light". Internauka №6 (192) 02/05/2021

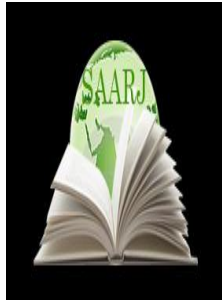

**ACADEMICIA**  
**An International  
 Multidisciplinary  
 Research Journal**  
 (Double Blind Refereed & Peer Reviewed Journal)



**DOI: 10.5958/2249-7137.2021.01281.7**

**INTENSIVE IN TEACHING ENGLISH CHARACTERISTICS OF  
 APPLICATION OF METHODS**

**Ibragimov X.I\*; Salimova Z.K\*\***

\*Professor,  
 Doctor of Pedagogical Sciences,  
 Uzbek State University of World Languages,  
 UZBEKISTAN

\*\*Lecturer,  
 Termez State University,  
 UZBEKISTAN

---

**ABSTRACT**

*The article highlights the concepts of the essence of the use of intensive methods of teaching English in general secondary schools. As you know, "On Education" and "On the National Training Program"3 The laws also set the task of training highly qualified specialists in our country who can meet the requirements of world standards. Much has changed since British researchers introduced a ridiculous language called "English into New Worlds" 400 years ago. During the 2010-2020 academic year, pedagogical experiment - test stages and its final type were conducted. Pedagogical experiments - tests In secondary schools No. 11 and 13 in Termez, classes 5a, 6a, 7a were selected as experimental, 5b, 6b, 7b as control classes.*

**KEYWORDS:** *School, Non-Traditional Teaching, Innovation, Strategy, Teaching, Student, Science, Education, Upbringing, Knowledge, System, Quality, Efficiency.*

---

**INTRODUCTION**

Educating and educating young people has always been one of the top priorities of any state. In the same way, in our country, such cases are always in the focus of attention of our leaders.

The Action Strategy on the five priority areas of development of the Republic of Uzbekistan, adopted on the direct initiative and under the leadership of the President of the Republic of Uzbekistan Sh.M. Mirziyoyev, has launched a new stage of development in the republic. The

practical results of this process are reflected today in all spheres of our lives, and most importantly, in the minds, aspirations and actions of our people.

Particular attention is paid to the improvement of the education system, which is one of the priorities of the fourth strategy of action - the development of the social sphere.<sup>1</sup> In his speeches and conversations at various meetings, the head of our state stressed the need to raise the issues of upbringing a harmoniously developed generation and a healthy lifestyle for young people.

<sup>1</sup>Decree of the President of the Republic of Uzbekistan "On the strategy of further development of the Republic of Uzbekistan". Tashkent, February 7, 2017. PF-4947.

As the President said: "If we do not bring up our children properly, if we are not aware of their behavior and mood every day, every minute, if we do not teach them science and profession, if we do not find a decent job, this deposit will be rich. We can give it away"<sup>2</sup>.

As you know, "On Education" and "On the National Training Program"<sup>3</sup> The laws also set the task of training highly qualified specialists in our country who can meet the requirements of world standards. In particular, the goal of the National Program of Personnel Training is to radically reform the education system, to completely rid it of the ideological views and deviations of the past, to develop a national system of training qualified personnel at the level of developed democracies. is to create.

The modern education system is a single purposeful process of education and upbringing. It is also the variability, as well as individualization, of the knowledge, skills, values, functions, experiences and skills acquired and implemented. If we turn to the pedagogical dictionary, we find the following definition: "Education is an integral part of society and at the same time a product of social development." This means that education is constantly evolving and must always meet the goals and objectives that society shapes.

In the recent past, the teaching of English has focused mainly on grammar. It took a lot of time to read and translate texts, and sometimes to memorize "topics" and write dictation to revive the monotony, and this process is hard work. Today, the main supply in the language market is formed depending on consumer demand.

According to SG Ter-Minasova, a leading specialist in linguistics and methods of teaching foreign languages, "Today, as a result of functionalization of language teaching and integration processes, the study of foreign languages, especially English, has become even more important.

<sup>2</sup>Mirziyoyev Sh. Let's work together for the fate and future of our country. // "People's speech", June 16, 2017.

<sup>3</sup>Laws of the Republic of Uzbekistan "On Education" and "On the National Training Program". – T.: "Sharq", 1997

But modern language learners are not interested in the history of language or its theory. English became necessary for them to meet their vital needs"[1, 27].

Modern teaching methods are widely used in the educational process of the educational institution. The use of modern teaching methods leads to high efficiency in the teaching process. When choosing teaching methods, it is advisable to choose each lesson based on the didactic task [2, 39].

Education and upbringing of a harmoniously developed generation and training of qualified personnel depend in many respects on the teacher-educator. A qualified teacher is a responsible person who has high professional skills, knowledge and skills, can use information and communication technologies, purposefully uses educational technologies in teaching, responds to the content and quality of teaching. Enrichment of training sessions with methods that activate learners depends on the level of their mastery leads to the rise of This requires a rational organization of the teaching process, increasing the interest of students in the learning process by the teacher and constantly encouraging their active participation in the learning process [3, 10-12].

In his work, the author emphasizes that the teacher in the modern lesson is not the only dominant source of information, but, as K. Rojeres (USA) emphasizes, it should be a facilitator, that is, a condition that facilitates independent learning of students, creating favorable conditions for them [4, 103].

The author has learned that the grammatical differences between the British and American versions of English are very small and insignificant in phonetic, lexical, and other terms. Much has changed since British researchers introduced a ridiculous language called “English into New Worlds” 400 years ago. The misleading part is the richness of vocabulary, and the same English words have a special meaning in the United States [5, 187-188].

This literature identifies modern methods of teaching English, which are widely used today in higher education institutions of the country, non-governmental educational institutions, comparative analysis of fundamental, linguistic, sociocultural, communicative methods, their role and importance in the educational process [6, 100].

In the first phase of our research in secondary schools, it was found that increasing students' interest in the science of English during the study of systematic program materials gives effective results.

During the 2010-2020 academic year, pedagogical experiment - test stages and its final type were conducted. Pedagogical experiments - tests In secondary schools No. 11 and 13 in Termez, classes 5a, 6a, 7a were selected as experimental, 5b, 6b, 7b as control classes.

The results in the basic experimental classes (5a, 6a, 7a classes experiment, 5b, 6b, 7b classes control) of the general education schools where the experimental training was conducted were compared with the results obtained from the control classes.

366 students took part in the experimental work: 180 students in experimental classes and 186 students in control classes.

Classes were conducted by teachers of English in secondary schools on the basis of methodological developments of the dissertation.

A comparative analysis of the results of the substantiating and concluding stages was conducted to study the final level of activity of the experimental and control class students.

Based on the experimental work and the results obtained, we came to the following conclusions:

1. The model developed for the development of English language science fully confirms the hypothesis we put forward.

2. Criteria for the effectiveness of the development of English language science in accordance with the developed model and didactic conditions.

3. Based on the conducted experimental work, the following results were noted on the criteria a) cognitive criterion - the level of knowledge of students in English is as follows: in experimental classes: quality indicator - 28.75% and 36.45% each; mastering rate - from 70.84% to 100%; average score - increased from 3.2 to 4.05; in control classes: quality indicator - from 24.55% to 30.28%; mastering rate - from 69.25% to 98%; the average score increased from 3.00 to 3.95 (see Table 1).

**TABLE-1 THE LEVEL OF DEVELOPMENT OF KNOWLEDGE OF ENGLISH IN EXPERIMENTAL AND CONTROL CLASSES**

Academic year	Experimental class			Control class		
	Quality indicator, %	Assimilation indicator, %	Average score	Quality indicator, %	Assimilation indicator, %	Average score
<b>2019-2020</b>	28,75	70,84	3,2	24,55	69,9	3,0
<b>2020-2021</b>	36,45	100	4,05	30,28	98	3,95

b) need-motivation criterion - the level of development of value orientation in students was distributed as follows: in the experimental class: the high level increased from 17.7% to 21.6% (3.9%); the average level increased from 69.6% to 71.9% (2.3%); low levels decreased from 12.7% to 6.6 (6.1%); in the control class: the high level increased from 13.5% to 17.1% (3.6%); the average level decreased from 69.3% to 68.5% (0.8%); the low level decreased from 17.1% to 14.3 (2.8%) (see Table 2).

**TABLE-2 LEVEL OF DEVELOPMENT OF INTEREST IN ENGLISH SCIENCE IN EXPERIMENTAL AND CONTROL CLASSES**

Academic year	Experimental class			Control class		
	High, %	Medium, %	Low, %	High, %	Medium, %	Low, %
<b>2019-2020</b>	17,7	69,6	12,7	13,5	69,3	17,1
<b>2020-2021</b>	21,6	71,9	6,6	17,1	68,5	14,3

c) operational-practical criterion - substantiated experimental work development of professionally significant qualities compared to the results the level ranged from 3.33 points to 4.65 points (1.32) in experimental class students points), in control class students from 3.27 points to 3.51 points (0.24points) increased (see Table 3).

**TABLE-3 A COMPARATIVE RESULT OF THE LEVEL OF DEVELOPMENT OF PROFESSIONALLY SIGNIFICANT QUALITIES IN EXPERIMENTAL AND CONTROL CLASSES**

Academic year	Experimental class	Control class
2019-2020	3,33	3,27
2020-2021	4,65	3,51

Thus, a significant increase in experimental class results was observed compared with the control class.

The analysis of the quality of knowledge, skills and competencies was carried out using evaluation criteria: the quality of mastery, the transition to automation, the completeness of scientific and conceptual mastery.

The above criteria are based on the coefficient of efficiency, the essence of which is suddenly exceeded in the situation under consideration, which once again confirms the effectiveness of the introduced areas of study in relation to their contemporaries.

The effectiveness of the developed directions of teaching optimization was evaluated using the Student t-criterion, and the results of the research showed that they were statistically significant and not random.

In the experimental and control classes conducted at Termez Secondary School No. 11, the mastery rate was 67% in the control classes, while in the experimental test classes this figure was 90% (see Table 4).

**TABLE-4 TERMEZ CITY 11TH GRADE STUDENTS HAVE MASTERED ENGLISH IN EXPERIMENTAL AND CONTROL CLASSES**

Classes	Experimental test class (class A)					Control class (class B)				
	Number of students	Good rating	Average grade	Low prices	Assimilation, %	Number of students	Good rating	Average grade	Low prices	Effort, %
5	33	26	3	4	84	28	9	8	11	60,7
6	27	20	5	2	92,5	29	10	9	10	65,5
7	25	19	4	2	92,0	31	13	10	8	74,1
<b>Total:</b>	85	65	12	8	90,0	88	32	27	29	67,0

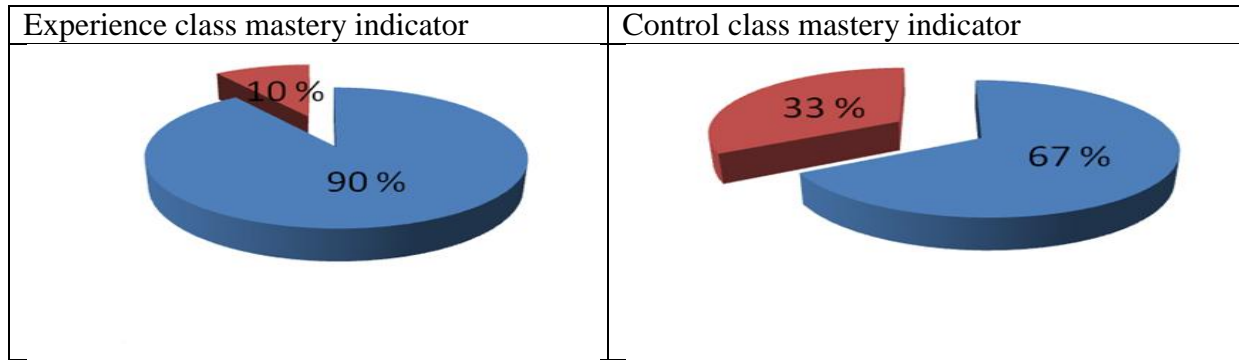

■ an indicator of what has been mastered in the experimental test class. ■ mastered in the control class.

■ an indicator of mastery in the experimental test class. ■ not mastered in the control class.

In the experimental test and control classes conducted at Termez Secondary School No. 13, the mastery rate was 64.2% in the control classes, while in the experimental test classes this figure was 89.4% (see Table 5).

**TABLE-5 TERMEZ CITY 13TH GRADE STUDENTS' ENGLISH LANGUAGE PROFICIENCY IN EXPERIMENTAL AND CONTROL CLASSES**

Classes	Experimental test class (class A)					Control class (class B)				
	Number of students	Good rating	Average grade	Low prices	Assimilation, %	Number of students	Good rating	Average grade	Low prices	Effort, %
5	33	26	4	3	90,9	35	10	11	14	60,0
6	32	22	8	2	93,7	32	7	14	11	65,6
7	30	23	4	3	90,0	31	8	13	10	67,7
<b>Total:</b>	95	69	16	8	89,4	98	25	38	35	64,2

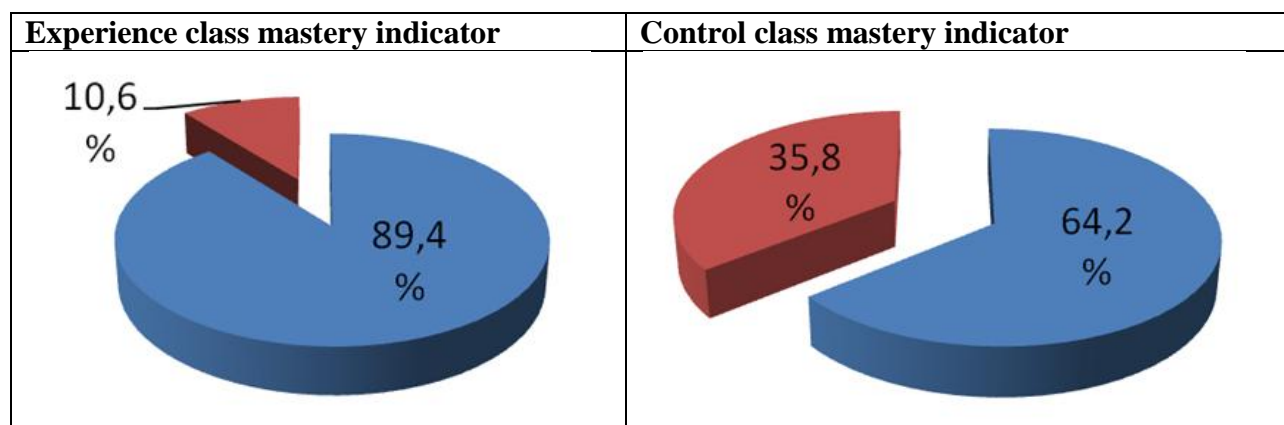

■ an indicator of mastery in the experimental test class. ■ mastered in the control class.

■ an indicator of those who have not mastered the experimental test class. ■ not mastered in the control class.

---

## CONCLUSION

The system of using intensive methods in teaching English in general secondary schools has been improved, the level of mastery in the experimental and control classes has been found to be high, and the number of low-grade students has significantly decreased.

## REFERENCES

1. Ter-Minasova S.G. Language and intercultural communication: Textbook. manual for students, graduate students and applicants for special. "Linguistics and Intercultural Communication". M., 2000.262 p.
2. Avliyakulova N.Kh. Zamonaviy ўqitish texnologolari. Ўқув лланма.-Т: 2001.-68b.
3. Nishonaliev U.N. Modular pedagogical technologies.-Professional education. M: 2002.-№ 14. -S. 10-12.
4. Pedagogical technology / Under the editorship of VS Kukushkin - "Pedagogical education" series - Rostov. Publishing Center. March, 2002.103 p.
5. Sh.Sh. Atakulova. Differences between British English and American English / "The role of youth in the development of science and education". November 23, 2018. Scientific-practical conference dedicated to the 75th anniversary of UzFAN. 1 part. Pages 187-188.
6. Irina Panferova. Modern methods of teaching English: similarities and differences / Scientific-methodical electronic journal. Tashkent. № 1 (5) / 2015. Page 100.
7. Farfiyeva, K. A. (2021). Theoretical Fundamentals Of Scientific And Innovative Thinking In Adolescents. *The American Journal of Social Science and Education Innovations*, 3(04), 431-437.
8. Ismatullayeva, N. R. The Concept of "Lacuna" in Translation Studies. *Asian Journal of Multidimensional Research (AJMR)*. ISSN, 2278-4853.





**ACADEMICIA**  
**An International**  
**Multidisciplinary**  
**Research Journal**  
 (Double Blind Refereed & Peer Reviewed Journal)



**DOI: 10.5958/2249-7137.2021.01285.4**

## ROLE OF SMALL SCALE INDUSTRIES IN ECONOMIC DEVELOPMENT

**Syed Waliullah Quadri\***

\*Department of Commerce Kakatiya University,  
INDIA

### ABSTRACT

*For any economy there are three sectors plays an important role.. After the independence agriculture sector, industrial sector and service sectors increased their performance and their contribution to the economy. After the independence government of India has taken the initiative of mixed economy. After the 1991 reforms made Indian manufacturing sector to take a major role in development. The globalisation and liberalisation which removed the import restrictions, brought in foreign competition led to privatisation of certain government owned public sector industries and liberalised foreign direct investment. The industrial sector is the one which is playing has taken a steady growth after the 1991 reforms, as Indian is a populated country more number of products and services are required. Industrial sector can provide products but somehow difficult to reach all the rural people due to lack of awareness , cost and distance from the towns. The growth of population has pressured the small sector to increase more and more contribution to economy. As they mainly depends on the products available in local market prepared by the small tiny farmers. These small scale industrial farmers can produce a large number of products to meets the needs of the both the customers as well as the companies. Companies also depends on the small scale industries for MRO (Maintenance, Repair and operating )goods, small products used in produce a big products. These small sectors also a plays an important role in employment generation and economic development. Therefore it became necessary to address the importance of the small scale industries. Present study will focuses the impact of small scale industries in economic development. It also studies the role of small scale industries in providing employment generation in Telangana. Data for this study would like to collect from the secondary data sources.*

**KEYWORDS:** *Gross Value Added, Women Enterprises, Entrepreneur Memorandum And Intellectual Property Rights.*

### INTRODUCTION:

Counties economic development government should actively promote, among the industrial sector small scale industries plays an important role. These small scale industries needs less investment but provide significant contribution to economy. Globalisation its impact is larger phenomenon but small scale industries is a local phenomenon but there is a relationship between these two. There two acts as the main drivers of the economic development of Indian economy. These small scale industries existed in India since ancient times in the form of silk and knowledge based products made by people for their self-sufficiency of rural people. The income which comes from the small scale industries can be distributed among all. For many families its is the only source of lively hood. These small industrial products are Eco friendly which produces less pollution and require locally available material.

### SMALL SCALE SECTOR:

Definition of small scale sector is different from one country to another country based on their economic development , policy formulation and administrative set up. But maximum all countries follow the same formula to define the small scale sector based on the capital investment volume of production and employment status. Government of India has taken more number of steps to define the small scale industries.

In India small scale industry is defined in terms of investment in plant and machinery (excluding the plant and machinery) and further classified into micro small and medium enterprises. Enterprises engaged in the manufacture or production of goods pertaining to any industry specified in the first schedule to the industries (Development and regulation) Act, 1951) or employing plant and machinery in the process of value addition to the final product having a distinct name or character or use.

The Manufacturing Enterprises are defined in terms of investment in Plant & Machinery. These are the industrial undertakings having fixed investment in plant and machinery, whether held on ownership basis or lease basis or hire purchase basis not exceeding Rs. 1 crore.

<b>MANUFACTURING SECTOR</b>	
Enterprises	Investment in plant & machinery
Micro Enterprises	Does not exceed twenty five lakh rupees
Small Enterprises	More than twenty five lakh rupees but does not exceed five crore rupees
Medium Enterprises	More than five crore rupees but does not exceed ten crore rupees
<b>SERVICE SECTOR</b>	
Enterprises	Investment in equipment's
Micro Enterprises	Does not exceed ten lakh rupees:
Small Enterprises	More than ten lakh rupees but does not exceed two crore rupees
Medium Enterprises	More than two crore rupees but does not exceed five core rupees

### REVIEW OF LITERATURE:

- Dividend policy is one of the most important financial policies,

- Anna Patil: Role Of Small Scale Industries In Economic Development: research concluded that small scale industrial sector is next to the agricultural sector in terms of employment generation.
- Dr. V.K. Gupta and Abhishek Chaturvedi : Role And Contribution Of Small Scale Industries In Economic Development In India. the present attempt to focus the present status of performance of MSMEs in India & future prospects. It is concluded that this sector contributes significantly to manufacturing output, employment, exports of the country. Research concluded that small scale sectors not only provide lower labour intensive production but also industrialisation of rural backwards.
- V.Mallika., Assistant Professor: The role of small scale industry in reduction of poverty in India: small scale industries are providing the employment opportunities , rise of industrial productivity , rise of exports and also rise of very impressive growth of GDP. The government that the state should provide the financial assistant to the small scale so that the contribution will increase.
- Shyambathi: India: the role of small-scale industries in an emerging economy: the study focuses Various factors affecting the growth and development of small-scale industries and the problem faced by this vital sector of Indian economy is examined. The contribution of small-scale industries in employment growth, production, export promotion and other economic indicators are discussed. Conclusions drawn from the analysis of the data suggest that the various policy initiatives taken by the Government of India since independence have helped this sector to grow considerably.

#### **OBJECTIVES OF THE STUDY:**

- To study the role of small scale industries in economic development of Indian economy
- To study the role of government in providing the assistance to growth of small scale industrial sector.
- To study the role of small scale industries in providing employment generation and women empowerment.

#### **RESEARCH METHODOLOGY:**

The data has been collected from secondary sources comprising of micro small and medium Enterprises annual reports, Ministry of Commerce and Government of India, ministry of micro small and medium from. Collected data scrutinised and classified in a systematic manner.

Assessment of MSME conducted mainly by two ways:

- By conducting of periodic All India Census of the Sector.
- By collecting the number of Entrepreneur Memorandum Part-II (EM-II) filled at DICs. (Replaced with Udyog Aadhaar online filing system since September, 2015).
- For the purpose of the present study data is collected from the report published in MSME report 2015. MSME presents its data every year based on the some base year. The data for the. The CSO published its sixth annual report in 2016.

### **MSME Establishments**

It is observed from the annual report the growth of the number of EMII fillings changed from 1.73 in 2007 to 4.25 in 2015. It means there is a steady growth in MSME sector. The growth rate is 17 percent from 11377. As per the Sixth Economic Census (2013), 58.5 million establishments were found to be in operation. 34.8 million establishments (59.48%) were found in rural areas and nearly 23.7 million establishments (40.52%) were found to be located in urban areas.

Livestock was the major economic activity (86.74%) of agricultural sector. Retail Trade (35.41%) followed by Manufacturing (22.77%) were the dominant ones within the non-agricultural sector. Among the States, maximum growth rate of establishments during 2005-2013 was observed in Manipur (121.07%) followed by Assam (107.99%) and Sikkim (100.07%)

### **MSME in Employment Generation:**

It is observed from sixth economic census that MSME sector alone generated 131.29 million persons in 58.5 million establishments. Out of the total 131.29 million persons, 67.89 million persons (51.71%) were employed in rural areas and 63.4 million persons (48.29%) in urban areas. While employment in Own Account Establishments was of the order of 58.15 million persons (44.29%), the employment in establishments with at least one hired worker was about 73.14 million persons (55.71%). Agricultural establishments provided employment to around 22.88 million persons (17.42%) and the non-agricultural establishments provided employment to around 108.41 million persons (82.58%). The growth rate of employment since 2005 was of the order of 38.13%.

### **Role of SSI industries in providing women empowerment:**

From the report it would be evident that establishments owned by women entrepreneurs 8.05 million (13.76%). These establishments provided employment to 13.45 million persons (10.24%), out of which 83.19% were without hired workers. About 88.8% of the workers were employed in the establishments hiring less than 10 workers. Total number of Self Help Groups (SHGs) were 0.19 million out of which all women Own Account Establishments were 89%. → Out of establishments under women entrepreneurs, about 34.3% belonged to agricultural activities, with livestock dominating therein having a share of 31.6%. Average employment per establishment for women owned establishments was found to be 1.67.

### **CONCLUSIONS:**

Micro, small and medium sector players are among the worst hit as banks continue to practice caution in lending to the industrial sector. Small scale industries are very important in providing employment generation, entrepreneur development, export generation, creation of livelihood and balanced regional development. The sector plays a role in achieving sustainable development goals of the nation. The industries also played a role in innovative technological development by providing engineered products. The sector some time faces problems like unwillingness of banks in providing financial assistance, lack of technology, market uncertainty and lack of planning. There needs to be regular dialogue between the stakeholders of the sector and government should provide the assistance to strengthen the sector. The government could consider dedicating

specialised financial schemes for addressing difficulties in assessing and providing credit for small enterprises, as also providing line of credit to firms which are under financial stress.

**REFERENCES:**

- Highlights of sixth economic report.
- Annual report 2016-17 government of India ministry of micro small and medium enterprises.
- Journal Article :Role of Small-Scale Industries in Economic Development: Irrigation Pumpsets Industry in Coimbatore.
- ShyamBhatiUniversity of Wollongong: India: the role of small-scale industries in an emerging economy.
- Anna Patil: Role Of Small Scale Industries In Economic Development
- Dr. V.K. Gupta: ROLE AND CONTRIBUTION OF SMALL SCALE INDUSTRIES IN ECONOMIC DEVELOPMENT IN India.
- Smrithichand: Small-Scale Industries in India: Definition, Characteristic and Objectives.
- Brief Note On Budget Estimate For 2016-17Of Msme Department Village & Small Enterprises
- Ministry of statistics and programme implementation government of India.
- Development Commissioner (Msme) Ministry Of Micro, Small & Medium Enterprises
- <https://www.hindustantimes.com/india/budget-brings-good-news-for-small-scale-entrepreneurs/story-yaQvUUaNcY0DLI3qf3QkFI.html>
- <https://www.thehindubusinessline.com/economy/budget/budget-has-addressed-msme-concerns/article6945631.ece>
- <https://msme.gov.in/sites/default/files/All%20India%20Report%20of%20Sixth%20Economic%20Census.pdf>

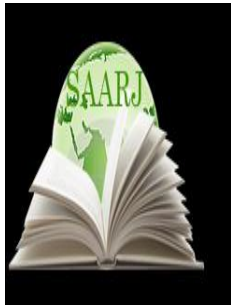

**ACADEMICIA**  
**An International**  
**Multidisciplinary**  
**Research Journal**  
 (Double Blind Refereed & Peer Reviewed Journal)



**DOI: 10.5958/2249-7137.2021.01267.2**

## STRUGGLE AGAINST ISLAM RELIGION IN THE 20–40-s OF THE XX CENTURY AND ITS MAIN TRENDS

**Shavkatjon Tulanboev\***

\*Teacher,  
 Namangan State University,  
 UZBEKISTAN

### ABSTRACT

*In the article the ideological struggle of the Soviet government against the Islam religion in the first half of the XX century, persecution of religious people, finishing “vaqf” properties and the situations in Fergana valley are described. Also, negative consequences of the religious politics of the Soviet government in Uzbekistan is criticized in the article.*

**KEYWORDS:** *Soviet State, New Economical Policy, Islam Religion, “Vaqf”, Madrasahs, Temple, Mosque, Mutavalli (A Staff In Mosque), Bolsheviks, Ideology, Policy, Religious Organizations, Courts Of Sharia, Old-Styled Schools, Jadids.*

### INTRODUCTION

The struggle of the Soviet state against Islam rose to its new stage in the 20 years of the XX century. This can be explained by the violation of Muslim temples, which was considered a new wave of religious policy carried out at that time, the construction of pigeons and mineral fertilizers in their place, the persecution of the cultists.

In order to deprive the religious institutions of material resources, Soviet power issued a decree “on the abolition of foundations” with the order of December 14, 1918 № 6486 [1: B.287]. According to him, in Turkistan, in the Fergana Valley, the use of the properties of the foundation, which was formerly a material base of education and culture and was managed by trustees (from 1918 to 1920 years, foundations were included in the budget of state and local organizations and madrasahs, garages were closed, Sharia courts were liquidated), the policy of confiscation of them. At that time, the foundation lived in land properties, the material conditions of thousands of peasants who were engaged in the farm deteriorated, a large part of the land lost its fertility, became abandoned, neglected places. Returning the peasants to their land, paying

attention to the economic crisis in the country, the Soviet government left the issue of the complete liquidation of the foundations later.

Due to the trustees management of the property of the foundations in Madrasah and mosques, the rulers of religious institutions, whose activities were in existence, received a wide outbreak in the hands of individuals subordinate to the Bolshevik order. For example, the former Soviet of Margilan deputies accused the Imam of the Yorota mosque and the White Madrasah of appropriating the income of the foundation in his personal favor, and on July 19, 1919 he was dismissed.

At the meeting of the Namangan city Executive committee, which was on August 27, 1918, the Ayritom mosque trustee Ismoilkho'ja Eshon was dismissed for giving false information about his "crimes", that is, the income and expenses that came to the mosque. In the same year, Kholkhoja Eshon madrasa trustee Mulla Abdukahhor, Abduvahobboy madrasa trustee Mulla Ashur Rahimov (Andijan), Imam of Sabirkhoja mosque in Shakhrikhan Mulla Sadullakhoji were also taken from the case on charges of looting the foundations.

According to the sources of the archive, the madrasah, located in the Fergana region in 1918-1921 years, a large part of the mosques were destroyed and they were separated from their sources of income.

On November 17, 1920, following the Charter of the Turkestan ASSR NCC and the "Russian Federation on land use in the Republic of Turkistan", the foundation began to transfer lands to the state and completely abolished [2: B.35]. In the law, the foundations belonging to the mosques were not temporarily touched.

At the beginning of 1921, the Religious Department of the Cabinet of Ministers of the Republic of Uzbekistan became interested in the construction of mosques and madrasahs and began to lead them to their maintenance and repair. The offices of this department in major cities such as Tashkent, Fergana, Andijan, Margilan, Namangan, Kokand, Khujand, Osh, Samarkand were operating and holding its influence in the rural areas. That is, the activities of the mosques in the villages were focused on issues such as fasting and the spending of charity and fitr charity from the population of Kurban Eid days, the arrival of saints on the pilgrimage to Khaj [3: B. 43].

In 1922-1924, the opening of some way to religion and the activities of religious institutions was associated with the activities of Soviet power in the period of a new economic policy (NEP). Factors such as the complete destruction of the farm due to ruthless military clashes, the terrible famine, the process of resistance to Bolshevik procedures, had forced the authorities to work in a compromise way in the management.

The decision of Turkestan ASSR MIK on the right of substitute-tooth controlled by the educational department of the foundation offices and the activities of the religious department of the Cabinet of Sharia further aggravated the situation of religious institutions. The old method was reformed by the Educational Department of schools and orphanages.

All regional activists took part in the meeting of the Fergana district executive authority held on 4 December 1928, in which mainly the religious issue was discussed. At the meeting, issues such as the complete liquidation of the properties of the foundation, the Prevention of the activities of old-style schools, the immediate transfer of the buildings of the pulled religious institution to the state, and the formation of a special commission, their functions were determined. The

transparent aggression of Soviet power in 1928 against the activities of religious institutions and organizations caused not only spiritual and religious, but also members of society as a whole.

The head of the Soviet state after I. Stalin stated in his speech on 3 March 1928 year that “the fight against the ears, the decisive struggle against religion”, religion and the pious became victims of a brutal repression. The adoption of the above-mentioned decisions also put an end to the activities of the religious department of the Cabinet of Sharia. To this extent, the aggravation of the policy of secularism of Soviet power led to the fact that, even in accordance with Article 158 of the criminal code of the USSR of Uzbekistan, criminal liability was established in relation to persons who tried to establish religious organizations and open old-fashioned schools. The above decisions of Soviet power in relation to religion and religion began to show the practical foundations of its rapid integration in Uzbekistan. The income of foundations, the material basis of religious institutions and organizations, was confiscated, 90 percent of the income from the property of the former foundation was transferred to the construction of Soviet-type schools, 10 percent to the account of the people's educational commissariat [4: B. 225].

In the history of Soviet society in the late 20s-early 30s of the XX century, religious institutions and organizations, as well as religious leaders, attitude towards the pious were extremely reactive, mercilessly characterized by a large scale decline of the atheist movement. The ideas of the all union of godless gods, carrying out its propaganda and propaganda work, trying to prove the “falsity” and “groundlessness” of holy places in the villages between the working and peasant masses, condemning the pious as supporters of the bourgeoisie and the petty bourgeoisie, accusing them of hostility to socialism, visiting the tombs of the holy saints, widely propagating the harmfulness of religious.

In 1938-1939 in Andijan city there were 71 mosques, 1 Russian church, 3 Jewish synagogues, which prevented the performance of religious ceremonies in various ways. In order to preserve its religious values and Islamic institutions, the work of raising funds through the hashar of the population is also understood as the propagation of scribes by government agencies. And this was one of the excuses in the queue, which was conceived to persecute the pious.

In the Fergana region of the Republic, literature and manuals containing 79 166 sums of the fight against religion were purchased in 1940 for the wide propaganda of anti-religious propaganda. In 1940, on the territory of the only Fergana region, the number of “wrestling godless” yachts reached 2 243 units, and the number of members was 45 824 people. There were also 272 agitators in the country, 210 lecturers in the cities and villages, who carried out anti-religion propaganda [5:p. 225].

At the meeting of the party of Fergana region, which was held in September 1940, it was noted that the chairmen of the Council of Soviets of all cities and villages will be given strict control over religious institutions in their territories, re-registration, demolition of unsuitable mosque buildings and the use of construction materials derived from them for other purposes to

In the 20-40 - ies of the XX century, the drastic changes aimed at finding a mini-decision on administrative-command in the sphere of socio-economic and cultural policy of Soviet power dealt a huge blow to religious scholars, as did all strata in society. The transparent aggression against the people of religion and the people of religion has long had a negative impact on them, which they cannot cope with.



In 1940, more than 3 000 printers were registered in Fergana, one of the largest regions of the Republic. Most of them were mosque imams, neighborhood mullah, qori and Otinbibis, who were secretly or openly operating in cities such as Kokand, Andijan, Margilan, Namangan, Chust, Asaka, Kuva, and some were forced to engage in farming or crafting because of the tax burden, while some were forced to give up their religious duties. In 1939, 316 scholars in Fergana region were taxed 621511 soums, in 1940 367 of the scholars were taxed and 798754 soums were imposed upon them [6: p. 162].

Another of the factors that contributed to the repression of Muslim scholars was also due to personal hostility of the heads of government by members of the Soviet local government in the localities. There have also been cases of retaliation from such scholars when the time comes of mutineer leaders who have criticized some religious scholars for their lack of justice in power, bribery, moral corruption, hypocrisy. Religious scholars have been accused of giving young people a religious education and starting them wrongly, as if they are being distracted. “Meliboy khalfa, who lives in the village of Big-yaydak in the Naryn District of Fergana province, at the same time, without working anywhere, is seducing young people with religious propaganda, taking money from some as a talisman. It also organized religious conversations, gathering people of many different ages at home. In the village under its influence, fasting people have increased”, many can meet the charges.

Well, thanks to the inhuman, violent policy of Soviet power on religious scholars, scribes perfectly aware of Islamic knowledge and spirituality in the Republic were completely lost, instead of them blind performers, persons who were superficially aware of religious knowledge, took the leadership of religious institutions. Such people performed their duties and were the executors of the orders issued from above. Religious scholars have been trampled on by spiritual values in the process of repression. Religious and secular sciences preserved by the scribes, as well as rare manuscripts reporting from the past of our country were confiscated or lost.

The collapse of the independence movement, the mass penetration of the entire layer of the peoples of Turkestan into the path of this struggle forced the Soviet authorities to conduct a cautious policy. Turkestan ASSR MIK with the aim of shifting foundations to madrasahs and mosques and entering into the trust of local residents with the purpose of repairing religious institutions, stabilizing life in the country in favor of the Bolsheviks. Turkistan ASSR MIK on June 20, 1922 year 75-digit, on October 23, 1923 year 164-digit. Although the soviet governorship returned the foundations to religious institutions and organizations, their activities were controlled by the state legislature [7: p. 227].

The above decisions of the Soviet authorities in relation to religious institutions will soon be the conduct of a national-territorial boundary in Turkistan. also, with the solution of domestic political and economic problems, he again returned to the path of his policy, which consisted of ingenuity in relation to religious organizations. The activities of Muslim institutions in the Fergana region were completely reflected on the basis of the decisions of the measures to end. The religious policy of the Soviet government of Uzbekistan conducted in the USSR, like other spheres, was based on the requirements of communist ideology, and consisted in the restriction and prohibition of religious belief, one of the centuries-long values of the people. During this period, not only the religion of Islam, but also the struggle against other religions was escalated, which, due to the political situation in the country, sometimes pave the way to a certain degree of freedom of religion, in some periods it was completely subjected to oppression and prohibitions.

Nevertheless, it was not possible to completely abolish religion from the people's hearts, life and household life, which were loyal to their values. Religion, as in all times, remained an important part of the spiritual life of the people.

#### REFERENCES:

1. Махмудов Э. Туркистон АССРда Совет ҳукуматининг вақф мулкларига муносабати (Фарғона вилояти мисолида) / Фарғона водийси янги тадқиқотларда. II Республика илмий анжумани материаллари. – Фарғона, 2012. – Б. 287.
2. Мустафаева Н. Ўзбекистонда совет ҳукуматининг диний сиёсати // Ўзбекистон тарихи. – 2005. – №2. – Б. 35.
3. Мустафаева Н. Ўзбекистонда совет ҳукуматининг диний сиёсати // Ўзбекистон тарихи. – 2005. – №2. – Б. 43.
4. Салмонов А., Ғаниев А. Совет ҳокимиятининг Фарғона водийсида вақфлар ва диний уламоларга муносабати / Фарғона водийси тарихи муаммолари. Республика илмий анжумани материаллари. – Наманган, 2012. – Б. 225.
5. Салмонов А., Ғаниев А. Совет ҳокимиятининг Фарғона водийсида вақфлар ва диний уламоларга муносабати / Фарғона водийси тарихи муаммолари. Республика илмий анжумани материаллари. – Наманган, 2012. – Б. 225.
6. Юсупов Р. М. Ўзбекистонда XX асрнинг 40–80 йилларида мусулмон диний ташкилотлари ва уламолар фаолияти. – Тошкент, 2008. – Б. 162.
7. Салмонов А., Ғаниев А. Совет ҳокимиятининг Фарғона водийсида вақфлар ва диний уламоларга муносабати / Фарғона водийси тарихи муаммолари. Республика илмий анжумани материаллари. – Наманган, 2012. – Б. 227.

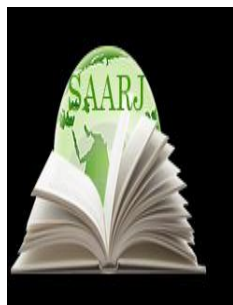

**ACADEMICIA**  
**An International**  
**Multidisciplinary**  
**Research Journal**  
 (Double Blind Refereed & Peer Reviewed Journal)

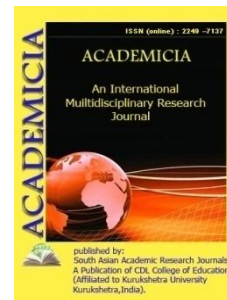

**DOI: 10.5958/2249-7137.2021.01268.4**

## AESTHETIC FUNCTIONS OF FLAME POETIC IMAGE IN UZBEK FOLK SONGS

**Karimova Feruza Muminovna\***

\*Base Doctorate,  
 Bukhara State University,  
 UZBEKISTAN

### ABSTRACT

*In this article, scientific theoretical analysis of the aesthetic essence and analogues of the rudiments associated with confidence in the cult of fire in the composition of the rituals of the world peoples, including the epic, lyrical, paremic genres of Uzbek folk folklore. Looking at the fire, Namrud saw Abraham sitting there with a stick.[4] confidence in the people of Uzbekistan in the cult of fire ,the above-mentioned examples of the processes of treatment with fire were the religious basis.*

**KEYWORDS:** *World Folklore, Religious Mythological Views, Historical Roots, Flame Sponsor, Avesto, Khorezm Traditions, Zardusht Religion, Narshakhy, Muqanna, Ethnography, Yasin, Koran Karim, Ash, Furnace, Smoke, Burning, Ibrahim, Fire Tree, Nemrud, S.Sh.Chagdurov, Ritual, Fertility Cult, Mistress Of Fire, Ethnography, Relic, Attack Movement, Portable Meaning, Material Scientist, Hair Embodiment, Immersion, Holistic System, Tashbeh, Views, Calendar, Seasonal Ritual, Animistic Imagination-Concept, Folk Poetry.*

### INTRODUCTION

"The struggle for national spiritual identity, mastering the cultural heritage is a gross social movement" [1] and plays an important role in the spiritual perspective of our people. After all, various traditions and rituals, the image of fire, which is reflected in folk works, and its analogs symbolic-alligatorial interpretation in terms of mythology, which forms the ancient layer of people's artistic thinking, plays an important role in the study of archaic texts on the symbolic-ritual essence, collecting and researching them is an important issue facing folklore studies.

The religious and mythological views of the Uzbek people on the fire cult, the fire cult are reflected in the composition of wedding, mourning, treatment ceremonies, folk performances, folk poetics. In the surah of the Koran Karim "Yasin" it is said about Allah: "he is the one who

made for you fire from a green tree.”[2] plowing the fire, worshipping it-the zardusht religion, is also very developed in the life of the ancient Turkic peoples. For example, according to Narshahi, Muqanna throws herself into a heated oven for three days, going up to heaven, bringing Angels of fire and trying to defeat her enemies.[3]

Namrud was sure that Abraham alaihissalom was burning ash in the fire. Riding on the animal, the fire passed by. Collected firewood to activate Abraham my carpet was burning. Looking at the fire, Namrud saw Abraham sitting there with a stick.[4] confidence in the people of Uzbekistan in the cult of fire ,the above-mentioned examples of the processes of treatment with fire were the religious basis. Folklore scientist A.Musakulov said that in the science of ethnography the spirit of being the owner of an oven is imagined to be female sex, the cult of fire is associated with cult of trees, and most importantly with the cult of fertility[5] according to the interpretation of S. Chagdurov, the cult of the letter-fire and the suffix of the letter-fire and the.[6]

In Khorezm, the fire burned in the oven itself cannot be extinguished until it is extinguished. In particular, it was considered indecent to extinguish the fire by pouring water into the oven. According to this act, “pour water into your furnace”, there is a matal, on the basis of which the family of the furnace in which water is poured, will die. In turn, this expression is also used as a crow. Here, the cult of fire is combined with the cult of generations. In many peoples there is a view that the family hearth is a mask of the spirit of ancestors.[7]

In Uzbek folk songs it is observed that fire and its attributes such as wood, comb, smoke, furnace, candle, lamp, poetic images such as burning burns are interpreted in specific artistic and aesthetic tasks. First of all, we must say that in Uzbek folk songs the image of fire can come both in its own meaning and in its portable meaning:

Damla palovni dam yesin,  
Tortgil olovni dam yesin,  
Bepul odamlar g'am yesin,  
Tekin desa –shalg'am yesin.

Or:

Chimmati yo'q chiroylik,  
Yur, klubga boraylik.  
Paranjilarni yig'ib,  
Olovda kuydiraylik.

In these songs, the meaning of fire is used in its own meaning. If the first song describes the action of lowering the flame under it, pulling it, before the rest of the pilaf, the second song refers to the fact that the historical event that took place in March 1927 in Uzbekistan burned women's offensive movements, that is, in the fire they collected their claws. In many songs, the interpretation of the flame in a portable sense is overlooked.

For example:

Anor uchu ichim to'lib,

Olov yonar,yor-yor.

Do'stim, senga aytar bo'lsam,

Mehrim qonar,yor-yor.

The concept of “burning fire inside” of a person expresses a portable meaning. This means that a person with this suffers deeply in the soul, suffers from the inside, suffers. In folk songs, the question of fire is also given by the words “grass”, ”fire”, which are its synonyms:

Ochildik hur zamonda,

Ko'ngillarga o't qo'ydik.

Boshdagi paranjini,

Olib o'tlarga yoqdik.

In these Egyptians, the herbivore suddenly guides in two different meanings – both its own and portable. The concept of ”burning fire in a dream” in a portable sense means that the soul is full of dreams and uplifting sensations.

Ro'molimni teng bo'laman,

Ammamga kelin bo'laman.

Ammam kelin qilmasa,

Otashga tushib ketaman.[8]

In this song, in place of the word fire, the suffix “fire”, which is its synonym, is used. The symbol of fire (fire, fire) in a portable sense expresses spiritual suffering, inner suffering and suffering.

Uchakka chiquvdim soz sasi keldi,

Soz bilan jaranglab yor sasi keldi.

Iloj bo'lsa borar edim yoniga,

O'zi kelmay o'tlar soldi jonimga.[9]

In this song, it is not difficult to understand that the grass that was killed by beloved is called “fire of love”. After all, the “fire of love” in folk songs is one of the traditional logos that most often come across.

Yordan kelmadi darak,  
Ishq o'tiga solgan falak  
O'ttizida yor tutib,

Yorga to'ymagan yurak[10]

Or:

Yoningdan ketolmayman,  
Ishq o'tini solgandek.  
Xayolim ketar har yon ,  
Tariqlar sochilgandek [11]

In both of the songs presented, beloved embodies the motivation of negation, from the passionate love grass. They come to parting because of love, heartache for not seeing beloved, longing for his mistress's path, dreams of him saying oh-u screams of disheveled lover are being interpreted. In a word, if a burn in a natural flame brings physical pain and suffering to a person, then the fire of love causes a person to suffer from it, which is also painful. He suffers not due to the body, but the spirit, love and even discredit man it's not for nothing that he makes him mad, mad. This is evidenced by the image of Majnun in our national literature.

Yuragimni kuydirdi,  
Ishq o'tida o'ldirdi,  
Yorim juda nozikdir,  
Meni jondan to'ydirdi.[12]

In the song presented, love is interpreted as a heart-burning, soul-nourishing and lethal powerful force. So it's not that there is no mystical content on the basis of this song. In the song presented, love is interpreted as a heart-burning, soul-nourishing and lethal powerful force. So it's not that there is no mystical content on the basis of this song. So, in mysticism, love is interpreted as a means of reaching God. The spirit of the one who achieves it leaves the material world, the second one goes to the other-to the divine world, and man achieves true love, the love of Allah. In it, love performed the role of the instrument .

Etiging o'kchasi o'n ikki parda,  
Men qaydan duch bo'ldim oshiqlik darda.  
Ikkimiz ham ishq o'tida yonamiz,  
Bermasmikan shu bolaga onamiz.[13]

In folk songs, sometimes the love, sometimes the lover's love, sometimes the lover's love is reflected in the riddle. In particular, in the above quartet, it is stated that the girl, who is in love with the lover, is striving for her boyfriend, dreams in this way. Often parents forcibly transfer their daughter. They do not allow her to be loved and married. As a result, the family foundation, built without love, in most cases quickly cracked. The couple can quickly break up, causing misunderstanding, disinterestedness to each other, warmth in the middle, lack of love awakening. In this song, created on the basis of this life-long truth, it is said that the girl is experiencing the pain of love. He very much wants his parents, especially Hamish, to understand himself, to feel his soul and to marry his beloved, his mother, who has become close to him.

Sen tirik dersan meni,  
Xuddi tirik o'lgandirman .  
Tirik ayrilgan yorimning  
O'tida kuygandirman.[14]

It is a bad situation for people who love each other, who are fond of something, to divorce from each other alive because of life reasons, to face parting and separation. In the song above there is a hint of exactly the same life reality.

Sochini yuvganlar orqaga tashlar,  
 Oshig'in ko'rganlar kunda bir yashar ,  
 Orada dushmanlar o'tday tutashar,  
 Dushmanni kuydirib kunda kel,yorim.[15]

The symbol of the hair in poetry usually refers to the symbol of the mystery of God. The concept of "washing hair" in the song is always a sign of the fact that lovers have their own secret. Because, to wash the hair, it is spread out. So the state of hair washing in the song is equal to the state of spreading the glaze. If the enemy finds out the secret of the lovers, then, of course, he will try to put a between them. Therefore, the secret will belong only to two people (lover). And the third (enemy) is over.

The verse in the song "Come on the day of burning the enemy, beloved" recalls our habit of going to slavery (making a game of slavery), which was passed before the wedding in connection with our past household life. The essence of this custom is reflected in the great epic of the Uzbek people - "Alpomish" poem: "since the Uzbeks have their own picture, they have expressed their own destiny.

It turns out that the groom on the day of the wedding goes. If I do not marry on the day of shul that I have not given the goods, it turns out that the man who is ashamed will remain dry from the wife, as long as his daughter will be sick. Their rust – picture is so that the symbol of immersion in folk songs much. Through it, the sadness of the soul is expressed:

Yurakka cho'g' –olov tashladingiz ,  
 Cho'g' olov-itdan olov, alla.  
 Tutunlari yo'qdir ,uxla.  
 Yuraklar sadporadir ,alla,  
 Butun joyi yo'qdir uning alla[16]

Drowning in the heart-fire is a mental pain that awakens in the heart due to the occurrence of death, separation. Death puts the entered apartment in agony, as it burns the place where it fell. In the song it is emphasized in its own way that the drowning fire that fell on the heart is a dog fire, that is, the fire of death. It is noteworthy that the combination of "dog Fire" has preserved in itself an ancient concept, which consists in the view that the dog is an intermediary of death, as it is highly stressed. The image of the choir is also in its meaning in folk songs, that is, in the meaning of the piece from the fire. For example:

Olaqarg'a o'g'zing to'q ,  
 O'choq to'la pista cho'g'.  
 Kelayotgan kelinchak,  
 Yoring bormi, yoring yo'q?[17]

Firewood is also one of the analogues of fire. Often it is regarded as one of the sources of the flame.

Qoshing qora to'tiday,  
 Saksovulning o'tiday.  
 Ikkalamiz o'ynaylik,  
 Dalada o'sgan qo'ziday.[18]

The Saksovul fire is kept long, and the heat is slightly higher. This very real character, characteristic of him, was the basis for comparing him in folk songs to the degree of the power of love grass.

O'tin yorib o'tirsam,  
 Sarjin boshimga tushdi.  
 Mozorboshidan o'tsam,  
 Dadam yodimga tushdi.

In Real reality it is known that chopping wood is not a light work. Because, when burning wood, it can fly and injure the head. Therefore, special care is required in chopping wood. In this song, the fact that (in the day) falls on the head and damages the head has a symbolic essence. Through this, the idea of the fact that the father dies in the family, and the duties assigned to him by him fall on the head of the eldest son is expressed artistically.

Well, in folk songs there are a lot of such images as fire, grass-related Ash, Ash, wood, three. Through them, mainly, love has four, punishment is expressed artistically.

In place of the conclusion, it should be said that in folk poetry it is possible to observe that the creation of an artistic image from the fire has become a tradition. In poetry, fire is used in many figurative meanings. The symbol of fire is associated not only with the family household, but also with the folklore of calendar or seasonal ceremonies. Trust in the cult of fire has been spread among our people for some time in the form of a wide and certain holistic system. Folk songs are distinguished by their beautiful form and content, beautiful and content, richness and high artistry of beautiful, resonant and impressiveness. In songs, people's life is manifested in all its facets, people's mood is manifested in all its manifestations. Despite the fact that folk thinking, worldview, customs in songs were formed even in the most ancient times, the belief views that have been preserved so far are often manifested through symbolic images. In particular, one of such symbolic images is associated with the e'tigodic concepts of the cult of fire.

#### REFERENCES:

1. O'zbekiston Respublikasi Prezidentining "O'zbekiston Respublikasini yanada rivojlantirish bo'yicha harakatlar strategiyasi to'g'risida"gi Farmoni. "Xalq so'zi" gazetasi –Toshkent., 2017-yil, 8-fevral, 28-son (67 22)
2. Quroni Karim O'zbekcha izohli tarjima va izohlar muallifi Alouddin Mansur.Toshkent "Sharq"1992-yil,bet:311
3. "Saodat"jurnali,1992-yil 9-son. B.145.
4. Payg'ambarlar tarixi Toshkent "Sharq", 2020-yil, B.140.
5. Musaqulov A. "O'zbek xalq lirikasi",Toshkent., "Fan", 2010-yil, B.202.



6. Чагдуров С Ш “ Происхождения Гэсэрады “ Новосибирск ,1980, стр.162.
7. Snesev G.P Xorazmliklarning musulmonlikdan avvalgi marosimlari va urf-odatlari”, Urganch -2018-y, B.187.
8. Oq olma ,qizil olma 114-bet.
9. Oq olma,qizil olma 126-bet.
10. Oq olma,qizil olma 12-bet.
11. Oq olma,qizil olma 29-bet.
12. Oq olma,qizil olma 29-bet.
13. Oq olma qizil olma 120-bet.
14. Oq olma,qizil olma 33-bet.
15. Oq olma,qizil olma 33-bet.
16. Bo’zlardan uchgan g’azal –ay, 90-bet.
17. Keliyoy qo’shiqlari 83-bet .
18. Oq olma,qizil olma 80-bet.
19. Shodmonovich, Jahongir Hayitov. "LOCAL PRESS INFORMATION ABOUT THE DISPOSAL OF A NEW AMERICAN COTTON VARIETY IN BUKHARA (BY THE MATERIALS OF THE NEWSPAPERS “BUKHORO AHBORI” AND “OZOD BUKHORO”)." *Scientific reports of Bukhara State University* 4.1 (2020): 291-295.
20. Shodmonovich, Khaitov Jakhongir. "History Of The Spread Of New Varieties Of Fodder Crops In Turkestan In The First Quarter Of The XX Century." *International Journal of Progressive Sciences and Technologies* 24.2: 18-21.
21. Hayitov, Jakhongir Shodmonovich. "SPREAD OF NEW TYPES OF CORPS IN TURKISTAN CONTINENT AT THE END OF THE 19th-AT THE BEGINNING OF THE 20th CENTURIE." *European Science Review* 1.11-12 (2018): 24-26.
22. Хайитов, Жахонгир Шадмонович. "ИСТОРИЯ О РАСПРОСТРОЕНИИ ДЕКОРАТИВНЫХ ДЕРЕВЬЕВ В ТУРКЕСТАНСКОМ КРАЕ (В КОНЦЕ XIX-В НАЧАЛЕ XX В.)." *Россия-Узбекистан. Международные образовательные и социально-культурные технологии: векторы развития.* 2019.
23. HAYITOV, J. "History of dissemination of the ornamental trees’ new types in Turkestan (the end of XIXth-beginning of XXth centuries)." *Scientific journal of the Fergana State University* 1.6 (2019): 61-63.
24. Khayitov S. A., Teshayev A. T. THE PROCESS OF UNINON OF GERMANY: ACTIVITY OF HELMUT KHOL //Scientific reports of Bukhara State University. – 2020. – Т. 4. – №. 2. – С. 271-275.
25. Khayitov S. A. UZBEKS IN RUSSIAN FEDERATION: HISTORICAL ANALYSIS (1991-2015) //Scientific reports of Bukhara State University. – 2020. – Т. 3. – №. 2. – С. 204-207.

- 26.** Хайтов Ш. А., Юлдашев А. Б. Переселенческая политика советского правительства и история переселения узбеков в Таджикистан //Гуманитарно-педагогические исследования. – 2019. – Т. 3. – №. 2.
- 27.** Хайтов Ш. А. Историческая судьба туркестанских военнопленных второй мировой войны //Метаморфозы истории. – 2015. – №. 6.
- 28.** Хайтов Ш. А. Общественные организации Узбекистана в развитии международных связей страны (70-80-е гг.) : дис. – Академия наук респ. Узбекистан. Ин-т истории, 1991.
- 29.** Хайтов Ш. А., Норов Ш. С. Исторический процесс разработки и принятие законов, на основании региональных сущностей о молодежи Узбекистана в период 2016-2020гг //CENTRAL ASIAN JOURNAL OF SOCIAL SCIENCES AND HISTORY. – 2021. – Т. 2. – №. 2. – С. 81-88.

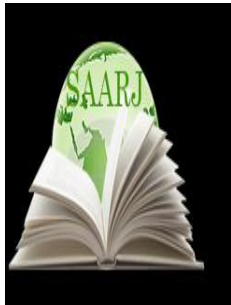

**ACADEMICIA**  
**An International  
 Multidisciplinary  
 Research Journal**  
 (Double Blind Refereed & Peer Reviewed Journal)



**DOI: 10.5958/2249-7137.2021.01269.6**

## WORD EARTH TUSHUNCHASI CONCEPT AND ITS ESSENCE

**Oripov Khasan Abdivakhovich\***

\*Doctoral student,  
 Samarkand State University,  
 UZBEKISTAN

### ABSTRACT

*This article analyzes the philosophical, social, legal aspects of the concept of Word land, its role in society, human development, development, freedom of speech. The concept of freedom is considered a philosophical concept, widely used in such areas of Social Humanitarian knowledge as ethics, aesthetics, jurisprudence, political science, and its lexical meaning is that a person acts on his own will. In particular, he wrote that we can learn the truth only by comparing all the existing points of view, and there is not enough wise people in the world to determine the truth for everyone in one person. Word freedom is its natural and inseparable right, which is inherent in the inner world of man, forms the basis of all spiritual life and does not allow any aggression and interference of man without his own consent.*

**KEYWORDS:** *Word, Freedom, Word Land, Society, Man, Law, Citizen, Democracy.*

### INTRODUCTION

The word land has so far been practically expressed from the early stages of development of society. First of all, in order to fully understand the concept of the word freedom, it will be necessary to touch on the concepts of words and freedom. In the Explanatory Dictionary of the Uzbek language, the word is interpreted as such a unit (in the language, as a means of expression in speech), consisting of sounds or sounds, a unit of speech that expresses a certain meaning, a section of speech, or a kind, style of meaning. Hence the word is considered to be a means of expression not only a meaningful unit of speech, but also in language and speech. According to A.A.Popov, "word freedom is a unique way of existence of a person and any social subject, connected with his ability to choose a decision himself and act according to his own goals. Freedom is the fundamental, in general, and in particular, the social basis of a person, because it reflects such an attitude of the subject towards his actions, and in this it is the reason that determines them, and therefore they cannot be directly related to conditions, natural, social,

persons communicative, individual-internal or individual - general factors. Word freedom seems to be a way out of a given circle and a creative impetus to something new, but it will not be complete if it does not realize itself externally in the sphere of publicity.[1]

The concept of freedom is considered a philosophical concept, widely used in such areas of Social Humanitarian knowledge as ethics, aesthetics, jurisprudence, political science, and its lexical meaning is that a person acts on his own will. By connecting freedom with different spheres of society, concrete concepts are formed. For example, conscience freedom, will freedom, thought freedom, word freedom, press freedom etc. Freedom is the desire of man, the duty of which is important to society, to insist that other people can do it, to demand. Freedom is the protection of a person from political, spiritual tension, violence. [2] it can be understood from this that the concept of the word freedom is closely related to the two elements described above, and it is purposeful to think of the freedom of speech as part of freedom.

### **LITERATURE AND METHODS**

Consider the philosophical, social, legal aspects of freedom of speech. The word freedom is considered a philosophical category and means "the right to understand", or the ability of a subject to go beyond the limits of emotional knowledge, to discover the surrounding world for himself, and to assimilate his reflected image to the extent necessary for practical appropriation and change in accordance with the needs and interests of people.

From a social point of view, the word freedom "the right of man to communicate with society" is an opportunity for the subject to become an asset to the Real world, including to another person, as part of this world, entering into contact with him.

Legally, however, it is a natural, legally recognized and normalized opportunity for everyone to independently choose the type and measure of speech behavior-to express ideas, thoughts and beliefs (written or oral, in whole or in part, in any question and in any other subject, unless of course this threatens the values protected by law). [3]

Word freedom has not been before, it is inappropriate to think that this concept came into being later. If there were no ideas, ideas and views, society would never have developed. A wide road to freedom of speech can be opened or its limitations began from ancient times. For example, the speeches of the speakers at the public meetings in ancient Greece, Rome, explained their personal recommendations on how to solve the issues that were being discussed, and the people of the camp believed that they were right. The activities of the people's tribunes in Rome can be evidence of our opinion. Also the word earth can begin its history with Socrates's self-defense speech from 399 BC or with the Magna card (the great harp of liberties) from 1215-th year. Or we can refer to the developed Muslim culture of pluralism and tolerance of the VIII-IX centuries. But an attempt to interpret ancient cultures from the point of view of the current concept of human rights would not have been successful. The principle of the word freedom is more suitable in modern historical circumstances, after church reform and religious and political debates accompanying it.

The word freedom is a person who conducts research in the field, according to scientists believe that it began in Europe in the middle ages of BC. But if we take a broader approach to this issue, we can see that it is recorded in the works of eastern scribes and statesman figures or in various historical sources. In particular, in the book Avesto, which is considered the main source of the

religion of Zarathustra, it is noted that faith is based on three pillars. Of these, the first is the purity of thoughts. Based on this base, it can be expressed in any way and method, if the idea is correct. [4] Also in the era of Amir Timur, great attention was paid to the issue of Word land and played an extremely important role in decision-making. Sahibkiran A. Temur wrote: "my experience is past, although how the completion of the work is hidden behind the thing of fate, it is necessary to know the thoughts of the wise and kind people, wishing a council event.... I did everything on board. Every time the councilors gathered and the Assembly was hungry, I would ask them for an opinion by opening the words of good and bad, profit and loss, whether to do things in front of us or not".[5] It should be noted that at that time the word was freedom, which means that each council member had to express his or her opinion freely based on how he or she understood the issues being discussed.

The first truly influential work on the word freedom was the work of John Milton "Areopagitika", written in 1644 year. Areopagitics were created in response to British Parliament's attempts to ban publications that were deemed unacceptable for various reasons. Milton cites a number of arguments to support freedom of speech. In particular, he wrote that we can learn the truth only by comparing all the existing points of view, and there is not enough wise people in the world to determine the truth for everyone in one person. Different opinions are the decisive factor of the development of consciousness in accordance with the search for truth - its main purpose. Therefore, Milton writes that "a person who destroys a good book kills the mind himself" [6]. This argument plays an instrumental role in the freedom of speech in our constant truths conditions. The essence of freedom of speech is the right of a person to express thoughts before the public. Word freedom any authoritative speech means that it must have certain boundaries. In addition, in any authoritative work on the word land of our time, it is emphasized that freedom of speech is important because it is one of the pillars of a democratic society.

It is considered free when the thought can be expressed for a person without negative or dangerous consequences. Thought can be learned from words, because the word is considered to be an objectification of thought for others. By expressing their thoughts in words, texts, a person becomes their public property. If people had not used the right of the word husband, they would not have been able to fully communicate with each other and would not have been able to transfer knowledge and experience to each other. Russian philosopher as V.L.Solovev correctly noted: "neither science, nor art, nor civil society could have been formed" [7].

Word freedom is its natural and inseparable right, which is inherent in the inner world of man, forms the basis of all spiritual life and does not allow any aggression and interference of man without his own consent. In addition to rights such as residence permit, freedom, dignity, personal inviolability, etc., the right to think and the word land is a necessary condition of the life of a civilized society, which must be recognized unconditionally and protected by the state.

Word freedom is the ability of a person to express in any way his thoughts and beliefs in public, to make it public, to disseminate. However, we must understand that there is a difference between discussing political news with a neighbor and talking to a journalist on television. That is why one person's face-to-face or casual communication with another person on any issue does not have social consequences, such as a person's regular speech in front of a group of people. Therefore, the essence of human freedom of speech lies in the realization of the possibility of open communication with its listeners. The essence of freedom of speech is in finding the truth.

Finding the truth is a continuous process. Word-language-thinking mechanism, this is a program of consciousness. According to Hegel, freedom is a substance of consciousness, "While world history is considered to be a development in the understanding of freedom"[8]. The activity of the brain is aimed at finding the truth that is realized with the help of thinking, language; it cannot be done without the freedom of speech. Thinking is a continuous process of collecting and analyzing information about the world around us and the person himself. The word husband is necessary in order to share information that can be both real (socially useful) and false (socially negative). Misunderstood information can lead to the death of both man and all mankind.

### CONCLUSION

In place of the conclusion, we can say that the word freedom is a philosophical category that characterizes the essence of the existence of mankind, which is characterized by the ability of a person to think independently, not to confuse his thoughts as a result of internal or external factors, but to freely express himself in accordance with his ideas and desires.

### REFERENCES:

1. Попов А. А. Реализация свободы в обществе поздней современности : дис. ... канд. филос. наук. Волгоград, 2005. 151 с.
2. Фалсафа қомусий луғати Т.:”Шарқ”2004, 464-бет
3. Oripov Kh.A. The role of freedom speech in development of society //ACADEMICIA an international multidisciplinary research journal. India. P 1387. Vol.11, Issue 1, January 2021.
4. Авесто: Тарихий-адабий ёдгорлик. Асқар Маҳкам таржимаси. Т.: Шарқ, 2001. – 400 б.
5. Темур Тузуклари Т.:Ғофур Ғулом.1991.15-бет.
6. John Milton. Areopagitica – eller om trykkefrihet. Overs. Olav Lausund. Oslo: Vidarforlaget, 2010.
7. Русский эрос: Философия любви в России. М., 1988. С. 42.
8. Гегель Г. Сочинения : в 14 т. М. ; Л., 1935. Т. 8. С. 19.

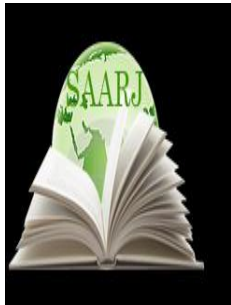

**ACADEMICIA**  
**An International  
 Multidisciplinary  
 Research Journal**  
 (Double Blind Refereed & Peer Reviewed Journal)



**DOI: 10.5958/2249-7137.2021.01270.2**

## FUNCTIONAL SEMANTIC FEATURES OF EUPHEMISMS IN GERMAN AND UZBEK LANGUAGES

**Kholiyarov Lutfulla Tashkuvatovich\***; **Rustamov Abdushukur Alibaevich\*\***;  
**Mamaziyayev Zokhid Kholboevich\*\*\***

\*Associate Professor,  
 Uzbek State University of world Languages,  
 UZBEKISTAN

\*\*Teacher,  
 Jizzakh State Pedagogical Institute,  
 UZBEKISTAN

\*\*\*Teacher,  
 Jizzakh State Pedagogical Institute,  
 UZBEKISTAN

### ABSTRACT

*In this article, euphemism the application of alternative words instead of forbidden (tabulated) words, during the application of these alternative words, an unfavorable environment that may arise as a result of the application of units banned (tabu) by the speaker is thought to be loosened. Also euphemism, in the opinion of many authors, is regarded as the exchange of non-unity into a reasonable unity, reveals that they are not only a dictionary unit used in place of taboos, but also units used in place of words that are not suitable for the cultural circle.*

**KEYWORDS:** *Euphemism, Alternative Words, Expressive, Impressionable, Thought, Linguistics, Speech Etiquette, Text, Rude, Term, Lexical Unit, Cultural, Phrase.*

### INTRODUCTION

The emergence of euphemism is associated with the conception of mankind and the development of its moral values. It is manifested not only as a phenomenon of language, but also as a tendency for a person to change his speech situation to some extent. While the acceptable word can be used, the unfavorable environment that can arise as a result of the application of units

forbidden by the speaker (taboo) is softened. And when forbidden words are said to be equated with humanity, there is no exaggeration.

The term euphemism is derived from the Greek language and, in the opinion of many authors, nouns are regarded as the exchange of unity into reasonable unity. A.A.Reformatsky gives the definition that “Euphemisms are words that are allowed to be used instead of forbidden (tabulated) words”.

And in the “linguisticheskoy encyclopedicheskoy slovar” it is called “euphemism is an emotional neutral word and expression that is used in place of words and expressions that are rude, uncomfortable in the point of view of the narrator, meaningfully to them”.

In linguistics about euphemism, so many opinions are put forward. Much more controversial issues have also arisen among linguists in this regard. The phenomenon of euphemism softens the rudeness of the meaning of words having a nominative meaning in the language on the basis of a metaphor. Also in euphemisms, impressiveness of images becomes extremely strong and gives a cultural tone to thought. Euphemisms are not only a dictionary unit used in place of taboos, but they are also units used in place of words that are not suitable for the cultural circle. Some thoughts about the feature of euphemism were noted by a number of linguists. Euphemisms are a kind of semantic migration, more precisely, they also occur through the migration of the word meaning. Usually many understand the combinations that are used in place of words that are not suitable for the cultural circle when they say euphemism. For example: instead of saying that he died, he passed away from the world, closed his eyes, died; instead of saying that he gave birth, expressions like a blindfold are used. The use of euphemism in the language was formed as a historical ethnographic phenomenon in connection with the phenomenon of taboos. Euphemism is associated with the development of customs, cultural level, aesthetic taste and ethnic norms in peoples. With the development of the language, its euphemistic layer also develops. New forms of euphemism are emerging on the basis of new norms of morality, new worldview. In the language there is also euphemism, which arises with the demand of a certain speech situation, the meaning of which is often understood through the text. For example, “*Раънони эгасига топирмагунимизча, — деду Низор ойим, — қуйилмайдиганга ўхшайди*“ it is like pouring” (A.Kadiri) in the sentence, the phrase euphemism in the form of an assignment to the owner in place of the phrase giving to the ground from the point of view of speech etiquette is used. Euphemism is widely used in scientific and official methods.

German languages, that is, German and English, are also very rich in euphemism and euphemistic phraseology, and speakers use this tool very widely in implicit use of different meanings.

Especially in the current period, euphemisms are used in the performance of all functional functions of the language—from oral colloquial speech to the language of official documents. Below we will refer to examples that include quite extensive socials in German and English, which have appeared in the next decades, in the sense that they are now commonly used and meant.

Examples in English are accident-unhappy event instead of incident-unpleasant event; disaster-unpleasant event instead of distress; Addict-substance instead of cocaine-drug abuser or chemical dependency-chemical taboo case phrases; Arrest-append instead of prison sentence-resort to action, words restricting freedom; illegal-illegal words instead of criminal-criminal;



Death penalty-death penalty capital punishment instead of soy-the word combination of higher punishment; drunk-intoxicated instead of intoxicated soy tispy-drunk, shot, drank words; Fat-fat soy instead of overweight-heavy-weight, chubby-drum. portly-the word; instead of informer-squeal-suffix, the words confidicent source-reliable source are used.

What is the history of the emergence of euphemisms? In what situations do we use euphemisms? In the application of euphemisms, an interesting regularity is observed in English, that is, a large part of euphemisms came into the English language from the Latin language, and the words they replaced, softened or concealed are the words of the native English-Saxon. This process began in 1066 year, marked by the desire of Norman, and the English historian Farb observes one very interesting thing in this regard:.. "the community began to make a distinction between a genteel and an abscent vocabulary between words of the upper class and the lusty Anglo-Saxon of the lower that is why a duchess pired and menstruated-while anitchen maid sweated and spat and bled" (Farb 1974.the r.80)-"... the team began to distinguish between cultured and vulgar words. The high flight of the upper class is silent, and the simple, heel language of the English-saxsons, belonging to the lower class, begins to move away from each other vividly. Therefore, the Countess wakes up, sees the saliva, the pharynx, and the moon, and the white man sweats, spits and experiences the arrival of blood from the vagina, that is, he sees menstruation. This is what the content of this observation consists of. The sociolinguistic situation caused by the Norman invasion was characterized by the fact that the English-Saxon people's language with Latin and French kept its dictionary wealth completely. Representatives of the upper classes tried to use new words created from the Latin core, instead of simple words of the English-Saxon language.

Now we will consider the euphemisms in German examples: das Zeitliche segnen instead of die Fe, das Weite suchen instead of Sone Fe, nicht auf dem Damm instead of sick so, in anderen Umständen, Stilles Örtchen instead of toilet so, Allgemeinmediziner instead of Hausarzt so, Abschiebung so instead of Aufenthaltsbeendende Maßnahmen, Vertreter außendienstmitarbeiter instead of Sor, vormund Sor instead betreuer, Dumm Sor instead bildungsfern, vielredner Sor instead gesprächspartner, Hausmeister Sor instead facility manager, Zensuren verteilen Sor instead fördergespräch, entlassen Soi instead freisetzen, Tod Soi instead heimgang, gewerbeinheiten Soi instead industriepark, Fett Soi instead korpulent, pedantisch, besserwischerisch Soi instead korrekt, teuer Soi instead kostenintensiv, bilanzfälschung Soi instead Kreative Buchführung, Bauer Soi instead landwirt, Bauernhof Soi instead landwirtschaftlicher Betrieb, Linien instead of Falten Su, Mimikfältchen, the words liquidieren instead of ermorden Su are more used.

At present, several euphemisms are emerging, especially in the next decade in Uzbek, German, English. We will witness that this phenomenon occurs before our eyes, in our speech. Of course, it is a difficult phenomenon to give up suddenly from the words that are learned, that is, they are usually used by people in oral speech. Even so, in written speech, we are forced to apply euphemisms. And in colloquial speech, the prepositional alternative of words is more used. If the new alternative of some of the words that we use in our speech comes out, it would seem that the old alternative of this word is rude to use in our oral speech. Because the new alternative somehow seems to be gentle, imaginative, touching.

We will refer to examples. The hostel term instead of student accommodation, instead of the word combination orphanage sor-children's house, instead of the orphanage Sor, instead of the word combination orphan Sor-lost the breadwinner, instead of the word combination

commandant sor-the head of the building, instead of the word combination library-term-the center of information resus are using new terms.

Usually the phenomenon of euphemism is accompanied by a softening of the rudeness of the meaning in the word, and it has the property of pronouncing objectivity and impressiveness in speech. And this process is characteristic of fiction-literature.

In the latter times, the cases of applying euphemisms in the performance of all the functional functions of the language, from colloquial speech to official documents, are more common.

We will analyze the following examples: cocaine, cocaine-consuming a lot of drugs instead of words; user words more than the norm of medicines; the term of blockade-take action instead, restricting freedom of speech combinations; bombardment-word combinations instead of supporting air; the term of the demon-illegal term; the term of orphanage-instead of the term-a combination of words of the house of a garbage collector is a word combination of a person who provides purity instead of a word combination; killing innocent people-a word combination instead of a word combination-a word combination of unforeseen victims; poor-a word combination instead of a word; prisoner-a term rather than a term of a prisoner; imprisoned-a word combination instead of a term; poor children-a word.

All of the above examples can be seen in official documents or diplomatic documents.

In summary, it is necessary to emphasize that euphemisms are not only used in the process of speech or in the artistic literature to replace coarse, shy words with other milder, more beautiful words, but also it is customary to use some words in official documents or diplomatic documents instead of vocabulary, terms, phrases.

As a rule, in official documents or diplomatic documents, specific vocabulary terms and vocabulary should be used. This point of view has changed considerably by the present time.

The use of euphemisms in official documents is typical in the current era of globalism at a time when cultural communication between people is developing.

This process, however, has led to the emergence of alternatives to new euphemisms, but further the use of euphemisms in official language or documents.

#### REFERENCES:

1. Омонтурдиев А., Ўзбек нутқининг эвфемик асослари, Т., 2000.
2. Исмагиллаев Н. Эвфемизмы в узбекском языке. Автореф дисс. канд филол. наук-Ташкент, 1964. 24 с
3. Миртожиев М Синекдоха ва унга ёндош ходисалар. Ўзбек тили ва адабиёти журналы, 1967, № 1, 33-38 бетлар.
4. Шомақсудов А., Расулов И., Қўнғуров Р., Рустамов Х., Ўзбек тили стилистикаси, Т., 1983.
5. Шахтури К.К Эвфемизмы и их роль в изменини значения слова. Автореф дисс. канд филол.наук-Тбилиси. 1956.24с
6. Қодирова Х.Б. Ўзбек тилида эвфемизм ва дисфемизм. Т., 2013.

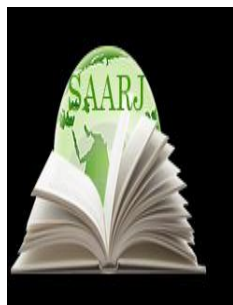

**ACADEMICIA**  
**An International  
Multidisciplinary  
Research Journal**  
(Double Blind Refereed & Peer Reviewed Journal)

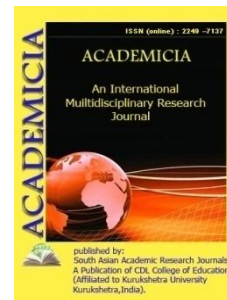

**DOI: 10.5958/2249-7137.2021.01271.4**

## **INNOVATIVE APPROACH TO ENSURING THE CONTINUITY OF TEACHING COMPUTER SCIENCE IN THE SYSTEM OF CONTINUOUS EDUCATION OF THE NEW UZBEKISTAN**

**Rasulov Inom Muydinovich\***

\*Head of Department Distance Education,  
Kokand State Pedagogical Institute named after Muqimi,  
UZBEKISTAN

### **ABSTRACT**

*The education sector is one of the most innovative industries, which largely determines the creation of an innovative climate and the competitiveness of the economy as a whole. Modern realities of life make traditional methods and technologies of teaching subjects ineffective and uninteresting. Computer science has always been in an advantageous position relative to other subjects, as the use of ICT is an integral part of the subject itself. But how to correctly use this advantage is decided by the teacher himself. In this article highlights of innovative approach to ensuring the continuity of teaching computer science in the system of continuous education of the new Uzbekistan.*

**KEYWORDS:** *Innovation, Innovative Approach, Computer Science, Education, Quality Of Education, New Uzbekistan.*

### **INTRODUCTION**

In the modern conditions of reforming the educational system of Uzbekistan, various innovative processes are becoming increasingly widespread. The testing and introduction of new forms and methods of work is a constant need for education. At the same time, the development, testing and implementation of innovations in the education system should be considered as a continuous process, as a component of everyday educational activities.

At the beginning of the twentieth century, a new field of knowledge was formed - the science of the new, innovations, which studied the patterns of occurrence, development and introduction of innovations in material production. However, in a short time, innovations have moved into the

social sphere, and, consequently, into education, which lays the foundations for pedagogical innovation. In the literature, the concept of innovation is interpreted in different ways.

Today, innovations in education consist in the introduction of new goals, content, methods and forms of training and education, in the organization of joint activities of teachers and students; changes in the style of professional pedagogical thinking. The term we use in the educational environment: innovation activity-refers to the process carried out in order to ensure the modernization and development of the education system, taking into account the main directions of socio-economic development of the Uzbekistan, the implementation of priority areas of the state policy of Uzbekistan in the field of education. This term is used in the federal law on education. Innovative activity is focused on improving both scientific and pedagogical and educational-methodical, as well as organizational, legal, financial and economic, personnel, material and technical support of the education system. If we consider the typology of innovative approaches to learning, we can distinguish two main types of innovation: innovation-modernization, innovation-transformation, corresponding to the reproductive and problem orientation of the technological approach in the educational process. Innovations-modernizations that modify the educational process are aimed at achieving guaranteed results within the framework of its traditional reproductive orientation. The underlying technological approach to learning is primarily aimed at communicating knowledge to students and forming ways of acting on a model, and is focused on highly effective reproductive learning.

Innovations-transformations that transform the educational process are aimed at ensuring its research nature, organizing search-based educational and cognitive activities. The corresponding search approach to teaching is aimed, first of all, at forming students' experience of independent search for new knowledge, their application in new conditions, the formation of experience of creative activity in combination with the development of value orientations. According to many scientists, innovative educational technologies should be focused on the formation of systematic creative thinking of students, their ability to generate non-standard ideas when solving educational, practical or creative tasks, which in turn is a formative factor of professional competence of future specialists.

At the same time, the main requirement for the modernization of education is the transition from an informative learning model to a developing one, which involves the formation of students not only subject knowledge, but also the ability to independently acquire them. It is important that computer science and ICT, due to the universality of its system-forming concept of "information" and the information approach generated by it in scientific knowledge, contributes to the construction of interdisciplinary connections in the educational process, and can be adapted to the professional needs of the future specialist, and also implies an independent deepening of practical knowledge and skills.

In our innovation activities, we use the case technology method. The essence of the case technology is that the student is given a description of a certain situation that a real organization has encountered in its activities or that is modeled as real. The student should get acquainted with the problem on the eve of the lesson and think about ways to solve it. In the classroom, in small groups, there is a collective discussion of the above case from practice. Each case is a complete set of educational and methodological materials developed on the basis of production situations, forming students' skills of independent design of algorithms for solving production problems. The case activates the students and allows them to perform practical work, developing

analytical and communication skills, leaving the trainees "one-on-one" with real situations. The use of cases in the study of information technologies allows you to learn how to organize object surveys, work with input and output data, be able to understand, create, analyze and process them, as well as work with unstructured information - its search, verification, formalization, processing and storage. The trainees quickly develop the necessary skills to enable them to carry out actions and procedures in the field of information technologies that they will have to face during their practical activities. The case-based learning method is a method of active learning based on real-world situations.

The advantage of case studies is the ability to optimally combine theory and practice, which is quite important in the preparation of students. In the process of teaching computer science and information technology, the case acts as an object of study (students themselves develop their multimedia varieties) and as an effective means of teaching. The introduction of the case method in teaching computer science and information technology allows us to implement a competence-based approach in practice, which develops the methodological system of computer science, enriches the content of the educational discipline. Within the framework of the subject of computer science, case technologies can be applied to such topics as: "Forms of information representation", "Types of graphics", "Text aesthetics. Fonts", "Tabular information models", "Object information model", "Viruses and antivirus programs", etc. The greatest effect can be achieved with a systematic approach to the choice of traditional and innovative learning technologies, with their reasonable combination, complement each other and with effective leadership of group and inter-group discussion.

Summing up the use of case technology in teaching, it should be noted that this method contributes to the activation and development of cognitive abilities and creative abilities of students in computer science lessons. Also, the creation of an educational and methodological complex, the main part of which is implemented in the form of an electronic manual, can be attributed to innovative activities. We implement this technology to work with students during the course of the following topics: "Information Theory", "Information coding". The peculiarity of Information theory as a scientific and educational discipline is that its applied component is in demand by many people, including those who are very far from the scientific sphere. Information theory is a science that studies the general properties of information, methods and means of its processing (collection, storage, transformation, movement).

The role and place of the discipline is determined mainly by the following factors:

- informatics as a science of natural, technical and social significance is rapidly developing today, based on the practical needs of increasing the level of scientific, technical, organizational and methodological support for the sustainable development of the world community in the conditions of the emerging and predicted "information explosion";
- Continuous scientific support of the increasing volume of practical developments related to the creation, implementation and operation of information systems is required;
- Theoretical foundations of computer science a worldview science because the subject of its study is information. Therefore, the study of the main sections of the discipline should not only provide the necessary theoretical training of the future computer science teacher directly to practice, but also form the basis for further education and education of information culture, which determines its integration, ideological and methodological functions.

Information theory deals with the study of information as such, its appearance, development and destruction. This section is closely related to the theory of coding, whose task is to study the forms of representation of information when it is transmitted through various communication channels, as well as during storage and processing. The topic "Information encoding" is the basis for the formation of concepts about the content of the processes that occur inside the computer when the user works on it. It is not related to the formation of computer skills, so it is most interesting for the organization of independent and individual work of students to study the ways of encoding information.

The formation and development of competence in the field of working with information in computer science lessons occurs mainly through the content, since the discipline itself involves working with information in different directions. For conducting computer science lessons, the following technologies are used:

- activity-based learning-expressed through the method of practical work;
- problem-based learning-expressed through a partially searchable method, a method of solving problem situations;
- project training-the project method is used;
- game training-the business game method is used;
- discussion training – the methods of discussion and "brainstorming" are used.
- In the training sessions such techniques are used to form and develop information competence:
- counter-arguments of the teacher to the alleged opponent in the process of presentation;
- presenting students with a deliberately broken logic of presentation, proof and analysis of the results obtained by the teacher;
- disclosure by the teacher of the causes and nature of failures encountered on the way to solving problems;
- teacher's discussion of possible consequences made from incorrect assumptions;
- dividing the material presented by the teacher into developing semantic moments;
- fixing students' attention on the sequence of contradictions that arise in the course of solving problems;
- an intriguing description by the teacher of the object being presented, followed by a question statement;
- the teacher's attitude to the students ' mental solution of the logical task put forward in the course of the presentation;
- rhetorical questions of the teacher during the presentation;
- presenting students with a conflict example.
- inclusion of students in the argumentation of the hypothesis put forward by the teacher;

- task for students to find the hidden nodal links of the reasoning proposed by the teacher;
- assign students to solve several subtasks selected from the difficult original one, after which the students return to the original problem;
- leading questions to students, helping them choose the right ways to solve the problem, while simultaneously pointing out different approaches to it;
- task for students to find errors in reasoning, which requires an original thought;
- organization of specific observations of the student, prompting the formulation of the problem;
- task for students to summarize the facts presented by the teacher in a special sequence;
- showing a method of action with a partial disclosure of its internal connections with the student;
- task for students to advance the next step of reasoning in the logic set by the teacher;
- demonstration of an object, a phenomenon, prompting the separation of the essence;
- color selection of a part of the drawing, diagram, record, orienting students to advance the problem, etc.
- I constantly use the Internet resources in my teaching activities as for myself:
- when selecting material when creating a website or presentation and when preparing for a lesson;
- for personal professional development;
- to increase the motivation of students to learn.
- I organize the work of students in the classroom using Internet resources as follows:
- front-end (virtual trips, excursions, network projects);
- individually (search, selection and analysis of information);
- in groups (implementation of a common training project).

When using information resources on the Internet in the organization of cognitive activity of students in the classroom and in the course of independent work, it is necessary to take into account their level of preparedness and the conditions available for this.

The most popular and effective technologies are currently the following:

1) Interactive technologies that allow you to: first, to establish contact between children and their peers in the group and with adults; secondly, it allows you to be involved in the learning process; third, it helps to create different learning situations in the group (taking into account the individual characteristics of each child), for which various options can be used.

These technologies allow teachers to independently create educational material for the child, taking into account its features and needs, as well as to make the necessary changes as quickly

and flexibly as possible. When selecting topics for individual projects, I take into account the interests of students and their inclinations and hobbies.

The project method allows students to master the ability to build a chain: from an idea through goals, tasks, brainstorming to the implementation and protection of their project. When completing a project, students use a plan that defines the project criteria. Computer modeling also provides great opportunities for using the project method. Here we are already talking about the fact that the development of a computer model of a particular process or phenomenon is in itself a kind of projective activity. If the student knows the techniques of programming, then in this case he has the opportunity to deeply penetrate not only into the very essence of the phenomenon, but also into its mathematical model, which then needs to be embodied in a visual image. Working on the project encourages the student not only to study in depth any topic of the course, but also to master new programs and software products, use the latest information and communication technologies.

## 2) Remote technologies

Modern computer technologies completely change the concept of distance education. After all, now, despite the fact that the student is outside the classroom, he can gain knowledge and actively participate in the educational process. It is also extremely important to constantly and effectively support and support specialists and teachers, because it is on them that the successful education of children depends. During the pandemic, these technologies have shown their effectiveness and the possibility of using them as additional to the main technologies.

I will focus on some of the teaching methods that I use in the lesson and which are innovative in nature: the method of research or "problem solving" is at the heart of educational collaboration, because it is a reproduction of the natural process of discovery or cognition of reality. In order to create such conditions in the organization of the educational process that allow students to develop the skills of search and research activities and develop their independent activity and interest in the subject, I include tasks in which children try to independently explore and analyze a combined text with elements of description and narration. Group communication in educational activities is of particular importance for the development of the child. It promotes the creation of business, collective, and interpersonal relationships. In the process of communication, it is possible to supplement the general activity with individual interests and inclinations. Working in groups, students are responsible for the success of each, learn to help each other. The inclusion of students in the computer science lesson in business communication provides high cognitive activity, which undoubtedly has a positive effect on the effectiveness of the learning process.

Group activity in a computer science lesson consists of the following elements:

1. Preliminary preparation of students for the implementation of the group tasks, setting training tasks and a brief briefing.
2. Discussion and preparation of a plan for the implementation of the training task in the group, distribution of responsibilities.
3. Work on the implementation of the training task.
4. Monitoring the work and adjusting the work of the group and individual employees students.
5. Mutual verification and control over the performance of the task in the group.



6. Students' report on the teacher's call about the results obtained, general discussion in the classroom under the guidance of the teacher, addition and correction, additional information from the teacher and the formation of final conclusions.

7. Individual assessment of the work of groups and the class as a whole.

The technology of learning in collaboration can be largely implemented in group work using a computer and other technical means. Training programs and computer models, virtual laboratory work, and the creation of multimedia presentations are the best suited for working together in pairs or groups of students. At the same time, the participants of the work can perform both the same type of tasks, mutually controlling or replacing each other, and individual stages of the overall work. When performing tasks in pairs or groups, the same level of technical skills is not required, and in the process of working together, the practical skills of students who are more "weak" in this regard are also improved.

#### REFERENCES:

1. Беспалко В.П. Слагаемые педагогической технологии. - М.: Педагогика, 1989.
2. Farhodjonova N. F. Modernization and integration: social-philosophical analysis. Rol'nauki v formirovaniisovremennojvirtual'nojreal'nosti. – 2019.
3. Bobomurodovich, B. M., &Makhamadaminovich, S. M. (2020). Human capital is made in the family. ACADEMICIA: An International Multidisciplinary Research Journal, 10(2), 144-150.
4. Farhodjonova N. F., Abdurahimov V. A. MODERN TECHNOLOGIES OF STUDENTS TRAINING IN HIGHER EDUCATION //НАУКАИТЕХНИКА. МИРОВЫЕИССЛЕДОВАНИЯ. – 2020. – С. 5-7.
5. Sodikjonov, M. M. (2020). EDUCATION AS THE MOST IMPORTANT FACTOR OF HUMAN CAPITAL DEVELOPMENT. Theoretical & Applied Science, (4), 901-905.
6. Голиш Л.В. Технологии обучения на лекциях и семинарах: Учебное пособие//Под общ. ред. акад. С.С. Гулямова. - Т.: ТГЕУ, 2005.
7. Mahamadaminovich, S. M. (2020). THE ESSENCE OF SOCIAL CAPITAL CONSEQUENCES AND THEIR INFLUENCES TO THE MODERN SOCIETY. Вестник науки и образования, (2-2 (80)).
8. Farhodjonqizi F. N., Dilshodjonugli N. S. Innovative processes and trends in the educational process in Uzbekistan //ACADEMICIA: An International Multidisciplinary Research Journal. – 2020. – Т. 10. – №. 4. – С. 621-626.
9. Farhodjonova N. F. Problemiprimeneniyainnovatsionnixtehnologiy v obrazovatel'nomprotsessenamejdunarodnomurovne. Mejdunarodnaya konferentsiya. Innovatsionnietendentsii, sotsial'no-ekonomicheskieipravovieproblemivzaimodeystviya v mejdunarodnomprostranstve. – 2016.
10. Numonjonov S. D. Innovative methods of professional training //ISJ Theoretical & Applied Science, 01 (81). – 2020. – С. 747-750.

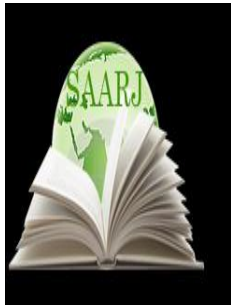

DOI: **10.5958/2249-7137.2021.01286.6**

## FROM THE HISTORY OF COURTS IN BUKHARA

**Alimova Mokhichehra Muzaffarovna\***; **Mirzaqulov Beshim Tangrievich\*\***

\*Senior Lecturer  
Department of "Social science"  
Buxoro Engineering and Technology Institute,  
UZBEKISTAN

\*\*Assistant of Professor  
Department of "Social Science"  
Buxoro engineering and technology Institute,  
UZBEKISTAN

### ABSTRACT

*This article is devoted to the history of the judiciary in Bukhara, based on written sources that the judiciary was created in the 7th century and operated on the basis of Sharia law. It is argued that during the reign of the Mangit dynasty in Bukhara, the official who held the post of Qozi kalon was given great powers, and a corresponding scientific conclusion was made.*

**KEYWORDS:** *Amir, Qozi, Qozi Kalon, Sharia, Mufti, Imam, Fiqh, Mudarris, Sheikhulislam, Chairman.*

### INTRODUCTION

The term "qozi" is Arabic, meaning decisive, executive, judgmental. With the formation of Islamic teachings and the formation of Muslim communities, the post of Qazi was established from the VII century. Appointed by the ruler in Muslim countries, he served as a judge on the basis of sharia, that is, he was considered the chairman of the sharia court.

In the Arab Caliphate, the first caliphs were appointed by the Prophet Muhammad, and then by the caliph Umar. During the time of Khulafoi Roshidin, the veterans only considered civil affairs, the resolution of the jinoi cases was in the competence of the caliph or regional governors. The office dealing with the complaints was headed by the head of state whom he appointed.

The judge ruled the affairs of non-Muslim citizens on the basis of their religious books. It was possible to appeal to the Caliph over the judge's judgment. In the period when the Arab Caliphate was ruled by the abbosi caliphs, the post of supreme qozi (Qoziul-quzzat) was introduced.

From a practical point of view, the position of the judge did not stain his reputation, was scientific, knew enough of the laws of sharia, which every free (non-slave) Muslim without physical defects and justice could occupy. According to the dish, the veterans were provided with state treasury supplies. [1]

During the reign of Somoni, the minister of amir Abu Muhammad Nuh (in 940-ies), Abu Zar, was actually the ruler of Bukhara, the scholar of fiqh science.

Sometimes the judge had a general authority, and also had the right to judge by the whole country. Sometimes there were also cases when his authority was limited to one province or urban area.

In Bukhara, during the reign of the mangit dynasty (early XX century), the chairman of the Bukhara Qozikalon Sadri Ziyoy - Muhammad Sharifjon ibn Qozi Abdushukur - Shakur, wrote in his memoirs that the judicial power in the emirate, that is, the work of the Qozikalon, was specially organized, for such a post were appointed ulamo and sodot (Sayyids), and they were equated to the governors. They are sheikhulislam, qozi ul-huzzot, qozi askar and voliyi askariya.[2]

In the Central Asian khanates there is a post of qozikalon, which was considered the chief judge, the highest judge of the highest rank, that is, the chairman of the supreme founding. The qozikalon was the head of all the rulers, the pious and the mullahs, who controlled over them. It should be said that the Chief Judge carried out both religious and judicial works.

The functions of the qozi kalon were not the same in the khanates. For example, in the Khiva Khanate, qozi kalon was also considered the chairman of all law issues and the army administration. Also with the calls and scandals of citizens, the qozi kalon was engaged. But the work, which may require a higher punishment, was considered by the Khan himself. In the first half of the XIX century, in the Khiva Khanate, it was noted in the sources that the Qozi kalon had 11 navkars. At the official reception, the qozi kalon was on the right side of the Khiva Khan, on the first place. [3]

As shown in the work of Muhammad Yusuf Munshi "History of the Muqimkhan", the first place was occupied by the right of the Khan was sheikh-ul islam, then the qozii buzruk (the great judge), then the khojas, the sadr, after them the qozii askar, then the alam and chief of staff.

The Qozii askar was considered the qozii of military service in the Muslim Eastern countries, and on the right side of the Khan at the official reception after the qozikalon, in second place. [4]

In the later period of the rule of the mangit dynasty, the appointment of the imam to the mosques of mudarris to the provinces, the chairman, madrasahs, etc. were also included in the task of the Bukhara qozikalon.

During the reign of Amir Abdulahadkhan, the qozikalon Badiuddin of the emirate of Bukhara, after his death, Baqokhan, Burhoniddin during the reign of amir Olimkhan, Muhammad Sharif sadr, then again Burhoniddin worked in this position. It is also possible to know from the following that qozikalon has a high position in the emirate: qozikalon Burkhoniddin's brother

Karomiddin is in Chortoy, his brother's son Aminjan Mahdum Sadr in Khayrabad district, his older son Umarkhan is in Pirmast district in career of Avraqi, his younger son Usmonjon is also in the career of Avraqi in the Zandana district.

According to the order established in the emirate of Bukhara, governors and veterans of the regions once a week officially filed for the state of the country. The applicant, who brought the application to the amir palace, could not return until his answer came out and was obliged to wait for this answer. [5]

In the XIX century, about 300 officials served in the palace of the emirate of Bukhara, received salaries from the state treasury and was completely dependent. And in the local government system, about thirty thousand officials served, and the governor and his officials were not paid by the state, they would spend the day off from the account of taxes, fees collected from the people. The governor said there was no clear law that would determine the activities of the tax collector and diggers.

According to the information of 1915 year, the emirate of Bukhara consisted of 27 provinces (principalities) and 11 districts. With the tax affairs of 9 districts, the veterans subordinated to the qozikalon were engaged. According to the established procedure, the district or province was governed by the bek, the judge and the chairman appointed by the amir, who were employed by the amir, but could not execute a citizen without the amir's decree and the consent of the muftis. [6]

The court, which carried out the judicial proceedings by the judge, was called the qozikhona. Although according to Islamic rules, the Kazakhs should be at the mosques, in most cases the judicial work was carried out in the Houses of the Kazakhs, and on Sunday in the markets. In the khanates, including in every genius of the emirate of Bukhara, there was a qozikhona. The Kazakhs worked under the control of the people's courts from 1917 year. Gradually, the stakes decreased: in 1925 year 87 units, in 1926 year 27 units, in 1927 year 8 units. In 1924 year 5 January "regulations on the construction of a court" the judicial system in force in the BPSR was established. [7]

For the local population, as a result of this change in the judicial case, the form of the court of judges was changed and the existing single-headed judge was formed instead of the collegial judge. Subsequently, by the decree of February 18, 1928 of the SSR XKS of Uzbekistan the courts of the Republic of Uzbekistan ceased their activities.

After the introduction of Turkistan into the Russian Empire, special attention was paid to the regulation of the management of the country. The goal was to adapt it to its own interests by thoroughly studying the national values of the people. Russian Orientalist Ilminsky in his time wrote the following: slowly it is necessary to interfere with the people's trust. Such conclusions should be sought from them themselves, so that they gradually learn to think Christian, Russian. Only then will they unite with the Russian people not only in language, but also in thought and writing. For this purpose, a member of the Russian government – senator, graf inspection by K.K.Palen began with 13 July 1908 year, and continued until the beginning of 1909 year. The main attention was paid to the study of the legal and economic life of the Turkic country. As a result, in Central Asia, the rules of law, the basics of sharia, which were in force at the end of the XIX beginning of the XX century, were studied. The activities of fiqh (jurisprudence) and mufti (fatwo) were analyzed. [8]

Legal education was carried out in madrasahs in Central Asia, including the emirate of Bukhara. Dozens of luxury madrasahs were also built by khans and amirs who were rulers in Bukhara. Only in the XIX century more than 60 madrasahs were built. It is known from sources that at the beginning of the XX century in Bukhara there were more than 200 madrasahs. [9]

To a certain extent, attention and funds have also been paid to the preparation of people with knowledge for the Gazi courts, Kazakhstanis. Muftiyids, muezzins, imams and have been allocated a share of the funds received from the foundation to the mudarris who teach shariah science. For example, muesli were given a shekel a year, a hundred nuqra coins. At the end of the XIX and early XX centuries, the amir of Bukhara allocated one hundred thousand rubles a year for madrasahs and their mudarris and teachers. [10]

The sciences taught in madrasahs are divided into three groups:

- 1) Arabic grammar.
- 2) Theology and jurisprudence
- 3) Philosophy

The future diggers were also forced to study the sciences that were divided into these groups. After mastering Arabic language by madrasa students, the course is divided into two sections: the general education course - the course of difficulties and the course of law. The reading of which of these sections is determined depending on the desire of the madrasah student. That is, students could finish reading either both departments or separate coursework if they wanted to.

When Khayyam calls for joy, pleasure in his moral views, he says that his views should be human duty in a person, abandonment world refuses to enjoy real life, that personal happiness is not the main goal of life, but that personal happiness in human society depends on collective happiness [11].

During the course of the course of the issue in madrasah, books such as Fiqhi Kaydani (the doctrine of the actions of compulsive and non-binding factors, which are approved and prohibited), Mukhtasar ul-viqaya (a brief description of religion and civil law), Sharhul-viqaya (the interpretation of the fact), Hidoya-i sharif (a perfectly given book on the issues briefly considered in Mukhtasar ul-viqoya) were read. For example, Sadridin Ayni in madrasah studied Muslim jurisprudence from mudarris Mulla Abdusakoi - "Mukhtasar ul viqoya".

Who was in Bukhara in 1840 year while N.Khanikov was writing about the madrasahs, in order to read the full course in the madrasah, he was asked to study 137 books from students, of which most corresponded to the sciences of philosophy and logic.

In conclusion, along with Islamic education, Islamic belief and Islamic culture, the legal culture formed in our country, has its place in our spirituality and history of a specific judicial system and the study of this does not always lose its relevance. After all, the deeper we study our past, the more just conclusions we draw from it, the greater and more perfect our future will be.

#### REFERENCES:

1. Ўзбекистон Миллий Энциклопедияси 11-том.
2. А. Фитрат. Амир олимжоннинг ҳукмронлик йилларим. Т. 1992.

3. Муҳаммад Юсуф Мунший “Муқимханская история” Т. 1956. Срт.19-20
4. Б. Мирзакулов. Бухоро тарих зарвақларида. 1-китоб. Т. Lesson Press. 2016.
5. Рисолаи “Мунтахабул-масойил”. Т. Академия нашриёти. 2002.
6. Ф. Бобожонова. Бухоро амирлигида таълим тизими (XIX аср охири-XX асрнинг бошлари) Т. “ADIB”. 2014. 37-38 бетлар.
7. Сухарева О. А. К истории городов Бухарского ханства. Т. Изд. АН УзССР. 1958. стр. 98.
8. Айний С. Бухара (Воспоминания)-Душанбе: Ирфон, 1981.стр.40.
9. Хаников Н. Описание Бухарского ханства. СП б. 1843. Стр. 222.



**ACADEMICIA**  
**An International**  
**Multidisciplinary**  
**Research Journal**  
 (Double Blind Refereed & Peer Reviewed Journal)



**DOI: 10.5958/2249-7137.2021.01287.8**

## THE EFFECT OF TEACHING VOCABULARY THROUGH ICT ON EFL LEARNERS

**Munavvar Bahodirovna Fayzullayeva\***; **Ismigul Baxtiyorovna Sattarova\*\***;  
**Manzura Adashevna Makhmudova\*\*\***

\*Faculty of the English Language I,  
 Department of the English history and Grammar,  
 Samarkand State Institute of Foreign languages,  
 Samarkand, UZBEKISTAN

\*\*Faculty of the English language I,  
 Department of the English history and Grammar,  
 Samarkand State Institute of Foreign languages,  
 Samarkand, UZBEKISTAN

\*\*\*Faculty of the English language I,  
 Department of the English history and Grammar,  
 Samarkand State Institute of Foreign languages,  
 Samarkand, UZBEKISTAN

### ABSTRACT

*This study examined the impacts of using ICT devices in education and for teaching and learning the English language. It is vital to mention that the article is devoted to highlight the effects of utilizing ICT tools to improve learners' vocabulary and their oral performance. The English language is one of the languages in the world which is rich with words, phrases and expressions. Most of language learners have difficulty to learn new words and to remember them for long time, for this reason the researcher gave some examples to enrich students' vocabulary by the help of ICT tools.*

**KEYWORDS:** *Computer Assisted Language Learning (CALL), Direct Method, Grammar Translation Method, Audio Lingua Method Or Audiolingualism, ICT (Information And Communication Technology) Applications, Web Based Learning, Non - Web Based Learning*

---

## INTRODUCTION

As it is fact that the English language is considered to have the most enormous vocabulary in the world and knowing vocabulary of any languages is vital part of learning second or foreign languages. Vocabulary learning is emphasized by most computer assisted language learning (CALL). Many vocabulary exercises, such as gap filling, matching, crosswords, chain words, text-reconstruction, vocabulary games are considered as exercises of CALL application.

One of the celebrated linguists David Wilkins claimed that: “without grammar little can be conveyed, without vocabulary nothing can be conveyed”. Therefore, vocabulary is one of the most essential parts of teaching and learning any language. People need words in order to express their opinions, feelings and ideas in any language. Vocabulary is considered as a main and vital tool for learners to use English fluently and effectively. It is fact that, words, phrases and sentences are necessary while communicating with a native English speaker, while writing a letter to somebody, while listening one’s conversation or speech or listening your favourite English songs and while reading foreign books, or just a text in English. It goes without saying that most students find out difficult to speak English fluently and accurately. They are always dissatisfied with their speaking and writing in English as they keep on using the same words, expressions and phrases very often while writing or speaking. The lack of vocabulary is the main reason for such communication. Some of them stated that they forget the words instantly after sometimes, and it is also the cause of lack vocabulary. However more students can easily learn new words and memorize them well.

Some centuries ago there were such approaches as Direct Method, Grammar translation Method and Audio lingua Method or Audiolingualism, and teaching grammatical structures were important part in three of them. In that period the main accent was on the grammar, few words were used and only grammar rules were taught. But in the beginning of the 1970s, in teaching English was observed a great change as Communicative approach was used. In that method vital part was teaching and learning vocabulary. During the courses number of new words were introduced and utilized while communication and learners used in order to express their thoughts.

It is visible that the role of a teacher is essential in enriching students’ vocabulary. ICT is one of the main tools for implementing this task. As there is main barrier in learning and remembering new words is memory problem. It is known that any new topic begins with large or small amount of vocabulary which students have to learn by heart in order to understand and realize the theme or context. Most teachers know that it is somehow impossible to learn all new words of the topic and remember them for a long time. It is obvious that students learn the words mechanically as a parrot and do some tasks and exercises and after sometimes they easily forget them. If a teacher wants to check up the new words, most of students cannot remember at all. In order not to forget vocabulary of each lesson, a teacher should have appropriate, modern and interesting method with the help of ICT applications for satisfying the new generation of our century.

In order to draw students’ attention to the lesson a teacher should be creator and skillful in using modern technologies. As it has been mention that “ICTs are important for our young generation as the breath”. For this reason it is possible to hold vocabulary lessons in a computer class with the internet access. A teacher can easily download important materials, handouts and activities for students beforehand and learners may do the tasks with great interest. In addition, they may



do online some vocabulary activities such as, gap filling, matching, finding synonyms and antonyms of the given words and others on the computers, in few minutes they may get feedback and they may know their scores about their tests in the same time. These kinds of lessons will be motivational and interesting, while using IC devices students enjoy and satisfied with their doings.

Pronunciation is one of the basic components of the language which always goes with vocabulary. I would like to call them as brothers in any language. In order to pronounce the word correctly language learners should know the transcription and pronunciation of the word. According to linguist Dr. Raval, there are two types of ICT applications: they are Non web based learning and Web based learning [23,26]. Non web based learning includes itself radio and television, films, overhead projectors and language lab. Therefore language lab is one of the modern and useful technological teaching aids for learners to improve their vocabulary and pronunciation. Language lab has multi functions as students can listen to the tracks, audios and understand the different accent used and are able to speak and even they may record their voices. The learners' pronunciation level could be improved day by day by listening the materials and be enriched their English proficiency. It is worthy stating that language laboratory can make friendly atmosphere than a traditional classroom.

Language learners find out some difficulties of English vocabulary. There are some words which are easier to learn and to use them in their speech while other words' pronunciations and spellings are more difficult to pronounce or to write. They are called as "false friends" in a language. "False friends" are words which have identical forms with Romanian words but they have different meanings. For example, while writing the words "admissible" or "accessible", most of students write them as "admissibil" or "accessibil". In order not to make a mistake with "false friends" learners should have enough experience. There are words as "do" and "make". It is true that they may have the same meaning, but they are utilized differently, with different expressions. Learners may have hesitation or confusion to use these words in expressions as "do homework", "make a decision" and so on. That's why teaching vocabulary is very significant to the students. There may be faced some problems with teaching vocabulary. Teachers sometimes have problems while teaching new words as they don't know how to select the words to teach and how to teach them, what vocabulary should be taught and for what level. It is easier to teach more concrete words rather than abstract words to language learners. As there are such words "book", "pen", "flower" which are stood in front of students. There are some words as "kind", "polite", "honest", "love" which are not represented in front of them or in the classroom and they are very difficult to explain them. Therefore in order to explain such abstract words for students teachers should utilize ICT applications such as with Power Point presentations, videos which express attitudes and relations among people.

There is another problem of vocabulary teaching as many words have more than one meaning, however they have one form of writing. For instance, the word "can" refers in one dictionary as "modal auxiliary verb, to know how to, to be able to, to be possible", but in another dictionary it reflects as "a container used to carry and dispense water for plants". So we will have to say that "can" sometimes refers as a tin-plate canister for preserved foods and in the USA it has another meaning as "toilet" or "bathroom" as well as "buttocks". When we run across a word, we try to translate and understand its meanings, as there are number of meanings of a word so that we should realize the current meaning from the given context. Some years ago, students were used

to present with reading texts, text books with pictures in order to learn new words, but nowadays thanks for ICT applications it is very easy, interesting and more suitable way to show vocabulary of the topic to students. The result of ICT and computer devices' development teaching and learning vocabulary and activities become more different and fun. According to Dudenney, Chapelle, Young and Melor Md Yunus, "the use of technology as a tool to develop the different language skills has received great attention, so that, teachers are frequently exposed to new materials" [24,11].

ICT devices are considered as main tools and helpers of teachers in education, they can provide many solutions for teachers. Teachers know that when new topics are presented students should learn all new words of the given texts. But it is not easy to learn all words for a long time, in order to remember necessary vocabulary, students should be encouraged by the help of ICTS and teachers should have some new techniques and approaches to interact and satisfy the learners who are living in the era of modern and new information and computer technologies. ICT tools are very vital applications to enhance teaching and learning vocabulary, not only for the language learners but also for teachers. For tutors ICTs are professional and new aids and resources to explore number of methods and different ways of teaching vocabulary, for students they can provide with any facilities and opportunities to improve their vocabulary by doing a lot of activities and tasks. Using ICTs is somehow complicated in a class, therefore teachers should be skillful and have specific ability to teach vocabulary with the interaction of ICT tools. Teaching vocabulary is not just presenting only new words, but also to teach students how to utilize new phrases and expressions in their every day speeches. Language learners are introduced amount of new vocabulary in the course of a week. Some of students can use the words, but others cannot to utilize them, they do not know how and when the words should be used. In order to solve these kinds of problems teachers should use computer technologies such as overhead projectors (OHP), Power point presentations (PPT), DVDs, video materials as most of students are visual type of learners, so that visualizations should be used with authentic examples and the new words should be used on them.

According to a scientist Hulstijn, there are two methods of learning vocabulary, as implicit learning paradigm and explicit learning paradigm [25,2]. Words can be improved by the repetition many times and with reading given contexts in implicit learning paradigm. It is also called as the process of acquiring vocabulary and grammar through communicative activities as listening and reading. In explicit learning paradigm contexts are important source for introducing new vocabulary. There are two categories in the approach of explicit learning paradigm. They are known as explicit instruction and strategy instruction. Teachers use different direct memorization techniques in order to teach vocabulary to students. As it is pity that we can come across with low level learners, teachers should give more attention to them to possess enough vocabulary for reading fluently and extensively. It goes without saying high level learners and low level learners should be taught vocabulary in different ways. As for high level students teachers can easily use direct teaching method, for example, by utilizing word cards, peer teaching or pair working, teacher' explanations are enough for the students to obtain knowledge. However, the students who are low level they should be taught in different way, through videos, animations and music. In this case ICT tools are significant aids for teachers and learners. In order to draw learners' attentions, teachers use interesting materials on the computer technologies while presenting a new word rather than using fixed materials and presentations

from the books or dictionaries. Computers can combine texts with pictures, graphics and visuals with listening materials and movies. Low level learners will find out them interesting and challenging. By the help of watching videos or movies with subtitles they can easily learn new words in a fun way. The given vocabularies are shown in the real situations, they will remember all new words for long time. ICTs are considered as variety and creativity tools in students' life to present new words.

### **Methodology.**

The participators of the small investigation are twenty eight of second year students at the Institute of Samarkand state of foreign languages. This study was conducted with two different groups, one of their first foreign language (FFL) is Spain, and another FFL is Italian, however their second foreign language (SFL) is English. The investigation was aimed at to teach vocabulary in two different ways as with the help of ICT tools and in a traditional method.

Three materials for the research were chosen, they were word lists, vocabulary and ICT devices. Word lists were prepared from the book "504 absolutely essential words" sixth edition by Murray Bromberg, Julius Liebb, and Arthur Traiger. The book was published in the USA. Each word list contained 12 words and they were taught by two groups' students in a week. The experimental group taught the new word with the help of ICT, and the control group used traditional way of vocabulary learning.

After learning new vocabularies they were examined. Each of the test consisted of 40 questions and tests on vocabulary items. They had only 30 minutes in order to fulfill the task, for each question were given 1 point. The items were pre-testing, post-testing, multiple-choice and gap filling.

The results of the experimental group were 9 from pre-test (90%), for post-test they got 10 (100%), for multiple-choice they obtained 9 (90%), and for the last activity 8 was their scores (80%).

The controlled group who used traditional method achieved for pre-test activity was 7 (70%), from second test they got 8 (80%), for multiple-choice they obtained 6 (60%) and 40% of activity was done by the controlled group. The results were given in the following diagram:

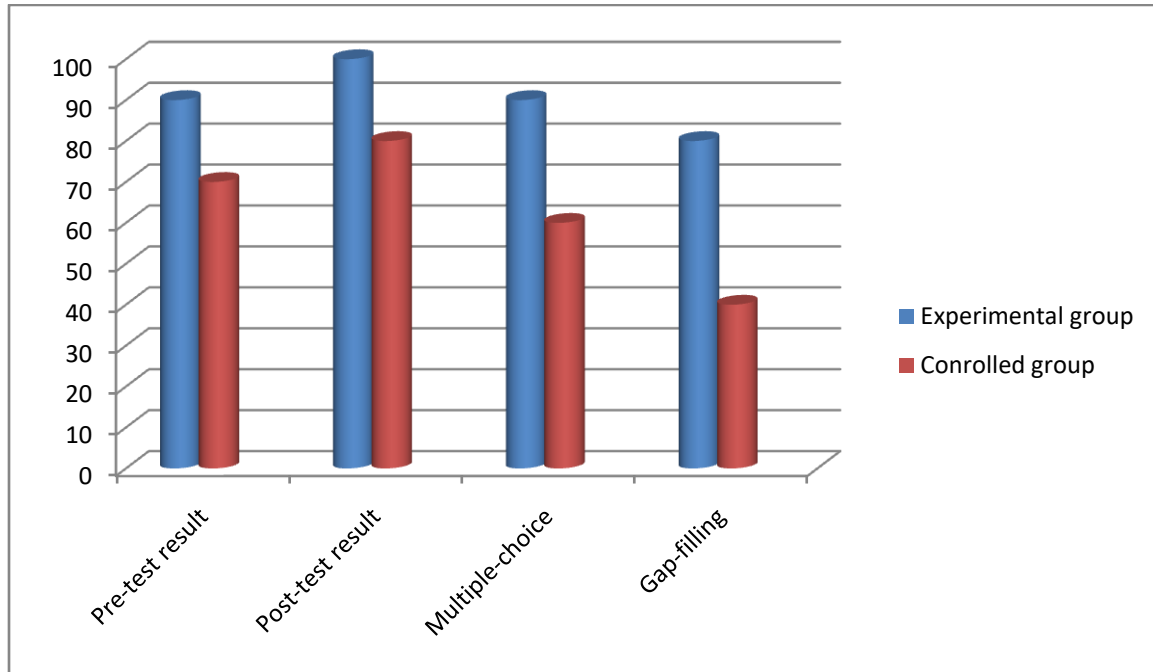

**Diagram1. The results of both groups in learning new vocabularies.**

A teacher used some ICT applications such as OHP (overhead projector), IWB (interactive whiteboard), TV set, a computer with the internet, CD rooms in order to show new words with real examples. Teaching with ICT tools was very fruitful and fun for both a teacher and learners and the results were visible from the diagram. The experimental group was satisfied with the teaching way and their results as well.

So, it means that teachers of the English language should utilize from the modern and new educational tools as ICTs, the lessons will not be boring and can draw the attentions of all students even the low levels.

## REFERENCES

1. Dr. Raval, M. R. "Use of ICT in English Language Teaching". International Journal of Research in all Subjects in multi Languages. – P: 21-24. 2014.
2. Dudenney, Chapelle, Young and Melor Md Yunus. "ICT in ELT: how did we get here and where are we going?". ELT Journal, 66 (4), 533-542.
3. Hulstijn. "Approaches of learning vocabulary".:-P. 349. 2003
4. Brown. H. D. "Language Assessment Principles and Classroom Practices. Pearson Education: Longman". 2004.
5. Dudley Gavin & Hockly Nicky. How to Teach English with Technology. England Pearson Educational Limited, 2007.
6. Kuo, L. L. "The effects of Youtube listening/viewing activities on Taiwanese EFL learners' listening comprehension". Doctoral dissertation, La Sierra University, the USA. Retrieved January 4, 2014

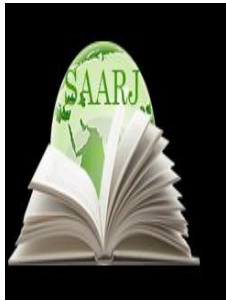

**ACADEMICIA**  
**An International**  
**Multidisciplinary**  
**Research Journal**  
 (Double Blind Refereed & Peer Reviewed Journal)



**DOI: 10.5958/2249-7137.2021.01288.X**

## A NEW APPROACH TO VOCAL-CHORAL SKILLS

**Botirova Xilola Tursunbaevna\***

\*Acting Associate Professor of the faculty of Art History,  
 Andijan State University,  
 UZBEKISTAN

---

### ABSTRACT

*This article explains how to set the tone and shape the sound when singing correctly. It outlines the steps that need to be taken to develop singing skills. However, in addition to the above qualities, the singer must also know how to comprehend the song. The song should be full of sincere feelings of the performer, it should come from the heart. A song that is memorized and sung in a dry way, that is, without the feelings of the performer, does not reach the heart of the listener.*

**KEYWORDS:** *Song, Skill, Art, Singer, Education.*

---

### INTRODUCTION

It also increases the aesthetic impact of a song number what instruments are used in a song, and how well they are chosen,

Instruments should be appropriate to the nature of the melody and the music in general. For example, M. Burhanov was the first to add lyricism and sincerity to the song. The melodic performance is also an important factor that has a positive effect on the aesthetic power of the song.

Harmonious good performance and it's vigor, high technique are one of the conditions for increasing the aesthetic impact of the song on the audience. The lyrics and the ideological content of the song are a powerful tool for aesthetic education. It is a tool that affects not only the emotions but also the mind, arouses feelings of compassion, stimulates thinking, creates a variety of spiritual assessments, that is, helps to educate the audience morally and aesthetically.

Among the elements of the structure of singing skills, the artistic features of the song, such as language, style, rhythm, and poetic perfection, are also of great importance. Sometimes the melody of a song is good, but also if it is performed flawlessly, its lyrics are far from perfect, and

it is characterized by inconsistency of form or absurdity of content. Such songs do not satisfy the audience, but irritate them.

There is another important element in the system of singing art, which is the pleasant performance of the singer, and this element also ensures the aesthetic effect of the song. However, singing is more important than performing. As a result, a well-tuned song loses its value due to the singer's inaccuracy, sometimes incorrect performance.

What is a singer's skill? In our opinion, this skill is first and foremost about having a good voice, being able to control it, a high level of performance technique, a pleasant timbre. But even with all this, some singers can't really impress their listeners. However, in addition to the above qualities, the singer must also know how to comprehend the song. The song should be full of sincere feelings of the performer, it should come from the heart. A song that is memorized and sung in a dry way, that is, without the feelings of the performer, does not reach the heart of the listener. So, the sincerity and enthusiasm of the singer is one of the necessary conditions for the high influence of the art of singing in the aesthetic education of the people.

Each real singer has his own style of performance. The great singer Caruso said, "There are as many ways to perform as there are singers. But these particular tracks, even if used correctly, may not be suitable for all other singers." Thus, when all the elements in the structure of the art of singing are sufficient, this art serves as the most important means of educating the general public in the spiritual and aesthetic spirit.

All the elements of the art of singing form a whole, and even the distortion of one of them reduces the aesthetic value of the song and the level of impact on the audience.

Now, let's look at song as an art genre. The songs reflect the spiritual world, life, history and whole life of the people.

The themes of the songs are rich and varied, and include love, joy and worry, aspiration, honoring greatness and heroism, narrating historical events, and so on.

The songs express people's attitudes, views, feelings and worldviews towards life.

Many songs in our country are translated into Uzbek. Songs of other nations are also sung and listened to. Russian, Ukrainian, Belarusian, Kyrgyz, Kazakh, Tajik, Tukman, Azerbaijani, Indian and other national songs are popular in Uzbekistan.

Songs have a strong place in the life and work of the people. They are the faithful companions of the people at all stages of their historical development. The song is important not only for expressing the feelings and aspirations of the people, but also as a very effective educational force.

The songs help to "build and live", encourage and lead to "labor and energy".

It is known that the songs of all nations have their own theme and ideological direction, and each nation expresses this theme and ideas in its own national form. In this context, we will consider the songs currently performed in Uzbekistan and express their role in the spiritual and aesthetic education of the general public.

The repertoire of Uzbek singers is rich and diverse. This richness is reflected in the diversity of themes, genres, melodies and performances.

Let's look at the themes that characterize the richness and diversity of Uzbek songs. The theme of patriotism and love for the Motherland is widely used in the songs of the Uzbek people. The songs praise the unparalleled heroism, courage, endurance, strength, will, confidence in victory and other qualities of our people, born of sincere, deep, boundless love for the Motherland, the desire to protect the Motherland and preserve its freedom.

These songs are characterized by high patriotism, enthusiasm, civic lyricism and deep emotion. That is why they play an important role in educating students in the spirit of patriotism. The educational power of these songs is that they truly and deeply express the feelings and aspirations of the people, have had a great aesthetic impact on people. The songs have become a powerful educational tool, especially as they affect people's minds and emotions.

The patriotic theme is reflected in the songs created at all stages of the development of the republic.

Patriotic songs are full of enthusiasm, lyricism and civic spirit. During this period, many songs about the Motherland were written in Uzbekistan. The "Song of the Motherland" written by M. Burhanov in the poem Shuhrat became a lyrical anthem honoring our Motherland. Many warm words can be said about songs D. Zokirov's "Flourish my dear Uzbekistan", S. Boboev's "The land of sun", A. Muhamedov's "Live long, free motherland".

M. Ashrafi's "My Uzbekistan", H. Izamov's "My Glorious People", S. Hayitbaev's "Flowers of Uzbekistan" are created in the traditional style of Uzbek folk lyric song. The most important features of such songs are lyricism, freedom, deep emotionality. These features correspond to the spirit of folk music and the character of our people, which is distinguished by its love of poetry, poetry and music.

S. Yudakov's song "Dear Uzbekistan" based on the poem by A. Mukhtor has a special place among the songs about the Motherland. It is a wonderful song that combines poetic text, music and rhythm. It reflects the development of our republic, peaceful labor, the labor of a happy, full-fledged man who strives for great heights.

A. Mukhamedov's songs "Beautiful Fergana" composed by the poet P. Momin, I. Hamroev's "My Uzbekistan" are the most popular songs about patriotism.

Songs about Tashkent, the city of international friendship and brotherhood, are also included in the series of patriotic songs.

In general, the theme of patriotism in the art of singing in Uzbekistan is very broad and comprehensive. If patriotic songs glorifying Uzbekistan are performed by singers with high skill, they will play an important role in educating workers.

The theme of labor is widely and comprehensively covered in the works of Uzbek composers and poets. Such songs reflect the hard work and respect of our people. It is said that labor is a source of happiness, joy, a measure of social wealth, a means of increasing the welfare of the people, an important factor in the prosperity of the country.

Songs praising work and hard work are also important in educating people, especially young people, spiritually and aesthetically.

The songs express the beauty and glory of the creative and selfless work of our people.

The theme of the art of singing is rich and multifaceted. It has a wide range of love themes. This topic is ancient and at the same time always young. It has existed throughout the history of the development of Uzbek singing, from the oral works of our past generations to our current lyrical songs.

Folk musicians and singers have written many songs about women's freedom and their new, happy lives. These include "Girl's Word", "Curly Hair", "Free Girl" and so on.

Composers of Uzbekistan "Poems", "Seven girls" based on the poems of A. Muhamedov's poet Polat Mumin, "Dongdor qiz" based on the poem of the poet Kamtar, many songs, such as "Heroic Girls", "Song of the Collective Farm Girl" by M. Kosimov, are about free women.

We have listed above the main, leading themes of the art of singing in Uzbekistan. But the issues of life expressed in the songs are not limited to these.

Modern songs cover and express all aspects of the life of the peoples of our republic, their feelings, life and spiritual world. This requires increasing the popularity and educational value of the songs. There is no doubt that the educational potential of songs is the result of poetry, music and singing.

Concert activities of TV, radio, cinema, variety, philharmonic, ensembles, amateur choirs and singers' groups, lectures-concerts, as well as concerts of representatives of music culture of other republics and foreign countries are the main ways to use the art of singing in the spiritual and aesthetic education of the working people. All these ways form a certain system of spiritual and aesthetic influence on each person and on our people in general.

Experimental work was carried out with students of 2nd "A" class, and below they read the song "Diyor Madhi" with music by N.Norkhodjaev, poem by H.Rakhmat, which was held with them in the II quarter. We refer to the development of the training process.

### 1. Voice adjustment exercises.

Voice adjustment exercises begin with controlling sitting position. When sitting, one should keep body straight and hands on ones knees without leaning on the chair.

The breath is inhaled through the nose without lifting the shoulders (as if smelling a flower) and exhaled through the mouth. This exercise is repeated several times. After that, one will learn breathing techniques while singing musical sentences (Exercise 1).

To breathe

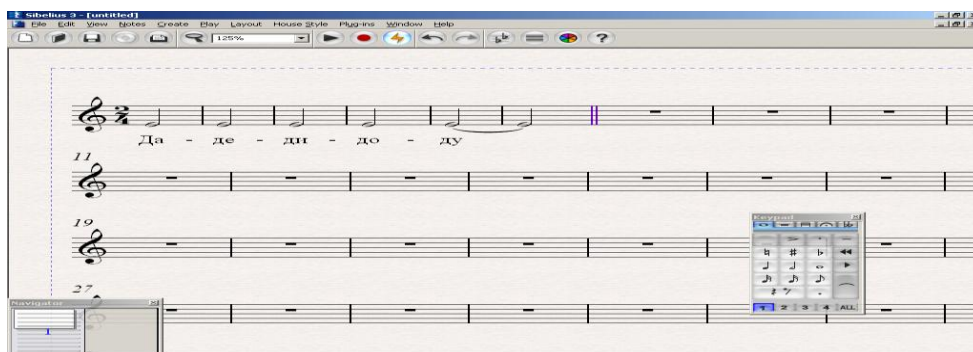



They are taught the rules of singing in unison, listening to their friends perform in a soft voice, not breathing between words.

Vocal sounds should be performed in a clear, resonant, high position (Exercise 2).

To pronounce vowels correctly (Exercise 2).

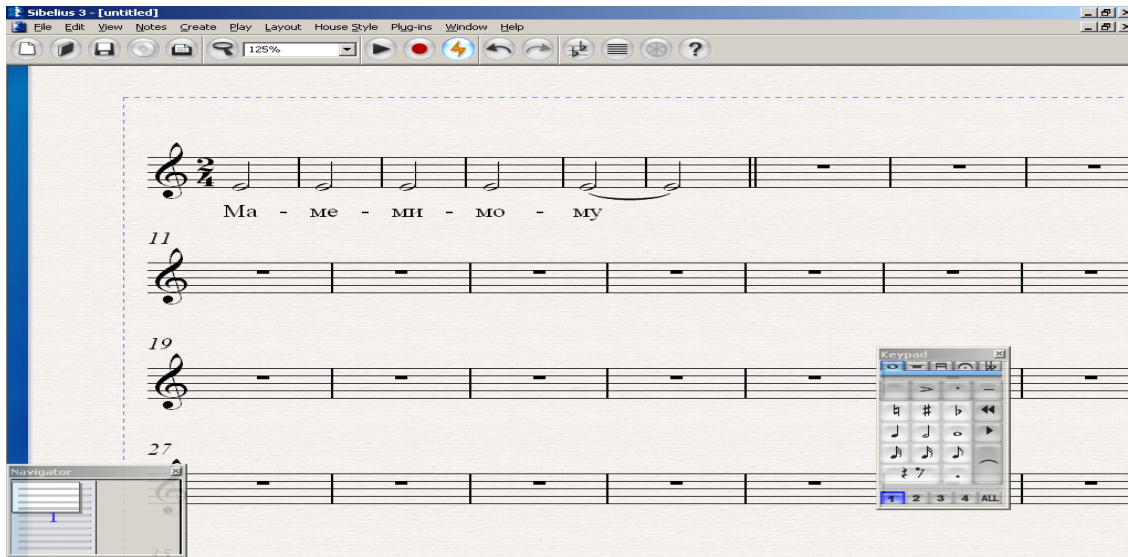

Consonant sounds should be sung short, clear, and understandable (Exercise 3).

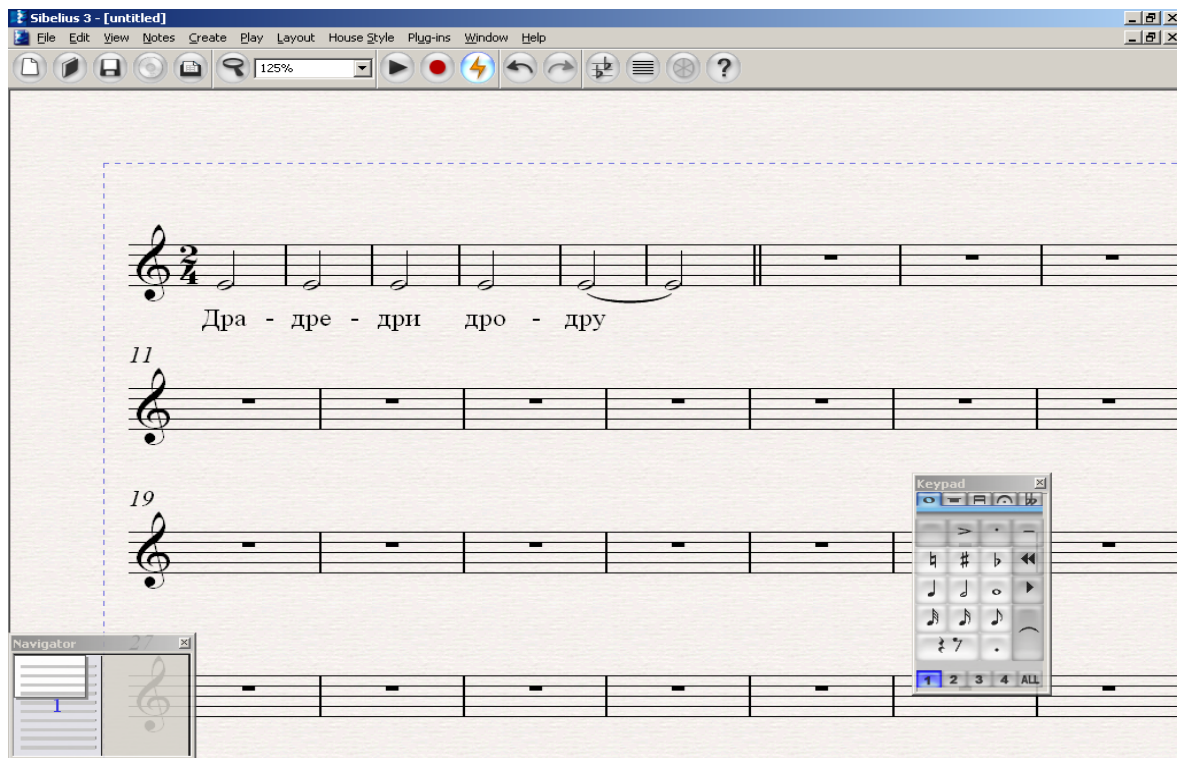

A variety of fun exercises can also be used to achieve clarity, clarity, and purity of pronunciation (Exercise 4).

It cannot be heard unless the exercise or song is sung in pure intonation. To achieve pure intonation, it is first necessary to achieve pure unison. Pure intonation or word is divided into 2 types, harmonic and melodic. A harmonic word is a simultaneous performance of vertically structured chords or sounds. Melodic sozesa means pure and clean performance in major or minor tones of horizontal intervals (Exercise 5).

Melodic

Harmonic

It is sung in the form of a gamma stokatto in a melodic state to develop diction and articulation (Exercise 6).

Singing in two voices develops students' ability to hear harmoniously. Exercises start with simple elements and become more complex. The exercises are sung in the form of a solfeggio with the names of the notes (Exercise 6).

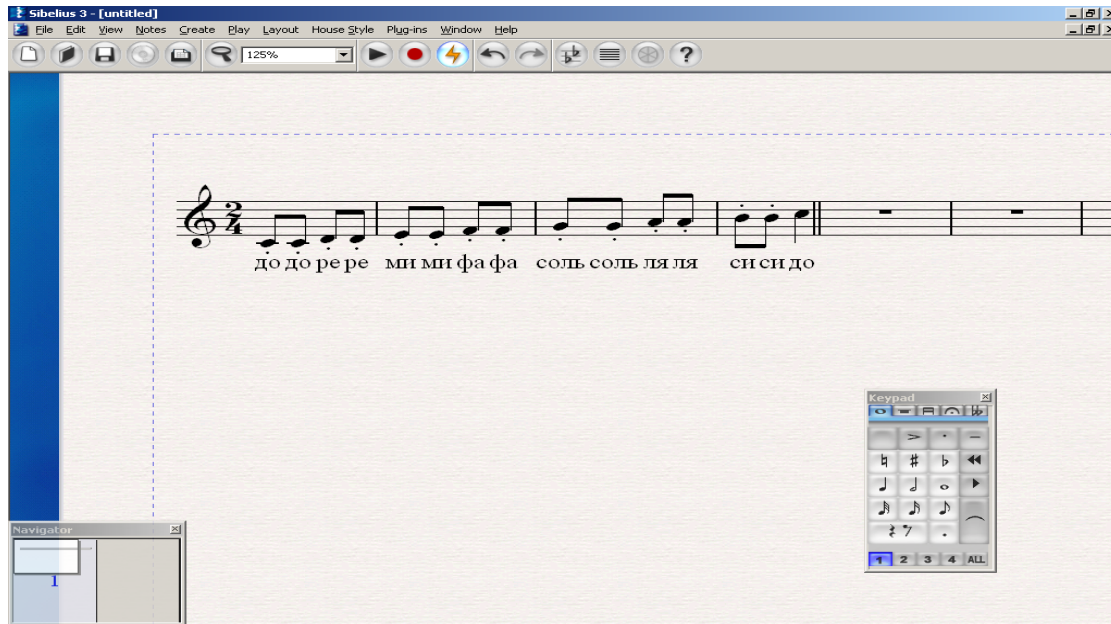

The screenshot shows the Sibelius 3 interface with a musical score in 2/4 time. The notes are: C4, D4, E4, F4, G4, A4, B4, C5. The lyrics are: до до ре ре ми ми фа фа соль соль ля ля си си до. A keypad window is visible in the bottom right corner.

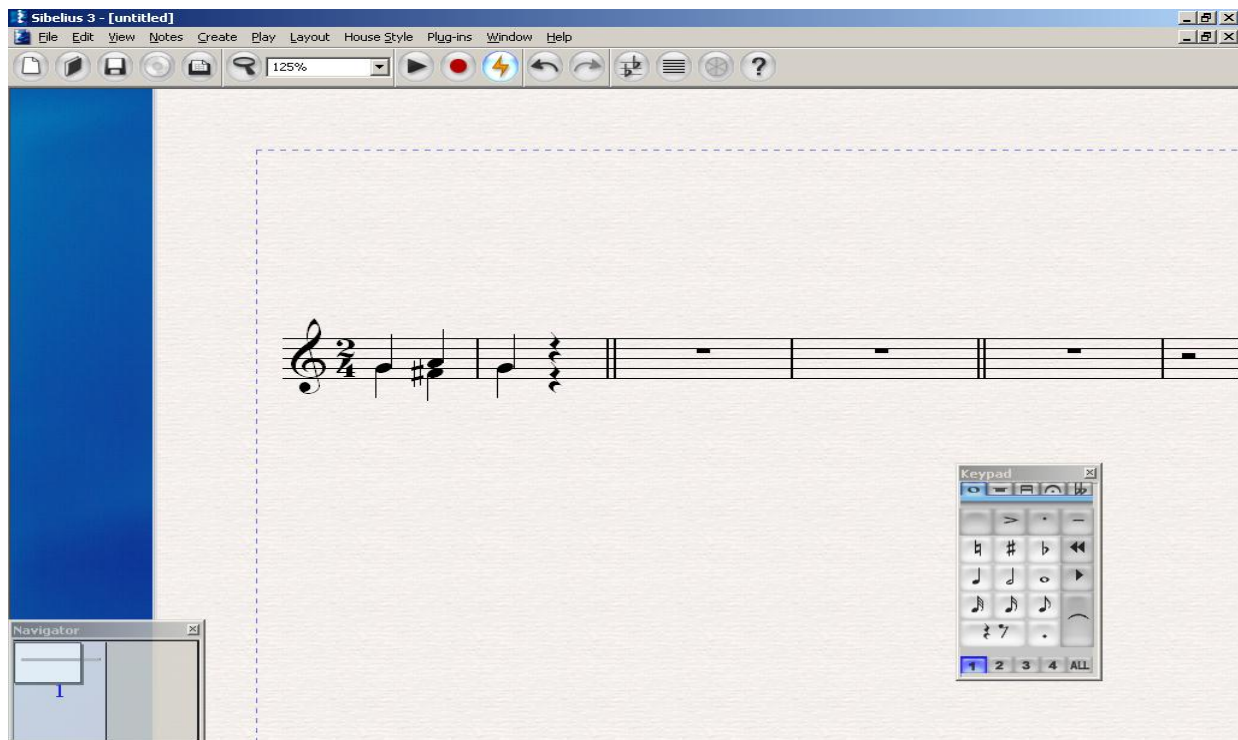

The screenshot shows the Sibelius 3 interface with a musical score in 2/4 time. The notes are: C4, D4, E4, F#4, G4, A4, B4, C5. The key signature changes from C major to D major. The lyrics are: до до ре ре ми ми фа фа соль соль ля ля си си до. A keypad window is visible in the bottom right corner.

## 2. Singing is done in four stages, just like listening to music:

Step 1: Provide information about the work, prepare for listening.

At this stage, information about the authors of the work is told to the students and a goal is set for them before listening to the work. Students should answer the following questions while listening to the work in order to learn more about the work being performed by the teacher:

- What is the nature of the work?
- What images are represented in the play?
- What are the means of expression of images?
- What is the tempo of the song?
- What can you say about the rhythmic features of the song?
- For what choir was the work written?

Step 2: Listen to the piece. Students are given a work by the teacher to listen to, expressively, accompanied by a musical instrument or using technical means (tape recorder, computer, programmer, etc.).

Step 3: Musical-theoretical and ideological analysis of the work. At this stage, students will be asked to answer the above questions. The answers were as follows:

Jahongir: - The character of the work is melodic, pleasant and lively.

Dildora: - The play reflects the love of students like us for the homeland, our honorable duties to the country.

Shokhrukh: - The work is expressed using musical-theoretical means of expression, such as tempo, dynamic characters, timbre and tone.

Sayyora: - The work is intended for children's choir.

Step 4- Introducing the final information and start teaching by the teacher.

Sounds 1 and 2 are used together because they are unison at the beginning of the melody. Care should be taken to ensure that the intonation is clear, crisp, and clear. It is also worth noting the rhythmic difficulty that occurs in the first phrase and during the melody - syncope. When you have finished working on the phrases, you can add them together and start playing them as a whole.

The two-part part of the song is taught separately for both sounds.

Sound 1                      Sound 2

A - - -                      Ni-yat-lar ul- kan, kat- ta.

Particular attention should be paid to the phrases of the two-part part of the song in refrain. Only when the first and second voices have a clear intonation can they be switched to two voices together. Repetition of phrases without choir to achieve accuracy will be a factor in achieving better results.

After completing the above steps, the text of the work will be worked on. It is important to note that the words in the text are pronounced according to the rules of diction and articulation.

O- na -Va- tan er- ta- si, Ke- la- jak- ning me- va-  
si, Bi- lim, hu- nar e- ga- si

Once the tone and text of the work have been mastered, work is done on its artistic aspects, such as character, dynamics, and rhythmic features. Care should be taken to ensure that other activities in the lesson are relevant to the content of the work being presented. The use of this work as an object of movement in the rhythmic movement activities of the lesson also ensures a more effective work.

Also, during the internship, I conducted experimental work in grades 4 "A" and 4 "B" on "Development of children's voices in the performance of choral works." In doing so, I conducted separate vocal and choral exercises on each child's voice. In order to successfully develop the characteristics of the voice of adolescents, it was necessary to resort directly to professional guidelines for the formation of choral and vocal skills.

An important way to develop your vocal skills is to take the right breath to sing. Students usually considered it the right way to breathe by raising their shoulders and chest to sing. They also quickly exhale and become accustomed to singing with the rest of the breath.

The following conditions must be met in order to breathe properly:

1. Get into the habit of not lifting shoulders while breathing.
2. Inhale not only through the nose, but also partially through the mouth.
3. Don't hold breath too much or too short.
4. Be able to focus breath on a musical phrase.
5. Breathe mainly into the abdomen.
6. Hold breath.
7. To be able to use the breath in a formal, economical way.
8. Be able to breathe with your classmates and start spending it at the same time.

In order to use their breath properly, students had to take into account the phrase they were singing. The breath vibrated freely in the vocal cords and was directed toward the mouth. It is important to avoid choking and making a muffled sound.

An important aspect of directing the breath to singing was to be able to form the words to be sung in the mouth. Proper pronunciation of vowels and consonants through the teeth, lips, and tongue is also important in singing. It is recommended to pay attention to the following important aspects of sound formation:

1. Know that singing aloud is an important part of sound production.
2. Consonants in short and sharp pronunciation.
3. Be able to spell words correctly.
4. Getting used to the free flight of the breath while providing sound flight, and so on.

4 Singing as a group, which is one of the activities typical of music lessons, played an important role in the development of singing skills of students in grades "A" and "V". During the group singing, all students had the opportunity to sing at once. And that gave the students a world of joy. As they sang together with all their classmates, the students felt the power of this union. Singing in a choir was a pleasure for people of all ages.

Like all human beings, children's voices are not always the same. Much depends on the mood, health and well-being of the students. That is why when they sing a certain note, the first one is noticeably lower, the second one is louder and the second one is more stable. In this case, the set of pronunciations is called a natural tuning. The piano has a certain agar-toned note that does not tend to decrease or increase. That is why the tuning of this instrument is called a flat tuning.

Because children's voices are as natural as adults', there were some shortcomings in the pronunciation of the intervals.

Choir experts with many years of experience have shown that it is necessary to use certain intonation features to pronounce intervals.

He proved that it is possible to pronounce the intervals in the process of singing by following these rules.

To sing melodic intervals correctly, it is recommended to sing their stages as follows:

1. All pure intervals should be sung in a stable manner on both stages of the pure-1, pure-4, pure-quintet, and pure-octaves (i.e., down and up notes).
2. All small intervals small-2, small-3, small-6, small-7 The first stage of the intervals was stable, and the second stage was reduced, that is, striving downwards.
3. All large intervals were sung by the 1st stage of the large-2, large-3, large-6 and large-7 intervals, and the 2nd stage was sung by raising.

The major and minor scales were also sung mainly in accordance with the above rules.

One of the most important elements of the choir is the ensemble, which is derived from the French language and requires all choir members to sing together.

Melody is the most important means of musical expression. Musical melody is like human speech. Man expresses his emotional state to others through the tone of speech, the tone of speech is expressed through the pitch, lowness, vibration, weight of the voice. the tone takes on a whole new artistic quality. The tone of human speech is the basis of the artistic language of

music and serves as a means of expressing the composer's attitude to reality in music. Centuries of experience in the field of speech have created a person's musical sensitivity and perception, the ability to comprehend music.

The collaboration of teachers and students in the music education process is used as a specific aspect of education. Students sing in groups, listen to music, and perform musical activities. Students share experiences, emotions, successes and failures. The teacher, with his teaching methods, makes a great contribution to the formation and development of musical abilities in students. Music culture classes have a number of tasks for the teacher.

The analysis of the music education system and the generalization of its positive aspects allowed to develop new types of music lessons.

The use of new pedagogical technologies to make music lessons more interesting with the challenges of our time is yielding good results. To make the lessons more interesting and uplifting, we offer the following types of lessons.

Concert lessons, quiz lessons, interview lessons, competition lessons, orientation lessons (using illustrative material), "around the table" lessons, self-awareness lessons, defense lessons, picture gallery lessons, the smart and the merry. Each of these courses has its own structure, function, and methodological basis.

The most widely used types of courses are:

1. Organizational lessons.
2. Mixed lessons.
3. Dominant (one type of activity in the class - singing, listening to music, music literacy, musical creativity is superior to others).
4. Control lessons.
5. Complex lessons.
6. Interview lessons,
7. Defense lessons.
8. Closing lessons

Music teachers base their choice of repertoire on specific styles. These methods include:

**1. Explaining the content of musical works is one of the most important methods** Because the reader cannot comprehend the work if he does not have an understanding of its content, requirements, and means of expression. This style requires them to take into account their cognitive abilities and to complicate the work as the possibilities increase. From simple to complex, from known to unknown, the effective use of visual aids is a means of ensuring the comprehensibility of musical works. For example, in the lesson "Working on the means of expression" on the work "Diyor Madhi" (music by N.Norkhodjaev, poem by Habib Rahmat) the tempo (Andantino), dynamics, strokes (ligato, nonligato) and information about the role of the piano accompaniment in revealing the content of the work makes the lyrics even more impressive. With the help of Habib Rahmat's text, the content and essence of the idea of a perfect man can be fully revealed.

**2. To focus on the development and upbringing of students' spiritual world of musical works.** Any musical work requires students to cultivate mental thinking in their mental activity, to observe the peculiarities of things and events in life, to determine its boundaries in relation to human life and lifestyle, as well as to understand everything. requires the ability to evaluate the place of an event in life. This requires constant attention of students, attention, observation, attitude to spiritual and cultural life, knowledge and skills. Like any other art form, music has the potential to develop a unique spiritual worldview. In particular, many examples of folklore (alla, lapar, terma and yalla), patriotic musical works written by composers, arouse the feelings of teenagers about the Motherland and make them feel at home. and increases love for national values. It also develops aesthetic taste, that is, the ability to feel and understand beauty. In this way the moral qualities are settled in their thinking. The manifestation of this principle is closely connected with the scale of educational influence, which consists in the nationality of musical works, their essence, which motivates them to love and protect the Motherland. This approach makes it necessary to include in the curriculum the knowledge that develops students' attitudes to reality through music and develops their skills system.

**3. In visual works of music,** although the content and essence are conveyed through artistic means, the artistic image of the idea embedded in those melodies is still visible. Demonstration plays an important role in the musical perception of adolescents. The use of musical instruments, teaching aids, and computers facilitates musical comprehension. For example, equipping a music room with specialized visual aids, equipment, pictures and photographs, the use of recorded musical illustrations in the process of mastering musical works gives positive results. The main source of the exhibition is the use of existing opportunities for students to visualize the artistic images that express the ideological ideas inherent in the content of the work.

**4. Relate musical works to the topic of the lesson.** Musical works are systematized within a specific topic and are aimed at imparting musical-theoretical, practical and ideological knowledge to them, helping to develop their worldview and knowledge, making it much easier to understand the content of the lesson. For example, in the process of imparting theoretical knowledge about the natural major and the natural minor lads , it is easier to master by analyzing the current musical work, identifying signs of alteration, showing the relationship of steps, stable and unstable sounds.

**5. Adapting musical works to students' real cognitive abilities.** This method is primarily based on the theoretical and practical knowledge acquired by primary school students. If they have the theoretical foundations of music in the educational process and the level of norms set by the standards, then it will be easier to work on them. Students' ability to learn realistically is also closely linked to their age and personal mental characteristics. Of course, the chosen work should be appropriate to the age of the student and should be aimed at increasing their interest. There are some works that help students to think independently and use their abilities to develop their singing skills. For example: "Vatanginam" (My lovely motherland) music by A.Mansurov, poem by P.Mumin, music by F.Alimov "Ahillik - dostlik" (Solidarity-friendship), poem by P.Mumin, "Song of young soldiers" Jalil's music, S.Barnoev's poem, R.Abdullaev's "Navruzqoshigi" (Navruz song) , Nazarmat's poem, etc. are among such works. Musical works usually express the social and spiritual environment that is familiar to students and directly surrounding them, as well as events related to their daily activities in such a way that they develop ideological thinking, and attention to the situation requires them to be, increases their spiritual wealth. As a



result, students' ideological thinking expands. It is known that the idea described in almost all musical works is familiar to students. For this reason, musical works, while expressed through a variety of artistic means, are always in tune with the students' explicit musical cognitive abilities. In addition, the emotions and experiences that are familiar to students are enhanced by the music.

**6. The method of gradually complicating the selection of musical works is important.** For example, the use of educational and pedagogical works for students is in the form of development from simple to complex, musical works based on theoretical knowledge, systematized, requiring thinking, comprehension and drawing conclusions are recommended. These works are recommended not only in terms of performance, but also in a structured form that evolves in content.

**7. A way to increase student engagement in learning music.** This style is determined primarily by the interest in folklore, composition and various areas of art. Because at the heart of any activity lies interest. Through curiosity, the student strives to develop. Striving is a mental state of a person, it is a way to look from the unknown to the known. Only when the selected pieces of music are of interest to the students will they become active. Interest is inextricably linked to the level of complexity of the chosen work, cognitive abilities, and relevance to the scope of theoretical knowledge.

By working on the content of the piece of music being studied, students begin to understand the nature of socio-political and economic events in life.

The formation of students' singing skills depends in many ways on the effective use of Uzbek folk customs and traditions. Because through them, the student, on the one hand, acquires musical-theoretical knowledge, on the other hand, is brought up ideologically. Traditions, customs and values are a key factor in educating students in the national spirit and developing their thinking. The use of holidays, customs, and values in daily life as a means of education allows students to instill a deeper spirit of respect and devotion to national ideas. Most importantly, as students perceive the content of an idea through artistic means, it is possible to explain the essence of the first ideas and views of our ancient ancestors.

By singing, students learn the secrets of art. The use of artistic means is primarily related to the perception, thinking, and worldview of students. In particular, musical works in the form of concise form, deep meaning of life, artistically harmonious, patriotic spirit can quickly attract the attention of students on the themes of peace, development of the homeland, family, parents, friendship, brotherhood. . Through such works, the student learns to observe, compare, and justify events.

The artistic means are rich in educational and didactic possibilities as they cover almost all spheres of spiritual life. Therefore, it is possible to use a wide range of musical genres in the comprehensive education of students. Musical works provide information about the spiritual and cultural relationships in life. Through this, one feels the supremacy of spirituality.

Singing helps students to understand figurative logic and musical language. They also instill in students a love for their homeland and encourage them to cherish its material and spiritual riches. Therefore, it is expedient to make effective use of its educational potential.

The patriotic music created by Uzbek folk composers depicts the attractive nature, ancient lands, rich culture, Uzbek reality of our ancient and sunny Uzbekistan. evokes a sense of nurturing beauty.

Singing has a special value in cultivating in students important features of national character and national spirit. It is important to note that since students do not yet fully understand the many events and relationships in life, they need to choose a repertoire that is interesting, ideologically influential, and theoretically understandable. Otherwise, students will be left in the lurch and tired of studying music.

Ideological education has social, economic and aesthetic significance in human life. The social significance of ideological upbringing is that a person lives in the midst of direct human relations, in constant contact with all ideological influences between people. This complex system of relations between them is called "Life". So, the idea is a guarantee of the existence and continuity of human life. But at the same time, man is the main force behind the change of ideas. He can enrich the spiritual life with his mind and intellect.

The economic significance of ideological upbringing is that since man is a part of society, his economic needs are also met through the material wealth of the country. The basic means of human existence are economic and spiritual. Thus, the economic development of the country is a guarantee of the improvement of spiritual life. Man's use of material wealth, his influence on spiritual wealth, makes ideological education not only a socio-economic, but also an aesthetic necessity. Because when a person enjoys beauty, his heart opens and his creativity develops. Therefore, approaching spirituality on the basis of ancient folk traditions increases its aesthetic value.

Based on the above, the following conclusion can be drawn. Today's demand sets specific tasks for schools in the field of music and aesthetic education:

- students understand the beauty of nature, works of art;
- formation of aesthetic taste and emotion;
- to pass a full understanding of the concept of beauty in life;
- formation of artistic creativity in students;
- Teaching students to bring beauty into their lives, their activities, etc.

It is important to study the psychological basis of music education for its successful implementation. In our lives, music has entered every home. Since the theme of music has its own character and does not cover all aspects of man and reality, it first of all expresses the inner spiritual world of man, his feelings and moods. Unlike art and sculpture, music creates emotions and moods, not perceptions of the world. In music, emotions are not the real feelings of life, they are selected, cleared of random moments, and understood in terms of specific dreams. Music is able to reflect all the colorful glitter of the state of human emotions. It can express the most complex emotions, the most delicate experiences and moods. Music is about time, covering the ups and downs of experiences.

Music, along with the emotional aspects of the inner world of man, can express the spiritual world as a whole, creating his mental and will power, a holistic image. It also has the ability to

express the characteristics of the mental system, to create states of national spirit. In the works of great composers, the uniqueness of the features of the mental system, the state of emotions and the ability to reflect reality, which is characteristic of a nation, is obvious. Folk music plays an important role in the process of reflecting the national spirit in musical instruments.

One of the characteristics of students' emotions is that they are related to a particular situation, that is, the emotional experiences that occur in children occur only under certain conditions. Therefore, the most important condition for the development of their aesthetic sense and musical culture is to create conditions that interest them. As students listen to a piece of music, they become more emotionally aware of the different sounds, means of expression, character, and mood of the music, the genre of the music they hear, and the ability to distinguish between classical, pop, or other music. In other words, their musical tastes take shape. The taste of music, the degree to which extracurricular and extracurricular activities are organized in the formation of the musical worldview, the living conditions of students, the family environment and the family's attitude to music, the attitude of parents and other family members to music. important in the verse. When a person perceives something, one of the senses comes to the fore in relation to what is being perceived. For example, when drawing, the visual organ is the main organ, and when listening to music, the auditory organ is the main organ. Several sensory organs may also be involved in perception. Such perception is an example of mixed perception.

#### **REFERENCES:**

1. T.Ye. Solomonova, History of Uzbek music. -T., 1981.
2. I.Rajabov, On the issue of maqoms. -T., 1963.
3. O.Matyoqubov, Maqomot. -T., 2004
4. History of Uzbek music. Tashkent - Music, 1979.
5. Akbarov I. Dictionary of music. Tashkent - Gulom Publishing House of Literature and Art. 1989.
6. Kadyrov R. Music pedagogy. Tashkent 2012.
7. Sami Aziz ogli, NuriddinAzizov. Elementary theory of music. KarshiNasaf Publishing House, 2005.
8. Sunnatova N. N. Solfeggio teaching methodology. Tashkent, 2004.
9. Sposobin I. V. The form of music. Tashkent, Teacher's Publishing House, 1982.
10. Vakhromeev V.A. Elementary theory of music. Tashkent, Teacher's Publishing House, 1965.
11. Mansurov A. and Karimova D. "Methodical recommendations for music lessons of 5th grade of secondary schools" T. 1997.
12. Omonullayev D., Nurmatov H., Mamirov K. "General secondary education curricula" T.1992.
13. Nurmatov H. and Ibragimov O. "Handbook for music lessons in the sixth grade." T., 1996 y.
14. The system of music education in Uzbekistan.
15. Vocal and choral skills and their application in music lessons.

16. Importance of Uzbek folk songs in music lessons
17. Introduction of local styles of Uzbek folk music in music lessons.
18. Development of vocal choir skills in primary school.
19. Satisfy students' artistic beliefs by listening to music.
20. General principles of music lessons and their application.
21. Period and its methodological direction.
22. Introduction of scientific and pedagogical researches on music education in music lessons.
23. Popular genres of Uzbek folk music.
24. GM Sharipova Methods of teaching music T .., 2008 Text of the lecture
25. RG Kadyrov Singing aloud in primary school. T., 1997 Teacher.
26. A.Zimina The basis of musical education and development young children. M., 2000
27. H. Rakhimov and others. "Uzbekistan is my homeland" 2 books. T., 1998.
28. H. Nurmatov and others. Textbooks "Music" for grades 1-3. T., 2002
29. T.Ye.Solomonova, 0 'History of Uzbek music. -T., 1981.
30. I.Rajabov, On the issue of maqoms. -T., 1963.
31. O.Matyoqubov, Maqomot. -T., 2004
32. History of Uzbek music Tashkent - Music 1979.
33. Akbarov I. Dictionary of music Tashkent. - G. Gulom Publishing House of Literature and Art 1989.
34. Kadyrov R. Music pedagogy. Tashkent 2012.
35. Sami Aziz ogli, Nuriddin Azizov. Elementary theory of music. Karshi Nasaf Publishing House, 2005.
  - a. Fitrat. 0 'Uzbek classical music and its history. - T .: «Fan», 1993.
36. H. Nurmatov, M. Norkhojayev. Textbook "Music Alphabet" for 1st grade. —T .: Publishing House named after G. Gulom, 2007.
37. H. Nurmatov, M. Norkhojayev. "Music" textbook for 2nd grade. —T .: Publishing House named after G. Gulom, 2008.
38. O. Ibrohimov, J. Sadirov. "Music" textbook for 7th grade. —T .: Publishing House named after G. Gulom, 2009.
39. D. Omonullayeva, Sh. Yormatov. "Music" textbook for 8th grade. —T .: Publishing House named after G. Gulom , 1990.
40. T.Y. Solomonova. 0 'History of Uzbek music. -T .: "0' Andy ", 1981.
41. V. Vaxrameyev. "Music Theory". —T .: «Teacher», 1965.
42. H. Nurmatov, O. Ibrohimov. Music Grade 6 Textbook. —'T .: '0' Andy, 1997.

- 43.** Sh. Roziyev. Textbook "Chorus". -T .: Publishing House named after G. Gulom, 1987.
- 44.** L. Ormonova. Textbook "Russian music". - M .: "Music" Publishing House, 2011.
- a. Trigulova. "Foreign musical literature", 2009.
- 45.** O. Ibragimov and others. 7th grade music textbook. —T .: Publishing House named after G. Gulom, 2004.



**ACADEMICIA**  
**An International**  
**Multidisciplinary**  
**Research Journal**  
 (Double Blind Refereed & Peer Reviewed Journal)



**DOI: 10.5958/2249-7137.2021.01289.1**

## CULTIVATION OF RADISH AND TURNIPS

**Kamilov Murodjon Mukumjonovich\***

\*Junior Research Fellow of the Andijan Scientific Experimental Station of the Scientific,  
 Research Institute of Vegetables, Melons and Potatoes,  
 UZBEKISTAN

### ABSTRACT

*The article provides recommendations for the introduction of new modern agrotechnical measures, which are one of the main factors in increasing the gross harvest and productivity of the cultivation of radish and turnip. In the current pandemic, one of the important factors in increasing the immunity of the human body and providing it with various essential vitamins is to pay attention to the medicinal properties of these crops, to fully meet the needs of consumption.*

**KEYWORDS:** *Agricultural Technology, Growing Season, Planting, Feeding, Sowing, Motherhood, Watering, Rooting, Harvest.*

### INTRODUCTION

Decree of the President of the Republic of Uzbekistan dated January 28, 2020 No. PP-4575 "On measures to implement the tasks set in the Strategy of Agricultural Development of the Republic of Uzbekistan for 2020-2030 in 2020" and May 11, 2020 No. PP-4709 "Agricultural products of the Republic" The current task is to provide the population with quality, vitamin-rich vegetable products, based on the tasks set out in the resolutions "On additional measures to specialize in cultivation." Based on these tasks, it is no exaggeration to say that the efficient use of arable land, as well as double and triple cropping is a modern requirement. Growing radishes and turnips as a secondary crop in the early vegetable crops and grain-free areas will not only meet the demand of the population for vegetable products, but also have a positive impact on food security. In the current pandemic, one of the important factors in increasing the immunity of the human body and providing it with various essential vitamins is to pay attention to the medicinal properties of these crops, to fully meet the needs of consumption. The following varieties of radishes and turnips are zoned in Uzbekistan:

Rapid-ripening varieties of radish Andijan-9 and Margilan, fast-ripening varieties of Namangan, Samarkand and Muyassar are included in the state register. Let us briefly consider the classification (characteristics) of these naals.

Andijan-9 variety of radish is fast-ripening. Root fruit round, size 9x9; 10x10cm. The flesh is tender, juicy. The root is located almost in the upper part of the soil, this part is green, the color of the part below the soil is light green or white. Flesh dense, color white root fruit weight 300–310 g. [3] The growth period is 96 days. Yield is 48-50 tons per hectare.

Margilan local variety of radish - fast ripening. The shape of the root fruit is broadly cylindrical, the sides are slightly slender, sometimes blunt size 10x17cm and 8x10cm, the surface is flat, the color of the side of the fruit band is green, the green towards the tip of the fruit alternates with white. The color of the flesh varies from white to green towards the center, dense, juicy, juicy. Root fruit weight 230-236 gr. Productivity is 30-40 tons per hectare.

The Namagan local variety of turnip is fast-ripening. Growth period is 54-60 days. The rhizome is flat-round, juicy, sweet, white, sometimes pale yellow, fleshy, with many lateral roots, completely submerged in the soil. Root fruit weight 138-140 gr. The tasting score is 4.5 points. Yield is 40-42 tons per hectare.

The Samarkand local variety of turnip is fast-ripening. Growth period is 53-55 days. The leaves are trimmed, hard, dark green. The rhizome is flat-round, the skin is raspberry-pink, pink, the surface is transversely blistered. Root fruit weight 120–130 g. The flesh is white, dense, tasting 4.5 points. Yield is 30-34 tons per hectare.

Muyassar variety of turnip - early ripening. Growth period is 45-60 days. The root is white, juicy, sweet, tasting 3.8 points. [4] The root fruit is edible when it weighs 60-70 g. The leaves are also consumed at a young age. Yield 35-40 tons per hectare.

Radishes and turnips are mainly planted in summer. Seeds will be sown in the central regions on August 1-15, in the northern regions on July 25-August 10 and in the southern regions on August 20-September 20.

Radishes and turnips can be sown in rows and ribbons. In both methods, the distance between the edges is 70 cm. Seeds are sown in SON-2.8 seedlings. When spraying in two rows, the drill bits are set in pairs. [5] The distance between each pair is 20 cm. Okuchniks are attached to the sieve. Each hectare consumes 4-5 kg of radish seeds and 2-3 kg of turnip seeds. Radish seeds are sown at a depth of 2 cm, turnip seeds at a depth of 1.5 cm. Once the seeds have germinated, they need to be transplanted and sown quickly. The first is carried out with the emergence of a single seed from the ground, the second with the emergence of 2–3 leaves. In this case, between the bushes are left 10-12 cm wide.

Radishes and turnips are weeded and fertilized and 400 kg of superphosphate and 150 kg of ammonium nitrate are applied per hectare. Further care includes timely watering of crops, cultivating between rows, loosening the furrow, and pest control. Radishes and turnips are damaged by aphids. It is recommended to spray Detsis at the rate of 0.5 l / ha or Mospilan at the rate of 0.3 g / ha.

## REFERENCES.

1. RA Hakimov, AS Hakimov, AA Tashmuhamedov "Seed production of vegetables and melons". T-2003
2. RAKhakimov, RANizomov, B.J.Azimov, MUKholdarov, FFRasulov "Recommendations on agrotechnology of rich and high-quality production of vegetables, melons and potatoes in Andijan region." T-2017.
3. Xudoyberdiev, T. S., Boltaboev, B. R., Razzakov, B. A., &Kholdarov, M. S. (2020). To the fertilizer knife determination of resistance. Asian Journal of Multidimensional Research (AJMR), 9(8), 65-71. <https://www.indianjournals.com/ijor.aspx?target=ijor:ajmr&volume=9&issue=8&article=011>
4. Khudoyberdiev, T. S., Boltaboev, B. R., &Kholdarov, M. S. Improved Design of Universal-combined Cultivator-fertilizer. International Journal on Orange Technologies, 2(10), 83-85. <https://www.neliti.com/publications/333419/improved-design-of-universal-combined-cultivator-fertilizer>
5. KIZI, K. S. R., & OGLI, M. K. B. The Importance of Esparset or Tall Crowfoot in Livestock and Its Effect on Soil Fertility and Its Cultivation Technology. JournalNX, 6(11), 104-106. <https://www.neliti.com/publications/335642/the-importance-of-esparset-or-tall-crowfoot-in-livestock-and-its-effect-on-soil>
6. Catalog of local varieties of vegetables, melons and potatoes." T-2016.

#### WEBSITES.

1. <https://agroklass.com/vyrashhivanie-redki.html>.
2. <https://rastenievod.com/redka.html>.
3. <https://flo.discus-club.ru/rodyka.html>.
4. <https://fazenda.net.ua/stat-catalog/vyracshivanie-redki-iz-semyan--posadka-uhod-i-sbor-chast-pervaya/>.
5. <https://www.fertilizerdaily.ru/20210302-redka-vyrashhivanie-iz-semyan-na-ogorode/>
6. <https://www.agro.uz/uz/services/useful/7852/>
7. <https://agromart.uz/uz/useful/material/59aa9ff61980b8c67552c1cf>





DOI: **10.5958/2249-7137.2021.01290.8**

## LINGUO-STYLISTIC PECULIARITIES OF FOOTBALL DISCOURSE IN MODERN SPORT PUBLIC ISM

**Egamov Sohiv Amonovich\***

\*Teacher of the Department of English Integrated Course,  
Uzbek State University of World Languages,  
UZBEKISTAN  
Email id: beksohib@gmail.com

### ABSTRACT

*The article describes linguo-stylistic features of football discourse in modern sports. Football is an event of cultural significance and it is not only an integral part of the social, cultural and cognitive direction in the modern world, but also a special linguistic reality. The concept of football as a linguistic-cultural phenomenon of modern reality reflects important features of language. In this article we tried to define the linguistic and stylistic features of football discourse by examining football as a linguistic-cultural concept that is an important element of language.*

**KEYWORDS:** *Discourse, Concept Of Football, Linguistic And Stylistic Features, Consciousness, Language, Football.*

### INTRODUCTION

Today, the concept of discourse is widely used in modern linguistics. The importance of a discursive approach in the study of concepts is very clear. The sports discourse discussed in this research paper represents the scope of the football concept and demonstrates itself as a specific means of implementing it.

The concept theory, based on modern scientific research, forms the basis of work on the concept of sports. This area of sports communication is poorly understood and in practice does not cover speech events specific to different sports. Most researchers have studied the language of the sports sector without distinguishing its individual areas, but our observations suggest that there are unique speech phenomena in different sports. For instance, a series of similar events may include the names of equipment in different sports. The frequently used names of the same

realities do not differ from each other for the listed sports, which allows us to talk about the fact that there is actually a unique perception of the sport.

Research materials show that the concept of football can be derived from the general concept of sport, which can be specific to any other sport depending on the state of a person's lexical consciousness, "the part of the human mind that responds to verbal communication, it is formed and defined.

In this work, text is a unit of discourse. In turn, the discourse is manifested as "a complex communicative unit of language with its own structural and semantic features, such as connection, integrity, completeness, understood as the fragmentation of all reference questions in the text". The level of mass communication enriches the text concept with new or semantic colors, which arise from one or another means of mass communication. Thus, the ratio of discourse and text can be expressed as a certain relationship of learning perspectives.

The concept of football actually represents a basic concept, around which the thematic content of the discourse is gathered.

The approach used in our research work has already been developed by Yu.N. Karaulov's work, its distinctive feature is that speech is expressed in all verbal and nonverbal complexes. As in other areas, sports-related nonverbalism is a major component of discourse, and the discourses that make up sports discourse (journalistic discourse, sports commentator discourse, and athlete discourse) have not been adequately studied.

Dutch linguist T. van Dyke interprets discourse as a system of genres. For example, he believes that political discourse creates a system of genres that interact with a particular social sphere, politics. In this regard, sports discourse forms a particular genre system that is most in demand in the field of sports communication. One of the important indicators of the field of sports today is the development of this sport, the impact and direction of certain sports on the lexical reality of the language.

The sports discourse aims to exert a special influence on the recipient in order to form a clear idea that corresponds to the author's idea of a particular event / person / action in the field of sports communication. However, the idea of a sports text author is to introduce the reader / listener to a particular sports circle (active or passive fans). In carrying out this process, a specific sports team is brought in, using.

In sports discourse, it is important to take into account the interaction of verbal and graphic components, which results in the formation of specific information about the sport.

It is especially important to divide sports discourses into several sub-discourses, specifically football game discourse, sports commentator, and sports journalist speeches. All of the above sports discourses have linguistic-stylistic features. In our opinion, at the level of linguistic expression for the recipient of information, sports journalism is the most convenient for discourses and sports commentators. These types of discourses are an effective means of entering the field of sports, using existing language tools such as general and sports jargon, general and sports phraseology, as well as terminology. It should be noted that it is difficult to say in detail about the fact that lexical means related to sports reach a non-sporting public place. Thus, the frequently used phraseological units that fall within the scope of football discourse lose their original meaning and acquire additional semantic additions.

---

As for the player's speech, according to our observations, this sub-discourse is unique. These types of discourses employ highly specialized football lexical units that are very difficult to understand for people who have nothing to do with football, so they are in many ways understandable to professionals in the field.

Thus, sports discourse is a specific type of discourse, because in its composition it is possible to distinguish the dominant features inherent in this discourse.

The discourse of football is a voluminous and multi-layered formation that combines the verbally expressed part of a text with the specific features of a particular medium. Thus, the texts that make up the football discourse are combined with pictorial and graphic commentary. In football discourse within the interview genre, one or another moment recorded at the speech level of a football game can be described, even with the help of resonant means, with strict football terminology. This largely depends on the type of sport, its purpose, and the specific sports information it is directed at to the recipient.

The fact that sports journalism is the most important component of information communication today explains why this type of work is formed in a rigid system of closely related elements and forms a whole that can be defined as the world of sports.

As mentioned above, an important criterion in the selection of topics and linguistic materials that serve a particular area of description is the recipient's interest in this or that information, covering a particular area of social relations specific to journalism in general. In turn, sports journalism also takes this factor into account. Consideration of the consumption factor is equally important.

Sports journalism has a specific audience, which can be conditionally divided into three groups: professionals in the field, active and passive fans. A preliminary study of the genres and linguistic materials of football discourse suggests that this type of discourse is an active group of fans representing the target audience.

At the same time, universal, specialized, professional sports publications can be highlighted. The first group includes universal sports publications

In the field of sports discourse, "it was and remains the most influential group". This type of sports journalism, as a rule, covers all areas of sports life, so it is not advisable to use the language tools of the sports subculture in these publications. This type of publication is not intended to attract the attention of a wide readership (because such a publication has a very large readership), but rather to provide accurate and timely information about sporting achievements, events, and individuals. An example of this is the newspapers that cover sports life in our country. In describing or commenting on any sporting event, this publication prefers to use general terminology in many ways. Research materials show that foreign language equivalents (mostly English) are more common in football discourse. Except for interviews with athletes, coaches, and others, who often have spontaneous and emotional feelings.

The unique popularity of football and the high level of development of the sport in general determine the choice of topics for universal publications. Universal publications covering all spheres of sports life, first of all, cover sports events in the football life of our country. The target audience for this type of publication is mostly men. Although the concept of a football fan is beyond the gender factor, an analysis of the language tools of football proves the predominance of the muscle principle in football discourse.

---

The second group consists of specialized sports publications that cover a specific area of sports life, which in turn are divided into different sports. Thus, compared to other sports, the most published ones are mainly dedicated to football. These are "Football", "My Football" and others. According to our observations, the readers of such publications are mostly men. In describing sporting events / situations, communication participants mainly use slang sports speech as well as sports and general jargon.

The third group is professional publications aimed at sports professionals. Football coaches and professional players are required to cover these or other topics, where language description tools are mainly focused on sports terminology (general and football). For example, the journal Football Theory and Practice is devoted to the game of football.

The fourth group includes time sports publications that pursue the same goals as blank sports publications in many respects. It combines the application with basic recommendations for action, terminological, basic linguistic-stylistic tools of a jargon nature. Thus, in football discourses, general and football jargons, on the one hand, serve to attract the reader's attention to follow the recommendations, on the other hand, to convey useful information about football to the sport in a clear and understandable language.

The text of sports journalism differs in structure and language level. This general interest is related to the author's approach on the one hand, and functional-stylistic orientation on the other. Due to the popularity of football in general, as well as the complexity of the linguistic and stylistic complex of modern language tools, the role of football in modern journalism plays an important role.

The distinctive speech genres of journalism are constantly evolving and meeting modern needs. An important feature of modern sports journalism is the feature that affects most parts of these texts, which is related to creating a certain attitude of the reader to the information being transmitted.

Most sports discourses are based on information and journalistic genres. In our opinion, the reporting genre is of great importance for the football genre.

This genre is distinguished by the fact that the author is on stage and is the most popular among sports journalists. The potential of the reporting genre allows journalists to fully understand the needs of the sports industry. First, the reportage genre type allows you to dynamically describe events using stylistically colored language tools. Second, the role of the sports journalist / commentator is to present this or that sporting situation / event / specific action in a way that evokes a sense of being in the recipient, so that he or she feels that he or she is a witness to the events described.

As a rule, a sports journalist prepares in advance any football-related facts that engage the reader / listener. Sports journalism requires a high level of attitude to the event / situation that takes place on the football field.

The linguistic-stylistic tool of football within the interview genre contributes to the fulfillment of the above tasks. For example, it incorporates general sports and football jargon into the description of game actions, making a special impression on the receiver and making him his interlocutor.

The use of general sports and football terminology allows the journalist to acquaint the reader with the professional environment in the field of sports. Sports phraseology is a vivid figurative component of a football game and is also a key component of a sports discourse.

According to our observations, sports jargon reveals its stylistic and text-forming features in a specific direction of football, and the reporting genre is the most excellent means of accomplishing these.

Thus, despite the rich spectrum of modern journalistic genres, the most important and effective for sports discourse is the informative reporting that can meet the needs of both the journalist and the recipient of sports information.

Modern sports reporting is often a mixed genre - informational and analytical, combining a description of any issue / problem (e.g., interviews with witnesses, participants in sporting events) and a description of the journalist's active efforts to analyze the problem. An example of this would be the discussion of the problem of losing a physical or other football team that has all the chances (both technical and physical) to win.

In sports journalism, it plays an important role in the interview genre, especially in the group of specialized sports publications. Examples include various interviews with coaches, players, and other prominent sports figures.

As part of sports journalism, the interview genre is multifaceted (e.g., questions about any sporting event, past or future football game to the interviewee), i.e. it can serve as an informative genre. In certain communicative situations, this genre is analytical (e.g., a conversation about the exchange of players between football clubs under certain conditions).

A distinctive feature of the interview genre is the dependence of the language that serves this genre on the social context, that is, the main pragmatic discourse - the acquisition of information about a particular type of recipient (sport).

The variety of styles using linguistic tools, the interconnectedness of the statements of the interlocutors (participants of special dialogues), the focus on information about involvement in the sport, as well as the orientation to the public - all this serves to popularize the genre in modern sports discourse. .

The expressive language of sports communication allows a journalist's speech in general to focus more on sports, especially football, which contributes to a deeper understanding of it. As a result, a language working within sports discourses will be able to go beyond the boundaries of highly specialized use, proving itself as an active and popular component in everyday language.

Within the genre of conversations, the personality of the interlocutors is of particular importance. The high social status of some individuals in sports, the popularity of achievements of individuals in sports (high game potential, achieved sports results, special physical shape, etc.) encourages recipients to accept certain language sports elements in everyday life from their speech to their language. This fact determines the high level of linguistic communication, expanding the scope of activities of language tools in sports.

Thus, it can be concluded that the genre of modern sports, football journalism today is a reporting genre that combines informational and analytical types of text. The genre of interview, which depends on the social context, also plays an important role. Of particular importance is the

type of sport given in the text, where the modern reader can find parts of different genres that do not violate the integrity of the text, but retain a certain independence of its parts.

Thus, within the genres discussed above, it is possible to realize only the specific features inherent in the textual types of sports, which determines the importance of these sports genres in football discourse.

**REFERENCES:**

1. Arutyunova, N.D. Language and the world of man / N.D. Arutyunov. M.: Languages of Russian culture, 1999.
2. Dementyev, VV Genres of new spheres of communication // Modern speech communication: new discursive practices. 2011. 344 p.
3. Krivenko, B. V. Language of mass communication. Lexico-semiotic aspect. - Voronezh, 1993. 136 p.
4. Kroychik, LE The system of journalistic genres // Fundamentals of the creative activity of a journalist. 2000. 410 p.
5. Solganik, G. Ya. About the language of sports journalism // Sports in the mirror of journalism. - M., 2007. - pp. 143–157.
6. Solganik, G. Ya., Language and style of mass media and propaganda: Print, radio, television, documentary films. - M.: Publishing house of Moscow. un-that. - 1980. 256 p.
7. Solganik, G. Ya. Expressive resources of the vocabulary of publicistic speech // Poetics of journalism / ed. G.Ya. Solganika. - Moscow, 1990. P. 10.

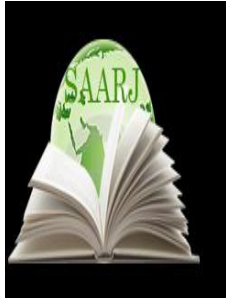

**ACADEMICIA**  
**An International  
 Multidisciplinary  
 Research Journal**  
 (Double Blind Refereed & Peer Reviewed Journal)



**DOI: 10.5958/2249-7137.2021.01291.X**

**PROPERTIES OF THE DEMONSTRATION OF THE ECOLOGICAL  
 OUTLOOK OF A PERSON IN A PERIOD WHEN GLOBAL  
 ENVIRONMENTAL PROBLEMS ARE ESCALATING**

**Kandov Bakhodir Mirzaevich\***

\*Doctor of Philasopha (PhD) on Philosophical Sciences,  
 Tashkent Institute of Irrigation and Agricultural Mechanization Engineers,  
 Tashkent, UZBEKISTAN  
 Email id: b.kandov@tiame.uz

**ABSTRACT**

*This article explores the trend of globalization of environmental relations, requiring radical qualitative changes not only in lifestyle, worldview, environmental knowledge, legal culture, but also in the worldview of people in a particular country or region. In addition, the time to resolve these problems is very short. At the same time, the global human impact on the environment is very strong. To solve the problem, which is extremely important all over the world, people with high intelligence, intellectual potential and huge economic resources, technical and technological base are required.*

**KEYWORDS:** *Globalization, Environmental Knowledge, Legal Culture, Ecological Worldview, Phenomenon, Ecological Thinking, National Values, Universal Values, Environmental Values, Central Asia, Globalization Of Environmental Problems.*

**INTRODUCTION**

Today, the criteria that determine the ecological conditions of the world and the mutual co-operation of transformation processes, determine the characters and contents of global problems. Humanity is living on the brink of global problems. "Today we live at the historical stage of the development of mankind, in which Dramatical changes are taking place.

In the following years, there have been drastic geopolitical changes on earth, the international system of security and stability is being disrupted. The ever-growing globalization era is not only expanding the opportunities of mankind, but also leading to the escalation of conflicts, an increase in the discrepancy between developed and undeveloped countries. As a result, Various

actions, which undermine peace and stability and are transnational in essence and scope, are being committed"[1], said Shavkat Mirziyoyev, President of the Republic of Uzbekistan.

In the aspect of ecology, as in other areas, The process of globalization led to a different explanation of the role and significance of the phenomenon of environmental outlook in the system of values that were formed in the minds of people, their groups, social communities, and society as a whole. The role of ecological values in the individual outlook associated with the protection of nature, rational use of its resources, and the assignment of integration into the minds of the younger generation, are actual problems.

### **METHODS AND LEVEL OF STUDY**

Recently, it is noticed that there are two approaches that differ from each other in the research of national and international values. In the first, the existence of national and international values are confessed and they complement and develop each other. In the second – on the other hand, there are only national values, there are no international values, they are concretized in the context of ecological values through the evidence they bring to prove alternative ideas which the abstract generalization of human consciousness, the product of abstract thinking, the diversity of national values.

When denying the existence of universal ecological values: Firstly, all people and communities have been living in accordance with their specific, diverse and conflicting interests, goals and beliefs; Secondly, any form of outlook, like its type and form, cannot have a single solution that satisfies everyone in the matter of ecological value; Thirdly, the solution of ecological problems is largely due to the significant and differently concrete historical conditions of the period; Fourthly, ecological values have always been locally in a particular social space and historical time; fifthly, it is an artificial construction designed to divert public opinion from a particular point of view and It aims at submitting national and environmental interests of various social units to the common goals; Sixthly, the recognition of the dominance of environmental "elitist" values in the universal values causes a rejection of the progressive national environmental values. Seventhly, in any society, different social units, cultures and civilizations cannot live in isolation, but they try to justify but they try to justify the need to reconcile them on the principle of tolerance caused to emerge the concept of universal values.

Defenders of this view think that the abstract "universal values" dominated by nationalism are fabrications invented by the United States and their allies. (This is evident in the skeptical approach to global climate change).

Because they are carrying out military, economic invasion and ecological aggression aimed at the exploitation and ecological exploitation of people, who seek to develop their ideas, under the guise of protecting "universal values" (such as mental freedom, democracy, human rights, etc).

In other words, the "universal value" is true euphemisms invented by the Western world to integrate economic globalism, "popular culture", multiculturalism and other demerits into the minds and lifestyles of the peoples of the world to accomplish their goals and protect their interests.

There are the following basics for recognizing the existence of universal ecological values, namely:



- a) Natural and social events that serve to meet the environmental, material and spiritual needs of human beings and to preserve the world's civilization;
- b) The moral and spiritual content of ecological universal values is an objective phenomenon in the genesis of origin, even if it is a subjective factor in the stable development of society;
- c) The universal ecological values are the result of the synthesis and integration of material and spiritual cultural directions at the national, regional and global levels of environmental protection;
- d) They operate within the global ecological outlook that serves the survival and activity of humankind, regardless of their presence in any historical period or socio-ecological space;
- d) Their status is strengthened by justification of humanistic and democratic principles and choosing the natural evolutionary way to integrate nationalism with humanity.

In general, according to the established historical tradition, it is methodologically correct to divide ecological human values into material and spiritual directions. The first of them includes all types and areas of practical activity: production of material wealth, economic relations, methods, technologies, results of experiments of changing the social life of the community and so on.

Spiritual areas include: knowledge and emotional, psychological and ethical aspects of assessment.

In the process of ecological thinking, the scientific representations that are the result of knowledge of ecological reality are processed, analyzed, compared, regulated, systematized, and summarized. This, in turn, provides the basis for the adoption of certain decisions and tasks.

It is worth confessing that: "today people do not have enough ecological knowledge and some even don't have it. Most people are aware of environmental problems and some people think that they need to make urgent decisions and they need to take a decisive step towards protecting the environment, while others don't consider as that[2].

In this context, it should be classified as the process of identifying the purpose, motives, mechanisms of the formation and development of new knowledge on the basis of processing, analyzing, accumulating, summarizing the ecological theoretical knowledge, results of practice in the process of knowledge of the ecological thinking of a particular ethnicity[3].

Ecological feelings are caused by the scientific knowledge of the ecological reality and are a major factor in the formation of the ecological outlook of the individual. His emotional perception of the eco-consciousness empirically reflects some aspect of objects and predmetns and cognition is his holistic ideal image. In the process of restoring the ecological image and emotional image of the ecological reality, the person becomes the main subjective factor of the ecological outlook and goes to logical-abstract level of ecological consciousness and serves as its source of information.

However, the complexity of forming an individual's environmental outlook, the limited use of existing environmental knowledge in the social practice of the individual, and the limited ability to provide theoretical and practical information to all individuals, prevents from making the right

decisions to solve environmental problems. In this issue, the importance of the ecological worldview is revealed.

It is necessary to look for ways and opportunities for enriching the ecological outlook in each person to overcome the sentiments of technocratic, utilitarian, mercantile approaches that still remain in the human psychology.

When Assessment Aspects in the Transformation of National Ecological Values to Universal Values and its Status, answers is searched the following questions "true or false?", "necessity or accident?", "useful or harmful?" "good or bad" "goodness and evil".

Certainly, only the well-known features of national environmental values can serve as a basis for assessing their role in the global ecological outlook. The objectivity and reality of any assessment depend on, first of all, depth and level of knowledge of the environmental situation and phenomena being evaluated; secondly, the status of the national environmental outlook as a part of universal ecological values; Thirdly, compliance of global environmental problems with human interests.

It is well-known that the realization of human living, political, economic and cultural rights depend on the level of development of the ecological outlook of the individual. Man changes and assimilates nature to satisfy his material and spiritual needs and create himself the necessary tools, wealth and comfort from the blessings of nature.

### **RESEARCH RESULTS**

However, these processes of change and assimilation are not based on the ecological scientific outlook and it creates environmental problems of global importance due to its spontaneous and extensive implementation and is recognized by the international community as a threat to human life. One of the leading Russian globalist scientists I. N. Fedoseev justify this, "in all complexity of global problems, the ecological problem is one of the most important problems at present"[4]. Indeed, according to the UN, environmental protection is the second largest global concern after the nuclear war.

Most importantly, the system of global problems nowadays is interconnected in the field of ecology, which is a global problem, not only within a specific nation and country, but it is also international problem. In particular, as a result of the opposite effect of anthropogenic impact on the environment, new natural disasters (eg, global warming), threats to human health (for example, new diseases), deviant behavior in lifestyle and other negative impacts on life.

Based on the developing trends and forecasts of these events, the following logical conclusions are drawn: the first is the escalation of national, local, regional and environmental problems, which become globalization opportunities; the second is the integration of national and international ecological values, an important subjective factor in preventing their globalization; third a - geographical parameters of the use of ecological values are conditional and relative and have direct or indirect meaning for the whole humanity; Fourth - integration of national and universal ecological values corresponds to global goals and interests and it does not exclude their individuality; the fifth - nature protection, which is the basis for human life, has a certain meaning in human social activity and becomes a product of human activity[5].

Because of the emergence of global problems, humanity's goals, in particular the environmental outlook, are being adequately matched. Indeed, the problem of globalization, are taken into account, on the one hand, their identification (adaptation to a particular environmental situation), and on the other hand, their differentiation (adaptation to a particular situation) of the human community's global environmental values.

This puts the issue of rational use of natural resources at the center of outlook. Because, if the use of these natural resources continues at this rate, it was calculated that oil reserves will be exhausted in the next 40-50 years. In order to change the current situation, it is necessary to change the national, regional and global ecological outlook of humanity. In other words, the introduction of energy saving technologies should be considered as a feature of the environmental outlook[6].

It should be noted that the disturbance of the harmony in the “nature-society-human” relationship as a result of the human antiecolological negative effects on the environment is also reflected in the environmental outlook. Therefore, at the present stage of human historical development, the issue of overcoming the contradictions in nature, society, and human relations, move the next the alternative environmental outlook.

Man, as a part of nature has caused global environmental problems as a result of anthropogenic influence on it. These problems, inevitably, should be the basis for the elimination of both the causes and effects of the negative changes in the ecological balance of the biosphere by changing its ecological outlook. Because the subjective nature of this basis is characterized by the stimulation of objective factors that influence the state of the natural environment. Determining the directions and criteria for this impact on the state of the natural environment should also be considered as a functional feature of the environmental outlook.

In addition, the definition of factors that have a positive and negative impact on the natural environment is identified respectively according to a particular environmental outlook. The social environment created on the basis of ecological criteria has a universal character and it is also a moral and spiritual factor that contributes to the overall well-being and sustainability of universal environmental security, with a positive impact on each member of society. As Philosoph-scientist Salomova H.Y. said, “Natural-ecological criteria mean firstly, natural laws, secondly, legal relations between environmental components, stability or volatility relationships, environmental regulations. Thirdly, it represents the natural quality characteristics of each environmental component and factor, the limits of adaptation, variability, and resilience”[7]. Factors that adversely affect the ecological conditions cause the atmosphere to emerge deterioration of human morale and the emergence of various diseases in the body. They have a negative impact on the physical and mental health of the person.

It should be noted that the diversity of some experts' views on environmental knowledge and outlook makes it difficult to reach a general decision.

In particular, their definitions have not still been formed general, unified position, even contradictory opinions are being given. This interfere the international and national environmental outlook being understood scientifically. For example, N. M. Noralieva's definition about environmental knowledge reveals such ambiguity.

In the N.M. Noralieva's opinion, the connection between theoretical and empirical levels was not considered: "Environmental knowledge is the information that people have created about protecting the natural environment, the rational use of natural resources, and the restoration of disturbed natural complexes, that is, the extent to which this reality is reflected in human thinking"[8].

In addition, the information provided in this definition is not related to "knowledge about the restoration of degraded natural complexes" but "degraded nature complexes". However, not all information can be knowledge. Only information which was put into practise can be a cause to emerge knowledge in particular areas.

A. Nigmatov relied on abstract concepts to explain the commonality of consciousness, knowledge and outlook in the structure of environmental culture ignoring the dialectical link between nationalism and humanity in the nature of the ecological outlook. Therefore, objective conditions that ensure the commonality of the goals of nationalism and humanity, a set of subjective factors were ignored in the definition of "environmental outlook and culture is the solution to environmental problems for present and future generations, realizing that it is a huge responsibility and acting on this basis is an advanced stage and component of a particular state and world culture"[9].

In addition, although it is well known that the conclusion that "a specific stage of development of a particular national and international culture" is a globalization of environmental relations around the world, the author did not include this in the context of a scientific description. Based on above-mentioned analyzes, it is necessary to lay the theoretical and conceptual foundations of the development of the ecological outlook on the strongly scientific basis.

Individual and social factors - based on systematization of theoretical and scientific-methodological approaches improving the ecological outlook of the individual can be combined and enriching the environmental outlook of people. Therefore, the increasing globalization of the world, and the growing environmental situation in Central Asia, makes it a matter of approach based on deep philosophical thinking.

It is not a secret that at present the emergence and exacerbation of global problems in the world happened causing, in essence, a "poverty of the ecological outlook". In particular, "The main cause of the environmental crisis is that the natural systems of metabolism and energy are violated in the ecological system. To put it in simpler terms, it can also be described as a violation of the chain of nature by man"[10].

For this reason, the problems of natural, economic, socio-political, ideological, and human health are threatening the lives of many peoples, nations and regions as a catastrophe. Hundreds of thousands of people die each year as a result of these antropotechnogen disasters[11].

Unfortunately, despite the fact that man has a high intelligence and the formation of noosphere, he has played a key role in creating such a crisis in global ecological conditions. The change in the system of nature-society can be followed by two laws: 1. The antropotechnogenic impressive pressure of society on the environment is increasing. 2. The tendency of the society's dependence on the natural environment is increasing. In this case, the first law creates the second law[12].

Therefore, the Millennium Summit, which was held by the UN in 2000 with 189 heads of state, identified the most important problems we are facing at the beginning of the 21st century, four of which, are related to directly ecological problems. These are: 1) reducing child decease; 2) improving maternal health; 3) The fight against AIDS and other eminently dangerous diseases; 4) the importance of environmental sustainability is crucial to the future of the world's population[13].

At the same time, the ecosystems of each part of the world are inextricably intertwined. As the First President of Uzbekistan Islam Karimov said: "The problem of ecology is relevant in all parts of the world, but its severity varies across countries and regions. One can clearly state that the Central Asian region has one of the most dangerous zones of ecological disaster. The complexity of the situation is that it has been caused not only by the neglect of this problem for decades, but also by the fact that virtually all areas of human activity in the region are exposed to environmental hazards. It is inadmissible to treat the nature rudely and arrogantly. We have a distressfull experience in this regard. The nature will not forgive this attitude. The pseudo-socialist ideologically false claim that "man is the lord of nature" became a tragedy for the lives of many people, nations and peoples, especially in the Central Asian region. Their extinction led to threat to be the destruction of the gene pool"[14].

In general, as a result of poverty, helplessness and lack of environmental outlook, extensive economic activities on our planet have turned 7% of the land into desert, the energy output of producing has declined day by day, and energy consumption spended on producing has increased fourfold in 10 years. For example, in the most developed country of the world, the United States consumes 0.5 liters of fuel to produce one liter of milk[6].

This is not only the result of human mismanagement of technological processes of changing and assimilating nature, but also due to the ignorantly environmental awareness. Their different manifestations at the national level indicate an uneven, discrete and fragmented development of the environmental outlook.

The philosopher V. Alimasov explained that the ecological situation is aggravating not only in a particular region, but also in the world. "Today, mankind is facing more than 13,000 global crises. If the world community didn't spend ten years to solve these crises, it would take one hundred and thirty thousand years to get rid of them. However, It has not been more than 6,000 years since humanity entered the civilization"[15].

These data also indicate the level of development of today's ecological outlook. As a result, the environmental situation not only affects the health of people, but also changes their gene pool. At the same time, the President recalled former UN Secretary-General Ban Ki-moon's words about the Aral Sea tragedy. The Secretary-General burst into tears seeing such situation.

"I have seen so many places in the world that have been destroyed", he said. - But this is the first time I've ever seen such a severe environmental situation. I admire the patience of the people who work in the face of such a harsh situation[16].

From the bottom of the Aral Sea, over 11 billion tons of sodium, magnesium, calcium and other compounds that pose a serious threat to the life of other living organisms are risen by the wind and spread to distant regions[17]. As the President of the Republic of Uzbekistan Shavkat Mirziyoyev said in his application to the Oliy Majlis, "Currently, the Aral Sea desert has arisen

on more than 5.5 million hectares due to the Aral Sea disaster. Every year, 100 million tons of sand and salt are taken into the air. This again proves that the Aral Sea disaster is a global problem"[18].

Today Investments in the social sector are an important direction for the country to build a strong economic foundation for a society with an environmentally strong, promising and high intellectual potential. As such, civil society and its institutions support activities to raise awareness and culture for the protection of the natural environment.

An effective solution of these problems is closely connected with the formation of a rich ecological outlook for each individual, development of active participation and responsibility of the population, legal knowledge and culture in this area. If these problems are resolved in practical way, it will allow to determine the level and quality of life of the present and future generations.

It is also connected with the formation of global consciousness, which is the basis for maintaining the ecological balance of the planetary biosphere. The most important feature of the global consciousness is the preservation of the priority of international values along with national and regional interests[19]. At the same time, it is necessary to continuously enrich the ecological knowledge, outlook and culture of the people living in each region, both in the global and regional context. Unfortunately, the measures being taken in this regard did not work well enough.

The tendency of globalization of ecological processes require coordination of environmental activities. While doing this, spiritual life of the individual and nation, way of life, role in family environment are learned, Expansion and deepening of international environmental policy globalization takes a different approach to the national development features of each country and region.

## CONCLUSION

In summary, the tendency of globalization of ecological relations demands radical changes not only in the lifestyle, outlook, environmental awareness, legal culture, but also in the world-wide vision of the population of a particular country or region.

It should be noted that the time for solving the above problems is very short. At the same time, the global antropotechnogen impact on the environment is continuing fastly. It requires people with high intelligence to solve the problem and at the same time, importantly great in the whole world, and intellectual potential and huge economic resources, technical and technological basis.

The integration of national and international ecological outlooks, on the one hand, will lead to their globalization, and on the other hand, their development in the process will be dialectical. In the process of globalization and exacerbation of ecological problems, national and international ecological values are identified and differentiated and their impressive directions are concretized by history.

While ensuring the harmony of the natural and social environment, which is the object of ecological national and international values, It is important to create the general and theoretical basis and reach perfection of the international criteria.

---

**REFERENCES**

1. Mirziyoyev Sh.M. We will continue with the path of national development to a new level. T.1. - Tashkent: Uzbekistan, 2017. 33-p.
2. Ashrapov M. Ecological worldview. // "Environmental announcement of Uzbekistan". 2005, №3, (54), 29-p.
3. Khudonazarov S.Kh. The role of fiction in the formation of environmental consciousness and personality culture. Candidate of Philosophy - Tashkent: 2010, 68-p.
4. Fedoseev I.N. Man and nature in the conditions of the scientific and technological revolution (social aspect of environmental problems). Moscow: Science, 1982. P. 9.
5. Ochilova B. Use of nature as a purpose of human activity // Philosophy and law. №4, 2007. 60- p.
6. Mustafaev S., Urakov S., Suvonov R. General ecology. Publisher of the Literary Fund of the Writers' Union of Uzbekistan. – Tashkent: 2006, 10-11-pages.
7. Salomova H.Yu. Basics of social ecology. - Tashkent: Science and Technology, 2004, 47-48- pages.
8. Noraliyeva N.M. The essence of the formation of environmental knowledge and cultural qualities in the process of continuous learning. The national idea is the basis of perfection of the person with high spirituality. National idea is theoretical-methodological basis of scientific research. The third book. - Andijan: 2010, 151-p.
9. Nigmatov A. Ecology: An annotated dictionary of key terms and expressions. - Tashkent: Teacher, 2002/ 15-16- pages.
10. Kuronov U. World Environmental Movement and Uzbekistan. // Thinking. 2011 №1. 113-114- p.
11. Yunusov K. Involvement of NGOs in the Development of Environmental Culture. The national idea is the basis of perfection of the person with high spirituality. National idea is theoretical-methodological basis of scientific research. The third book. - Andijan: 2010, 155-p.
12. Ismailova D. Problems of optimization of interaction between nature and society. // Environmental notice. 2014. №4.(156). 10- p.
13. Millennium Development Goals Report. – Tashkent: Uzbekistan. 2006. 37- P.
14. Karimov I. For security and sustainable development. 6. T., - Tashkent: Uzbekistan,1998 111-p.
15. Alimasov V. Confucianism and Eastern statehood. – Tashkent: 2006, 17-p.
16. Mirziyoyev Sh. We build our great future with our brave and noble people. – Tashkent: Uzbekistan, 2017. 212- p.
17. Abduvoitov J. Environmental notice. // 2016. №9 (185), 9- p.

- 
18. Address of the President of the Republic of Uzbekistan Sh. Mirziyoyev to the Oliy Majlis. Popular word. December 29, 2018.
  19. Kandov B.M., Kalkanov E.T., Alimuhammedova N.Ya. Social and Philosophical Aspects of Globalization. International Journal of Recent Technology and Engineering (IJRTE) ISSN: 2277-3878, Volume-8 Issue-3, September 2019. – P. 4523-4525.



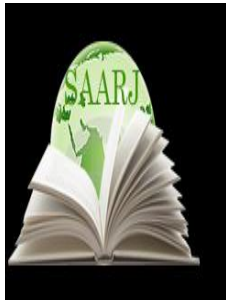

**ACADEMICIA**  
**An International**  
**Multidisciplinary**  
**Research Journal**  
 (Double Blind Refereed & Peer Reviewed Journal)

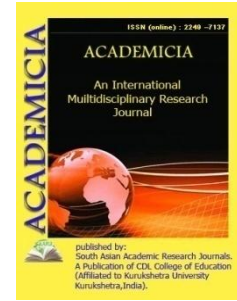

**DOI: 10.5958/2249-7137.2021.01292.1**

## WHAT IS MOTIVATION AND ITS PECULIARITIES IN LEARNING A FOREIGN LANGUAGE

**Rahimova Charos Odiljonovna\***

\*Student of UzSWLU,  
UZBEKISTAN

### ABSTRACT

*It is well known that learning motivation is a specific type of motivation that is incorporated into a particular activity - in this case the learning activity. Like any other type, learning motivation is determined by a number of factors specific to the activity included in it. Learning motivation, like any other type, is systemic and characterized by focus, sustainability, and dynamism. In this regard, it is necessary to highlight the signs of motivation. Here we have given a general idea of motivation and its specific features in the study of a foreign language.*

**KEYWORDS:** *Learning Motivation, Learning Activities, Foreign Language, Structure, Stability, Dynamism.*

### INTRODUCTION

Motivation is one of the main problems in Russian pedagogy. Its importance for the development of modern pedagogy is related to the analysis of the sources of human activity, the motivating forces of his activity, behavior. What motivates him to act, what is his purpose, what is the answer to the question of what he must do to make it happen, is the basis for interpreting it adequately. "When people communicate with each other ... then, first of all, the question arises as to the motives, the reasons that motivate them to have such contact with other people, as well as the goals they set before them with greater or lesser awareness. " In general, a motive is something that identifies, motivates, and motivates a person to any action that is included in an activity that is defined by that motive.

Thus, we can give a specific definition of motivation. Motivation is a complex, multi-level process of psychologically heterogeneous motivators, including needs, motives, interests, ideals, aspirations, views, feelings, norms, values, etc., that determine a person's behavior and activities. heterogeneous system, their structure.

O.S. According to Grebenyuk, the signs of motivation are its educational selectivity, reflects what attracts the learner to the learning activity and the dynamic characteristics of motivation. These characteristics of motivation are intensity (motivation of motives, level of overcoming difficulties, etc.), stability (level of desire to learn) and effectiveness of motives (implementation of the necessary motive in a given situation, making the right decision) ability to do). Characters that can judge the level of development of motivation.

Thus, learning motivation is a special type of motivation, characterized by a complex structure, one of its forms is the structure of internal (for process and result) and external (reward, avoidance) motivation. The features we have identified allow us to rationally assess the state of motivation, set goals for its improvement, measure changes in the development of motivation in the pedagogical process.

It should also be noted that the movement of external motivations of education by parents, teachers, class, society often responds to an individual's internal resistance. That is why the inner motivation of the student is a decisive factor in motivating learning.

Important aspects of motivation include its functions. First, it encourages behavior; secondly, it governs and regulates it, and thirdly, it gives it personal meaning and significance. Thus, the motivational functions are:

1. Incentives;
2. Manual;
3. Emotion formation;
4. Improving teaching effectiveness.

All of the above discusses the complexity of educational motivation as a psychological phenomenon. Moreover, the essence of learning motivation lies in the content of goals, needs, and motives, and in the nature of the connections and relationships between them. Motivation, which is understood as the source of activity and at the same time as a system of incentives for any activity, is studied in different ways, so this concept is interpreted differently by the authors. Researchers define motivation as a specific motive, as a unique system of motives, and as a specific field that includes needs, motives, goals, and interests in their complex interactions and interactions. The most complete is the definition proposed by one of the leading researchers of this problem - LI Bozhovich. According to LI Bozhovich, the objects, representations, ideas, feelings and experiences of the external world, in a word, everything that is needed can act as a motive. Such a definition of motive removes many of the contradictions in its interpretation, where energetic, dynamic, and meaningful aspects are combined. At the same time, we see that the concept of "motive" is already a concept of "motivation", which "works as a complex mechanism of correlation of external and internal factors of behavior by the individual, the emergence of specific forms of activity, determines the direction and methods of implementation".

The above facts prove the relevance of our study. Therefore, as M.A. Aryan points out, understanding the need to optimize the teaching of foreign languages leads to the idea that it is important to choose the best combination of teaching methods and techniques and apply them in the most effective situations.

Many studies are devoted to the problem of motivation formation (VG Aseev, Yu.K. Babansky, LIBozhovich, SM Bondarenko VK Vilyunas, LSVygotsky, IA Dzhidaryan, BI Dodonov, IA Zimnyaya, AN Leontiev, AA Leontiev, AK Markova, A. Maslow, SI Rubinstein, D B. Elkonin, PM Jacobson, etc.), emphasizes the role of positive motivation, which is one of the most important conditions for achieving good learning outcomes. However, it should be noted that there is little research on the problem of increasing motivation to study FL under the influence of the media.

Recently, for many students, the only motive for learning a foreign language was to get a good grade. But today, knowing a foreign language is becoming one of the mandatory components of professional activity and makes leisure time more complete and interesting. Therefore, more attention is paid to language learning. Managing the motivation to learn FL is one of the central challenges of teaching methodology. As an IL object, it has a number of unique features, one of which is the mastery of IL by teaching the ability to communicate in IL. Unfortunately, learning in FL is now largely artificial and educational in nature, due to the fact that there is no “natural need” for students to communicate in FL. In this regard, the teacher has the task of creating an environment for foreign language speech communication in the process of language teaching, as close as possible to the natural conditions.

There are several types of external motivation and internal motivation. External motivation, as a rule, directs the student to achieve the end result of a long, long study. The main type of internal motivation is communicative motivation. Students, regardless of age, formulate their needs unanimously as a clear communicative, i.e.: talking to a friend, an adult, reading to expand their worldview, with a professional purpose and pleasure, and a letter write. However, despite such a clear desire of students to communicate, it is most difficult to maintain this motivation. The fact is that FL emerges as an artificial means of communication in the assimilation of the mother tongue atmosphere. Hence, the natural conditions used in teaching are essentially artificial. According to GV Rogova, interest in the process of learning a foreign language depends on internal motives arising from the activities of a foreign language.

Scholars studying the motives for mastering FL have identified a number of types of motivation that take into account the individual development of students.

1. External motivation, as a rule, is aimed at achieving the final result of students' learning;
2. Internal motivation has a strong motivating effect on the learning process. And for that, the teacher needs to build the learning process in such a way that at each stage, the students feel that they are moving towards the goal.

Analyzing the existing approaches to the concept of the essence of motivation, we came to the following conclusions:

1. Motivation is one of the main tools of personality development, a regulatory and a prerequisite for successful learning.
2. Important aspects of motivation include its functions:
  - ❖ incentives;
  - ❖ manual;

- ❖ semantic;
  - ❖ stimulation of thought processes;
  - ❖ improving teaching efficiency.
3. The essence of learning motivation lies in the content of goals, needs and motives, the nature of the connections and relationships between them.
  4. There is cognitive motivation and communicative motivation in the study of FL. Communicative motivation plays a leading role in foreign language teaching.
  5. We identified the following types of motivation:
    - a) external motivation;
    - b) internal motivation.
  6. The main features of motivation are its orientation, stability, dynamism.

The theory of the combined effects of the effects of mass communications. According to this theory, people in modern society perceive media messages in the same way, i.e.. they have very similar reactions. In practice, this effect occurs under certain conditions and in relation to a specific audience. The aggressiveness of the audience (person) may increase when watching some programs.

Theory of Social Education (Albert Bandura and his colleagues). This approach has emerged in the gut of behavioral psychology. It is based on the claim that mastering a model of human behavior is imitated by the behavior of others. Depending on how they behave in a particular situation, a person imitates them and assimilates their own experiences. In this context, the media provides examples and becomes a source of learning. For a person to receive social education, the following is necessary:

1. the presence of an example;
2. memorize patterns of behavior;
3. understand actions;
4. motivation;
5. Implement a behavioral model.

Cultivation theory (gradual formation of a way of thinking) (George Gerbner and colleagues). The proliferation and repetition of the media (primarily television) over a long period of time will help their consumers to gradually change their perceptions of events, processes, and social reality. Such an effect on the audience helps to form (shape) certain positions, views in accordance with the information created on the TV screen.

Theory of socialization - (theory of social development). Through the long-term impact of the media on consumers, they become a source of knowledge about the world. Modern children often spend 2 to 4 hours watching TV, which makes it an important element of social development. With the help of television, they learn about the adult world, their behavior, and begin to play adult-specific social roles. Children and young viewers are helped to make the greatest impact on the TV audience by using methods that focus on their psychology (elements

of entertainment, competition, novelty, excitement, etc.). It is no coincidence that the positive and negative role of the media is more perceptible to children.

In summary, the study of a large number of literature on the problems of motivation formation, as well as diagnosing the level of motivation formation of students suggests that in modern conditions it is possible to teach a foreign language using the media and thus increase motivation to learn a foreign language allows us to conclude. proper use of the media to present you the process of language acquisition as an understanding of the culture of a living foreign language, individualize the learning process, acquaint adolescents with the cultural values of native speakers and, consequently, the skills of speech activity and allows him to develop his motivation. The complex solution of practical, educational, upbringing and developmental education problems is possible not only by influencing the minds of students, but also by penetrating their emotional realm. This helps to activate students' interest, increase their English rating compared to other subjects and, most importantly, increase students' language skills.

#### LIST OF USED LITERATURE

1. Ariyan, MA Taking into account the characteristics of the teacher's personality in optimizing the learning process [Text] / MA Ariyan // IYaSh. - 1988. - № 3. - P. 19 - 23.
2. Bozhovich, L. I. The problem of the development of the motivational sphere of the child: the study of the motivation of the behavior of children and adolescents [Text] / L. I. Bozhovich. - M.: Education, 1982. - 180s
3. Vereshchagina, IN Methods of teaching English in primary school [Text] / NI Vereshchagina, GV Rogova. - M.: Education, 1988. - 224 p.
4. Djidaryan, I. A. On the role of needs, feelings, and emotions in a person's motivation. Theoretical problems of personality psychology [Text] / I. A. Djidaryan. - M.: Education, 1984. - 211p.
5. Leont'ev, A. A. General methods of teaching foreign languages: the reader [Text] / A. A. Leontiev. - M.: Rus tili, 1991. - 360s.
6. Ksenzova, G. Yu. Perspective school technologies [Text] / G. Yu. Ksenzova. - M.: Akademiya, 2000. - 265p.
7. LV Mardakhaev Social pedagogy: textbook. - M.: Gardariki, 2005 - 269p.
8. Jacobson, P. M. Communication with people as a social and psychological problem [Text] / P. M. Jacobson. - M.: Education, 1983. - 142p.

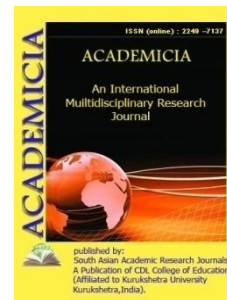
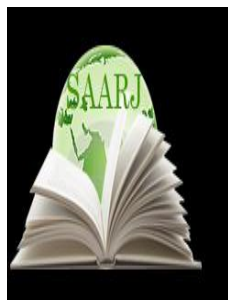

DOI: **10.5958/2249-7137.2021.01293.3**

## **PATHOMORPHOLOGICAL CHANGES IN POULTRY PODODERMATITIS IN COWS**

**Batiyor Zokirovich Mukhtorov\***; **Nasriddin Bobokulovich Dilmurodov\*\***

<sup>1,2</sup>Samarkand Institute of Veterinary Medicine,  
UZBEKISTAN

### **ABSTRACT**

*The pathomorphological changes in the hoof were studied in case of purulent pododermatitis in productive cows. It was revealed that with pododermatitis in the pathological focus of the hoof, the blood vessels in a state of acute hyperemia, the development of emigration of erythrocytes and leukocytes, around the vessels - blood plasma, numerous leukocytes and single erythrocytes in the exudate, destroyed tissues, disordered arrangement of reticular cells and threads atrophied tissues.*

**KEYWORDS:** *Purulent Pododermatitis, Productive Cows, Pathomorphological, Erythrocyte, Leukocyte, Pathological Focus, Hyperemia, Exudate, Reticular Cell, Connective Tissue, Necrosis, Dystrophic, Granulation.*

### **INTRODUCTION**

Timely diagnosis of purulent-necrotic pathologies of the distal limbs, common in productive cows, the pathogenesis of the disease, the identification of pathomorphological changes in the hooves in the development of effective methods of treatment.

Surgical diseases of the legs were studied in dairy cows [4, 8, 9, 10], and surgical diseases in high-yielding cows accounted for 84% of the total number of diseases. In most cases, bursitis, especially bursitis of the tarsal joint, is noted. Blood serum biochemical tests showed an increase in total protein, globulins, urea, cholesterol and phosphorus.

Scientific studies have been conducted to determine the effect of motor activity on the quality of cow hooves, [6] and high physical activity reduces the thickening of tubes and long-term erosion. In cows with Rustergolz's ulcer, a decrease in motor activity was observed by an average of 36% as a result of the decomposition of the hoof substance, and in pododermatitis by an average decrease in motor activity by 56%.

The inclusion of natural sorbent diatomaceous earth in the treatment of cows with lesions in the distal part of the legs has led to the restoration of clinical indications in animals. When using this experimental scheme of treatment, the duration of treatment was reduced by 2-3 days [1, 7].

Scientific research has been conducted on the diagnosis of diseases of the legs of cattle with farm conditions [2], precarpal bursitis in 10 cows, whey-fibrinous fibrinosis of the calf joint in 14 cows. According to the authors, acute aseptic subcutaneous bursitis is characterized by swelling, pain and fluctuations, passive movement, numbness, elastic edema in chronic serum-fibrinous bursitis, crepitation in perforation, bursolitis and fibrin in the bursa wall, fibrin in the bursa wall. Purulent bursitis has been found to be primary or secondary as a result of metastases and infection of surrounding tissues.

The etiological structure of pathogens in purulent-necrotic lesions of the distal part of the skin of the horns of cattle has been studied [3, 5], and studies have shown that the distal part of the legs of cows is purulent (67%), purulent-necrotic (P8%). (49.3%), *Staphylococcus epidermitis* (42.7%), *Proteus vulgaris* (38.4%), *Streptococcus pyogenes* (27.8%) were identified.

Object and methods of research. Scientific research on the etiology of purulent pododermatitis in productive cows, pathomorphological changes in the hooves.

Results obtained and their analysis. As a result of the development of hoof diseases in productive cows, they have their own pathomorphological changes. In particular, as a result of changes in the shape of the hooves, the development of deep pathomorphological changes in the hoof wall, hoof heel, at the base of the hoof skin and hoof bone was observed. This is a major factor in the development of hoof diseases. Weakening of the protective layer of the hoof wall, hoof heel, soft foot under the influence of external factors leads to the formation of lesions, foci of necrosis, the development of purulent pododermatitis and other diseases. Studies have shown that in productive cows with pododermatitis, the pathological process is exacerbated by necrosis of the skin base of the hoof, the tips of the hooves, the hooves, the soft hoof and the hoof bone.

The clinical status of animals in the pre-treatment groups was typical for purulent pododermatitis, with purulent-fibrinous inflammatory process.

When the hooves of sick cows were visually examined, they were found to have defects in the palms and in the following cases: erosion of the stratum corneum, the formation of pathological ducts leading to the skin of the hoof, from which a large amount of odorous exudate. Inflammatory tumors formed in the surrounding tissues and spread to the soft palate and the surrounding area, causing local fever and redness of the skin.

Destructive and dystrophic changes are developed in the underlying skin and surrounding tissues, in which the process of necrosis and necrobiosis spreads to the epidermal, dermal and hypodermal layers. Pathological tissue with necrosis under the fibrin sheaths was formed in large numbers around the defects of the hoof sole. It was observed that the resulting discharge is purulent, exudate containing a large number of leukocytes, inflammatory infiltration has the property of aggressively spreading from the hoof to the deep layers of the drug. The microhemodynamic type in the dermal and hypodermal layers is similar to venous-capillary vessels filled with blood.

Signs of depolymerization were detected in the connective tissue of the mature granulation tissue near the base of the wound.

Cows with purulent pododermatitis in the experimental group developed a strong support by the seventh day, and hyperthermia and tumors developed in the tissues of the pelvic area. Despite the exudative process in the tissues, it was found that the intensity of inflammation decreased.

On the fifteenth day, a positive dynamics was observed in the process of finishing the hooves of the cows in the experimental group, which shows that the condition of the animals has changed in a positive way. Palpation revealed a decrease in pain in the surrounding tissues, although it was limited, and the hoof was noticeable, mainly in the palm. Examination of the hoof bandage showed a decrease in the amount of exudate released, which is a characteristic feature of the dehydration stage. Defects in the palmar part of the hoof revealed the formation of healthy granulation tissue.

Visual examination of the hooves of cows with purulent pododermatitis in the control group revealed the formation of atypical granular tissue with swollen granules in the lower extremities. This tissue was characterized by the presence of a turbid fluid and a layer of fibrin on the surface, which bleeds rapidly, and the appearance of wounds on the surface. Therefore, they noted a slow maturation process and no significant changes in the general condition of the animals.

By the twenty-first day, it was found that the morphofunctional changes in the pathological process shifted to the positive side. The condition of the animals in the experimental group was satisfactory, swelling, local temperature and pain were reduced. Morphological examination of the tissues revealed that reparative-regenerative processes and defragmental epithelialization were clearly visible on the surface of the wound in the hoof defects.

Cows with purulent pododermatitis in the control group were observed for 24-25 days, their general condition and appetite were satisfactory, there was no support, and the cows moved completely on the affected hooves. Local heat and pain are not felt when the hooves are swollen and palpated in the surrounding tissues. Defects in the hoof palm were completely covered with healthy granulation tissue, and due to the completion of the epithelialization process, the growth of newly formed horn tissue at the edge of the wound was observed to close it.

It was found that cows with purulent pododermatitis in the control group had a partial pathological granulation in the hoof defects, which lasted for 4-5 days. Therefore, for 24-25 days in this cow, as a result of partial growth of the horn tissue around the wound, its complete closure was not observed, as the regeneration process was slower than in the experimental group.

One week after treatment, different stages of healing of purulent pododermatitis were identified in all experimental animals. In animals, strong whitening, the formation of fine-grained granulation tissue in the solid foci in the injured foci was noted. Partial bleeding was observed when the hooves were cleaned. In some animals, purulent exudate components were observed on the surface of the wound. In other animals in the experimental group, improvement in general condition, weak lameness, correct position of the legs were found. A dry, weakly painful, branched substance was found around the injured tissue.

Two weeks after treatment, it was found that in some animals, the injured lesion was filled with granulation tissue, and a purulent coating formed on its surface. Part of the wound is filled with horny tissue, hard, partially painful when pressed, lameness is weak. In other cows in the experiment, the purulent-necrotic lesion was filled with dry, completely granulation tissue. A



partial painful reaction in the pathological lesion, the general condition of the cows was found to be good, no lameness.

On the 21st day of treatment, the same characteristic changes were observed in 4 heads of cows in the first experimental group: formation of branched tissue in the wound, growth of granulation tissue at the site of inflammation, surrounded by a hard-to-move film. This condition was characterized by the shrinkage of the injured furnace.

A complete recovery was detected on day 21 of treatment in 4 head of cows in the first experimental group. In the remaining head, it was noted that open wound defects were formed, filled with bright red granulation tissue, and a branched layer was formed around it.

Examination of the hooves of cows in the second experimental group revealed the following changes in the hoof wall and heel heel: foci of animals with purulent pododermatitis were found to have foci of necrosis in the stratum corneum and purulent discharge in some, from which white-yellow pus flowed.

Pathohistological examination revealed acute hyperemia of the blood vessels in the pathological lesion, the development of emigration of erythrocytes and leukocytes, different manifestations of blood plasma and trace elements around the vein and purulent exudate foci, as well as the presence of large numbers of leukocytes, numerous erythrocytes and connective tissue in the exudate. fibers and reticular cells were found to be disordered and atrophied.

Connective tissue cells are broken down, in case of necrosis, the fibers are divided into fragments, as well as fibrinoid and mucoid swelling in collagen and elastic fibers, mucoid and fibrinoid substances are absorbed in the fiber walls, the fibers are broken into fragments.

The foci of necrosis are painted a bright red in the eosin, and the nuclei appear in a state of rexis and picnosis. Dystrophic changes in the cells, the walls of the connective fibers are indistinguishable and necrotic.

Collagen fibers are swollen, mostly fibrinoid necrosis, hyperplasia of elastic fibers and accumulation of fibrin between collagen fibers, hyalinosis, fibrinous changes in connective tissue, the formation of hyaline in the connective tissue instead of broken collagen fibers, elastic muscle dystrophy, smooth muscle cells it was noted that most elastic fibers were eroded.

It was found that serum fluid and large amounts of polymorphonuclear leukocytes emigrated from the vascular walls.

Dystrophic and atrophic changes were observed in the suction layer of the dermis and in the epidermal layer. Dystrophic changes in vascular endothelial cells, foci of necrosis and microabscesses, infiltration of polymorphic cells in some areas of the incision, and acute inflammation characterized by neutrophil granulocytes were detected.

On the third day of the experiment, fibrin was absorbed at the site of inflammation, purulent necrotic tissue was limited, and tissue hypoxia led to the development of tumors. Hygropic dystrophy in desquamated epithelial cells, hyperemia of collarbone vessels under ruptured tissue, interstitial hemorrhage were observed.

On the seventh day of the experiment, not only quantitative changes in cell composition but also qualitative changes were detected. Absorption of degraded tissue occurred as a result of

increased blood circulation. Multiple hemorrhage of the sinusoidal capillaries was observed, and some collagen fibers were not formed by uninjured tissue as a result of cessation of exudative inflammation. In the control group, leukocyte infiltration and advanced hemorrhage were observed under the foci of necrosis.

On the fourteenth day of the experiment, qualitative development of granulation tissue, no fibrin coatings on the surface of the wounds were observed, leukocyte infiltration between the nuclei was observed.

In the control group, necrosis and fibrosis in the center of the wound foci, and in the granulation tissue were noted inflammatory infiltrates rich in plasma cells, lymphocytes, neutrophils.

At the end of the experiment it was found that complete epithelialization develops on the wound surface, granulation tissue between the epithelial components, connective tissue formed inside the wound, lymphoid infiltrates at the edges, fibrous structure developed, in the control group vascular density, scarred epithelial cells recovered.

### CONCLUSION:

- The development of tissue necrosis as a result of the development of a complex necrotic process in the palms of the hooves of productive cows with purulent pododermatitis, circulatory disorders lead to the spread of pathological processes and the addition of microorganisms to it causes purulent pododermatitis;
- purulent pododermatitis in the pathological foci of the hoof, the presence of acute vascular hyperemia, the development of emigration of erythrocytes and leukocytes, various manifestations of blood plasma and trace elements around the vein and purulent exudate foci, as well as the presence of large numbers of leukocytes, erythrocytes and erythrocytes characterized by irregular placement of connective tissue fibers and reticular cells, atrophy.

### REFERENCES

1. Gugkaeva M.S. Complex therapy of purulent pododermatitis in cattle in the farms of the Republic of North Ossetia-Alania // Avtoref. diss. Cand. vet. sciences. Kazan, 2011. 24 p.
2. Ladanova M.A., Sukhovalsky O.K., Dashaev I.V. Diagnostics of limb diseases in cattle at JSC "Kalininskoe". Regulatory issues in veterinary medicine. Quarterly information and analytical journal. No. 3. St. Petersburg, 2013. –P. 65-66.
3. Maryin E.M., Lyashchenko P.M., Sapozhnikov A.V. Clinical and pathomorphological characteristics of purulent pododermatitis in cattle // Bulletin of the Ulyanovsk State Agricultural Academy. -2015. -№4. -S. 123-132.
4. Semenov BS, Videnin VN, Pilaeva NV, Savina G.Yu. Surgical limb diseases in dairy cows. Regulatory issues in veterinary medicine. Quarterly information and analytical journal. No. 3. St. Petersburg, 2013. –P. 107-109.
5. Sol'yanchuk P.V., Kochetkov A.V., Rukol V.M. Association of microorganisms in diseases of the hoof in cattle. Topical issues and ways to solve them in veterinary surgery. Materials of the International Scientific and Practical Conference dedicated to the 80th anniversary of the birth of Professor E.I. Veremey. Vitebsk, VGAVM, 2019. –S. 105-108.

6. Khovailo E.V. The influence of physical activity on the quality of the hoof horn of cows. Regulatory issues in veterinary medicine. Quarterly information and analytical journal. No. 3. St. Petersburg, 2013. –P. 129-130.
7. Jacob V.K., Ermolaev V.A., Maryin E.M. Clinical characteristics of the healing of ulcerative processes in the hoof area in cattle. Regulatory issues in veterinary medicine. Quarterly information and analytical journal. No. 3. St. Petersburg, 2013. –P. 138-140.
8. Kostlin R.G., Nuss K. Behandlung der eitrigen Klauengelenkentzündung beim Rind durch Gelenkresektion – Ergebnisse. // Tierarztl. Praxis. 1988.T.16. N2.- S. 123-131.
9. Botle S., Igna C., Blaga L. Observatii asupra eficientei finadynului. In terapie unor procese algicesi inflamatorii la animale. // (Lucr.//Inst. Agron. (Cluj-Napoca). Fac. Agr. Catedra Med. veter. 1989. T. 15. – p. 369-374.
10. Parker D.W.H., Hinton M. Disease conditions diagnosed in culled adult cattle sent to an abattoir either with or without a veterinary certificate. // Veter. Rec. 1990. T. 126. N. 8. – p. 189-190.

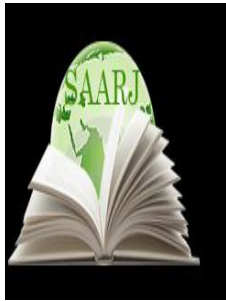

**ACADEMICIA**  
**An International  
 Multidisciplinary  
 Research Journal**  
 (Double Blind Refereed & Peer Reviewed Journal)

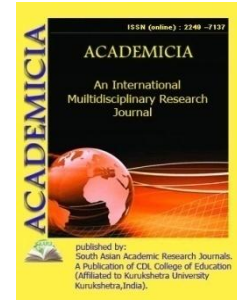

**DOI: 10.5958/2249-7137.2021.01294.5**

## SOURCES OF TSARIST RUSSIA'S RESETTLEMENT POLICY IN TURKESTAN

**Sultonova Maxfuza Ibroximovna\***

\*A teacher at Andijan State University,  
 UZBEKISTAN

### ABSTRACT

*The article discusses the policy of resettlement of the Russian Empire in Turkestan, the Russian settlements built in the country, their way of life, the main goals of the resettlement policy of the colonial authorities, the conditions created for the resettled population through primary sources. illuminated. Many more Russian settlements have sprung up in Turkestan, in remote areas, around military fortifications or forts. The IDPs were initially exempted from any fees and obligations, and were given cash and an unlimited amount of land.*

**KEYWORDS:** *Colony, Resettlement, Position, Draft Regulation, Township, Residence, Serfdom, Peasant, Empire, Laws, Settlements, Military, Officer, Administration.*

### INTRODUCTION

History has shown that the socio-political development of nations varies according to historical circumstances. If it develops at some stage, there is a period of decline in development at some stage. Social change is always based on certain factors and causes. The standard of living of the peoples of Central Asia also changed after the invasion of the Russian Empire. One of the main factors in this dramatic change was Tsarist Russia's policy of resettlement in Turkestan.

The main goal of the colonial government's resettlement policy was to strengthen the colonial system in Turkestan, as well as an important step towards achieving its economic, political and military goals. Throughout history, many invading nations have consolidated their power and introduced their own culture by relocating their inhabitants to the occupied territories. Tsarist Russia also took advantage of this policy. Initially, the resettlement policy was applied in Siberia and the Caucasus, but also in the territory of the Governor-General of Turkestan. After the abolition of the serfdom system in the Russian Empire on February 19, 1861 [1.193], new problems arose before the Russian government. One of the main problems was to provide land for the people freed from serfdom. The abolition of serfdom led to the development of capitalist

relations in Russian socio-political life, the intensification of the workers' movement, and the emergence of new problems in the lives of peasants. When the peasants were liberated, new forms of labor activity appeared in their social life. In particular, they were transformed into workers, peasants and Cossack troops.

Prior to the resettlement policy, Russian Empire officials thoroughly studied the potential of Turkestan and identified fertile, water-scarce, low-cost areas as possible, but no legal basis for resettlement. not developed. There were plans to relocate people from the central districts of the empire to remote areas. It should be noted that there is no special system for the formation of the first Russian settlements, no instructions for the formation of administrative units. It was only in a charter adopted in 1886 that the first normative basis for the resettlement of Turkestans in Turkestan was enshrined in law [1.193].

According to many historical sources, the policy of resettlement of the Russian-speaking population in Turkestan began in 1875 with the resettlement to Avliyota. It is said that the first Russian residence was established in Avliya. However, the analysis of sources confirms that the first resettlement policy began with the occupation of Tashkent by the Russian Empire and the establishment of the Turkestan region. According to sources, the first Russian settlement was established as a result of the occupation of Tashkent. In 1865-1867, the issue was resolved by the military governor of the Turkestan region, and the area between the Bozsuv and Chauli rivers was taken from the indigenous population and vacated for the Russian population. As the Russian-speaking population grew, the settlement expanded to the area from Chauli to Solor, at the behest of von Kaufmann [2.72]. Land in the area was developed in a variety of ways: occupation, seizure, and acquisition by the Russian administration at various times. However, Russians have also expanded their settlements by buying land from locals in and around Chauli, Salar and Salar.

Tsarist Russia initially relocated troops and their families to Turkestan. This can be seen in many sources from that period. Tashkent has been home to Russian settlers since the year the city was occupied. In 1865 General M.G. After the conquest of Tashkent, Chernyayev began to establish a Russian settlement. M.G. In order to prepare the army for the winter, Chernyayev ordered the construction of a fortress and buildings for the winter from August 1865, and by October the construction would be completed. At the military base, a company for 6 infantry companies, a battalion commander, a warehouse for storage of military uniforms and weapons, a powder warehouse, and a medical facility were built. In the Tashkent arch there is a place for the headquarters, the Orenburg artillery battalion, 250 Cossack regiments, Siberian and combat battalions [2.72].

After the conquest of Tashkent on June 17, 1865, M.G. A separate courtyard was built for Chernyayev. This place later served as a hotel for all the colonial leaders who came. Later, a garden was built around the yard and it was called Chernyayev Park. M.G. After Chernyayev was called to Russia, Romanovsky, who was appointed military governor of the Turkestan region, chose a territory in Tashkent in early 1866 for the Russian population. It was taken from the local population of the city, and the eastern part of Tashkent was the area between Bozsuv and Chauli. In June of this year, a commission was formed under the leadership of Romanovsky to build a new city, which will carry out construction work for 18 months (from June 1866 to January 1868). During this period, all buildings in the area, including the arch, were demolished. Instead, European-style streets, barracks, houses for Russian officials, parks, market squares, and housing

for 500 farms will be built. Between 1866 and 1867, 200 private residential buildings were completed. From 1867, General von K.P. von Kaufman, other officials settled with their families in these settlements, and the Russian-speaking part of Tashkent grew rapidly, and between 1868 and 1869 several administrative offices and 500 private houses were built [2.73]. The border between the new Russian-speaking city and the old local city was the Bozsuv River. As Tashkent was the administrative center of the Turkestan Governor-General's Office, it was difficult to provide housing for all Russian citizens. Therefore, the governor-general decided to issue loans for the construction of houses in the amount of 1,500 rubles for a period of 10 years at an annual rate of 2%. This loan was widely used, with a loan of 100,000 rubles in 1868-1869 [2.73].

By 1909, there were 3,000 households in the new part of Tashkent. According to sources, in 1867 the first Russian settlement in Tashkent, the village of Chernyayevka, was established by colonial authorities. The resettlement policy was accompanied by the annexation of the occupied territories [3.144]. The first evacuations began with the relocation of Russian officials and their families. The town of Chernyayevka, home to a large number of colonial administration leaders, was one of the first steps toward Russification.

The settlements are separated from the local population. Many political, cultural and trade events were held in the new part of Tashkent, and representatives of the local population were invited. By the 19th century, Turkestan's business community, intellectuals, and merchants were in contact with the Russian-speaking population, the Russian administration, and immigrants, as well as cooperating in various fields.

Many more Russian settlements have sprung up in Turkestan, in remote areas, around military fortifications or forts. The IDPs were initially exempted from any fees and obligations, and were given cash and an unlimited amount of land. In return, they are required to perform military service in emergencies or to supply a certain number of troops. In order to encourage the resettlement, an unlimited amount of land, loans, and many opportunities for production were introduced.

The colonial administration also initially pursued a policy of relocating Russian peasants to the Seventies. As the administration did not have special instructions on resettlement and resettlement, and no vacancies were identified, the resettlers were housed in rented areas from Kazakhs living around the town of Verny [7.114].

As the issue of land supply to farmers in Russia was not completed, a new form of Russian colonialism in Turkestan - the policy of resettlement - accelerated. The migration of many Russian peasant families to Turkestan was an additional military force for the colonial administration. That is why the colonial authorities urged to pay attention to the creation of conditions and protection of the immigrants in the region. Hence, the governor of the Seventy, G.A. In 1869, Kolpakovsky developed temporary rules for Russian settlements in the Seventies, creating favorable conditions for the mass migration of the Russian-speaking population to the Seventies. As a result, by 1868-1882, 29 Russian settlements with a population of 25,000 were established in Yettisuv [7.114].

Poor farmers from Russia's southern provinces of Astrakhan, Kharkiv, Voronezh, Samara, and Orenburg were relocated to what is now southern Kazakhstan, often suffering from crop failures. In the Orenburg desert, poor peasants set out with their families and belongings.

In 1873 the Governor-General of Turkestan, K.P. von Kaufmann signed a master plan for the mass resettlement of Russian peasants. According to him, Kaufman forbade Europeans, as well as Russians, to buy land from locals. It is planned to establish Russian peasant settlements along the rivers and on the communication lines from Orenburg to Tashkent via Verny to Semipalatinsk. Initially, the resettlement policy was slow, as the resettlers faced many problems. These include leaving the place of residence, the unfamiliar environment in the new place, the hot climate, new ways of cultivating the land, and so on. Not everyone was able to adapt to the new environment and conditions, and there are reports of some returnees. On Friday, an interview with a passenger returning from Turkestan to Kazalinsk was published in Rodina magazine in 1880. It describes the opinion of a Russian farmer who was relocated to Turkestan: "The land is dry, barren and grassy. They said that no matter how we run, neither the plow nor the plow will pass, but it will soften after the rain. It rains in the winter and sparsely in the spring, so the ground is very wet. That is why we are returning to Moscow "[7.114]. Apparently, those who could not adapt to the local conditions were forced to return.

In 1881, the tsarist government issued temporary rules for the resettlement of Russian peasants. In Turkestan, except for poor peasants, lower-ranking military officials were allowed to call their families and stayed with their families in Turkestan at the end of their service. The administration used land and various privileges to keep the military in the area. Each family received at least seven tithes (7.63 ha) of irrigated land, with all paid and other obligations exempted for 15 years. The resettled lands were privatized 10 years later if they were harvested here every year. In 1912, Krivoshen, one of the colonial rulers in Turkestan, said, "Future Russian villages must be richer than local villages. In any case, it is better for the local population to work in the hands of immigrant Russians than to do the opposite." he pointed out.

The colonial administration introduced new rules on resettlement in 1883, now allowing only the Slavic people to migrate to the Orthodox Church, thus limiting the number of immigrants.

In 1886, the "Regulations on the management of the Turkestan region" were adopted. The rights of large landowners and Muslim believers were restricted under the statute, and the state land fund increased dramatically by declaring all lands state property.

By the end of the 1980s, many new Russian settlements had been established in Turkestan, creating all the conditions for the adaptation of the immigrant population. Immigrants are now given 7-10 tithes of land, benefits and loans. On July 13, 1889, the government passed a new law on resettlement, which remained in force until 1904 [7.114]. According to the law, free movement was prohibited, and immigration was subject to permission and order, but arbitrary immigration continued, no matter how legally persecuted.

In many cases, the Russian government treated Russian settlements as military garrisons, including some retired soldiers. In the 1980s and 1990s, the colonial administration took additional measures in response to the national liberation movement and uprisings in Turkestan. Governor of Syrdarya region N.I. According to Grodekov, the evacuees were armed in 1892.

N.I. Grodekov uses the phrase "... every new Russian village is equal to the strength of the Russian battalion" [8.5], which is a call to arm Russian muzhiks. The idea of arming Russian peasants was first put forward by an ordinary ensign Mayev in 1867, two years after the conquest of Tashkent. The idea was prompted by fears of a surprise attack by locals. Russian villages began to be built in strategic places, along rivers, on roadsides. Mayev was offered a place in the

lower echelons of the army, in the settlements along the Syrdarya military line. Mayev explained the strategic advantages of this idea as follows: "The continuous establishment of settlements of retired lower militias, as well as Cossack villages, throughout the region will be of great benefit during the riots in Turkestan" [8.8]. These settlements should be built close to each other to help each other in an emergency. It should be noted that Russian villages have been selected as comfortable, trouble-free areas for living.

The view of the first Russian settlements as a military force began two years after the occupation of Tashkent with the formation of the Governor-General of Turkestan. Retired servicemen have been appointed to administrative positions in Russian towns because of attacks by locals. They were tasked with organizing the first defense. N.I. Grodekov said arming Russian villages in the Syrdarya region was also important for border security in Afghanistan and China. One of the most pressing issues was to ensure that the Syrdarya region was the main military base of the Turkestan Governor-General's Office, as well as a reliable additional force for Russian villages. Beginning in 1889, Grodekov succeeded in arming the Russian population in Turkestan on several grounds, and finally, at his suggestion, on November 29, 1891, the government signed a law on arming the Russian population in Turkestan [8.16].

In the Syrdarya region, the formation of settlements under the command of retired soldiers was planned and arming of the displaced population began in 1892, but this policy was very slow. The reason for this was that the administration was very careful in distributing weapons, fearing various conflicts between the local and Russian population. The first armament took place in the Syrdarya and Fergana regions. Initially, weapons were distributed to retired ex-servicemen, and the rest were distributed to civilians. In 1892, 1,500 weapons were distributed to the displaced in the Syrdarya region, and by 1897, 1,231 had been distributed to the displaced population [8.18].

In 1894, there were 17 weapons in the village of Pokrovsky in the Fergana region, and in 1897, more than 50 weapons from the Syrdarya region were distributed in the village. If we look at the number of weapons, we can see a small number, but if we look at the population, we can see that more than half of the population is armed. As of 1892, the Turkestan Governor-General's Office had 3,000 displaced families in 42 Russian settlements, mostly in the Syrdarya region. In 1897, there were a total of 3 villages in the Fergana region, and by 1899, there were 166 families, 67 of which, or 40.3%, were armed [8.19]. The purpose of the Russian armament was to keep the state of emergency ready. Despite the measures taken, the deteriorating socio-economic situation of the local population forced the Russian administration in Turkestan to take new measures.

1896 Finance Minister S. Yu. Witte came up with the idea of stopping the deportation. Secretary of Defense P.S. Because of Vanovsky's support, the imperial government forbade the relocation of the population to the Seventies. In 1897 the Governor-General of Turkestan, A.B. Vrevsky, without waiting for the emperor's consent, canceled the resettlement to the provinces of Turkestan [7.113].

However, this was a temporary situation. A famine in Russia in 1891 caused a mass exodus of landless peasants to Turkestan. No matter how dense the Syrdarya region, 17 Russian villages were formed in two years. Until the 1990s, there was a shortage of poor among the displaced, but between 1891 and 1892, there was an increase in the migration of the poor. From 1891 to 1892, migration from Russia to Turkestan increased again. The local administration was not ready for



that. The governor-general of Turkestan demanded that the military governor of the Syrdarya region report on the vacant lands on June 17, 1892, in order to establish new settlements. [8]

According to 1890 statistics, 1,300 families were relocated to the Syrdarya region. According to the report, there were no vacant plots of land in Shymkent district, and as of 1892, 360 families had been resettled. From 1875 to 1895, there were 52 Russian villages in the Syrdarya region, 17 of which were in the Shymkent district. One of the reasons for the mass migration of Russian peasants from the central provinces to Turkestan was the normative documents adopted on July 13, 1889, March 15, 1896 and December 27, July 10, 1903 and June 6, 1904. In the early 1990s, more than 15,000 people emigrated to Turkestan as a result of famine in Russia. By the Governor-General of Turkestan, 2,000 of them were relocated to lands confiscated from the local population [6.29]. The migration of the Russian-speaking population not only led to a dramatic increase in the population of Central Asia, but also to an increase in national unity. In 1897, the first census was taken in the entire Russian Empire. In particular, the population of Turkestan is 5.3 million. of which 35.77% - Uzbeks, 44.36% - Cossacks and Kyrgyz, 6.73% - Tajiks, 4.98% - Turkmens, 3.75% - Russians, 2.26% - Karakalpaks, 2.15% - other nationalities [6.29].

The main goal of the colonial administration's resettlement policy in Turkestan was to increase its political influence by Russifying the country. The state of the Russian language, which was transferred to Turkestan, was satisfactory at first sight. However, the resettlement was difficult at first, as Russian farming methods were not suitable for Central Asian conditions. This was stated by an ardent fan of Russian colonial policy in Turkestan, I.I. Geyer also acknowledged that "Russians who have been displaced have had to re-educate themselves from the earliest days to cultivate the land." The displaced Russians initially felt helpless. Because cultivating the land he learned from his father was not appropriate in this area "[9.26].

The Russian Empire sought to solve its internal problems through the policy of resettlement, but the consequences of this policy in the resettled area were a secondary problem for them. The resettled people felt uncomfortable from the very beginning, because their farming activities were radically different from their traditional farming activities.

According to sources, not all of the evacuees were able to use the land or understand the techniques of farming. The tsarist government, although aware of their negligence, continued the policy of resettlement. In an article in the November 1890 issue of *Russkiy Vestnik* entitled "Russian Colonialism in Turkestan," Mr. Ivanov lamented the resettlement policy: "It should be noted that the number of displaced people is growing. In 1886 315 farms were relocated, in 1887 twice as many 789, and in 1889 1006 farms were relocated.

In 1879, the population of the three Christian settlements was 2,000, and 10 years later, in 1889, the number of displaced people in the Syrdarya, Zarafshan and Fergana regions increased to 25,000 "[4,369]. Arriving in these areas, Ivanov described the living conditions of the displaced people as follows: "As we toured several Russian settlements, we were not happy with the information gathered about their living conditions. Despite the fact that the settlers have lived here for several years, the locals have not mastered the use of natural resources. They are like orphans waiting for someone to take care of them and you can't do anything about it "[4.370]. Apparently, most of the displaced people did not love the place because it was forced to do so, but just wanted to use it. Historical experience shows that the use of landowners is beneficial not only to the state, but also to the state in terms of income, employment and welfare of the

population. In the formation and development of the property of the owners lies their tireless work, talent, patience and perseverance. Poverty is often self-inflicted, caused by a lack of innovation, incompetence, and a lack of appreciation for time.

The majority of those deported to Central Asia were poor and faced personal illiteracy in running their own farms. The displaced population is the blackest and poorest part of the Russian population, and the Russian administration controls their activities and expresses its opinion: "Without outside help, without a wise manager, you cannot start your own economy. Since the state does not always provide financial assistance, resettlement policy should be organized in such a way that it benefits the economy. The best way to do this is to relocate the displaced population to private landowners"[5.392].

Thus, the agrarian policy of the tsarist government and its sharp-edged resettlement policy eventually led to an increase in the number of rusars in the province, strengthening their economic position and increasing their dominance over the local population. This created the socio-economic basis of the great Russian chauvinism.

#### REFERENCES:

1. O'zbekistonning yangi tarixi. Birinchi kitob. Turkiston chor Rossisi mustamlakachiligi darida. Toshkent: Sharq, 2000.
2. Добромыслов А.И. Ташкент в прошлом и настоящем. Исторический очерк. Ташкент, 1912.
3. Galuzo P.G. Voorujeniye russkix pereselensev v Sredney Azii. (istoricheskiy ocherk). Tashkent. Sr.-Az.Komm. Un-ta. Im. V.I. Lenina. 1926.
4. Gaspirinskiy Ismail Polnoye sobraniye sochineniy. Tom tretiy. Publisistika: 1887-1890gg. Kazan-Simferopol 2019.
5. Kaufman A.A. Pereseleniye i kolonizasiya. S. Peterburg 1905.
6. Uzbekistan v period kolonializma i sovetского totalitarizma. Uchebnoye posobiye dlya magistrantov po spetsialnosti 5A 120301 Istoriya Uzbekistana. – Tashkent: Nacionalnoye obshchestvo filosofov, 1997.
7. Breyneva S. N. Russkiye pereselensy v Turkestane: problemy vzaimootnosheniya s mestnym naseleniyem. Nauchnyye vedomosti. Politologiya 1973. №1 .Выпуск 37.
8. Vladimir Privalov. Russkiyepereselensy v Turkestanskomkraye. Internetdan
9. Mamadaliyev I.A., Maxmudov O.R. Sущnost pereselencheskoy politiki Rossiyskoy imperii v Sredney Azii. Nomai donishgox. Uchyonye zapiski. SCIENTIFICNOTES. №4 (53) 2017.

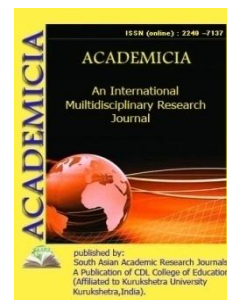
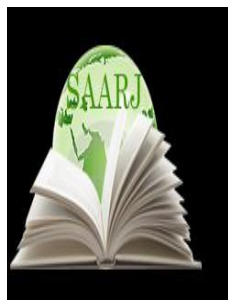

DOI: **10.5958/2249-7137.2021.01295.7**

**SCIENTIFIC AND METHODOLOGICAL BASES OF INTEGRATIVE  
IMPROVEMENT OF THE COURSE "POLYMER CHEMISTRY"  
UNDERGRADUATE EDUCATION "CHEMISTRY"**

**Kurbonova Gulchekhra Rayimovna\*<sup>\*</sup>; Nishonov Mirkozimjon Fozilovich\*\*<sup>\*\*</sup>**

\*Teacher at Chemistry Department,  
Fergana state University,  
UZBEKISTAN

\*\*Professor,  
Chairman of Chemistry Department,  
Fergana state University, UZBEKISTAN  
Email id: Nishonov17157@scientifictext.ru

**ABSTRACT**

*In this article, we will show how polymers are taught in the section on this topic. Information on the history of the Department of Polymers at the Faculty of Chemistry is provided at universities. Polymer science courses at the University of Concept are an integral part of the curriculum in seven programs - chemistry, biochemistry, bioengineering, civil engineering in materials, chemical analysis, chemistry and civil engineering in chemistry. A detailed description of the polymer-based courses included in the curriculum, as well as the scientific and methodological basis for the integrative improvement of the course "Polymer Chemistry" in the bachelor's degree program "Chemistry" in universities.*

**KEYWORDS:** *Polymer Chemistry, Methodology, Chemistry, Integrative Improvement, Teaching Methods, University, Curricula.*

**INTRODUCTION**

Polymers are a part of our lives; scientists dedicated to polymer science are developing new materials, thinking about environmentally friendly methodologies and meeting people's needs. In many universities, polymer science is taught by academics associated with traditional chemistry departments (organic, analytical, physical, and inorganic chemistry). Like various sciences, polymer chemistry has its own language and terminology. Poly- means many, inheritance- means

size. Also, the molecular mass of polymers is very large. Their exact scientific name is called high-molecular compounds. However, you are well aware that the so-called "polymer" is synonymous with science, technology and is widely used in life. The molecule of polymers is also called a macromolecule because they actually have a molecular mass. Polymers are high-molecular compounds whose macromolecules have a chain structure, consisting of groups of atoms (joints) that repeat many times.

Due to the interdisciplinary nature of teaching polymer chemistry to undergraduate students, there are specific difficulties in conveying the topic clearly. It aims to propose a new curriculum for teaching this core course to overcome some major barriers. In particular, new integrative research methods are being added to the professors responsible for teaching first-year polymer chemistry. Starting with the simplest chemical pathway, i.e. live anionic polymerization, we intended to facilitate polymerization. In addition, some pedagogical challenges are highlighted in this article. These new scientific methods of polymer teaching are based on knowledge of organic chemistry.

What is the purpose of the science of "polymer chemistry"? In fact, it is to acquaint undergraduate students in the field of chemistry with the basics of polymer chemistry and its important practical features, which the chemist-bachelor should know, and to help them to test their theoretical knowledge in practice. The general course focuses on explaining the properties of polymers that differ from ordinary submolecular compounds due to the large size and chain structure of macromolecules. The general theoretical course of the subject "Chemistry of Polymers" is carried out by students through laboratory work.

Teaching improvement processes:<sup>1</sup>

- Strategies for providing teaching and workshop opportunities to improve teaching staff;
- Creating opportunities to improve academic courses and research through conferences;
- Update by reading more books and articles related to the course;
- Improving methods in the classroom and allowing students to focus on the learning process through relationships such as improving and enhancing the teacher-student relationship. World experience shows that the relationship between teacher and students certainly affects the quality of education.

Polymer chemistry course materials and learning outcomes should be reviewed periodically and modified. The development of scientific and methodological bases for the integrated improvement of the course of polymer chemistry and the introduction of innovations in this area require the use of modern and interactive teaching methods, mainly through the initiative. Pedagogy is a fundamental and applied science. First fundamental applied research and is characterized by the expression of fundamental priorities. The strategic goal of fundamental research is to identify laws and regularities, to create theories and concepts, to systematize the properties and significance of real objects.

The increasing use of IT or web directories will also make it easier to educate students through changes in content as a result of new research. Polymer Chemistry course materials will be posted on the website, which students can access and can easily use both intensive and integrative coursework. Electronic materials and computer-based software are used to support the course material.

It is necessary to continuously use traditional and interactive methods during the teaching of students, mainly in the course of Polymer Chemistry. It is also important in this area, as it is in every field. The laboratory room is a place where students test their theoretical knowledge in practice. Chemistry is a complex science and we need to be able to explain it to students in a simple and easy way through various interactive and interactive lessons, using modern methods. Fundamental research performs not only prognostic, ontological, but also heuristic and methodological functions to reveal new aspects of the problem in the education system that need to be explored and to develop heuristic technologies and strategies for applied research.

In the context of information globalization, the enrichment of science with different information, a high degree of freedom to analyze and interpret information, like other disciplines, determines the sense of looking at the science of pedagogy from different angles, ie perspectives. An understanding of the course of polymer chemistry that is incompatible with its nature, and attempts to forcibly assimilate approaches, may also be overlooked. The main way to preserve the fundamental nature of this science is to clarify and correctly explain its methodology.

Why is the motivational method necessary for the course of polymer chemistry ?!

Motivation for everyone is a power and a power that inspires a sense of inner confidence that can empower you to take a bold step toward your goal. I believe that the most important result will be a good result if teachers and professors teach students using motivational methods during the course. These methods and integrative scientific methods have been tested in my own teaching activities.

According to the results of the new research, lessons are organized on the basis of interactive methods by introducing the content of the course and giving assignments to improve the overall skills of the student. The main purpose of this course is to acquaint students with current methods of spectroscopic analysis. They are used in a variety of analytical applications by studying and linking their performance, design, problems, and using the following methods with data:

- Instrumental integrative research methods;
- Analytical interactive methods;
- Methodology of analysis and thinking.

The result of science as a system of scientific knowledge and scientific activity is reflected in new scientific knowledge of theoretical and practical type. In general, the existence of truth and novelty is the most fundamental value for scientific knowledge. Science as a component of culture is based on a socio-cultural perspective, a specific historical and cultural context, develops in an axiological context; on the other hand. - serves as a basis for the development of science and culture.

Based on the need for a scientific and methodological basis for the integrated improvement of the course "Chemistry of Polymers" in the bachelor's degree program "Chemistry", which fully reflects the methodology of scientific and pedagogical research, the creative team provided textbooks, methods and manuals. was created. Because this science is complex, understanding a textbook can certainly be a little harder at the beginning. You will have to rely on philosophical and logical thinking in situations like this. According to pedagogical, methodological and

scientific research, using the results of scientific research on the course of polymer chemistry, it is possible not only to understand the essence of the course of polymer chemistry, but also to study the lessons intensively.

In conclusion, I can say that the educational process is always in need of innovation, new teaching and learning methods. A solution to this problem can be found mainly through the scientific research of university students and teachers. In teaching the science of polymer chemistry to young people on the basis of interactive, integrative scientific methods, which have become popular in recent years, it is necessary to conduct lessons with students, both collectively and individually.

By studying the scientific and methodological basis of the integrative improvement of the course "Polymer Chemistry" in the bachelor's degree program "Chemistry" in universities, we see both the quality of education and its level. Basically, it is necessary to conduct research in this area and use the power of modern technology, as well as to guide students in this regard. In the future, we intend to develop new methods in the field of polymer chemistry and to train mature and knowledgeable personnel through lessons based on each of the integrative scientific methods used in the further development of these fields in our country.

#### REFERENCES:

1. Askarov MA, Ismailov II Chemistry and physics of polymers. Tashkent, Uzbekistan, 2004.
2. Young, RJ (1987) Introduction to Polymers, Chapman & Hall ISBN 0-412-22170-5
3. Rashidova S.Sh., Nadjimutdinov NN, Usmanov TI Introduction to polymer chemistry. Tashkent. 2003.
4. <http://goldbook.iupac.org/>
5. "Glossary of Basic Terms in Polymer Science," IUPAC Recommendation [http://goldbook.iupac.org/src\\_PAC1996682287.htm](http://goldbook.iupac.org/src_PAC1996682287.htm)
6. <http://www.chemistry.com>
7. Нишонов, М. Ф., Юнусов, М. М., & Курбонова, Г. Р. (2020). ПРЕПОДАВАНИЕ ТЕМЫ «АЗОТНАЯ ПРОМЫШЛЕННОСТЬ» НЕТРАДИЦИОННЫМ МЕТОДОМ. Проблемы современной науки и образования, (12-2 (157)).



**ACADEMICIA**  
**An International**  
**Multidisciplinary**  
**Research Journal**  
 (Double Blind Refereed & Peer Reviewed Journal)



**DOI: 10.5958/2249-7137.2021.01296.9**

## THEORETICAL FOUNDATIONS OF DIGITAL ECONOMY

**Turaev Khurshid Bakhridinugli\***

\*Student of Bukhara Engineering and Technology Institute,  
 UZBEKISTAN

### ABSTRACT

*Before embarking on our journey into the exciting and engaging digital economy, we will try to get a closer look at the information society and a number of key concepts that are inextricably linked to it. Because only then will it be possible to understand the issues, problems and concepts presented in this article.*

**KEYWORDS:** *New Digital Economy, Techno-Economy, Information Economy, Innovation, Digital Skills, Development.*

### INTRODUCTION

The theory of the digital economy is in its infancy, as the transition of civilization to the digital information stage began only a few decades ago. The term "digital economy" was introduced into scientific practice by Manuel Castels, a Spanish and American sociologist and leading researcher in the information society. He has published a three-volume monograph, *The Information Age: Economy, Society, and Culture*. To date, the theory of the digital economy has not yet been fully formed and is being studied extensively by many economists. In the scientific literature, the modern "New Digital Economy" is called by various terms. For example, "post-industrial economy" (D. Bell), "information economy" (O. Toffler), "mega economy" (V. Kuvaldin), "information and communication-based economy" (I. Nihiluto), techno-economy or digital economy (B. Gates), "knowledge-based economy" (D. Tapskott). The unifying factor of these concepts is the fact that information technology plays a key role in the globalization of economic processes. When talking about the digital economy, it is appropriate to describe the information society., most of the people who work in it are told to a society that is engaged in the production, storage, processing and sale of information, especially knowledge, which is its highest form. This stage of society and economic development is characterized by the growing importance of information, knowledge and information technology in society. Economists use a variety of technological, economic, labor, spatial, consumption and creative criteria to describe

the information society in which the digital economy predominates. We will try to look at each of them in more detail below:

**1. Technological criteria.** New technologies in an informed society is considered a birthmark. These include cable and satellite TV, computer networks, personal computers, new office technologies, and more. This amount of technological innovation is thought to lead to social reconstruction, as their impact on society will be very significant. In Japan, the Ministry of Communications and Telecommunications has been using sophisticated technology since 1975 to measure and record telephone conversations. The following objections to the technological criterion are raised:

- Lack of a rational unit for measuring the volume of information and communication technologies in society; - the problem of not finding a valuable solution to determine the point at which the society can be called informed in the indicator of the technological level; - technologies are inseparable from the social sphere, they are an integral part of society. For example, the decisions that are made in the matter of this or that research and scientific development represent social priorities, and various technologies are developed on the basis of these evaluative considerations. Technological determinism places undue importance on technology, but technology as a non-social phenomenon cannot serve as a major, social factor in the development of society.

**2. The economic criterion is to take into account the growth of the economic value of information.** The increase in the share of the information business in GDP means that the development of society is moving towards an informed society. To determine the level of development of the digital economy, scientists are proposing to introduce the indicator "Gross Digital Product". It reflects the market value of information, goods and services that are useful to the consumer, created in economic sectors using information technology or the information and intellectual component. science, law, publishing, media, and computer manufacturing. Mark Porat, on the other hand, is one of the American scholars who has made a distinction between the primary and secondary economic sectors. The primary sector can be clearly valued economically because it directly creates market value. Although the secondary sector is important to the economy, its economic evaluation is more difficult because it involves information activities within companies and state-owned enterprises.

The economic criterion for defining the information society has found its theoretical basis in the work of the American scientist, Professor Herbert Schiller. He said that "the role of the market will be decisive in any innovation related to information and communication: information must remain a commodity, that is, access to them will be only on a commercial basis." he concludes.

In this case, the information is more like any other product. According to Schiller, market principles work as fully in the field of information as in a capitalist society. According to this criterion, the quantity and quality of information produced directly depends on the availability of useful information. At the same time, it is natural to be faced with the question of what kind of information should be produced in accordance with market principles, for whom and under what conditions. The following objections are raised against this economic criterion:

- In deciding what to include in the information sector, it will be impossible to avoid covert commentary and costly judgment. As a result, the economic importance of the information sector may be exaggerated. For example, F. Makhlop includes in his "field of knowledge" the



construction of "information buildings", which is in stark contrast to the construction of similar buildings, such as universities and libraries, warehouses for food storage. implies that When M. Porat studies his "secondary information sector", he divides any field into information and non-information parts. However, in such a division as "thinking" and "doing", for example, it becomes difficult to determine in which section the work of the operator of control computer systems, which includes various tasks, should be included;

- A valuable approach to measuring the amount of information equates different types of socially significant economic activities. In this approach, for example, \$ 1 spent on advertising is equated to \$ 1 spent on publishing a scientific journal. 3. Labor criteria. It examines the employment structure and trends in this structure. When most members of an active society work in the field of information, it is understood that the society enters the digital information stage of its development. In this approach, information serves as a raw material for non-physical labor.

- The driving force of the modern digital economy is people, whose main task is to create and use information. The criterion of labor has its theoretical basis in the works of the American sociologist Daniel Bell. He proposed a series of social structures that were determined by the priorities of labor as a whole and at all stages. According to him, in pre-industrial societies agricultural labor was the main type of activity, in industrial societies the most common labor was in manufacturing, while in post-industrial society the main type of employment was in the service sector.

- Bell explains that the main reason for such changes is the increase in production efficiency. As productivity increases, so does the number of teachers, doctors, hospitals, and so on. The more goods an industrial society creates, the more types of services it provides, and the more industrial workers move into the service sector. As it is difficult to automate labor in the service sector, the number of workers in the service sector will continue to grow as industrial productivity increases. Therefore, there is no room for a sharp decline in employment, says Bell. The following objections have been made to the above criteria:

- There is no objective way to divide labor into information and non-information types. For example, railroad conductors need to have a great deal of knowledge about tracks, train schedules, and routes. Nevertheless, they are included in the workers of the industrial age;

- In the digital information society, a new class of intellectual and technical intellectuals will serve as a factor in the development of society. No matter how much the number of members of this class grows, their number will remain much smaller than the working population.

Once we have clarified the issues related to the information society above, we will begin our journey into the world of cryptocurrencies. One of the main types of fast-growing digital economy in all developed countries today is a variety of financial transactions with blockchain and cryptocurrencies, in which to know the meaning of active and knowledgeable participation in them. very important. It should be noted that the main difference between blockchain and cryptocurrencies is that their structure is decentralized.

There is no single hub or bank in the blockchain and cryptocurrency systems, and the entire network is based on a P2P (peer-to-peer) peer-to-peer architecture. That is, such a network consists of client programs with the same rights. Each blockchain and cryptocurrency client program, in turn, consists of a self-supporting structure that connects to the global

cryptocurrency network and is fully automated 24 hours a day. The issuance of cryptocurrencies is based on the principle of mining. "Mine" is the process of using the computing power of computer systems to create a chain of cryptocurrency transactions. In this case, each block must have some criteria of accuracy and level of complexity. For this, hashing algorithms are used. Thus, miners find new cryptocurrencies at the same time and perform all possible types of cryptocurrency transactions. If the miners stop working, the cryptocurrency will disappear. The resources of today's modern personal computers are not enough to mine the largest number of circulating cryptocurrencies (Bitcoin, Litecoin).

That's why miners, or "farms," use high-speed, high-performance computer stations with huge computing power. Cryptocurrencies are protected from counterfeiting by hashing algorithms, and their decryption (breach of protection) is currently practically impossible. Digital money - cryptocurrencies We go back to shed some light on the issue and first answer the question of what money is: Money is a currency that is accepted as a common equivalent for the purchase of goods and services by one country or several countries under an agreement. 'lib, it applies in today's economy in paper, metal or electronic form. One of the most important aspects of the currency is that it issues an institution issuing (issuing money) (Central Bank of Uzbekistan) and strictly adopts its value in the territories specified in the payments in accordance with the relevant legislation.

In the United States, for example, it costs only 14 cents to issue a single \$ 100 bill. If half a century ago the value of money was provided by the gold equivalent, today it is determined that they are provided by the total sum of goods and services created in the country. However, every transaction with non-cash money (money transfer practice) is carried out directly through a financial institution. There is a special control, and financial intermediaries (banks, stock exchanges, etc.) are charged a fee for security and services.

## CONCLUSION

And of course, cash can be counterfeit. Given global trends and foreign policy developments, Uzbekistan faces the challenge of global competitiveness and national security, and the development of the digital economy in the country will play an important role in addressing this issue. Some elements of the digital economy are already working successfully in our country.

## REFERENCES:

1. Евгений Филиппов. Криптовалюта от А до Я. STFOREX, 2017
2. Алекс Форк. Bitcoin. Больше чем деньги. 2014, 280 стр.
3. Don Tapscott, Alex Tapscott. Blockchain Revolution: How the Technology Behind Bitcoin is Changing Money, Business, and the World, 2016, 324 pages.
4. Jeremy Clark. Bitcoin, blockchain, cryptocurrency, cryptology (A detailed and technical study of Bitcoin, blockchain, cryptocurrency, and cryptology).; 2016
5. Abdurahmanova G. Q., Rustamov D. J., Directions of development of human capital on the basis of digital economy. Monograph.: 2020. International Book Market Service Ltd., member of OmniScriptum Publishing Group 17 Meldrum Street, Beau Bassin 71504, Mauritius.

6. Gulyamov S.S., Abdullayev A.M. Iqtisodiyotdazamonaviyaxborottizimlarivatexnologiyalari T.: Impress Media, 2018
7. Tulakov U., Usmonov Ch., Turaev B. Increasing The Income of the Population is the Guarantee of A Prosperous Life. TEST Engineering & Management. – 2020. – T. 83. – №. 3. – pp 609-615.

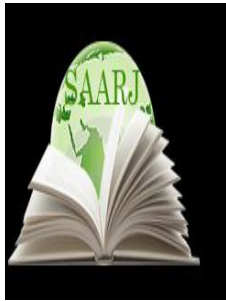

**ACADEMICIA**  
**An International**  
**Multidisciplinary**  
**Research Journal**  
 (Double Blind Refereed & Peer Reviewed Journal)



**DOI: 10.5958/2249-7137.2021.01297.0**

**ECONOMIC AND SOCIAL IMPORTANCE OF CREATING  
 COMPETITIVE INDUSTRIAL CHAINS AND INCREASING  
 INVESTMENT PROJECTS IN STRENGTHENING ECONOMIC GROWTH**

**Yadgarov Akram Akbarovich\*<sup>\*</sup>; Yuldashev Golibjon Turgunovich\*\*<sup>\*\*</sup>; Mahmudov  
 Mirabbos Fazliddinovich\*\*\*<sup>\*\*\*</sup>; Najimadinov Ravshanbek Dushamboevich\*\*\*\*<sup>\*\*\*\*</sup>**

\*Associate Professor of Department "Branch Economics",  
 Candidate of Economic Sciences,  
 Tashkent State University of Economics, UZBEKISTAN  
 Email id: ayadgarov79@mail.ru

\*\*Senior Lecturer,  
 Department of "Branch Economics",  
 Tashkent State University of Economics, UZBEKISTAN  
 Email id: golib76@mail.ru

\*\*\*Associate Professor of Department "Branch Economics" PhD.,  
 Tashkent State University of Economics, UZBEKISTAN  
 Email id: m.mahmudov@tsue.uz

\*\*\*\*Senior Lecturer,  
 Department of "Branch Economics",  
 Tashkent State University of Economics, UZBEKISTAN  
 Email id: ravshanbek071975@gmail.com

**ABSTRACT**

*The article emphasizes the socio-economic importance of creating competitive production chains and increasing investment projects using the opportunities of the investment environment within the framework of reforms aimed at further enhancing the country's economic growth. In addition, an analytical approach to the state of production of industries has been developed and proposals and recommendations have been developed to increase the volume of investments based on investment projects to ensure a competitive production chain.*

**KEYWORDS:** *Economic Growth, Competition, Production Chains, Investments, Investment Climate, Investment Projects, Direct Investments, Economic Complexity Index.*

## INTRODUCTION

The Address of the President of the Republic of Uzbekistan Shavkat Mirziyoyev to the Oliy Majlis summarizes the results achieved this year, the work was done in the framework of the State Program "Year of Science, Enlightenment and Digital Economy" and the next year, as well as the most important tasks for further development. Priorities for domestic and foreign policy were identified [1].

It is no exaggeration to say that 2020 has been a dangerous year for the countries of the world, in particular, the whole of humanity is experiencing a global catastrophe called the COVID-19 coronavirus pandemic. It is true to say that such an unexpected catastrophe has not occurred on a global scale in the last hundred years.

## LITERATURE REVIEW

In order to combat the coronavirus pandemic and the global crisis in our country, on March 20, 2020, Decree PD-5969 "On priority measures to mitigate the negative impact of the coronavirus pandemic and the global crisis on sectors of the economy" was adopted.

According to the decree, the Republican Anti-Crisis Commission headed by the Prime Minister was established to mitigate the negative effects of the coronavirus pandemic and the global crisis in various sectors of the economy, and the Anti-Crisis Fund was established. In addition, 10 trillion soums were allocated to the fund from the state budget.

The funds will be directed mainly to measures to combat the spread of coronavirus infection, support entrepreneurship, and employment, including the implementation of infrastructure projects, ensuring the sustainable operation of sectors of the economy and expanding social support [2].

At a time when strict quarantine measures have been strengthened in connection with the pandemic in our country, there is a need for targeted support to needy families in the regions. It is safe to say that the effectiveness of the "iron book" system, introduced at the initiative of the President, has become a program to maintain stability in social issues, such as employment and the provision of state assistance to needy families, and such good measures have yielded positive results.

In the context of the pandemic, one of the important tasks is to ensure economic growth of the country based on the priorities set by the President, to combat the crisis and mitigate it by creating competitive industrial chains, especially in the pandemic. and ensuring the functioning of the service sector is one of the urgent tasks. Therefore, the development and implementation of effective investment projects in the radical solution of the problems of employment and prevention of unemployment, poverty reduction in the regions of the country are of great importance.

Another important issue raised by the President in the Address is to ensure high economic growth in the country in the coming years. As the President said, economic growth requires constant development of new goods and upward advancement in the global production chain.

In his address, President Shavkat Mirziyoyev said that the oil and gas, metallurgy, machinery, electrical engineering, pharmaceuticals, construction materials, textiles, leather and footwear industries, which are based on in-depth scientific and practical research and have all the potential, should become the "drivers" of our economy. They also expressed their views on what to do in 2021, focusing on the following, in particular [1]:

- ✦ Development of investments totaling \$ 23 billion in the sectors involved in the creation of competitive industrial chains and the commissioning of 226 large industrial and infrastructure facilities;
- ✦ reducing the state participation in investment policy, ensuring the priority of increasing the share of private and direct investment;
- ✦ to determine the list of promising industrial clusters by April 1, 2021, and to develop a separate program for their development;
- ✦ Increased production of industrial products under the "processing regime in the customs territory";
- ✦ In the field of geological prospecting in our country, 50 deposits and promising areas will be sold to investors through auctions.

Uzbekistan ranks 80th in the Index of Economic Complexity, an increase of 9 points over the past decade. For comparison, this is the best indicator among Central Asian countries. Another important aspect of this index is that the higher the index, the higher the income level of the country.

Based on this ranking, Uzbekistan expects an average annual economic growth of 4.5% over the next 10 years, ranking 23rd out of 133 countries analyzed. Another noteworthy aspect is that since 2003, the number of exported goods has increased by 23 new goods. During these years, the number of new products in Kazakhstan - 15, in Pakistan - 21, in Tajikistan - 10 [4].

## RESEARCH METHODOLOGY

The main purpose of the study is to develop scientific and practical proposals and recommendations for the development of the industry based on the analysis of the current implementation of reforms to create competitive industrial chains and increase the socio-economic importance of increasing investment projects, as well as analysis of investment in industrial enterprises. Comparison, grouping, and empirical research methods were widely used in the study.

### Analysis and results

Increasing investment projects is crucial in ensuring the country's economic growth and creating competitive industrial chains. In this regard, the development and effective implementation of

investment projects, taking into account the country's resource potential, will serve to deepen structural reforms in industry, increase its competitiveness through modernization and diversification of key sectors of the national economy.

In particular, comprehensive measures are being taken to further intensify investment policy aimed at modernizing and organizing high-tech industries that provide deep processing of local raw materials and production of finished products with high added value. Extensive work has been done to radically improve and simplify the implementation of investment projects, to expand the attraction and development of investment, especially foreign direct investment [3].

Within the framework of this decision, the Ministry of Investment and Foreign Trade of the Republic of Uzbekistan jointly with the relevant ministries, departments, and other organizations developed 850.5 trillion soums on the basis of the Investment Program of the Republic of Uzbekistan for 2020-2022 soums of investments, including 35.5 bln.

Aggregate forecast parameters for the development of capital investments in 2020-2022, which provides for the development of foreign investment in the amount of US dollars, as well as the development and attraction of investments and loans in 2020-2022, the creation of 206 new production facilities and more than 31 thousand jobs in 2020 issues of launching large production facilities and capacities, have been identified.

Positive work is being carried out in the country with the support of our Government on the development of industrial sectors and attracting direct investors. In particular, investment relations with the World Bank, the European Bank for Reconstruction and Development, the Islamic and Asian Development Banks, and other international financial institutions are changing for the better. In addition, foreign investments in 2020 amounted to 6.6 billion US dollars in fixed assets [5].

It is the development and implementation of investment projects that are of great importance for our country as well as for investors. In this regard, the implementation of investment commitments is set to be carried out mainly in Phase 2. Today, the implementation of investment projects is important for every country. It is no exaggeration to say that investment as a "driver of the economy" is the "heart of the economy" - the driving force.

Along with investment in ensuring economic growth of the country, new technologies, advanced foreign experience, highly qualified specialists, small business and entrepreneurship are rapidly developing in various industries and sectors, as well as in the regions.

According to preliminary data, in January-November 2020, the enterprises of the republic produced industrial products worth 322.3 trillion soums, compared to January-November 2019, the volume index of industrial production amounted to 100.1%. The largest share in the structure of industrial production fell to the share of the manufacturing industry, which accounted for its share in total industrial production (83.1%).

The main factor in the decline in the physical volume of total industrial production was a decrease in mining and quarrying - by 22.5% and in water supply, sewerage, waste collection and disposal - by 6.2%. There was also an increase in manufacturing (processing) by 6.3% and electricity, gas, steam and air conditioning supply by 12.9%.

**TABLE 1 THE VOLUME OF PRODUCTION OF CERTAIN TYPES OF INDUSTRIAL PRODUCTS BY LARGE INDUSTRIAL ENTERPRISES IN THE MINING INDUSTRY AND OPEN-PIT MINING<sup>1</sup>**

<i>Industrial products</i>	<b>January-November 2019</b>	<b>January-November 2020</b>	<b>The difference +/-</b>
Coal, thousand t.	3 513,5	3 710,4	196,9
Oil, ming t.	640,7	673,4	32,7
Natural gas, mln. cubic meters	55 252,4	44 926,1	-10 326,3
Gas condensate, thousand t.	1 932,3	1 268,4	-663,9
Pebbles, thousand t.	1 773,3	1 677,7	-95,6
Gravel, thousand t.	470,2	235,0	-235,2
Kaolin, thousand t.	<b>296,4</b>	<b>351,8</b>	55,4

The volume of products produced by industrial enterprises in January-November 2020 amounted to 267.8 trillion soums or 83.1% of total industrial output. The share of high-tech industry in the structure of manufacturing industry is 1.9% (in January-November 2019 - 1.5%), medium-high-tech - 23.1% (26.1%), medium-low-tech - 40.5 percent (36.6 percent) and low-tech - 34.5 percent (35.8 percent) (Table 1).

Foreign investment is mainly applied to solve financial problems. The use of funds by financial departments of foreign corporations for the purpose of obtaining high returns, including short-term investments, leads to the determination of material interest. Such investments are often based on the capital of private entrepreneurs, who sometimes issue their own securities and buy foreign securities.

**TABLE 2 DYNAMICS OF CERTAIN TYPES OF INDUSTRIAL PRODUCTS PRODUCED BY LARGE INDUSTRIAL ENTERPRISES IN THE INDUSTRY<sup>2</sup>**

<b>Industrial products</b>	<b>January-November 2019</b>	<b>January-November 2020</b>	<b>The difference+/-</b>
<i>Cars, pcs</i>	253421,0	260862,0	<b>7441,0</b>
<i>Trucks, pcs</i>	5 056,0	3 726,0	<b>-1330</b>
<i>Car engines, thousand pcs</i>	186,4	210,4	<b>24</b>
<i>Thousand tons of soft wheat and spelta it</i>	1 485,6	1 685,7	<b>-200,1</b>
<i>Cotton fiber, thousand tons</i>	367,1	510,7	<b>143,6</b>
<i>Thousand tons of vegetable oil (refined)</i>	<b>160,2</b>	<b>146,2</b>	<b>-14,0</b>

In January-November 2020, the industry produced 919.0 thousand tons of gasoline (decreased by 0.8% compared to January-November 2019), 407.1 thousand tons of yarn (9.1%), 1,685.7 thousand tons of soft wheat and spelta flour (13.5%), 226.6 million liters of beer (13.0%) and high growth rates were observed.

An analysis of the structure of foreign investment attracted today shows that the bulk of such investments are in export-oriented sectors: fuel and energy, oil and gas, chemicals, gold mining, and cotton processing, or short-term and large self-repayment. the fund focuses on high-yield



projects that do not require: trade, telecommunications, catering, construction of office and hotel buildings in major cities, food industry, and financial services.

Ensuring the sustainability of production in all sectors is important in ensuring the chain of industries. In this regard, special attention is paid to the implementation of an active investment policy aimed at modernization of production, technical and technological renewal, production, agriculture, transport and communications and social infrastructure projects.

For this purpose, emphasis is placed on the use of centralized, decentralized funds, foreign investments and loans, as well as their effective use.

Of particular note is the work being done to attract investment for the implementation of projects on the structural restructuring of the economy, modernization of industries, technical and technological renewal.

As of 2020, it is planned to create 62,972 new jobs as a result of the disbursement of 16.7 trillion soums of investment funds on the objects of control over the inflow of fixed capital investments in the Republic of Uzbekistan.

**Fig 1.**

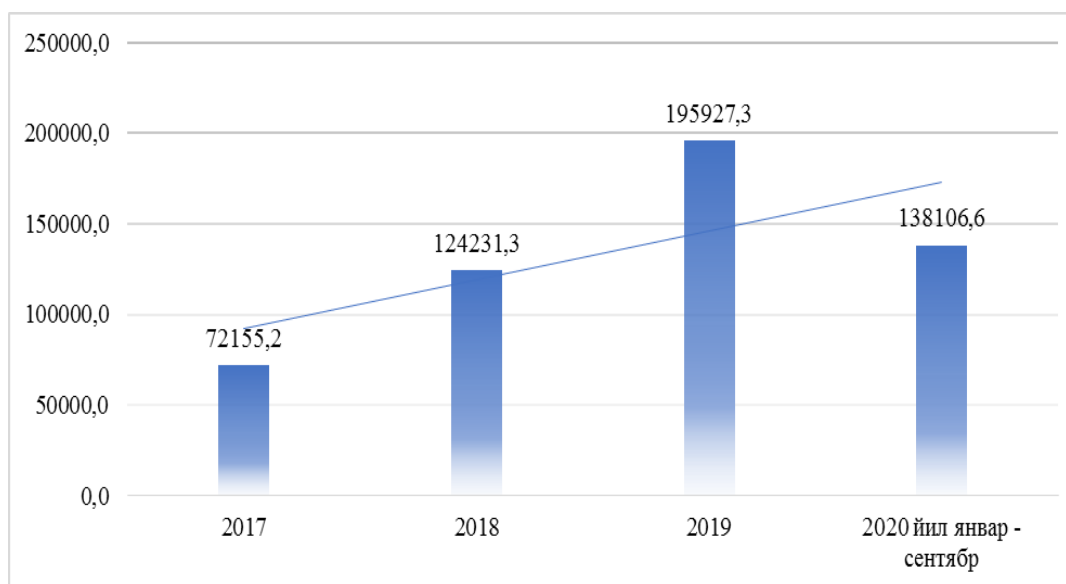

**The volume of investments in fixed assets (in current prices, billion soums) [6].**

The total volume of investments in fixed assets in the Republic of Uzbekistan in 2017 amounted to 72,155.2 billion soums, in 2019 - 19,5927.3 billion soums, in the three-quarters of 2020 - 138,106.6 billion soums (Figure 1).

Analysis of the factors and sources of economic growth in the country shows that in the pre-crisis period, high rates of economic activity were achieved mainly due to the acceleration of export potential, the volume of investments in the economy, systematic and gradual renewal of the economy.

Economic growth has been ensured by the deepening and expansion of economic liberalization, the stabilization of the foreign exchange market, and the rapid development of the small business and private entrepreneurship sector.

## CONCLUSION

The economic and social significance of creating competitive industrial chains and increasing investment projects is growing, especially as a result of deeper processing of raw materials, implementation of structural policies aimed at increasing the share of high value-added goods, reducing the share of agriculture and industry, services an increase in the share of industries is observed.

In conclusion, the measures taken to ensure the economic growth of the country, the creation of competitive industrial chains and increase investment projects, as well as technical and technological modernization of enterprises, expansion of the range of products and further increase the competitiveness of competitive industries. serves to create chains.

## REFERENCES

1. Address of the President of the Republic of Uzbekistan to the Oliy Majlis // "People's speech" 30.12.2020.
2. Decree of the President of the Republic of Uzbekistan No. PD-5969 of March 20, 2020 "On priority measures to mitigate the negative impact of the coronavirus pandemic and the global crisis on sectors of the economy."
3. Resolution of the President of the Republic of Uzbekistan "On measures to implement the Investment Program of the Republic of Uzbekistan for 2020-2022". January 9, 2020, No. PD-4563.
4. <https://review.uz/> - based on the site.
5. <https://mift.uz/uz> - Ministry of Investment and Foreign Trade of the Republic of Uzbekistan.
6. Yadgarov Akram Akbarovich, Abdulkasimov Abdurashid. Rational use and protection of land resources of the Zerafshan economic region Type: article in the conference proceedings Language: Russian Publication year: Pages: 4112-41152016 <https://www.elibrary.ru/item.asp?id=26272357>.
7. A.Yadgarov. International insurance market and experience of foreign countries in agricultural insurance. Economics and Innovative Technologies. Vol. 2020 > No. 2 (2020). <https://uzjournals.edu.uz/iqtisodiyot/vol2020/iss2/>
8. A.Yadgarov. Agro insurance is an important factor in ensuring the economic stability of agricultural producers. Collection of scientific articles and abstracts of the scientific conference "Science and Education in Uzbekistan". March 26, 2020. The conference published a collection of scientific articles and abstracts linked to the Google Scholar system.
9. A.Yadgarov. (2020). AgroInsurance-As A Mitigating Financial Lever For Climate Change In Agriculture. International Journal of Advanced Science and Technology, 29(7), 2251 - 2258. <http://sersc.org/journals/index.php/IJAST/article/view/17501>

10. A.Yadgarov. The importance of using the agricultural insurance system in increasing the volume of agricultural production in pandemic conditions. SAARJ Journal on Banking & Insurance Research (SJBIR) ISSN: 2319-1422 Vol.9, July 2020, Impact Factor: SJIF 2020 = 7.126. 31-37 page. <https://saarj.com/wp-content/uploads/sjbir-july-2020-full-journal>
11. A.Yadgarov. Issues of food safety on the basis of agricultural insurance. The American Journal of Agriculture and Biomedical Engineering ISSN: 2689-1018. JULY 2020. Page No.: 43-52 Volume-II Issue-VII PUBLISHED: 30 JULY 2020. <https://usajournalshub.com/index.php/tajabe/article/view/576/539>
12. A.Yadgarov. Promising directions of insurance of enterprises of the agro-industrial complex. "Caspian Research Institute of Arid Agriculture" "Modern trends in the development of the agrarian complex" of the International Scientific and Practical Internet Conference. May 11-13, 2016 p. Salt Zaymishche, Astrakhan region, Russia. <https://journal.tsue.uz/index.php/archive/article/view/1138>.
13. G.T.Yuldashev. Trends in the development of the fruit and vegetable industry in Uzbekistan. Economy and education. - Tashkent., 2018. -№3. -P. 72-76 [https://scholar.google.com/citations?user=DGpgLW0AAAAJ&hl=uk#d=gs\\_](https://scholar.google.com/citations?user=DGpgLW0AAAAJ&hl=uk#d=gs_)
14. G.T.Yuldashev. The main directions of development of export of products of the fruit and vegetable complex of the Republic of Uzbekistan. Internauka. Science Magazine. Part 1. M.:2019. - №24 (106). -P.-64-66. [https://scholar.google.com/citations?user=DGpgLW0AAAAJ&hl=uk#d=gs\\_](https://scholar.google.com/citations?user=DGpgLW0AAAAJ&hl=uk#d=gs_)
15. G.T.Yuldashev. Agrocluster competitiveness management. International scientific review of problems and prospects of modern science and education / Collection of scientific articles. LXXII International correspondence scientific and practical conference (Boston, USA, July 23-24, 2020). Boston. 2020. P.-26 <https://cyberleninka.ru/article/n/upravlenie-konkurentosposobnostyu-agroklasterov/viewer>
16. M.F.Makhmudov, M.M. Bustonov. Improving Economic Mechanisms to Encourage Efficient Use of Industrial Production Power in Kashkadarya Region Annals of R.S.C.B., ISSN:1583-6258, Vol. 25, Issue 3, 2021, Pages. 8183 - 8196 Received 16 February 2021; Accepted 08 March 2021. <http://annalsofrscb.ro>

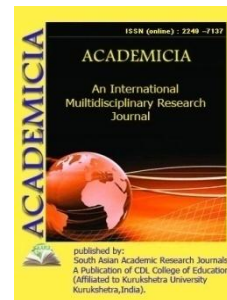

DOI: **10.5958/2249-7137.2021.01298.2**

## THE ADVANTAGES OF USING MODULAR TECHNOLOGIES AT PRIMARY EDUCATION

**Abdurasulova Shoira Kushakovna\***; **Mamarahimov Shuhrat Uralovich\*\***;  
**Mansurova Dilfuza Bakirovna\*\*\***

<sup>1,3</sup>Teachers of the Primary Education Methodology Department,  
Pedagogy Faculty of Gulistan State University,  
UZBEKISTAN

### ABSTRACT

*The modern information society raises new requirements to the process of training of a future primary school teacher as a component of a lifelong education system. An important role in providing of lifelong learning is given to distance education, which promotes self-motivation and self-actualization, enhances independent cognitive activity, and contributes to the acquisition of fundamental knowledge and the formation of skills to use it in professional activity. In this regard, the article analyzes the course "Teaching future primary school teachers to train students on the basis of modular technologies" that contributes to the training of future primary school teachers to the successful use of distance learning technologies in the system of lifelong education. The course consists of two modules. The first module provides theoretical information on a distance learning technology in primary education, and the other – individual research assignments. Also, the paper presents the topics of lectures, practical classes and independent activity and describes the system of student performance evaluation.*

**KEYWORDS:** *Lifelong Education System, Distance Learning, Fundamentals of Distance Learning In Primary Education.*

### INTRODUCTION

#### Problem statement

In the modern information society, when technologies require the new system of thinking, school should teach students communication skills, the ability to work with any information and to think flexibly, depending on a situation. Therefore, modern primary school teachers must possess innovative teaching technologies that requires a school reform according to the State National

Program “Education” (Ukraine XXI century) [8] the National Doctrine for Development of Education in Ukraine [9], the Conception of Continuous Pedagogical Education [1], the National Standard of Primary Education [2], the Regulations on Distance Learning [7].

The use of distance learning modular technologies in all areas of educational activity requires from a modern pedagogical higher education institution the creation of appropriate conditions for forming readiness of future primary school teachers for distance learning in a lifelong education system. In our study, we define primary school teachers’ readiness for DL as possession of knowledge and skills to study in a lifelong education system.

**Recent studies analysis.** The analysis of recent studies and publications, in which the attempts to solve to the problem are found, shows that modern scholars pay much attention to the introduction of distance learning into the educational process , particularly in the process of continuous education of primary school teachers.

The problem of primary school teachers training for professional activity in the modern information society was studied by V. Bondar, N. Bibik, M. Hordiichuk, O. Kyvliuk et al.

**The purpose of the article** is to analyze the content of the course “Fundamentals of Distance Learning in Primary Education” which is taught to future primary school teachers in a lifelong education system

**Main material statement.** The learning technologies that are based on information and pedagogical technologies change the functions of a future primary school teacher in the educational environment of universities, increase the requirements for knowledge, skills and personal qualities. Therefore, great importance is attached to the questions of forming students’ readiness to solve learning and self-study tasks, search, analyze, and present the necessary information using computer tools and technologies. There are objective reasons for the formation and development in a future specialist structural components of learning activity (learning tasks, learning actions, reflection, control), psychological readiness (activity, motivation to self-study, interest in educational and professional activity) and competence in information and communication technologies.

The main objective of the course is to train future professionals for the successful use of distance learning technologies in a system of lifelong education of primary school teachers.

In accordance with the goal and objectives of the course “*Teaching future primary school teachers to train students on the basis of modular technologies*” and considering the complex of requirements for a primary school teacher in the DL [1], we formulated the requirements for knowledge and skills of future primary school teachers that should be acquired and practised in the process of mastering the discipline.

On learning theoretical material of the course, a future primary school teacher must know:

- nature, kinds, functions, tasks, models and technologies of DL on the modern stage;
- development of DL in pedagogical theory and practice;
- conditions of organization of DL in a pedagogical higher education institution; – requirements for the use of DL technologies;
- basic principles of DL in a system of lifelong education of primary school teachers;

- forms and methods of organizing DL in a system of lifelong education of primary school teachers.

On completing the tasks for practical classes and independent work, a future primary school teacher should be able to:

- be familiar with DL models and technologies;
- work with a web-site of lifelong education of primary school teachers;
- organize and conduct DL in a system of lifelong education of primary school teachers;
- develop distance learning courses for primary school teachers, including such elements as forms, glossary, tests, etc.;
- create electronic didactic tools using hypertext, multimedia technologies and technologies of Web 2.0;
- search and select information on the Internet.

The content of the course “Fundamentals of Distance Learning in Primary Education” is determined in accordance with the goal and objectives of the course. The structure of the course consists of two modules.

Module 1 includes two content modules which reflect the topics of lectures, practical classes and independent work (see Table 1)

**TABLE 1.STRUCTURE OF THE COURSE**

Topic	Hours											
	Full-time						Correspondence					
	Total	incl.					Total	incl.				
l		p	lab.	ind.	i.a.	l		p	lab.	ind.	i.a.	
Module I												
Content Module 1. Theoretical Fundamentals of Distance												
Topic 1. Distance Learning in Modern Educational Environment	8	2	2		2	2	8	2			3	3
Topic2. Organization and Holding Training of DL at a University	8	2	2		2	2	8	2			3	3
Content Module 2. Technology of Distant Learning in Primary Education												
Topic 3. Main Competecies of a Primary School Teacher Required for DL	8	2	2		2	2	8	2			3	3
Topic 4. Didactical Foundations of DL Organization in Primary Education	8		2			3	3	8			4	4

Topic 5. Ways of Support of DL in Primary Education	10		2		4	4	10		2		4	4
Topic 6. DL Organization in a System of Lifelong Education of Primary School Teachers	12		2		5	5	12		2		5	5
Total Module I	54	6	12		18	18	54	6	4		22	22

The modular control has two components: the control of the independent practical assignments completion and taking tests.

In the first case, students load on the distance course webpage completed practical assignments in the form of files; a lecturer checks these works, assesses and analyzes, and then sends the results to students for revision or rewriting if necessary.

Tests are carried out on all topics. Each student, taking a test on any topic, has one attempt and 8 min. to complete it, after he or she can see the number of correct answers and earned points.

In the distance course “Fundamentals of Distance Learning in Primary Education” tests on each topic consist of 10 questions developed in a closed form: select one or several answers.

- The Final Testing. The goal of this stage is to test and evaluate the knowledge and skills of the course as a whole. During this stage, students take closed-form tests, consisting of 15 questions. To complete the test they have only one attempt.
- Conclusions, analysis and reflection. This stage combines two complementary processes:

the analysis of a student’s activity by a lecturer and by other students, reflection (the analysis of their own activities) students. The teacher concludes the study of the distance course, examines the activity of students, and calculates the final score.

## CONCLUSIONS

Thus, the analyzed training course “*Teaching future primary school teachers to train students on the basis of modular technologies*” takes into account the following peculiarities of the DL organization in a system of lifelong education of primary school teachers: the shift from teaching to independent cognitive activity of students; the necessity of forming abilities of distance interaction by means of information technologies (compulsory computer literacy of teachers and students); the change of interaction between the subjects of educational activity caused by the advent of information technologies which leads directly to changes in the educational process; flexibility where residence and class hours do not matter, since the classes can be conducted at time and place convenient to everyone.

We believe that this training course contributes to fundamentalization of education, the development of systems thinking of future specialists, the study of theoretical, methodological and practical problems of forming, functioning and development of a lifelong education system, building readiness of future specialists for DL in a lifelong education system.

**Prospects for further studies** are in improving the course “*Teaching future primary school teachers to train students on the basis of modular technologies*” in all forms of organizing the educational process of a pedagogical higher education institution by means of modern DL technologies.

**REFERENCES:**

1. Medvedev V.A. Seven generations in the Kuzbass. Novosibirsk: Siberian time, p. 452. 2007
2. Materials of the school museum "Homeland is important!".Stolyarenko L.D., Samygin S.I.,Stolyarenko V.E. Psychology and pedagogy. - Rostov n / a: Phoenix, 2014 .-- 636 p.
3. Agapova I., Davydova M. Patriotic education at school. - M .: Iris - Press, 2002 .-- 224 p.
4. Slastenin V. A., Isaev I. F., Shiyarov E. N. Pedagogy. -M .: "Academy" Publishing House,2013. - 496p.
5. Kodjaspirova GM, KodjaspirovA.Yu. Pedagogical dictionary: For reading. high and Sundaypad textbook. institutions.- M .: Academy, 2000. -176 p





**ACADEMICIA**  
**An International  
Multidisciplinary  
Research Journal**  
(Double Blind Refereed & Peer Reviewed Journal)



DOI: **10.5958/2249-7137.2021.01299.4**

## LINGUISTIC ANALYSIS OF COMPUTER TERMINOLOGY

**Zulfikorova Zuhra Allaberdievna\***

\*English Teacher,  
Karshi Engineering Economic Institute,  
UZBEKISTAN

### ABSTRACT

*To date, the Internet term system needs to be streamlined, which can be implemented through the use of various models of representation of conceptual structures. The development of the principles of defining Internet terms, as well as a complete complex parametric description of the term system and a complete detailed representation of the conceptual structure is the perspective of this study. The terminology studied in this dissertation, due to both the increasing spontaneity and rapidity of formation, and the increasing importance of the field itself, its globality and incorporation into a common language, requires close attention of terminologists and appeals to normative work using effective methods.*

**KEYWORDS:** *Terminology, Internet, Term Systems Terminological Semantics*

### INTRODUCTION

The need for a deep and comprehensive study of computer terms in various languages is confirmed by modern works on the terminology of computer technology in English [Kondratyukova, 1984], Russian [Komleva, 2006], French [Telyatnikova, 2001], Spanish [Lobanova, 2009]. Computer terminology is the subject of dissertation research, which examines terms borrowed from the English language [Shumailova, 2003; Glazyrina, 2006], methods of formation of computer terms and their structural and semantic features [Antonova, 2004; Koshkarova, 2004; Belikova, 2004; Knyazev, 2006], extralinguistic conditionality of computer vocabulary [Akulinina, 2003].

The systematic nature of terminology is due to the performance of its units of the main function of designating special concepts of a certain field of knowledge, which in turn is determined by the presence or absence in their internal form of categorical, concept-forming features, the motivation of the form and semantics of the term, as well as the complexity of scientific concepts verbalized by terms. In this regard, such poorly studied phenomena as: 1) the content structure of

terms, in particular the semantics of unambiguous and polysemantic terms; 2) the causality of the inclusion in the external form of terms of elements that reflect the essential, characteristic or only distinctive features of the concept.

There are three main aspects of the study of terminological semantics: derivational, due to the component composition of the structure of terms and the attachment of individual term elements to certain categories of concepts; functional-field, exposing the semantics of terms of specific areas of knowledge using fixed means of professional speech and through their correlation in the general field space; and lexical, based on intersystem, intersectoral and inter-scientific connections and relations [Morozova, 2004:78-79]. The latter is most often stated in semantic studies of terms, but a comprehensive study of the three aspects is almost not presented.

Thus, the relevance of the research is due to the urgent need for a comprehensive study of terminological semantics in the derivational, functional-field and lexical aspects and the ordering of terminology in the field of the Internet, which penetrates into all spheres of modern life.

As a result of the conducted research, it is proved that the terminology of the Internet in the English language is an open multidimensional system of special nominations that is constantly updated and adjusted because of the intensive development of the practical application of the Internet and its active implementation in all spheres of activity.

The study showed that the dynamic nature of the term system caused by the constant migration of units affects the specific nature of Internet terms that correspond to the trends in the development of term systems (consistency of semantics, fullness and unambiguity, lack of synonyms, jargon, unusual forms, variants, motivation, internationality, euphony). However, it was noted that in specific cases, Internet terms deviate from the prescribed requirements for one reason or another, while performing the main function of designating a special concept of the Internet area.

The function of the designation of a special concept as the main essential characteristic determines the functional-semantic and structural and grammatical originality, greater informativeness and motivation of the linguistic substratum of the term.

The study of the formal, semantic, historical and functional characteristics of Internet terminology gives an idea of the studied set of terms as a relatively normalized, mainly international macroterminology, consisting of various subsystems formed as a result of the separation of a new field of knowledge from the subject area of computer technology with the simultaneous influence of a number of sciences. Extra linguistic factors allow us to distinguish six stages in the formation of a special area of the Internet, each of which corresponds to a certain stage in the formation of concepts and their designated terms with a predominance of spontaneity or consciousness at different stages. Apparently, the Internet term system is one of the few in the field of special communication, the composition of which is almost completely native in origin, although today, in connection with the development of the Internet in non-English-speaking countries, borrowings appear in the English terminology of the Internet (5% of the new terms recorded in the period from September 2009 to January 2010), but more often they have native doublets.

Considering the terminology of the Internet from the point of view of logical and linguistic coherence allows us to conclude that it contains branched derivational nests, in particular in the

form of derivational paradigms, the derived elements of which are both the result of term formation within the English language system, and the result of filling terminological gaps with the help of professionalism. Regular and productive terminological paradigms and term-forming models reflect the system connections at the level of an individual term.

The core area of the main terms of the Internet stands out clearly, as well as other groups of terms (complex, derived, involved, basic, general scientific\general technical and terms of broad semantics).

Terminology as a whole is quite ordered, which is facilitated by various factors considered in our work, including the system relations of terminological vocabulary (synonymy, antonym, hyponymy, etc.). Interaction with related term systems ("Graphics and typography", "Marketing and advertising", "Computer " Telecommunications"), the demand for phenomena and objects, technologies "and reflected in the terminology of the Internet, by different circles of modern society, explains the trends towards simplification, "comprehensibility" of special units, which has the corollary of the functioning of a large number of synonymous categories, which to some extent are not always justified, since it is impossible to clearly trace the degree of similarity\differences. However, in the systematic representation of the meanings of synonyms, which is facilitated by the structural parallelism of definitions, additional linguistic consistency, the description of specific features of differences and similarities in the reflection of paradigmatic relations, the type of definition, strengthen the system connections of terms in the term system. The analyzed definitive material from the point of view of reflection of semantic correlations of synonymy, antonym, hyponymy, "part-whole", semantic derivation and associative correlation precisely proves the presence of deep system relations in the terminology of the Internet, reflecting logical and conceptual connections. At the same time, the accuracy of the reflection of the conceptual relatedness depends on the number of system connections between the terms fixed at the semantic level in the terminological definition.

The multidimensional nature of the Internet term system can be traced in the thematic organization (six large thematic groups: web technologies, e-commerce, Internet infrastructure, distributed data processing and distribution systems, information security on the Internet, the language of chat, discussion groups, communities, e-mail), while the integrity and interconnection of individual subgroups is manifested in the ability to identify more general and large thematic blocks (networks, the World Wide Web and Internet services) and in the presence of connecting overlapping subgroups, what is presented in the holistic model of the conceptual system of the Internet. The hierarchical structure of the Internet term system is illustrated in the form of a frame consisting of subframes and numerous slots arranged vertically and horizontally. The structure of the concept of "Internet" is presented in the form of a set of 10 main cognitive features, widely represented in the blocks of terminological vocabulary. The multilevel and structural complexity of Internet terminology revealed in the course of our research is reflected in the "spherical structure", that is, in the structure of the Internet. a general representation of the consistency of a certain language set in three-dimensional space in the form of several horizontal sections (functional, technical, and problem-sociological).

Consideration of the structural relations of Internet terminology at four levels (terminology in general, term-semantic group, individual term, and individual meaning of the term) it contributed to a comprehensive description of the terminological consistency. The most promising and at the same time difficult in the description of terminological consistency is the study of the semantic

consistency of the term and the modeling of the semantic space of terminology, since it is at the semantic level that it is possible to identify the fundamental connections and relationships that manifest themselves at higher levels.

The component approach to the study of the content structure of the term and its formation, in particular the component analysis of the meaning of the term, allows you to identify deep semantic connections in the term system, describe the subject-semantic differences of terms, determine the specifics of each component of the content of the term and at the same time its similarity to the commonly used word, as well as to investigate the interdependence and mutual influence of these components (for example, in the process of terminologization or when there are regular relations between the sememes of a multi-valued term).

One of the aspects of describing the semantic consistency of a term is the study of terminological polysemy, which in this perspective appears as a regular, regular, systematic and cognitively conditioned phenomenon in terminology. A significant majority (more than 80%) of polysemantic terms of the Internet and computer technologies are formed semantically from polysemantic common words belonging to the zone of poorly developed polysemy, which allows us to conclude that the polysemy of the term is conditioned by the polysemy of its common source. Modeled homonyms in Internet terminology are also able to develop polysemy, but it is somewhat more difficult to trace the dependence of this development on a commonly used source, since it is necessary to take into account the paradigmatic relations in the semantics of the term and the connections of the OU homonyms of terms in the general vocabulary. This line of research is, in our opinion, quite promising, along with the consideration of the process of terminologization as a factor affecting the semantic development of terms.

To date, the Internet term system needs to be streamlined, which can be implemented through the use of various models of representation of conceptual structures. The development of the principles of defining Internet terms, as well as a complete complex parametric description of the term system and a complete detailed representation of the conceptual structure is the perspective of this study. The terminology studied in this dissertation, due to both the increasing spontaneity and rapidity of formation, and the increasing importance of the field itself, its globality and incorporation into a common language, requires close attention of terminologists and appeals to normative work using effective methods.

## REFERENCES

1. Abdurasulov Y. (2009) Turkiytillarning qiyosiy-tarixiy grammatikasi. – Tashkent: “Fan”. 260 p.
2. Adji M. (2004) Tyurkiimir: sokrovennaya istoriya. – Moscow: AST, 650 p.
3. Drevnetyurkskiyslovar. (1969) – Leningrad: Izd. “Nauka”. 800 p.
4. Dybo A.V. (2007) Lingvisticheskiy kontaktirannikhtyurkov. Leksicheskiy fond. Moskva, Izd. “Vostochnayaliteratura”, RAN. 224 p.
5. Gumilyev L.N. (2007) Etnogenez y biosphere zemli. – M.: AST, 556 p.
6. Kuldashv A.M. (2020) Tilshunoslik datarixiy liktamoyili. Tashkent, Fan. 300 p.
7. Kuldashv A.M., Hamzayev S. (2015) Ingliz tilitarixi. Tashkent, 191 p.

8. Lingvisticheskiyentsyklopedicheskiyslovar (LES). (1990) – Moskva, Izd. “SovetskayaEntsiklopediya”. -650 p.
9. Müsse L. (2008) “VarvarskiyenashestviyanaYevropu: Germanskiynatisk.” – Yevrazia, Sankt-Peterburg. - 400 p.
10. O’zbekcha-Ruscha lughat. (1959) Toshkent, Uzdavnashr. 590 p.
11. Smirnitskiy A.I. (1940) Khrestomatiya po istoriangliyskogoyazyka. Moskva, Inostrannaya literature. 350 p.
12. Terentyev V.A. (1990) Drevneyschietyurkskiyezaimstvovaniya v yazikahYevropy. – V: SovetskayaTyurkologiya. - v. 4, pp 39-74.
13. Zhirmunsky V.M. (1960) Nemetskayadialektologia. Moscow, “Nauka”. 680 p. (German Dialectology)

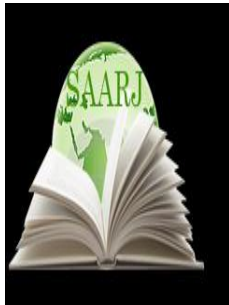

**ACADEMICIA**  
**An International  
 Multidisciplinary  
 Research Journal**  
 (Double Blind Refereed & Peer Reviewed Journal)



**DOI: 10.5958/2249-7137.2021.01284.2**

## A STUDY ON LIQUIDITY ASSESSMENT OF AUTO ANCILLARIES OTHERS IN AUTOMOBILE INDUSTRY

**Dr. R. Vidya\***

\*Department of Commerce,  
 Government Arts College Udumalpet,  
 INDIA  
 Email id: vidyapollachi@gmail.com

### ABSTRACT

*The primary aim of this paper is to analyse the liquidity assessment of Auto Ancillaries Others sector of Indian Automobile Industry. A Sample of 40 companies has been selected for the present study. The study period covers from 2004-05 to 2013-14. The result shows that As per Discriminant analysis of Auto Ancillaries sector was good in others.*

**KEYWORDS:** *Auto Ancillaries Others, Liquidity.*

### INTRODUCTION

Liquidity refers to the ability to pay in cash the obligations that are due. If sufficient liquidity is not maintained, the enterprise is technically insolvent and at least faces the financial embarrassments of renegotiating its obligations to creditors.<sup>9</sup> A higher financial liquidity would generally mean a lower risk of technical insolvency showing capability of an enterprise to pay the current debts as they become due. There are several measures with the help of which the short term liquidity of an enterprise may be assessed.

Liquidity management is necessary for all businesses, small, medium or large because it means collecting cash from customers in time so that having no difficulty in paying short-term debts. Therefore, when a business does not manage its liquidity well, it will have cash shortages and will results in difficulty in paying obligations. As a result, in addition to liquidity management is vital for on-going concerns.

### Statement of the Problem

The growing scenario of Indian economy has made a healthy development of transportation industries. Automobile industry is one of key elements in transportation industries and

automobile vehicles are a vital element for all industries and society. Finance is the life blood of the business. Therefore, when a business does not manage its liquidity well, it will have cash shortages and will result in difficulty in paying obligations. There is no study on liquidity assessment of Indian automobile industry. Therefore to cover the gaps in the earlier studies, the present study is undertaken to give an insight into the liquidity assessment of Auto Ancillaries others sector in the Indian Automobile Industry.

## RESEARCH METHODOLOGY

Automobile industry consists of two sectors. One is Automobiles and the other one is Auto Ancillaries. The Automobile Industry has 242 companies in the capital line data base. The present study is based on secondary data. The auto ancillaries others sector the number of available company is 144, out of these 40 companies have been selected. The data for this study has been selected based on stratified sampling. The study period has been chosen from 2004-05 to 2013-14 (ten years). Discriminant analysis has been used for the present study.

### Discriminant Analysis

In this study, the following two variables as reliable indicators of liquidity behaviour have been considered for the selected Auto Ancillaries Other Companies

$X_1$  = the Current Ratio (CR)

$X_2$  = the Liquid Ratio (LR)

The object is to determine weights for  $X_1$  and  $X_2$ , that is the values of 'a' and 'b' in

$$Z = a X_1 + b X_2$$

Where, Z is the discriminant index.

First of all, the selected companies have been classified into two groups. The companies, which have Current and Liquid Ratios of 2:1 and 1:1 or more respectively have been classified as good risks (Group A) and the remaining companies as poor risks (Group B). After classifying the selected companies into the good and poor risk classes, the values of 'a' and 'b' in the discriminant functions are estimated. The discriminant co-efficient was multiplied with the values of each company ratios in order to obtain the discriminant score of each company. With the help of the discriminant scores, the cut off values are calculated as follows.

$$n_1 Z_1 + n_2 Z_2$$

$$\text{Cut off value} = \frac{\quad}{n_1 + n_2}$$

Where  $n_1$  and  $n_2$  are the size of sample and  $Z_1$  and  $Z_2$  are the mean of the discriminant score of Group A and Group B respectively. Actual Z scores of the individual companies are compared with the discriminating Z scores. If the Z scores are found to be more than the discriminating Z scores, it can be said that such companies have good liquidity position.

The following financial ratios are used to make discriminant analysis.

### 1. Current Ratio

## 2. Liquid Ratio

### 1. Current Ratio

The Current Ratio is a measure of the company's short-term solvency. It explains the relationship between the Current Assets and Current Liabilities. The Current Ratio is calculated by dividing Current Assets by Current Liabilities.

$$\text{Current Ratio} = \frac{\text{Current Assets}}{\text{Current Liabilities}}$$

This ratio indicates the availability of Current Assets in rupees for every one rupee of Current Liabilities. A ratio of greater than one means that concern has more Current Assets than Current Liabilities. As a conventional rule, a Current Ratio of 2: 1 or more is considered satisfactory.

### 2. Liquid Ratio

It is a measurement of a company's ability to convert its current assets quickly in to cash in order to meet its current liabilities. Thus it is a measure of quick or acid liquidity.

$$\text{Liquid Ratio} = \frac{\text{Liquid assets}}{\text{Current liabilities}}$$

Liquid Ratio of 1:1 is considered satisfactory as a company.

**TABLE NO. 1.1 GOOD AND POOR RISK COMPANIES IN TERMS OF CURRENT RATIO AND LIQUID RATIO (AUTO ANCILLARIES - OTHERS)**

Year	Good risk	Poor Risk
2004-05	17	23
2005-06	16	24
2006-07	18	22
2007-08	18	22
2008-09	20	20
2009-10	19	21
2010-11	16	24
2011-12	17	23
2012-13	17	23
2013-14	17	23

**Source: Computed from the Annual Reports of the Indian Automobile Industry**



**Table No. 1.3**  
**Discriminating Z-scores for the selected Other Companies for the year 2004-05 to 2013-14**

2004-	2005-06	2006-07	2007-08	2008-09	2009-	2010-	2011-	2012-	2013-14
0.48	1.26	-0.34	-0.91	-2.06	-1.07	2.03	0.16	0.52	-0.06
-0.46	0.64	0.28	0.66	1.22	0.31	0.70	0.10	0.08	0.47
-1.37	-2.41	3.97	3.35	0.24	-0.81	-2.08	-0.17	-1.23	0.51
-0.62	1.36	1.94	0.02	-0.15	-1.25	-1.82	0.30	-0.46	0.68
1.17	0.19	0.36	-0.02	1.20	-0.88	-0.17	-2.06	-0.75	0.96
0.58	0.30	1.19	0.31	1.14	-1.24	-1.05	-0.88	-1.39	1.05
-1.20	-0.40	-0.58	-1.28	0.66	0.80	1.51	0.89	0.64	-1.06
-1.24	0.79	-0.33	0.13	1.98	-0.34	-1.04	-0.86	1.01	-0.11
-0.97	-1.08	1.09	3.20	-1.23	-1.84	0.04	0.96	-0.01	-0.15
-0.56	0.17	0.38	-1.49	3.85	-1.00	-2.31	0.71	0.27	-0.01
-0.87	-0.61	-1.51	0.91	-0.38	-0.98	1.52	2.91	0.13	-1.12
-0.27	0.78	2.49	1.15	-0.25	-0.06	-1.76	-0.96	-2.55	1.42
3.34	-1.40	-2.05	-0.87	0.93	1.66	-0.95	-0.39	-0.79	0.52
0.28	0.47	1.15	0.03	0.03	1.01	1.11	0.05	0.50	0.66
-2.16	-1.35	2.73	0.17	-0.22	1.31	-1.09	0.	0.56	-0.63
0.33	0.57	1.13	0.65	0.69	-0.88	-0.64	-1.64	-1.28	1.09
-0.46	-1.65	1.13	0.64	-1.28	1.95	-0.85	0.02	1.05	-0.56
-2.17	-0.34	2.53	0.80	-0.19	-0.46	0.14	1.13	-1.30	-0.14
-0.94	-1.45	-1.70	-2.14	2.36	2.59	1.47	0.74	0.47	-1.40

<b>Companies</b>
Alicon Castlloy Ltd
Auto Jemition Ltd
Auto line Industries Ltd
Banco Products (India)
Bharat Seats Ltd.
Brakes India Ltd.
Canara workshops Ltd.
CMH tools Ltd.
Fiem Industries Ltd.
Harita seating systems
Jay ushin Ltd.
JBM Auto Ltd.
Johnson control India
KEM Industries Ltd
LG Balakrishna Bros
Lucas Indian Services
Lumax Automotive
Lumax Auto
MiPco Seamless Rings

**TABLE NO. 1.2 DISCRIMINANT FUNCTION FOR THE PERIOD 2004-05 TO 2013-2014 (AUTO ANCILLARIES - OTHERS)**

Year	Function	Remarks
2004-05	$Z = 1.93 a - 1.26 b$	$a > b$
2005-06	$Z = 2.10 a - 1.37 b$	$a > b$
2006-07	$Z = 2.19 a - 1.48 b$	$a > b$
2007-08	$Z = 2.14 a - 1.48 b$	$a > b$
2008-09	$Z = 2.45 a - 1.65 b$	$a > b$
2009-10	$Z = 2.21 a - 1.53 b$	$a > b$
2010-11	$Z = 2.09 a - 1.36 b$	$a > b$
2011-12	$Z = 2.19 a - 1.44 b$	$a > b$
2012-13	$Z = 2.26 a - 1.46 b$	$a > b$
2013-14	$Z = 2.07 a - 1.39 b$	$a > b$

Note: The expression  $a > b$  is to be read as “a is greater than b”.

2010-11	2011-12	2012-13	2013-14
-1.10	-0.98	-0.33	1.13
0.66	1.63	1.07	-1.24
-1.32	2.17	3.78	-0.96
-1.77	-0.53	-1.92	0.38
-3.19	0.95	0.98	-0.53
-1.48	-1.28	-1.36	0.57
0.37	1.79	1.81	-1.10
-0.89	-1.56	-1.21	0.50
-1.54	-0.70	1.19	-0.04
-5.02	-3.08	-2.81	4.07
-1.50	-1.19	-0.02	0.16
0.16	0.33	0.73	-0.90
0.75	-0.46	0.58	-0.65
-0.54	0.05	1.95	-0.44
0.13	1.71	2.06	-1.11
0.00	-0.97	-3.82	1.64
-0.63	-1.75	-0.99	0.76
-0.69	-0.29	0.19	-0.17
0.72	-1.62	-0.82	0.18
1.70	1.98	2.87	-2.19
-0.16	-1.21	-1.81	1.24
<b>-0.46</b>	<b>-0.04</b>	<b>0.02</b>	<b>0.08</b>

Source : Computed from the Annual

Companies	2004-05	2005	2006	2007-08	2008-09	2009-10
Munial Auto Industries	1.72	0.76	1.15	-0.08	-1.53	-0.73
Perfect Circle India	-1.12	-0.93	-0.91	-0.28	0.18	0.93
Remsons Industries	2.90	-0.23	-2.48	-2.89	-0.78	-0.18
Rico Auto Industries	-1.53	-1.40	-0.16	4.40	2.35	0.18
Schrader Duncan Ltd.	0.60	-2.38	-0.76	0.59	1.05	2.70
Sharda Motor	-0.82	-0.26	0.05	2.59	1.12	0.87
Simnson & Companv	-0.71	-0.53	-0.44	-0.34	-0.24	-0.60
Spicer India Ltd.	-1.17	0.37	0.88	0.65	0.80	1.62
Stanes Motor Parts Ltd.	-1.71	0.39	1.58	0.93	0.47	-0.56
Subros Ltd.	2.51	3.34	5.40	3.22	-4.19	-3.45
Sunbeam Auto Pvt. Ltd.	1.10	-1.72	-0.69	0.37	0.65	2.83
Suprajit Engineering	-1.95	-1.72	1.03	1.46	-0.05	0.90
Swarai Automotives	-0.41	-2.43	-0.37	0.83	2.00	0.16
Talbro's Automotive	-0.30	1.70	-0.85	-1.87	-0.26	0.55
TMIL Driveslines	-0.43	-0.80	-0.14	-1.28	0.88	-1.02
Tractors Engineers Ltd.	1.22	0.65	0.81	-0.34	1.63	-0.80
Triton Valves Ltd.	-0.42	0.73	0.90	-0.44	2.14	-0.31
Varroc Engineering	-0.61	0.37	1.05	-2.58	-0.09	2.82
Victor Gaskets India	0.63	-0.89	-0.78	-1.00	2.42	1.18
WABCO India Ltd.	-1.63	-1.63	-1.63	-0.42	0.47	0.47
XLO India Ltd.	1.15	1.26	0.44	-0.19	-0.40	-0.32
<b>Cut off point</b>	<b>-0.18</b>	<b>-0.13</b>	<b>0.47</b>	<b>0.15</b>	<b>0.48</b>	<b>0.05</b>

TABLE NO. 1.4 CLASSIFICATION MATRIX (AUTO ANCILLARIES - OTHERS)

Year	As per CR and LR		As per Discriminant score	
	Good	Poor	Good	Poor
2004-05	17	23	13	27
2005-06	16	24	18	22
2006-07	18	22	17	23
2007-08	18	22	18	22
2008-09	20	20	21	19
2009-10	19	21	18	22

2010-11	16	24	14	26
2011-12	17	23	18	22
2012-13	17	23	20	20
2013-14	17	23	18	22

**Source: Computed from the Annual Reports of the Indian Automobile Industry**

As per the rule the selected Others sector falling in the good and poor risk groups are presented in Table No. 1.1. The Discriminant Functions of the selected years are presented in Table No. 1.2, where the Co-efficient for 'a' and 'b' indicates values for Current and Quick Ratios respectively. It is evident from the table that the Current Ratio appeared to be stronger than the Liquid Ratios during the year 2004-05 to 2013-14. The Table No. 1.3 presents the data relating to the Discriminating Score of both the groups. The good risk companies as indicated by Z value are Auto Ignition Limited, Auto Line Industries Limited, Banco Products (India) Limited, Brakes India Limited, Fiem Industries Limited, JBM Auto Limited, LG Balakrishnan and Bros. Limited, Lucas Indian Services Limited, Lumax Automotive System Limited, Lumax Auto Technologies Limited, Munjal Auto Industries Limited, Spicer India Limited, Stanes Motor Parts Limited, Subros Limited, Suprajit Engineering Limited, Tractors Engineers Limited, Triton Valves Limited and Varroc Engineering Private Limited in 2006-07, Auto Line Industries Limited, Brakes India Limited, Fiem Industries Limited, Jay Ushin Limited, JBM Auto Limited, LG Balakrishnan and Bros. Limited, Lucas Indian Services Limited, Lumax Automotive System Limited, Lumax Auto Technologies Limited, Rico industries Limited, Schrader Duncan Limited, Sharda Motor Industries Limited, Spicer India Limited, Stanes Motor Parts Limited, Subros Limited, Sun Beam Auto Private Limited, Suprajit Engineering Limited, and Swaraj Automotives Limited in 2007-08, Auto Ignition Limited, Bharat Seats Limited, Brakes India Limited, Canara Workshops Limited, CMH Tools Limited, Harita Seating Systems Limited, Johnsons Control India Private Limited, KEW Industries Limited, Lucas Indian Services Limited, Mipco Seamless Rings (Gujarat) Limited, Rico Auto Industries Limited, Schrader Duncan Limited, Sharda Motor Industries Limited, Spicer India Limited, Sun Beam Auto Private Limited, Swaraj Automotives Limited, TML Drivelines, Tractors Engineers Limited, Triton Valves Limited and Victor Gaskets India Limited in 2008-09, Canara Workshops Limited, Johnson Controls India Private Limited, KEW Industries Limited, LG Balakrishnan and Bros. Limited, Lumax Automotive Systems Limited, Mipco Seamless Rings (Gujarat) Limited, Perfect Circle India Limited, Rico Industries Limited, Schrader Duncan Limited, Sharda Motor Industries Limited, Spicer India Limited, Sunbeam Auto Private Limited, Suprajit Engineering Limited, Swaraj Automotives Limited, Talbros Automotive Components Limited, Varroc Engineering Private Limited, Victor Gaskets India Limited and WABCO India Limited in 2009-10, Alicon Castalloy Limited, Auto Ignition Limited, Canara Workshops Limited, CMH Tools Limited, Harita Seating Systems Limited, Jay Ushin Limited, LG Balakrishnan Bros Limited, Lumax Automotive Systems Limited, Mipco Seamless Rings (Gujarat) Limited, Perfect Circle India Limited, Remsons Industries Limited, Schrader Duncan Limited, Simpson and Company Limited, Stanes Motor Parts Limited, Suprajit Engineering Limited, Swaraj Automotives Limited, Talbros Automotive Components Limited, TML Drivelines, Varroc Engineering Private Limited and WABCO India Limited in 2012-13, Auto Ignition Limited, Auto Line Industries Limited, Banco Products (India) Limited, Bharat Seats Limited, Brakes India Limited, JBM Auto Limited, Johnson Controls India Private Limited, Lucas Indian Services Limited, Munjal Auto Industries Limited, Rico Industries Limited, Sharda Motor

Industries Limited, Spicer India Limited, Subros Limited, Sunbeam Auto Private Limited, Tractors Engineers Limited, Triton Valves Limited, Victor Gaskets India Limited and XLO India Limited in 2013-14. The rest of the companies are poor risk in all the years.

The number of good and poor risk companies as per the criteria of Current and Liquid Ratios and as per the Discriminant Scores are presented in Table 1.4. It is clear from the table that the misclassification occurs in all the years from 2004-05 to 2013-14. It means that there is a significant difference between the criteria of Current and Liquid Ratios and the criteria of Discriminant Scores in all the years. Generally, companies with lower Current and Liquid Ratios in the good risk groups and the companies with higher Current and Liquid Ratios in poor risk group have been misclassified under the criteria of Discriminant Score. It is also inferred that the poor risk companies under the criteria of Current and Liquid Ratios appeared to be good risk under the criteria of Discriminant Score. Such companies are Auto Ignition Limited, Auto Line Industries Limited, Banco Products (India) Limited, Brakes India Limited, Fiem Industries Limited, JBM Auto Limited, LG Balakrishnan and Bros. Limited, Lucas Indian Services Limited, Lumax Automotive System Limited, Lumax Auto Technologies Limited, Munjal Auto Industries Limited, Spicer India Limited, Stanes Motor Parts Limited, Subros Limited, Suprajit Engineering Limited, Tractors Engineers Limited, Triton Valves Limited and Varroc Engineering Private Limited in 2006-07, Auto line Industries Limited, Brakes India Limited, Fiem Industries Limited, Jay Ushin Limited, JBM Auto Limited, LG Balakrishnan and Bros. Limited, Lucas Indian Services Limited, Lumax Automotive System Limited, Lumax Auto Technologies Limited, Rico Industries Limited, Schrader Duncan Limited, Sharda Motor Industries Limited, Spicer India Limited, Stanes Motor Parts Limited, Subros Limited, Sun Beam Auto Private Limited, Suprajit Engineering Limited, and Swaraj Automotives Limited in 2007-08, Auto Ignition Limited, Bharat Seats Limited, Brakes India Limited, Canara Workshops Limited, CMH Tools Limited, Harita Seating Systems Limited, Johnsons Control India Private Limited, KEW Industries Limited, Lucas Indian Services Limited, Mipco Seamless Rings (Gujarat) Limited, Rico Auto Industries Limited, Schrader Duncan Limited, Sharda Motor Industries Limited, Spicer India Limited, Sun Beam Auto Private Limited, Swaraj Automotives Limited, TML Drivelines, Tractors Engineers Limited, Triton Valves Limited and Victor Gaskets India Limited in 2008-09, Canara Workshops Limited, Johnson Controls India Private Limited, KEW Industries Limited, LG Balakrishnan and Bros. Limited, Lumax Automotive Systems Limited, Mipco Seamless Rings (Gujarat) Limited, Perfect Circle India Limited, Rico Industries Limited, Schrader Duncan Limited, Sharda Motor Industries Limited, Spicer India Limited, Sunbeam Auto Private Limited, Suprajit Engineering Limited, Swaraj Automotives Limited, Talbros Automotive Components Limited, Varroc Engineering Private Limited, Victor Gaskets India Limited and WABCO India Limited in 2009-10, Alicon Castalloy Limited, Auto Ignition Limited, Canara Workshops Limited, CMH Tools Limited, Harita Seating Systems Limited, Jay Ushin Limited, LG Balakrishnan Bros Limited, Lumax Automotive Systems Limited, Mipco Seamless Rings (Gujarat) Limited, Perfect Circle India Limited, Remsons Industries Limited, Schrader Duncan Limited, Simpson and Company Limited, Stanes Motor Parts Limited, Suprajit Engineering Limited, Swaraj Automotives Limited, Talbros Automotive Components Limited, TML Drivelines, Varroc Engineering Private Limited and WABCO India Limited in 2012-13, Auto Ignition Limited, Auto Line Industries Limited, Banco Products (India) Limited, Bharat Seats Limited, Brakes India Limited, JBM Auto Limited, Johnson Controls India Private Limited, Lucas Indian Services Limited, Munjal Auto Industries Limited,

Rico Industries Limited, Sharda Motor Industries Limited, Spicer India Limited, Subros Limited, Sunbeam Auto Private Limited, Tractors Engineers Limited, Triton Valves Limited, Victor Gaskets India Limited and XLO India Limited in 2013-14. It is to be noticed that the number of good risk companies as per the criteria of Discriminant Score is more than the number of good risk companies as per the criteria of Current and Quick Ratios in the year 2005-06, 2008-09, 2011-12, 2012-13 and 2013-14. The remaining years the number of good risk companies as per the criteria of Discriminant Score is less than the number of good risk companies as per the criteria of Current and Quick Ratios.

### **Findings**

The number of good risk companies as per the criteria of Discriminant Score is more than the number of good risk companies as per the criteria of Current and Quick Ratios in the year 2005-06, 2008-09, 2011-12, 2012-13 and 2013-14. The remaining years the number of good risk companies as per the criteria of Discriminant Score is less than the number of good risk companies as per the criteria of Current and Quick Ratios.

### **CONCLUSION**

The study result shows that as per Discriminant analysis, repaying capacity was good in Auto Ancillaries Others sector. It is more important for on-going concerns. It is necessary for all companies either small or large because it means collecting cash from customers in time so that having no difficulty in paying short term debts. Auto ancillaries sectors are rising continuously. It should continue the importance given to this industry to have a better growth of our economy.

### **REFERENCES**

1. Burton A. Kolb, "Principles of Financial Management", 1983, Texas: Business Publications, Inc., p.153.
2. Maurice Joy O. and John O. Tollesfson, "On the Financial Applications of Discriminant Analysis", The Journal of Financial and Quantitative Analysis, December 1975, pp. 723-739.
3. Walter J.E., "A Discriminant Functions for Earnings Price - Ratios of Large Industrial Corporations, Review of Economics and Statistics, 1959, Vol., XLI, pp. 44-52.
4. Pandey I.M., "Financial Management", 2013, Vikas Publishing House Pvt Ltd., New Delhi.

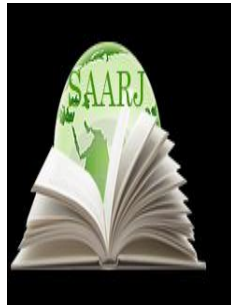

DOI: **10.5958/2249-7137.2021.01300.8**

## TRANSPORT AND ROAD CONSTRUCTION ISSUES IN BUKHARA

J. J. Majidov\*

\*A lecturer of the Department of World History  
Bukhara State University,  
UZBEKISTAN

### ABSTRACT

*This article deals with the state of transport and communication systems in Bukhara region in the 50s of the XX century, future projects, measures taken and the elimination of problems and shortcomings.*

**KEYWORDS:** *Transport Structure, Roads And Bridges, Railways, Freight, Passenger Traffic, Motorcade, Bus Depot, Auto Inspection Office, Road Technical School, Village Council, Railway Station, Bus Stop, Bukhara Haqiqati Newspaper, Road Management, Uzkhloptrans.*

### INTRODUCTION

Over the past century, in almost all countries of the world, a lot of news and engagements have been achieved for the household lifestyle of the population. Of course, this is a practical achievement in the field of Science and technology, as well as the evasion of many economic resources.

In the years of Soviet power, the transport sector has become one of the most important sectors of the economy in all republics. The development of this area as the only transport network of the country was carried out on the basis of Technical Reconstruction of all types of transport. In particular, many species of Wormwood were created anew [1].

It makes specific demands on the transport sector, where the country's economy is growing from year to year. First of all, they had to carry out economic and cultural relations inside the country, establish relations with socialist and capitalist countries.

### MATERIALS AND METHODS

Public transporting network in 1970 year (without taking into account sea routes) 1485,5 thousand km.ni made up. From this, the length of exploitation of Railways 135,2 thousand km.ni,

the length of the exploited River roads - 137,8 thousand km.ni and highways with a hard coating 511,6 thousand km.ni made up. [2].

The decree of the Soviet of Ministers of the USSR № 274 “On measures to improve transport roads in the rural areas and develop telephone communications” dated 18 April 1972 also sets out a number of tasks on the development and improvement of the sphere. In particular, the state agency for architecture under the Ministry of construction (Gostroy(State building)) is assigned special tasks.

This construction and repair work is planned to be carried out in the remote regions of all republics. The purpose of this was to develop the nation-economy by creating convenience for the movement of vehicles of all types, including public transport, trucks, agricultural machinery and other of these types.

During this period, among all the regions of the USSR, Uzbekistan could not fully meet the socio - economic needs of the population, although specific work was carried out in Bukhara in this regard. In particular, the report of the chairman of the Permanent Commission of people's Deputies of Bukhara region on transport, road construction and communications issues, dated 28 March 1978, cites a number of figures related to the sphere. In January 1978, the state was 17186 km highway in the region. It was noted that these roads are of general importance, Republican and regional importance, and most of them do not adequately meet the requirements of road traffic. Only one Zarafshan moves 15000 cars during 1 day at a large road (highway). But the road is designed for 3-4 thousand cars. Very difficult situation occurred on local highways, 14428 km of the road with a total length of 11966,2 km still has no coverage at all. Local road construction organizations are able to build a road 150-200 km per year [3].

## RESULTS AND DISCUSSIONS

According to the proposals and recommendations issued by the Permanent Commission, a number of letters were sent to the ministries of the Republic and higher organizations. Relevant recommendations have also been developed by the commission to improve passenger transportation activities.

In the case of January 1, 1978, there were 40282 cars in the region, including 1819 light cars, 1441 buses, 12202 trucks, 21173 private light cars [4].

The analysis of auto-maintenance work showed that the quality of the use of cars was incredibly low. From the analysis of the 2-month activity of the regional highway, it is known that the use of the lorry park has 0,66%, the bus 0,69%, the taxi 0,75%. It remains to be said that the public authorities have not always fulfilled their duties in full. GAI(State Road Controlling Inspection) staff noted that there have been increasing cases of gross violations of the traffic rules of many motor vehicle drivers. This suggests that there are many unresolved problems related to the industry.

When analyzing the existing problems in the railway, it was recognized that the work on increasing and unloading was not systematic, the construction of freight yards was going very slowly, the repair of roads was stopped for object and subject reasons, in the summer season the population was suffering from obtaining tickets, in particular, such a situation was observed on trains in Moscow [5].



Analysis by the Permanent Commission shows that many problems of these areas remain on the Whirlpool, which in turn is characterized by the fact that the issue of personnel is also difficult. The lack of personnel landing, that is, the constant migration of specialists of the field from one place to another, has become one of the main factors of similar problems. This was done with the aim of establishing new sovkhos (state farms), new population localities and establishing communication systems there. And this process is constantly repeated. Only by the 80-ies there are cases of stabilization in a certain sense.

In addition, some aspects that are noteworthy from the time of the former Union in Bukhara can be cited as an example of the following measures carried out in the PRC in this area.

When the press agencies of the BKHSR are acquainted with the large number of newspapers "Bukhoroakhbori(Bukhara reports)" and "OzodBukhoro(Free Bukhara)", which were published in 1920-1924, it is possible to get information about the vehicles of these years and their types, activities and ways of Transportation. It is noted that the domestic vehicles of that period were used as horses, cars, Foxes. It is stated in the news that the government agencies need to register horse-drawn carriages and foyers in the Republic, to carry out cargo transportation works, and to bring them to the disposal of the shipping company [6].

On 11 December 1, 1920 issue of the newspaper "Bukhoroakhbori(Bukhara reports)" published the 7-digit order of the Republican control of dohilia (internal affairs). This order consists of 2 paragraphs, and in Paragraph 1 it is written that whoever runs a horse in cities and does not care in opposition to the militia will be punished according to the law, paragraph 2 says that it is possible to run a horse only if there is a fire somewhere in an emergency or if there is an incident. The order was signed by the minister of dohilia Abdulhamid Oripov and the Head of General Affairs Riza Ali.

In the data of the newspaper it is written that the streets of Bukhara City are narrow, in the evenings some streets are dark and it is impossible to pass because of stagnant water. This has led to the fact that frequent emergency adverse events occur.

In the 1922 Year issue of the "Bukhoroakhbori(Bukhara reports)" published a lot of reports on the construction of road facilities and their regulation. In them, issues of Correction of roads on which cars and foothills walk, digging wells that store water along the roadways, construction of bridges are emphasized [7].

In 1923, the government paid special attention to the problem of repairing the Kagan-Bukhara Stone Road. According to information released during this year's issue of OzodBukhoro(free Bukhara), a significant amount of funding measures have been taken to correct the Stone Road between Kagan-Bukhara and launch the vehicle. It is reported that 1.933.822 soums have been spent from the government for this purpose [8], 55.000 soums have been given with gold to complete this work, [9] in addition 10.400 soums have been collected, 1000 soums have been allocated [10] by the Economic Council.

Kagan (new Bukhara)-the government paid special attention to the correction of the Kagan-Bukhara Rock Road, as it was the main railway station where goods from the states of the army were brought to the Republican Center and the goods were sent to Bukhara. From the owners of horse-drawn carriages and foytun, who use this road, that is, passing by, the road tax was levied, the accumulated funds were spent on the laying of stones.

During the years of the BKHSR, the activities of the railway connecting the former Bukhara emirate with Tsarist Russia continued, the repair of cattle-breeding, Kagan-Termez routes and railway lines of the Bukhara Railway, the continuous establishment of postal, telegraph, railway activities were also given attention [11]. Getting acquainted with the materials of the newspaper, we can imagine that the railway tracks were broken due to military actions of 1921-1922 years (armed struggle against the Red Army), there is no possibility of establishing a regular transport route between the regions. In one of the messages of the newspaper "OzodBukhoro(Free Bukhara)": "Until the book-Shahrisabz-Termiz, the divided railways were fixed. Termez-Shahrisabz has raised \$ 2 million in gold to fix this railway. The sum is assigned" [12] quota;

In 1923-1924, with the aim of connecting the regions and districts of the Republic with the capital Bukhara, the tasks related to the construction and commissioning of internal railways were put on the agenda. In the autumn of 1923, the issue of construction of the Bukhara-Vobkent-Gijduvon railway was raised. [13] Efforts have been made to link the Karakul districts with the center (Kagan Station), except for Gijduvan, Vobkent [14]. But these things have remained on the drawing board.

By the end of the year 1923, Bxsr had a relatively stable period. As a result, the construction of Behbudiy (Karshi)-Kitab, Behbudiy-Guzar Railways was initiated. "Behbudiy-the book was given 450.000 sum by the Government of Bukhara [15] for the railway", - writes "free Bukhara". "From September 2, 1924 to 24, the Behbudiy-Guzar Railway, which was called Behbudiy-Guzar, was launched and the population was saved from horse riding and Arab walking during the time of famine. Relations with Guzar and East Bukhara have become easier," [16] a second source said.

## CONCLUSION

Practical activities, such as drawing up a schedule of domestic railways that were partially commissioned, setting the time for the movement of trains and steam locomotive, were also carried out and announced to the public through the newspaper.

## REFERENCES:

1. Transport and communications of the USSR. Static collection 3-st. M. 1972
2. Transport and communications of the USSR. Static collection 4-st. M. 1972
3. State archive of Bukhara region 1023 -foundation, list 1, collection 661, page 87
4. State archive of Bukhara region 1023 -foundation, list 1, collection 661, page 925.
5. State archive of Bukhara region 1023 -foundation, list 1, collection 661, page 94
6. Command №1. By the Department of Transportation. Bukhara news. Number 3. September 29, 1920; Order by the Department of Transportation. Number 8. November 21, 1920.
7. The roads are paved. Bukhara news. Number 100. September 21, 1922; About road constructions. Bukhara. 107-issue October 2, 1922.
8. Kagan-Bukhara highway. Bukhara. No. 207. Sept. 28, 1923;
9. For Kogon-Bukhara. Ozod Bukhara. No. 22. December 11, 1923;
10. Money for Kagan-Bukhara highway. Ozod Buxoro. 112-issue. July 9, 1924.

11. Order 19 by the MIQ of the ICC. Bukhara. Number 8. November 21, 1920; Negotiations between the Russian Socialist Republic and the CSTO. Bukhara. 11-son. December 1, 1920.
12. A new step in the development of the national economy: Railways. Do we have railways? Railways will be repaired. Ozod Bukhara No. 63. March 17, 1924.
13. Bukhara-Vobkent-Gijduvontemiryoli. Bukhara. 205-issue. Sept. 23, 1923;
14. Narrow-gauge railways. OzodBuxoro. No. 78. April 17, 1924.
15. Behbudi-Kitobtemiryoli. OzodBuxoro. No. 111. July 6, 1924.
16. The railroad was opened. OzodBuxoro. 145-issue. Sept. 26, 1924; Reward for the residents of the Karshi-Guzart railway. OzodBuxoro. 151-issue. Oct. 14, 1924.
17. Arrival and departure of trains. OzodBuxoro. 110-son. July 5, 1924.
18. Rayimovich, AbdukayumovAsror. "EARLY SETTLEMENTS OF CENTRAL ASIA AS A FACTOR OF FORMATION OF FIRST SOCIETIES (ON EXAMPLE OF THE SETTLEMENT OF SARAZM)." European science review 5-6 (2020).
19. Isayev, O. (2019). THE CULTURAL LIFE IN SURKHAN OASIS: INFORMING OF ACHIEVEMENTS AND PROBLEMS BASED ON ARCHIVAL MATERIALS (1925–1941 YEARS). The Light of Islam, 2019(4),
20. Bakiev, Anvar, and ZubaydaYuldasheva. "THE FIFTH CIVILIZATION OF THE ANCIENT EAST." Theoretical & Applied Science 8 (2020): 39-45.
21. Kushakov, S., &Akhmedov, S. (2021). The Ethnic History And Composition Of Uzbek People: On The Example Of Two Languages, Settlement And Livestock Tribes. The American Journal of Interdisciplinary Innovations and Research, 3(02), 24-27.
22. Abdulloev, S. B. (2021). Positive Attitudes To" Dev" In Central Asian People. The American Journal of Social Science and Education Innovations, 3(01), 275-279.
23. Yusupovich, K. S. (2020). The Emergence Of Religious Views Is Exemplified By The Southern Regions. The American Journal of Social Science and Education Innovations, 2(10), 143-145.
24. Orziyev, Mahmud Zayniyevich, and BakhshandBakhodirovnaYunusova. "Difficult ways edifying education." European Conference on Education and Applied Psychology. 2014.
25. Orziev, MakhmudZayniyevich, and AmonkeldiKhasanovichAkhmatov. "THE CHANNEL FROM SIRDARYA TO BUKHARA: TRUTH OR FRAUD." Scientific reports of Bukhara State University 3.1 (2020): 234-239.
26. Orziev, Mahmud Zayniyevich. "THE SECOND WORLD WAR AND THE UNOPENED AFGHAN FRONT." Scientific reports of Bukhara State University 4.3 (2020): 243-249.
27. Орзиев, МахмудЗайниевич. "МАТЕРИАЛЬНАЯ ПОДДЕРЖКА ТИПОГРАФИИ, СОЗДАННОЙ В БУХАРСКОМ ЭМИРАТЕ." Россия-Узбекистан. Международные образовательные и социально-культурные технологии: векторы развития. 2019.
28. Алламуратов Ш.А.История амударьинского судостроения // Бюллетень науки и практики. 2020. Т. 6. №10. С. 422-429.

- 
29. Allamuratov S.A. THE ROLE OF THE AMUDARYA FLEET IN THE ECONOMIC LIFE OF THE EMIRATE OF BUKHARA AT THE END OF THE 19TH CENTURY-THE BEGINNING OF THE 20TH CENTURY //Ўтмишганазаржурнали. – 2019. – Т. 21. – №. 2
  30. Allamuratov, Sh.A. (2020). The role of the Amudarya waterway and the Surkhan oasis crossings in trade relations of the Emirate of Bukhara. Actual problems of modern science, education and training. Vol. 5, Issue 1, October. (in English).
  31. AllamuratovShukhratAshurovich. CRAFT AND TRADE RELATIONS IN EASTERN BEKS OF THE BUKHARA EMIRATE. ACADEMICIA: An International Multidisciplinary Research Journal. Vol. 11, Issue 2, February 2021
  32. Buronov A. K. Uzbekistan In The New Era Of Trade Union Development (2016-2020) //The American Journal of Social Science and Education Innovations. – 2021. – Т. 3. – №. 01. – С. 294-297
  33. Uktamovna, Y. D. (2020). The Effect Of The Russian Empire On The Political Life Of The Emirate Of Bukhara (1868-1917). The American Journal of Social Science and Education Innovations, 2(10), 171-177

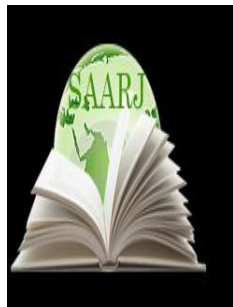

**ACADEMICIA**  
**An International**  
**Multidisciplinary**  
**Research Journal**  
 (Double Blind Refereed & Peer Reviewed Journal)



**DOI: 10.5958/2249-7137.2021.01301.X**

## HOW TO USE OF VIDEO FILMS IN THE CLASSROOM

**Yulduz Sayitmurodovna Sattorova\***

\*English Teacher of Intercultural Communication and Tourism Department,  
 Tashkent State University of Uzbek Language and Literature,  
 UZBEKISTAN

---

### ABSTRACT

*The need of increasing interest in the subject and to broaden horizons of learners, we use video films in teaching foreign languages. While watching videos in a foreign language, students make a conversation and hot discussions over the film. Additionally, they listen to the speech of native speakers and learn the history, culture, and geography of the country as well.*

**KEYWORDS:** *Motivation, Video Material, Subtitles, Listening Skills*

---

### INTRODUCTION

One of the main tasks of teaching a foreign language is the development of students' speaking skills. Mastering this type of activity is associated with great difficulties due to the complexity of the very process of generating a speech utterance. To create motivation for communication in a foreign language in educational conditions, it is necessary to use the situation, and need them to speak. In order to increase interest in the subject, as well as broaden horizons, it is advisable to show video films. In the process of watching videos in a foreign language, such conditions are created when students are encouraged to make a conversation and a discussion.

In addition, they listen to the speech of a native speaker and learn with the history, culture, and geography of the country. Taking into account the duration of a feature film, which is an average of 1.5 hours, the enormous language material, the difficulty of understanding its form and content, the use of the entire feature film is ineffective.

### MATERIALS AND METHODS

It is more productive to work with passages containing dialogues and monologues as models of speech-behavioral acts.

- the use of subtitles in different languages;
- combination of languages using sound and subtitles;

- instant access to any fragment of the film;
- slowing down the pace of video and audio playback;
- acceleration of the pace of video and audio playback.

It should be noted that the use of a video film in the lesson is one of the important forms of teaching a foreign language as the video sequence complements the audio and contains such important non-verbal information as facial expressions, articulation, gestures, etc. communications. This is due to the fact that spontaneous speech is largely mediated by external factors that affect both the topic of the conversation and the linguistic means used by the communicants. The study of listening processes shows that even when listening to a text twice without visual support, the level of understanding is significantly lower than when unambiguously perceiving a video document.

One of the main characteristics that affect the success of listening is the rate of speech, directly affects the amount of audited information. Thus, the lower the rate of speech, the easier it is to understand it; the higher, the more difficult it is. In the process of using authentic video and audio documents, as a rule, there are no problems with understanding the general meaning. The difficulty lies in the completeness and accuracy of understanding the audio text. To ensure the most complete understanding of the audited document, it is recommended to reproduce it repeatedly (5 or 6 times, if necessary) in order to master all its elements. It is also recommended to carry out pre-text work, which in practice means that the teacher eliminates grammatical, lexical and phonetic difficulties before listening to or viewing the document, in order to relieve language difficulties.

The most important criterion in the study of a foreign language is considered to be the listening comprehension of a foreign language authentic colloquial speech, that is, speech characteristic of native speakers. Unlike audio or printed text, which can have a high informative, educational, educational and developmental value, video text has the advantage that it combines various aspects of the act of speech interaction. In addition to the content side of communication, the video text contains visual information about the place of the event, the appearance and non-verbal behavior of the participants in communication in a particular situation, often due to the specifics of the age, gender and psychological characteristics of the personality of the speakers. The visual range allows you to better understand and consolidate both factual information and purely linguistic features of speech in a specific context.

Video materials provide almost unlimited opportunities for analysis based on comparing and contrasting cultural realities and characteristics of human behavior in various situations of intercultural communication (provided that the selected video texts provide the necessary basis for such a comparison). It is also obvious that the video can have a strong emotional impact on teachers, serve as a stimulus and reinforcement to create additional motivation in further educational, search and creative activities.

The conditions of real communication in a foreign language presuppose the use of all the wealth of the native language, including all the features of an informal conversational style, by a foreign language partner, taking into account the fact that each person has his own individual manner of speech. Thus, communication with a foreign language interlocutor occurs due to the possession of the foreign language learners in a complex of speech, grammatical, phonetic, lexical skills and

abilities of various levels. It should be kept in mind that at the productive and receptive levels, it is necessary to master the auditory skills to perfection.

The effectiveness of using a video film in teaching speech depends not only on the precise definition of its place in the teaching system, but also on how rationally the structure of the video lesson is organized, how the educational capabilities of the video film are coordinated with the learning objectives. In the structure of a video lesson for teaching oral speech, four stages can be distinguished:

- ✓ preparatory - the stage of preliminary removal of language and linguistic regional difficulties;
- ✓ video perception - the development of information perception skills;
- ✓ control of understanding of the main content;
- ✓ development of language skills and oral skills

To solve each of the tasks, students must know not only the general content of the video, but also remember the details, as well as be able to evaluate events, characterize the characters, using words and expressions from the speech accompaniment of the video.

The use of a video film contributes to the development of various aspects of the mental activity of students, and above all - attention and memory. During viewing in the audience (classroom), an atmosphere of joint cognitive activity arises. Under these conditions, even an inattentive student becomes attentive. In order to understand the content of the film, students need to make some effort. And the intensity of attention affects the memorization process. The use of various channels of information flow (auditory, visual, motor perception) has a positive effect on the strength of capturing regional and linguistic material.

## CONCLUSION

Summarizing the above, it can be argued that educational video courses and animations open up ample opportunities for active work in the process of developing speech skills and abilities of students and make the educational process of mastering a foreign language attractive for students at all stages of learning.

The use of video in a foreign language lesson and in extracurricular activities opens up a number of unique opportunities for the teacher and students in terms of mastering a foreign language culture, especially in terms of the formation of socio-cultural competence as one of the components of communicative competence in general.

## REFERENCES:

1. Stempleski, S. (2002). Video in the ELT classroom: The role of the teacher. *Methodology in language teaching. An anthology of current practice*, 364-367.
2. Cakir, I. (2006). The use of video as an audio-visual material in foreign language teaching classroom. *Turkish Online Journal of Educational Technology-TOJET*, 5(4), 67-72.
3. Verisokin Yu.I. Video film as a means of motivating schoolchildren in teaching a foreign language // *Foreign languages at school*. - 2003. - No. 5. - p. 31-35.
4. Ilchenko E. Using video in English lessons // *English language*. - 2003. - No. 9. - p. 7-10.

5. Muhamadjonovna, S. D. (2020). A Set Of Methodological Tools For The Formation Of Sociolinguistic Competence Of Future English Teachers. *The American Journal of Social Science and Education Innovations*, 2(12), 298-302.
6. Sarimsakova, D. (2017). Station Rotation. *English Teaching Professional*, 109.





**ACADEMICIA**  
**An International  
 Multidisciplinary  
 Research Journal**  
 (Double Blind Refereed & Peer Reviewed Journal)



**DOI: 10.5958/2249-7137.2021.01302.1**

## **DERIVATIVES MARKET: WORLD TRENDS AND DEVELOPMENT PROSPECTS**

**Orifjonova Mukhlisa Alisher kizi\***

\*Master's Degree Student,  
 University of World Economy and Diplomacy,  
 UZBEKISTAN

### **ABSTRACT**

*The article analyzes the problems of the development of the world derivatives market, which in the recent post-crisis years has increased its turnover to catastrophically huge parameters, significantly exceeding world GDP. This casts doubt on the reliability of the global financial system, since the overwhelming majority of these financial instruments are traded on the over-the-counter market and therefore are not subject to any regulation or control. The solution to these problems is associated, in the author's opinion, with the creation of a unified standardized system of exchange turnover of all types of derivative financial instruments, which should bring the volume of issued derivatives and real underlying assets in line with them.*

**KEYWORDS:** *Derivatives, Financial Market, Risk Hedging, Exchange And Over-The-Counter Turnover, World Financial System, Banks, Stock Exchanges.*

### **INTRODUCTION**

The protracted nature of the last financial crisis, which began in 2007, demonstrated the emergence of a new threat to the development of the global financial system - the uncontrolled growth of the derivatives market. Having become the cause of the crisis, derivatives came into conflict with their economic essence as an instrument of insurance and hedging of risks in the financial market. The factor of unrestricted growth of this market is the absence of state control over the issue and circulation of these financial instruments, as well as the transition of a significant part of the market to over-the-counter circulation. In this regard, the relevance of the study of modern world trends in the derivatives market and the directions of their development is increasing, which would make it possible to develop directions for regulating this segment of the financial market.

---

**Place of the derivatives market in the structure of the financial market**

When considering the market economy as a set of different markets, it is possible to single out the leading role in it of the financial market, since it is it that provides the possibility of a consistent flow of capital from one country to another, from less profitable sectors of the economy to more profitable ones. Thus, the financial market ensures the redistribution of capital between sectors of the economy and helps to level the sectoral rate of return.

The transformation of free capital into investments takes place through the stock market, in the structure of which the segment of financial derivatives (derivatives) has recently become dominant. It was developed in connection with the liberalization of the world financial system and the transition to floating exchange rates. The widespread popularity of derivatives as derivatives from stocks, currencies and commodities is due to the fact that they are used to hedge risks or engage in speculation.

If earlier derivative financial instruments acted as a standard instrument issued by an exchange, now the derivatives market is developing in two forms - exchange and over-the-counter, and the competition between these two segments of the stock market serves as an additional incentive for the development of the derivatives market, which is due to the emergence of, along with standard exchange contracts for new types of over-the-counter agreements containing special conditions for insuring the risks of trading participants.

**Research methodology of the modern derivatives market**

The issues of the development of the world derivatives market are widely reflected in the works of foreign and domestic economists. The fundamentals of the development of financial derivatives are set out in the fundamental work of W. Sharp "Investments", which reveals their nature and mechanisms of circulation [1]. With regard to Russian practice, derivative financial instruments are considered in detail by A.N. Burenin, who analyzed not only their types, but also the peculiarities of circulation on the Russian securities market [2].

The greatest attention is paid to the development of the world derivatives market after the 2007 crisis. The rapid development of this market is associated with a change in the role of underlying assets (oil, gold, grain, etc.) that underlie derivative financial instruments, namely, a significant increase in their trading volume [ 3. P. 149]. S.S. Samsonova believes that the growth of the over-the-counter turnover of these financial instruments in the post-crisis period is already 10 times higher than the nominal value of their basic assets [4. P. 71]. According to G.G. Chibrikov, the preponderance of derivatives on the world financial market in comparison with other instruments becomes the cause of financial crises, the overcoming of which he associates with the need to reduce the growth in the volume of these instruments [5. P. 11].

The point of view of K.L. Astapov on the methodology for regulating the over-the-counter circulation of derivatives [6. C. 60], proposing to introduce universal principles of investor protection, which, in his opinion, should reduce conflicts of interest and prevent market manipulation. He also believes that the creation of a system for the exchange of information between different states, which does not undermine the national banking secrecy, will help to streamline the circulation of derivatives in the global financial market. Thus, the majority of scholars studying the circulation of derivatives are concerned about the uncontrollable growth of the volume of these financial instruments and are looking for ways to regulate their circulation.

### **Features of the development of the derivatives market in the post-crisis period**

The modern derivatives market is developing as an independent segment of the stock market, and thanks to the circulation of these financial instruments outside the exchange, they have the opportunity to circulate in unlimited quantities and be issued on various basic assets, including stock indices and other calculated indicators. At the same time, the main trends in the development of the financial derivatives market are largely determined by the ongoing changes in the post-crisis period in the markets of basic assets. Thus, the multiple growth in the trading volume on the stock market entailed an equally rapid development of the market for standard contracts for stocks and stock indices. At the same time, the derivatives market continues to grow at a faster pace compared to other financial instruments, and this creates volatility on stock exchanges.

### **Derivatives as a crisis mechanism**

The main reason for the global economic crisis in 2007 and the subsequent recession in the economies of most countries was the inflated “bubble” in the US derivatives market. In the event of a series of non-payments and refusals to execute contracts, derivatives gave rise to a domino effect: the collapse of one instrument led to the fall of others. Following this, the development of the crisis in the Eurozone pushed the speculative nature of credit default swaps issued on debt obligations of the Greek government, which significantly intensified the manifestation of the crisis in the global financial system.

In the emergence of the crisis, derivatives played the role of a trigger, which is associated with the peculiarities of the circulation of this financial instrument. In essence, derivatives should create hedging instruments and infrastructure for market participants to reduce the overall volume of risk through its redistribution. In other words, the derivatives market should theoretically serve as additional support or insurance for business associated with the real movement of goods or capital.

In practice, in the last decade, there has been a huge gap between speculative players in this market and companies that really hedge the risks of their core activities. This is reflected in the fact that derivatives, in fact, began to circulate independently of the movement of goods that lie in their underlying asset. As a result, their turnover went beyond the national economies, since these instruments no longer participate in the formation of the domestic capital of countries where the goods underlying the underlying assets are produced.

In short, all threats to the development of the derivatives market for the global financial system can be formulated as follows:

- The market has become too large and does not stop growing;
- derivatives as financial instruments are not secured by anything;
- the system of derivatives circulation is almost completely uncontrollable;
- this system is dominated by the largest banks in the world;
- The uncontrolled (unregistered) and non-transparent issue of new forms of derivative financial instruments is constantly taking place;
- The derivatives market is developing in isolation from the real economy.

### **Problems of derivatives market regulation**

Due to the presence of a pronounced upward trend in financial derivatives, caused by an increase in the number of participants and the volume of attracted capital, the derivatives market needs urgent regulation. According to experts, measures to regulate the derivatives market can develop in two directions: first, through tightening the legislation of the main countries participating in the derivatives market; secondly, in the absence of a positive effect of measures to regulate the derivatives market, it is proposed to zero the market by abandoning the main currencies that provide settlements for derivative transactions [8].

In September 2013, at the G20 Summit in St. Petersburg, the G20 countries agreed to tighten the rules for regulating the derivatives market. The G20 Summit Declaration [9] pointed to the need to establish common minimum margin requirements for derivatives trading and to form a centralized clearing system for derivatives transactions based on international consensus. According to the G20 recommendations, financial market regulators should ensure that high-risk assets are traded strictly through clearing centers and exchanges. It becomes obvious that international regulation should be aimed at limiting the emission of derivative financial instruments. It should be borne in mind that a direct ban on derivatives as a financial instrument is unlikely to have a positive effect, since the overwhelming majority of these instruments are traded on the OTC market. In this regard, it is the OTC derivatives turnover, especially interbank swap transactions, that should be subject to regulation. This presupposes the transfer of all transactions to the exchange circulation system, i.e. trading these instruments only on stock exchanges. This approach will eliminate the problem of conflicts of interest among participants in the derivatives turnover, when the same trading participant in one person acts as an issuer, seller and buyer. First of all, this should apply to the relationship between banks and their clients that make transactions with derivatives, which should be carried out only with the participation of a third independent party - an exchange or a clearing center, which provide guarantees for the fulfillment of obligations by all participants in this operation.

The latest financial crisis revealed the need for strict antimonopoly regulation of the activities of derivatives market participants, which is primarily associated with the need to eliminate the dependence of a significant share of world financial flows on the management of global American banks. So, during the last financial crisis after the collapse of the Lehman Brothers bank only on CDS default swaps there were debts of \$ 400 billion [10. P. 151]. The lack of control of global financial holdings allows them to ignore all principles of risk management and continue to issue on the market new highly speculative instruments that not only fail to reduce financial risks, but also contribute to their growth by including an unlimited number of new participants in these operations.

Consequently, the main problems of the modern derivatives market are generated by the liberalization of the terms of transactions, as well as the uncontrolled activity in this market of global financial institutions, which are the main suppliers of credit default swaps to the stock market. It is this segment that operates only in the over-the-counter market mode, which is based on opaque pricing and ineffective monitoring of risks, including the risk of solvency of credit protection sellers under CDS. However, other sectors of the derivatives market operating within the framework of exchange trading (options, futures, etc.) are more resistant to the crisis, since they operate under standard contracts and constant control by the exchange. In addition, banks' CDS risks are increasing due to the lack of a unified methodology for accounting for derivatives

on the balance sheets of credit institutions. At present, banks have the opportunity, due to tricks in the accounting of derivatives, not to fully reflect the risks and possible losses associated with their circulation. Today, this aspect is most in need of regulation. In this regard, the question of the mandatory introduction of unified standard rules for accounting for credit default swaps as a necessary condition for improving the turnover of derivatives by banks arises. In this regard, it is necessary to make a decision at the state level to prohibit operations with OTC derivatives for commercial banks, which should eliminate most of the risks associated with the circulation of these financial instruments.

From the point of view of improving the circulation of derivatives, two fundamental points should be highlighted. First, there is a need to create an analogue of a central depository for the purpose of accounting for derivative financial instruments, the activity of which can significantly facilitate and streamline transactions with all types of such instruments. Secondly, it is necessary to increase the role of self-regulatory organizations in the derivatives market, which could take on such issues as interaction with state regulatory bodies, resolving disputes between market participants, etc. There is already some experience in the world in terms of self-regulation of international circulation. securities, when the Association of International Stock Market Participants (ISMA) assumes responsibility for the formation of conditions and control over the circulation of international securities and the activities of market participants [11. P. 74].

Thus, minimizing the threat of the collapse of the global financial system lies in the plane of creating a system of regulation and control of the world derivatives market, which in modern conditions has prospects for implementation with the solidarity participation of the governments of countries whose banks are active emitters and buyers of derivative financial instruments.

#### REFERENCES:

- [1] Sharp U.F. Investicii / U.F. SHarp, G.Dzh. Aleksander, Dzh. Bejli: per. sangl. — M.: INFRA-M, 2007.
- [2] Burenin A.N. Forvardy, f'yuchersy, opciony, ehkzoticheskie i pogodnye proizvodnye. — M.: NTO, 2011.
- [3] Rubcov B.B. Global'nye finansovye rynki: masshtaby, struktura, regulirovanie // Vek globalizacii. — 2011. — № 2 (8).
- [4] Samsonova S.S. Mirovoj rynek vnebirzhevnyh derivativov: reforma i tekushchee sostoyanie // Finansovaya analitika. — 2014. — № 18 (204).
- [5] CHibrikov G.G. Finansovyy krizis i metody ego preodoleniya. — URL: <http://www.econ.msu.ru/cmt2/lib/a/1430/file/Chebrikov>
- [6] Astapov K.L. Razvitie rynka derivativov Rossijskoj Federacii v kontekste resheniya stran «Gruppy 20» // Den'gi i kredit. — 2013. — № 6.
- [7] Ezhegodnyj doklad Associacii uchastnikov f'yuchersnyh tovgov «The Futures Industry Association» Report on trading volume in the global listed derivatives markets. — URL: [http://www.futuresindustry.org/downloads/FIA\\_Annual\\_Volume\\_Survey\\_2013.pdf](http://www.futuresindustry.org/downloads/FIA_Annual_Volume_Survey_2013.pdf)
- [8] Snyder M. Derivatives: The Quadrillion Dollar Financial Casino Completely Dominated By The Big International Banks. — URL: <http://theeconomiccollapseblog.com/archives/derivatives>

---

[9] Deklaraciya sammita «Gruppy dvadcati» — Oficial'nyj sajt G20 v Sankt-Peterburge.—URL: <http://www.g20russia.ru/news/20130906/782776168.html>

[10] Petrenko E.V. Mirovoj rynek derivativov // Molodoj uchenyj. — 2011. — № 10. — T. 1.

[11] Blokhina T.K. Finansovye rynki: ucheb. posobie. — M.: RUDN, 2009. — 200 p.



**ACADEMICIA**  
**An International**  
**Multidisciplinary**  
**Research Journal**  
 (Double Blind Refereed & Peer Reviewed Journal)

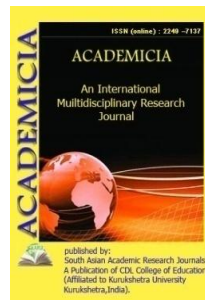

**DOI: 10.5958/2249-7137.2021.01303.3**

## THE EFFECTIVE WAYS OF DEVELOPING CRITICAL THINKING AND ITS ROLE IN TEACHING PROCESS

**Rabbimova Yulduz Karshiboy kizi\***; **Petrosyan Nelya Valerovna\*\***

\*2nd year master's student,  
 Faculty of Foreign Languages and Literature,  
 Samarkand State Institute of Foreign Languages,  
 UZBEKISTAN

\*\*Scientific Supervisor,  
 Teacher of the Department of English Language Teaching Methods,  
 Samarkand State Institute of Foreign Languages,  
 UZBEKISTAN

### ABSTRACT

*The technology for the development of critical thinking began to take shape in the 90s of the XX century. Critical thinking does not mean negative judgment or criticism, but judicious consideration of a variety of approaches in order to make informed judgments and decisions. An orientation towards critical thinking assumes that nothing is taken for granted. Each student, regardless of authority, develops his or her opinion in the context of the curriculum.*

**KEYWORDS:** *Critical Thinking, Technology For The Development Of Critical Thinking, Techniques For The Development Of Critical Thinking, Challenge, Comprehension, Reflection, Clusters, A Tree Of Predictions, Diaries And Logbooks, Thick And Thin Questions, Writing In A Circle, Marks In The Margins, Syncwine, Essay.*

### INTRODUCTION

Critical thinking is the ability to pose new questions, develop different arguments, and make informed decisions. The purpose of this technology is to ensure the development of critical thinking through the interactive inclusion of students in the educational process. Critical thinking promotes mutual respect between partners, understanding and productive interaction between people; makes it easier to understand different “world views”; allows students to use their knowledge to make sense of situations with a high level of uncertainty, to create a basis for new types of human activity.

The technology includes several stages:

Stage I "Challenge" (actualization of subjective experience).

Stage II "Comprehension".

Stage III "Reflection".

The first stage is challenge.

Her presence at every lesson is mandatory.

This stage allows:

- To actualize and summarize the student's knowledge on a given topic or problem;
- to arouse a steady interest in the topic under study, to motivate the student to educational activities;
- Formulate the questions to which we would like to receive answers; -To encourage the student to work actively in the classroom and at home [3].

At the stage of the call, the existing knowledge on the declared topic is updated, ie. even before acquaintance with the text (the text is understood as the written text, and the speech of the teacher, and the video material), the student begins to think about the specific material. At the first stage, motivation mechanisms are switched on, the goal is determined.

The second stage is comprehension.

There are other tasks here. This stage allows:

- To receive new information, to comprehend it;
- Related to existing knowledge;
- Search for answers to the questions posed in the first part [3].1

At the stage of comprehension, direct work with the text takes place - reading, which is accompanied by the student's actions: marking using the signs "v", "+", "-", "?" (as they read, they are put in the margins on the right), drawing up tables, searching for answers to the questions posed in the first part of the lesson, etc. As a result, students receive new information, correlate new and existing knowledge, systematize the data obtained. Thus, students follow their own understanding on their own.

The third stage is reflection. Here the main one is:

- holistic comprehension, generalization of the information received;
- Appropriation of new knowledge, new information;
- the formation of each of the students their own attitude to the studied material [1].

At the stage of reflection, information is generalized, the role of writing increases. Writing helps not only to understand the material and reflect on what has been read, but also to express new hypotheses. In the technology of developing critical thinking, different methods and techniques are used, which are used both at a certain stage and as a strategy for conducting the lesson as a whole. Let's take a look at some of them.



### Techniques for developing critical thinking

"Clusters". This is the selection of semantic units of text and graphic design in a certain order in the form of a bunch. Making some notes, sketches for memory, we often intuitively distribute them in a special way, arrange them into categories. Bunches are a graphic technique in the systematization of material. Thoughts are no longer piled up, but are arranged in a certain order. The principle is pretty simple. A model of the solar system is drawn: a star, planets and their satellites. In the center is a star - this is our theme, around it the planets are large semantic units, we connect them with a straight line with the star, each planet has its own satellites, and its own satellites. Clusters help students capture more information than could be obtained from regular writing work. This technique can be applied at the stage of calling, when it is necessary to organize information before acquaintance with the main source (text) in the form of questions or headings of semantic blocks. You can use this technique at the stage of reflection. This is a fix for the wrong assumptions in "Preliminary clusters", filling them in on the basis of new information, establishing causal links between individual semantic blocks (work can be carried out individually, in groups, on the whole topic or in separate semantic blocks) [2].

"Prediction tree". This technique helps to make assumptions about the development of the storyline in the story, novella. The rules for working with this technique are as follows: a tree trunk is a theme, branches are assumptions that are conducted in two main directions - "possible" and "probably" (the number of branches is not limited), and, finally, leaves are the justification of these assumptions, arguments in favor of one opinion or another. This technique also works well for the calling stage.

"Diaries" and "flight journals". These techniques are well suited for the reflection stage. In-flight journals are a generalized name for various teaching writing techniques, according to which students write down their thoughts while studying a topic. The logbook can be presented in the form of a table. 1:

What do I know about this topic?	What new have I learned from the text?

An interesting technique is the "Two-part diary". This technique allows the reader to connect the content of the text with his personal experience. Such diaries can be used when reading the text in class, but it is especially productive to work with them at home when a large text is given. On the left side of the diary, students write down those moments that made the greatest impression on them, evoked memories, associations, puzzled, etc. On the right, they should comment on what prompted them to write down this particular quote.

Quote	Comments

At the stage of reflection, students return to work with these diaries and, with their help, the text is consistently analyzed. There are "Three-part Diaries", which have a third column - "Letters to the teacher". This technique allows you to work not only with the text, but also to conduct a dialogue with the teacher about the read [2]. "Thick and thin questions." The technique can be used at any stage of the lesson: at the stage of calling - these are questions before studying the topic; on the stages of comprehension - questions during reading, listening; at the stage of reflection (thinking) - demonstration of understanding of the past.

"Thick and thin questions" can be arranged in the form of a table. 3.

Thin?	Thick?
Who...? What...?	Give three explanations: why? Explain why ...?
When...? Can...?	Why do you think...?
Will be...? Could ...?	Why do you think ...?
What's your name...?	What is the difference...? Suppose: what happens if ...? What if...?
Was there ...?	
Do you agree...?	
Is it true...?	

As you work with the table, questions are written in the right column that require a simple, monosyllabic answer. The left column contains questions requiring detailed, detailed answers. Tables of thick and thin questions can be the basis for research, discussions, essays. "Catch the mistake." The teacher prepares in advance a text containing erroneous information and invites students to identify the mistakes made [2].

It is important that the task contains errors of 2 levels:

- explicit, which are quite easily identified by students, based on their personal experience and knowledge;
- hidden, which can be installed only by studying new material.

Students analyze the proposed text, try to identify errors, argue their conclusions. Then they study new material, after which they return to the text and correct those mistakes that could not be identified at the beginning of the lesson. "Marks in the margins". The technique of "Marking in the Margins" works at the stage of comprehension. While reading the educational text, a target setting is given: while reading the article, make notes in the text. The teacher must first determine the text or a fragment of it for reading with notes, remind the rules for placing markings, indicate the time allotted for work, check the work.

Marking marks:

- The check mark marks information that is known.
- The plus sign is used to mark new information, new knowledge.
- The “question” sign marks what remains unclear and requires additional information.

"Essay". A very effective artistic form of written reflection is an essay. This is a free letter on a given topic. An essay is a small piece of work that reveals a specific topic and has an underlined subjective interpretation, free composition, orientation towards spoken language, and a tendency to paradoxes.

The technology for the development of critical thinking provides an opportunity for the student's personal growth, introduces the student to the spiritual experience of mankind, develops his mind and individuality. The technology is open to solving a wide range of problems in the educational sphere. It is a set of special techniques and strategies, the application of which allows you to build the educational process so as to ensure the independent and conscious activity of students to achieve the set educational goals [4].

**REFERENCES:**

1. Zair-Bek S.I., Mushtavinskaya I.V. Developing Critical Thinking in the Lesson: A Teacher's Guide. - M.: Education, 2004.
2. Kozyr E.A. Characteristics of the methods of the RCMCHP technology. // gas. "Russian language". - 2009. - No. 7.
3. Zagashev I.O., Zair-Bek S.I. Critical Thinking: Development Technology: A Guide for Teachers. - St. Petersburg; Delta Alliance, 2003.
4. Selevko G.K. Modern educational technologies. - M. Public Education, 1998.

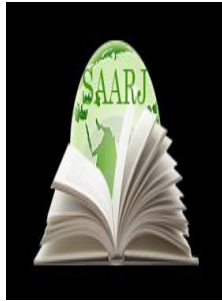

**ACADEMICIA**  
**An International**  
**Multidisciplinary**  
**Research Journal**  
 (Double Blind Refereed & Peer Reviewed Journal)



**DOI: 10.5958/2249-7137.2021.01304.5**

## GEOGRAPHICAL ROOTS AND BASIC CONCEPTS OF ETHNOECOLOGY

**Komilova Nargizahon Urinovna\***

\*Fergana State University,  
UZBEKISTAN

### ABSTRACT

*This article provides information on the geographical roots and basic concepts of ethnoecology, the work and views of scientists on ethnoecology. He assesses the impact of climate on society as follows: The northern boundary of Oykumena crosses the Black Sea 400 miles north, above which the development of civilization is only 'around the fire', and the cold climate makes life difficult. The aim of the "cultural ecology" created abroad by J. Steward as an analogue of ethnoecology was to reveal the causes of intercultural differences, first of all, the peculiarities associated with the "face" of each cultural region.*

**KEYWORDS:** *Research, Ethnoecology, Society, Natural Conditions, Geography, Determinism, Nature, Soil, Water, Air, Anthropogeography, Ecology.*

### INTRODUCTION

The system of interactions and relationships that take place between nature and society has become much more complex when it comes to the present. This connection has been replaced by the strong influence and pressure that society exerts on nature. As a result, there is an increase in various environmental problems in nature and its transformation into socio-environmental problems. President Mirziyoyev writes about the importance of ethno-ecological approach to solving these problems, along with modern innovative approaches, based on the traditions of local people: "Centuries-old approach of our peoples to nature and conservation of its water resources. By relying on our traditions, we will achieve really great results." In addition, a number of conferences of the international community (Rio de Janeiro, 1992, Johannesburg, 2002, New York, 2015) have shown that rescuing humanity from impending environmental disasters is one of the key principles of the transition to sustainable development - "traditional knowledge and values used by indigenous peoples. , recognizing the ways in which resources are used". In such an approach, the relevance of ethnoecological research is further enhanced.

Although the term ethnoecology was first introduced to modern science by the American ethnologist G. Conklin (1954) (Greek ethnos - people, oikos - home, shelter, logos - word, doctrine), the scientific views that express this concept have existed in human society for a long time. In these worldviews, serious efforts have been made to scientifically substantiate the interaction of society and nature, their interaction. The first ethnoecological ideas were put forward by philosophers in ancient Rome and Greece.

Assessing natural conditions in geography, identifying what opportunities and barriers it has for human habitation and activity began with Strabo. He assesses the impact of climate on society as follows: The northern boundary of Oykumena crosses the Black Sea 400 miles north, above which the development of civilization is only 'around the fire', and the cold climate makes life difficult. In his time, Hippocrates (460-377 BC) divided the inhabited part of the continent into 3 northern cold southern temperate and southern warm regions, where he wrote that the peculiarities of human physical and mental development, the physical and mental development of people are determined by climate. In addition, the works of Aristotle, Geradot, Strabo, Ibn Khaldun, Abu Rayhan Beruni, and the Indian treatise Arthashastra assess the impact of natural conditions on human society.

The French thinker C. Montesquieu is mentioned as the founder of geographical determinism, which was a great impetus for the development of ethnoecological views. It turns out that the views of Montesquieu and other Western European scholars on the influence of nature on human society were influenced by the ancient world and Islamic civilization. Our compatriot Abu Rayhan Beruni, commenting on the impact of natural features of the place (soil, water, air) on human society and its activities, writes: "Differences in color, image, nature and morals of human structures are due not only to differences in genealogy from the diversity of the air and the land, the places where people live." As can be seen from the link above, Abu Rayhan Beruni was extremely careful not to exaggerate the role of the geographical factor, to allow, in modern parlance, "geographical determinism". He emphasizes the importance of the role and importance of natural factors, as well as emphasizing that human beings are primarily influenced by 'genealogies', i.e. human society. Stressing that such an approach is correct and appropriate, A. Soliev writes: "Geographical determinism is, to a certain extent, an objective state of affairs, the whole question is how to interpret it."

Unfortunately, in Montesquieu's "Spirit of Laws" the exaggeration of the influence of nature on society and its presentation as the only primary factor has led to the inclusion of this idea in the list of extremely absurd ideas. He writes that "hot climates affect the physical nature and spiritual outlook of peoples and lead to the development of slavery, while temperate climates develop people's intellectual potential and lead to the emergence of strong and resilient individuals." This worldview later became a weapon to justify imperialist expansionism, nationalism and racism, and remained in the eyes of the scientific community.

He was the founder of anthropogeography in the development of ethnoecological ideas. The works of F. Rattsel (1899) played an important role. In his view, along with their place in the development of ethnoses, population density also plays a significant role, and population density contributes not only to the physical development of peoples but also to the growth of culture.

Although he did not use the term ethnoecology, the American geographer G. Burroughs was one of the first to use the term "Human Ecology", which embodied one of the main ideas in this

direction, "human adaptation to the environment." Later, in this direction, the idea of looking at the ethnic diversity of mankind as a result of his attempt (adaptation) to adapt to different natural conditions was voiced.

The aim of the "cultural ecology" created abroad by J. Steward as an analogue of ethnoecology was to reveal the causes of intercultural differences, first of all, the peculiarities associated with the "face" of each cultural region. The views of J. Steward (1955) reveal the influence of geographical factors on human culture in the following cases: first, his ideological views are based on the concept of 'diversity of evolution' and require a very careful consideration of natural factors;

second, it is recognized that similar evolutionary processes that take place in a society with comparable natural conditions are not always the result of a cultural "diffusion," but are caused by the natural conditions of the place.

The ideas of French possibilists (P. Vidal de la Blash, 1926) also play a special role in the development of ethnoecological views. According to the model developed by them, man is seen as an active agent, not a passive one, adapting to nature. It is recognized that different people in the same living environment choose different paths of economic development under the influence of different spiritual, technical, political, economic and other unnatural factors. This idea should be applied to areas with favorable and diverse natural conditions. This approach recognizes the need to take into account the complex (natural, social, economic) reasons for how a person behaves in a particular area.

## REFERENCES

1. Ahmadaliev Yu. Socio-ecological features of the territorial organization of land use. Information of the Geographical Society of Uzbekistan. Tashkent, 2003. Volume 23. -B. 58-59.
2. Ahmadaliev Yu., Abdug'aniev O., Komilova N. Landscape and Navruz // Information of the Geographical Society of Uzbekistan. Tashkent, 2017 Volume 50, pp. 24-27.
3. Babushkin L.N., Kogay I.A., Zakirov Sh.S. Agroclimatic conditions of rural economy of Uzbekistan. –T.: Mexnat, 1985. -160
4. Berg L.S. Nomogenesis or evolution on the basis of regularities. Prague, 1922.-650 p.

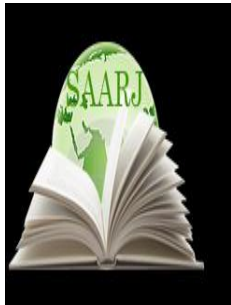

**ACADEMICIA**  
**An International  
 Multidisciplinary  
 Research Journal**  
 (Double Blind Refereed & Peer Reviewed Journal)



**DOI: 10.5958/2249-7137.2021.01305.7**

## RESULTS OF INDUSTRIAL TESTING OF OIL EMULSION DRILLING MUD IN THE USTYURT URBAN AREA

**N.N. Yodgorov\* ; A.A. Abdinazarov\*\***

\*Doctoral Student named I.A. Karimov,  
 TSTU, UZBEKISTAN

\*\*Trainee Researcher named I.A. Karimov,  
 TSTU, UZBEKISTAN

### ABSTRACT

*Geological and physical conditions and peculiarities of the development of deposits of high-viscosity oils are given. To study the causes of flooding production of wells, dependencies have been made on the development period, the utilization factor of reserves and the recovery factor of oil. It is established that the rate of watering the production of wells depends on the activity of the water-pressure system.*

**KEYWORDS:** *Deposit, Deposits, Horizon, Reservoir, Watering, Development, Dependence, Water System, Activity, Rate, Selection, Coefficient, Washing, Liquid.*

### INTRODUCTION

The specificity of drilling prospecting and exploration wells for oil and gas in the Ustyurt region is accompanied by both normal and difficult mining and geological conditions. The geological structure of the drilled areas, the depth of the productive horizons, as well as the difference in reservoir pressures, require the use of drilling fluids with different densities. One of the main tasks in well construction is the selection of rational types and formulations of drilling fluids, as well as control over their quality during drilling.

However, drilling in the interval of lowering intermediate strings is often accompanied by sloughs, collapses and grooves, which leads to the necessary study, and sometimes to emergency situations. For example, sticking a drilling tool in well. No. 1 pl. Surgil during the opening of thick clay deposits in the interval of 2550-2587 m. The cause of the sticking of the drilling tool was the collapse of the borehole walls. The elimination of the sticking was completed with the drilling of the second borehole. There were also cases of frequent wellbore reaming while drilling wells. No. 1 Shagirlik in the interval 1835-2035 m there was a deterioration in the quality

of the clay solution. As a result, the relative viscosity of the solution increased to "non-fluid", and the fluid loss also rose to 30 cm<sup>3</sup> in 30 minutes and the density of the solution reached 1.30 g / cm<sup>3</sup>. Under these conditions of work, wellbore development is required with continuous treatment of the drilling fluid with the addition of FHLS, UShchR, soda ash and NaOH, to maintain the properties of the drilling fluid within the following limits: specific gravity - 1.18 g / cm<sup>3</sup>, viscosity 60c and fluid loss 10-12 cm<sup>3</sup> in 30 minutes [1,2].

It is difficult to regulate the technological properties of drilling fluids directly during drilling, due to the lack of effective reagents to ensure the required properties.

It is known that the formation waters of this region used for the preparation of drilling fluids differ from other formation waters of Uzbekistan in their aggressive action towards chemical reagents, due to the content of sodium, calcium, magnesium and potassium ions in the water composition in large quantities. The total salinity of formation waters is 20-25%.

When preparing drilling fluids based on formation waters, chemical reagents and materials are consumed several times more than those envisaged in the well construction project in this region. However, despite this, it was not possible to maintain the parameters of the drilling fluids that meet the requirements of well placement in a particular geological section. Considering this circumstance, they abandoned the use of formation waters for the preparation of drilling fluids using fresh water.

Therefore, our experimental laboratory studies were aimed at obtaining oil-emulsion inhibited drilling mud using saline formation waters of the Ustyurt oil and gas region. The use of saline formation water excludes the introduction of inhibiting additives into the composition of the drilling mud, because these additives are in the composition of the formation water in the required amount [3].

On the basis of laboratory studies, we have developed the composition of an oil emulsion drilling mud based on a polymer composition obtained from the waste of an oil and fat plant - (PCM) with the use of aggressive formation waters of the Ustyurt region.

The proposed composition of the oil emulsion drilling mud was tested in the Severny Berdakh area while drilling a wellbore in the interval of 103-910 m.

Well No. 2 of the North Berdakh area was laid in order to clarify the geological structure and assess the effectiveness of the oil and gas potential of the upper, middle and lower Jurassic deposits. Design depth - 4100 m (Paleozoic). In the 0-100 m interval, drilling was carried out using natural clay mud based on saline formation water. The 426 mm elongated direction was run down to a depth of 103 m and cemented. The processing of the working natural circulating drilling mud of the North Berdakh-2 area with the PCM began at a depth of 103 m. Before treatment, the drilling mud had the following parameters:

Specific gravity	1,20 g / cm <sup>3</sup>
Viscosity	25 sec
Water loss	40 cm <sup>3</sup> / 30 min
Peel thickness	6 mm
PH	7,0



According to the operating flow chart, in the interval from 100 to 1600 m, the following chemical reagents were to be used for drilling mud treatment in percentage ratios of the total volume of circulating drilling mud:

Carbon alkali reagent paste	10-15 %
Caustic soda	1,0 %
Soda ash	1,0 %
Reagent K-4	2-3 %
Oil	5-10 %

Drilling of the wellbore for the surface of the Severnaya Berdakh area was carried out with bits with a diameter of 394 mm, accompanied by partial loss of drilling fluid (25 - 30 m<sup>3</sup> per day). To maintain the required volume of the circulating fluid continuously without interruption, it was necessary to prepare 35 - 40 m<sup>3</sup> of drilling fluid using the above reagents at the required rates. It was delivered to the drilling site pl. Severny Berdakh 8 tons of PCM. For the primary treatment of the working drilling mud, a 10% aqueous solution of PCM was first prepared in an amount of 80 m<sup>3</sup>. Without stopping the process of deepening the well, they began to inject an aqueous solution of PCM into the circulating solution. After the completion of the PCM injection, the drilling fluid had the following parameters:

Specific gravity - 1.12 g / cm<sup>3</sup>

Viscosity - 35 sec

Water loss - 20 cm<sup>3</sup> / 30 min

Peel thickness - 4 mm

RN - 8.0

After being introduced into the working emulsion drilling mud, the PCMs were additionally treated with a 2% aqueous solution of the K-4 reagent. As a result of the introduction of the K-4 reagent, it was possible to maintain the parameters of the drilling fluid in the required standards, which were provided for in the GTN:

Specific gravity	- 1,12-1,14 г/см <sup>3</sup>
Viscosity	- 40-45 сек
Water loss	- 10-12 см <sup>3</sup> /30 min
Peel thickness	- 1,5-2 мм
pH	- 8-9

Taking into account the absorption of drilling mud and shedding of unstable rock into the wellbore, it was decided to run the casing string with a diameter of 299 mm to a depth of 910 m. It should be noted that in the process of deepening, working out and preparing the wellbore for running the casing string, the parameters of the drilling mud practically did not change. , tripping operations were carried out without tightening and landings of the drilling tool. During the test period in the well No. 2 pl. Severny Berdakh prepared 250 m<sup>3</sup> of drilling mud based on PCM,

without the use of caustic and soda ash, and the consumption of K-4 reagent decreased several times. It should be noted that local and bentonite clay was not used to prepare the drilling mud; drilled clay was used in their place. Conductor 299 mm in diameter was lowered to a depth of 910 m without reaming and widening of the wellbore, only with gauging, after which the casing was successfully cemented. The cement slurry rose to the wellhead [4].

The results of industrial testing of emulsion drilling mud based on PCM in the Severny Berdakh area, well No. 2 showed that the process of drilling wells under conditions of salt aggression was carried out without complications and the parameters of the working fluid were maintained in accordance with the GTN ..

In the adjacent well No. 1 pl. Severny Berdakh, despite the huge expenditure of chemicals, failed to maintain the parameters of the drilling fluid provided for in the GTN. Thanks to the use of PCM in the treatment of circulating drilling mud, 2420 kg of caustic soda, 2985 kg of soda ash, 5975 kg of K-4 reagent, 36315 kg of clay and 1873 kg of oil were saved.

Based on the positive results obtained from testing oil emulsion drilling mud in well No. No. 2 on the Severny Berdakh area, this composition is recommended for industrial implementation in the drilled wells of the Ustyurt region.

#### REFERENCES:

1. N. Yodgarov book "Chemical reagents and materials for oil and gas industry" - Tashkent., Voris. 2009 529 p.
2. Murtazaev A.M. Development of methods for increasing the reliability of isolation of oil and gas reservoirs with high pressure and temperature // Dissertation of Candidate of Technical Sciences. Institute UzLITI oil and gas - Tashkent 2004.
3. Express method for determining the stability of hydrophobic emulsion solutions. "Oil industry" No. 5, Moscow, Nedra, 1998.
4. Drilling fluids based on emulsions. OZL, ser. "Drilling". M. VNIIOENG 2003.

PCM-Polymer composite material

UShchr- Carbon alkali reagent

GTN - Geological and technical outfit

NTF- Nitrioltrimethylphosphonic acid (white powder)

FHLS- Ferrochromlignosulfonate

CMC - carboxymethyl cellulose

K-4 - polymer reagent

CITS - central engineering and technical service

UBR - drilling operations department

pH - pH, a measure of the acidity of aqueous solutions



**ACADEMICIA**  
**An International  
Multidisciplinary  
Research Journal**  
(Double Blind Refereed & Peer Reviewed Journal)

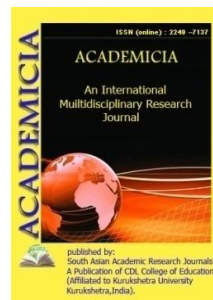

DOI: **10.5958/2249-7137.2021.01282.9**

## **SPECIAL METHODS FOR STUDYING THE CHEMICAL COMPOSITION OF ENGINE OILS**

**Imomova M.Yo\*; Abduganiev B.Yo\*\*; Turdiboev A. Kh\*\*\***

\*Fergana State University,  
UZBEKISTAN

\*\*Central Customs Laboratory of the Republic of UZBEKISTAN

\*\*\*Fergana State University,  
UZBEKISTAN

### **ABSTRACT**

*Scientific research in the direction of differentiating the belonging of motor oils and lubricants to synthetic, poly- $\alpha$ -olefin or mineral containing from 20 to 70 carbon atoms, or semisynthetic consisting of their mixtures, are the main ones, since the prevention of incorrect classification by the code of one type of engine oil and lubricants to others, it is conditioned by the introduction of customs control methods based on world-class achievements in the field of science and technology, as a result of which it becomes clear that only research in this area will help to solve the above-mentioned problems.*

**KEYWORDS:** *Base Oil, Lubricating Oil, Mineral Oil, Synthetic Oil.*

### **INTRODUCTION**

Our research paper presents data obtained by using an effective method for determining the amount of base oil in an engine and lubricating oils. This method consists of several steps:

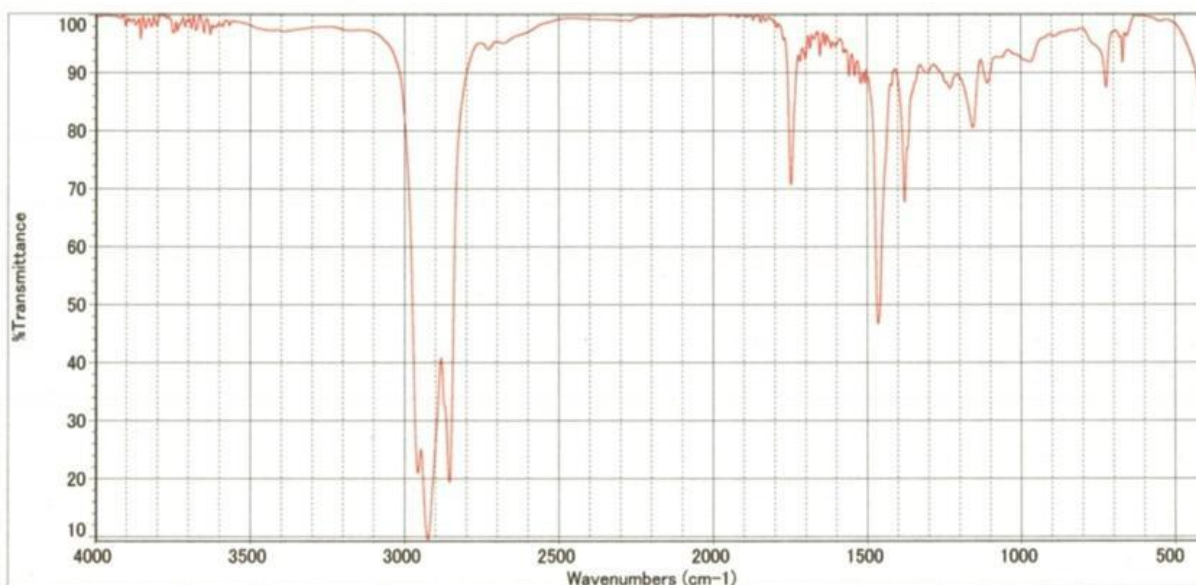

### **Scheme for determining the amount of base oil in engine and lubricating oils**

#### **THE MAIN FINDINGS AND RESULTS**

Due to the fact that this study is based on IR spectroscopy, in order to achieve the accuracy and transparency of the results, a program for metrological certification of equipment was developed, as well as an integrated approach to determining the chemical composition of engine oil in the described sequence.

For the analysis of engine oils, two types of samples with a mass of 100 g were taken. In order to make sure that the samples were engine oil, the IR spectra of the samples were taken. In some cases, knowing the frequency of absorption of the bands in the IR spectrum, one can draw conclusions about the functional groups of a substance, thus finding which classes they belong to. The IR spectrum of saturated and unsaturated hydrocarbons is observed only in absorption bands caused by stretching and deformation vibrations of the CH bond.

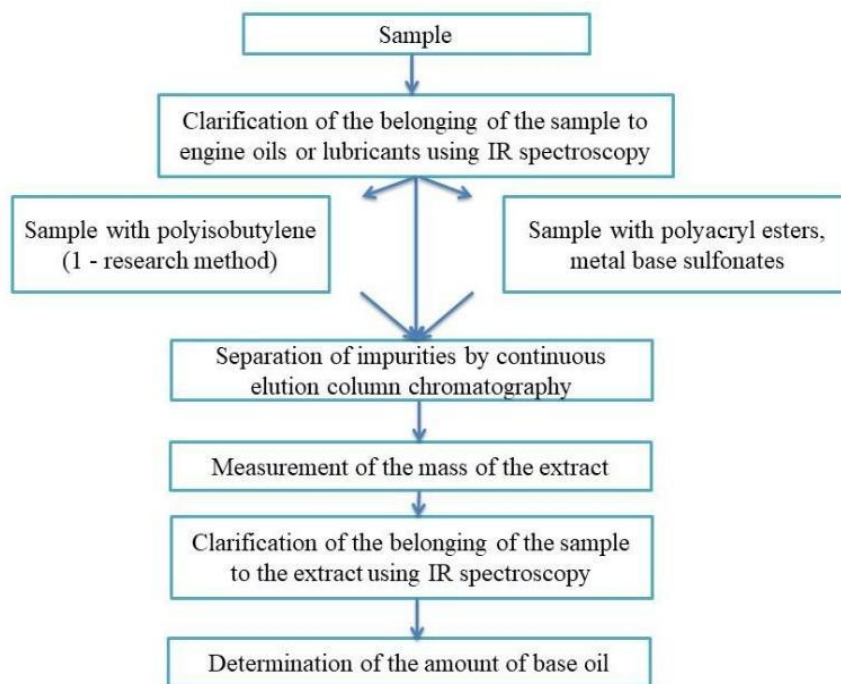

### Synthetic oil sample

#### Pic. – 6. IR spectrum of engine oil.

However, it is impossible to obtain information on the number of methyl and methylene groups in the hydrocarbon chain from IR spectra. Bands formed by asymmetric and symmetric stretching vibrations of methyl (-CH<sub>3</sub>) and methylene (-CH<sub>2</sub>) groups in the range 2850-2950 cm<sup>-1</sup>. Based on this case, it was concluded that the analyzed sample consists of hydrocarbons. Compared to the spectra in the Image Sample Library, the exact match of the spectra of the unknown substance indicates that the fluid being tested is engine oil.

According to the IR spectra, if it was assumed that the sample contains polyisobutylene, then it is necessary to carry out the pretreatment procedure as described in the first way.

The first method of preliminary sample preparation.

Took the first sample with an accuracy of 5 g and placed in a 200 ml Erlenmeyer flask, mixing, added 20 ml of petroleum ether. While constantly mixing, 20 ml of acetone was slowly added to the mixture. The flask was connected to a refrigerator, inserted into a condenser and heated for 10 minutes in a hot water bath. We waited until the liquid above the sediment reaches a transparent state. The decanted liquid content in the flask was collected in a 500 ml glass beaker. The precipitate in the flask was washed three times with a mixture of 20 ml of petroleum ether and acetone (1: 1), and each time the solution from the flask was poured into a 500 ml beaker. The precipitate was washed twice more with 20 ml of petroleum ether, filtered and added to the mixture in a 500 ml beaker. The newly obtained 200 ml Erlenmeyer flask was pre-weighed. The collected extract in a 500 ml glass beaker was poured into a pre-weighed 200 ml Erlenmeyer flask and the solvent was evaporated using a rotary evaporator. The remaining residue was dried

at  $100 \pm 2$  ° C in an oven and weighed on an analytical balance. The percentage of residual oil other than polyisobutylene is calculated using the following formula:

$$X \% = \frac{B_o}{A} * 100 \quad (1)$$

X is the residual part of the oil except for polyisobutylene (%);

A is the weight of the sample (g);

B<sub>o</sub> is the residual part of the oil except for polyisobutylene (g).

All processes were performed due to the fact that polyisobutylene does not dissolve in acetone and petroleum ether, and the rest of the oil sample is highly soluble in these solvents. If the IR spectra suggest that the sample contains polyacrylic esters and / or metal bases of sulfonates, preliminary preparation was carried out in accordance with the method described in method two.

Second way of preliminary sample preparation.

2 g of the sample was placed in a rubber membrane. The top of the rubber membrane was attached to the aeration clamp. The attached membrane was placed in the Soxhlet extractor column in such a way that the membrane was above the level of the extractor liquid.

120 ml of petroleum ether was poured into a flask and combined with an extractor. To ensure circulation, the immersed flask was connected to a reflux condenser, then placed in a water bath and left to boil for 10 hours. The dialysis rate of the water bath was adjusted from 6 to 8 cycles per hour. The purified ether in the flask was used as a test material.

At the same time, metal-based polyacrylic esters and sulfonates are easily adsorbed.

After dialysis, the flask was separated from the Soxhlet extractor and the petroleum ether solution was removed as a test material for further processes. If all of the aforementioned additives are assumed to be present in the sample based on IR spectra, then pretreatment should be performed first with the first method and then with the procedure shown in method two.

The procedures shown in the first and second methods were not implemented due to the absence of polyacrylic ethers, sulfonates based on metals and polyisobutylene functional groups in the sample according to IR spectra.

Method for quantitative analysis of motor oils using continuous elution chromatography.

Preparing a Soxhlet column.

50 g of weighed dry silica gel was loaded onto a Soxhlet extractor column.

The upper and lower parts of the Soxhlet column were covered with cotton wool, and the adsorbent was washed with a large amount of petroleum ether. The washed petroleum ether was removed. In a pre-weighed flask was poured 100 ml of petroleum ether and connected to the above Soxhlet column. The sample was slightly dissolved in petroleum ether. The flask was connected to a refrigerator and placed in a water bath. The temperature was set such that the rate of petroleum ether outflowing from the bottom of the column was 100 to 120 drops per minute. Thus, the solvent was circulated for 16 hours. The residue in the flask was dried in a water bath at  $100 \pm 2$  ° C until the residual mass became constant.

### Mineral oil

#### Pic. – 7. IR spectrum of motor oil extract.

Determination of volatile substances.

This method was carried out due to the presence of volatiles in base oils in the determination of the quantitative analysis of engine oils using the first method of preliminary sample preparation and the method of continuous elution chromatography.

In parallel with the process of quantitative analysis of engine oil using the method of continuous elution chromatography, 2 g of the sample placed in a Soxhlet column was weighed and dried in an oven at a temperature of  $100 \pm 2$  ° C until the mass became constant.

The losses were calculated using the following formula:

$$U \% = \frac{B}{G_o} * 100 \quad (2)$$

U is the amount of volatile substances%;

B is the amount of loss (g);

$G_o$  is the residual part of the test sample (g).

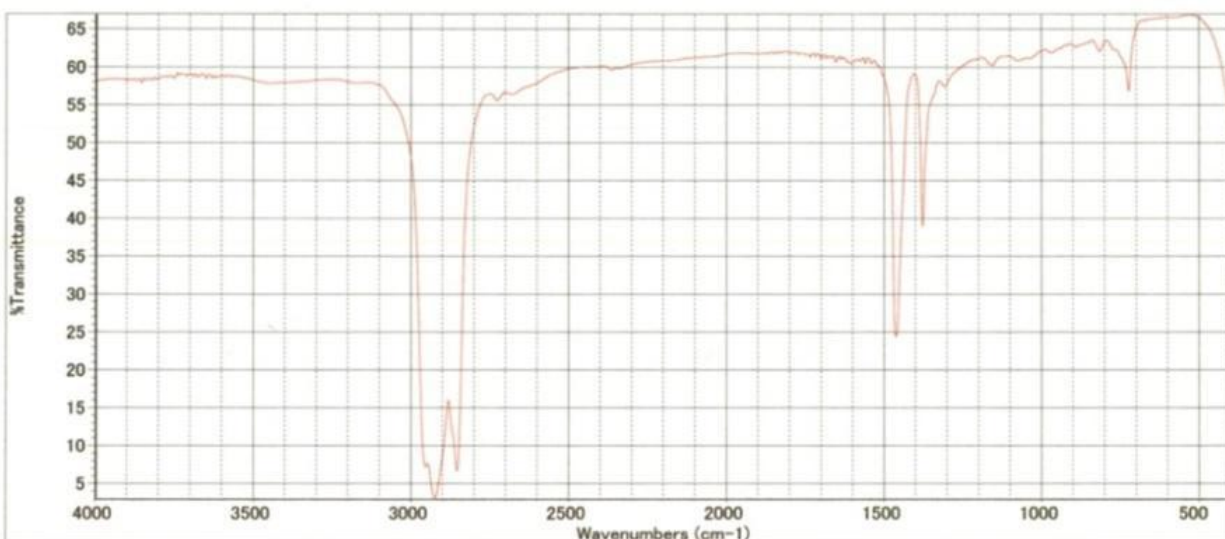

The degree of dissolution of base oils with continuous elution with petroleum ether for 16 hours (%). Calculation of base oil content in engine oil.

The mineral content in engine oil samples is determined using the following formula.

On the occasion, obtained  $T$  by the first method of preliminary sample preparation

$$N \% = P \% \times x + \frac{T}{S_o} \text{ volatile substance \% (3)}$$

$N$  is the base component of mineral oil%;

$P$  is the amount after removal of poly-isobutylene (%);

$T$  is the amount of a substance according to the analysis of engine oils using a continuous elution chromatography method (g);

$S_o$  is the collected volume of the test sample (g).

As a result, it was found that the first sample of engine oil = 95.51% - 2710, and the second sample of engine oil = 45.1% - 3403.



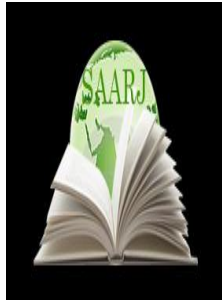

**ACADEMICIA**  
**An International  
 Multidisciplinary  
 Research Journal**  
 (Double Blind Refereed & Peer Reviewed Journal)



**DOI: 10.5958/2249-7137.2021.01283.0**

**DATA ON JALALIDDIN RUMI'S LIFE IN THE WORK “SHARHI  
 MASNAVIYI MAWLAVI” BY AYYUB**

**Iroda Amanullayevna Umarova\***

\*Independent Researcher,  
 Department of “Classical Philology”,  
 Tashkent State University of Oriental Studies,  
 UZBEKISTAN  
 Email id: bibish\_b5@mail.ru

**ABSTRACT**

*The greatest didactic work of Mawlana Jalaliddin Rumi (1207-1273) was “Masnaviyi Manaviy”, and to understand it required a great deal of knowledge, so from the very beginning of this work, commentaries have been written on it. The play deals not only with religion and mysticism, but also with Rumi's life and work. Of course, there is more or less information about it in the comments. One such work is Ayyub's commentary on the six books of Jalaliddin Rumi's “Masnaviyi Manaviy”. This work is stored in the fund of the Institute of Oriental Studies named after Abu Rayhon Beruni of the Academy of Sciences of the Republic of Uzbekistan under item number 2225 / II. In the middle of the pages of the manuscript there is a Roman “Masnavi”, in the margin there is a commentary of Ayyub “Sharhi Masnavi Mavlavi” in proportion to it. At the same time, the commentary explains some of the words, and tells stories about Rumi's life and his teachings. Some of the stories are narrated by the narrator himself. Others are interpreted on the basis of a specific source, such as the Quraan or “Manaqib al-Arifin”, and at the beginning of each commentary or story the source from which the information was obtained is noted. The narrator also narrated some of the stories on behalf of a person, and in this case the name of the person is clearly stated. In the article, these cases are classified separately and explained through examples. In the commentaries, the deeds of Mawlana, information about his relatives, Rumi is described not only as a poet, but also as the founder of the “Mawlawi” sect, a mature sage of his time, a saint who reached the highest peak of perfection. A study of Ayyub's commentary shows that he read many works on Rumi's life and work, worked with dictionaries, improved his religious and mystical knowledge, and collected information from previously*

---

written commentaries. Therefore, “SharhiMasnaviMavlavi” is one of the best sources of many other sources on the life and work of Rumi.

**KEYWORDS:** *Jalaliddin Rumi, Ayyub, Work, Commentary, Manuscript, Source, Copy, Dictionary, Mysticism, Saint, Verse, Prophet, Qur'an, Verse, Hadith, Reality, Story, And Love, Spirit.*

---

## INTRODUCTION

A number of works of MawlanaJalaliddin Rumi (1207-1273) have been inherited by mankind. Centuries later, these works continue to be studied by Roman scholars, while retaining their relevance. His greatest didactic work is “MasnaviyiManaviy” and since understanding it requires a great deal of knowledge, a commentary has been written on it from the very beginning of its writing.

Today, information about the work of MawlanaJalaliddin Rumi “MasnaviyiManaviy” can be found in the forewords of his published works, articles, scientific research, pamphlets and books dedicated to the life and work of Rumi, as well as on the Internet. Among them is some commentary on Rumi's “Masnavi”. In his book “MawlanaJalaladdin Rumi. Divine flute of the world. Life, personality, thoughts” [6:96], ShefikDjan gave some information about the comments written in Turkey, but it is said that this information is not a definitive number and the comments of “Masnavi” will be found again. In particular, the Institute of Oriental Studies of the Academy of Sciences of the Republic of Uzbekistan also has commentaries on “Masnavi”, some of which are described in “*Sobranievostochnyxrukopisey*” (“Collection of Oriental Manuscripts”) [1].

## THE MAIN FINDINGS AND RESULTS

One of such commentaries is Ayyub's commentary on Jalaliddin Rumi's “MasnaviyiManaviy”, one of his manuscripts (manuscript number 2225) is kept in the fund of the Institute of Oriental Studies of the Academy of Sciences of the Republic of Uzbekistan. It is given in the margin of the pages of the book (in the middle is the text of Jalaliddin Rumi's “MasnaviyiManaviy”) and is called “SharhiMasnaviyiMawlavi”; the author's name is mentioned in the form of Ayyub in the first lines of this commentary. The first brief description of the manuscript is found in the second volume of *Sobranievostochnyxrukopisey* [2]. It contains information that the work was copied in Kashmir by the secretary Obad Muhammad Siddiq in 1221/1806 by the order of Mirza Muhammad Rabikhan. This comment is one of the comments written in India [7:35]. The first study of Ayyub's SharhiMasnaviyiMawlavi was DiloromHamroeva's article “A work of immortal soul. About the first Turkish commentaries of “MasnaviyiManaviy” published in the newspaper “Uzbekistan adabiyotivasanati”, in which Ayyub Lohuri's commentary was mentioned, and the date of writing was given as 1713 [8] . Subsequent research was conducted by the author of the article [9].

Ayyub's commentary contains many stories about the life and work of MawlanaJalaliddin Rumi, which can be grouped as follows:

- a) The events of Rumi's life and work narrated by Ayyub;
- b) Phrases and excerpts from Ahmad Afloki'sManaqib al-Arifin [5];

c) A story narrated by a narrator on behalf of a person.

**Stories from the life and work of Rumi narrated by Ayyub.** Ayyub does not give information about its sources when he narrates a story commenting on some bytes. The following story is about Mawlana's great love for Allah.

جانهای بسته اندر آب و گل  
چون رهند از آب و گلها شاد دل  
در هوای عشق حق رقصان شوند  
همچو قرص بدر بی نقصان شوند [3:32a]

*Translation:*

*He melted our souls into water,  
Erusuvdin made us happy.  
In the air of love, he said, dance,  
Be as perfect as the full moon [1: 1:13].*

According to Ayyub, these verses describe the emergence of man and his joy and happiness. It is said of his abstract existence and eventual extinction: "One day Sultan Valad narrated: "My great-grandfather, in his youth, devoted himself to asceticism and ceased to participate in heaven. Then my grandfather on my mother's side invited my father to heaven. Shams Tabrizi came and called my great-grandfather to descend to heaven, and they began to descend to heaven. Mawlana Zayniddin, a great Greek scholar and official, says:

"Why do such a great Mawlana violate the rules of the sky?" Then Mawlana replied:

"Everything that is forbidden before a person dies (if he is helpless) is lawful for him. Similarly, it does not matter how a person dances if he has only Allah in his heart, that is, if he lives only in his memory. He considers himself close to God." Upon hearing this, Zayniddin took a few steps and fainted. Zayniddin Mawlana will become a murid".

In the commentary on the following verses, the narrator also gives verses from the Quraan to further enrich the content of the stories narrated by him.

چون بسی ابلیس آدم روی هست  
پس بهر دستی نشاید داد دست  
زانکه صیاد آورد بانک و صفیر  
تا فریب مرغرا آن مرغ گویو [3:15 b]

*Translation:*

*The demons are human in nature, so  
It's also not good to shake hands with everyone.  
The hunter-gatherers whistled the bird,  
The bird is also deceived by this sound [1: 1:50].*

Ayyub describes what MawlanaJalaliddin Rumi meant in this story in his commentary:

“One day, a person named Nuriddin, the deputy of MuiniddinParwana, was talking to Mawlana about the miracle of Haji BektashKhurasani. He said, “Bektash was not praying and I told him to pray. He said to me, “Bring me some water so that I may perform ablution”. I brought water. He took the water-pot and handed it to me and ordered me to pour water. I poured water into his hand. Pure water turned to blood”.

Then Mawlana said: “It would be better if he turned blood into water, because it is not a profession to turn pure water into something impure. If the word (Moses) turned the water of the Nile into blood for the Copts and the blood into water for the Tribes, it is only for him. No one else has been given such power. This conversion is called a useless conversion” [3: 15b].

The commentary is then summarized in the following verse:

ان المبذرين كانوا اخوان الشياطين

The full form is as follows:

ان المبذرين كانوا اخوان الشياطينو كان الشيطان لربه كفورا

*Translation: Because the wasteful are the brothers of the devils. Satan, on the other hand, was very ungrateful to his Lord [4:17:27].*

"The real (true) transformation is that your wine will turn into vinegar and your problem will be solved, low-quality copper will turn into yellow gold, the unbeliever will become a Muslim, and your (clay) soil will turn into pearl”.

Nuriddin bowed his head” [3: 15b].

Ayyub in “MasnaviyiManaviy”

آنکه جان بخشد اکر بکشد رواست

نایبست و دست او دست خداست [3:14a]

*Translation:*

*Whoever kills - if he kills, well?*

*The great vicegerent is the hand of God. [1: 1:43]*

hen commenting on the verses, **در مناقب العارفين مستور است** said, “I am quoted in “**Manaqib al-Arifin**”, citing the source he used, but did not say who the author was.

Based on this work, the narrator narrates an event related to the life of Ayyub MawlanaJalaliddin Rumi. According to the narration of MawlanaShamsiddinMudarris's son, MawlanaJalaliddin Rumi had a flute player named Mawlana Hamza. He played the nay very skillfully and Mawlana Rumi's love for him was boundless.

One day he gets sick and dies. They inform Rumi about this and begin preparations for the funeral.

Jalaliddin Rumi goes to his house and as soon as he enters through the door, my dear friend Hamza, gets up! They shout. Hamza gets up and starts playing the flute. They descend into the different samo (dance) for three nights - day in the melody of the nay. Seeing this, about a

hundred Roman infidels became Muslims. With the departure of Mawlana, Hamza passed away [3: 14a].

According to the narrator, the second verse of the above verse refers to the verse of the Holy Quraan:

ان الذين يبائعونك انما يبائعون الله يد الله فوق ايديهم فمن نكث فانما ينكث على نفسه و من او فى بماعهد عليه  
الله فسيؤتيه اجر اعظيما [4:48:10]

*Translation:*

*Indeed, those who pledge allegiance to sega pledge allegiance only to Allah Himself. God's hand is over their hands. Whoever breaks a covenant breaks it against himself. And whoever fulfills his covenant with Allah, he will have a great reward.*

Then, O Muhammad (saas), if they pledge allegiance to you, they have pledged allegiance to God! - the commentator writes.

Sheikh Abdulaziz Mansur's translation of the Holy Qur'an explains this verse as follows: as if his hand was placed on the hands of believers, it is as if he were placed on the "hand" of Allah. As it is said in another verse: "Whoever obeys the Messenger has obeyed Allah".

Under a bush in the Hudaybiya Valley, about one and a half thousand Muslims swore allegiance to the Prophet (saas) under all circumstances. This event is known in Islamic history as Bay'atur-Rizwan. It means an oath that is pleasing to Allah [4:48:10].

The following commentaries deal with the saintly qualities of Hazrat Mawlana:

غيب و آينده بر ايشان گشت فاش [3:34a]

*Translation:*

*The secret of tomorrow is revealed before him [1: 1: 146]*

Ayyub interprets this verse as follows: According to "Manaqib al-Arifin", one day Hazrat Mawlana raised his blessed hands and said: "A group of noble people from Turkestan and Bukhara are coming and want hot halva from us". Then a plate of hot halva appeared out of nowhere. When the nobles arrived, Mawlana said to them: "You could have asked for Jesus' share. What happened to a plate of halva? Allah, Allah! Do you come and ask the saints for halva?! Ask for something that will solve your problem as easily as a halva and give strength to your soul and body".

هست قرآن حالهای انبیا

ماهیان بحر پاک کبریا [3:35a]

*Translation:*

*The state of the saints is the Qur'an of Truth,*

*What a great ocean of fish [1: 1: 153].*

These verses point out that because of the divine power given to the saints, they were given the opportunity to appear at any time, anywhere. Ayyub interprets it as follows: It is said that one of the admirers of Hazrat Mawlana lived in Kunya. He set out with the intention of Hajj. Wherever

he stopped, wherever he went, he would see Hazrat Mawlana. When he reached Damascus, he saw Mawlana walking on top of the mosque. He would call her from there. He fainted from fear. When he regained consciousness, he saw no one there. Surprised, he continued on his way and reached the Ka'bah. As you can see, Mawlana was circumambulating the Ka'bah. During his visit to Mount Arafat, he saw Mawlana begging there. When he returned from Hajj, Kuniya came to Mawlana and Mawlana said to him: "Hoja Amir swam like a fish in the river of power. He would stick his head out wherever he wanted".

کاملی گر خاک گیرد زر شود

ناقص ار زر برد خاکستر شود [3:36a]

*Translation:*

*If you take the soil, it will be perfect, it will be dice,*

*If he takes the wrong dice, he will be reduced to ashes [1: 1: 159].*

Commenting on this verse, Ayyub narrates: "One day Mawlana used to recite this ghazal with pleasure:

"ای عشقان ای عشقان

من خاکرا گوهر کنم

وی مطربان وی مطربان

دف شما پر زر کنم"

With that, they took a handful of soil from the ground and sprinkled it on the drum of a man named Kamal, the chief of the drummers. He was also the greatest musician and singer of his time. He looked like his drum was full of gold. "

The narrator narrates another story from "Manaqib al-Arifin" and links it to the following verse commentary:

ای مری کرده پیاده با سوار

سر نخواهی برد اکنون پایدار [3:36a]

*Translation:*

*He is a horseman, you are a walker, do not argue,*

*If the head is needed, enough, then turn [1: 1: 159].*

The commentary on this byte tells the story: Sheikh Majiddin, one of the most famous sheikhs of his time, said at a gathering of scholars: He said, "Now, if Mawlana (Rumi) comes and I deny what he says, and in this way he will be gentle." Sheikh Sadriddin, who was present at the meeting, tried to dissuade him, saying, "It is forbidden in the teachings to insult the elders". But he did not listen. Hazrat Mawlana visited the meeting: He said, "La ilaha illallahu Muhammadu-r-Rasulullah". The crowd came to a screeching halt, and all at once returned, leaving them, and shouting. Sheikh Majiddin repented and bowed.

Many of the stories from "Manaqib al-Arifin" speak of Rumi's saintly qualities.

**A story narrated by a shariah on behalf of a person.** Ayyub sometimes quotes the name of a specific person and gives a quote from the life of Jalaliddin Rumi on his behalf. One of them is the Malikul Caliph **Mawlana Badriddin al-Madani**, may Allah have mercy on him, the respected caliph of Rumi, who narrated: “Hazrat Mawlana had a fat singer. One day, Mawlana was singing with all his joy, and he was playing the drums with enthusiasm. After Samo, Mawlana asked him: They said, “Why don't you stand up?” He said he was fat. Mawlana stroked his back with his hand, and immediately his body straightened up [3: 14a].

The next verse refers to a verse from the Quraan:

آیت انسوم کم ذکر بیخوان [4:23:110]

قدرت نسیان نهادن سان بدان [3:37a]

*Translation:*

*Read the verse "Ansavkumu zikriy ...",*

*So forgetfulness is rare, conscious, read [1: 1: 146].*

The full text of the verse is as follows:

فاتخذ تموهم سخريا حتى انسوكم ذكرى و كنته منهم نضحكون

*Translation:*

*So you mocked them, even though he forgot you to remember Me. You laughed at them [4: 23: 110].*

Commenting on this verse, Ayyub refers to the following story:

Mawlana **Qutbiddin Sherozi** writes in his book "Majma'i fuzaloi Tabriz":

“We have 12 people in Kunya who are very knowledgeable. Each of us was very talented in a particular subject and we wanted to talk to Hazrat Mawlana on a number of issues. When we went to them, we forgot all our knowledge and could not remember anything no matter how hard we tried. Mawlana answered all the questions we were thinking about one by one. We were amazed and admired him”.

In the commentary of the following verse, Mawlana's words about nafs are quoted:

گر تو این انبان زنان خالی کنی

پر ز گوهرهای اجالی کنی [3:366]

*Translation:*

*Put the bread aside, do not leave, gather,*

*Fill the chest with pure pearls [1: 1: 161].*

Mawlana Badriddin Bahriya narrates:

“One winter, Mawlana came to my house and went naked into the cold pool. Those who went into the water poured water from the man's head into a bucket. They stayed in that position for 3 nights and 3 days. People could not stand it. I would cry out to the poor man and say that cold water was harmful in this bitter winter. Mawlana came out of the water and spent 9 days and

nights in the sky. They did not eat and said: "O soul, be patient. Do not eat. If you do, he will eat you".

## CONCLUSION

The above analysis provides various information about the life of Jalaliddin Rumi. The stories provide information about Mawlana's life deeds as well as his close people. It is also stated that Rumi was not only a poet, the founder of the Mawlawi sect, a mature sage of his time, but also a man who reached the highest peaks of perfection and embodied the qualities of a saint. The scientific study of the life of Jalaliddin Rumi and his works "Masnaviyi Manaviy", which has become a masterpiece of the spiritual wealth of mankind, is a topical issue and provides an opportunity to reveal its undiscovered aspects on the basis of new research.

## REFERENCES

1. Jaloliddin Rumi. "MasnaviyiManaviy". The first book. Translation from Persian by the People's Poet of Uzbekistan Jamal Kamal. Abdulla Kodiri People's Heritage Publishing House. – Tashkent. 2002.
2. Collection of Oriental Manuscripts of the Academy of Sciences of the Republic of Uzbekistan (SVR). T. II. – Tashkent: 1952, Number 912.
3. Fund of the Institute of Oriental Studies named after Abu RayhonBeruni of the Academy of Sciences of the Republic of Uzbekistan, Manuscript No. 2225.
4. The Holy Quran. Translation and Interpretation of Meanings (Revised 2nd Edition). The author of the translation and description is Sheikh Abdulaziz Mansur. "Sharq" Publishing House. – Tashkent. 2007.
5. According to Haji Khalifa's Kashf uz-Zunun, Manaqib al-Arifin was written in 718 AH / 1318 AD and was written by Ahmad Afloki. Haji Khalifa (original name Mustafa ibn Abdullah; 1609, Istanbul - 1657) and Secretary Chalabi is a Turkish geographer and historian. He is famous for his works on historical geography "Jahonnamo" and bibliographic works "Kashf uz-zunun". The next work contains important information about many authors and their works. See also: جلال الدين همالي. تفسير مثنوی مولوی. داستان قلعه ذات الصور یا ذر هوش ربا. پانتشرات دانشگاه تهران-1298. p. 60.
6. Shefik Jan. (2008). *MawlanaJalaladdin Rumi. Divine flute of the world. Life, personality, thoughts.* – Moscow:– p. 96.
7. Information on external and internal features and structural features of the work The author's master's dissertation "Ayyub's work" Sharhi Masnaviyi Mawlavi "as a literary source on the life and work of Jalaliddin Rumi (first book)" Chapter II, 2.1. It is described in detail in the paragraph entitled "Content and structural features of the commentary of Ayyub. – Tashkent. 2010. – p. 90.
8. DiloromHamroeva. *A work of immortal soul./Gas.* "Literature and Art of Uzbekistan", October 3, 2008.
9. Umarova I. (2010). "Ayyub's work" Sharhi Masnaviyi Mawlavi "as a literary source on the life and work of Jalaliddin Rumi (first book)". Master's dissertation. – Tashkent:– p. 90; Umarova I. About a commentary on Jalaliddin Rumi's Masnaviyi ma'naviy. Sources on the



history of the Timurids. Tashkent, State Museum of the History of the Timurids, October 18, 2007. Proceedings of the scientific-practical seminar of young researchers on "Scientific potential and time" Tashkent, State Museum of the History of the Timurids, October 18, 2008. 4 books. Tashkent, 2010; Umarova I. Comments of Jaloliddin Rumi's work "Masnaviyi Manaviy" in the fund of the Institute of Oriental Studies of the Academy of Sciences of the Republic of Uzbekistan. Theses of the IX scientific-practical conference of young orientalists named after academician Ubaydulla Karimov. Institute of Oriental Studies named after Abu Rayhon Beruni of the Academy of Sciences of the Republic of Uzbekistan, Tashkent State Pedagogical Institute, - Tashkent: 2011. pp. 13-14; Umarova I. On the comments of Jalaliddin Rumi's work "Masnaviyi Manaviy" (on the basis of manuscripts of the Treasury of the Academy of Sciences of the Republic of Uzbekistan). Institute of Oriental Studies named after Abu Rayhon Beruni of the Academy of Sciences of the Republic of Uzbekistan Scientific collection "Oriental Studies" №16. Tashkent, 2013.

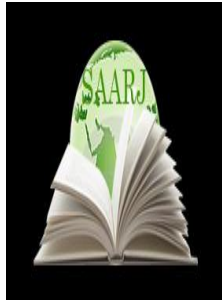

**ACADEMICIA**  
**An International**  
**Multidisciplinary**  
**Research Journal**  
 (Double Blind Refereed & Peer Reviewed Journal)



**DOI: 10.5958/2249-7137.2021.01307.0**

## THE TAX SYSTEM AS A STRUCTURAL LINK OF THE FINANCIAL SYSTEM

**Javlonbek Butaev\* ; Umurzoq Radjabov\*\***

\*Master,  
 Tashkent Institute of Finance,  
 UZBEKISTAN

\*\*Associate Professor,  
 Tashkent Institute of Finance,  
 UZBEKISTAN

### ABSTRACT

*Democratization and renewal of society in Uzbekistan, modernization and reform of the country's economy require a comprehensive reorganization of the activities of various sectors. Because the spheres form a holistic system of interdependence, gaining specific features. The article emphasizes that the ongoing reforms in Uzbekistan are aimed at establishing a socially oriented market economy and ensure economic stability, free conditions for the activities of citizens and economic entities based on democratic principles.*

**KEYWORDS:** *Tax, Tax System, Market Economy, Commodity-Money Relations, Tax Policy, Income, Expenditure, Taxpayer, Government, Tax Reform.*

### INTRODUCTION

The ongoing liberalization process in our country is also inherent in the tax system. "The tax system, as an integral part of the reform process, as its internal driving force, must meet the goals of economic reform as much as possible" [4]. Accordingly, it should be noted that tax reform is a continuous process, which is affected by quantitative and qualitative changes in the economy. Tax reform is based on certain theoretical views, which are inextricably linked to the scientific views on market relations.

It is now important to encourage the improvement of living conditions through the tax mechanism by ensuring employment, further increasing incomes, ensuring a steady increase in the value of property and assets. In this regard, the Action Strategy for the Development of the

Republic of Uzbekistan for 2017-2021 identifies "... continuation of the policy of reducing the tax burden and simplification of the tax system, improving tax administration and expanding appropriate incentives" [3].

In the context of liberalization and modernization of the economy in Uzbekistan, priority is given to studying the problems of increasing real incomes, steadily improving their living standards and quality, stimulating consumer demand through the tax system, improving real incomes.

### **MATERIAL AND METHOD**

In the modern scientific and economic literature (P. Samuelson Economics, P. Haynes Ekonomicheskij obraz myshleniya, McConnell K. Bruce. Economics; Principles, Problems and Politics. Fishers., R. Dornbush Schmalenzi. Economics M. Delo.) The market system is such an economic system. It is considered that a decision is made on the use of limited production resources, subject to price targets. If a certain product is created at the expense of limited resources, it is necessary to give up the production of another such product. In a market economy, demand and costs are the main criteria for this choice. This choice involves the degree of profit and loss [6].

In the process of functioning of the market mechanism on the basis of supply and demand, it is observed that the needs of consumers are related to producers, and through them, to intermediaries. The competitive environment that arises in this process, by its very nature, requires the satisfaction of the needs of the economic entity and requires the priority of the basic principles of the economy (Figure 1.1.1). These principles apply in an interconnected, systematic way.

Market economies are viewed differently in terms of humanity and development prospects, and they are reflected in a number of views aimed at supporting market relations.

The above-mentioned functional principles of the market system also apply to the financial system. According to him, the financial system is considered in a broad sense. Such a view is also found in some dissertations. In our opinion, such views are correct. In the past, finance was understood as a state-owned financial relationship, and this reflected the real situation in the totalitarian-planned system.

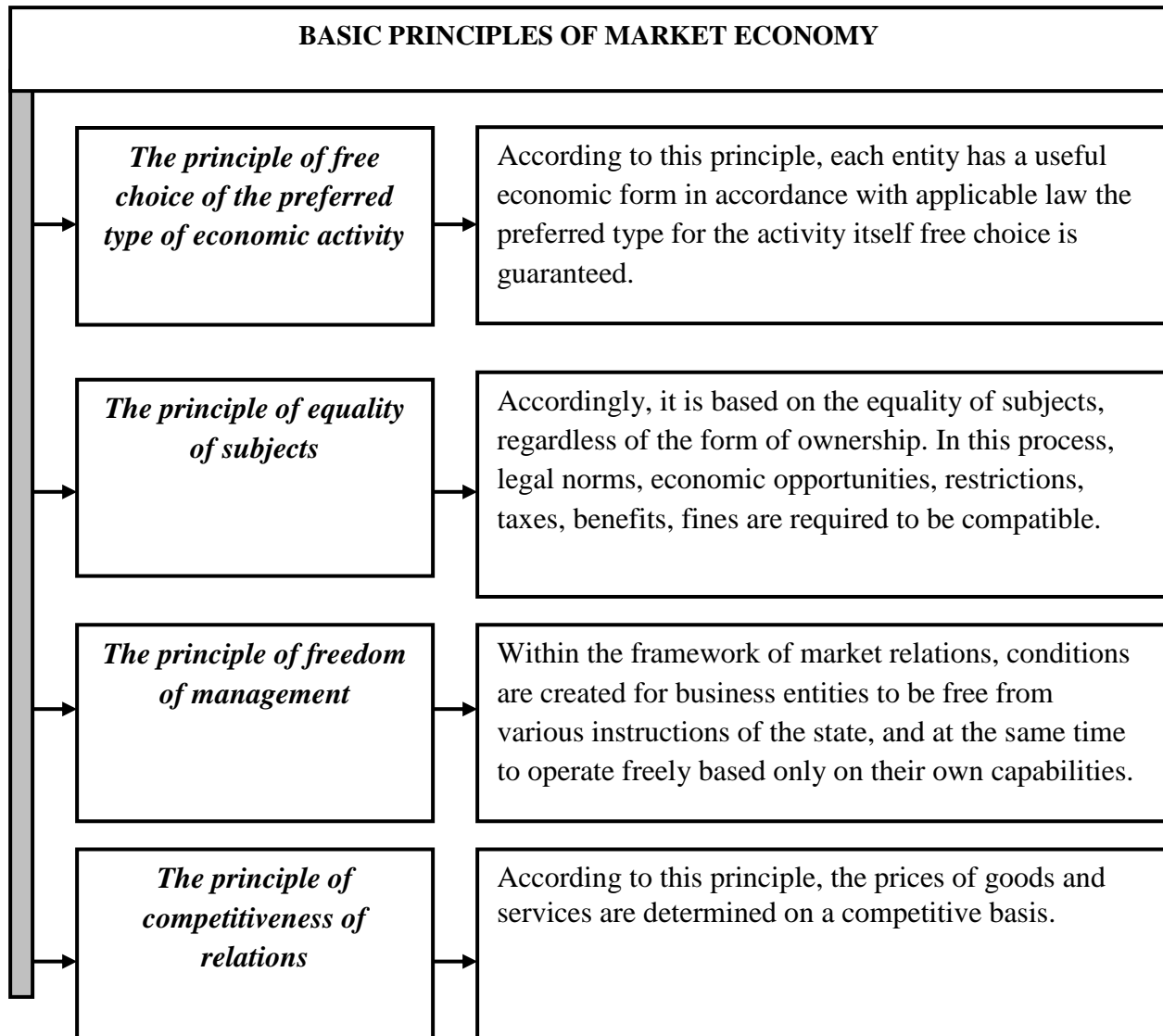

**Figure 1.1.1. Basic principles of market economy**

Finance is evaluated in terms of the market system in the current view, and this is certainly true because finance has always been a link in the economy. The current economy is a two-sector structure, consisting of the real and monetary sectors, the real sector is tangible and intangible production, where goods and services are created, which are consumed through market exchange and re-produced, for which resources are taken from the market. used. This process is constantly reversed, resulting in a macroeconomic cycle.

The movement of goods and services created in the real sector from production to consumption takes place through commodity-money relations, which is why the money sector is needed.

Enterprises, farms, households and various non-governmental organizations, which are micro-level entities, receive the monetary equivalent of goods and services, satisfy their needs by purchasing resources and consumer goods.

In manufacturing firms, turnover is in the form of money→resources→goods→and money. This movement takes the form of resource → money → commodity in households. In NGOs, this movement is limited to cash and commodity flows.

When the turnover goes beyond the national sphere, there is an international, ie mega-turnover, which also consists of material and monetary movements. At any level, real turnover is primary, because through them are created branded services that have value. In contrast to their movement, the movement of cash flows arises because money serves to convert them.

Cash flows also occur between different entities, which include firms, households, government and non-government organizations. While cash flow refers to the movement of goods and services, they mean that market value is measured. When this value is distributed, income and expenses are generated, which create finance as a value category. They go in the opposite direction, i.e. the income of one entity creates an expense for the other entity at the same time.

In this sense, if taxes are revenue for the state, they will be an expense for other entities. Income and expenditure can be said to be integral categories of finance, as they are specific to all sectors of the economy and are part of the financial system.

This system is multi-tiered, it cannot be limited to pure financial relations, as it includes financial institutions and financial policy. A number of authors advocate finance in the broadest sense and incorporate it into the system [7].

Based on this, it is appropriate to look at the tax system in a broad sense. There are views on the classification of finance according to the level of production [8]. Accordingly, micro-macro-mega finance is allocated.

The macrofinance system forms two large blocks. The first is the fiscal system, the second is the budget system. These are structurally state structures, one of which represents government revenue and the other means that it is spent through the budget.

As the fiscal system is part of finance, it is appropriate to consider it as a sub-system. This system is also multi-element, each of which has its own function. But they cannot be outside the system and form integrity by requiring each other.

At the heart of the tax system is a tax relationship. The difference between these and other economic relationships is that most entities enter into a relationship with a single entity. While the majority are individuals and legal entities that pay taxes, the sole taxpayer is the state.

However, when the state spends taxes as income, it is in the public interest. The state, by means of its own mechanisms, relies on institutions that have the force of legal coercion against its own population, represented by the term "society" in a particular area, and it has the upper hand in the legislature<sup>1</sup>.

The state can coerce subordinates based on tax legislation. At the same time, the state provides the population with social benefits that are difficult for members of society to obtain through the market and have special characteristics.

The social protection function of the state is focused on maintaining security and social order. The state must prevent possible harm to each other and ensure that citizens live in peace, ensure strict compliance with applicable laws, and monitor compliance with the rules of society.

A number of problems arise when the state does not effectively perform its function. In particular, there are cases when the market mechanism can not be used to determine the actual costs of production of goods (services, works), inefficient use of resources, environmental pollution in cases where property rights are not clearly defined or protected. The elimination of the negative consequences of these cases will be mainly at the expense of the state.

Another important task of the state is to create conditions for the development of reproduction. At this point, this functionality requires funding and this is covered by taxes. The state does not replace the market mechanism, but takes measures to ensure its functioning when this mechanism becomes incompetent. The state undertakes to develop solutions to socio-economic problems that this mechanism cannot solve (sometimes through ineffective solutions). Given the need for state regulation of society, it should be noted that there are normative limits to its intervention in the economic process. Within this boundary, it primarily affects market participants through taxes.

In this ranking, the tax is the main means of influence in the hands of the state, which determines the nature and role of taxes in the current market economy. It should also be noted that there are currently a number of terms and definitions to describe the tax elements (Figure 1.1.2).

<b>Tax elements</b>
<b>Tax subject</b> - taxpayers (legal entities and individuals) involved in tax relations, as well as tax collectors (tax authorities), as well as entities that assist in their collection (banks, commercial courts, etc.);
<b>The object of taxation</b> is a property, action, result of action or other situation of value, quantitative or physical nature, in the presence of which the tax legislation creates a tax liability on the taxpayer;
<b>Tax base</b> - represents the value, physical or other property of the object of taxation;
<b>Tax rate</b> - the amount of tax calculated as a percentage or absolute amount of tax calculated per unit of measurement of the tax base of the tax rate;
<b>Tax benefits</b> - certain categories of taxpayers have advantages over other taxpayers under tax legislation, including the ability to avoid paying taxes or pay them in smaller amounts;
<b>The source of taxation</b> is the income from which the tax is paid, or in some cases property;
<b>Tax payments</b> - the amount established by law and expressed in money transferred to the budget;
<b>Tax burden</b> is the amount of all taxes and fees paid by taxpayers.

*Figure 1.1.2. Tax elements*

Taxes emerge as a means of collecting the necessary part of the national product created in the country, which is required for the state to perform its functions.

Taxes, being a financial instrument of state regulation of the economy, also determine that the state is a subject of a market economy.

When describing the modern tax system, it is first necessary to assess the essence of taxes, because on their basis emerge financial relations. Taxes are also the main financial category that reflects the commodity-money relationship.

In the current literature, taxes are traditionally interpreted as mandatory, non-equivalent payments levied on individuals and legal entities to the state budget and extra-budgetary funds in accordance with applicable regulations [10].

It should be noted that the large number of different payments, which are the sources of revenue generation of the state budget, creates certain problems in the interpretation of taxes. In particular, there is a need to select clear bases in the study and classification of tax types. At this point, we found it necessary to dwell on the special economic features of taxes, that is, the difference between them and other payments.

Taxes, unlike other payments, mean the alienation of taxpayer property in favor of the state. Taxation is based on a legal basis. Government agencies set rules and norms for taxation, and taxes are collected compulsorily. Taxes vary, they generate non-refundable payments, they become financial resources at the disposal of the state.

Taxes are payments set by the state, which is a subject of transparent law, in which the interests of the state and society are reflected. Therefore, the right to impose taxes is determined by law. The Constitution of the Republic of Uzbekistan states that the introduction of taxes and mandatory payments is the competence of the Oliy Majlis, the highest state body exercising legislative power [1].

The interpretations of the essence of taxes by economists of our country in recent years are also noteworthy. In particular, it should be noted that the interpretation of taxes as a monetary relationship representing a mandatory payment has somewhat expressed their current nature [9].

Obligation in taxes means the responsibility of the lower economic entities to society in the form of the state. This is primarily a social obligation that stems from the social orientation of the market economy.

This direction means that economic prosperity is ensured through the market through fiscal policy. The source of funding for this is the taxes levied.

Taxes differ from other payments by their non-equivalence. In our view, inequality cannot be understood as absolute inequality because there are two aspects to it. First, there is really no equivalence between the money a taxpayer gives and the social benefits he receives from the state. Equivalence occurs when goods and services are paid for according to their market value. Social benefits convertible into taxes have no market value, as the state provides them free of charge to individuals and legal entities, as well as to the general population. Since these services are social, everyone consumes them. Therefore, everyone benefits from the services of law enforcement and security agencies, education, health, beautification and normalization, ensuring a normal life.

Since these services are common consumption, it is impossible for each group to use them and the other not to use them. The presence of non-equivalent payment of taxes is relative to some taxpayers. At the community level, there is a certain equivalence, i.e. equality, between taxes and the cost of social services.

The amount of taxes should, as a rule, be sufficient to cover the cost of social benefits. Social benefits are not created for commercial purposes and for profit. In this way, they differ from the goods that are bought individually from the market and consumed. It is therefore sufficient to cover the cost of social benefits. This task is performed by taxes. However, taxes are not the only source of funding for these services, as revenues other than taxes are also involved in their creation. In conclusion, they can be interpreted by making a number of additions to the principle of tax inequality. In the scientific literature, the tax system is interpreted differently, in the narrow sense, "the sum of taxes and other payments collected in the prescribed manner constitute the tax system" [10].

### **Results**

Based on the results of the study, it should be noted that the tax system is a set of principles and taxes, as well as the forms and methods of their collection, modification, abolition, collection and control.

However, the study of views on the tax system shows that in the future there will be a broader interpretation of this system and it will be considered in terms of tax practice. Such an approach also has its bases.

Recognizing this, it was agreed to evaluate the tax system in terms of the concept of economic systems. Based on this concept, the tax system should be viewed as a complex that embodies structurally complex elements

This complex includes the tax system "taxes - tax objects - tax subjects - tax mechanism, in addition, tax institutions - tax legislation - tax policy"(Figure1.1.3).



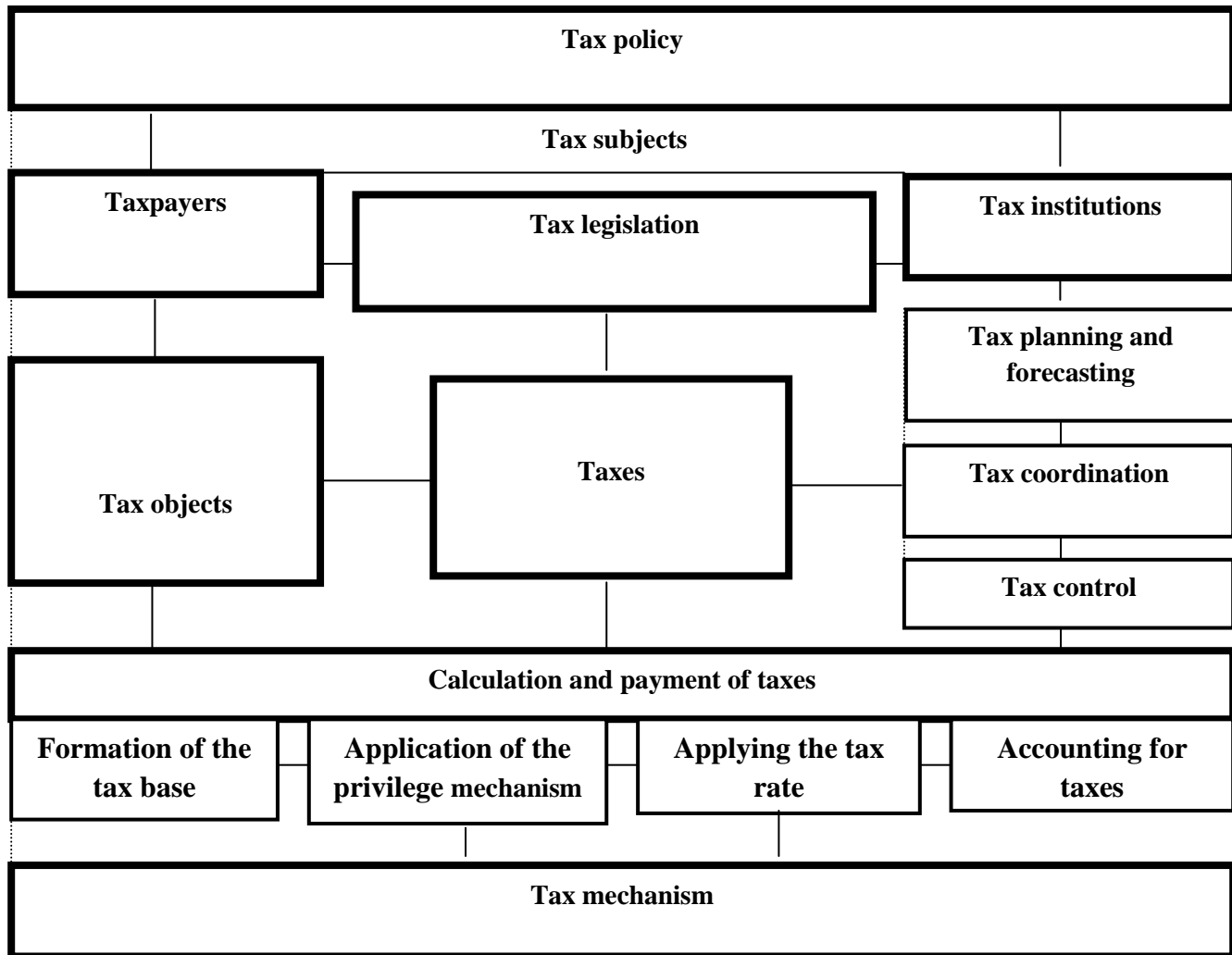

*Figure 1.1.3. The structural structure of the functional tax system*

From the author's point of view, taxes themselves do not form a system, because the system must have a set of relationships in which different elements interact. The tax system includes not only tax relations, but also tax infrastructure and tax policy. The main element in the tax system is taxes.

A leading element of the tax system is the tax mechanism. This mechanism consists of tax rates, tax benefits, tax penalties, the establishment and collection of taxes, and, if necessary, their modification and regulation. The tax mechanism includes administrative instruments in addition to economic instruments.

In the tax system, tax institutions perform the function of infrastructure, the activities of which are determined by law.

Tax legislation serves to regulate the tax system, ensures the integrity of the tax system, its state control. Legislation is the legal basis for the implementation of tax principles.

Tax policy manifests itself as a system-forming element, but tax policy, unlike other types of economic policy, is only public policy, in which economic coercion is accompanied by administrative coercion.

Each of the above-mentioned elements performs a specific function, they interact with each other as required, and one creates the conditions for the other to act. They form the basis of the tax system as a whole and serve the implementation of its functions.

There is a traditional succession in tax principles and views in tax theory<sup>2</sup>. In particular, in Amir Temur's "Temur's Statutes" principles such as humanity - a special approach - convenience - low cost - fairness were applied to taxes. While Amir Temur interpreted tax principles in terms of fiscal efficiency, tax principles were studied by A. Smith not only in terms of fiscal but also economic impact [11]. His theory states that the tax system should be based on such principles as: generality - stability - equal distribution - obligation - social justice - clarity - neutrality.

A number of other scholars have also expressed certain views on the principles of taxation. In particular, the Russian economist N. Turgenev recognized such specific principles as equal distribution of taxes - accuracy of taxes - convenience of timing of tax collection - low cost of tax collection - the existence of a general rule in tax collection [12].

In modern tax theory, tax principles are considered much more broadly. The functionality of these principles serves the economic and social efficiency of the tax system. The newly formed tax principles in Uzbekistan have a legal basis and are reflected in the figure (Figure 1.1.4).

At the current stage of the market economy, the methods of tax collection are used, such as cadastral, declaration, source of income, administrative. Another important aspect of the modern tax system is taxation based on the natural and value base of the tax. For example, taxation on a natural basis is used in a number of countries to collect household taxes, personal taxes, special duties. Taxation on the basis of value is applied to the bases of gross and net income. An important aspect that had a significant impact on the nature and role of taxes was the wider spread of taxation as the wealth of the taxpayer increased.

This approach requires that the total amount of taxes levied on taxpayers not, firstly, exceed the income of taxpayers, and secondly, that they constitute a certain normative part of their income.

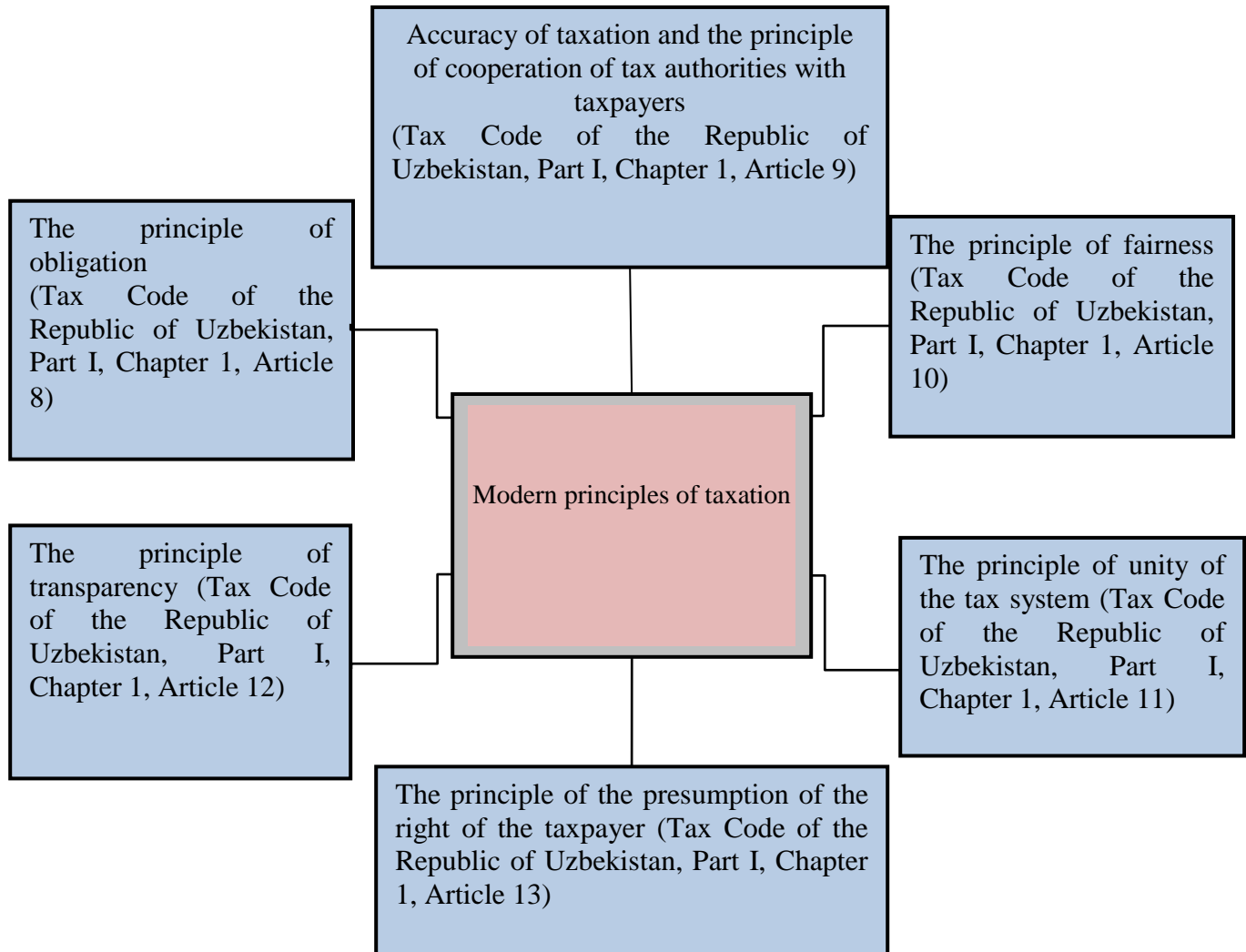

*Figure 1.1.4. Principles of taxation provided by the legislation of Uzbekistan<sup>3</sup> [2]*

## CONCLUSION

From the above, it can be concluded that the tax system consists not only of tax relations, but also of tax legislation, tax policy and tax institutions. In this system, the basic principles of taxation are followed. It is necessary to look at the tax system as an integral part of economic development, as it adapts to it in the context of economic transformation. The efficiency of the tax system and the quality of service provided to taxpayers by the staff, of course, the selection and placement of personnel, the implementation of systematic work to fill the tax authorities with highly qualified staff, as well as crime prevention among them and their service. requires the creation of conditions. In order to strengthen financial and budgetary discipline and ensure balanced execution of the budget of the Republic of Uzbekistan, it is necessary to ensure the full collection of taxes and other mandatory payments, maximum legalization of employed citizens and increase the salary fund. One of the urgent measures of the state is to expand the tax base, identify additional sources of revenue to the budget, develop, ensure and monitor the implementation of "Road Maps" by districts and cities to ensure its balance, taking into account the strict responsibility of individuals.

---

**REFERENCES**

1. The Constitution of the Republic of Uzbekistan. T.: Uzbekistan, 2016, 28-p.
2. Tax Code of the Republic of Uzbekistan (new edition). 30.12.2019.
3. Decree of the President of the Republic of Uzbekistan dated February 7, 2017 No PD-4947 "On the Action Strategy for further development of the Republic of Uzbekistan".
4. I.A Karimov, "Uzbekistan on the way to deepening economic reforms", T., "Uzbekistan" Publishing House, 1995, 204 p.
5. P. Samuelson Economics // trans. from English M., 1992, p. 6-9; P. Haynes Economic Way of Thinking trans. from English M., 1993-p. 27-29; McConnell C. Bruce. Economics; Principles, problems and policies. per. from English M., 1992, p. 36-40; Fishers, R. Dornbusch Schmalenzi, Economics, translated from English. M. Delo, 1995. pp. 1-3, etc.
6. Olmasov A., Vahobov A. "Economic Theory", T.: 2006, pp. 377-378.
7. Olmasov A., Sharifkhodjaev M. "Economic Theory", T: Mehnat, 1995, p.368.
8. Q.Yahyoev. Theory and practice of taxation. Textbook (revised) T, 2003, p.
9. Chernik D.G. Fundamentals of the tax system, -M.: UNITI, 2000; Pushkareva V. History of financial thought and tax policy. - M.: INFRA.M, 1996.
10. T.S.Malikov. Current issues of taxes and taxation. - T "Academy", p. 163.
11. Smith A. Research on the nature and causes of the wealth of peoples. T.2. - M.: Sotsekgiz 1935, p. 341.
12. N. Turgenev. Experience of tax theory // At the origins of financial law. -M.: Status, 1998, p. 129.

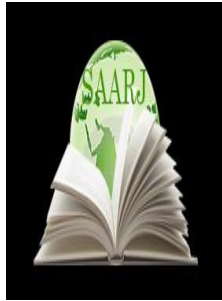

**ACADEMICIA**  
**An International  
 Multidisciplinary  
 Research Journal**  
 (Double Blind Refereed & Peer Reviewed Journal)



**DOI: 10.5958/2249-7137.2021.01308.2**

## USE OF MULTIMEDIA TECHNOLOGIES IN THE EDUCATIONAL PROCESS

**Lobar Abdimannobovna Muxtarova\***

\*Lecturer,

Termez State University, Termez,  
 UZBEKISTAN

Email id: lobar.muxtarova@mail.ru

### ABSTRACT

*This article highlights the issue of techniques for the effective use of multimedia in improving the quality and effectiveness of primary school reading lessons. Primary education is carried out with the wide and effective use of multimedia, active teaching methods, and gaming technologies. With the effective use of multimedia, students develop the ability of active and logical thinking, attention, logical memory, mental ability.*

**KEYWORDS:** *Multimedia, Develop Ability, Logical Thinking, Primary Education, Efficiency.*

### INTRODUCTION

The main purpose of the large-scale work to improve the education system of the Republic is to improve the quality and effectiveness of education of the younger generation, their upbringing and their strong education. It is the creation of all the necessary conditions for acquiring knowledge and highly skilled professionals with the ability to acquire new knowledge, acquire professional excellence and possess professional flexibility in the context of modern technology that requires new in-depth knowledge. to improve the quality and effectiveness of the educational process through training. This, in turn, requires the organization of the learning process based on the latest scientific achievements and the effective use of modern teaching technologies.

Upbringing the young people as healthy people is one of the most important tasks in the social life of our society. At the same time, President Mirziyoyev said: "Another important issue for us is to bring up our children as genuine patriots with independent thinking, modern knowledge and skills, with a solid life position. is a function" i would like to point out that. Indeed, the stronger the knowledge, the more the student's worldview and intellectual potential develops and

matures[1]. For today, information literacy for students is an essential prerequisite for improving the effectiveness of education.

The Uzbek model of the National Program for Personnel Training, first of all, provides the students with the knowledge, skills and abilities needed to realize their potential, meet their material and spiritual needs, and promote the activities of young people. and create an education system that aims to serve the development of society, science and industry. In this regard, education should focus on teaching the development of our independent country, which is achieved by independence. It is important to remember that one of the main tasks of the present is to improve the quality of teaching through innovative approaches and the introduction of advanced state-of-the-art technologies into the learning process.

The Education Act states that "Elementary education is aimed at developing the basics of literacy, knowledge and skills necessary for general secondary education[2]." During the first three years of the elementary school, students will be able to read and understand words and expressions correctly, including emphasizing the meaning of the words. They acquire such knowledge and skills. In the fourth grade, students' learning abilities and skills will be further enhanced. That is, the emphasis on reading comprehension and working on the text is enhanced.

## **MATERIALS AND METHODS**

In the State Standard of Secondary Education By training students to develop logical thinking, mental development, worldview, communicative literacy and self-awareness, to experience the beauty of material existence, to enjoy beauty and sensuality[3]. At the same time, the aim of the primary education "to broaden their understanding of the subject, to expand their activities, to be able to think freely, to acquire the skills and abilities of others" is to guide students in creative thinking through innovative approaches. , it is important to teach changing situations, create independent activities based on free competition. This requires students to think creatively, to develop free thinking, to develop critical thinking skills, and to make learning easier.

As you know, most of the important tasks of teaching elementary school students are in the classroom. During the reading and speaking lessons, the students are given some knowledge based on the topics identified in the program. In addition to improving reading skills, the focus is on educating students in a spiritually mature human spirit. In the primary school, students are taught to read accurately, intelligently, fluently, expressively, through the lessons that follow the goals and objectives of the reading and speaking program. Children learn to work with books in this process, and they develop a love for the book. Qualitative and effective implementation of this process depends directly on the organization of training courses using an innovative approach.

According to the reading and speaking program, fourth-graders should be able to read texts that are relevant to their knowledge at a reasonable, expressive and normal speed. It is advisable to improve the reading skills of students in two ways. First, there are ways to overcome some students' learning disadvantages.

Second, special attention is paid to the further development and improvement of the reading comprehension skills of all students. The most effective way to develop children 's reading and expressive reading skills is to enhance their reading comprehension and vocabulary.

It seems that the teacher should constantly work on improving the reading skills in this class, enriching the child's speech by providing expressive reading. Innovative learning in this process, the use of various tools and innovative learning technologies throughout the classroom is an important factor in improving the quality and effectiveness of teaching.

As Professor K. Yuldashev rightly points out, "School literature is not a teaching tool but an educational tool. In fact, rather than a reader who can scarcely tell the facts about the history of literature, but lacks good moral qualities, he is able to absorb the most human qualities inherent in the heroes of fiction, even though he does not know some literary information system. readers who seem to be inactive rather than outward are more important to our society... Literature is to create a beautiful spiritual world in a beautiful world[4]." According to the scientist, the task of teaching literature is to instill in readers a sense that each nation can be perceived in a unique set of spiritual values. After all, a person who does not know how to build their own spirituality is like traveling to an unknown country without a map, and is in danger of being distracted.

Thus, a number of measures are being taken to educate teachers based on the innovative approach to the educational process, to introduce the best international practices in the educational process, to develop the professional competence of teachers.

That is why it is theoretically and practically important to focus on the innovative teaching and learning skills of teachers in the elementary school classrooms, and the problems of selecting and applying the most appropriate educational technologies.

Innovative learning technologies are a systematic way to create, apply and define technical and human resources and their interrelationships, with the goal of enhancing the effectiveness of forms of learning throughout the learning and learning process. Widespread access to modern knowledge is one of the most important requirements of today.

Providing students with knowledge and skills in accordance with the requirements of the State Educational Standard through the materials provided in the textbook of the elementary grades to instill a sense of love for the motherland and the Uzbek people; - to convey to students the knowledge required by the program during the training sessions; improving reading and speaking skills; the artistic work that is given is meant to visualize images.

The lessons are particularly important in the elementary education system, in terms of their essence, goals and objectives. Not all subject classes can be imagined without reading activities. This is because reading comprehension and reading comprehension, rhythmic and expressive reading. The training sessions provide students with the opportunity to acquire the knowledge and skills required by the State Education Standard.

## **RESULT AND DISCUSSION**

It is necessary to take into account the age and the level of knowledge of the students in order to form an idea and understanding of what is happening around them. In order to educate students in the spirit of national independence, love for their homeland and people, love and respect for workers around the world, literary literature on the motherland, its independence and its leading people and great ancestors will be taught.

In the elementary grades, especially in the fourth grade, students are treated with a sense of self-efficacy and a sense of community. and in the fourth grade, students' learning abilities and skills

will be further enhanced. That is, the emphasis on reading comprehension and reading is enhanced. In reading classes, it is important to form a desire to read a literary work on a regular basis. It is very difficult, and if it is not implemented, the learner will have little or no learning skills. The formation of an independent reading of artistic work in students depends on the ability to see, understand and feel the attractive aspects of the artistic work. The breadth of this knowledge and experience requires the student to develop his abilities in artistic observation.

Coaching is an important part of the younger generation to develop independent thinking and nurture a healthy and harmonious generation. In the future, only independent-minded students will be able to become full-fledged, fully developed people, and will bring our independent republic to the leading world countries.

In this regard, Z. Nishonova's article on Teaching Independent Thinking: It is worth noting that the present system of learning is also aimed at developing more memory. However, some teachers are more likely today to explain a subject, to make it ready for readers, and to ask for the content next day or to memorize a poem. Such a lesson does not create any problem, and it does not allow students to understand the subject matter freely and independently in the classroom. Teachers themselves know that students cannot think independently. But how can a student gain the ability to think independently in a classroom? It is difficult to answer this question [5].

The skills of a teacher in the emerging elementary grades, his ability to integrate modern technology into the learning process, to find new ways and means of teaching, to use the best pedagogical experience is very important. Therefore, it is essential to prepare future elementary school teachers for future activities and to prepare innovative teaching technologies for implementation. Because innovative educational technologies provide first and foremost opportunities for students to easily acquire knowledge, skills and abilities; One of the main reasons for the development of innovative education is the educational crisis. Different countries have the following in common: Differences between the evolving needs of social practice and the actual training of graduates in higher education institutions; set new goals for primary education and complicate organizational structure and forms of management; interests and opportunities of the subjects of the educational process[6].

## **CONCLUSION**

Thus, innovative activity is considered to be a solution to a number of problems that arise as a result of the incompatibility of traditional norms with new social requirements or the emerging norms of practice. It is organized at the expense of organizational, technological, methodological and creative readiness of the person, especially the pedagogue for the organization of the innovation process. The educational system or process is constantly evolving, allowing pedagogical innovation to consistently innovate pedagogical activity. The goal is to get the best possible results from the amount of effort and effort invested in innovation in the education system or educational activities. Innovation is different from any other innovation, and it needs to have a flexible mechanism for managing and controlling it[7].

In summary, the innovative approach of the teacher is seen as a driving force, motivation, and motivation for the teaching team, and it guarantees the quality and effectiveness of the learning process.



**REFERENCES**

1. Sh.M. Mirziyoev “We Build Our Great Future Together With Our Brave and Loving People” T., 2017
2. The Law of the Republic of Uzbekistan “On Education”. - T. 1997.
3. State Secondary Education Standard - T., 2017.
4. Nishonova Z. Teaching Independent Thinking // The Journal of Labor Education. 1999. No. 3.
5. B. Khodjaev, Sh.Zufarov. Pedagogical innovations. -T.: "Science and Technology", 2010
6. Sultonova GA Pedagogical skills. - Tashkent: TSPU, 2005
7. Matchonov C., Shojalilov F., H. Gulomova, Sh.Sharieva, Z.Dolimov. Textbook for 4th Grade T.: 2015.
8. Farfiyeva K. A. Social Media as a factor in formation of scientific thinking in youth. European Journal of Research and Reflection in Educational Sciences. Vol. 8 No. 10, 2020. – Pp. 52-56.

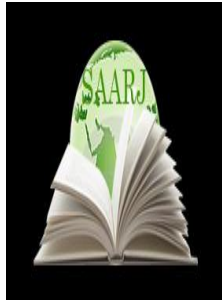

**ACADEMICIA**  
**An International  
 Multidisciplinary  
 Research Journal**  
 (Double Blind Refereed & Peer Reviewed Journal)



**DOI: 10.5958/2249-7137.2021.01309.4**

**INSURANCE AGENTS AND SIGNIFICANT ASPECTS OF IMPROVING  
 THEIR ACTIVITY**

**Matiyazova S.R\***

\*Independent Researcher,  
 Tashkent Institute of Finance,  
 UZBEKISTAN

**ABSTRACT**

*This article considers essential peculiarities of the activity of insurance agents. Moreover, the article analyzes the ways to improve the activities of insurance agents under conditions of pandemics. The agreement of the agency may also specify the performance of other services and duties by the insurance agent. An insurance agent is a representative of a particular insurer who buys insurance products from a particular insurer. An insurance agent may also represent several insurers at once. Therefore, the maintenance of the position of insurance companies in the insurance market during the global pandemic and the successful implementation of insurance activities depends on the organization of the activities of comprehensive insurance agents.*

**KEYWORDS:** *Insurance Market, Insurance Agent, Insurance Premium, Insurance Cover, Insurance Services, Pandemics.*

**1. INTRODUCTION**

As a result of measures taken to create favourable conditions for further development of the insurance services market in the country, the volume of insurance services is growing steadily and the role of insurers in the country's economy is becoming increasingly important, which in turn increases the interest of legal persona and individuals in insurance products.

In particular, the Action Strategy for the five priority areas of further development of the Republic of Uzbekistan for 2017-2021 (Prescription, 2017) also considers the development of banking, finance and insurance companies as a special priority, the development of the insurance market and the introduction of modern insurance services. requires increasing the role of the insurance mechanism in protecting business entities from various risks.

It should be noted that the proper organization of the activities of insurance agents plays an important role in the development of the insurance market, ensuring the popularity of insurance services, reliable protection of a wide range of legal persona and individuals from various risks.

It is no secret that today's global pandemic is putting various sectors of the economy in a difficult position due to its global spread. Therefore, the maintenance of the position of insurance companies in the insurance market during the global pandemic and the successful implementation of insurance activities depends on the organization of the activities of comprehensive insurance agents. Because today the growing demand for the services of insurance agents, both by insurance companies and legal persona and individuals who are consumers of their products, requires the improvement of mechanisms for the sale of insurance services electronically through their remote services.

## **2. Main Part**

The main task of insurance agents is to serve customers on behalf of the insurer and by organizing the conclusion and execution of the insurance contract on his behalf. Also, insurance agents play an important role in increasing the insurance culture of the population, the formation of confidence in insurance institutions, as well as in an insurer.

Payment of insurance coverage to the insured through fast and quality service: on the one hand, there is a need to increase the reputation of the insurance company and attract new customers, on the other hand - to restore production faster in case of major disasters, which is important for macroeconomic stability.

As for the essence of the concept of the insurance agent and its activities, the Glossary (2018) stipulates that on behalf of the insurer and behalf of the insurer in the interests of the insurer and within the powers granted, the legalization of the insurance contract it is emphasized that the individual is an insurance agent.

Consequently, the insurance agent carries out its activities mainly on the terms of the agency agreement concluded between the insurer and him. An agency agreement is a civil-law contract that defines the relationship, liability and powers between the insurance agent and the insurer.

In general, an insurance agent is interested in selling as many insurance services as possible by engaging in the sale of insurance services provided by the insurer. Because the insurance agent receives a commission from the insurer in the amount of a certain percentage of the insurance premiums received for the insurance services sold. The agreement of the agency may also specify the performance of other services and duties by the insurance agent. An insurance agent is a representative of a particular insurer who buys insurance products from a particular insurer. An insurance agent may also represent several insurers at once. At the time of sale of insurance products, the insurance agent must provide the insured with a document confirming the authority of the insurer to conclude an insurance contract, confirming that he is an official representative of the insurer.

Mirsadikov (2010) focused on the organization and efficiency of insurance agents, arguing that the success of an insurance contract when selling insurance services through insurance agents depends on the skill of the insurance agent, which includes the following elements, including customer satisfaction and quality. given by: establish an initial connection; introduce the company to the client; identifying customer needs; convincing the customer; explanation of

insurance terms and calculation of the cost; quick and high-quality contract execution; improving customer relationships and maintaining customer relationships, in line with the above, is based on the fact that the customer's relationship with the company is formed under the influence of the information provided by the insurance agent to the customer.

Galaguz (2008) believes that the success of an insurance company depends in many ways on the proper organization of the activities of insurance agents. In particular, it outlined the key factors that affect the effective performance of an insurance agent. In particular, the insurance agent should not ignore the following six important factors to establish a mutually beneficial relationship with the client:

- Mutual goodwill. This quality is an important condition for establishing a good business relationship. Kindness, the commonality of interests, increases benevolence;
- Mutual respect of the parties. Another important condition for a strong trade relationship is the mutual respect of these partners;
- Mutual trust of the parties. The success of sales technology is characterized by mutual trust of partners, mutual openness, conscience, "clarity" of behaviour, orderliness and reliability;
- Mutual diligence. As a seller of insurance products, an agent should make every effort to have a good relationship with the client. Indeed, without the interest of the client, the agent cannot make any change in the path of the overall set goal. In other words, the insurance agent should be friendly to the client, and on top of that help to solve his problems, try to fulfil any of his wishes. Calmness and restraint, as well as modesty, form the basis of the success of trade relations. It should also be noted that the ability of the insurance agent to communicate with the customer, mutual interest in each other's business, such qualities as flexibility, nobility and independence is some of the necessary conditions for achieving a positive result in the sales process;
- Intensity of relations between the insurance company and the client. It is important to keep in mind that relationships only improve when both sides are in constant communication with each other. If an agent selling insurance products cannot find the opportunity to maintain regular good and strong communication with customers, then all attention and efforts should be focused on high-income customers;
- To be thoroughly educated. In the process of introducing his company to the client, the insurance agent should be able to instill confidence in the client in the insurance company by giving him full information about the achievements and positive aspects of the company.

From these considerations, it is clear that the insurance agent must have a thorough knowledge of the insurance industry, be able to present himself as a fully qualified specialist in a conversation with the client, otherwise it can ruin all relationships and negatively affect the image of the insurance company.

### **3. Analysis and discussion of results**

Today, insurance is one of the most important sectors that make up the financial infrastructure of a market economy, ensuring the continuity and stability of economic growth in the country. In this regard, it is clear that the economic and financial risks that are expected to occur in all sectors of the economy due to the global pandemic will not bypass insurance companies. In particular, the expected risks in the banking system, which is the leading structure of the

financial market, the decline in incomes, the relative decline in economic development, are expected to cause various financial difficulties for insurance companies that are professional participants in the insurance market. Therefore, we believe that it is necessary to develop measures to increase the efficiency and improve the activities of insurance agents who offer insurance services to insurance companies, ie directly sell insurance services. This is because only by increasing the efficiency of insurance agents will it be possible to achieve a relative easing of the financial difficulties that are expected to occur today. At the same time, the activities of insurance agents are mainly organized based on modern information technologies. It is necessary to develop a system of remote electronic sales, establish a network of insurance agents, reduce the dependence on the sale of insurance services only to large industrial enterprises or certain industries, and expand customer diversification. For example, dependence on bank credit insurance alone may lead to a decrease in insurance premiums thereupon a decrease in lending opportunities due to a possible shortage of resources in the banking system. To prevent such cases, it is necessary to increase the ability of insurance agents to offer and promote insurance services to the general public by expanding the provision of remote insurance services.

The insurance system plays a strategic role in the modern economy of Uzbekistan, which is why the insurance system has risen to the level of public policy, the insurance market is considered by public authorities as an integral part of the market infrastructure of the country. Indeed, the sustainability of business entities in the context of deepening economic reforms largely depends on the level of development of the insurance infrastructure.

In our analysis, we rely on the data of the insurance company 'Uzbekinvest', which is a leader in the insurance market of Uzbekistan. The development of insurance activity in this company is based on continuous research aimed at developing and introducing new insurance products and improving existing insurance products. This, in turn, will ensure the diversification of insurance services, expand the consumer segment and increase the company's competitiveness in the market. In this regard, the main principle of the Company is to provide a wide range of consumers with quality and reliable insurance services by improving service and introducing modern service methods.

Due to the strict observance of such a policy in the service, the company in 2019 will receive a total of 285.6 billion. UZS of insurance premiums were collected. At the same time, of course, the share of regional branches of the company was significant, their share in the insurance premium collection was 36% of the company's portfolio.

The accumulated insurance premiums on personal insurance increased by 2 times compared to 2018 and amounted to 23.0 billion UZS. Insurance premiums in excess of UZS were collected.

To expand the coverage of the population, since last year, the organization of work in the field of tourism, insurance of outbound and domestic tourists, the development of new insurance products, the definition of specific tasks and plans for the insurance of outbound tourists from March 2019 to the end of the year. 1.0 billion collected insurance premiums in excess of UZS. This insurance service is also expected to decline sharply due to the global pandemic.

In order to further improve the quality of insurance services in the company, to create convenience for the insured, we can say that the organization has a system of online sale of insurance products.

In particular, the company has sold 7,940 insurance policies since the sale online and received 429.3 million UZS of insurance premiums.

The share of voluntary insurance in the structure of the company's insurance premiums is high, and the effectiveness of the activities of insurance agents in the receipt of voluntary insurance premiums is obvious.

**TABLE 1 DYNAMICS OF VOLUNTARY TYPES OF INSURANCE OF 'UZBEKINVEST' EIIC**

Years	Insurance premium (million UZS)	Insurance liability (million UZS)	Number of contracts
2016	88 921,39	43 581 201,06	96212
2017	113 389,04	129 899 233,56	97384
2018	149 037, 45	82 721 317,46	206147
2019	252 197,85	41 49 031,44	279716

Source: "Uzbek invest" EIIC compiled by the author based on data.

In this table, we can see the dynamics of growth of insurance premium income for the period from 2016 to 2019 by type of voluntary insurance. In particular, in 2016, the Company received 88,921.39 million UZS of voluntary insurance premiums, and in 2019 it increased to 252,197.85 million UZS. These achievements can, of course, be explained by the fact that the activities of the company's insurance agents are effectively organized.

In the insurance market, as in any other market, it is a free competitive environment that ensures the quality of insurance services and their affordability, affordability and attractiveness. The competitive environment in the insurance market is large, to a certain extent, formed by the subjects of the insurance market infrastructure - insurance agents. In addition, insurance agents are an important component in the organization of the infrastructure of the insurance market, a set of activities that ensure the effective operation of insurance and provide services in this area.

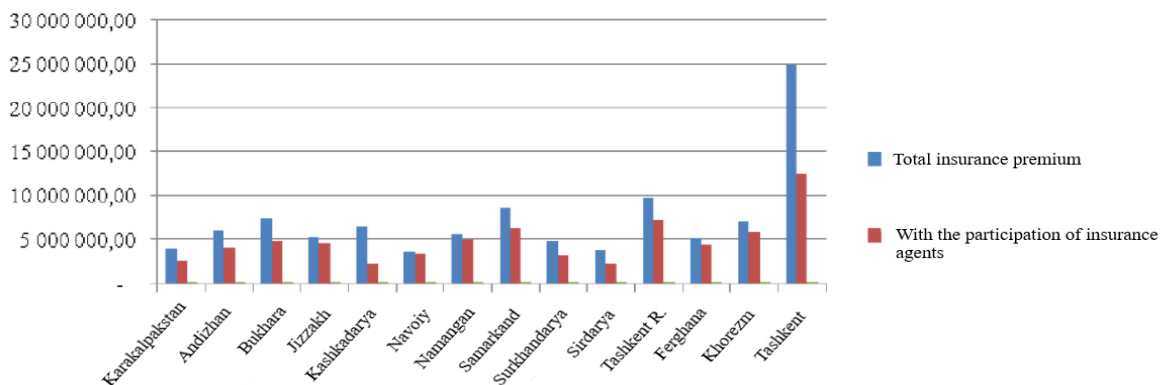
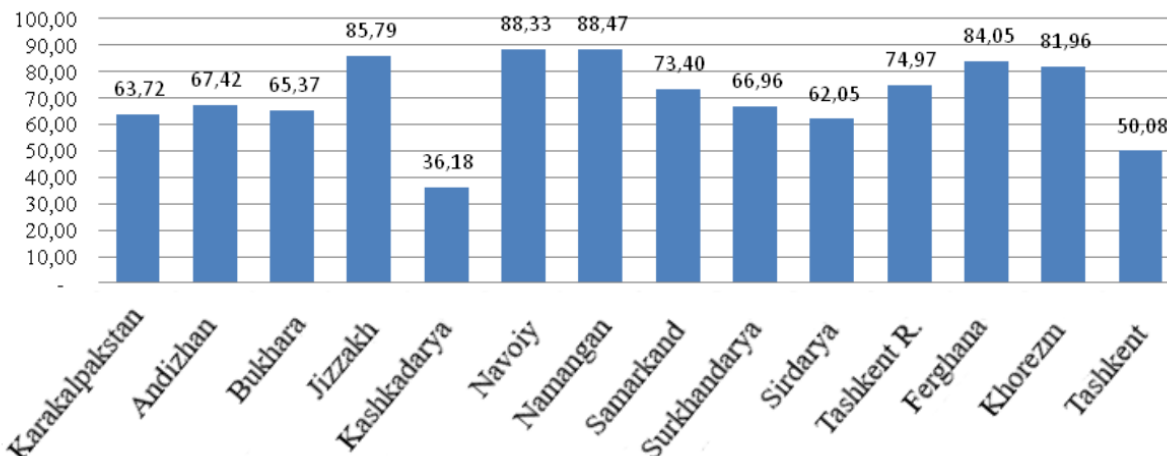

**Figure 1. Dynamics of total insurance premiums and insurance premiums collected by insurance agents in 2019 'Uzbekinvest' EIIC.**

Source: Compiled by the author on the basis of data 'Uzbekinvest' EIIC

From the analysis of the data in Figure 1, we can see that insurance premiums with the participation of insurance agents have a significant share in the formation of insurance premiums

of 'Uzbekinvest' EIIC. For example, in 2019, the Tashkent city administration paid 24.9 billion UZS in insurance premiums, of which about 12.5 billion UZS fell to the share of insurance agents. If we look at the share of insurance premiums made by insurance agents in the total insurance revenue by region, this is a much lower figure than in other provinces.



**Figure 2. Share of insurance agents in insurance premiums in 2019, %.**

Source: Compiled by the author on the basis of 'Uzbekinvest' EIIC.

The analysis of these data shows that the share of insurance agents in total insurance revenues is the highest in Namangan, Navoi and Jizzakh regions, at 88.47%, 88.33% and 85.79%, respectively. The lowest rates are in the Kashkadarya region (36.18%) and Tashkent (50.08%). This requires further development of the activities of insurance agents.

In addition to the above positive results, there are a number of problems in the activities of insurance agents in Uzbekistan that need to be addressed. In particular, the activities of insurance agents are insufficiently developed and they do not have sufficient knowledge in the field of insurance, the level of use of information technology in the activities of insurance agents and the low capacity of remote services of insurance agents.

Insufficient development of the insurance market of the country, low public confidence in insurance and insurance companies, underdevelopment of modern insurance services, insufficient regulation of electronic sales of insurance services also have a negative impact on the activities of insurance agents.

In order to prevent this, insurance companies need to invent new approaches to the organization of insurance agents and improve the financial mechanisms for the implementation of insurance agents, as well as the implementation of positive features of the implementation of insurance agents in foreign countries.

#### 4. CONCLUSIONS AND SUGGESTIONS

Summarizing the results of the above analysis, the results of research by foreign and domestic scientists, it can be concluded that without the correct and effective organization of insurance agents in the insurance market, without improving the financial mechanisms of remote insurance services, it is impossible to achieve the expected economic efficiency.

Therefore, in order to improve the activities of insurance agents, it is necessary to do the following:

- organization of regular training to increase the knowledge of insurance agents in order to improve the image of insurance companies and improve the quality of insurance services, as well as the issuance of quality certificates to them;
- Development and introduction of financial mechanisms for electronic remote sale of insurance products by insurance agents;
- Development of insurance glossary for insurance agents;
- strengthening the legal framework for the organization of a network of insurance agents in the insurance market;
- wide introduction of market mechanisms for the activities of insurance agents;
- Development and introduction of mechanisms to increase the efficiency of insurance agents and encourage their activities by insurance companies;
- It is necessary to improve the mechanisms of insurance agents and their legal framework in the development of the insurance market.

In general, in order to effectively organize the activities of insurance agents, it is possible to increase the efficiency of insurance companies, strengthen their position in the insurance market and further develop the insurance system of the country only by improving the financial mechanisms and strengthening the legal framework for remote insurance services.

#### **REFERENCES:**

1. Galaguz N.F. (2008) Insurance intermediaries. -M.: "Training and Consulting Center Yur InfoR", - p. 208.
2. Glossary (2018). Internet site [www.glossary.ru](http://www.glossary.ru)
3. Mirsadykov M.A. (2010) Insurance Risks: A Dictionary. - T.: "Association of professional participants in the insurance market of Uzbekistan", p. 108.
4. Decree (2017) № PD-4947 of the President of the Republic of Uzbekistan dated February 7, 2017 "On the Action Strategy for further development of the Republic of Uzbekistan".
5. Lutfullaevich, Y. G. (2020). Impact of inflation on R&D investment flow: Case of five Countries. International Journal of Scientific and Technology Research, 9(1), 1970-1974.



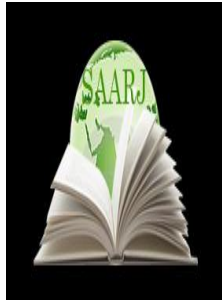

**ACADEMICIA**  
**An International**  
**Multidisciplinary**  
**Research Journal**  
 (Double Blind Refereed & Peer Reviewed Journal)



**DOI: 10.5958/2249-7137.2021.01310.0**

## THE BREATH OF THE PERIOD IN THE EPISODES OF THE NOVEL

**Mekhrison Yadgarova\***

\*Lecturer,

The museum of Literature named after Alisher Navoi,  
 Academy of Science of the Republic of UZBEKISTAN

### ABSTRACT

*A work of art is born out of a writer's desire to communicate. To say a word, the writer distributes all the elements of the work of art on the basis of a certain plan, based on the internal capacity of the work. Even the smallest detail in a work of art should serve the purpose of ideological and artistic purpose. The article deals with the small episodes in the novel "Gold is rustproof" (1965) by the National Writer of Uzbekistan Shukhrat (1918-1993), their role in revealing the artistic intentions of the writer and their life basis. The author also examines the main theme of the novel in small episodes - the repression of the years of the cult of personality and the consequences on the lifestyle and psyche of members of society - by comparing the author's "criminal case" in the State Security Service archives with other works on the subject made.*

**KEYWORDS:** *Shukhrat, Uzbek Literature, Novel Episode, Writer's Concept, Repression Theme.*

### INTRODUCTION

#### **The image of Hajar and her role in the composition of the novel**

In the manuscript of the novel "Gold is rustproof", there is an image named Hajar, who was omitted from the work. Her job is to disguise herself as Musharraf and file a complaint against Sadiq. One of the personages of the novel – Hajar is Mirsalim's trading partner. He hires her for money and admits her to the district committee on behalf of Musharraf. Hajar, in turn, performs her mission face to face without any remorse. Mirsalim thus manages to slander Sadiq by the hands of Hajar. But this character, for some reason, could not get through the censorship claws of the time.

At first glance, the writer does not place such a great task on the image of Hajar. As mentioned in the discussion of "Gold is rustproof", it seems that without it, the novel would not be incomplete, and what the writer wanted to say would appear anyway. Is that really so? What task did the writer "assign" to the image of Hajar? Was the writer able to say what he intended to say, or rather, his pain, without Hajar? We will look for answers to these and other questions below.

Nemat Toshpulatov, who was arrested in 1946 on charges of being an "enemy of the people," testified against Shukhrat during the investigation and accused him of "fanaticism" of Abdullah Qodiri. Shukhrat filed a complaint with the Supreme Court of the Uzbek SSR, alleging: "Witness Toshpulatov's testimony was a personal prejudice - because he suspected me of his wife ... ..He acted this way after he was shown a photo of his wife and me together..."<sup>1</sup>. Shukhrat's statement, frankly, surprised us. Why does Toshpulatov suspect that his wife was in a relationship with Shukhrat? In general, why does Shukhrat take a picture with someone's wife, more precisely, how do they take a picture of them? The questions are tricky. Wouldn't the answer be even more daring?

Considering that someone must have heard this, we sought answers to these questions from Shukhrat's contemporaries who had known him: Poet Shukrullo could not remember the incident, and the literary critics – Umarali Normatov and Naim Karimov had not heard of it. In short, the puzzle was not solved.

We continued to search the archive, trying to find answers to these questions here and ...

Let's listen to the testimony of the convict and witness Mukhiddin Komilov: "... in addition, investigators – Konyukhov and Sukhanov incited me against Alimov. It was said that Alimov was in contact with my wife after my arrest. Sukhanov showed me a photo card with a picture of my wife and Alimov to confirm his statement. This made me against Alimov. As a result, I signed an investigation report with false instructions against Alimov"<sup>2</sup>.

Apparently, the photos were shown to other prisoners as well as to Toshpulatov. This allowed us to find the tip of the iceberg. As we read the criminal case, the document began to reveal its secret to us.

Continuing the testimony, Komilov said that the photo was taken in Eski Jova. He also admitted that the investigators showed him a poem by Shukhrat called " to M ... " and they said that Shukhrat dedicated it to his wife to make him jealous (M. Komilov's wife's name was Mubarak). ) In the end, Komilov also testified against Shukhrat. In general, "Aminjonov Gulom was arrested on February 10, 1951, on the instructions of Mirzaev Yongin, Abdullaev Habibulla, Latipov Khalil, Mirzaev Inom, Komilov Muhiddin, Husankhodjaev Said Ahmad and Toshpulatov Nemat"<sup>3</sup>.

These prisoners were Shukhrat's comrades and colleagues, all of whom were arrested in the second half of the 1940s, that is, before Shukhrat's detention. Later, in a 1955 re-investigation for Shukhrat's official rehabilitation, all but Toshpulatov denied previous accusations with pretexts like "I said it out of compulsion," "I had to say it because I was beaten," "I said it because of mental torture and jealousy, and Shukhrat was in fact innocent." Thus, they refused the testimony they had given.

The above passage is also taken from these 1955 investigative reports. Komilov went on to say that he later found out through his wife that the allegations were fabricated. Shukhrat himself

testified about it: "... my poems were dedicated to my beloved" M.T "- Mukharram Toirova," - not to M.K.– Muborak Komilova"<sup>4</sup>. In general, the women in Shukhrat's life are a separate topic. He informs about this in the 14th volume of the criminal case and counts them by name.

In addition, U.Normatov, a literary critic, wrote about Shukhrat's Azerbaijani mistress in his pamphlet "Shukhrat"<sup>5</sup>. Based on this instruction of the author and the pamphlet of U.Normatov, it can be concluded that Shukhrat had no contact with the wives of his friends. Special agents, who knew Shukhrat's nature, skillfully used it. His friends, in turn, believed this lie. On the one hand, the betrayal of a friend, on the other hand, jealousy ...

Mirzo Kenjabek, poet, in his documentary book "Free heart. Shukhrat's life in detention" wrote that after his release from prison, he reconciled with all the above-mentioned people, except Nemat Toshpulatov. Only Toshpulatov and Shukhrat's relations remained cold.

Muhiddin Komilov was Shukhrat's groupmate at the Transport College, and Nemat Toshpulatov was Shukhrat's groupmate at the Nizami Tashkent State Pedagogical Institute. They all used to live in the Old City of Tashkent. Therefore, it was natural that Shukhrat would meet both Komilov's wife and Toshpulatov's wife in Eski Jova Bazaar.

The Old Jova Bazaar is, firstly, the busiest place in Tashkent, where you can meet anyone (and their houses were close to Old Java), and secondly, if there were a relationship, as the investigators concluded, would it be logical for a woman to date in the bazaar?

We think, Shukhrat met his friend's wife by chance in the market. They did not know they were under surveillance. On the one hand, Ministry of State Security operatives who were watching Shukhrat, on the other hand, Komilov's wife, took pictures of them in the market and handed them over to the investigators. The purpose for which the investigators used the photograph has been seen above.

Ministry of State Security operatives, who carried out the order without batting an eyelid, violated the sacred value of the people. The friendship was sold very cheaply, and, sadly, the "inside" was invaded. Privacy has been compromised. This led society to deviate from its axis. As mentioned above, M. Komilov inquired and found out that the allegations made by investigators about Shukhrat and his wife were false, and restored his previous relationship with both his wife and his friend. N. Toshpulatov and his friend had a conflict, and it is unknown how his family problem was solved. In any case, obviously, it was not easy for him and his family.

Shukhrat takes these events through the prism of his soul and reworks them for the novel. By introducing the image of Hajar into the novel, the writer tries to artistically reflect how slander was organized at that time. If in life the slander was organized by special agents, the writer of the novel entrusts the task to the image of Mirsalim. Mirsalim, in turn, takes advantage of Hajar who accomplishes the task as easy as pie.

In a letter to J.W. Goethe dated September 14, 1797, F. Schiller wrote: "The poet and the artist are required firstly, to rise above reality, secondly, to remain within the emotional world. Where these two requirements meet, aesthetic art emerges. Turning an empirical form into an aesthetic form is a difficult operation, and it usually lacks either body, or spirit, or truth, or freedom"<sup>6</sup>.

Even if we apply the word "writer" instead of the words "poet" and "artist" in Schiller's statement, the essence does not change. The main issue is the rise of reality to the level of art -

the creation of a truly artistic image. It seems as if something is missing in the character of Hajar, as Schiller said. The plot is well thought out, well-based. But the character of Hajar, who has to do the main work, is rather artificial, her behavior is not to the extent that the reader believes. (Maybe that's why A. Qahhor and A. Mukhtor didn't want this character to be included in the novel.)

Neither Toshpulatov's wife nor Komilov's wife was aware that, on the one hand, they were laying the groundwork for the imprisonment of a friend of their husbands, and on the other hand, that they were disgracing themselves. Interestingly, Musharraf is also unaware that her name is being sold and slander is being prepared against her husband. But the writer continues to recreate the reality, portraying Musharraf in retrospect as a woman mired in a swamp of betrayal. Subsequent events continued in a completely different direction, and Musharraf, who had taken the easy way out of life, went to prison to ask her husband for a divorce.

### **A literary image of society and the female psyche**

"To say a few words, he (the writer - M.Y.) has to see a lot, know the events, biographies, facts, feelings, thoughts, psychology. There are areas that an engineer, an academic, does not need to know. The writer has no such field. The life experience of a writer is a golden fund ... A writer must be an experienced person who has seen a lot, tasted bitterness, can distinguish the good and the evil"<sup>7</sup>. Shuhrat, who had such an experience, incorporated the tragedy he witnessed in the next episode into the novel as a logical continuation of the first episode.

Sukhanov called her and advised her to divorce "after explaining the whole matter," otherwise Musharraf would have been driven fifty kilometers out of the city as Sukhanov said. Musharraf agreed to everything and asked: "What if he takes my son?" Sukhanov replied, "No, he has no right." The issue was raised again. "Musharraf admitted she had been trained"<sup>8</sup>.

"In those days of the Soviet regime, it was a daily occurrence for a child to formally renounce his father and for a wife to formally renounce her husband. Because in that period of human society, the treacherous system began to reign: the pioneers, the young elites, the sects were traitorous. Wives used to "divorce" their husbands ... "<sup>9</sup>. Musharraf's case was a typical event for that period; it was especially hard for women working in public affairs.

The episode of the wife's divorce from her husband is also reflected in Abdullah Qahhor's 1959 unfinished story "Zilzila" ("Earthquake.") If Shuhrat brought this episode to the novel to fill the main plot, to intensify the conflict of events, to develop dramatically, A. Qahhor chooses this topic as the main motif of "Earthquake" as the main motif.

During the discussion of the novel "Gold is rustproof" in 1964 at the Writers' Union of Uzbekistan, A. Qahhor spoke about the redundancy of the image of Hajar in the novel and said that it would be better if Musharraf herself performed her role. Following the writer's advice, Shuhrat removed the character and assigns her task to Musharraf. As a result, in all editions of the novel, Musharraf herself goes to complain to the district committee<sup>10</sup>.

In our opinion, based on the logic of his story, which A. Qahhor wrote a while ago and left in his box, he thought that if the image of Hajar was removed, Musharraf's role would increase and the episode of divorce would intensify. But Shuhrat's creative idea was different from the beginning, and he brought in both episodes to develop the main motif. In short, the writers did not understand each other's opinions, and as a result, the novel cracked.

Analyzing the story of "Earthquake", N. Ziyodullaeva noted: "The story of the character Sabir Salim, which began in 1959 but was not completed, may be similar to the life of Abdullah Qahhor in the 1930s."<sup>11</sup>. And she associated the story with Qahhor's imprisonment in 1929. At first glance, the conclusion seems to be not groundless. In the story, the writer skillfully describes the mental state of the prisoner, the conditions of the prison. However, when a writer creates a work of art, he can describe the feelings of both the child and the old man, as well as the woman. This is not a reason to say that the author described himself.

In addition, N. Ziyodullaeva seems to have overlooked the author's notes when visiting the archives of A. Qahhor. According to O. Juraboev, textologist who described the archives of A. Qahhor, the document No. 3785 in the house-museum contains the author's notes under the title "Materials for the story "Earthquake ". In it, the writer made notes about the prototypes of the heroes of the work: "Sabir Salim – Hamid Sulaymon. Abdullaev Sobir. When he sees Mirvahid, his eyes glaze over "<sup>12</sup> Apparently, there is no reason to say that A. Qahhor himself was a prototype for the character of Sabir Salim. Hamid Suleyman and Abdullaev Sabir were prototypes for this image.

After the end of World War II with the victory of the USSR, there was an opinion among the intelligentsia that "the war ended in our favor, we have a share in it, and now Stalin must believe in us." For this reason, the intelligentsia felt a little free. The number of parties and gossips rose. Naturally, in these "speeches" people tell various "anecdotes" and give freedom to their words. Unfortunately, soon the next wave of Stalinist repression emerged.

On November 29, 1950, Hamid Sulayman, Deputy Director for Academic Affairs of the Tashkent Evening Pedagogical Institute, was arrested on charges of being an "enemy of the people." This message spreads around at lightning speed. At that time, the scientist's wife, Fozila Sulaymonova, was teaching World Literature at the Central Asian State University (now the National University of Uzbekistan). In the 50s of the last century, academician Naim Karimov and professor Umarali Normatov were students of this school. Naim Karimov recalled that the dean of the Faculty of Philology G.P. Vladimirov threatened Suleymanova that she must divorce her husband, otherwise the wife of the "enemy of the people" would have no place at the university.

As a result, F. Suleymanova had to do what the dean had insisted. U. Normatov added that Sulaymonova did not get rid of a consequent burden by writing the letter. "I saw her crying a lot after that," he said, recalling the tragedies of that time. "Saida Zunnunova was also studying at our university at that time. Saida was in senior year, we were in junior year. The dean asked her to leave her husband as well. Saida was expelled from the university after she disobeyed the order,"<sup>13</sup> he stated. The poet Shukrullo, after a long pause, noted, "Sister Fozila was a good woman"<sup>14</sup>

Hamid Sulayman's criminal case, which is kept in the archives of the State Security Service (P-21493), contains the following information about his family:

“Family structure:

1. The father: Persecuted in 1938 for anti-Soviet activities. Address unknown.

2. The mother: Sulaymonova Tokhta. 1887. Tashkent Address: Tashkent city, Frunze district, Parovoznaya street № 12. Unable to work.

3. The wife: Sulaymonova Fozila Komilovna. 1919. Fergana region Margilan city Address: Tashkent city, Frunze district, Parovoznaya street № 12. A Lecturer at Central Asian State University.

4. Children: Sulaymonov Rustam. 1939. Tashkent.

Sulaymonov Sultan. 1943. Tashkent Address: Tashkent city, Frunze district, Parovoznaya street № 12.

The brother: Sulaymonov Karim. 1924. Tashkent city, Address: Tashkent city, Frunze district, Parovoznaya street № 12. Unemployed <sup>15</sup>.

Apparently, the family was enormous. The above statement proves that the whole burden of the family fell on the head of F. Suleymanova after the imprisonment of the father of the family. The court also stated that Suleymanov's sister, whose husband had died, was living with them in the house with her three children.<sup>16</sup>

Firstly, the need to save the family, secondly, the concern for the survival of so many people, and thirdly, the fate of the children forced the scholar to do so. On top of that, this was not the first time the family was in trouble. The fate of the father of Hamid Sulayman was unknown after he had been repressed in 1938. Probably, the mother-in-law, who was the wife of an "enemy of the people", knew that it was difficult to take care of orphaned children. She may have advised her daughter-in-law to comply with the dean's request. Otherwise, they would not have lived in the same yard after this incident.

Such incidents were common at the time. After all, both A. Qahhor and Shukhrat used this event creatively in their works. "Every element of a work of art goes through the creative personality and characterizes it. If the author is interested in which side of the reality the author's creative activity is focused on, the reader will understand and master this aspect in the play. That is, the reader understands and assimilates the reality that was previously assimilated by the author in the work of art"<sup>17</sup>.

If in the "Earthquake" Gulandom was persuaded by Mirvahid, in the novel "Gold is rustproof" Musharraf did it after the investigator threatened to expel her 50 kilometers from the city (manuscript, pp. 302-306). However, in the printed versions of the novel, it is written that Musharraf "went to Sadiq to ask for a divorce on the advice of some people"<sup>18</sup>.

These episodes prove that in any case, it was no easier for the wife of a man imprisoned as an "enemy of the people". For them to live in this world was harder than to be in prison. Well, since this is the wife, the second half of an apple, how did this tragedy affect a third person or individuals? For example, the son or brother of the "enemy of the people" ?!

### **Between hope and madness**

In 1937, a report published in the poster newspaper of the Faculty of Literature of the Tashkent Pedagogical Institute turned the whole faculty upside down. It reported: "Hamid Gulomov, a

student studying with us, is the son of one of the activists of the gang." "Gulomov cannot remain in our institute as the son of an enemy of the Soviet state,"<sup>19</sup> the author continued.

At that time, Hamid Gulomov was a first-year student at the Tashkent Pedagogical Institute, studying with Shukhrat, Ilyas Muslim, Nemat Toshpulatov, and Quدرات Hikmat. During the bloody storm of 1937, someone wrote a "round" letter to the rector about the fact that Gulom's father was a basmachi (a rebel against the Russian or Soviet rule in Central Asia). After that, the case of Hamid Gulom was considered and the future poet was expelled from the institute.

Shuhrat continued to testify, "This article was discussed at a meeting of our group of students for two or three days. "As a result of the discussion, we decided to expel Gulomov from the institute." However, Yongin Mirzo, who studied with them at that time, denied the allegations, saying, "Shukhrat has nothing to do with it, we were just participants in the meeting."

The only thing that holds a man to this world is - hope. If there were no hope a person would go insane. When in need, a person clings to the hay so as not to drown. Shukhrat also tries to justify himself by using this incident, which took place during his student days, to help the Soviet state in exposing the enemy in this way, but his lie is quickly discovered and the event disappears on its own. (At that time, it was customary to make a shield for oneself by exposing the "enemy of the people.")

Nothing in this world goes unnoticed. No matter what form a person takes, he feels the need to express his heartache. But there is also the fact that this can sometimes be impossible. It is due, on the one hand, to social conditions and, on the other hand, to the writer's lack of creative ability.

Later, Hamid Gulom covered the Basmachi movement in the novel "Mashal", and Shukhrat created the image of a basmachi in "Gold is rustproof". It should be noted that in both works the image of the basmachi was created following the requirements of the time.

If a person describes what he really sees and knows, the reader will believe it. In our opinion, both writers are well aware of the essence of "the Basmachi movement". However, they tried to evaluate them by looking at the image of the basmachi through a crooked window held by the Soviets, contrary to their views. In the end, H. Gulom's pillow-like novel disappeared, while the image of basmachi in "Gold is rustproof" became one of the most unbelievable characters in the novel.

H. Gulom's expulsion from school as the son of a printer is reminiscent of the episode of Kodir's expulsion from the ranks of students in the novel "Gold is rustproof". "... on the poster, his was harshly disreputed. It was mentioned that he sat in the auditorium in a bad temper; deliberately delayed the delivery of the library book; hid his biography and kept in touch with the brother of "enemy of the people" ... Qodir could not stand in front of the newspaper and went out into the yard. He didn't notice how the big break passed. "I was saved! It's good that the bell rang. " He came in and was crushed worse than at the break. Two of the students sitting next to him took their books and went to the back "(manuscript, pp. 340-341).

At one point in the novel "Gold is rustproof", he says to aunt Adolat's son Sadiq, "... you have a couple of friends who visit at night. I don't know their names. One seems to be in a bigger job and usually appears in a car. But he leaves his car far away "(manuscript, p. 436). Approaching the "enemy of the people" or his relatives was tantamount to risking one's life. That is why

“leaving one’s car far away” or “taking your book and going to the back” expresses the deep-rooted fear of the people of that time. Once the law was broken and the fathers were imprisoned, what if the law was broken for a second time to charge the children? So the unwritten law once again shows its power and Qodir was expelled.

Why should total strangers suffer at a time when the child is responsible for the father and the brother for the brother was being ostracised from society ?!

But it was the case. Everyone became a spectator. No courageous man was found when H. Gulom and Qodir were expelled from the Institute.

### **Fact and fiction**

Every writer prepares for great work as he begins to write it, collects a huge source. Oybek wrote about how he had prepared to write the novel "Navoi", including: "I have long dreamed of writing a work about Alisher Navoi. The image of the great humanist took over my mind like a lighted torch illuminating the darkness of a medieval night. First of all, I wrote the poem "Navoi". "The image of Navoi is embodied in many of my poems ... I started collecting materials about the great poet Navoi in 1928, studied the immortal works of the poet and his period, and wrote many historical and literary works about the life and work of Navoi"<sup>19</sup>.

And Shukhrat admitted that he did not collect special materials for writing the novel: "I know the life in "Gold is rustproof" very well, it is the life of the people who were with me, who met me. I was not around this life, I was inside it"<sup>20</sup>. Obviously, Shukhrat not only apply his own experiences in the novel but also creatively used the fate of his contemporaries and masterfully incorporated their tragedies into the novel. If the writer made good use of his own experience in the first episode, the tragedy of Hamid Sulayman in the second, and the expulsion of Hamid Gulom in the second, the fourth episode reflects the pain of Maqsud Shaykhzoda.

Indeed, life was so cruel. For mirsalims of that time, it was not enough to prison a person and to destroy the families, they intended to possess their property: "Aged and grey-haired by grief aunt Adolat sat on the baggage thrown in the street: "These dark days will pass, and your face will burn, Mirsalim!" What do you say when Sadiq comes? Shame! He said:

"He won't come!" The corpses in lahad (a hollow cavity in which the dead body is kept in a grave tomb) come when they stand up! (Manuscript, p. 252).

On May 25, 1956, the poet Maqsud Shaykhzoda, who had been acquitted during the Khrushchevite heatwave, wrote a letter to the then First Secretary of the Communist Party of the Uzbek SSR, N.A Muhiddinov. The letter reads, in part: "Instruct the relevant authorities to rectify the illegal behavior - that is, to return our apartment on Stalin Street № 3, which was confiscated by Uygun in 1953"<sup>21</sup>.

Shaykhzoda was exiled to Tashkent in 1928. "In the autumn of 1936, Shaykhzoda managed to get a house belonging to the Union on the Shakhrisabz Street. However, in the first days of moving to this house, he went on vacation and went back to his parents with his wife"<sup>22</sup>. Unfortunately, this joy did not last long. The Writers' Union soon took the house from Shaykhzoda and gave it to the writer Shokir Sulayman.

After some wandering, in the summer of 1939, at the behest of Usmon Yusupov, Shaykhzoda moved to a house near Red Square. Later, when Shaykhzoda was imprisoned as an "enemy of



the people", the house was taken over by the poet Uygun. Academician N.Karimov notes: "... then Uygun came to Shaykhzoda's house on Abdulla Tukay Street with a policeman and drove out Shaykhzoda's wife Sakina, saying that the enemy of the people could not live in this house. Sakina answered: "I will not move! My husband is not an enemy of the people. God willing, when good times come, he will definitely come back. My husband is a real communist who has served Uzbek literature ". But with the help of the police, Uygun threw everything in the house into the street and forced Sakina to move. After that, Sakina moved to the house of the then chairman of the Writers' Union, Uygun, on the 4th floor of the House of Experts on Turob Tola Street. According to N.Karimov, Uygun did not return the house to Shaykhzoda later.

This means that the then chairman of the Writers' Union, Uygun, seized Shaykhzoda's house by abusing his official authority. (Uygun, like Mirsalim, did not think about how to look in Shaykhzoda's eyes if he returned.)

Shukhrat brought the episode into the novel and put on a different cloak, giving it a bit of a narrative. "In springtime, ignoring aunt Adolat's tears, Mirsalim emptied the four-room courtyard where Sadiq and his family lived and moved in". (manuscript, p. 252). This, in turn, made it difficult for the reader to understand what action Mirsalim took to seize Sadiq's house. Because it was clear to the reader that Mirsalim was not strong enough to take someone's house. Had the author better covered this aspect of the issue, he would not have allowed ambiguity.

According to prof. U.Normatov, in 1967, a literary critic O.Sharafiddinov and Maqsud Shaykhzoda went to see him a week before his death. Then the poet recalled with regret the dark days he had gone through, and said, "Perhaps, when I recover, I will write something on this subject. If I cannot manage, I have no regret. In any case, Shukhrat in "Gold is rustproof" wrote about my fate and pain"<sup>23</sup>. This serves to substantiate our above considerations.

Above, we have tried to share our thoughts on how the historical reality is fictionalized by comparing the four small episodes in the novel with their vital basis. Needless to say, each of these episodes could have been the basis for different work. In any case, Shukhrat incorporated these events into his novel and used them to shape the plot. At the same time, these episodes reflect the complexities of the period, playing a unique key role in reflecting the psyche of the people of the Stalinist repression era.

#### REFERENCES:

1. Архив КГБ П-21493. Дело № 726. Томов 16. Том 7. – С. 231. (Бу ариза ўзбек тилида ёзилган. – М.Ё)
2. Архив КГБ П-21493. Дело № 726. Томов 16. Том 15. – С. 131-136. (Таржима бизники – М.Ё).
3. Архив КГБ П-21493. Дело № 726. Томов 16. Том 16. – С. 271. (Таржима бизники – М.Ё).
4. Норматов У. Шухрат. Т.: Фафур Фулом. 1969.
5. Саримсоқов Б. Бадиийлик асослари ва мезонлари. Т.: 2004. – Б. 34.
6. Мухтор А. Ёш дўстларимга. Т.: 1971. – Б. 10-11

7. Алишер Навоий номидаги Давлат адабиёт музейи. Ёзувчи ва шоирлар архиви. Шухрат фонди. Ф.16.37-38 рақамли ҳужжат. “Олтин зангламас” романи қўлёзмаси. – Б. 306. (Бундан кейин қўлёзмадан кўчирма келтирилса, қавс ичида қўлёзма деб ёзилиб, ёнида саҳифаси кўрсатилади.)
8. Боқий Н. Қатлнома. Т.: Ғафур Ғулом. 1992. – Б. 8.
9. Ёдгорова М. Бир образ тадрижи ва талқини. // Ўзбек тили ва адабиёти. 2019 йил № 5 сон. – Б. 80-83.
10. Зиёдуллаева Н. Ўзбек адабиётида ижодкор биографиясини ўрганиш муаммолари. ф,ф,н. илмий даражасини олиш учун ёзилган дисс. Т.: 2000. – Б. 52.
11. Абдулла Қаҳҳор архиви каталоги (Араб ёзувидаги ёзувидаги ҳужжатлар тавсифи). Тайёрловчи О.Жўрабоев. Т.: Муҳаррир. 2011. – Б. 34
12. Сухбат 13.06.2019 йил У.Норматовнинг уйида бўлиб ўтган. –М.Ё.
13. Сухбат 24.03.2019 йил Шукруллонинг уйида бўлиб ўтган. – М.Ё.
14. Архив КГБ П-21493. Личное дело Сулайманова Хамида. Архив. инв. №4. П-21493. – С. 5. (таржима бизники – М.Ё)
15. Архив КГБ П-21493. Дело № 726. Томов 16. Том 7 – С. 70.
16. Носиров Ў. Ижодкор шахс, бадиий услуб, автор образи. Т.: Фан. 1981. – Б. 119
17. Шухрат. Олтин зангламас. Т.: Шарқ. 1999. – Б. 175
18. Архив КГБ П-21493. Дело № 726. Томов 16. Том 12 – С. 214-217. (Таржимабизники – М.Ё)
19. Ойбек. Мукамал асарлар тўплами. 20 томлик. 14 том. Т.: Фан. 1979. – Б. 16.
20. Шухрат. Ўзим ҳақимда икки оғиз сўз. Танланган асарлар 3 томлик. 1 том. Т.: Ғафур Ғулом. 1969. – Б. 9.
21. Алишер Навоий номидаги давлат адабиёт музейи. Ўзбекистон ёзувчилари ахиви. М.Шайхзода фонди. 747
22. инвентарь рақамли ҳужжат. М.Шайхзоданинг Н.А.Муҳиддиновга ёзган хати. 4 бет. Иқтибос 4-бетдан олинди. (Таржима бизники – М.Ё)
23. Каримов Н. Мақсуд Шайхзода. Т.: Шарқ. 2010. – Б. 62.

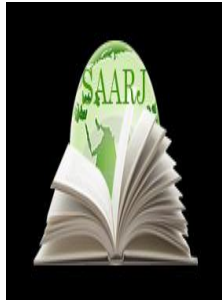

**ACADEMICIA**  
**An International  
Multidisciplinary  
Research Journal**  
(Double Blind Refereed & Peer Reviewed Journal)



DOI: **10.5958/2249-7137.2021.01311.2**

## SYSTEM AND INTEGRATED APPROACH TO ECONOMETRIC TRAINING

**Muhaya Makhmanazarovna Ravshanova\***

\*Researcher,  
Karshi Engineering Economics Institute,  
UZBEKISTAN

### ABSTRACT

*In this article, the researcher explains the basic concepts of a systemic approach and comprehensive communication, which are one of the scientific approaches in pedagogy, and their use in the science of econometrics in accordance with the objectives and objectives of the study.*

**KEYWORDS:** *Pedagogy, Systemic Approach, Technology, Integrated Approach, Model, Econometric, System.*

### INTRODUCTION

Today, with the development of science, the concept of a systematic approach and an integrated approach is also used in the pedagogical sphere. In science, the study of objects or events as the system led to the formation of a new approach to science, a systematic approach. As a methodological principle, a systematic approach is used in science and various fields.

The systematic approach is a general scientific method for solving theoretical and practical problems. The development of the theory of functional systems undertaken by PK Zanochein, made it possible to use a systemic approach in pedagogy, and then in psychology.

The essence of the system approach seems to be: a form of integration in scientific and practical activities; type of formalization of real phenomena; The active conversion position of the researcher, involving the design of the result, and the generalized specific scientific expression of the methodological principles, concepts and methods of systemic studies.

**Purpose.** As is well known, the central problem of all scientific knowledge is the objective difficulty in resolving the contradiction, which arises between the complexity and variety of

cognizable phenomena, on the one hand, and the limited forms and methods of thinking-on the other.

"The system (from Greek. Zuzeta is a whole) - the association of some different-forming into a single and clearly disjointed integer, the elements of which in relation to the whole and other parts occupy the corresponding places" it necessarily implies the interaction of the elements.

Any object of pedagogical research can be represented as a system. In this case, the system properties of the pedagogical object are not due to the properties of the components of its elements, since they are a certain result of integrative processes occurring inside it. The definition as an object of scientific cognition of a holistic system is one of the initial stages and at the same time an effective path of resolution of the contradiction, which was mentioned above.

According to T.A. Ilina, the system is an ordered set of interrelated elements, combined with a common goal of functioning and unity of management, and acting in cooperation with the medium as a complete unity.

At the moments of relationships and interaction emphasizes PK Zanolkin. The system, he emphasizes, can be called "only such a complex of selectively involved components in which the interaction and relationship acquire the nature of the interaction of components for obtaining a focused useful result."

In pedagogy, there are numerous options for applying the general theory of systems to the analysis of the pedagogical action by the system, it is customary to understand the complex of interacting elements, connections and relationships between objects. "

The narrower definition of the pedagogical system, but N.V. Kuzmina gives a more important for the analysis of holistic pedagogical objects: "Pedagogical system we define as a functioning structure of interrelated components subordinate to the goals of education, education and learning the younger generations and adults."

**Scientific novelty of the article.** The practice of applying a systemic approach in pedagogy is often suggested about a fairly common error, the essence of which concludes in the non-divergence of a systemic (complex organized) pedagogical object and systemic study of such an object. At various levels of analysis and when solving various tasks, the same object can be explored as systemic and non-system.

**Results and practical applications.** In other words, with the methodological analysis of the pedagogical object, from the very beginning there are two different worldview scientific positions of the author: the declaration of their intention to accept this object for something whole and allocate elements or recognition of the systemity as the qualitative characteristics of this Pedagogy object in it. Depending on the choice of one or another position, the teacher will implement various strategies for knowledge of the object and converting an object:

- Describe the pedagogical system, i.e. consistently consider the elements of the object in several typical embodiments of their interaction (to investigate the states or situations of the pedagogical object) and determine how and to what extent elements (or situations it depends on the choice of structure) are subject to the objectives of the system;
- Describe the qualitative characteristics of the pedagogical system: its integrity, structuralism, interdependence of the system and medium, hierarchy, the plurality of the description of each

system, etc. The choice of the position of the teacher-researcher is the initial step of the implementation of the system approach. In our work, we adhere to the first position, understanding the deep differences between the subject system and the process system.

The systematic approach has a significant number relative to independent directions, each of which solves its own problems: system-genetic, system-historical, system-structural, systemically - meaningful, system-functional, system-methodical, system-information, etc..To comprehensively To know the system, you need to study its essence (quality of integrity), the inner structure (composition, structure, functions, system factors), communications with an external environment, its history. When analyzing the inner structure, system-component, system-structural, system-functional and system-integrative aspects differ.

From the standpoint of the general scientific theory of the systematic approach in the study of the social system of any level, as V. G. Afanasyev notes, it is necessary to consider the main features of the element: an objectively existing system; theoretical scientific system as a reflection in thinking objectively existing system; the movement of this theoretical system in the direction of increasingly adequate reflection of objective reality; Practice as the initial moment of knowledge, the basis and criterion of truth, as the sphere of use of knowledge of the system.

Thus, the use of a systemic approach in pedagogical examination we consider not only necessary, but also inevitable.

A comprehensive approach is expressed in unity, interdisciplinary interaction, the logical synthesis of philosophical, historical, social-economic, technical, technological knowledge about the object and subject matter, as well as general scientific and specific scientific methodological provisions.

Given the sufficient development of an integrated approach in the scientific literature, we define here only the dialectics of systemic and integrated approaches in the knowledge and transformation of the object and its methodological consequences.

The integrated approach "makes" functioning the educational system as a whole as the organic unity of interconnected components. Otherwise, as F. K. Kazaryan notes, the system is the most good in its plan to act "in parts", without ensuring the most educational tasks in the end, for which it was created.

If the systematic approach in pedagogy allows you to determine the set of elements allocated according to the general (system-forming) base for them (that is, complementary by each other), then the integrated approach ensures the relationship of the heterogeneous elements (interconnecting each other) of a particular pedagogical object.

Consequently, the integrated approach in pedagogy provides coordinating targeted, interrelated, but sometimes even multidirectional and contradictory effects on a pedagogical object for its conversion in case it is investigated as a system. If it is not investigated as a system, then the complication of the effects on it is very difficult due to the fuzziness of the allocation and knowledge of its connections, functions, elements, relations, properties, etc. For a holistic study of the pedagogical object, a dialectical application of systemic and complex methodological general scientific approaches.

## CONCLUSIONS AND SUGGESTIONS

In conclusion, we note that the methodological consequences of the use of the integrated approach is wide and diverse in the pedagogy. Research programs in pedagogy are also integrated, and practical pedagogical activities require accounting for all connections and mutual influences of society, the interaction of the social environment and humans. In pedagogical practice, those models that were originally designed as complex were the most effective. When building a model of a methodological system of training econometric students of pedavuses, an integrated approach allows us to take into account various external influences on the study object.

## REFERENCES

1. Лаврентьева, Н. Б. Педагогические основы разработки модульной технологии обучения [Текст] : монография / Н. Б. Лаврентьева. - Барнаул : Изд-во АГТУ и ААЭП, 1998. - 252 с.
2. Бабанский, Ю. К. Оптимизация процесса обучения [Текст]/Ю. К. Бабанский. - М.: Педагогика, 1997. - 184 с.
3. Лузик, Э. В. Подходы к диагностике качества обучения [Текст] /Э. В. Лузик, Д. В. Чернилевский. - М.: МГТА, 2000. - 27 с.
4. Чернилевский, Д. В. Дидактические технологии в высшей школе [Текст]: учеб. пособие для вузов / Д. В. Чернилевский. - М. : ЮНИТИ- ДАНА, 2002.-437 с.
5. Чошанов, М. А. Гибкая технология проблемно-модульного обучения: методическое пособие [Текст] /М. А Чошанов.-М.: Нар. образование, 1996. -157 с.
6. Shadiyev R.D. Methods and Forms to Ensure Understanding in Educational Process. Eastern European Scientific Journal. DOI 10.12851/EESJ201805.www.auris-verlag.de.
7. Shadiyev R.D., Yarasheva S.K.Implementation of a preschool organization development Program. «Муғаллим ҳам ўзликсиз билимлендириў». №3, Нөкис .2019., 129-133-б.
8. Ergashev N.G'. "Using visual program technology methods in engineering education". European Journal of Research and Reflection in Educational Sciences Volume 7 Number 10, 2019 ISSN 2056-5852 Progressive Academic Publishing, UK [www.idpublications.org](http://www.idpublications.org) 107-111 p.

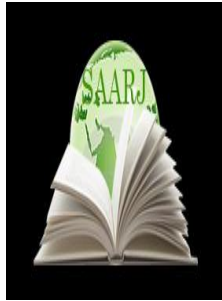

**ACADEMICIA**  
**An International  
 Multidisciplinary  
 Research Journal**  
 (Double Blind Refereed & Peer Reviewed Journal)



**DOI: 10.5958/2249-7137.2021.01312.4**

**STATUSES OF SPIRITUAL PERFECTION**

**Murodkhoja Mukhtorov\***

\*Independent Researcher,  
 Alisher Navoi State Museum,  
 UZBEKISTAN

**ABSTRACT**

*This article is about the fact that the art of maqom is an integral part of the wonderful spiritual world and artistic thinking of the work of Hazrat Alisher Navoi. For the gazelle of the sultan of the kingdom of words is an ocean of wisdom, expressed in this poetic style, and makoms are an ocean of wisdom, spread by the sound of a melody. This is probably why the public who reads and enjoys Navoi gazelles usually wants to hear makoms in the same spirit, needs them and enjoys spiritually. And the connection of these two oceans, decorated with wonderful meaning, into one world occurs thanks to great love. This is the teaching of a perfect man who, because of this sublime love, chooses the path of spiritual purity and spiritually ascends to the universe in his position.*

**KEYWORDS:** *Makom Art, Artistic Thinking, Spiritual Development, Melodic Constructions, Main Stages*

**INTRODUCTION**

It is clear from his poetic and scientific works that Hazrat Nizamiddin Mir Alisher Navoi knew the art of maqom both practically and theoretically. This fact also shows that the legacy of the thinker is one of the important and valuable sources in the study of various issues related to status (historical, theoretical, etc.). In fact, the world of status is an integral part of the deep and beautiful spiritual world of Navoi's artistic thinking. For, the ghazal of the sultan of the realm of words is the ocean of wisdom expressed in this poetic style, while the maqoms are the ocean of wisdom spread through the sounds of melody. Probably for this reason, a fan who enjoys reading Navoi's ghazals will usually want to listen to the maqoms as well, and will enjoy them spiritually. And the connection of these two oceans, adorned with beautiful meanings, into one world is due to great love.

Fiery verses such as HazratNavoi's  
*Ochmagayerdingjamoliolamarokoshki,*  
*Solmagayerdingboriolamgag'avg'okoshki.*  
*Chun jamolingjilvasiolamg'asoldirustaxez,*  
*Qilmagayerdiko'zumonitamosho, koshki*  
*Bo'lmagayerdiko'zum, o'tlug'yuzingko'rganzamon,*  
*Ishqingo'tishu'lasiko'nglumdapaydokoshki [1, p. 629]*

I wish you hadn't opened it,  
 I wish the world would be a better place.  
 Your beauty has set the world on fire  
 I wish my eyes were watching my mother  
 My eyes were gone, when I saw your grassy face,  
 I wish the light of the fire of love appeared in my heart.

can be a prelude to every major utterance in the maqoms. Even in the bodies, the warmth of the grassy heart, the torments of peaceful pain, the intense experiences of pure feeling are felt. Indeed, the doctrine of the perfect man, who chooses the path of spiritual purity for the sake of high love and in his status ascends to the universe, and in his provar the real beauty reaches the truth, is the core of both HazratNavoi's poetry and our classical maqams. Consequently, the claims of status, scattered throughout the works of the wise poet, are not merely for the purpose of "lyrical retreat," but the most important point of a particular idea is sometimes expressed in the form of an inward conclusion. At the same time, one should not overlook HazratNavoi's views on music in general.

In particular, we read such verses in the philosophical epic "Lisonut-Tayr", written in response to Fariddin Attar's "Mantiqut-Tayr".

Bo'lsalahnunag'madaogohlig'  
 Behkitoatvaqtidagumrohlig'  
*If so, be aware of the melody*  
*It is a mistake to be obedient*

That means, when one listens to the melody, remembering the Dargah and being aware of the first Address is better than a prayer of obedience performed in error. (Vollohua'lam). In this sense, perceived music can have a direct positive effect on the human heart, can be spiritual nourishment for his soul. So, if "awareness melodies" can be interpreted, then spiritual prayer is sacred. In the meantime, let's look at the following bytes with the names of the positions.

Qaddixajringdatortsangnola,  
 "Rost" ohang, eyNavoiytuz [2].  
*If you pull on your chest, moan,*



*The melody of "Truth", O Navoi salt.*

(Badoeulbidoya)

### THE MAIN FINDINGS AND RESULTS

The term "Truth" and its specific features in music play an important role in understanding the content of this byte. This term, which is the name of one of the famous twelve maqams, also symbolizes the path of the sect (Roxi-rost) in mysticism. Therefore, the content of the verse can be interpreted as follows: Let the lover who suffers from separation (Hijran) enter the path of the sect. Because this path is aimed at this goal. Now, if we consider the "True" in the section of the maqams, the following meaning emerges from this verse: Because the melodies played in this position bring peace and tranquility to the heart of the lover, and maybe he can lift his spirits and achieve the desired state of pleasure.

The reasons for such an extraordinarily strong emotional impact on the human spirit of the status of "Truth" are characterized, first of all, by the association of its perfect curtains and, on this basis, a certain style of development of melodies. The priceless power given in this way to the content of a byte does not negate the former, but shows that deep meanings in a complementary system are embodied in only two poetic verses. In the same byte, it can be understood that the content of this byte reflects the mystical ideas in the music. In this regard, the following verses of Hazrat Navoi are also noteworthy:

*EyNavoiy, sendog'iqilsangtamma'sayri "Xijoz",*

*Qil "Iroq" ohangitarkaylabXuroson men kabi.*

*O Navoi, if you stain, you will go to Khijaz.*

*Let the "Iraqi" tone leave Khorasan like me.*

(Navodirush-Shabob")

*EyNavoiy to muqarrarqildimohangi "Xijoz"*

*Goh "Iroqu", goh "Ajam" sari tarannumaylaram*

*O Navoi, I have inevitably heard the melody "Khijaz"*

*Sometimes I sing "Iraq" and sometimes "Ajam"*

(Xazoyinulmaoniy)

*Eymug'anniy, tut "Iroq" ohangigako'rgiz "Xijoz"*

*Kim, Navoiyxotiribo'lmishXurosondinmalul*

*O singer, show me the melody of "Iraq" "Hijaz"*

*Kim, the memory of Navoi, is known as Khurasan*

(Badoeulbidoya)

The names "Khijaz" and "Iraq", which have several meanings from the verses, have the meaning of "Open". Hijaz is known to refer to the border between the holy cities of Makkah Mukarramah and Madinah Munawwarah, while Iraq is known to refer to the name of the country. Hence, the interrelationship of these names is likened to the great pilgrimage. Hijaz is a symbol of the main

goal of the trip, and Iraq is a symbol of the long road to this goal. In Navoi's time, he crossed the Iraqi desert to reach the Hijaz. Thus, the content of the above verse reflects the aspiration of Hazrat Navoi for the pilgrimage he has dreamed of all his life. At the heart of the "Idea of Hajj" is also the journey of spiritual maturity, which leads to the great truth. As for the meanings in the musical part of the verses, in general, it is clear that the lover has a spiritual need to listen to the maqom melodies "Iraq" and "Khijaz". This is because these positions also have perfect curtain associations, such as Rost, and melody structures that develop in a certain style, which can be a source of nourishment for the lover's soul to rise to surur "vajd" experiences. It should be noted that the status of "Khijaz" (more precisely, its name) does not occur in the structure of the Shashmaqom, Khorezmmaqoms and Fergana-Tashkent maqom roads, which have survived to our time. The status of "Truth" has not changed since the time of Navoi, it is one of the most perfectly organized curtains for the human heart to listen and understand. In the case of "Iraq", the curtain system looks similarly perfect. These curtains are important in revealing the idea of each status, and this situation fully manifests itself only within a certain style.

In fact, this style, which was formed as an artistic reflection of spiritual growth in the stages of development, appeared not only in music, but also in almost all areas of creation with mystical influence, including fiction, which in many respects is close to music. Consequently, the comparisons in this regard are noteworthy. In particular, this artistic principle, which can be described as a method of "gradual ascent" (or status), is widely reflected in Navoi's work (various poems). In particular, we can see that the certain mood expressed in the first verses of the poet's poems develops gradually over the next few verses and eventually reaches its climax.

This style is also used with great talent in large-scale works such as "Khamsa" [3], "Lisonut-Tayr" [4], as a result of which the sources of origin are some of the events and folklore of the ancient world ("SaddiIskandariy") and later ("Sab'aiSaiyyar"). , "Layli and Majnun" and others ...) are the basis of our wonderful, artistic and poetic epics, in which the spiritual maturity of the protagonists is described with great skill.

For example, the literary theme on which the epic Sab'aiSaiyyar is based is based on the legends and myths about BahromGor, who is actually described as a "glorious king, a skilled hunter and a lover." Continuing the tradition of Hamsa on a high level, Hazrat Navoi radically reworked the subject and incorporated into it the views of the ancient Greeks on the seven heavens. As a result, the protagonist of the work, BahromGor, falls in love. The story of the seven planets, which played an important role in the composition of the epic, is interpreted in the section "Man and the unity of the universe", each of which is depicted in a separate color, symbolizing the sect, the ascension. Consequently, the development of the reality of the work in relation to the story is reflected in the fact that the colors change along with the planets (1st black, 2nd yellow, 3rd green, 4th dawn, 5th blue, 6th sandalwood, 7th white). The application of the step-by-step growth method in statuses is also somewhat unique. The content of this method, which is almost consistent in the beginning and main parts, involves the gradual development of small-scale melody structures (contents) on the basis of perfect curtains in a single order (I, II, III, IV and bass ...) from bottom to top.

For example, the gradual growth of the theme of TasnifiRost melody in Shoshmaqom starts from the first scene (stage 1 "Do"). This curtain is the main pillar (stage 1 compared to the sect), and the other pillars are also based on it. In this case, each stage is created at intervals equal to its own amount. In particular, the intervals of the 1st stage "do-do" (prima), the 2nd stage "do-re"

(second), the 3rd stage "do-mi" (thirteenth), the 4th stage "do-fa" (quarter) assimilated by means of. Thus the development of the melody theme is accomplished by the individual key sounds of the seven main curtain sounds in the same order. It should be noted that such a "growth principle" observed in the maqoms was originally used to bring the simple (folk) melodies, inherited from antiquity, to the level of classical requirements. In particular, the melodies of the maqom "NavruzAjam", "NavruzKhor", "Navruz Sabo", which have been classified by experts as "the most ancient example of folk music" ("primary line"), are clearly visible. Of course, this is not in vain. It is known that many peoples of the East have long celebrated Navruz and performed certain melodies and songs. It is probably true that this category of melodies, which played an important role in the traditional life of the people as a kind of seasonal ceremonial music, was later incorporated into maqom structures and gained their highly developed appearance through the application of this style. It seems that the melody structures in the form of "goh" (ie in the form of "Dugoh", "Segoh", "Chorgoh", "Panjgoh") also developed on this basis. Most scholars speculate that this type of melody [5] is based on the tradition of reading ancient books in certain tones, including the Gothic hymns in the Avesto. An analysis of the Goh melodies known to us shows that the roots of these specimens are older than the supposed periods. In particular, from Fergana-Tashkent maqoms on the basis of the melody "Dugohi-Husseini" -1 the structure of two base curtains in the instrumental melody "Segoh", as well as in the parts of Shoshmaqom "Tasnify-Segoh" the existence of which is obvious. It is known from the recent achievements of ethnomusicologists that such basic melodies are the first buds of folk musical thinking. At the same time, it is noteworthy that such simple melodic structures rose to the level of maqoms in the later periods of musical art development. Of course, the "growth" method described must have been used. In our opinion, the study of Navoi's work on the basis of balanced comparisons is very effective in understanding this process. In particular, man's attainment of the peak of spiritual maturity is expressed in a figurative style. In the epic "Lisonut-tayr", thirty birds fly in search of the righteous king Simurg. During the arduous journey, the seven stages of Talab, Ishq, Ma'rifat, Istiqna, Tawhid, Hayrat, and Faqr, the valleys of Fano, are conquered together, but in the end they see themselves not at Simurg, but at the level of Simurg (that is, at perfection).

*Ko'rdilaro'zniqayonkimko'z,  
 Olloh, Olloh, ne ajoyibdurbuso'z,  
 Kim, qilibSimurg'o'ttizqushhavas  
 O'zlarinko'rdilarulsimurg'bas.  
 They saw him with their own eyes,  
 Allah, Allah, how wonderful is this word,  
 Who, so Simurg envied thirty birds  
 They saw that he was dead.  
 ("Lisonut-Tayr")*

It is noteworthy that the idea of "good quality", which is achieved at the end of the road, also appears in the status quo. Examples of this are the Shashmaqom, Khorezmmaqoms and the Dugoh, Segoh, Chorgoh on the Fergana-Tashkent maqom roads. Thus, the gohkuy structures,

which were originally in very simple forms, belonged to a group of branches of the twelve maqom systems, each of which was individually attached to perfect curtain associations in order to develop them at the level of classical requirements.

Accordingly, the Dugoh branch is described as Husayniy, the Segoh branch as Khijaz, and the Chorgoh branch as Zangula. As a result, there was a natural process of penetration into the attached status curtains of the branches. The following example illustrates this. In the way of saying “MaqomiSegoh”, which is one of the Khorezmmaqoms, the melody device “Segoh”, which initially consists of three sounds, “conquers” seven main stages in a row, starting from the “re” curtain. It is true that the flow of melody periodically repeats the conquered stages with wavy motions and repeats them with wavy motions, which is due to the peculiarities of music in general. A comparative study of the twelve positions of the existing association of sounds instead of the basic stages reveals that it corresponds to the expression of the sects identified on the basis of V.M.Belyaev's [6] past treatises on the curtains of "Khijaz". Thus, the simple-looking old melody structures within the two (Dugoh), three (Segoh), and four (Chorgoh) tones of vocal singing are developed along the seven main curtains of certain statuses, irrigated with romantic-sounding moans and healing garlands of new meaning as a result, it can be said that their new levels of quality (i.e., status) had emerged. In fact, now these patterns have "sealed" the beautiful mental states of lovers in their melodies, so in order to "revive" them in the sounds, it is necessary to effectively use such executive methods as "moan", "escape" from the essence of love.

*Qaysiqushbulbulkimingdostonibor,  
Harbiruldostondabirafg'oni bor.  
Lekuldostonlarigulshavqidin  
Nola-u afg'onlarigulshavqidin  
Which nightingale has a thousand stories?  
Each that story has an Afghan.  
But his stories are full of flowers  
Weeping Afghans are interested in flowers  
("Lisonut-Tayr")*

## CONCLUSION

Thus, ancient music samples such as “Dugoh”, “Segoh” and “Chorgoh” discovered new qualities and later formed maqom forms (in ShoshmaqomKhorezmmaqoms - “Dugoh” and “Segoh”, on Fergana-Tashkent maqom roads “Dugoh”, “Segoh ”and“ Chorgoh ”. The logical conclusion is that in this process, the twin names, such as "Segohi-Khijaz", "Dugohi-Husseini", "Chorgohi-Zangula", which used to be used, gradually began to lose their meaning. This is because the subdivisions (melodies) were so naturally absorbed in them during their development in the maqam curtains that the names of these branches became not only the new melodies to be considered within these curtains, but also the concepts of these perfect curtains themselves.

**REFERENCES**

1. NavoiAlisher. “KhazoinulMaoniy”. – Tashkent: 1959 Volume 2, - p. 629.
2. NavoiAlisher. Badoe'ulbidoya is a collection of perfect works. – Tashkent: Fan. 1987. Volume 1.
3. NavoiAlisher. “Khamsa”. – Tashkent: 1986.
4. NavoiAlisher. “LisonutTayr”. – Tashknet: 1986.
5. Other sources are listed in the list of references used.
6. Belyaev V. M. Edition, A. M. Boldirev's translation “Musical treatise” Jamiy A. – Tashkent.1960.
7. FarobiAdu Nasr. The Art of Poetry. – Tashkent: 1979
8. Fitrat. *Uzbek classical music and its history*. – Tashkent: 1993
9. Matyoqubov O. (1991) “Introduction to professional musical works in the oral tradition. – Tashkent.
10. G'anieva S. Ne'matov X. (1993). *Collection of issues of literary mastery of AlisherNavoi*. – Tashkent.

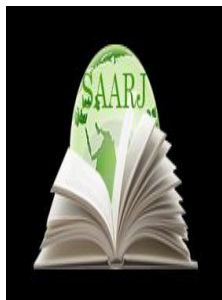

**ACADEMICIA**  
**An International**  
**Multidisciplinary**  
**Research Journal**  
 (Double Blind Refereed & Peer Reviewed Journal)

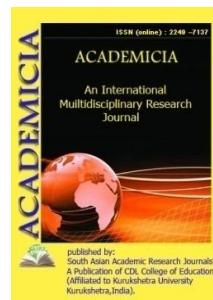

**DOI: 10.5958/2249-7137.2021.01313.6**

**SYMBOLIC INTERPRETATION OF COLORS**

**Nasiba Saburovna Jumatova\***

\*Teacher,  
 Candidate of Philological Sciences,  
 "Department of Uzbek and Foreign Languages,  
 MRDI named after Kamoliddin Behzod,  
 UZBEKISTAN

**ABSTRACT**

*This article discusses the historical basis of the creation of symbolic images associated with color in Uzbek literature, the role of the people in oral art, its role. Symbolic images associated with color serve to enhance the art, charm and influence of Uzbek folk proverbs. In folklore, color symbols have been explored using examples as a means of expressing ideas clearly, succinctly, and figuratively.*

**KEYWORDS:** *Folklore, Symbols, Color Symbols, Folk Proverbs.*

**INTRODUCTION**

Art, especially poetry, has evolved from time immemorial in connection with symbolism. Therefore, it is difficult to imagine the poetic image, its essence, the content and idea of the poetic work without symbols. Especially in recent years in the unprecedented development of art in Uzbek poetry "blood of poetry" [Parandovsky Ya. Alchemy Slova.-M., 1972.-208.] One of the means of creating an image is the importance of the place of symbols.

Symbolism, especially color-related symbols, is the most ancient means of artistic thinking. z tarovati serves to reflect with its splendor. Because the use of poetic symbols, their appropriate and skillful use allows each artist to express the spirit of the time, the dreams of the people, human experiences in a concise, meaningful and impressive form. The connection of the symbolic image with color, on the other hand, serves to make the artistic expression deeper and more impressive, to arouse in the fans of poetry the extraordinary wonder and delight that the poet expects. The study of symbols is relevant on the one hand, as it reveals the essence of this magical creature, on the other hand, it reveals the power of its influence on the psyche of our time. Before discussing the symbolic images associated with color, it is necessary to briefly

dwell on what a symbol is in general, its place in human life, and the role it plays in a work of art.

What is a symbol? What is its essence? These questions have been posed to the people since the time of Aristotle, and since then, every scientist has been able to answer this question with great power. rather than expressing, but rather expressing our understanding by generalizing existing views about the symbol.

Symbolism, in the broadest sense, is an image created through live observation of an event. Based on this, it can be said that a symbol is a reflection of an event. By its very nature, a symbol is a specific generalization of an event, referring to the sole object of what it represents. As the well-known Russian philosopher AF Losev noted, a symbol is a symbol of something, but any content and essence cannot be a symbol of something. [Losev AF Logika symbol.-M., 1991.-P.258.] The conclusion to be drawn from this is that the essence of any content of an object cannot be its symbol. In order for the meaning and essence of an object to become a symbol, they must be re-perceived in a specific way, raised to a level that is universally accepted by the majority on a certain conditional basis. In order for the content of an object to become a symbol and for the generalization to rise to such a large scale, it must have many semantic horizons. consists of a view that represents an idea. For this reason, the symbol is not clearly and well defined in any scientific, journalistic, or encyclopedic or dictionary of industry terms. Because the symbol is so complex, so multifaceted, that it is impossible to cover all its features in one arithmetic. This is probably why in almost all dictionaries the term "symbol" is interpreted in two different ways.

1. In a narrow sense, the term refers to special symbols used in the natural, philosophical sciences, as well as in the practical life of man. For example, "x" (x) or "y" (igrek), all the signs in the rules of the road, state emblems and h, k.

2. In a broad sense, the term "symbol" encompasses the concept of image in all forms of art with all its complex aspects. [See: Philosophical Encyclopedic Dictionary, -M., 1983.-P.607-608.] B In order to understand the essence of the artistic symbol and its role in the poem, it is necessary to know the conditionality of the artistic movement in the nature of the symbol, the logical basis of the symbol, as well as the historical and national features. As noted by Ri, if artistic conditionality provides emotional arousal in the symbol, the logical basis allows to find the exaggerated meaning in it. [Sharopov A. Worlds within the worlds.-1978.70-71 pages] In correctly defining the logical basis The past and the beliefs of each nation play an important role. The logical basis of the symbol has a very complex nature, and its definition depends on the artistic symbolic image. It depends on the accuracy and the poet's ability to understand art. Because the artistic symbol moves the image. In the process of movement, the image shows its colorful edges.

There is no nation in the world that has not created masterpieces of wisdom, has not expressed its religious beliefs in them, and has not been nurtured for centuries like the apple of an eye. "Proverbs appear in the upper stages of primitive culture and have the character of living for a long time." Symbols that have become clear and obvious to many in the development of human artistic thought are widely used as a means of expressing thought clearly, succinctly, figuratively. One of such genres is folk proverbs. Color symbols play an important role in folk proverbs, which are an encyclopedia of exemplary ideas that have been confirmed thousands of times in

the centuries-old experience of the people. Of course, there are many symbols associated with different symbols in folk proverbs. It is impossible to dwell on all of them. Therefore, we will comment on some of them below.

G.Vemberi, a well-known European orientalist, visited our country in the second half of the last century and wrote when he returned; „ In Central Asia, which has long been a land of poetic sentiments, young lovers, priests and aristocrats, who fell in love with each other, are equally interested in all poetic works... Proverbs can be found both in written literature and in live speech, both in the palaces of the dead and in the nomadic pastures.

The antiquity of color-related symbols is explained by the fact that they originated in connection with the beliefs of primitive man. Because the human mind still did not have the ability to create complex abstract concepts, it sought to symbolize simple empirical concepts. and distinguished the darkness. During the day he did not have any difficulty in hunting or fighting with others. The reason is that he was able to see his surroundings well, to fully understand the geographical structure of his place. In the darkness of the night, the opposite was true and he suffered a lot. That is why it is dark. He was afraid of death, and this fear led to the formation of black in his mind as a symbol of evil and horror. Light was embodied in white as goodness, comfort, and prosperity. The color of blood in people and animals killed in hunting or war. because it is red, this color was formed as a symbol of war, sacrifice.

In ancient times, the gods lived in heaven, and the idea that people's souls and souls were given to the will of these gods formed the color blue as a divine symbol. Blue is a divine color, as well as a force that unites the souls and souls of all the dead. It is clear from the above considerations that white, black, blue, red , the colors green and yellow were symbolized much earlier than other symbols associated with color as the most ancient religious notions. Even today, these colors have fully retained their religious essence. That is why the symbols associated with these colors are often used in art.

In Uzbek folk proverbs, black is used as a symbol of evil. Because, as mentioned above, this color has always been a symbol of evil and horror in the minds of the people. said But the figurative representation of the image of the bad man in black gave the article expressiveness, impact, conciseness, and conciseness. This is a concept that contradicts the spiritual and moral norms of our black-faced people. This concept is used as a poetic symbol in folklore. Therefore, in the article "The face that is separated from the people will be black", the face serves as a symbol of blackness, humiliation, inferiority. In folk proverbs, not only words that express color, but also other words become symbolic by obtaining color identifiers. For example, the word "earth" refers to the earth that provides food for all and carries the whole being on its shoulders. But before that word, the symbolic meaning of the scientist was created by quoting the color identifier "Black". The black color in the proverb "Be a land, if you are not a land, be a black land" and the symbolic images identified by this color have played an important role in concisely, effectively and figuratively expressing the wise, exemplary ideas of the people. All of them are led by the ancient ideas and views of the people associated with black. The fact that this color and imagination are equally understandable to all allowed the article to turn this color into an artistic image. The symbolic image serves to enhance the artistry, attractiveness and impact of the work.



One such color is white. This color symbolizes goodness, purity, elegance and youth. In Uzbek folk proverbs there are many symbolic images in white. They serve to summarize the content of the proverb. It is very rare in folklore that white is a special symbol. Because in many places this color is a determinant of something or an event. For example: "A white dog is a black dog, anyway a dog". The meaning of the compound symbol in this proverb is that all bad people have bad meanings. In such symbols, the core, that is, the defining meaning, is assigned to the dog. Therefore, the dog symbol in the proverb means a bad person. White and black do not matter in the article. That is why the symbols of the white dog and the black dog are not the black and white of the bad man in the article, because they all conclude that they are bad. In the following article, the color white symbolizes independently: "If you want my face to be white, do the right thing. The white face is the ancient symbol of goodness, peace, righteousness, not to be ashamed." Thus, the fact that the color white is a symbol in a particular case goes back to the ancient notions of the people about this color.

There is one more thing to note here. The ancient use of white as a symbol of goodness is due to the fact that some of the things in white are useful to man. For example, milk has long been known to be beneficial to humans. That is why people did not always say milk, but made a word from the category of adjectives that describe its color. As a result, the word that describes the quality of color has become a word that directly expresses the white thing itself. Because no is understood in the same way for all, the word serves as a symbol associated with color. For example, "Where there is whiteness, there is no pain." White milk is a word based on a white symbol meaning yoghurt. This word symbolizes that the patient should not drink milk and yoghurt in order not to get sick, that is, he should always consume milk and yoghurt. represents bread.

So, in Uzbek folk proverbs there are many symbols associated with the color white, and the meanings of all of them have long been associated with the meaning of this color, such as kindness, serenity, correctness, health, light. goes to mean.

The symbol of red is also common in Uzbek folklore. This symbol of color is also associated with the ancient cosmogonic views of the people. hemorrhage area. Later, redness became a symbol of both negative and positive meanings on the basis of dual (two different) views. As a symbol of negative meaning consists of war, bloodshed, etc., as a positive symbol, folklorist Sh. Turdimov As noted in the settings, it means such things as warmth, girl (woman), love, gold, wealth.

In the following article, the color red symbolizes love: "Girls fly to the red, the merchant - to the money."

In this article, the greed of girls for love is compared to the greed of a merchant for money and wealth. Indeed, grown-up girls fly to guys to express their love and admiration for them. This characteristic of young inexperienced girls is represented figuratively by the likeness of the merchants to the thirst for money. The "red" symbol played an important role in the clear and concise expression of the proverb.

In the following article, the color red is used to mean gold. "The red cup will lead Khidr astray." The proverb clearly and succinctly states that no one, not even a saint, has a human head in the face of a human trap. Therefore, while Khidr is a universal symbol, red is a symbol of money,

wealth and gold. Various variants of the proverb are used, such as “Kizil khizni aynitar”, “Kizil korsa, khizir ozar”, “Kizildan qazi da uyalar”.

In addition, in folklore, the color yellow is also used as a symbol of separation, need for something, illness, longing.

In folklore, the symbol of color is very ancient and very clearly used. In addition, it can be seen that the color symbols in folk proverbs are associated with the ancient religious beliefs of the people.

This means that, as they say, “Shortness is the sister of talent” (APChekhov), symbolic images associated with color can not only provide the leading condition of the small genre - brevity, but also serve to expand its "field of activity" and prolong its life. does.

#### REFERENCES:

1. Losev A.F. The logic of the symbol. Losev A.F. Philosophy. Mythology. Culture -M., 1991.-C.258.
2. Sarimsakov B. About proverbs. Uzbek folk proverbs.-T., 1978.-197 pages.
3. Uzbek folk proverbs. Two volumes. Volume 2 –T .: Fan. - 1988. - p.55.
4. Turdimov Sh. Colorful world. ”Youth”, 1987, issue 8, pages 60-62.
5. Taylor B. “Primitive culture” - M .: Science. 1989. –C. 76-80.
6. Vamberi G. Ocherki Sredney Azii. –M., 1866. –C. 323-324.
7. Parandovskiy Ya. Alchemy of Slova.-M., 1972.-208.
8. Losev A. F.Logika simvola.-M., 1991.-S.258.
9. See: Philosophical encyclopedic dictionary, -M., 1983.-S. 607- 608.
10. Sharopov A. Worlds within the worlds.-1978 pages 70-71.



**ACADEMICIA**  
**An International**  
**Multidisciplinary**  
**Research Journal**  
(Double Blind Refereed & Peer Reviewed Journal)



DOI: **10.5958/2249-7137.2021.01314.8**

## COMPARATIVE ANALYSIS OF THE PROPERTIES OF SIRO YARN SPINNED BY NATURAL AND CHEMICAL FIBERS

Nuriddin Nuralioglu Roziboyev\*; Vohid Tolaganovich Isakulov\*\*

\*Basic Doctoral Student,  
Department of "Spinning Technology",  
Tashkent Institute of Textile and Light Industry,  
UZBEKISTAN

\*\*Associate Professor,  
Candidate of Technical Sciences,  
Department of "Spinning technology",  
Tashkent Institute of Textile and Light Industry,  
UZBEKISTAN

### ABSTRACT

*In this article are study, Siro-spun yarns were produced from cotton and chemical fibers, and the properties of the yarns were studied. Siro spun yarns from a blend of cotton and polyester (50% / 50%) fiber, cotton and bamboo (50% / 50%) polyester and bamboo (50/50%) fiber, were produced separately and compared on physical and mechanical performance. Parameters such as yarn unevenness (U%, CVm%, CV10m), Siro yarn hairiness and tension were tested and analyzed.*

**KEYWORDS:** *Carded Yarn, Siro Yarn, (Zinser-351), Yarn Quality Parameters, Linear Density, Count.*

### INTRODUCTION

Today in the spinning mills in the creation of a new range of yarn from a mixture of natural and chemical fibers, as well as the development of resource-saving technology, full use of the technological capabilities of the ring spinning machine installed in spinning mills, import substitute, competitive provides extensive use in the production of woven knitted products that can meet the requirements of domestic and foreign markets.

The technological possibilities of ring spinning machines were studied, efficient use of local raw materials. Due to the improvement of the technology of spinning cotton and chemical fibers by the "Siro" method, as well as the production of high-yield yarn, improving yarn quality, reducing technological processes in spinning mills, the introduction of the Siro method will increase labor productivity by 25-30%.

Siro spun yarns from cotton and chemical fibers are characterized by abrasion resistance, high strength, and low hairiness.

The quality of regular yarn produced by the classical method, the unevenness of the yarn and the elongation at break, as well as the abundance of technological advances lead to an increase in the cost of yarn.

The method that bypasses these processes a bit is Siro as a method of spinning, technical technological processes, electricity, number of transition, a reduction in labor costs is achieved.

The sequence of technological processes of the classical and Siro methods is shown in Figure 1 [1,2,3,4].

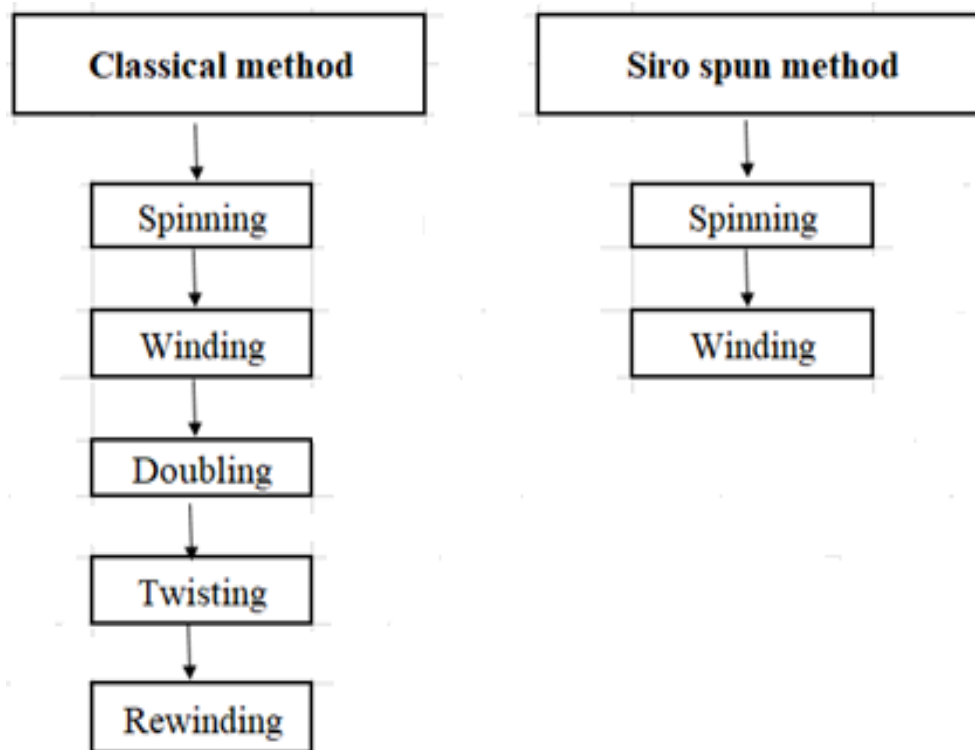

**Figure 1.** Technological sequence of production of classical yarn and Siro yarn.

The research of domestic and foreign scientists has allowed to create and implement a number of new twisting machines. VTS Volkman (FRG), Yantra (NRB), Savio (Italy), Rieter (Switzerland), Marzulli (Italy) and other companies, is carrying out this work [5,6].

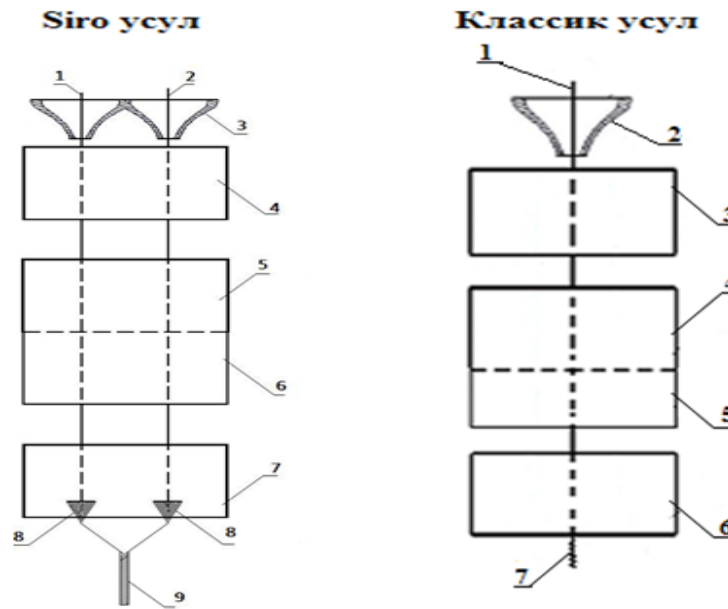

Figure 1.1.

Figure 1.2.

- 1-Cotton and chemical fiber yarn;1 Chemical fiber roving;  
 2 Single-eyed densifier;2-Cotton fiber roving;  
 3- Unwanted crushing roller 3-Two-eye densifier;  
 4 -The belt crushing roller; 4- Incoming crushing roller;  
 5- Belt transmission cylinder;5 Belt crusher;  
 6- Exhaust crushing roller; 6 Belt transmission cylinder  
 7-Spun yarn; 7-Spinning crushing roller;  
 8 twisting triangle;  
 9 Spun yarn

Siro spinning technology was first developed in 1947 by Nesler A.M. was suggested by, however, this method was not widely used due to the lack of a reliable means of controlling the breaks in one of the two sliver of the spun yarn [7,8].

The SIRO spinning method was invented by CSIRO laboratories in 1975-76 and commercialized in 1980.

A brief spinning plan for the production of Siro spun yarn from a blend of cotton and polyester (50% / 50%), Cotton and bamboo (50% / 50%), polyester and bamboo (50/50%) was developed and is presented in Table 1.

The first experimental work was carried out by JV Osborn Textile,

100% polyester, 100% bamboo and 100% cotton in the blowroom department during the test, 1) 70% of Porlok-2 4-type 1-grade fiber, and 2) Sultan variety 4-type 2-grade cotton fiber 30% mixed and carded sliver was obtained.[9,10].

Experimental tests of quality indicators of the carding sliver were carried out in the training and production laboratory of the department "Spinning Technology"[11]. A plan for spinning the experimental test results was developed. According to the plan, the technological parameters of the car were re-adjusted.

**TABLE 1 BRIEF SPINNING PLAN OF COTTON AND CHEMICAL FIBERS (50/50)  
MIXED YARN SPINNING OF JV "OSBORN TEXTILE" JV LLC**

№	Technological equipment item	Linear density of the output, tex	Doubling count $d$	Draft count $E$	Twisting count		Delivery speed		Efficiency, %	Theoretical productivity kg / h
					$\alpha_t$	K bur/m	V m/m in	n $\text{min}^{-1}$		
1	Card C 60	5363	1				165		0.90	60
2	Draw frame I transition SB-D 45	5363	6				500		0.85	150
3	Draw frame II transition RSB-D 35	5100	8	8,36			500		0.85	150
4	Roving frame Zinser-668	900	1	5,65	8,7	29		1100	0.90	0,9
5	Spinning frame Zinser-350	32	2	45,38	32.63	730		15480	0.90	0,022

The linear density of cotton m $\acute{e}$ lange, polyester, bamboo, 0-pass shearing fibers delivered to the test laboratory was determined according to the plan, and experiments were conducted on the equipment available in the laboratory[12,13]In this transition, based on the technical characteristics of the HSR-1000 draw frame machine, the parameters of the machine were changed accordingly. Then, on a RSBD-45 draw frame machine, 500 tex linear density sliver were obtained and the figures are given in Table 1.1, 1.2.

**TABLE 1.1 PROPERTIES OF COTTON FIBER (RESULTS TESTED IN HVI)**

No	Fiber on process	Stapel	Length, inch	Mic	Strength, cH/tex	Rd	+b	Trash count	SFI, %	Uniformity, %	Elongation, %
1	Cotton fiber in bale	36,0	1,12	4,6	28,33	75,90	9,10	3,0	4,30	83,00	6,86

**TABLE 1.2 NUMBERS OF COUNT OF COTTON, POLYESTER, BAMBOO YARNS**

Items	Number of count, ktex
100% , cotton fiber	5.0 ktex
100%, polyester fiber	5.0 ktex
100%, bamboo fiber	5.0 ktex

Before entering the selected and calculated values in the Zinser-668 spinning machine into the machine's computer program, the total elongation constant of the machine was changed and the total elongation variable gears were replaced, and the calculated values were entered into the machine's computer control screen. The machine was started and the expected result was obtained from the experiment, ie Ne 0.65, linear density 500 tex cotton polyester, linear density 900 tex fibers from bamboo fibers.

**TABLE 1.3. NUMBER OF COUNT OF COTTON, POLYESTER, BAMBOO YARNS**

Items	Roving count
100% , cotton fiber	Ne0.65
100%, polyester fiber	Ne0.65
100%, bamboo fiber	Ne0.65

Sequence of technological processes in Osborn Textile JV

- BDT-019 automaticaly bale opener;
- BLBO condenser;
- Blow room line by Trutzschler;
- DK-803 carding machine;
- 1-VOUK draw frame machine at 0 passage;
- HSR-1000 draw frame machine;
- Zinser-668 roving machine;
- Zinser-350 ring spinning machine;

In order to obtain the "Siro" spun yarn on the Zinser-350 ring spinning machine, the movement scheme of the machine was analyzed, the machine's elongation and cooking gears were replaced,

the corresponding calculations were performed, entered into the computer program and the results were obtained.

The densifiers installed on the spinning machine's drafting zone were replaced with specially designed densifiers to form the Siro yarn. Siro cotton yarn and chemical fiber yarn were sent to the two-eyed spinner separately, and the flyer coming out of the stretcher was separated and twisted by means of a twisting triangle.

The quality of Ne 18 Siro yarns obtained as a result of the experiment was determined on modern test equipment in the laboratory of Bakan Tex LLC and JV Osborn Textile.

**TABLE 1.4. NUMBER OF SIRO YARNS MIXED FROM COTTON, POLYESTER, BAMBOO FIBERS**

Items	Yarns count
Cotton/polyester50/50	Ne 18
Cotton/bamboo50/50	Ne 18
Polyester/bamboo50/50	Ne 18

Physical and mechanical properties of Siro yarns obtained from a mixture of cotton and chemical fibers (yarn number (Ne), number of twists (T / m), tensile strength (cN / Tex), Uster% (Cv), yarn thinness (-50%), yarn thickness (+ 50%), number of nepses (+ 200%), yarn hairiness (H and yarn thickness) are given in the tables and figures below.

**TABLE 1.5 PHYSICAL AND MECHANICAL PROPERTIES OF SIRO YARNS OBTAINED FROM A MIXTURE OF COTTON AND CHEMICAL FIBERS**

	Item name	Cotton/polyester 50/50	Cotton/bamboo 50/50	Polyester/bamboo 50/50
1	$R_{km}$	20,06	16,29	20,30
2	$CV/(R_{km})$	6,78	5,95	6,57
3	E	7,29	7,06	14,68
4	CV(E)	6,57	9,58	5,48
5	PP	658,0	534,6	666,04
6	CV(PP)	6,78	5,95	6,57

Figure 1.3

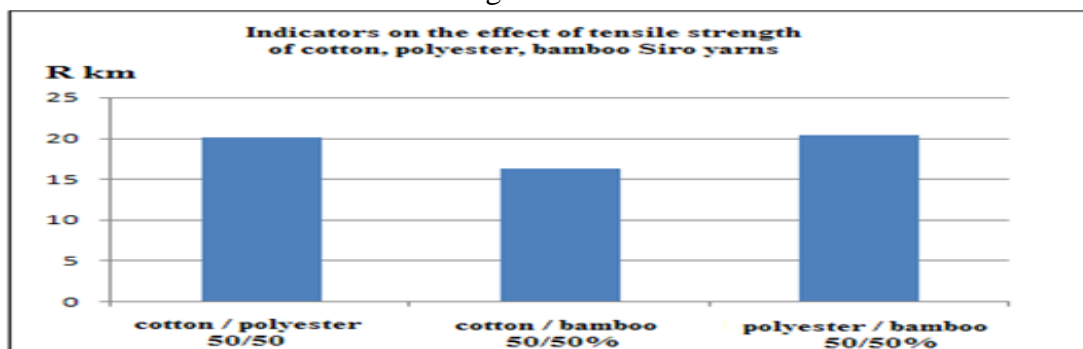



In this research work, cotton / polyester (50/50%), cotton / bamboo (50/50%), polyester / bamboo (50/50%) mixed Siro baked yarns were produced on a ring spinning machine made of 100% cotton, 100% polyester, 100% bamboo fibers, Siro yarn strength, were compared in terms of friction resistance, unevenness, hairiness, and tensile strength. The physical and mechanical properties of the obtained Siro spun yarn were studied. The effect of the raw material on the properties of the spun yarns, the number of yarns, the twisting coefficient and the distances between the yarns were studied. The effect of the raw material on the physical properties of the yarn was found to be statistically significant. Cotton-spun yarn from a mixture of cotton / polyester (50/50%) was found to have better quality performance than cotton / bamboo, cotton / viscose mixed fiber Siro-spun yarn.

#### REFERENCES:

1. C.A. Lawrence, "Advances in Yarn Spinning Technology". CRC Press. New York, 2010.
2. S. Unal & S. Ömeroğlu, "Ring İplik çiliğinde Farklı Sistemler Kullanılarak Direkt Olarak Elde Edilmiş Çift Katlı İplik Özelliklerinin İncelenmesi" Pamuk kale Üniversitesi Mühendislik Bilimleri Dergisi, vol.19, issue 4, pp.165-169, 2013.
3. K.P.S. Cheng & C.H. Yuen, "Siro and Two-fold Yarns" JHKITA, pp.64-70, 1997.
4. N. Brunk, "Elitwist-Three Years After Market Introduction" Spinnovation, vol.22, issue 7, pp.10-16, 2006.
5. S.A. Mansour & M. Tawfik, "Production of Siro-spun Yarns from Short-staple Fibres" Indian Journal of Textile Research, vol.11, pp.70-72, 1985.
6. M.N. Sun & K. P. S. Cheng, "Structure and Properties of Cotton Siro-spun Yarn". Textile Research Journal, vol.70, issue 3, pp.261-268, 2000.
7. T. Bedez Üte & H. Kadaoğlu, "Viskon Siro-spun ve Ring İpliklerinin Özelliklerinin Karşılaştırılması" Tekstil Teknolojileri Elektronik Dergisi, vol.3, pp.12-23, 2009.
8. Yıldız Begüm Selen, Kilic Musa "An Investigation On Properties Of Siro-Spun Yarns" Annals Of The University Of Oradea Fascicle Of Textiles Leatherwork Turkiyaizmer .131-136, 2017.
9. Рўзибоев Н.Н., Исакулов В.Т., Ярашов С.Н., Рўзибоев Р.Н. "Таббий ва кимёвий толаларидан Siro йигирилган ипларини физик-механик хусусиятлари «Тўқимачилик Ва Тикув Трикотаж Саноатини Янада Ривожлантириш Ва Кадрлар Тайёрлашга Инновацион Ёндашувлар» Республика онлайн илмий амалий анжумани. Наманган – 2020.
10. Ruzibaev Nuriddin Nurali O'g'li, Isakulov Voxid Tolaganvich "Investigation Of Factors Influencing The Properties Of Spun Siro Strip", «International Journal of Advanced Research in Science, Engineering and Technology» INDIA (September 2020)
11. Н.Н.Рўзибоев, С.Н.Ярашов, В.Т.Исакулов "таббий толалардан йигирилган siro ипларнинг физик –механик хусусиятлари" «Fan, ta'lim, ishlab chiqarish integratsiyalashuvi sharoitida paxta tozalash, to'qimachilik, yengilsanoat, matbaa ishlab chiqarish innovatsion texnologiyalari dolzarb muammolari va ularning yechimi» Тошкент 2020 йил.

- 
12. Ш.А.Қорабаев, Б.М.Мардонов, С.Л.Матисмаилов, Ш.Ф.Махкамова, Н.Н.Рўзибоев  
Пишитиш интисификаторида ипнинг харакат қонуниятини аниқлаш. НамМТИ ИТЖ  
2019.
  13. Исақулов В.Т., Бурнашев Р.З., Янги турдаги ип ишлаб чиқариш технологияси ГКНТ-  
2001 йил, Тошкент – 2001 йил.

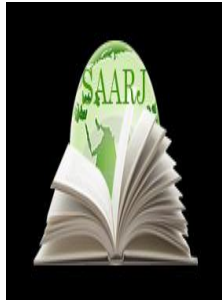

**ACADEMICIA**  
**An International  
 Multidisciplinary  
 Research Journal**  
 (Double Blind Refereed & Peer Reviewed Journal)



**DOI: 10.5958/2249-7137.2021.01315.X**

## TYPES OF DIPLOMATIC TERMS IN THE UZBEK LANGUAGE ACCORDING TO THEIR SEMANTIC RELATIONS

**Sanjar Mavlyanov\***

\*Researcher,

Tashkent State University of Uzbek Language and Literature Named after Alisher Navoi,  
 UZBEKISTAN

Email id: movlanovsanjar@mail.ru

### ABSTRACT

*No matter how important the form and appearance of diplomatic documents, attention should be paid to the main part, its content. The idea must be clear, concise, logically sound, and concise. Diplomatic documents are very comprehensive, they cover not only issues related to the declaration of independence of countries and the establishment of diplomatic relations with other countries, but also political issues such as peace, neutrality, disarmament, etc. and various issues related to cultural cooperation. The author comments on the semantic relationship between diplomatic terms in the article. In addition, the article discusses the lexical-semantic features, relationships and synonyms and antonyms between diplomatic terms.*

**KEYWORDS:** *Diplomacy, Diplomatic Terms, Diplomatic Documents, Synonyms Antonyms, Speech-Thematic Groups, Lexical, Semantic, Speech-Specific Terms, Dictionary.*

### INTRODUCTION

While talking about the lexical-semantic features of diplomatic terms, it should be borne in mind that it is possible to focus on their speech-thematic groups. In addition to a specific formal template, each document uses speech-specific terms.

Diplomatic documents are very comprehensive, they include not only issues related to the declaration of independence of countries and the establishment of diplomatic relations with other countries, but also political issues such as peace, neutrality, disarmament, etc. and various issues related to cultural cooperation.

Therefore, diplomats dealing with diplomatic documents are required to know exactly the traditions and names associated with each state.

The names of the heads of state, ministers and other high-ranking officials should be written in full without any abbreviations. Writing names, surnames, positions in accordance with the original is a sign of respect and attention. [ 1]

In addition, in some official documents, personal appeals, comments are used words that reflect the friendly relationship. Researcher SaodatNosirova in her dissertation "Lexical-semantic and structural analysis of diplomatic terms in modern Chinese" is widely used in diplomatic documents.

### **Main part**

Analyzes the "protocol formulas" and divides them into the following speech-semantic groups.

A) Address words

B) Official remarks

C) Official words used in the final part of diplomatic speeches.

**Reference words.** Words in the sense of respect for the beginning of an official document are used in both the main and middle of diplomatic documents, and official words and phrases are used in the final part of official documents.

It is observed that the words of appeal vary depending on the gender, social and professional status of the person.

For example:

The personal note contains the following forms of appeal:

"Mr. President", "His Majesty the King", "His Majesty the Queen", "His Excellency the Minister", "His Majesty the Queen", "The Pope", "The Grand Minister" and others. When the condolence is indicated, the words of respect are omitted and written as "Mr. President", "Mr. Ambassador", "Mr. Prime Minister". If the note or letter is friendly, the main part also begins with words that express respect. In correspondence through letters from representatives of a foreign country or in letters sent by foreign countries, we can see the following units of reference. We can meet such units as "Mr. President", "Mr. President", "Dear Shavkat Mirziyoyev", "His Excellency the Prime Minister", "His Excellency the Prime Minister" and others.

**Official (kind) words.** In general, when using words and phrases to heads of state, the king, the foreign minister, it is necessary to take into account the role of the two sides in society, their relationship and the political situation.

Each type of reference word used in diplomatic documents has its own meaning and scope. Improper use of certain address words can lead to misunderstandings between interlocutors [ 2 ] .

**Official remarks used in the final part of diplomatic documents.** Diplomatic documents form the basis of the formal style. In addition to the formal word and stereotyped units, they also use units of praise. Researcher SaodatNosirova included such words in the group "Words used at the end of diplomatic documents." In our opinion, it would be more appropriate to call such words of

praise and respect. This is because the words used at the end or beginning of diplomatic documents are written in order to show respect to the sender and praise them.

"I express my deep respect to you"

"With high respect"

"Wishing you good health"

"I express my deep respect"

"I take this opportunity to once again express my respect and esteem to you."

"Trust me once again for my respect and esteem."

Official letters and notes may contain a statement of respect at the end of the document, even before signing:

"Best wishes"

"With all due respect"

"With respect and esteem"

"With deep respect to you"

Like "Wishing you good health."

As discussed, words of praise and respect can be one-component and multi-component, and synonyms can sometimes be used in the same section of diplomatic documents.

The word "respect" with the word "respect", the word "thank you" with the word "thanks", the word "patience" with the word "perseverance", the word "high", can be easily replaced by the word's "infinite". The emotional impact of words a letter to the ambassador or the government, addressed a warm relationship with the person as well as his Master is indicative of a representative of the state [ 3] .

It is well known that any word (lexeme) can be a common word or term according to its nature. As modern sciences are divided into many branches, one of the important tasks is to determine the place and essence of the lexemes used in them. In this regard, the criteria for distinguishing between a term and a non-term word or phrase are clearly defined.

A term is a linguistic unit word or phrase belonging to the language of production, science, and technology, which is a special type of universal language.

The term - a concrete thing - is a specialized name for the original abstract concepts of the subject.

The term requires a specific definition, which can be used to more accurately express the content of the relevant concept, to distinguish one concept from another, while at the same time allowing a particular concept to be placed in a certain classification line.

Terminology is defined as the sum of terms that interact with a system of concepts of a particular science.

Any system of concepts corresponds to a specific system of terms. Terminological systems are evolving along with the development of science. The terms are introduced differently from commonly used words, and their use is somewhat controlled.

"The term does not appear," but is "invented" and "created" with the understanding of their necessity. Also, unlike a simple word, the meaning of a term does not depend on the context. As long as a particular lexeme is used in its terminological sense and in its own terminological and its own terminological space, the same meaning is retained.

However, there is no doubt that context is necessary to distinguish the exact meaning of polysemous terms.

Diplomatic terms, on the other hand, are far from ambiguous. They differ in that they have only one meaning. But only some terms create multiple meanings depending on the context.

For example:

*The* word *absolute* has come to us through British diplomacy and it can have many meanings depending on the context.

1. unconditional absolute

... Italy was soon transformed into a one-party absolute dictatorship.

1. Full. This meaning is also formed by generating valence in context.

Scandia's absolute trust and discretionary trust at glance.

Absolute veto - full veto.

For our Ambassador to propose joint use of the base in Gibraltar would give Spain an absolute veto over every think ...

Diplomat II. A lockable briefcase in the shape of a small suitcase.

Diplomatic 1. Concerning the official relations of the state with foreign countries and diplomacy. Diplomatic act. Diplomatic relations. Diplomatic relations[ 4].

**Lexical-semantic relations in the Uzbek language through diplomatic terms.** No matter how important the form and appearance of diplomatic documents, attention should be paid to the main part, its content.

It is necessary to state the opinion clearly, accurately, logically and taking into account the characteristics of the other party. In these documents, uncertainty should not be a misrepresentation of states. Because it cannot be corrected later or given separate information.

Diplomatic correspondence shall be conducted by the Ministries of Foreign Affairs in the official language of that country and shall be accompanied by a translation into an international language. Embassies and consulates must also conduct their correspondence in their official language or in the official language of the country in which they operate. In diplomatic documents, the focus on the word should be very strong. Its language should be simple and fluent, free from portable meanings, the word should be absolutely consistent with the content, and no other meaning should be expressed. Expressions such as "half a cup under a cup" have no

place in diplomatic documents. if there is any subtlety or abstraction in the meaning of the word, it is better to replace it with another word.

Therefore, it is important for diplomats to know the meaning of diplomatic terms, to have accurate information about their places of application. There are certain differences in the use of diplomatic terminology and literary language. This is especially evident in diplomatic documents.

Thus, the terminology of the language of diplomatic documents has its own lexical-methodological, morphological and syntactic features.

Lexical methodological diplomatic correspondence. It has its own system of terms, molded stable compounds, various means of expression such as synonyms, antonyms. It should be noted that while the formal style of work is free of emotional words, diplomatic correspondence is characterized by a wealth of emotionally colored words, words of praise. Words of praise are one of the essential parts of a note, the most basic type of diplomatic correspondence. Depending on how they are used, these documents can be divided into certain types. For example, in the notes, such words as "Your Excellency", "Dear Sir", "Trust in my high esteem for you" - the use of words of honor is friendly to him, and the use of words of respect is less official. gives color.

The synonymous line of diplomatic correspondence is not more methodologically neutral words, but rather words with a positive emotional color and biblical style. For example, I say the word instead of the word, the opportunity instead of the time, the position once instead of the word, the position instead of the word, thank you instead of the word thank you, instead of the word happy are applied. Phrases in the diplomatic protocol (especially in oral speech), fixed phrases used in a figurative sense, including over the head, my head turned blue, do not despair, head on one side The expressions are widely used, as well as folk proverbs, aphorisms from the sages, as if a body is a soul. Such stable connections serve to increase the sensitivity to give a high spirit to the speech. In ancient times, the phrase was used especially often in diplomatic documents. It is still common in some official personal letters.

In general, our people say in diplomatic documents that they are both friends and enemies. The word spoken or written in its place connects nations to one another brings together, helps to resolve some disagreements [ 5 ] .

This type of formal style also has grammatical features. In diplomatic correspondence, it is often spoken on behalf of the first or third person, so the cut of the sentence is in the form of the first or third person. It should be noted that passive constructions are often used in diplomatic discourse. It is even common to express it in vague forms, such as by a person or “**a decision made by us**”. With the help of more conjunctive conjunctions (**both, and**) of sentences and phrases, and conjunctions with prepositions -ki, therefore due to the following conjunctions, affixes -b, -ibare used to link. In diplomatic correspondence, introductory words and introductory combinations are often used.

Morphologically, personality, identity, pronouns, indefinite verb forms, especially the affix “-moq” form of the noun, passive pronouns, conjunctions (**to collaborate, to hope, to achieve, to cancel**) It is worth noting that diplomatic correspondence is written in an uplifting spirit, so it is worth noting that it is often used in conjunction with conjunctions and pairs of verbs. serving

grammatical - morphological forms are widely used. For example, the use of archaic and biblical forms of the name of the affix - *moq* form, verbs *to express confidence*, *to accept*, and so on.

### **Synonymy between diplomatic terms in Uzbek**

The language of diplomacy is very delicate and requires a great deal of skill on the part of the ambassador.

Synonyms, no matter how close we are to each other in the expression of concepts, differ in the expression of the subtleties of meaning. In the field of diplomacy, synonyms also play an important role in expressing ideas clearly and purposefully. World diplomats say that "diplomacy often finds itself in an awkward position in the negotiation process, indicating that there are still problems in diplomacy." One of them is synonyms," they told diplomacy.

Negotiations between nations ability to act on the basis of mutual consent between nations, as She has had a long and distinguished career in diplomacy.

For example;

Tact, tactfulness- polite, courteous, orderly, He gave a tactful critique of her story.

British diplomats can easily use the word politic instead of diplomacy. They have the same meaning, they are synonyms."

It would not be political to ignore them. Diplomacy and foreign policy are synonymous. Union, union, alliance, confederation coalition, the words union are grouped into a single synonymous line. However, although the words are combined on the basis of a common meaning, there are differences in some aspects of their meaning.

Alliance - a contract-based association;

Confederation - an alliance, a union for a specific purpose;

A coalition is an alliance

The word "union" is derived from the Texas word "Taisha" in Kaddo. Taisha means "friends", "allies". American tribes were friendly to newcomers and used the word "Taisha" in reference to them.

Ambassador, Representative, Delegate, Consul,

Memorandum, delegation,

Agreement, contract, treaty,

Conflict, seriousness, conflict, conflict

Protest, protest, protest

Decree decision;

Consulate, representative office, embassy;

Condolences, sympathy;

Argument - debate

Consolidation, attachment;



Tactless undiplomatic, untactful

Delicacykeenness, acuity, sharpness.

In it, the synonymous series is enriched by foreign words, and most of the words based on translation are mainly used to express narrower meanings.

There is a scientific difference in the classification of diplomatic synonyms. In this regard, synonyms can be divided into 2 groups.

- Synonyms with different meanings (absolute or doublet)

Thank you (rahmat), thank you (tashakkur);

To be happy (mamnun bo'lmoq), to be happy (xursand bo'lmoq);

To express (bildirmoq), to express (izhor qilmoq);

Career, position;

It is used sparingly in diplomacy. This is because even small differences in the meaning of words in a synonymous series can have a significant effect on the field.

For example, the words spy (josus), spy (ayg'oqchi), and spy (shipyon) are grouped together by the term spy, but there are some spiritual differences between them.

A spy is someone who is hired to investigate and kill someone.

A spy is a person hired by certain officials to find out the secrets of a group or country.

The exact translation of the word spy can be a double synonym for spy and spy.

The terms state, government, are actually combined on the basis of organizational semaphore.

But there are some semantic differences between the words in the synonymous series.

The state is the legislature, the executive, and the judiciary.

Residence;

The residence is the permanent residence of the head of state.

The residence is a mobile residence where the head of state works.

Consulate, embassy, representative office;

This synonymous series is also based on the term embassy, and the consulate is a smaller organization that deals with smaller issues. For example: British council, American council, Korean council.

These organizations serve to develop the language, science, culture and arts of a country.

The embassy is a place where more than 17-18 ambassadors work.

An embassy is a place where representatives of a state operate. An embassy is larger than a consulate and deals with important interstate issues.

The terms diplomacy and foreign affairs are also synonymous with British diplomats

### Antonym between diplomatic terms in Uzbek language

The lexical meaning of a lexeme is not a rigid, fixed phenomenon, although it is more stable, it can change over the years under the influence of certain factors. Lexemes learned from other languages become polysemous lexemes over time under the influence of various linguistic and non-linguistic factors. As the meaning of lexemes in a language increases, so do the synonyms, antonyms, homonyms, and other phenomena in the language. An antonym is a relation of lexemes that have opposite meanings [ 7] . An antonym is a relationship between two lexemes, and one of the denotative semaphores of these lexemes is the opposite semaphore. In the pair of diplomatic-rude antonyms, diplomatic-polite means positive, while rude means negative. The phenomenon of antonyms is not unique to all words in a dictionary.

Antonym is a stable semantic relationship based on antonym pairs. Although antonymous pairs have opposite meanings, they represent the two extreme sides of the same event, the two poles.

If there are intermediate events between the meanings of the antonym pairs, we can say that this antonym relationship is formed on the basis of hierarchy. At the same time, the differences between the first and last lexemes of spiritual hierarchy increased, eventually reaching antonyms.

The phenomenon of antonym develops in the same way as the phenomenon of synonymy. For example:

Tact, tactfulness - a synonymous series of polite, courteous

Gauche, untactful, is a rude, rude synonymous series that creates a spiritual antonym. Or:

Tactless- xushmuomala, rude- qo‘pol;

Artless – impolite, sodda go‘l, qo‘pol;

Attentive - awake- hushyor- indifferent, uncorcerned- loqayd;

Adentage disadvantage, ustunlik- noustunlik;

Agree – disagree, rozi bo‘lmoq, rad etmoq;

Alove – forbit, ruxsat bermoq - man etmoq;

Achive failure, maqsadga erishish – maqsadga erishmaslik;

Aknowlage- ignore, qabul qilmoq, rad etmoq;

Belif –distras, ishonch- ishonmaslik;

Cagey- careless, ehtiyotkor – ehtiyotsiz;

Quality-resonable, arzon, qimmat;

Company- individual, jamoaviy, xususiy;

Complate- incomplate, to‘liq, noto‘liq;

Equale- unequale, tenglik - tengsizlik;

Exatly- approximately, aynan- taxminan;

Fake – original, soxta –haqiqiy;

Gain - lose, to‘plamoq yo‘qotmoq;  
General – specific, umumiy – xususiy;  
Gratefull –ungratefull, minnatdor- norozi;  
Legal illegal qonuniy noqonuniy  
Skeillfull- unskeillfull malakali malakasiz;  
Desire - despaire, umidli - noumid;  
Local - national, mahalliy- millatlararo  
Obey disobey bo‘ysunmoq bo‘ysunmaslik  
Loyal disloyal, sodiq, sotqin;  
Protect - unprotect, himoya qilmoq- himoyasiz;  
Prove - disprove, isbotlamoq- isbotlay olmaslik;  
Regular irregular to‘gri noto‘g’ri

## CONCLUSION

In summary, the widespread use of the phenomenon of synonymy and antonym in the field of diplomacy, especially in the naming of diplomatic documents, has been observed in practice to have negative consequences. Therefore, the documents should be carefully analyzed by sinologists before signing.

## REFERENCES

1. MuhammedovaS. MoydinovQ. State of speech culture language management. - Tashkent, 2013. - 141p.
2. Muhiddinova H., Abdullayeva A. A. Formal style type of diplomatic correspondence. - Tashkent, 1997.
3. Annotated dictionary of the Uzbek language. I skin. - Tashkent: Uzbekistan National Encyclopedia, 2006. - B 624.
4. SatouE. Diplomatic Practitioner Guide. 1961.
5. Mikhailkevich, G.N. International protocol and etiquette communication / G.N. Mikhailkevich. - 2nd ed., Rev. and add. - Minsk. : RIVSH, 2009
6. Annotated dictionary of the Uzbek language. I skin. - Tashkent: Uzbekistan National Encyclopedia, 2006. - B 624.
7. Jamolxonov H. HO’AT. O‘zbekiston milliy enkislopediyasi. -T. 2013. 264-265-bet.
8. Rasuljanovna, I. N. (2019). Lacunas Occurance In Semantic Fields Of Chinese And Uzbek Languages. *International Journal of Scientific & Technology Research*, 8(11), 1998-2001.

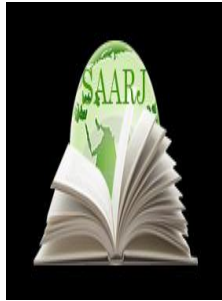

**ACADEMICIA**  
**An International**  
**Multidisciplinary**  
**Research Journal**  
 (Double Blind Refereed & Peer Reviewed Journal)



**DOI: 10.5958/2249-7137.2021.01316.1**

**MANUSCRIPTS OF AZIMKHOJA ESHAN AND HIS DEWANS**

**Sarvinoz Yokubjonkizi Azizkhonova\***

\*PhD Student,

AlisherNavoi State Museum of Literature of the Academy of Sciences,  
 Republic of UZBEKISTAN

**ABSTRACT**

*This article provides information about the life and work of the sheikh and poet AzimkhojaEshan, who lived and worked in the literary environment of Kokand in the late XVIII and early XIX centuries, and the known manuscripts of his works. In particular, the manuscripts of his office are stored in the fund of the State Museum of Literature named after AlisherNavoi of the Academy of Sciences of the Republic of Uzbekistan under the number №189, the fund of the Institute of Oriental Studies named after Abu RayhanBeruni of the Academy of Sciences of the Republic of Uzbekistan, Professor Hamid Sulaymon Manuscripts No. 6354, inventory digital manuscript №5992 / II kept in the main fund of the Institute of Oriental Studies named after Abu Rayhon Beruni of the Academy of Sciences of the Republic of Uzbekistan, main features of manuscripts №6209, №6750, №6806 information about*

**KEYWORDS:** *Dewan, Manuscript, Description, Mysticism, Genre, Wisdom, Muhammas, Musaddas, Wisdom.*

**INTRODUCTION**

In the history of Uzbek classical literature, artists who grew up in the literary environment of Kokand have a significant place. Among them are those whose lives, works, and scientific and creative heritage have not yet been fully explored. A comprehensive study of the heritage of unexplored manuscripts, identification of sources of their works, comparative analysis, and determination of their place in the classical literature are topical issues.

One of the artists whose creative heritage is almost unexplored is AzimkhojaEshan, a representative of mystical literature, which is an integral part of Uzbek classical literature.

---

## THE MAIN FINDINGS AND RESULTS

AzimkhojaEshan lived and worked in the late 18th and early 19th centuries. He was an excellent poet of Khogand and one of the great sheikhs in mysticism. One of the creators working in the genre of great wisdom. The approximate date of birth is set as 1200 AH (1785-1786 AD). According to the sources, AzimkhojaEshan was born in Sarmozormahalla of Kokand city in the Naqshbandi-Khojagon sect in an educated clergy family. AzimkhojaEshanAzimi shook his pen under his pseudonym. He died in 1263 AH (1847 AD). His grave is in the Sarmazor cemetery in Kokand.

According to the information, Azimi and his loyal friend and esteemed Jalali first learned Sharia and theology from their ancestors Nizamiddin Khoja (Sheikh and poet NizomiddinKhokandi) in Kokand. Then they went to Bukhara together and became disciples of the famous Sheikh KhalifaHusayn ibn Yusuf Bukhari and studied mysticism and madrasah [1, p. 18]. When he returned to his homeland, he served as an imam for 40 years in a large mosque in the village of KalDushan in Hoqand. Towards the end of his life he became blind.

There is only some information about his family and life. According to the poet Zavqi, Azimi had a son named Sadi[2, p. 56].

PulatjonQayumov described AzimkhojaEshon as “a scientist, a pious, pious, alert, loving, eloquent and handsome, full-bodied, white-faced, big-bearded, clean-shaven man”. He also described him as “a very strong, fiery poet, a great sheikh and scholar” [3, p. 321].

Azimi left us a literary legacy of more than 4,000 verses [4, p. 9]. He collected the poems he wrote and composed a dewan. It contains proverbs, ghazals, mustahzod, muhammas, masnavi and musaddas in Uzbek and Persian languages.

AzimkhojaEshan, a follower of Khoja Ahmad Yassavi, has 28 wisdoms in his divan. His wisdom includes didactic issues such as the wisdom of Ahmad Yassavi, i.e. religion and faith, piety and piety, the relationship between murshid and murid, the intercession of the Prophet Muhammad (saas), the world and the hereafter, heaven and hell, and the teachings of love expressed in the form For example, in his wisdom, the poet called on the people to be religious and honest, to make fair decisions in every matter. In Azimi's proverbs, the theme of love and romance is described in a unique way. He considers love for God to be real.

The language of the poet's proverbs is as simple and clear as that of Yassavi. The main theme of his wisdom is the interpretation of true love, the enlightenment of the spiritual experiences of the taxman on the path of monotheism, who seeks the attainment of the vision of Allah.

He is a creator who illuminates religious-mystical, moral-enlightenment ideas through his own artistic paints through his poems in the genre of great wisdom.

In his articles, O. Juraboev covered the life of AzimkhojaEshan and his manuscripts [5, pp. 18-22].

So far, ten manuscripts of this dewan have been known. Below we give a brief account of the manuscripts of this dewan known to us.

1. Manuscript kept in the fund of the State Museum of Literature named after AlisherNavoi of the Academy of Sciences of the Republic of Uzbekistan under the number №189. This copy is

one of the most complete copies of Azimi, and it is called “Murad ul-ashiqin” (Book of love of lovers) [5].

Secretary: not specified (on the cover there is an inscription “In the book of SayyidAkram Khoja”). Date of copying: Hijri 1294 (AD 1877), copied in Kokand city in a fluent Nasta'liq letter Manuscript size: 15.5x26.5 cm, text size: 8.5x16 cm. The manuscript consists of a total of 126 pages.

Beginning: (Bismillah ...)

اسم توبود احمد محمود محمد

وصف توبود رحمت رب بر همه اشيا

Ending:

هر که خاند دعا طمع داريم

زانکه ما بنده گنه کاريم

3. Institute of Oriental Studies named after Abu RayhonBeruni of the Academy of Sciences of the Republic of Uzbekistan is kept in the Department of Manuscripts named after Professor Hamid Suleiman under number 2694. This copy is also one of the most complete and beautiful copies of Azimi's office. Secretary and location not specified. Date of copying: 1311 AH (1893 AD) [6]. The cocoon is transcribed on silk paper in a beautiful Nasta'liq letter. Dimensions of the manuscript: 15x25 cm. Text size: 8.5x20.5 cm. consists of 125 sheets.

Beginning:

يا قادر از وصف تو قاصر زبان ما

باشد بقدر چصله ما بيان ما

Ending:

هر که خاند دعا طمع داريم

زانکه ما بنده گنه کاريم

4. Manuscript No. 6354 kept in the Manuscripts Department named after Professor عظيمديوان Hamid Suleiman. This manuscript is an inaccurate copy. The secretary, where it was copied, and the date are unknown because the last sheets were torn. The text of the manuscript was copied on plain Kokand paper in a fluent Nasta'liq letter. Manuscript size: 16x25 cm. Text size: 9x20.5 cm. The manuscript consists of 121 pages.

Beginning: (Bismillah ...)

يا قادرا از وصف تو قاصر زبان ما

باشد بقدر چوصله ما بيان ما

Ending:

كونكل نرم قىلغان طوطى دىك شىرنى مقالاتى

بو خصلت لار هميشه مرشد كامل علاماتى

5. عظیمدیوان Inventory digital manuscript 5992 / II in the main fund of the Institute of Oriental Studies named after Abu Rayhon Beruni of the Academy of Sciences of the Republic of Uzbekistan. This manuscript is an incomplete copy. Secretary and location not specified. Mirislom Mirkhomudbek is written in pen on the 117b page of the manuscript. The manuscript was copied in 1327 AH (1909 AD) in a large Nasta'liq letter on Russian factory paper [7]. Dimensions of the manuscript: 15x26 cm. This copy consists of 123 pages.

Beginning: (Bismillah ...)

یا قادر از وصف تو قاصر زبان ما

باشد بقدر چصله ما بیان ما

Ending:

ندامنده بولسون اشینگ سوز گداز

قیلسه بولمس یوقسه قللو ق ادابینی

6. عظیمدیوان - Manuscript No. 6806 kept in the fund of the Kokand Literary Museum named after Ghafur Ghulam. Secretary: Koriy [8]. The manuscript was written in 1303 AH (1886 AD) in small letters in a Nasta'liq letter on Kokand paper. This copy was copied in Kokand. The size of the manuscript is 23x14 cm. The size of the text is 17x8 cm. The manuscript consists of a total of 138 pages.

Beginning: (Bismillah ...)

یا قادر از وصف تو قاصر زبان ما

باشد بقدر چصله ما بیان ما

Ending:

ندامنده بولسه اشینگ سوز گداز

قیلسه بولمس یوقسه قللو ق ادابینی

7. Manuscript No. 6750 kept in the fund of the Kokand Literary Museum named after Ghafur Ghulam. This manuscript is written under the title "Nazmisulukuwahasbihol" (meaning, the poetic expression of the hasbi states of those who entered the path of the sect). Secretary: Muhammad Suluk. The date of copying is 1253 AH (1837-1838 AD). The copy was copied in Kokand on a Kokand paper in a Nasta'liq letter. The size of the manuscript is 24x13 cm and the text is 17x9 cm. The manuscript consists of a total of 148 pages (296 pages).

Beginning: (Bismillah ...)

یا قادر از وصف تو قاصر زبان ما

باشد بقدر چصله ما بیان ما

Ending:

ندامنده بولسون اشینگ سوز گداز

قیلسه بولمس یوقسه قللو ق ادابینی

8. دیوان عظیم - Manuscript No. 6209 kept in the fund of the Kokand Literary Museum named after Ghafur Ghulam. Since some of the pages at the beginning and the pages at the end of this manuscript are also missing, it is not possible to determine the secretary, the place and date of copying. The manuscript is kept in a sealed envelope with a museum seal. The cocoon was transcribed on a sheet of paper in a Nasta'liq letter. The paper size of the manuscript is 23x14.5 cm, the text size is 17x8 cm. A total of 69 pages.

Beginning:

ای محتسب گر واقف از خاک کس خونیم ما  
مست می حب کشته ایم یا مست معجونیم ما

Ending:

بیا اید لطمع داری کر از احسان دروشان  
بکن پیوند جان حویش را با جان دروشان

9. دیوان عظیم - Manuscript kept in the personal library of Abdulhafiz Muhammadkhanov [9]. Secretary and date not specified. It is believed that it was moved to Kokand in the 50s and 60s of the XIX century [1, p. 21]. This manuscript was copied on Kokand paper in an average Nasta'liq script. Manuscript size: 15x26 cm, text size 8.5x18 cm. This copy consists of a total of 208 pages.

Beginning: (Bismillah ...)

یا قادر از وصف تو قاصر زبان ما  
باشد بقدر چصله ما بیان ما

Ending:

ندامنده بولسون اشینگ سوز گداز  
قیسه بولمس یوقسه ققوق ادابینی

10. دیوان عظیم - Candidate of Philological Sciences Sayfiddin Rafiddinov [11] is kept in his personal library. This copy is one of the complete copies of the poet's dewan. Information about the secretary is not available. The manuscript was copied in 1319 AH (1902 AD) in a beautiful Nasta'liq script. Manuscript paper size: 14x25 cm. Text size: 10.5x 20 cm. It consists of 160 pages in total.

Beginning: (Bismillah ...)

یا قادر از وصف تو قاصر زبان ما  
باشد بقدر چصله ما بیان ما

Ending:

ندامنده بولسون اشینگ سوز گداز  
قیسه بولمس یوقسه ققوق ادابینی



---

## RESULTS AND DISCUSSIONS

AzimkhojaEshan lived and worked in Kokand in the late 18th and early 19th centuries. He is a mystic sheikh and poet. There are 10 manuscripts of his “Murad-ul-oshiqin” divan, which have reached us. Copies of this manuscript have been fully described and are being brought into scientific practice. An important aspect of these manuscripts is that for the first time in the history of Uzbek literature such a large-scale mystical poet was discovered.

## CONCLUSION

All copies of the Dewanian should be studied comparatively, and the base copy should be identified, taking into account the orderly and literate copying of the manuscript, the completeness of the text, the antiquity of the copied time, the lack of errors affecting the meaning of the work. Ten existing manuscripts were studied, and in the process of comparing the text of each, the main differences, such as byte drop, relocation, confusion of secretaries, errors in words, were identified, and in the process of compiling comparative text such errors were corrected and published. will be appropriate.

## REFERENCES

1. O.Juraboev. (2009) “On the manuscripts of Azim Khoja Eshan and his dewan”. *A mirror of literature. Scientific publication* №11. – Tashkent: - pp. 18-23.
2. Zavkiy. (2003) “A wonderful time”. Poems. –Tashkent:– p. 56.
3. P.Kayyumov. (2011)*History of Khojand and its literature*. “Tamaddun”. –Tashkent: - p. 321
4. B.Xasanov. (2009) *Azimxoja Eshon. “Murad ul-ashiqin”*. *Dewan*. –Tashkent: - p. 9.
5. Fund of the AlisherNavoi State Museum of Literature of the Academy of Sciences of the Republic of Uzbekistan №189 Manuscript, 125b pages.
6. Institute of Oriental Studies named after Abu Rayhon Beruni of the Academy of Sciences of the Republic of Uzbekistan, Department of Manuscripts named after Professor Hamid Suleiman №2694 Manuscript Colophon (page 125a)
7. Manuscript No. 5992 / II (page 113a) kept in the main fund of the Institute of Oriental Studies named after Abu RayhonBeruni of the Academy of Sciences of the Republic of Uzbekistan
8. Manuscript No. 6806 (page 133a) kept in the fund of the Kokand Museum of Literature named after Ghafur Ghulam
9. He was born in 1928 and lives in Degrezlikmahalla of Kokand city.
10. This source was photocopied by S.Rafiddinov from the original kept by one person (O.R.Juraboev)

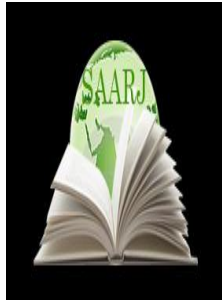

**ACADEMICIA**  
**An International  
 Multidisciplinary  
 Research Journal**  
 (Double Blind Refereed & Peer Reviewed Journal)



**DOI: 10.5958/2249-7137.2021.01317.3**

## THE ROLE OF MUSIC EDUCATION IN THE DEVELOPMENT OF PERSONAL QUALITIES OF CREATIVE PERSONS

**Sevar Samatovna Malikova\***

\*Associate Professor,  
 Candidate of Pedagogical Sciences,  
 Uzbekistan State Institute of Arts and Culture,  
 UZBEKISTAN  
 Email id: malikova.sevar@mail.ru.

### ABSTRACT

*The article is devoted to the results of research and the creation of guidelines on the pedagogical foundations of education and the development of personal qualities, logical thinking and scientific research of creative individuals by means of music.*

**KEYWORDS:** *Creativity, Scientific Creativity, Logic, Thinking, Personality, Personality Education, Musical Education.*

### INTRODUCTION

The issue of man and his upbringing, the development of a mature person has long been in the focus of attention of Eastern scientists, thinkers and sages. They elevated the human race to the heights they considered the best of all living beings. The valuable ideas of the thinkers who lived in Mazi about man and the purpose of his life, a perfect society, a just and enlightened king, a perfect man, still serve humanity without losing their value.

In the millennial history of the Uzbek people lived and worked the great scientists and thinkers who laid the foundation stone of world science, whose work is based on the education of the individual and the improvement of their logical thinking.

The history of the Middle East shows that the unprecedented rise in culture and education, medicine, literature, art and architecture, the emergence of scientific schools, the emergence and growth of a new wave of talented generations - all this is primarily due to the economy, agriculture and the more rapid growth of the urban economy, the high level of development of handicrafts and trade, the construction of roads, the opening of new caravan routes and, above all, the provision of relative stability.

On the basis of the rich spiritual heritage of our people, oriental and universal values, it is necessary to strengthen the historical roots of the nation, its spiritual foundations and revive its cultural, educational, pedagogical, musical and aesthetic work.

Perfect human education is carried out on the basis of complex means of influence. In this complex, artistic and aesthetic content, knowledge and imagination also play an important role. Therefore, at all times, special attention was paid to the aesthetic education of the younger generation. In particular, the young generation must have formed aesthetic perceptions, knowledge, certain skills and competencies in expressing their understanding of the world, their attitude to events and phenomena in the environment.

Our state has always been a guide to the development of art and culture. In particular, the Resolution of the President of the Republic of Uzbekistan dated July 8, 2008 No PP-910 "On the State Program for Strengthening the Material and Technical Base of Children's Music and Art Schools and Further Improving Their Activities for 2009-2014", July 8, 2008 Resolution of the Government of the Republic of Uzbekistan No. PQ-910 "On the State Program for Strengthening the Material and Technical Base of Art Schools and Further Improving Their Activities for 2009-2014", April 7, 2009 "You are One, Holy Motherland!" Resolution of the Cabinet of Ministers of the Republic of Uzbekistan dated March 11, 1997 "On the establishment of the Uzbek State Institute of Arts and Culture", Resolution of the Cabinet of Ministers of the Republic of Uzbekistan dated March 11, 1997 "On the establishment of the Republican contest" PQ-1091 Resolution of the President of the Republic of Uzbekistan No. 132 "On holding an international music festival" Proof of our words - "5 important initiatives to raise the morale of young people and meaningful organization of their leisure time" proposed by Mirziyoyev.

After gaining independence, Uzbekistan has paid more attention to the education of the individual and human spirituality, caring for him, caring for his interests, social protection of citizens has become a priority policy of the state, its daily activities. As stated in the Constitution of the Republic of Uzbekistan, "Democracy in the Republic of Uzbekistan is based on universal principles, according to which a person, his life, freedom, honor, dignity and other inalienable rights are the highest value." [1.1]

The current task is to take care of people, to bring up and bring up the younger generation as a mature person, modern, educated, highly spiritual, strong-willed, strong-willed, caring person for the people and the Motherland.

The analysis of the history of music and aesthetic education in our country shows that although the Uzbek music education has been collected, recorded, published, as a result of the lack of national education, these invaluable resources have been left out of the educational system. The performance of vocal, choir, opera, ballet, variety, symphony orchestras, which emerged as a result of the influence of European music, developed in the main direction. Naturally, scientific research on music and aesthetic education has also been largely in this direction. It should be noted that the research on the above-mentioned types of art is carried out in the field of art criticism, including Uzbek folk music, its genre features, melody structure, methods of development, ways of development, some of its types in the field of singing. Consistent research is certainly beneficial. However, it can be acknowledged that new directions in the field of aesthetic education have not been studied in relation to the higher education system.

This article is devoted to the results of research on the development of pedagogical bases for the development of personal qualities of creative people through music and the creation of science-based methodical recommendations, the solution of the following tasks is relevant today:

1. Theoretical and practical study and generalization of the current state of development of personal qualities of creative people through music.
2. Development of the content, methods, forms and means of aesthetic education through the development of personal qualities of creative people through music.
3. Development of methodical recommendations on improving the development of personal qualities of creative people through music.

Pedagogical experiments conducted to observe changes in students' attitudes to the art of folk singing - the results of sociological research, questionnaires, questions and answers:

- the lack of theoretical analysis of the development of personal qualities of creative people on the example of the art of music;
- the practical aspects of the development of personal qualities of creative people have not been studied in the example of music;
- showed that the forms of education through music in the formation of creative individuals are not socio-historically covered in the context of traditional and modern art education.

During the study, the content and methods of music and aesthetic education, improving the involvement of students in spiritual and aesthetic values, improving the existing curriculum, texts of lectures, teaching and methodological manuals, enriching their national foundations. However:

- theoretical analysis of the development of personal qualities of creative people on the example of the art of music;
- to study the practical aspects of the development of personal qualities of creative people on the example of music;
- in the formation of creative personalities, attempts were made to socio-historically cover the forms of education through music in the context of traditional and modern art education.

Improving the content and methods of music and aesthetic education conducted at the institute, ensures the involvement of students in spiritual and aesthetic values, improves the existing program of music education, texts of lectures, teaching and methodological manuals, creates a methodological basis for enriching their national basis.

At present, the widespread use of pedagogical innovations in the educational process is a global trend of global development. Particular attention is paid to the systematic introduction of innovations in the field of education at a time when the scale of pedagogical innovations is growing, the process of modernization in the country is developing rapidly. However, despite the creation of many pedagogical innovations, the level of introduction of pedagogical research on the introduction of new content, forms, methods and tools of teaching in the educational process is not yet sufficient.

Indeed, in the implementation of the updated education system, it is important that every teacher has the ability to constantly study the innovations in their subject and the education of a harmoniously developed generation and apply them consistently in their work. The content, form and methods of developing the personal qualities of creative people through music education is a pedagogical system organized in this direction in the higher school of arts and pedagogy and the implementation of spiritual aesthetic education. The effectiveness of this system is fully reflected in the results of pedagogical research. As music education is an educational tool of the pedagogical system we have chosen and operated, its content has been proved in the samples selected from the treasury of music education.

While pursuing the goals of spiritual and aesthetic education, we have chosen songs on a variety of popular topics that have as much educational impact as possible to achieve that goal.

The development of students' personal qualities is carried out mainly in the classroom. Thinking can only be developed if the learning process is designed to teach students exactly how to think creatively.

During the research, pedagogical methods of developing logical thinking in scientific creativity, practical and methodological recommendations and conclusions on the use of scientific creativity and logical thinking in the formation of creative individuals in music education were developed. Logical thinking and reading give good results only if students understand the diversity of ideas and experiences.

During the study, it was found that the level of use of folk music, especially music education, in the aesthetic education of students in art and pedagogical universities is unsatisfactory. This is due to: a) the lack of purposeful programs and manuals of the leaders of clubs and teachers-educators engaged in aesthetic education in higher education institutions; b) examples of music education that can have a positive effect on aesthetic education and general information about music education (song genre, authors, content, style of performance, performers, which local style of performance it belongs to, in what condition it is performed, music, etc. ) lack of resources; c) lack of popularization of existing practices in the field of aesthetic education in music education; g) the absence of national musical instruments, technical means, visual and musical notes, which would increase the effectiveness of the training and allow to achieve positive results.

[4.76]

In short, Uzbekistan has set key tasks in reforming the education system in order to strengthen its independence and become one of the developed countries. One of them is to form a new generation of young people who have the ability to advance and solve future tasks, a high culture of thinking, the ability to find an independent path in political and socio-economic life.

Effective lifelong learning applied to new situations poses a problem for us to make information and ideas understandable. The highest result can be achieved only when students actively assimilate information and ideas, that is, they become mature professionals in all respects.

In order for young people to become mature professionals in their field, it is necessary to develop their logical thinking. To do this, in the pedagogical process, it is advisable to organize training sessions that allow students to think logically.

The learning process will be more successful only if different strategies for developing the personal qualities of creative individuals are used. Such strategies make the reading process more conscious.

Only when students can apply their knowledge in solving certain problems will they develop knowledge and logical thinking.

Reading based on students' previous knowledge and experience will be solid. All of this allows students to connect new information with what they know.

#### REFERENCES:

1. Ўзбекистон Республикаси Конституцияси. –Тошкент:Ўзбекистон.2003.5 –Б.
2. Ўзбекистон Республикаси Президентининг 2008 йил 8 июлдаги “Болалар мусиқа ва санъат мактабларининг моддий-техник базасини мустаҳкамлаш ва уларнинг фаолиятини янада яхшилаш бўйича 2009-2014 йилларга мўлжалланган давлат дастури тўғрисида”ги ПҚ-910-сон Қарори.
3. “Болалар мусиқа ва санъат мактабларининг моддий-техник базасини мустаҳкамлаш ва уларнинг фаолиятини янада яхшилаш бўйича 2009-2014 йилларга мўлжалланган давлат дастури тўғрисида”ги ПҚ-910-сон Қарори. 2008 йил 8 июл.
4. “Ягонасан, муқаддас Ватан!” Республика кўрик-танловини ўтказиш тўғрисида”ги ПҚ-1091-сон Қарори. 2009 йил 7 апрел.
5. “Ўзбекистон давлат санъат ва маданият институтини ташкил этиш тўғрисида”ги ПҚ-1771-сон Қарори. 2012 йил 4 июн.
6. Ўзбекистон Республикаси Вазирлар Маҳкамасининг 1997 йил 11 мартдаги “Шарқ тароналари” халқаро мусиқа фестивалини ўтказиш тўғрисида”ги 132-сон қарори.
7. Ўзбекистон Республикаси Президенти Ш.Мирзиёвнинг“2017-2021 йилларда Ўзбекистон Республикасини ривожлантиришнинг бешта устувор йўналиши бўйича Ҳаракатлар стратегиясини амалга оширишга доир ташкилий чора-тадбирлар тўғрисида”ги Ф-4849-сон Фармойиши. 2017 йил 14феврал.
8. Ўзбекистон Республикаси Президенти Ш.М.Мирзиёев иштирокида “Таълим тизимини ривожлантириш, педагогларнинг малакасини ва жамиятдаги нуфузини ошириш, ёш авлод маънавиятини юксалтириш” 2019 йил 23 август.
9. Акбаров И.Узбекский музыкальный фольклор.Тошкент: Уздавнашр.1974-114 с.

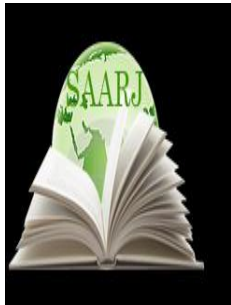

**ACADEMICIA**  
**An International**  
**Multidisciplinary**  
**Research Journal**  
 (Double Blind Refereed & Peer Reviewed Journal)



DOI: **10.5958/2249-7137.2021.01334.3**

**ORGANIZATIONAL COMMITMENT AS MEDIATOR OF THE  
 RELATIONSHIP BETWEEN JOB SATISFACTION AND  
 PERFORMANCE IN THE COMMERCIAL BANKS IN SRI LANKA- A  
 STUDY**

**Sampath Kappagoda\***

\* PhD Scholar, Senior Lecturer,  
 Department of Business Management,  
 Faculty of Management Studies, Rajarata University of SRI LANKA  
 Email id: sampathkappagoda@yahoo.com

**ABSTRACT**

*The purpose of this study was to investigate the relationship among job satisfaction, organizational commitment and job performance of non - managerial employees in the commercial banks in Sri Lanka. The sample consisted of 400 non - managerial employees randomly selected from Systemically Important Banks. A questionnaire was administered among the non - managerial employees as the measuring instrument. The collected data were analyzed using correlation coefficient and simple regression. The results of the study indicated that there was a positive relationship between job satisfaction and job performance, job satisfaction and organizational commitment, organizational commitment and job performance. Organizational commitment was found to mediate the relationship between job satisfaction and job performance of non-managerial employees in the commercial banks in Sri Lanka.*

**KEYWORDS:** *Organizational Commitment, Job Satisfaction, Job Performance, Mediating Effect*

**INTRODUCTION**

The importance of human factor has not decreased because the human involvement is yet to be considered as a significant element in the banking sector. The quality of the staff has significant impact on the customer satisfaction and overall performance of the banking sector.

Job Performance (JP), Job Satisfaction (JS) and Organizational Commitment (OC) of the employees are the key factors in deciding the success or failure of any organization. Banking

being a service sector industry, these factors are further significant because the well satisfied, high committed and high performed employees are more crucial for the customer satisfaction and overall performance.

Gabbott and Hogg (1997) argue that employees' JP in particular is considered to be a key individual outcome in the financial and banking services context. In this context, bank employees play an important role in delivering high quality services, promoting the corporate image and improving customer satisfaction (Karatepe and Tekinkus, 2006). Thus, the enhancing the JP of the employees is the high priority of any manager. Lots of researchers and practitioners have focused their researches to find out the antecedents of JP. Among them, personality (Ones & Viswesvaran, 2001), job satisfaction (Iaffaldano & Muchinsky, 1985, Judge *et al.*, 2001), Organizational commitment (Baugh & Roberts, 1994; Meyer *et al.*, 1993), Job involvement (Brown, 1996; Robbins, 2003), work attitudes-organizational commitment and job involvement- (Blau, 1986), motivation (Moorhead and Griffin, 1999), organizational culture (Moorhead and Griffin, 1999), organizational structure (Robbins, 2003), leadership (Mullins, 1996) are the most investigated antecedents of JP. Among them, job satisfaction and organizational commitment are the most significant factors in determining the JP.

JS is a positive emotional response towards the various aspects of job resulting from what the employees want and value from their job (Olsen, 1993). It is closely associated with life satisfaction, job performance, Organizational Commitment, Job Involvement, physical and mental health, absenteeism, turnover, labour problem, labour grievances (Buitendach & De Witte, 2005). Among these different associations, the relationship between JS and job performance has fascinated researchers for decades and several theoretical explanations have been posited to explain this relationship (Schleicher, Watt, & Greguras, 2004). In turn, OC has received substantial attention in past research due to its significant impact on work outcomes. Some researchers point out that organization whose members have higher levels of commitment show higher performance, productivity and lower levels of absenteeism and tardiness. This implies that employees with a high level of commitment tend to take greater effort to perform and invest their resources in the organization.

In reviewing the literature, there exists a substantial amount of research on the relationship between JS and JP whereas a sizable literature has investigated the relationship between JS and OC and OC and JP. Anyway, the mediating effect of OC on the relationship between JS and JP has received little attention in previous researches. In Sri Lanka, there are few researches on the relationship between JS and JP but nothing can be found in the mediating effect of OC on the relationship between JS and JP in the commercial banks. Therefore, it seems that there is a research gap in the commercial banks in Sri Lanka.

### **Problem Statement**

In order to improve the JP of the employees, the managers have to identify the factors affecting to JP and their impact. In reviewing the literature, lots of researchers have identified different factors affecting to JP. Among them, JS and OC of the employees are identified as the most influential factors which shape the employees' JP. In turn, there are relationship between JS and OC and OC and JP. Anyway, there were no researches on the mediating effect of OC in the banking sector in Sri Lanka. Therefore, the problems addressed in this study are to investigate:



1. How and in what ways does JS and OC affect on JP of non - managerial Employees in the commercial banks in Sri Lanka?
2. Does OC mediate the relationship between JS and JP of non-managerial employees in the commercial banks in Sri Lanka?

### **Objectives of the Study**

1. To identify the relationship between JS and JP of non-managerial employees in the commercial banks
2. To investigate the impact of JS on OC of non-managerial employees in the commercial banks
3. To identify the relationship between OC and JP of non-managerial employees in the commercial banks
4. To identify whether the OC can be used as a mediating variable between JS and JP among the non-managerial employees in the commercial banks

### **LITERATURE REVIEW**

#### **Job Performance**

Traditionally, JP was evaluated in terms of the proficiency with which an individual carried out the tasks that were specified in their job description. It has been conceptualized in terms of the execution and completion of well-defined task as a one dimension (Borman & Motowidlo, 1993). According to Moorhead and Griffin (1999), JP is all of the total set of work related behaviors that the organization expects from the individuals to display. Motowidlo, Borman and Schmit (1997) define JP as behaviors or activities that are oriented towards the organization's goals and objectives. However, the changing nature of work and organizations has challenged traditional views of JP. Today, JP is defined as a multidimensional construct.

The Task Performance (TP) and Contextual Performance (CP) have been received the most attention in the recent research (Borman and Motowidlo, 1993). According to Borman and Motowidlo (1993) the TP is the behavior that is directly linked with completion of the job. When employees use technical skills and knowledge to produce goods or services through the organization's core technical processes, or when they accomplished specialized tasks that support these core functions, they are engaging in TP. Task related behaviors contribute to the technical core of the organization. Furthermore, they explain TP including those aspects of a job that contribute directly to the technical object of the organization. These behaviors are predominantly task oriented and are included in formal job descriptions and may represent a key performance indicator. Behaviour in the domain of TP is usually recognized as a formal requirement of an individual's job. Job description often explicitly stipulates that the job holders must perform these activities. According to another conceptualization on TP refers to activities that are formally part of a worker's job. These activities are two types. The first type includes activities that contribute directly to the "technical core" of the organization and the second type includes activities that support the technical core. TP involves all behaviors that are directly relevant to main job functions and in short, is the proficiency of activities that formally are recognized as part of workers "job" (Borman and Motowidlo, 1993).

Borman and Motowidlo (1993) define CP as an individual's performance, which maintain and enhances an organization's social network and the psychological climate that supports technical tasks. CP is comprised of interpersonal behaviors or actions that benefit the organization. Furthermore, they explained that CP includes activities that may not represent formal work tasks although they still make an important contribution to the effectiveness of an organization. This type of performance is often not written in a job description but it is considered to be an important component of JP. CP is behavior that contributes to the culture and climate of the organization. It is the context within which transformation and maintenance activities are carried out. CP consist the behavior of volunteering for extra work, persisting with enthusiasm, helping and cooperating with others, following rules and procedures and supporting or defending the organization (Motowidlo and Schmit, 1999). Borman&Motowidlo (1993), define CP as behaviors that shape the organizational, social and psychological context that serve as catalyst for task activities and processes.

### **Job Satisfaction**

According to the literature, there are various conceptualizations of JS. Most researchers conceptualize it as cognitive, affective and evaluative reactions. Locke (1976) defines JS as a pleasurable or positive emotional states resulting from the appraisal of one's job or job experience. JS is a result of employee's perception of how well their job provides those things that are viewed as important. According to Henne and Locke (1985), JS is an emotional response to a value judgment by an individual worker. If his job values are perceived as being fulfilled, he will experience the pleasurable emotions of satisfaction; if they are perceived as being frustrated, he will experience the unpleasurable emotion of dissatisfaction. The intensity of these emotional reactions will depend on the importance of the values whose fulfillment is being facilitated or frustrated by the work experience.

Some researchers define JS in terms of feeling, attitudes and beliefs. Robbins (2000) defines JS as a subjective measure of worker attitudes, that is, an individual's general attitudes to his or her job. A person with high JS holds positive attitudes towards the job and one who is dissatisfied with, has negative attitudes toward it. George and Jones (1996) define it as "the collection of feeling and beliefs that people have about their current jobs. Ivancevich and Mattson (2005) defines JS as an attitude that individuals have towards their jobs which stems from their perception of their jobs and the degree to which there is a good fit between the individual and the organization.

### **Organizational Commitment**

OC researchers can be divided into two major camps, those who view OC as an attitude and those who view it as behaviors (Meyer and Allen, 1991). They regard attitudinal commitment as the way people feel and think about their organizations. That is the employee attitude that reflects the nature and quality of the linkage between an employee and an organization. Behavioral commitment reflects the way individual have become locked into the organizations.

According to Poter et al., (1984) an attitudinal perspective refers to the psychological attachment or Affective Commitment (AC) formed by an employee in relation to his identification and involvement with the respective organization. They further explain this as "an attachment to the

organization, characterized by intention to remain in it, identification with the values and goals of the organization, and a willingness to exert extra effort on its behalf.” It is considered to be the linkage between the individual employee and the organization because of individuals consider the extent to which their own values and goals related to that of the organization as part of OC.

Behavioral perspectives of OC is explained under the side bet theory (Becker, 1960) Side bets theory refers to the accumulation of investments valued by the individual which would be lost if she or he were to leave the organization (Becker, 1960). According to this theory individuals are committed to the organization as far as they hold their positions, irrespective of the stressful condition they experience. However, if they have been given alternative benefits, they will not to leave the organization. Mowday, Poter and Steers (1982) support the Becker’s view and describe OC as a behavior relating to the process by which individuals become locked in to a certain organization.

Mayer and Allen (1990) viewed OC as multidimensional concept. They proposed a Three-Component Model, including: Affective Commitment (AC), continuance commitment (CC), and normative commitment (NC). AC refers to the employee’s emotional attachment to, identification with, and involvement in the organization. CC refers to commitment based on the costs that the employee associates with leaving the organization due to the high cost of leaving. NC refers to an employee’s feeling of obligation to remain with the organization based on the employee having internalized the values and goals of the organization.

### **Job Satisfaction, Organizational Commitment and Job Performance**

Previous research has devoted a great deal of attention to the relationship between JS and JP. Locke (1970) ,Jaffaldano&Muchinsky (1985), Abedel-Halim (1980), Parasuraman and Futrell (1983) ,Rao (2000), Judge et al., (2001) , Sullivan and Bhaget (1992), Petty, McGee &Cavender (1984). Many studies revealed strong correlations between JS and OC. Poter& Steers (1973),Chen(2007),Clark & Larkin(1992),Mathieu and Zajac, (1990),Mathieu and Hamel (1989),Benkhoff (1997),Price and Mueller (1981),Iverson and Roy (1994),Yousef (2000),Samad (2005),Taunton et al.,(1989),Williams and Hazer (1986).Previous research have studied the relationship between OC and JP and found positive relationship.Riketta (2002), Matheiu&Zajac (1990), Baugh and Roberts(1994),Meyer & Allen ( 1997) ,Randall (1990), Rao (2000), Mowday et al., (1982), Mitchell & Larson (1987), Keller (1997), Brett et al., (1995),Ward and Davis (1995).Based on these empirical evidences, the following hypotheses are formulated.

H1: There is a positive relationship between JS and JP of non-managerial employees in the commercial banks.

H2: There is a positive relationship between JS and OC of non-managerial employees in the commercial banks.

H3:There is a positive relationship between OC and JP of non-managerial employees in the commercial banks.

H4: OC mediates the relationship between JS and JP of non-managerial employees in the commercial banks.

## **RESEARCH METHODOLOGY**

### **The research design**

The current study employed a correlational research design in order to explore the relationship between non-managerial employees' JS (independent variable) and non - managerial employees' JP (dependent variable). OC is the mediating variable. This field study is conducted in natural environment in banking sector under non-contrived settings. The unit of study is individual.

### **Population and Sample**

The population of this study is all the permanent non - managerial employees who work in Systemically Important Banks (highly performed commercial banks) in Sri Lanka. The sample for this study was randomly selected 400 non - managerial employees employed in Systemically Important Banks.

### **The sampling method**

Firstly, The Systemically Important Banks (SIBs) - Bank of Ceylon, Peoples Bank, Commercial Bank, Hatton National Bank, Sampath Bank and Seylan Bank- were selected. The convenient sampling method is used to select the branches of the bank which was situated in Colombo, Kurunegala and Anuradhapura. Then, with the consultation of the branch manager, four permanent non-managerial employees were selected in random basis.

### **Measures**

Non - managerial employees' JP was the dependent variable and JS of the non-managerial employees is the independent variable of this research. OC of non-managerial employees is the mediating variable. These variables were measured using a questionnaire which was originally developed by the researcher. The questionnaire was separated into three sections for demographic data, work related attitudes (JS & OC) and JP. Six questions were included to get the demographic information. The JP was measured including 19 questions under two dimensions (Task performance and Contextual performance). Under the work related attitudes, the level of JS and OC of the non - managerial employees in the banking sector were tested. 16 questions were used to measure the JS under six dimensions (Work itself, pay, promotion, supervision, coworkers and working condition). Nine questions were included to test the OC of the non-managerial employees under two dimensions (Willingness to display effort and Desire to belong to the organization). The total questions were 50.

### **Validity and Reliability**

The questionnaire which was prepared for non-managerial employees consists of 03 instruments (JS, OC and JP). All these instruments have been developed after correctly identifying the relevant dimensions and indicators. Therefore, it can be assured that the instrument has content validity. In developing OC instrument, Affective OC Scale, which was created by Meyer, Allen and Smith (1993), OC questionnaire, created by Meyer, Allen (1997) were considered. When developing JP questionnaire, Motowidlo and Van Scotter's (1994) 15 items scale of OCB and Task and Overall performance scale of Borman, and Ackerman (1994) were considered.

**TABLE 01 - ALPHA VALUE FOR TEST RETESTS RELIABILITY**

Variables	Alpha value
Job Performance	0.87
Job Satisfaction	0.90
Organizational Commitment	0.74

It can be concluded that the instruments possesses high test retest reliability as there is a significant high correlation between the responses of the two administrations.

The table 02 shows the Cronbach coefficient alpha for each instrument. According to the data, each item is correlated with other item across the entire sample and the internal consistency reliability is satisfactory.

**TABLE 02 - CRONBACH COEFFICIENT ALPHA VALUE FOR INTERNAL CONSISTENCY**

Variables	Alpha value –range
Job Performance	0.91
Job Satisfaction	0.90
Organizational Commitment	0.73

### Methods of data analysis

The data analysis included univariate, bivariate and multivariate analyses. Collected data were analyzed using the SPSS data analysis package.

### Results

The results of the univariate data are given in table 03. According to the data, the level of JS is in high level among the non-managerial employees who work in banking sector. The JP and OC are at moderate level.

**TABLE 03- THE RESULTS OF UNIVARIATE ANALYSIS**

	Mean	Std. Deviation
Job Satisfaction	3.50	0.57
Organizational Commitment	3.01	0.52
Job Performance	3.00	0.39

**TABLE 04- CORRELATION COEFFICIENT BETWEEN INDEPENDENT AND DEPENDENT VARIABLES**

Variables	1	2	3
1. Job Satisfaction	-		
2. Organizational Commitment	0.32(**)	-	
3. Job Performance	0.31(**)	0.67(**)	-

\*\* Correlation is significant at the 0.01 level.

**TABLE 05 - RESULTS OF SIMPLE REGRESSION ANALYSIS**

	<b>JS &amp; JP</b>	<b>OC &amp; JP</b>	<b>JS &amp; OC</b>
R Square	0.134	0.381	0.057
Adjusted R Square	0.131	0.379	0.055
F Value	15.913	155.52	24.15
Significance	0.00	0.00	0.00
$\beta$	0.127	0.398	0.220

Table 05 presents the results of the regression analysis. According to the table, JS and OC have significantly and positively correlated to JP whereas JS has also significantly and positively correlated to OC.

**TABLE 06- REGRESSION ANALYSIS OF ORGANIZATIONAL COMMITMENT MEDIATING JOB SATISFACTION-JOB PERFORMANCE RELATIONSHIP**

	<b>Step 01</b>	<b>Step 02</b>
Job Satisfaction $\beta$	0.127(**)	0.042
Organizational Commitment $\beta$	-	0.387(**)
R	0.184	0.533
R <sup>2</sup>	0.034	0.284
F value	13.91	139.05

\*\* Correlation is significant at the 0.01 level.

According to the results of table 06, the introduction of OC in the analysis reduces the impact of JS. The  $\beta$  has dropped from 0.13 ( $P < 0.01$ ) in step 01 to 0.04 in step 02. OC remains a significant predictor in the last analysis. ( $\beta = 0.39, P < 0.01$ )

## DISCUSSION

The objectives of this study were to investigate the mediating effect of OC on the relationship between JS and JP of the non-managerial employees in the commercial banks in Sri Lanka and to identify the relationships of JS and JP, JS and OC, OC and JP of the non-managerial employees in the commercial banks in Sri Lanka. For this purpose, four hypotheses were formulated.

By considering the hypothesis one, the results of correlation coefficient and regression analysis indicated that JS of the non-managerial employees has positively and significantly correlated to their JP. The second hypothesis was that there was a positive relationship between JS and OC. It was confirmed that the relationship between JS and OC of non-managerial employees in the commercial banks has significantly and positively correlated. There is statistical evidence to accept the third hypothesis which was formulated in this study. The OC of the non-managerial employees has significantly and positively correlated to JP. It was the strongest correlation among the variables. It has significantly explained 38.1 % of the variance in job performance. Furthermore, the researcher formulated a hypothesis to investigate the mediating effect of OC on the relationship between JS and JP. For this purpose, the three steps which were recommended by Baron and Kenny in 1986 were used. According to these authors, the first, the mediator

should be predicted by the independent variable. Table 05 already showed that OC can be predicted by the JS. The Second, the dependent variable should be predicted by the mediator and the independent variable. The results in table 05 showed that JP can be predicted by JS and OC. The data suggested that there is an evidence for the first and second steps of Baron and Kenny's procedure. Last, the dependent variable should be regressed on the independent variable, controlling for the mediator. According to the results of table 06, the introduction of OC in the analysis reduces the impact of JS .The  $\beta$  has dropped from 0.13 ( $P < 0.01$ ) in step 01 to 0.04 in step 02. OC remains a significant predictor in the last analysis. ( $\beta = 0.39, P < 0.01$ ). Therefore, according to Baron and Kenny (1986), it can be assumed that there is a full mediation in this case. Thus, the final hypothesis can be accepted.

## CONCLUSION

Based on the results of the study, it can be concluded that there is a full mediating effect of OC of the non-managerial employees on the relationship between JS and JP of the non-managerial employees. In addition to that, the correlation between OC and JP is stronger than the correlations between JS and JP, JS and OC. Therefore, the strategists in the banking sector have to consider this scenario when they are formulating strategies regarding their human capital.

## REFERENCES

1. Abedel-Halim, A. A. (1980). Effects of higher order need strength on the job performance jobsatisfaction relationship, *Personnel Psychology*, 33, 335 - 347.
2. Allen, N. J., & Meyer, J.P. (1990).The measurements and antecedent of affective, continuance and normative commitment to the organization. *Journal of Occupational Psychology*,63, 1-18
3. Baron, R.M. & Kenny, D.A. (1986). The moderator- mediator variable distinction in social psychological research: Conceptual, strategic, and statistical considerations. *Journal of Personality and SocialPsychology*, 51(6), 1173-1182.
4. Baugh, S. G., & Roberts, R. M. (1994). Professional and organizational commitment among engineers: Conflicting or complementing? *IEEE Transactions of EngineeringManagement*, 41, 108-114.
5. Benkhoff,B. (1997a), Ignoring commitment is costly:new approaches established the missing link between commitment & performance.*Human Relations*,5(6),701-726
6. Blau, G.J. (1986). Job involvement and organizational commitment as interactive predictors of tardiness and absenteeism. *Journal of Management*, 12, 577-84.
7. Borman, W. C., &Motowidlo, S. J. (1993b). Expanding the criterion domain to include elements of contextual performance. In N. Schmitt, W. C. Borman, & Associates (Eds.), *Personnel selection in organizations*, 71-98. San Francisco, California: Jossey-Bass.
8. Brett, J.K., &Cron, W.L., & Slocum, J.W.In (1995). Ecomomic dependency on work: a moderator of the relationship between organizational commitment and job performance. *Academy of Management Journal*,38(1),261-271
9. Brown, S.P. (1996). A meta-analysis and review of organizational research on job involvement. *Psychological Bulletin*, 120 (2), 235-55.

10. Buitendach, J.H., & De Witte, H. (2005). Job insecurity, extrinsic and intrinsic job satisfaction and affective organisational commitment of maintenance workers in a parastatal. *South African Journal of Business Management*, 36(2), 27-37.
11. Chen, Y.J. (2007). Relationships among service orientation, job satisfaction, and organizational commitment in the international tourist hotel industry, *Journal of American Academy of Business*, 11 (2), 71-82
12. Clark, C.E., & Larkin, J.M. (1992). Internal Auditors: Job Satisfaction and professional commitment. *Internal Auditing*, 8(1), 9-17
13. Gabbott, M. and Hogg, G. (1997). *Contemporary Services Marketing Management*, The Dryden Press, UK.
14. George, Jennifer M., & Jones, Careth R. (1996). *Understanding and Managing Organizational Behavior* (2nd ed.). Addison-Wesley Publications Company, Inc. 66-67
15. Henne, D., and Locke, E. A. (1985). *International Journal of Psychology*. 20, 221-240. Elsevier Science Publishers B.V. North Holland.
16. Iaffaldano, M.T. and Muchinsky, P.M. (1985). Job satisfaction and job performance: a meta-analysis", *Psychological Bulletin*, Vol. 97, pp. 251-73.
17. Ivancevich, J. M., Matteson, M. T., & Richards, E. P. (1985). Who's liable for stress at work? *Harvard Business Review*, 63, 60-72.
18. Iverson, R.D. and Roy, P. (1994). A causal model of behavioural commitment: evidence from a study of Australian blue-collar employees, *Journal of Management*, 20(1), 15-41.
19. Judge, T. A., Thoresen, C. J., Bono, J. E., and Patton, G. K. (2001). The job satisfaction job performance relationship: A qualitative and quantitative review, *Psychological Bulletin*, 127, 376-407.
20. Karatepe O. M., and Tekinkus M. (2006). The effects of work-family conflict, emotional exhaustion, and intrinsic motivation on job outcomes of front-line employees, *International Journal of Bank Marketing*, 24(3), 173-193
21. Keller, R.T. (1997). Job Involvement and Organizational Commitment as longitudinal predictors of Job Performance: A study of Scientists & Engineers. *Journal of Applied Psychology*, 82(4), 539-545.
22. Locke, E.A. (1976). The nature and causes of job satisfaction, In M. D. Dunnette, *Handbook of industrial and organizational psychology*, Chicago: McNally.
23. Mathieu, J. and Hamel, D. (1989). A cause model of the antecedents of organizational commitment among professionals and non-professionals, *Journal of Vocational Behaviour*, 34, 299-317
24. Mathieu, J.E., & Zajac, D.M. (1990). A review and meta-analysis of the antecedents, correlates and consequences of organizational commitment. *Psychological Bulletin*, 108(2), 171-194.
25. Meyer, J.P., & Allen, N.J. (1991). A three-component conceptualization of organizational commitment. *Human Resource Management Review*, 1, 61-89.



26. Meyer, J.P. & Allen, N.J. (1997). *Commitment in the workplace: Theory, research and application*. Thousand Oaks: Sage
27. Meyer, J. P., Allen, N. J. & Smith, C. (1993). Commitment to organizations and occupations: Extension and test of a three component conceptualization, *Journal of Applied Psychology*, 87, 538-551
28. Mitchel, T.R., and Larson, J.R. (1987). *People in Organization*, Singapore: McGraw – Hill International Inc.
29. Moorhead, G. and Griffin, R.W. (1999), *Organizational Behaviour; Managing people and organizations*, 3rd ed, Mumbai: Jaico Publishing House.
30. Motowidlo, S. J., Borman, W. C., & Schmit, M. J. (1997). A theory of individual differences in task and contextual performance. *Human Performance*, 10, 71-83.
31. Mowday, R., Porter, L., & Steers, R. (1982), *Organizational Linkages: The Psychology of Commitment, Absenteeism, and Turnover*, Academic Press, New York, NY.
32. Motowidlo, S. J., & Schmit, M. J. (1999). *Performance assessment in unique jobs. The changing nature of performance*, 56-86. San Francisco: Jossey-Bass.
33. Motowidlo, S. J., & Van Scotter, J. R. (1994). Evidence that task performance should be distinguished from contextual performance. *Journal of Applied Psychology*, 79, 475-480.
34. Mullins, L. (1996). *Management and organization*. 4th ed. London: Pitman.
35. Olsen, D. (1993). Work satisfaction and Stress in the first and third years of academic appointments. *Journal of Higher Education*, 64, 453-471
36. Ones, D.S. & Viswesvaran, C. (2001). Integrity tests and other criterion-focused occupational personality scales (COPS) used in personnel selection. *International Journal of Selection and Assessment*, 9 (1/2), 31-39.
37. Parasuraman, A., Futrell M. C. (1983). Demographics, job satisfaction, and propensity to leave of industrial salesman. *Journal of Business Research*, 11, 33-48.
38. Petty, M.M., McGee, G.W., & Cavender, J.W. (1984), A meta-analysis of the relationships between individual job satisfaction and individual performance. *Academy of Management Review*, 9, 712-721
39. Porter, L., Steers, R., Mowday, R., & Boulian, P. (1974). Organizational commitment, job satisfaction, and turnover among psychiatric technicians. *Journal of Applied Psychology*, 59, 603–609.
40. Price, J. and Mueller, C. (1981). Professional Turnover: *The Case of Nurses*, Medical and Scientific Books, New York, NY.
41. Randall, D.M. (1990). The consequences of organizational commitments: methodological investigation. *Journal of Organizational Behavior*, 11, 361-78.
42. Rao, T.V. (2000). *HRD Audit, evaluating the human resource functions for business improvement*, New Delhi: Response book.

43. Riketta, M. (2002). Attitudinal organizational commitment and job performance: A meta-analysis. *Journal of Organizational Behavior*, 23, 257-266.
44. Robbins, S. P. (2003), *Organizational behavior*, 10th ed, New Delhi: Prentice – Hall of India Private Limited.
45. Samad, S. (2005). Unraveling the organizational commitment and job performance relationship: exploring the moderating effect of job satisfaction, *The Business Review*, 4 (2), 79-84.
46. Schleicher, D. J., Watt, J. D., & Greguras, G. J. (2004). Reexamining the job satisfaction-performance relationship: The complexity of attitudes. *Journal of Applied Psychology*, 89, 165–177.
47. Steers, R. M. (1975). Effects of need for achievement on the job performance-job attitude relationship, *Journal of Applied Psychology*, 60, 678-682
48. Sullivan, S.E. and Bhaget, R.S. (1992). Organizational stress, job satisfaction, and job performance: where do we go from here? *Journal of Management*, 18, 353 – 374.
49. Taunton, R., Krampitz, S. and Wood, C. (1989). Manager impact on retention of hospital staff Part 1, *Journal of Nursing Administration*, 19(3), 14-19.
50. Yousef, D. (2000). Organizational commitment: a mediator of the relationship of leadership behavior with job satisfaction and performance in a non-western country. *Journal of Managerial Psychology*, Vol. 15 No. 1, pp. 6-28.
51. Williams, L.J. and Hazer, J.T. (1986). Antecedents and consequences of satisfaction and commitment in turnover models: a re-analysis using latent variable structural equation methods, *Journal of Applied Psychology*, 71( 2), 219-31.

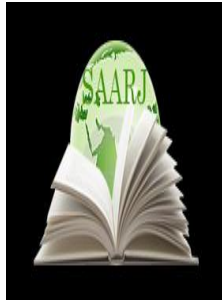

DOI: **10.5958/2249-7137.2021.01306.9**

**THE MECHANISM FOR INCREASING THE SOCIAL ENGAGEMENT OF STUDENTS IN THE PROCESS OF TEACHING ENGLISH (ON THE EXAMPLE OF THE PROCESS OF PREPARING FUTURE ECONOMISTS)**

**Pulatova Ziyoda Abdumalikovna\***

\*Senior Teacher of the “English language”,  
Department in Tashkent State University of Economics,  
UZBEKISTAN

**ABSTRACT**

*The increasing importance of English as an international language has resulted in the expansion of one particular aspect of English Language Teaching, namely the teaching of English for Specific Purposes. This relatively new aspect of English Language Teaching has its basis in an investigation of the purposes of the learners and the set of communicative needs arising from those purposes. Consequently, the aim of this study is to offer some immediately accessible guidelines into teaching English to students in Economics.*

**KEYWORDS:** *Learning Styles, Needs Analysis, Teaching English, Student Of Economics, Mechanism, Social Engagement.*

**INTRODUCTION**

English is the most-spoken language in the world. If you're reading this article, you may be one of the 379 million native English speakers, or one of the 753 million people who speak it as a second language and a lot of people know the language.<sup>1</sup> This indicates the amazing success of English as the lingua franca of economics, travel and worldwide relations. The relative ease with which English can be picked up (especially compared with Chinese) and the outstretched soft power of US culture means that English will proceed to dominate the world stage for the expected future.

When teaching English for economics, the connection between content, general vocabulary and specialized terminology is obvious. Therefore, finding interesting texts concerning the latest information in this field, meeting the challenging and changing needs and expectations of the learners, using eclectic teaching methods and techniques adapted to the students' learning strategies can lead to successful English classes.<sup>2</sup>

The best effects of teaching English language for future economists, especially by this book should be reflected in the personal development and professionalism of graduates, who will be competent with a good language command in the world market and science arenas. They will be active at learning news consistently, studying new forms of research, reading professional literature, writing specialized articles, making presentations, and leading research teams. Furthermore, it is important to mention that all measures and actions of organizing ESP (English for Specific Purposes) - courses are performed for developing students comprehension, thinking, dialoguing in English strategies and, of course, to reach the best levels of practicing owned knowledge and skills in their further specialized and research activities as modern specialists with independent English communication. Providing economic students with specific knowledge and skills, especially English for Economists will contribute to their further completion and make them professionally capable to work in possible fields.

Motivation is an important part of learning. Students, contrary to young learners who can study for the sake of a good grade or other indirect rewards, put forth sustained efforts for some other goals than the express enjoyment of the activity itself. Internal and external factors that promote learners' reasons for learning are challenges and promotions at work, claims for English literacy, overseas tasks and trips, workshops and conferences in English, welcoming foreign visitors, professional differentiation and specialization, e-communication. Besides, students have accurate, personality reasons for being in an economics course and learning English.

### **Learning styles**

Students may be grouped according to their preferred learning styles. Using multiple learning methods for learning is a comparatively new approach to teaching. Differences in cognitive styles impact learners' priorities for a separately approach to learning. Discipline styles are 'specific actions taken by the learner to make learning easier, faster, more enjoyable, more self-directed and more transferable to good positions.

The activities referred below are part of the methodology used for designing a lesson scheme based on the concept and term "crypto currency", and aimed at teaching business English. The objectives pursued by the teaching staff could be: teaching specialized vocabulary, developing students' reading, listening, speaking and listening skills through audio-visuals (video, online dictionaries, online learning platforms – if applicable, a variety of teaching resources provided by British Council. Teaching English - <https://www.teachingenglish.org.uk/resources/adult>

Introducing new vocabulary.

The teacher shows the students different kinds of currency (for example, bitcoin/Ripple/Ethereum) and provides their definition alternative to this technique could be the "flipped learning", a learner-centered approach, with topics explained in greater depth, with information conveyed before the English class. The website <https://www.incomeninjas.com> provides valuable information about this kind of digital money. The paragraphs can be used in very different ways, depending on the language skills considered by the teacher. The experience of planning and designing an appropriate course in English that suits students in Economics can be very challenging, as teachers are often faced with various complexities and problems. Traditionally, the first interpretation was widely used and accepted.

Training strategies in teaching English to students in Economics

One of the important goals in learning a foreign language is to develop the skill of listening comprehension. Listening activities often prove to be time-consuming. After listening to some passage, most of the students usually make complaints about all being too fast or different students recall the passage differently. Every individual student has his or her own specific purpose for learning Economics in English.<sup>3</sup> A needs analysis is an essential starting point in teaching students, as teachers cannot really address a student's specific needs unless they are absolutely clear about what they are. A successful English language course for students in Economics is one that is learner-centred and helps to meet the foreign language needs of the learners.

**In the Conclusion**, a method is a way of teaching. The choice of a method is dependent on the teacher's approach, namely what he/she believes about how people learn or how teaching helps people learn. Any teacher then has to make methodological decisions about the course aims, the teaching techniques, the type of activities, the methods of assessment. Despite the various methods that could be approached by language teachers, many of them nowadays do not follow one single method. Over the years, they develop a personal methodology, built from their own selection of what they consider to be the best and most appropriate of what they have learnt about. There are individual preferences regarding how students like to communicate and learn. A complete repertoire of teaching and learning approaches improves learning. Students who approach the learning process with a wide range of strategies have more options available for meeting expectations. It is obvious that well-known methods can be accompanied by new ones, which can get students motivated and interested in the subject, join peers to fulfill tasks, solve problems, contribute with ideas and their creativity, produce portfolios and, most importantly, enjoy learning business English in a comfortable, encouraging, stress-free environment. The mechanism for increasing the social engagement of economist's students in the process of teaching Learning English depends on their movement, interest and motivation. These methods are really useful for learning English economists students.

#### **LIST OF REFERENCE:**

1. <https://www.babbel.com/en/magazine/the-10-most-spoken-languages-in-the-world>
2. Lavinia Nadrag University of Economic Sciences Series "How to Teach English for Economics" pdf 2020-y
3. <https://www.economist.com/leaders/2019/02/23/the-perils-of-learning-in-english>
4. Annals of the „Constantin Brâncuși” University of Târgu Jiu, Economy Series, Issue 4/2014 pdf "Teaching English to students in economics"

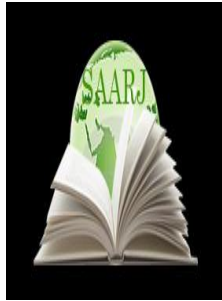

**ACADEMICIA**  
**An International  
 Multidisciplinary  
 Research Journal**  
 (Double Blind Refereed & Peer Reviewed Journal)



**DOI: 10.5958/2249-7137.2021.01318.5**

## SEARCH FOR REGULARITIES BY INTERVALS OF VALUES OF QUANTITATIVE FEATURES

**Shavkat Fayzullaevich Madrakhimov\*<sup>\*</sup>; Alisher Khasanovich Khurramov\*\*<sup>\*\*</sup>**

\*Associate Professor,  
 Doctor of Physical and Mathematical Sciences,  
 Head of the Department of “Algorithms and Programming Technologies”,  
 Faculty of Mathematics, National University of UZBEKISTAN  
 Email id: mshavkat@yandex.ru

\*\*Lecturer,  
 Department of Applied Mathematics,  
 Karshi State University, UZBEKISTAN  
 Email id: xurramov2009@yandex.ru

### ABSTRACT

*The problem of searching for hidden patterns in a sample of objects described by the initial and combined features is considered. The knowledge obtained on the basis of dividing the values of quantitative attributes into intervals is presented in the form of a set of fuzzy inference rules. The methodology of using these rules for decision making is described.*

**KEYWORDS:** *Hidden Patterns, Latent Features, Domination Intervals, Partition Stability, Fuzzy Inference Rules.*

### INTRODUCTION

Regularities are relationships (explicit and hidden) between properties (features) of objects. One of the ways to identify patterns is to divide the values of quantitative features into intervals and search for patterns by them [1, p. 19; 2, pp. 217-225].

In [3, p.310], a method is described for the preliminary analysis of training information, based on finding an informative zone in the training material (such sub-descriptions (or fragments of descriptions) are considered informative if they allow one to distinguish objects from different classes or distinguish a given object from all objects that do not belong to the same class. as considered) and typical for their classes of objects (the most representative).

---

## THE MAIN FINDINGS AND RESULTS

The search for informative zones is based on the use of the apparatus of discrete mathematics, in particular, Boolean algebra, the theory of disjunctive normal forms, the theory of coverings of Boolean and integer matrices. So, in the estimation algorithms developed by Y.I. Juravlev and his students, estimates of ensembles of features are found considered in [4, p. 916; 6, pp. 32-40], which are generalizations of the coefficients of information content.

It is possible to introduce taxonomy into the division of features into intervals - statistical methods for dividing features into equal or unequal intervals. The methods of partitioning into equal intervals include histograms, dicyclic partitioning and so forth. In [7, p. 447], the criterion for partitioning into intervals is based on the analysis of the probability distribution density.

In many procedures of statistical data analysis, the percentage distribution for a certain characteristic is used relative to another indicator. The distribution of the ordered characteristic values into intervals is made on the basis of certain criteria. For example, the Gini coefficient [8, p. 403] was originally defined as a statistical indicator of the degree of stratification of society in a given country or region in relation to any studied attribute. The value of the coefficient changes from 0 to 1. The closer this value is to zero, the more evenly the indicator is distributed.

Most often in modern economic calculations as in [9, pp. 67-70], the Gini index is used as an indicator of the discriminating ability of the classifier in solving the problem of classifying bank customers.

In [7, p. 447], an algorithm for extremal division of attribute values into gradations is presented. The principle that the algorithm implements is as follows: it is necessary to split the parameter values into a finite number of gradations so that the uncertainty (entropy) estimate when classifying using this feature is minimal (or close to minimal). At the beginning, the interval of values of the feature is divided into a sufficiently large number ( $\tau$ ) of gradations, and then by "gluing" adjacent gradations (thereby reducing the number of gradations  $\tau$ ) to achieve the minimization of entropy with respect to  $\tau$ . Then, among the remaining gradations  $\tau - 1$ , two adjacent ones are "glued together" in order to minimize entropy, and so on. The disadvantage of this algorithm is the absence of a criterion for constructing the boundaries of intervals, the initial partitioning is performed in an intuitive way and the final partition is locally optimal.

In [10, p. 33], the main problems of methods of searching for logical patterns in data were identified and analyzed. A common problem for traditional methods is the "first step" problem (feature segmentation). The well-known algorithms for finding *if-then* rules make a mistake at the very beginning of their work, using heuristic assumptions during segmentation to limit further enumeration. In the author's abstract of V. A. Dyuk's doctoral dissertation [10, p. 33], the thesis is substantiated that the first step in the operation of an algorithm claiming a "high result" should be the smallest possible (taking into account the available computing power) partition of the initial features into intervals.

In [11], it is proposed to search for informative regularities through the generation of a family of predicates by an arbitrary feature.

### Formulation of the problem

A sample of objects  $E = \{S_1, \dots, S_m\}$  is given that contains representatives of 2 disjoint classes  $K_1$  and  $K_2$ . The description of objects is made using a set of features of different types  $X(n) = (x_1, \dots, x_n)$ , of  $n$  diverse traits,  $\xi$  of which measured in interval scales,  $n - \xi$  – measured in nominal.

To search for patterns by sets of latent features in the description of sample objects, you need to perform the following action:

- the sequence of values of the initial and combined quantitative characteristics, in the description of classified objects of the sample, split into intervals;
- calculate the stability of the partitioning into intervals;
- Presentation of the revealed patterns by the intervals of partitioning of the initial and combined features in the form of fuzzy inference rules.

Latent (clearly unmeasured) features for describing the objects of the sample can be obtained through the use of linear arithmetic operations on the original quantitative features, or in the form of generalized estimates of objects for subsets of features [12, pp. 1-10].

Consider a variant of constructing latent features using arithmetic operations. The latent feature  $x^*$  is calculated as:

$$x^* = x_i \odot x_j,$$

where  $i \neq j, 1 \leq i, j \leq n, i, j \in I, \odot = \{*, / \}$ .

New knowledge on a latent feature is revealed when comparing its properties with respect to the original features from which it is synthesized.

**Division into intervals according to the criterion of dominance of class representatives.** A method is proposed for calculating disjoint intervals of quantitative features, within the boundaries of which the values of certain classes dominate [13, pp. 35-40; 15, p. 72].

Ordered set of values of a quantitative characteristic  $x_j$ :

$$r_j = r_{j_1}, \dots, r_{j_p}, \dots, r_{j_m} \quad (1)$$

According to the criterion defined below, an ordered sequence of the form (1) is divided into disjoint intervals  $[r_{c_u}, r_{c_v}]^i, 1 \leq u, u \leq v \leq m, i = \overline{1, \tau_c}$ .

$d_t^i(u, v)$  - number of class  $K_t$  representatives, in interval  $[r_{c_u}, r_{c_v}]^i$ . For the recursive procedure for selecting values  $r_{c_u}, r_{c_v}$  the criterion is used:



$$\left| \frac{d_1^i(u, v)}{|K_1|} - \frac{d_2^i(u, v)}{|K_2|} \right| \rightarrow \max. \quad (2)$$

Let's denote by  $\eta_{1i} = \frac{d_1^i(u, v)}{|K_1|}$ ,  $\eta_{2i} = \frac{d_2^i(u, v)}{|K_2|}$  results of optimal partitioning according to (3) for each interval  $[r_{c_u}, r_{c_v}]^i$ ,  $i = \overline{1, \tau_c}$ .

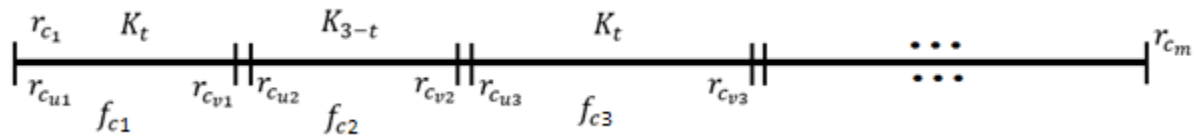

**Pic. 1. Splitting into intervals of dominance of the values of the  $c$  feature**

Dominance is quantitatively expressed through the  $f_{ci} \in (0.5, 1]$  class of  $K_l, l = 1, 2$  membership function. The value of the membership function of the  $c$  attribute to the  $K_1$  interval  $[r_{c_u}, r_{c_v}]^i$  is defined as:

$$f_{ci} = \frac{\eta_{1i}}{\eta_{1i} + \eta_{2i}}. \quad (3)$$

An additional alternative for ranking by  $K_l, l = 1, 2$  with an equal number of intervals is the stability of the feature values by the membership function, which is calculated as:

$$U(c) = \frac{1}{m} \sum_{\{[r_{c_u}, r_{c_v}]^i\}} \begin{cases} f_{ci}(v-u+1), & f_{ci} > 0.5, \\ (1-f_{ci})(v-u+1), & f_{ci} < 0.5, \end{cases} \quad (4)$$

expresses the degree of homogeneity (non-displacement) of the values of the  $c$  attribute of objects within the boundaries of the intervals of dominance determined by (2). If (ideally) the values of the attribute of one class lie within the boundaries of the intervals, then it is  $U(c) = 1$ .

### Computational experiment

For the experiment, a sample of "Echocardiogram" data from [16] was taken, describing the condition of patients who had a heart attack. The sample consists of 108 objects, of which 74 belong to the class (the patient died within 1 year), 34 to  $K_2$  (the patient survived or died after 1 year).

Each object is described by sets  $X(10) = (x_1, \dots, x_{10})$ , containing 8 quantitative features ( $x_1 = \langle \text{survival} \rangle$ ,  $x_2 = \langle \text{wall-motion-score} \rangle$ ,  $x_3 = \langle \text{eps} \rangle$ ,  $x_4 = \langle \text{age-at-heart-attack} \rangle$ ,  $x_5 = \langle \text{lvdd} \rangle$ ,  $x_6 = \langle \text{wall-motion-index} \rangle$ ,  $x_7 = \langle \text{fractional-shortening} \rangle$ ,  $x_8 = \langle \text{mult} \rangle$ ) and 2 nominal ( $x_9 = \langle \text{alive-at-1} \rangle$ ,  $x_{10} = \langle \text{pericardial-effusion} \rangle$ ).

Dividing into intervals of dominance of the values of quantitative features in the description of objects is a way to reveal hidden patterns. Table 1 shows the number of intervals of dominance of quantitative features and their boundaries for the sample.

**TABLE 1. CHARACTERISTICS OF THE INTERVALS OF DOMINANCE OF THE VALUES OF THE INITIAL QUANTITATIVE CHARACTERISTICS**

Attribute	Boundaries of intervals [u, v] by (3)	The value of the membership function (4)	Stability of the trait by intervals (5)
$x_1$	[0.25, 10]	0.05	0.86
	[12, 57]	0.82	
$x_2$	[7.5, 8]	0.13	0.69
	[9, 14.5]	0.68	
	[15, 39]	0.33	
$x_3$	[11, 40]	0.36	0.67
	[0, 10.3]	0.69	
$x_4$	[35, 64]	0.63	0.65
	[65, 86]	0.3	
$x_5$	[2.32, 2.32]	1	0.68
	[3, 3]	0	
	[3.1, 4.55]	0.72	
	[4.56, 6.73]	0.37	
	[6.74, 6.74]	1	
$x_6$	[1, 1.3]	0.71	0.7
	[1.31, 3]	0.31	
$x_7$	[0.01, 0.24]	0.37	0.7
	[0.25, 0.61]	0.81	
$x_8$	[0.28, 0.57]	0.28	0.68
	[0.59, 0.81]	0.6	
	[0.86, 0.93]	0.31	
	[0.93, 1]	0.87	

From Table 1, one can distinguish relatively strongly pronounced patterns in the belonging of objects to classes (in the particular case to  $K_1$ ), for signs  $x_1$  in the interval [12.57] with a

membership function value of 0.82 and  $x_7$  in the interval [0.25, 0.61] with a membership function value of 0.81 s stability of objects in the intervals of 0.86 and 0.7, respectively. If the boundaries of the intervals coincide (for example, as for  $x_2$  - [5.5, 5.5]), then objects with such a value require additional checking for anomalies.

**TABLE 2. INTERVALS OF DOMINANCE OF VALUES OF LATENT QUANTITATIVE FEATURES (FRAGMENT)**

Combination of signs	Boundaries of intervals [u, v] by (3)	The value of the membership function (4)	Stability of the trait by intervals (5)
$x_1 / x_4$	[0, 0.13]	0.02	0.85
	[0.15, 1]	0.83	
$x_4 / x_1$	[1, 6.6]	0.83	0.87
	[7.7, 344]	0	
$x_1 * x_8$	[0.18, 7.14]	0.02	0.87
	[8.12, 52.16]	0.83	
$x_1 * x_5$	[1.21, 42.3]	0.03	0.88
	[52.6, 280.9]	0.83	
$x_1 / x_5$	[0.05, 4]	0.13	0.84
	[4.07, 16.38]	0.93	
$x_5 / x_1$	[0.06, 0.25]	0.94	0.82
	[0.252, 20.8]	0.14	
$x_2 / x_7$	[21.31, 56]	0.77	0.64
	[60.53, 3900]	0.38	
$x_7 * x_8$	[0.01, 0.04]	0.28	0.64
	[0.05, 0.17]	0.68	
	[0.19, 0.35]	0.76	
	[0.38, 0.38]	0	
$x_7 / x_2$	[0, 0.02]	0.38	0.67
	[0.021, 0.05]	0.77	
$x_8 / x_7$	[3.49, 92.8]	0.38	0.56
	[0.94, 3.45]	0.67	

Table 2. A subset of combined (latent) features with high values according to the criterion of the type:

$$\frac{U(i)}{P(i)} \rightarrow \max,$$

where  $U(i)$  is the stability of objects in the intervals of dominance by the  $i$  attribute,  $P(i)$  is the number of intervals when dividing the  $i$  attribute.

In table 2 there are examples of combined features with both “improved” property indicators and “deteriorated” ones. For example,  $x_1$  in 2 intervals, had a stability of 0.86 and  $x_8$  in 3 intervals, had a stability of 0.65 when their combination of the form  $x_1 * x_8$ , the latent feature is divided into 2 intervals of dominance with object stability 0.87. On the other hand, the combination of features  $x_7$  with 2 intervals of dominance with a stability of 0.7 and  $x_8$  with 4 intervals of

dominance, with a stability of 0.68 with their combination of the form  $x7 * x8$  is divided into 4 intervals of dominance with a stability of 0.64.

The patterns revealed during the experiment (see Tables 1-2) can be described using fuzzy inference formalisms [17, pp. 338-353; 18] and linguistic variables. For example, according to the tables 1 and 2, it is possible to compose a set of fuzzy inference rules about the belonging of an object to a class of the form

*If A then B ('coefficient of confidence'),*

where 'coefficient of confidence' is the coefficient of confidence to the conclusion B if condition A.

Fragment of the list of rules for displaying table 1:

$P_{11}$ : *If  $x1 \in [0.25, 10]$  then  $S \in K_1 (0.05)$ ;*

$P_{12}$ : *If  $x1 \in [12, 57]$  then  $S \in K_1 (0.82)$ ;*

$P_{13}$ : *If  $x2 \in [7.5, 8]$  then  $S \in K_1 (0.13)$ ;*

$P_{14}$ : *If  $x2 \in [9, 14.5]$  then  $S \in K_1 (0.68)$ ;*

$P_{15}$ : *If  $x2 \in [15, 39]$  then  $S \in K_1 (0.33)$ ;*

$P_{16}$ : *If  $x3 \in [11, 40]$  then  $S \in K_1 (0.36)$ ;*

$P_{17}$ : *If  $x3 \in [0, 10.3]$  then  $S \in K_1 (0.69)$ ;*

...

Fragment of the list of inference rules according to Table 2:

$P_{21}$ : *If  $x1 / x4 \in [0, 0.13]$  then (0.02);*

$P_{22}$ : *If  $x1 / x4 \in [0.15, 1]$  then (0.83);*

$P_{23}$ : *If  $x1 * x8 \in [0.18, 7.14]$  then  $S \in K_1 (0.02)$ ;*

$P_{24}$ : *If  $x1 * x8 \in [8.12, 52.16]$  then  $S \in K_1 (0.83)$ ;*

$P_{25}$ : *If  $x7 / x2 \in [0, 0.02]$  then  $S \in K_1 (0.38)$ ;*

$P_{26}$ : *If  $x7 / x2 \in [0.021, 0.05]$  then  $S \in K_1 (0.77)$ ;*

You can use a measure of confidence of the form

$$M\mathcal{D}[h : e1, e2] = M\mathcal{D}[h : e1] + M\mathcal{D}[h : e2] (1 - M\mathcal{D}[h : e1]), \quad (6)$$

which is interpreted as “a measure of confidence in an event  $h$  with evidence  $e_1$  and equal to the measure of confidence in an event  $h$  with evidence added to a mixed measure  $e_2$  of confidence in an event  $h$  with evidence  $e_2$ ” [19]. This measure is used to assess the credibility of an event with an increase in the number of evidence. This can be demonstrated with the following example. If, in the process of inference, the sending of the rules  $P_{11}$  and  $P_{17}$  are executed (see the list above), then the measure of confidence in the event takes the form

$$M\mathcal{D}[\langle\langle S \in K_1 \rangle\rangle : x_1 \in [0.25, 10], x_3 \in [0, 10.3]] = M\mathcal{D}[\langle\langle S \in K_1 \rangle\rangle : x_1 \in [0.25, 10]] \\ + M\mathcal{D}[\langle\langle S \in K_1 \rangle\rangle : x_3 \in [0, 10.3]](1 - M\mathcal{D}[\langle\langle S \in K_1 \rangle\rangle : x_1 \in [0.25, 10]]).$$

Substituting the confidence coefficients from the rules, we get

$$M\mathcal{D}[\langle\langle S \in K_1 \rangle\rangle : x_1 \in [0.25, 10], x_3 \in [0, 10.3]] = 0.05 + 0.69 * (1 - 0.05) = 0.706.$$

If there are more than two evidences in favor of an event, the measure of confidence is computed in a cascade manner.

To interpret the results of inference in natural language, it is possible to assign a linguistic variable and a membership function to each feature [12, pp. 1-10; 13, pp. 35-40]. As an example, let us take the sign  $x_1$ , the value of which is the number of months that have passed since the patient has a heart attack. The linguistic variable for attribute  $x_1$  can be defined as follows:

$\beta_1$  – “Number of months after a heart attack”;  $T_1 = \{ \text{“Big enough”, “Very small”} \}$ ;  $X_1 = [0.25, 57]$ ;  $G_1 - \beta_1$  – expanded set of new values of the linguistic variable  $\{ \text{“Very small”, “Small”, “Normal”, “Good”, “Large”, “Large enough”} \}$  (see Table 6).

**TABLE 6. THE SET OF VALUES OF THE LINGUISTIC VARIABLE  $\beta_1$**

Survival interval by $x_1$ (survival)	$T_1 \cup G_1(T_1)$
[0,25..1)	<i>Very small</i>
[1..3)	<i>Small</i>
[3..7,5)	<i>Normal</i>
[7,5..12)	<i>Good</i>
[12..24)	<i>Large</i>
[24..57]	<i>Large enough</i>

The tabular form of setting the values of the linguistic variable and their membership functions  $f_c(i)$  to the  $K_1$  class presented in Table. 7.

**TABLE 7. TABULAR REPRESENTATION OF THE LINGUISTIC VARIABLE**

The value of the membership function $f_c(i)$	Linguistic variable values
[0..0,2)	<i>Practically absent</i>
[0,2..0,35)	<i>Small</i>
[0,35..0,5)	<i>Tangible</i>
[0,5..0,7)	<i>Sensitive</i>
[0,7..0,85)	<i>Strong</i>
[0,85..1]	<i>Very strong</i>

## CONCLUSION

A method is proposed for revealing hidden patterns from databases based on dividing feature values into non-intersecting intervals. The revealed knowledge on making decisions about the belonging of the sampled objects to the classes is presented in the form of a set of fuzzy inference rules. A method for calculating the membership function in fuzzy rules is described. A decision-making mechanism is proposed by calculating the confidence measure of an object's belonging to a class according to fuzzy inference rules.

A methodology for mapping the values of the membership function to the values of a linguistic variable is proposed for the purpose of interpreting knowledge.

Decision-making on the classification of an arbitrary admissible object can be made if it does not have measured values for some of the features.

## REFERENCES

1. Nikolaev A.B., Fominykh I.B. (2003). *Intelligent analysis and data processing*. Tutorial. - Moscow: MADI (STU), – p. 119.
2. Orlov A.I. (2012). *Measurement theory and methods of data analysis // Modern sociology of modern Russia*. Digestofarticles. Moscow: NRUHSE, – pp. 217-225
3. Juravlev Y.I., Gurevich I.B. (2000). *Pattern recognition and image analysis // Artificial Intelligence: Models and Methods*. T. 1. - Moscow: Radio and communication, –p. 310.
4. Juravlev Y.I. (1989) *On algebraic methods in problems of recognition and classification // Recognition, classification, forecasting. Mathematical methods and their application*. Moscow: Nauka., Issue 1. – pp. 9-16.
5. Juravlev Y.I. (1978). *On an algebraic approach to solving problems of recognition and classification // Problems of Cybernetics*. Mosciw: Science. – pp. 5-68
6. Krivenko M.P. (2016) *Significance criteria for selection of classification signs // Informatics and its application*, Vol 10, Issue 3, – pp. 32–40
7. Vapnik V.N. (1979). *Recovering dependencies from empirical data*. – Moscow: Nauka, –p. 447.

8. Ripley B.D. (2005). *Pattern Recognition and Neural networks* // Cambridge university press, – 403 p. (Ripley B.D. *Pattern Recognition and Neural networks*// Cambridge university press, 2005.-403 p.)
9. Shunina Y.S., Alekseeva V.A., Klyachkin V.N. (2015). *Performance criteria for classifiers*. - Bulletin of the Ulyanovsk State Technical University, No. 2 (70), – pp. 67–70.
10. Duke V. A. (2005). *Methodology of searching for logical patterns in the subject area with fuzzy systemology*: Author's Abstract of Doctoral Diss. Of Technical Sciences, St. Petersburg, – p. 33
11. Vorontsov K.V. Mathematical teaching methods by precedents (machine learning theory) Retrieved from: <http://www.ccas.ru/voron>
12. Ignatyev N.A., Madrakhimov Sh.F., Saidov D.Y. (2017). *Stability of object classes and selection of the latent features* // International journal of engineering technology and sciences, Malaysia, Vol. 7, – pp. 1–10. ( Ignatyev N.A., Madrakhimov Sh.F., Saidov D.Y.. *Stability of object classes and selection of the latent features* // International journal of engineering technology and sciences, 2017, Malaysia, Vol. 7, pp. 1-10.)
13. Ignatiev N. A., Saidov D. Y. (2014) *Computing the complexity of effective algorithms for choosing the optimal boundaries of intervals* // Problems of Informatics and Energy, - Tashkent, no. 6, – pp. 35–40.
14. Ignatiev N.A. (2011). *Calculation of generalized indicators and data mining* // Automation and tele-mechanics, No. 5, – pp. 183–190.
15. Ignatiev N.A. (2014) *Generalized estimates and local metrics of objects in data mining*. Monograph. - Tashkent: Publishing House “University”, – p. 72.
16. Retrieved from online source: <http://archive.ics.uci.edu/ml/machine-learning-databases/echocardiogram>
17. Zadeh, L. (1965). *Fuzzy sets. Information and Control*, 8 (3): pp. 338 – 353. (Zadeh, L. (1965). *Fuzzy sets. Information and Control*, 8(3):338 – 353.)
18. Shtovba S.D. *Introduction to the theory of fuzzy sets and fuzzy logic* / S. D. Shtovba. Retrieved from: <http://matlab.exponenta.ru/fuzzy-logic/book1/index.php>.
19. Buchanan, B. E. (1984). *Rule based Expert Systems: The MYCIN Experiments of the Stanford Heuristic Programming Project*. Addison-Wesley. (Buchanan, B. E. *Rule based Expert Systems: The MYCIN Experiments of the Stanford Heuristic Programming Project*. Addison-Wesley, 1984.)

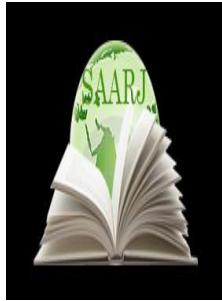

**ACADEMICIA**  
**An International**  
**Multidisciplinary**  
**Research Journal**  
(Double Blind Refereed & Peer Reviewed Journal)



DOI: **10.5958/2249-7137.2021.01319.7**

**STARTUPS: THE ESSENCE AND FEATURES OF FORMATION ON THE  
EXAMPLE OF FOREIGN EXPERIENCE**

**Shirin Shavkatkizi Achilova\***

\*Senior Teacher,  
Tashkent Institute of Finance,  
UZBEKISTAN

**ABSTRACT**

*This article examines the content, essence, role of startup projects in the development of an innovative economy. The study also analyzes the conditions for the formation and development of startup on the example of developed and developing countries. As the authors of the report note, the difference between the most innovative companies and the companies lagging behind in this aspect lies in the degree of activity of searching for developments from third parties. In other words, a startup is a business, but not every business can be recognized as a startup. A business, as a rule, uses a ready-made business model, receives loans for the implementation of an entrepreneurial idea with subsequent payment of interest.*

**KEYWORDS:** *Competition, Innovation, Startup, Investment, National Economy, Innovative Development, Ecosystem, Venture, Stages of Financing.*

**INTRODUCTION**

Modern realities of the development of the world economy are characterized by the fact that the country's competitive advantage is closely correlated with its innovativeness: knowledge reflected in innovative products or processes is today the main capital in society that contributes to economic growth and an increase in the country's living standards [1]. Building an innovation ecosystem is unthinkable without the development of innovative entrepreneurship in the form of start-ups - innovative companies with a short history of operating activities.

The term “startup”, which means “the beginning of the process” or “start”. Initially, this concept appeared in 1939 in Silicon Valley and is associated with the names of two graduates of Stanford University, who were the creators of a startup company - Hewlett-Packard, which later became a pioneer in information technology and solutions. Now the word “startup” is familiar to almost



every Internet entrepreneur who has decided to implement his grandiose business project [2, pp. 3946–3950].

In order to increase the competitiveness of the national economy of the Republic of Uzbekistan, the transition to an innovative way of development seems relevant; knowledge applied in innovative products or processes is today the main capital in society, contributing to economic growth, improving the quality of life of the country's population. One of the largest consulting agencies The Boston Consulting Group in 2020 published its 14th annual ranking of the most innovative companies, which is based on a survey of more than 1,500 CEOs from around the world; they are such technology companies as Apple, Google, Amazon, IBM, Microsoft, Samsung and others. As the authors of the report note, the difference between the most innovative companies and the companies lagging behind in this aspect lies in the degree of activity of searching for developments from third parties. Leading companies manage 65% of new ideas through social media and big data analytics, while inactive innovators only 14%. According to researchers, it is the ability to find and obtain technology from outside parties and competitors that plays a fundamental role in the implementation of innovations [3].

### **THE MAIN FINDINGS AND RESULTS**

The practice of the world's leading economies shows that one of the levers providing this process are startups - innovative companies with a short history of operating activities [4]. The term “startup”, which means “the beginning of the process” or “start”, was introduced by the creator of the client development methodology, American entrepreneur S. Blank, who defined them as “temporary structures that exist to search for reproducible [5] and scalable [6] business models” [7]. According to E. Rees, a startup is an organization “creating a new product or service under conditions of high uncertainty” [8].

According to venture capitalist P. Graham, the main characteristic of startups is their rapid growth (5-7% per week in terms of the key indicator) [9]. It should be noted that most of the startups in the world are represented in the field of intelligent IT technologies; in particular, such technology companies as Yahoo, Google, Facebook, Uber, Amazon, etc. have received their conceptual development within the framework of start-up projects. At the same time, the technological nature of the business or the small age does not make the company a startup [10]; frequent use of the concept in the context of technology companies characterizes the role of technology in ensuring sustainable growth, but does not imply technological character as a mandatory characteristic of a startup [11].

Thus, a startup is innovative, often informational projects, created with the expectation of their rapid growth and, as a result, high capitalization;

- The main function is to simplify any actions for users in their daily life; the main goal of creating a startup is to sell it to a large corporation or to list its shares on the stock exchange and continue working as a separate company. The work of Start-up Genome and Grow Advisors to systematize knowledge about startups deserves high praise.

According to Grow Advisors [12], the startup ecosystem consists of the following components: ideas, inventions, and research; startups at different stages of development; entrepreneurs, members of start-up groups; Angel investors; startup trainers; startup consultants; other people with entrepreneurial abilities; other organizations that carry out startup activities. It also lists the

organizations and organizational arrangements associated with startups: universities; consulting and coaching organizations; incubators for startups; startup accelerators; co-working centers; service providers (consulting, accounting, legal, etc.); event organizers; selection at startup; investor relations; venture capital enterprises; reverse portals; other sources of funding (loans, grants, etc.); startup blogs and other business-related media; other elements of the environment.

Startup Genome [13] has been analyzing global startup ecosystems for several years, as evidenced by the fact that 4 reports were released in 2012, 2015, 2017 and 2018, respectively. The organization's research is based on the Startup Ecosystem Index, which is used to sort out startup ecosystems. This index is made up of specific parameters and components. The Startup Ecosystems Index (SEI) in 2015 consisted of 8 components that covered trends in startups, finance, company performance, talent, support infrastructure, entrepreneurial potential, ecosystem trends and differentiation, as well as the 2017 SEI 5 report presented in the form of components - the result, funding, market success, talent, and startup experience. The 2018 report used groups of metrics such as the thinking ability of the founder, local communication, the founder's know-how, and demographics for the assessment.

Each report presents the top 20 startup ecosystems in the world, including Silicon Valley, Berlin, Beijing, Singapore and Bangalore. Of particular importance is Silicon Valley, which is the cradle of the startup phenomenon and the most developed startup ecosystem in the world.

Comparison of approaches to American and European startup ecosystems shows the following:

- In the US, a liberal approach to bankruptcy prevails, which, in turn, impedes the development of motivation for startups. In Europe, on the other hand, bankruptcies or setbacks mean business interruptions and loss of talent, so projects with a potential capitalization of more than \$ 1 billion over the next 5 years could fail;
- The procedure for investing in the US is simple, while in Europe conservative investors need many reasons;
- In the US, students are preparing for business by opening start-ups, while in Europe; young people prefer to work in large corporations;
- In addition, Europeans are more willing to invest in their area of residence, while Americans do not consider it a priority, and instead may invest in other parts of the country, even in Europe.

In Asia, start-up ecosystems are characterized by rapid growth, although high growth is observed a little later. The largest and most promising startup ecosystems are Yekaterinburg, Shanghai, Bangalore and Tokyo, as well as China, Singapore, India and Japan.

Features of Asian startup ecosystems include:

- Active participation of the state in financing start-ups;
- Low operating costs: low wages, low rents, low tax rates;
- An active role of the public and private sectors in the implementation of innovative developments;

The situation is almost the same or has characteristics similar to Latin American startup ecosystems.

However, it is necessary to note the difference between a startup and a small business: as a rule, ordinary firms are based on relative certainty and predictability. The future of the new startup, however, is very uncertain - the new idea must find its application and target audience. As the entrepreneur N. Blumenthal notes, "a startup is a company aimed at solving a problem when the solution is not obvious and success is not guaranteed." In other words, a startup is a business, but not every business can be recognized as a startup. A business, as a rule, uses a ready-made business model, receives loans for the implementation of an entrepreneurial idea with subsequent payment of interest. In this case, the founder / and the firms remain its owners.

In a startup, on the other hand, "investments are attracted through" rounds of funding, "and with each round the owner's share is diluted. Thus, it turns out that the owner pays for future super profits with his share "[14]. Thus, the concept of a startup incorporates the interests of three parties: a business initiator offering an original idea;

a venture investor whose goal is to multiply the profit from investments, as well as a consumer who is interested in extracting maximum utility from the consumption of goods and services.

The concept of a startup proposed by S. Blank was aimed at developing a client development model based on testing a prototype of a future product on potential consumers. It consists of four stages, during which a startup is transformed into a stable company [15]:

1. "Customer identification", during which a startup builds hypotheses about how its product solves the problems of potential customers
2. "Verification of consumers", the stage of hypothesis testing and preparation of a sales plan, marketing strategy, search for early adopters of the company. In case of failure at this stage, the startup returns to identifying its customers.
3. "Attracting consumers", after confirming the usefulness of the company's product, the startup moves on to product sales and marketing investments.
4. "Creation of a company" - the ultimate goal of a startup, the creation of a formal structure of the company and business processes for further development [16].

Exploring the international experience in the formation of sources of funding for startups, it is necessary to note several possible investors, in particular:

1. 3F / FFF (from the English words family, friends, fools - literally "family", "friends", "madmen"), who have no investment experience, but are ready to invest in original ideas; bootstrap startup means raising only your own funds for development
2. Business angels; private investors who invest relatively small funds in projects have competencies and connections [17]
3. Venture funds - risky investment companies focused on working with innovative enterprises and startups; they assess the possible success of the project and finance projects
4. Crowd funding is a method of collective financing; a way to raise funds for a project using special Internet sites. It is based on voluntary contributions, which implies the interaction of a crowd funding platform (an Internet site for announcing crowd funding projects and fundraising) and directly those who finance a project or idea - donors who can receive material or non-material rewards.

It should be noted here that “crowd funding is quite diverse. In addition to gratuitous support or project support for a nominal fee, there is, among other things, crowd-investing, which is focused on micro-investment in startups with further benefits from the future cash flows of this company. Also, crowd funding differs from venture investment in a fundamentally different structure of the transaction itself. In this case, crowd-investing platforms act as intermediaries between micro-investors and startups. Such an intermediary implements all internal venture investment processes - from project verification to closing a deal. For its role in this process, the platform receives a commission (as a rule, no more than 10% of the amount of the completed transaction). In addition, platforms often set a minimum threshold for a transaction. If the required amount is not collected, the money is returned to the investors”.

**TABLE 1 FUNDING MODEL FOR STARTUPS BY P. GRAHAM [18]**

<b>№</b>	<b>Financing stages</b>	<b>Content</b>
1.	Seed Investment (3F)	cover the expenses of the team for accommodation, development of a business plan and a prototype of a future product
2.	Angel investments (private investors)	A business angel who is part of the company's charter capital usually gets a seat on the board of directors and the ability to block decisions of the founders, which he considers unreasonable. At this stage, the startup gets the opportunity to expand its staff, finish work on the first version of the product, attract the first customers - "early adopters"
3	Round “A” / Venture Fund (further rounds can be expanded)	Attracting venture capital funds to a company with a workable product, clients and development plans. The amount of investment significantly exceeds the previous indicators, the startup begins to build a formal structure and expand
4.	Primary public offer, IPO - placement of the company's shares on the stock exchange	IPO is usually the main goal of a startup in the later stages of development.

At the same time, it should be noted that specialized conferences can be used as alternative ways to find investors. Several such conferences are held annually around the world. For example, a conference in StaryOskol - Startup Village, ClickZ Live New York (New York, USA), Pioneers 500 Festival (Vienna, Austria).

The well-known expert Mikhail Babich, having studied the life cycle of startups in foreign countries, claims that 97% of startups “die at the embryonic stage” without attracting investment, and only the remaining 3% find investors. At the same time, about 2% of them also “die”, because in addition to funding, these startups have acute problems with strategies for product formation and development, as well as problems with team work. Babich's analysis showed that the loss of investment when financing startups is 69%, with 30% of investments returning without return and only 1% making a profit. A startup financing system is considered effective if the profit from this 1% investment and the return on investment cover 69% of the lost investment [19, p. 176].

The international practice of start-up development shows that the main platforms for the development of start-up initiatives are universities, business schools, technology parks, grant programs and funds, business incubators and accelerators, etc. For example, the Massachusetts Institute of Technology (USA) has created on its basis the infrastructure of high-tech entrepreneurship. The aggregate gross product of companies created by students, graduates and teachers of the institute for 50 years is comparable to that of major world economies [20]. Silicon Valley, which has formed around Stanford University and the factories of large technology corporations, is a prime example of the world's leading startup ecosystem, where the largest major venture capital funds are concentrated. Israel, when considered in proportion to the total population, has the largest number of start-up companies in the world.

It is Israel, after the United States, that occupies a leading position in the world in terms of the number of companies opening (3,500 companies, most of which are engaged in the development, improvement and implementation of high technologies). However, Israel has the highest concentration of high-tech companies in the world, with the exception of the US Silicon Valley [21]. Under the auspices of the Government of the Republic of Uzbekistan, a resolution “On measures to further support innovative activities” No. 721 dated 09/11/2018 was adopted, the purpose of which is to provide financial and other assistance to startups; “The Fund for Support of Innovative Development and Innovative Ideas will provide grants based on self-sustaining projects for startups that are aimed at creating and commercializing domestic scientific developments. An innovative startup accelerator and a startup incubator have been created in the structure of the Center for Advanced Technologies under the Ministry of Innovative Development. Here, small high-tech companies on preferential terms will be provided with lease of laboratory equipment, production facilities and office space for a period of two years (in agreement with the Ministry of Innovative Development, the period can be extended to five years). In addition, residents of the Center for Advanced Technologies until January 1, 2022 are exempt from land tax, income tax, property tax of legal entities, a single tax payment, customs payments for raw materials and components imported for their own needs (except for customs clearance fees) [ 22].

According to statistics, unfortunately, about 70% of startups wind down their activities in their first year of operation. Among the remaining 30%, about forty do not live until the third year. The main reasons are systematized in the form of table 2.

**TABLE 2 THE MAIN REASONS FOR THE “FAILURE” OF START-UP PROJECTS**

[23, PP. 3946–3950]

Main reason	Failure percentage	Sub-reasons
Incompetence	51	-lack of knowledge on pricing; - tax evasion; - lack of planning; - ignorance of the economy; -lack of experience in accounting
Inconsistent experience or lack of managerial experience	35	-lack of experience in working with loans; -too fast expansion; - the wrong choice of "experience for borrowing"
Lack of experience in the	11	-wrong conduct inventory;

line of products and services		- ignorance of suppliers; -a waste of advertising budget
Fraud, disasters and more	3	-

Thus, summing up, we can say that for the creation of a startup project, the decisive factor is the generation of fundamentally new ideas that meet the needs of society at a given moment in time. Therefore, we believe that creativity and an unconventional look at many everyday things is the key to the success of your future enterprise.

To date, the Republic is implementing several large programs for subsidizing and providing grants to entrepreneurial projects, [24] in particular:

Yoshlar - kelajagimiz Foundation under the Youth Union (“Youth is our future”); is aimed at providing unemployed youth with work, supporting the implementation of youth business initiatives, start-ups, ideas and projects. The fund provides preferential loans and property through banks on lease at a rate of 7% per annum for the implementation of business ideas and startups. The Fund can: a) issue a guarantee for loans in the amount of 50% of the total amount (but not more than 1 billion soums); b) participate in projects by buying out 50% of the company's value with the condition of selling its share within five years. In 2018, the fund allocated 725 billion soums (about \$ 86 million) for the implementation of more than 6 thousand projects throughout the country.

- Fund for Support of Innovative Development and Innovative Ideas under the Ministry of Innovation. The state budget allocated 50 billion soums to the fund to support start-up projects, as well as innovative research and development projects. The fund's supervisory board includes 16 heads of ministries and departments. Any decision, including the allocation of funding, must be approved by each member of the board. In 2018, a competition for innovative, research, development and start-up projects was announced for the first time. Of the 170 start-up projects that applied for the competition, 16 were selected for funding. In 2019, the second cycle was announced; the amount of funding was up to 1.5 billion soums. The main condition is that the project should become self-sufficient in about two years.

- An intensive program to support the development of innovative ideas and start-up projects, designed for students, university staff, including teachers and researchers, the 5th cycle was announced in 2020. The program is divided into several stages. First, the participants study the basics of launching a project, and then move on to its direct implementation - they draw up a development roadmap, create a prototype and conduct test sales, these events are carried out with the appointment of mentors / consultants. In addition, master classes on marketing, taxation, legal aspects of doing business are held for the participants. They are carried out not only by local, but also by foreign experts. The Demo Day ends, where the teams present the results of their work to interested organizations and potential investors. So, starting in 2018, the project has allocated funds for prizes: five winners of the third cycle program won 40 million soums each; in 2019, five winners also received 50 million soums each for the development of their projects; for the winners of the fifth cycle of the program in 2020, a total prize amount of 2 billion soums was announced (40 projects of 50 million soums each). Today the program covers all regions of Uzbekistan.

## CONCLUSION

In summary, it should be noted that, given not only the socio-economic importance of start-up projects in the context of a structural shift in the direction of innovative and technological business, but also the importance of creating a favorable climate for venture capital and direct investments of the future, it is proposed to create:

- A unified strategy for the development of start-up projects in Uzbekistan, taking into account foreign experience;
- Startup accelerator in the Free Economic Zones, in particular, in the field of tourism, in the field of hotel and restaurant business;
- Business incubators at universities for creating startups in such areas as Internet and mobile banking, e-commerce, international logistics, advertising technologies, systems for processing and analyzing large amounts of information.

## REFERENCES

- [1] Kasimova N.J., Sharifkhodzhaev Sh.A. "Startups as a factor of innovative development of the economy". "Action strategy of the Republic of Uzbekistan: macroeconomic stability, investment activity and prospects for innovative development" collection of materials of the 3rd international online scientific and practical conference. 10-11 December. 2020.
- [2] Nazarenko V. A., Bochkova E. V. (2016). Startups: essence and main components of development // *Scientific-methodical electronic journal "Concept"*. – Tashkent: 11 – pp. 3946–3950. URL: <http://e-oncept.ru/2016/86828.htm>.
- [3] [https://forbes.kz//finances/markets/na\\_peredovoy\\_1599923733/?](https://forbes.kz//finances/markets/na_peredovoy_1599923733/?)
- [4] John Simpson and Edmund Weiner. (1989). *The Oxford English Dictionary*. — United Kingdom: Oxford University Press.
- [5] Reproducibility here is the ability to repeatedly sell the resulting solution.
- [6] Scalability - the possibility of significant project growth; for example, Snapchat has shot from zero to 100 million users in less than five years, <https://equity.today/startups.html>
- [7] <https://steveblank.com/2010/01/25/whats-a-startup-first-principles/>
- [8] Eric Ries. (2011) *The Lean Startup: How Today's Entrepreneurs Use Continuous Innovation to Create Radically Successful Businesses*. - New York: Crown Business.
- [9] <http://www.paulgraham.com/growth.html>
- [10] The idea of selling the equipment through the mail belongs to M. Dell, which made it possible to save significant funds on the maintenance of stores and establish his own company without large expenses; thus the firm "Dell" was created - a startup that entered the stage of the IPO.
- [11] <https://www.nkj.ru>
- [12] Startup Ecosystem Whitepaper. <http://www.startupcommons.org/download-startupecosystem-documentation.html>

- [13-14] RipEmpson. Startup Genome Ranks The World's Top Startup Ecosystems: Silicon Valley, Tel Aviv & L.A. Lead The Way. <https://techcrunch.com/2012/11/20/startup-genome-ranks-theworlds-top-startup-ecosystems-silicon-valley-tel-aviv-l-a-lead-the-way/>
- [15] Steve Blank. (2019)*Four Steps to Illumination*. Strategies for creating successful startups, Publisher Alpina Publisher
- [16] <https://cyberleninka.ru/article/n/chto-takoe-startapy-pochemu-k-nim-nablyudaetsyapovyshenny-interes/viewer>
- [17] Business angels are private investors, usually with entrepreneurial or managerial experience, who financially support a project at an early stage of development.
- [18] <http://www.paulgraham.com/growth.html>
- [19] Khamidullina E. Yu. (2018) *Promotion of innovative technologies: alternative projects and practices, Sociological Science and Social Practice*, No. 4 (24). – p. 176.
- [20] <https://tv.rbc.ru/archive/startup/5b7fab6f2ae5961fca0cdfc6>
- [21] Moshkin I. V. (2014). *Research of the processes of modern entrepreneurship*. – Moscow: Direct-Media.
- [22] Figovskiy O.L. (2014)*Israel's innovation system*. Management and business administration, No. 2. – p. 179.
- [23] Nazarenko V. A., Bochkova E. V. (2016) Startups: essence and main components of development // *Scientific-methodical electronic journal "Concept"* . – Tashkent.11. – pp. 3946–3950. – URL: <http://e-oncept.ru/2016/86828.htm>.
- [24] Khudaynazarov A. (2019). *State of the system of organizational support and financing of startups in the Republic of Uzbekistan: problems, their causes and solutions, Chamber of Commerce*.



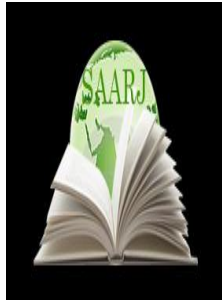

**ACADEMICIA**  
**An International**  
**Multidisciplinary**  
**Research Journal**  
 (Double Blind Refereed & Peer Reviewed Journal)



**DOI: 10.5958/2249-7137.2021.01320.3**

## GENDER CHARACTERISTICS OF UZBEK KIPCHAK DIALECTS

**Shoira Khushbokovna Islomova\***

\*Teacher,  
 Karshi Engineering and Economics Institute,  
 UZBEKISTAN

Email id: shoiraislomova3@gmail.com

### ABSTRACT

*This article focuses on the concept of gender, gender studies conducted in various scientific paradigms in linguistics, their goals and objectives. Also, the gender specificity of lexical units, in particular, the Kipchak dialect, which is one of the dialects, based on the Uzbek literary language, the causes and factors of the specificity of male and female speech, the meaning of expressions are analyzed on the example of dialectal expressions.*

**KEYWORDS:** *Linguistics, Gender, Language, Speech, Dialect, Phrase, Pragmatic Situation, Communication Culture, Speech Adaptation.*

### INTRODUCTION

The concept of gender refers to the psychological, social and cultural characteristics of men and women. In the course of the long evolution of mankind, these two opposite sexes have had their own commonalities and differences. As a result, a system of features that distinguishes and generalizes women and men has been formed. Gender refers to the identity of men and women and differences in behavior.

The concept of "gender" was introduced into science to distinguish between the concepts of biological sex, that is, the "sex" that divides people into men and women. Subsequent research suggests that there are more similarities than differences between the sexes in biological terms. Accordingly, biological gender does not serve as a key factor in determining the role of women and men in society [1, 185]. The difference between a man and a woman Since the emergence of humanity, this difference is first seen in the work they do. The men were busy hunting, looking for food for a living, and the women were setting fire to it so that the fire would not go out in the house. Later, with the development of human society, women and men began to differ in their behavior, dress, demeanor, and speech.

Currently, gender research in linguistics is being conducted in various scientific paradigms. Society culture, socio-cultural relations determine the status of men and women in society. The content of these concepts of “man” and “woman” in different languages is not the same, and the concepts of “man” and “woman” of different languages are directly related to the above factors.

### **THE MAIN FINDINGS AND RESULTS**

Gender analysis of language tools is one of the issues that has been and is being done in linguistics in recent years. A number of studies have been done in European linguistics to show the different cases of expressions that occur in the speech of men and women. In particular, sufficient work has been done in Russian linguistics in this regard, and all means of Russian and women's speech have been analyzed. Each nation uses language tools differently in the process of communication due to its mental nature. The means of language used in Uzbek speech are different from the means of language of other peoples, which also reflects the Uzbek culture, way of thinking and thinking. The reflection of the knowledge, culture and views of its users in language units is a key factor in the formation of women's and men's speech in a unique way.

Men and women differ not only biologically and physiologically, but also in terms of communication behavior. The degree of differences between men and women is directly related to the division of labor and gender differences between the sexes. Differences in the communication behavior of Uzbek men and women are observed to some extent at almost all levels of the language system and at many stages of the communication process [2, 31].

Phrases of the Uzbek language and its dialects also have a gender character. This is because the Uzbek language also differs in that it is often used in women's speech or in men's speech. For example, many of these expressions are applied to men and women in speech processes and are distinguished by their expressive and figurative expression of their characteristics.

Millions of years of historical, cultural and bioanthropological development, especially differentiation, division of labor, have shaped the way of life in women and men, thinking, career choice skills, communication methods, the study of these ideas, the essence of which is the main task of gender philosophy . Hence, the study of gender relations is primarily the task of philosophy. But today, fields of science such as “gender sociology”, “gender psychology”, and “gender pedagogy” are emerging. That is why today in the scientific literature, research and debate, the term “gender” is associated with “gender relations”, “gender characteristics”, “gender equality”, “gender culture”, “gender development”, “gender sociology”, terms like “gender psychology” are widely used. In the words of V. Alimasov, the next twenty years can be called the "period of gender research" [3, 5].

Men and women differ not only biologically and physiologically, but also in terms of communication behavior. The degree of differences between men and women is directly related to the division of labor and gender differences between the sexes. Differences in the communication behavior of Uzbek men and women are observed to some extent at almost all levels of the language system and at many stages of the communication process [2, 31].

Phrases of the Uzbek language and its dialects also have a gender character. This is because the Uzbek language also differs in that it is often used in women's speech or in men's speech. For example, many of these expressions are applied to men and women in speech processes and are distinguished by their expressive and figurative expression of their characteristics.

Millions of years of historical, cultural and bioanthropological development, especially differentiation, division of labor, have shaped the way of life in women and men, thinking, career choice skills, communication methods, the study of these ideas, the essence of which is the main task of gender philosophy. Hence, the study of gender relations is primarily the task of philosophy. But today, fields of science such as “gender sociology”, “gender psychology”, and “gender pedagogy” are emerging. That is why today in the scientific literature, research and debate, the term “gender” is associated with “gender relations”, “gender characteristics”, “gender equality”, “gender culture”, “gender development”, “gender sociology”, terms like “gender psychology” are widely used. In the words of V. Alimasov, the next twenty years can be called the “period of gender research” [3, 5].

In fact, gender (gender) is the difference between a man and a woman according to their anatomical gender. These two sexes (male and female), which have belonged to the same species for thousands of years, differ from each other in their characteristics. Linguistically, too, these two sexes differ from each other. In particular, the use of linguistic and non-linguistic units in relation to them, their use of linguistic and non-linguistic units, there are significant differences between the representatives of these two sexes. Many linguistic and non-linguistic units have a gender identity as they belong to one or another gender. For example, the expressions used by men and women are radically different. There are expressions in Uzbek that”, are used only in men's speech. Many phrases, such as “rub your nose on the ground *“take out your dab”*, *“crush your chin”*, *“take out your abjag”* and *“hit the star,”* are also used in men's speech, especially for men. Women's speech, on the other hand, is characterized by words and phrases such as *“aylanay”*, *“orgulay”*, *“qaqindik”*, *“girgittonbolay”*, which are lexical means of expressing the subtleties of positive meaning in different speech situations. Also, according to the nature of its use by women and men, the terms used in relation to women and men also differ in terms of gender attitudes.

Some expressions are applied only to men, in which the gender meaning may prevail over other meanings. For example: *Would this bull talk?!* We know that the phrase blindness in this example applies only to men. But there are also expressions in our language that their use does not differ by gender, that is, they can be used equally for men and women.

Based on the fact that phrases are stabilized in a way that is specific to the speech activity and the pragmatic situation, they can be divided into the following groups according to their gender:

1. Phrases that can be applied to both sexes according to the communicative purpose and speech conditions: *“Cow kidney eats”*, *“Fear the old goat”*, *“It's like sniffing”*, *“Blind”* and others.
2. Phrases used only for men: *“Skinny kid”*, *“Riding a horse”*, *“Your father's bone”*, *“Going dog”*, *“Dog coming”* and others.
3. Phrases used only for women: *“Betibezraygan”*, *“Romolchiyi”*, *“Oqoragan”*, *“Bet achar”*, *“Shobozqogir”*, *“Tilingdantopgir”*, *“Kara basqir”*, *“Dudoringkurugur”* and others.

The expressions involved in the speech of the Kipchak dialect are, in turn, divided into expressions specific to women's speech, expressions specific to men's speech, and expressions specific to the speech of both speakers.

In the Kipchak dialect, we come across the phrase “Walk as long as you can” in a women’s speech. The phrase is actually related to the concept of the weaving industry, which includes the

content of focusing on quality, effective work, performing productive activities, not just finishing quickly, poor quality name when weaving carpets, socks or anything else.

The phrase “pick up your hands and feet” is also actively used in the speech of these dialect women. This phrase is applied to a pregnant woman after she has given birth to a healthy child. In keeping with the high intellect and culture of the speakers, it serves to provide a gentle, soft expression of the process.

The phrase “faceless” is also common in women’s speech. The term is used in women’s speech to refer to women who are rude, who don’t know the culture of treatment, and who hurt others quickly.

“Carrying in the hands” - is used in the sense of respect, esteem. “Not to cut” is used in the sense of not giving good things and blessings to others. “Ayroniochimas” is applied to carefree, carefree women. “Pressed” means to be tired, to be touched. “White wrap” - applies to women in mourning. “Burning one's feet” is used in the sense of lucky, virtuous, and blessed.

There are many expressions in the speech of Kipchak dialect men that have their own peculiarities:

The phrase “cleared the throat” is common in men’s speech, and we can observe that it is used in different meanings depending on the situation, whether the person is objecting to the interlocutor, his or her comments.

The phrase “Skinny boy” is also widely used in men's speech. This phrase is applied to men who ask about the situation when the case comes down and lead them to a stranger at another time.

The phrase “your father’s bone” is used in men’s speech to refer to boys who have done something wrong or made a mistake. At the same time, there is a positive feature in this phrase, which is that the child is disciplined.

In addition to these phrases, the phrase "He rides a horse" is also common in the speech of men of this dialect. This phrase has done evil, i.e. it is understood that when a person sees that his work has come to fruition, he becomes jealous and interferes with his work.

Phrases that occur in the speech of both speech representatives: “Inakbuyrakjigan” is common in the speech of dialect representatives. An “*inak*” is a synonym for a cow, meaning it eats a cow’s kidney. This is said in the Kipchaks to those who are merciless, stony-hearted. Just as the main occupations of each region are reflected in their own language, the profession of the Kipchaks will be demonstrated in their own language.

The phrase “fear the old goat” is also common, and the word goat in it is a portable word used in the human sense. Keep yourself one step lower in front of older people, they are used in the sense that they are more experienced than you. From this phrase it is clear that the basis of Kipchak training is cattle breeding.

In Kipchak, the phrase “*Qariechkidanqo’rq – be afraid of al goat*” serves to ensure the originality of the speech of the dialect representatives. The word is used in the sense of getting rid of any worries, problems, and acts as an active user unit in the lives of dialect representatives. From this it is clear that the unique lifestyle and culture of the population living in each region is also reflected in the words.

The phrase “*Bovurbasdi*” is also actively used, it is understood that a person loves the things and deposits of others. From this it is clear that the peculiar psyche and cultural views of the dialect representatives live in the form of phrases.

The phrase “*Burnipupraygan*” is applied to people who are conceited, arrogant. This phrase is used not only in its original meaning, but also in the sense of a nickname for this person. The phrase nose is used with a different spirit than the adult, which also indicates the cultural characters in the dialect.

The meaning of the phrase “*kurasikurmagan*” corresponds to the meaning of the phrase “he who does not see is cursed” and is related to the character aspects of a person. That is, the inability to control the passion, to be greedy in everything, applies to those who act uncivilized.

“*Uzunquloq – long ear*” refers to people who hear a message, a sentence first, and like to convey it to others first. As a result, others turn to the same category of people to find out a message.

The phrase “*Juliboldi*” is used in the sense of happiness, thankful, meaning that a person is grateful to someone who has done something. This phrase also shows the uniqueness of the speech of the dialect representatives.

This means that phrases in the Uzbek language, as well as in the Kipchak dialect, increase the effectiveness and attractiveness of speech, as well as gender.

## CONCLUSION

The above shows that the expressions of gender in the Uzbek language, as well as in the Kipchak dialect, are not the same for all, some are applied to both sexes by speech requirement, and some are applied only to men or only to women. The social adaptation of expressions in the dialect lexicon, in particular, gender adaptation, is considered to be inextricably linked with non-linguistic factors such as the culture, lifestyle, and profession of the speakers.

## REFERENCES

- [1] Giddens Anthony. (2002). *Sociology*: Translator. Mamatov N., Begmatov J. – Tashkent: Sharq. –p. 813.
- [2] Mominov S. (2000). *Socio-linguistic features of Uzbek communication behavior*. Doctor of Philological Sciences. Disc. –Tashkent: - p. 231.
- [3] Alimasov V. (2008)*Gender philosophy*. – Tashkent: - p. 154
- [4] Iskandarova Sh. (1993). *Forms of communication of Uzbek speech habit*: Candidate of Philological Sciences. Diss. – Tashkent: - p. 128.

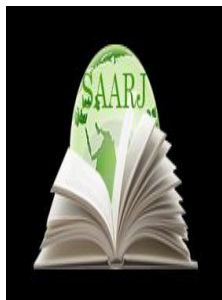

**ACADEMICIA**  
**An International**  
**Multidisciplinary**  
**Research Journal**  
(Double Blind Refereed & Peer Reviewed Journal)

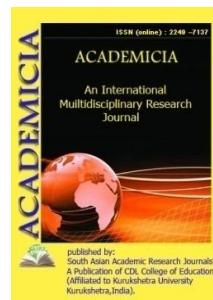

DOI: **10.5958/2249-7137.2021.01321.5**

**COTTON OIL REFINING METHOD**

**Sunnatullo Shamsulloyevich Ismatov\***

\*Associate Professor,  
Candidate of Technical Sciences,  
Bukhara Engineering-Technological Institute,  
UZBEKISTAN

**ABSTRACT**

*A method for refining cottonseed oil sequentially with solutions of aluminate and sodium hydroxide, characterized in that in order to intensify the process, increase the yield and quality of refined oil, the solutions used are pretreated in an electromagnetic field. Known methods of refining vegetable oils and fats in the presence of various types of alkaline solutions and other chemical reagents by periodic and continuous methods in order to obtain refined fats of various qualities and chemical composition. Process intensification, increasing the yield and quality of refined oil. This goal is achieved by pretreating alkaline solutions of aluminate and sodium hydroxide in an electromagnetic field of various strengths in a two-stage crude cottonseed oil refining technology.*

**KEYWORDS:** *Refined Cottonseed Oil, Crude Cottonseed Oil, Optimal Technological, Experiment, Partially Neutralized Oil, Process, Refining, Refining Method, Method, Neutralizer, Batch And Continuous Action, Concentration, Aluminate And Sodium Hydroxide Solutions, Excess, Food Processing, Final Refining, Two-Stage Gossypol Related Technology, Electromagnetic Processing, Analysis And Evaluation, Data, Feasibility.*

**INTRODUCTION**

The method of cottonseed oil refining by these methods is carried out on neutralizers of periodic and continuous action. In this case, the concentration of solutions of aluminate and sodium hydroxide, as well as their excess is selected depending on the initial acid number (mg. KOH / g) and color (red units) of crude cottonseed oil[1,2].

The disadvantages of these methods of refining cottonseed oil are the long duration of the neutralization of raw materials with alkaline solutions, low yield and quality of refined oil.

The closest in technical essence to the present invention is a method for refining cottonseed oil sequentially with solutions of aluminate and sodium hydroxide. This technological method of cottonseed oil refining consists of two stages[3,4].

At the first stage of the refining technology, a certain reduction in the content of free fatty acids (FFA) and substances accompanying the oil is achieved in order to obtain a partially neutralized oil. This is carried out by processing the raw material with an alkaline solution of sodium aluminate of various concentrations and excess.

At the second stage, the final refining technology of partially neutralized raw materials is carried out with an alkaline solution of sodium hydroxide of various concentrations and excess.

As a result of this method, a relative improvement in quality and an increase in the yield of refined oil are achieved.

The disadvantages of this method of cottonseed oil refining are that the total duration of processing of raw materials with alkaline solutions is 120 ... 240 sec; the yield of refined oil, depending on the initial acid number of the raw material ( $K_p = 6.9 \dots 10.8 \text{ mg KOH / g}$ ), is 78 ... 87%. At the same time, the residual content of free fatty acids in the obtained oils ranges from 0.27 ... 0.31 mg KOH / g and their color value is 11 ... 13 CR units at 35 yellow in 13.5 cm layer[5,6].

In addition, high consumption of alkaline solutions for the processes of neutralizing raw materials and sequential refining modes reduce the nutritional value of refined oil.

The objective of the present invention is to intensify the technological process by reducing the duration of processing of raw materials with alkaline solutions, increasing the yield and quality of refined cottonseed oil. At the same time, achieving a reduction in the consumption of alkalis and an increase in the nutritional value of refined oil.

The problem is solved by the fact that in the two-stage cottonseed oil refining technology, the alkaline solutions of aluminate and sodium hydroxide used are pretreated in an electromagnetic field with a strength of 0.4 ... 2.8 A / m. The total duration of processing of raw materials with alkaline solutions is 90 ... 150 sec; the yield of refined oil, depending on the initial acid number of the raw material ( $K_p = 6.9 \dots 10.8 \text{ mg KOH / g}$ ), is 81 ... 90%. At the same time, the residual content of free fatty acids in the obtained oils ranges from 0.07 ... 0.11 mg KOH / g and their color is 4 ... 9 CR units at 35 yellow in 13.5 cm layer[6,7,8,9].

This refining technology makes it possible to reduce the consumption of alkaline solutions for the processes of neutralizing raw materials and improves the process conditions.

In addition, according to the recommended method, an increase in the nutritional value of refined cottonseed oil is achieved.

The essence of the present invention is illustrated by the following examples.

The first stage of alkaline neutralization of crude cottonseed oil is carried out in a standard neutralizer. Partial alkaline neutralization of raw materials is carried out with sodium aluminate solution. In this case, an alkaline solution of sodium aluminate is pretreated in an electromagnetic field, using a typical electromagnetic device AMO-25 UHL4, which is widely used in food enterprises for processing aqueous solutions. The intensity of the electromagnetic

field in the apparatus is regulated by means of a BCA-5K rectifier, which is a necessary part of the apparatus.

Raw cottonseed oil with an initial acid number of 6.9 ... 10.8 mg KOH / g, unobservable color, content (%) of phospholipids 0.8 ... 1.4 is subjected to preliminary alkaline neutralization; free 0.30 ... 0.36 and bound 0.34 ... 0.39 gossypol and tocopherols 75 ... 85 mg 100 g. The process is carried out in order to partially reduce (by about half) the acid number and remove substances accompanying the oil. Taking this into account, the concentration and excess of alkaline solutions are set by calculation, depending on the initial acid number of the raw material.

The process of alkaline neutralization is carried out at 20 ... 22 ° C, with the duration in which the established decrease in the acid number of the raw material is ensured. Research is carried out without and with preliminary treatment of an alkaline solution in an electromagnetic field. At the end of the neutralization process, partially refined raw materials are defatted and filtered from the formed sodium salts (soap stocks). Partially refined raw materials are washed from the remains of an alkaline solution and dried from free moisture, then it is subjected to physicochemical analysis. For the analysis of raw materials and products obtained, modern methods of physical and chemical research are used[7,8,9,10].

The results of the analyzes obtained are shown in Tables 1 and 2.

Analysis and evaluation of the data given in tables 1 and 2 indicate that the treatment of an alkaline solution of sodium aluminate lead to a decrease in the acid number of the partially neutralized oil. An increase in the strength of the electromagnetic field up to 1.6 A / m intensely affects the decrease in the acid number of the raw material, a further increase in this parameter insignificantly affects the studied parameter of the process. As a result of electromagnetic treatment, color is also improved and the yield of partially neutralized oil is relatively increased.

Electromagnetic treatment of an alkaline solution leads to an intensification of the technology of partial neutralization of crude cottonseed oil, that is, the duration of refining is somewhat reduced in comparison with the prototype.

The results of experimental studies confirm the feasibility and effectiveness of using the method of electromagnetic treatment of an alkaline solution of sodium aluminate in a two-stage technology for refining cottonseed oil.

**TABLE 1 EFFECT OF ELECTROMAGNETIC FIELD STRENGTH ON THE RESULTS OF PARTIAL NEUTRALIZATION OF RAW COTTONSEED OIL**

No.	EMF intensity, A / m	Results of partial refining of raw materials			Results of partial refining of raw materials		
		Acid number, mg, KOH / g	Chromaticity, red units at 35 yellow in 1 cm layer	Oil yield,%	Acid number, mg, KOH / g	Chromaticity, red units at 35 yellow in 1 cm layer	Oil yield,%
0		raw materials			raw materials		
		6,9	not looking.	-	10,8	not looking.	90,6
1	Without processing	3,7	37	95,0	6,1	52	90,9
2	0,4	3,6	35	95,2	5,8	41	91,2



3	0,8	3,4	33	95,5	5,4	37	91,6
4	1,2	3,1	30	95,9	4,9	35	92,0
5	1,6	2,7	25	96,6	4,3	31	92,8
6	2,0	2,6	21	96,7	4,1	28	92,9
7	2,4	2,6	19	96,8	4,0	27	93,0
8	2,8	2,6	18	96,8	3,9	25	93,1

The second stage of alkaline refining of partially neutralized cottonseed oil is carried out in a similar manner. The process of final refining of partially neutralized oil is carried out with an alkaline solution of sodium hydroxide. In this case, an alkaline solution of sodium hydroxide is pretreated in an electromagnetic field using an electromagnetic device AMO-25 UHL4. The intensity of the electromagnetic field in the apparatus is regulated using a BCA-5K rectifier[8,9,10]. Partially neutralized cottonseed oil with the following quality and physicochemical parameters is subjected to final refining (Table 2, No. 3):

Acid number - 3.9 ... 4.3 mg KOH / g;

Color - 31 ... 36 crotch units at 35 yellow in 1 cm;

Content,%:

phospholipids - 0.4;

free gossypol - 0.19;

bound gossypol - 0.27.

The process is carried out in order to obtain high quality refined cottonseed oil that meets the requirements of industry standards. Taking this into account, the concentration and excess of an alkaline sodium hydroxide solution are set by calculation, depending on the initial acid number of the raw material of partially neutralized cottonseed oil.

The final refining process is carried out at 20 ... 22<sup>0</sup>C. The duration of stirring the reaction mass is set depending on the quality and yield of refined oil. Upon completion of the final refining technology, the refined oil is defatted and filtered from the formed sodium salts (soap stock). The finally refined oil is washed from the residues of the alkaline solution and dried from free moisture, then it is subjected to physicochemical analysis.

**TABLE 2 RESULTS OF PARTIAL NEUTRALIZATION OF CRUDE COTTONSEED OIL DEPENDING ON FROM THE DURATION OF STIRRING THE REACTION MASS**

No.	Duration of neutralization, sec	Without treatment of alkaline solution in EMF					With the processing of an alkaline solution in an EMF stress. 1.6 A / m				
		Physicochemical indicators of partially neutralized oil				Partially neutralized oil yield,	Physicochemical indicators of partially neutralized oil				Partially neutralized oil yield,
		Acid number, mg, KOH /	Chromaticity, red	Content,%			Acid number, mg, KOH /	Chromaticity, red	Content,%		
				Phospholipids	Free gossypol	Associated				Phospholipids	Free gossypol

		g	units at 35 yellow in 1 cm layer			goss syp ol	%	g	units at 35 yellow in 1 cm layer			goss ypol	%
1	0	6,9	not looki ng.	0,8	0,30	0,3 4	-	6,9	not looki ng.	0,8	0,30	0,34	-
2	30	6,2	51	0,7	0,27	0,3 3	98,6	5,5	42	0,6	0,23	0,30	98,8
3	60	5,7	47	0,5	0,23	0,3 0	97,5	3,9	36	0,4	0,19	0,27	97,7
4	90	4,6	40	0,4	0,20	0,2 6	95,4	3,2	29	0,3	0,17	0,21	95,6
5	120	3,7	33	0,4	0,19	0,2 5	93,4	2,6	18	0,2	0,15	0,19	93,6

For the analysis of refined oil, modern methods of physical and chemical research are used.

The results of the analyzes obtained are shown in tables 3 and 4.

**TABLE 3 INFLUENCE OF THE ELECTROMAGNETIC FIELD STRENGTH ON THE RESULTS OF THE FINAL REFINING OF PARTIALLY NEUTRALIZED COTTONSEED OIL**

NO.	EMF intensity, A / m	Final refining results			Final refining results		
		Acid number, mg, KOH / g	Chromaticity, red units at 35 yellow at 13.5 cm.	Oil yield,%	Acid number, mg, KOH / g	Chromaticity, red units at 35 yellow at 13.5 cm.	Oil yield,%
0		raw materials			raw materials		
		3,9	36	-	4,3		-
1	Without processing	0,27	11	93,4	0,31	13	91,2
2	0,4	0,20	9	93,5	0,29	12	91,3
3	0,8	0,13	7	93,6	0,21	11	91,5
4	1,2	0,10	5	93,7	0,15	10	91,6
5	1,6	0,07	4	93,8	0,11	9	91,8
6	2,0	0,07	4	93,9	0,11	9	91,9
7	2,4	0,07	4	93,9	0,11	9	92,0
8	2,8	0,07	3	93,9	0,11	8	92,0

Analysis and evaluation of the data given in Tables 3 and 4 indicate that the process of the final refining of partially neutralized cottonseed oil proceeds in mild technological modes. This

achieves a significant reduction in the acid number and an improvement in the color of the refined oil. Treatment of an alkaline sodium hydroxide solution accelerates the final refining of the partially neutralized oil to an electromagnetic field strength of 1.6 A / m [6,7,8,11].

Electromagnetic treatment of an alkaline solution leads to an intensification of the technology for the final refining of partially neutralized cottonseed oil, that is, the duration of the refining of raw materials is somewhat reduced.

**TABLE 4 FINAL REFINING RESULTS OF PARTIALLY NEUTRALIZED COTTONSEED OIL ON THE DURATION OF MIXING REACTION MASS**

No.	Duration of neutralization, sec	Without treatment of alkaline solution in EMF			With the processing of an alkaline solution in an EMF, for example. 1.6 A / m		
		Acid number, mg, KOH / g	Chromaticity, red units at 35 yellow at 13.5 cm.	Refined oil yield,%	Acid number, mg, KOH / g	Chromaticity, red units at 35 yellow at 13.5 cm.	Refined oil yield,%
1	0	3,9	36	-	3,9	36	-
2	30	0,37	15	93,6	0,21	11	93,8
3	60	0,31	13	93,4	0,13	9	93,9
4	90	0,29	12	93,2	0,09	6	94,0
5	120	0,27	11	93,2	0,07	4	94,0

Thus, the development of technology for the refining of raw cottonseed oil by pretreating alkaline solutions in an electromagnetic field has achieved an increase in the quality and nutritional value of refined oil and ensured a reduction in the consumption of alkaline solutions used.

## REFERENCES

1. Technology of fat processing / N.S. Harutyunyan, E.P. Kornev and others - 2<sup>nd</sup> ed., Revised and added. // M.: Pishchepromizdat, 1998. p. 452.
2. Research of changes in the quality indicators of bleached cottonseed oil and its products / S.Sh.Ismatov, F.G.Mamatkulov // Austrian Journal of Technical and Natural Sciences Scientific journal No. 3–4 2019 (March– April) p 16-20 ...
3. Refining of the extraction cottonseed oil. / S. Sh. Ismatov and K.Kh. Mazhidov // "Oil and fat industry" journal, Moscow, 2011, No. 4, p. 19-20.
4. Ismatov, S. Sh., and K. Kh. Mazhidov. "COTTON OIL REFINING INTENSIFICATION using electromagnetic treatment." Oil and Fat Industry 5 (2008): 22-24.
5. Ismatov, SunnatilloShamsulloevich, ShomurodKomilovichNazarov, and NigoraAkhtamovnaSharipova. "Continuous refining of cottonseed oil with separators." Young Scientist 7 (2016): 90-92.
6. Ismatov, S. Sh., and K. Kh. Mazhidov. "Method for refining cottonseed oil." Oil and Fat Industry 6 (2008): 23-24.

7. Ismatov, S. Sh. "Cottonseed oil refining using sodium silicate solutions." Storage and processing of agricultural raw materials 4 (2004): 8-11.
8. Ismatov, SunnatulloShamsulloevich, MavludaSayfullaevnaNorova, and Sobir AkhrorUgliNiyozov. "Refining technology. Bleaching of cottonseed oil with local adsorbents." Science and Education Issues 2 (3) (2017).
9. Ismatov, SunnatulloShamsulloevich, NilufarFaizullaevnaKhuzhakulova, and DostonUsmonUgliKhudoyorov. "Technology of cottonseed oil refining using sodium aluminate." Science and Education Issues 2 (3) (2017).
10. Ismatov, S. Sh., H. R. Toshpulatov, and MuslimbekYunusovichAsrorov. "PRESENT STATE OF COTTON OIL BLEACHING." Economy and Society 1-1 (2019): 535-537.
11. Technologies for preliminary refining of cotton oil for treatment of alkali solution in emp / S.Sh. Ismatov, Khairiloev M.K. Zhurn.Voprosy science and education No. 1 (2), 2017, Moscow 2017 pp. 47-48.

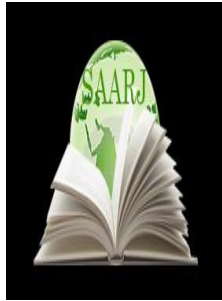

**ACADEMICIA**  
**An International**  
**Multidisciplinary**  
**Research Journal**  
 (Double Blind Refereed & Peer Reviewed Journal)



**DOI: 10.5958/2249-7137.2021.01322.7**

## STUDY OF THE MATERIAL AND CULTURAL LIFE OF THE KARAKALPAK PEOPLE IN THE XIX-XX CENTURIES

**Timur Rustemovich Jabbarbergenov\***; **Ajiniyaz Quralbaevich Paxratdinov\*\***

\*Master,  
 Karakalpak State University, Nukus,  
 UZBEKISTAN

\*\*Master,  
 Karakalpak State University, Nukus,  
 UZBEKISTAN

### ABSTRACT

*The article is devoted to scientific research of the culture and life of the Karakalpaks of the 19th and 20th century. And also, materials of military expeditions organized in the region in order to study the culture and life of the people. The most valuable information about the Karakalpaks, the nature of the region, history was captured by a member of the Russian expedition N.N. Karazin in his paintings "Chimbai Bazaar", "Amu Darya Barge Haulers" and others.*

**KEYWORDS:** *Material Culture, Spiritual Culture, Tradition, Customs, Arts, Everyday Life, Socio-Economic Life, Expedition.*

### INTRODUCTION

The culture and life of the Karakalpak people of the 19th century, as well as of the earlier period - the period of its formation into a nationality, the stages of its historical development were reflected in the works of Russian researchers such as P.P. Ivanov, S.P. Tolstov, T.A. Zhdanko, N.A. Baskakov [1] and others. Studies of the culture and everyday life of the people require an integrated approach that considers the ethnic development of the Turkic peoples, the relationship between them and each other. In 1936, in the process of working on unregistered manuscripts of the Saltykov-Shedrin Library of Leningrad, P.P. Ivanov discovered the archive of the Khiva khans of the 19th century. And although the archive was seized back in 1873, immediately after the conquest of the Khiva Khanate, it was safely forgotten, they remembered about it in the 1930s. As a result of studying the archival documents discovered by P.P. "Archive of Khiva khans of the XIX century." Thanks to which new information is introduced into the scientific

circulation, land tenure among the Karakalpaks in the XIX century. Having carefully studied 12 documents (notebooks), information about the Karakalpaks and Kazakhs, P. Ivanov summarizes them in the section entitled "Karakalpaks and Kazakhs".

### **Main part**

After the conquest of the Khiva Khanate of Tsarist Russia in 1873, a number of expeditions were organized. As part of the Russian troops, a group of scientists was sent, whose main goal was to study the newly conquered lands. The group of scientists included A.V. Kaulbars, A.L. Kuhn, who collected information of an ethnographic and historical nature, M.N. Bogdanov, who was engaged in the zoological study of the region, I.I. Krause, who focused his research on the study of the flora of the region, etc. [2.112.116].

The materials collected by these authors were especially significant for their time, as they became the primary source for further research in the field of social and natural sciences. Thus, the works of A.V. Kaulbars and A.L. Kuna are valuable for the stored materials on the history and history of the culture of Central Asia.

As part of the Amudarya scientific expedition in 1874 under the leadership of N.G. The Stoletovs were visited by L. Sobolev, N. Karazin, Riza-Kuli Mirza, who collected not only ethnographic materials, but also statistical data [3.37]. Thanks to the work of the expedition, interesting information was collected about the culture and life of the Karakalpaks in the lower reaches of the Amu Darya. One of the members of the expedition, Nikolai Nikolayevich Karazin (1842-1908), summarizing the materials he collected during the expedition, publishes a number of works - essays, stories, novels dedicated to the population of this region, paintings and sketches. Pictures painted by N. Karazin illustrate the life of the Karakalpak fishermen of the 19th century, the Chimbay bazaar and other picturesque sketches, which are a valuable source in the study of the life of the Karakalpak people, their features, and customs. Created during the activities of the scientific expedition N.N. Karazin's picturesque pictures and sketches mainly illuminate the life of ordinary people - farmers, cattle breeders, fishermen on the banks of the Amu Darya [4.212-bet].

The most interesting in terms of ethnographic use under the names "Amudarya barge haulers", "Views of the Aral Sea", "Ustyurt", "Karakalpak dwelling", "AulNukus", "Ruins of the ancient Shylpyk mound", "Around the fire" [5]. These pictures allow you to see with your own eyes the life and ethnographic features of the Karakalpak people of that period.

Special studies devoted to the study of the material culture and life of the Karakalpak people of the 19th century were reflected in a number of works, including the work of the Doctor of Historical Sciences, Corresponding Member of the Academy of Sciences of Uzbekistan Ya.G .Gulamov, dedicated to the history of irrigation in Central Asia [6], M.V. Sazonova, considering the types of land tenure relations in the Khiva Khanate [7],

B.V. Andrianov, who studied the ethnic territory of the Karakalpaks [8], A.S. Morozova, who examined the domestic life and culture of the Karakalpaks until the beginning of the 20th century [9].

These works were performed using a large number of historical sources. The national liberation movements of the Karakalpaks against the Khiva Khan of the 18th-19th centuries, the analysis of

the socio-economic life of the Karakalpaks of that period, with the involvement of a wide range of sources, are covered in the monograph of Academician SK Kamalov [10].

The history of the development of Karakalpak literature up to the XX century was studied by the first doctor of philological sciences N. Daukaraev [11].

His work characterizes the development of Karakalpak literature, from oral folk art to the 20th century, covering all genres of Karakalpak literary criticism.

A study on the development of public education of the Karakalpaks of the 19th century, including the colonial period, was carried out by Zhumek Orynbaev, Doctor of Pedagogy [12].

His work reflected such issues as education in the *mekteb and madrasah*, the distinctive features of regional education from European and other. The research was carried out using a large number of archival materials and written sources. Features of culture, art, traditions and customs of the Karakalpak people are highlighted in the work of Doctor of Philology, Professor K.A. Ayimbetov [13]. His work contains rich information about the origins of the Karakalpak songwriting, the development of the art of *jirau*, the formation of the school of *jirau* and *bahksy*, and creative continuity in them.

The social life of the people until the XX century, documents on the types of land use, the tax policy of the Khiva Khanate, the structure of management of the Karakalpaks, *Beksand Beglerbegi*, data on the ruling elite who ruled the people, geographical names, names of tribal divisions and other historical sources are highlighted in the work of Amanbek Zhalilov [14].

His research is a valuable source for studying the socio-economic life of the Karakalpaks in the 19th - early 20th centuries. Kh. Esbergenov carried out an ethnographic study of the Karakalpak people [15].

The ethnographer's work contains information about family rituals, religious beliefs, and the life of the Karakalpaks. His works are of great importance in the study of the national Karakalpak people. The decorative and applied art of the Karakalpaks, in particular, woodcarving, is devoted to the work of I.V. Savitsky "Folk applied art of the Karakalpaks". T. Adambaeva focused her interest on the study of the Karakalpak zhyraw. She carried out a separate study on the work of Musa baksa. The work of the classic of Karakalpak literature as a historical source was studied by Professor M. Tleumuratov (Berdakh's works as a historical source). These works became a significant contribution to the study of the culture and art of the Karakalpak people. In the second half of the 20th century, Russian researchers published a number of works analyzing a clearly delineated chronological period. Here it is appropriate to point out the work of Doctor of Historical Sciences Rzambet Kosbergenov, which highlights the culture and life of the Karakalpaks of the colonial period - the last quarter of the 19th century. Socio-economic life, relationships with neighboring peoples, construction of dwellings, household utensils and clothes, types of crafts, education, arts and folklore have received extensive coverage in the pages of work [16].

Since the middle of the 19th century, the territories inhabited by the Karakalpaks have become an object of interest for European and Russian travelers and artists. Karakalpak lands were visited by T.G. Shevchenko, A. Alikhanov-Avarsky, N.N. Karazin. As part of a Russian scientific expedition, they visited the Aral Sea, part of the distance (from Kuskhana to Turtkul) traveled by steamer, part of the caravan route. Drawings made during the expedition "Sarykol

fishermen", "Amudarya barge haulers", "Chimbay bazaar", "AulNukus", "Pilot between Nukus and Khojeili", "Shylpyk" and others were published in the pages of magazines.

**Results:** Thus, studies reflecting the history of the Karakalpak people of the 19th century, based on the tasks solved thanks to them, can be divided into the following stages:

First: The emergence of archival memoirs and art paintings as a result of Russian scientific and military expeditions.

Second: The emergence of new sources related to the study of taxation policy and land-water relations

Third: Preparation of scientific papers covering the material and spiritual culture of the Karakalpak people, their customs and traditions.

## CONCLUSION

An analysis of scientific works covering the history of the Karakalpak people of the 19th century allows us to conclude that the influence of Soviet ideology prevails in them. So, for example, when describing the history of the peoples of Central Asia, events are presented in such a way as if they, of their own free will, joined Russia, and were not conquered. The indigenous population is presented as completely illiterate, not taking into account the existence of the local education. The coverage of independence movements is not fully covered. All this gives grounds to say that at the present time, after liberation from the political chains of the imperial system, the history of our people should be assessed from the standpoint of national ideology, from the standpoint of modern history.

## REFERENCES:

1. П.П.Иванов Архив Хивинских ханов. Л.1940.151-бет,
2. Толстов С.П.Работы Хорезмской археолого-этнографической экспедиции в 1954-1956 гг. Материалы ХЭ, вып 1. М. 1959,
3. ЖданкоТ.А.Очерки исторической этнографии каракалпаков М.1950,
4. Н.А. Баскаков. Тюркские языки. Издательство Восточной литературы М.1960.
5. .Б.В.Лунин. Средняя Азия в до революционном и советском востоведении.Ташкент, 1965,112-116-бетлер.
6. .Нурмухамедов М.К. рус каракалпақмәдениетин байланыслары тарихынан «Қарақалпақстан» баспасы, Нөкис 1977.37-б.
7. Н.Каразин.В низовьях Аму (путевые очерки), «Вестник Европы», СПб т.Х.1875 212-б.
8. А.Алламуратов Каракалпакские этюдыН.Каразина «Советская Каракалпакия», 1973, 9-октябрь.
9. Я.Гуламов. хоразмнингсуғорилиш тарихи, Тошкент.1959.
10. М.В.Сазонова.Земельные отношения в Хивинском ханстве в XIX в
11. Б.В.Андрианов.Этническая территория Каракалпаков в северном Хорезме (XVIII-XIX) Т.Х.Э.Т. III М.1958.



12. А.С.Морозова культура домашнего быта каракалпаков начале XX века (к вопросу этногенеза) Ташкент,1955.
13. С.Камалов. Освободительная борьба каракалпаков против Хивинских ханов,Т.хэт.Т.Ш М.1958. №1 Каракалпаки в XVIII-XIX веках, Ташкент Изд-во «Фан» УзССР,1968.
14. .Н.Даўкараев «Революцияғашекемгиқарақалпақәдебиятытарийхыныңочерклери». «Қарақалпақстан» баспасыНөкис 1959-жыл.
15. .Ж.Урумбаев Очерки истории школы в Каракалпақстане (1810-1967гг) Изд. «Қарақалпақстан» Нукус 1973.
16. Айымбетов К.А.  
Қарақалпақбақсыжыраўларыхәмолардыңрепертуарлары.Халықданалығы  
«Қарақалпақстан» баспасы Нөкис-1967ж.

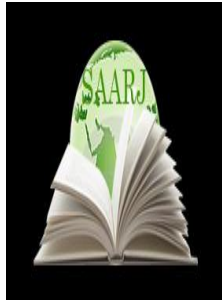

**ACADEMICIA**  
**An International**  
**Multidisciplinary**  
**Research Journal**  
(Double Blind Refereed & Peer Reviewed Journal)



DOI: **10.5958/2249-7137.2021.01323.9**

**SELECTION OF TOOLS FOR MACHINING PARTS MADE OF  
POLYMER COMPOSITE MATERIALS**

**Umida Shaozimova\*, Xabibjon Xamraev\*\***

\* Associate Professor,  
Tashkent state technical university,  
Tashkent, UZBEKISTAN

\*\* Master Student,  
Tashkent state technical university,  
Tashkent, UZBEKISTAN

---

**ABSTRACT**

*The article presents the features of the choice of cutting tools in the processing of polymer composite materials. As a result of the analysis, the authors formulated their own recommendations. The solution of these problems is possible with highly qualified training (according to the requirements of the time) of specialists in materials science and technology, programmers, designers, calculators, operation and repair engineers. The choice of tools should not be limited only to carbide drills, which does not allow us to give an objective assessment of the optimization of the choice of the brand and material of the drill.*

**KEYWORDS:** *Polymer Composite Materials, Similar Parts, Tolerance, Carbon, Cutting Fluid, Quality*

---

**INTRODUCTION**

Currently, a whole series of new-generation binders and carbon fiber plastics has been developed, which have begun to be introduced into the design of promising aircraft. The use of composite materials in aircraft structures for various design and technological solutions has been significantly expanding in recent years.

The variety of polymer composite materials (PCM) – carbon fiber plastics, fiberglass, organoplastics, etc., used in the designed structures, requires a special approach when choosing processing technologies, tools, tooling structures and methods for quality control of finished products. The solution of these problems is possible with highly qualified training (according to

the requirements of the time) of specialists in materials science and technology, programmers, designers, calculators, operation and repair engineers. When designing parts and components made of PCM, it is necessary to take into account both the possibilities of existing production and the creation of new specialized production sites for specific technological requirements for the development and implementation of new developments – perhaps with a small reserve for the prospects for the development and implementation of PCM structures.

### **Main part**

One of the priority tasks in expanding the use of PCM should be the task of creating "artificial intelligence", which will ensure the development of processes in the creation of materials, technologies and new promising structures almost without human participation – only according to the task developed by him and under his control.

For the design of structures from composite materials it is necessary to consider (to ensure the manufacturability) volumes, methods and types of machining – milling, drilling, laser cutting and hydraulic etc.

Difficulties in machining PCM are determined by their physical-mechanical characteristics: tendency to phase separation during processing due to their webbing, structural heterogeneity, the high hardness of the filler material and the low ductility of the binder, etc.

Currently, the most widely used tool for mechanical processing of PCM is a diamond-coated tool or a tool made of a hard-alloy material. Examples of such a tool are shown in Fig. 1. The greater the grain size of the diamond-coated tool, the greater the amount of material removed in one pass, but at the same time the cleanliness of the treated surface decreases. To obtain a high-quality cut, it is necessary to choose the tool that provides the required quality and cutting speed with optimal performance.



**Fig.1. Examples of machining tools**

When choosing a tool, it is necessary to take into account the features of the PCM structure. The more viscous the matrix, the stronger the heat during cutting and the binder sticks to the cutting edge with intense heating of the tool and the part, which affects the quality of the surface of the cutting zone. The choice of tools should not be limited only to carbide drills, which does not allow us to give an objective assessment of the optimization of the choice of the brand and material of the drill. Taking into account the requirements for the quality of holes and drilling modes, when conducting an experiment with a drilling speed of 16,000 and 26,000 rpm (when feeding 0.01–0.15 mm per revolution), it was possible to obtain a satisfactory tool life (750 holes before replacing it). When using a manual electric drill mounted on a tripod, the process is inefficient with possibly unstable quality of the results in production. In the manufacture of parts of aircraft structures, one of the mass processes of mechanical processing of PCM is drilling. When making holes, it is necessary to take into account their functional purpose – holes for assembling power elements of structures, functional (for fuel overflow, in noise-absorbing panels, condensate drain, etc.) and technological. In each of these cases, the requirements for the quality of the holes are determined by the requirements of the design documentation. The quality of the resulting holes on the input and output edges, the accuracy and cleanliness of the surface of the cylindrical part of the hole are extremely important in terms of reliability, durability and operability of the structure. The maximum productivity and stable quality of the through holes in the PCM is ensured by properly selected tools and cutting modes during drilling, as well as the structural rigidity of the technological equipment. An important role in ensuring the quality of the hole surface is played by the durability and geometric shape of the cutting edges of the tool. The main defects that occur during mechanical processing are: cracking of the binder, delamination, pulling out of the fibers, non-cutting of the fibers, thermal destruction of the binder.

The cutting edge usually breaks the matrix (binder) brittle and cuts the reinforcing fibers. To eliminate these defects, special tool designs are used, their geometric shape is optimized, and technological drilling modes are used, using special devices. When drilling PCM, defects often occur at the inlet and outlet of the hole, due to the peculiarities of the drill's force action on the work piece (Fig. 2). At the inlet, there are delaminations and material rupture, and at the outlet – delamination and non-cutting of fibers. Since holes are stress concentrators, such defects contribute to reducing the fatigue and static strength of structures. To minimize effects, tool companies offer special drill designs.

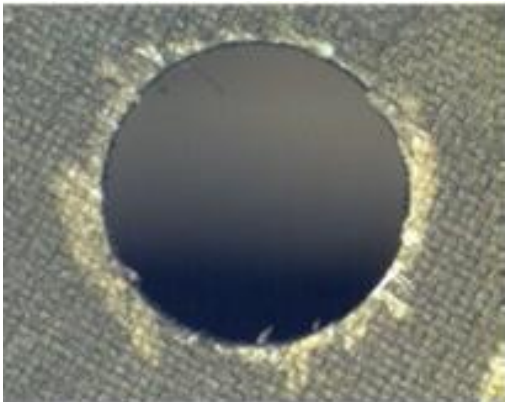

a) b)

**Fig. 2. Local delamination of the material layers in case of violations of the axial feed of the tool during drilling (a) and fiber fragments (chips) on the inner surface of the hole due to wear of the cutting edge and violations of the drilling modes (b)**

Typical hole quality requirements:

- roughness  $R_a < 4.8$  microns;
- delamination
- no chips (torn fibers in the hole).

When processing PCM, a decrease in the quality of the resulting holes can occur long before the tool breaks.

**Improving the productivity of the cutting process.** Speeding up the tool feed and cutting speed increases the productivity of the process, but the more important factor is the quality of the hole. The poor quality of the hole leads to the need for two-stage processing with different tools. An example of obtaining a high-quality hole with two-stage drilling processing is shown in Fig. 3.

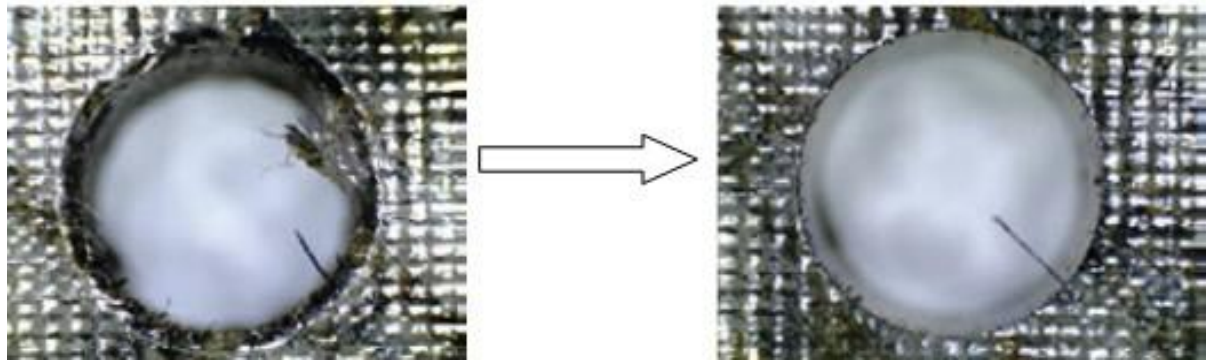

**Fig. 3. Hole quality in two-stage machining with two tools**

Unlike metals, PCM based on a polymer matrix has low thermal conductivity and heat resistance. At temperatures  $>(300-350)^{\circ}\text{C}$  begins the thermal degradation of the binder. This leads to a sharp deterioration in the quality of the treated surface, the appearance of cauterization and reflow in the defective boundary layer (Fig. 4).

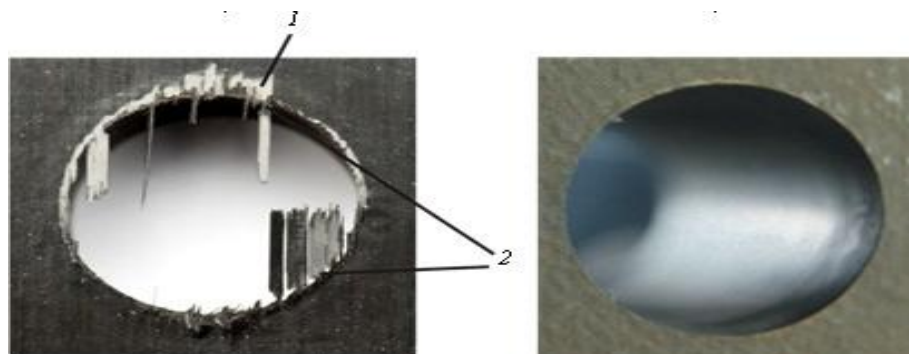

**Fig. 4. Poor-quality (a) and high-quality (b) holes in carbon fiber: 1 – delamination of the material; 2 – non-cutting of the fibers**

To reduce the delamination at the entrance of the hole, double-sharpened drills are used, and to eliminate the non – cutting of the fibers, drills with sharp edges on the periphery are used (Fig. 5). In order to avoid delamination, sometimes it is necessary to use conductors pressed against the surface with a force sufficient to prevent delamination. Drilling is usually carried out with cutting speeds of 100-200 m/min at low feed rates in the range of 0.02–0.1 mm/rev. At the entrance and exit of the drill to avoid delamination, reduce the force and the amount of feed per revolution.

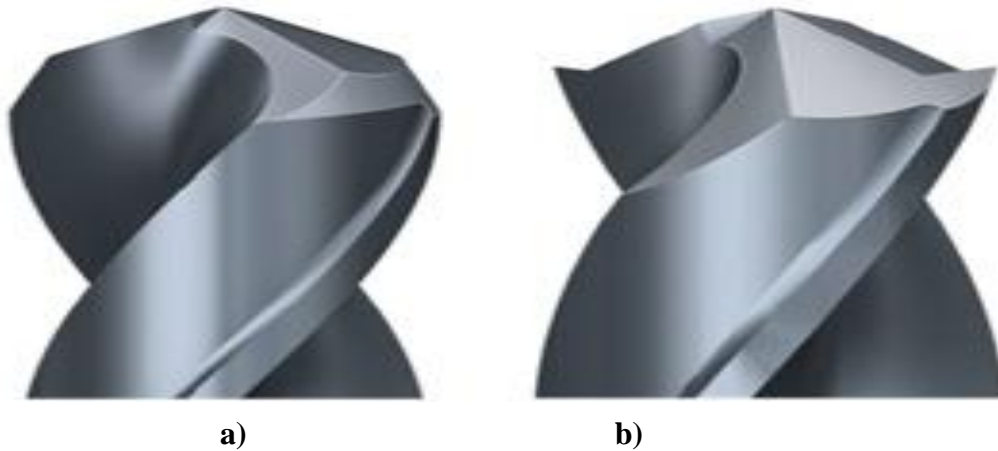

**Fig. 5. Drills for PCM with double sharpening (a) and with undercut edges (b)**

The choice of the process strategy for drilling PCM The upper and lower surfaces of the part differ significantly in the quality of the input and output edges of the holes during drilling. To improve the quality of holes, a number of technological techniques are used: drilling direction, surface protection with technological overlays, etc. Coatings or additional surface layers above the carbon fiber or fiberglass layer can significantly affect drilling performance and quality. Thus, a lightning-proof layer in the form of a fine or large copper mesh (Fig.6, a) allows you to drill carbon fiber with accelerated feed without losing the quality of the hole; fiberglass-increases the risk of delamination, worsening the quality (Fig. 6, b). Both materials can be easily processed with the right choice of tools and processing modes.

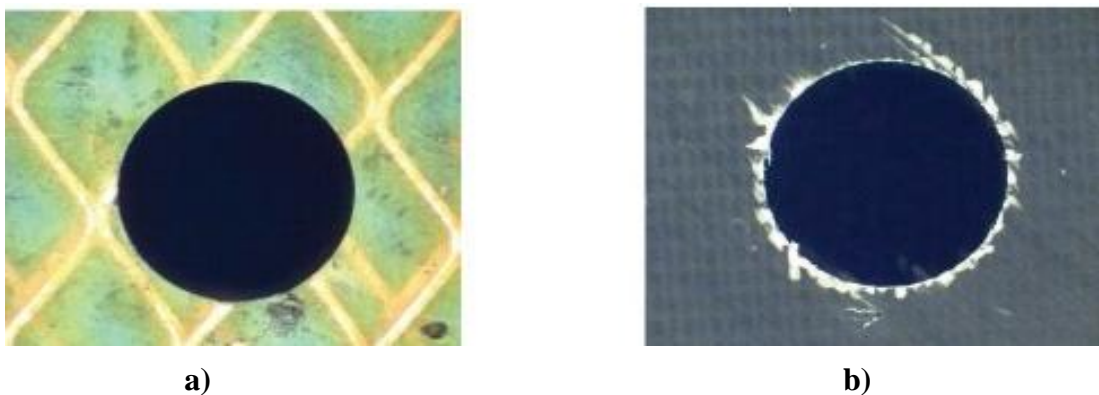

**Fig. 6. Lightning protection layer on carbon fiber (a) and carbon fiber with a layer of fiberglass (b)**

## CONCLUSION

When processing PCM, the cutting fluid is usually not used, so the cutting product is a fine fire-hazardous and harmful to human health dust, which must be removed from the cutting area by a special dust removal system. When processing PCM parts, the cutting volume is usually small: the parts are already molded and only requires, as in this case, drilling assembly holes or holes in the form of perforations – for example, in noise-absorbing panels.

## REFERENCES

1. Timoshkov P. N., Kogan D. I. Modern technologies of production of polymer composite materials of the new generation // Proceedings of VIAM: electron. scientific and technical journal. 2013. no. 4. St. 07. URL: <http://www.viam-works.ru> (accessed: 01.02.2016).
2. Умаров, Т. У., Турсунбаев, С. А., & Мардонов, У. Т. (2018). Новые технологические возможности повышения эксплуатационной надёжности инструментов для обработки композиционных материалов. In *ТЕХНИКА И ТЕХНОЛОГИИ МАШИНОСТРОЕНИЯ* (pp. 70-74).
3. TURAKHODJAEV, N., TURSUNBAEV, S., UMAROVA, D., KUCHKOROVA, M., & BAYDULLAEV, A. Influence of Alloying Conditions on the Properties of White Cast Iron. *International Journal of Innovations in Engineering Research and Technology*, 7(12), 1-6.
4. Mukhametov R. R., Akhmadieva K. R., Kim M. A., Babin A. N. Melt binders for advanced methods of manufacturing new-generation PCM // Aviation materials and technologies. 2012. no. S. S. 260-265.
5. Nodir, T., Sherzod, T., Ruslan, Z., Sarvar, T., & Azamat, B. (2020). STUDYING THE SCIENTIFIC AND TECHNOLOGICAL BASES FOR THE PROCESSING OF DUMPING COPPER AND ALUMINUM SLAGS. *Journal of Critical Reviews*, 7(11), 441-444.
6. Turakhodjaev, N., Turakhujaeva, S., Turakhodjaev, S., Tursunbaev, S., Turakhodjaeva, F., & Turakhujaeva, A. (2020). Research On Heat Exchange In Melting Process. *Solid State Technology*, 63(6), 6653-6661.
7. Mukhametov R. R., Akhmadieva K. R., Chursova L. V., Kogan D. I. New polymer binders for promising methods of manufacturing structural fiber PCM / / *Aviatsionnyy materialy i tekhnologii*. 2011. No. 2. pp. 38-42.
8. Umarov, T. U., Mardonov, U. T., Khasanov, O. A., Ozodova, S. O., & Yusupov, B. D. (2020). RESEARCH OF THE VARIATION OF FIRMNESS OF POINTED DRILLS BY METHOD OF SIMULATION MODELING OF PROCESS OF WEAR. *International Journal of Psychosocial Rehabilitation*, 24(04).
9. Umarov, E. O., Mardonov, U. T., & Turonov, M. Z. (2021, January). MEASUREMENT OF DYNAMIC VISCOSITY COEFFICIENT OF FLUIDS. In *Euro-Asia Conferences* (Vol. 1, No. 1, pp. 37-40).
10. Grashchenkov D. V., Chursova L. V. Strategiyarazvitiyakompozitsionnykhifunktsionalnykhmaterialov [Strategy for the development of composite and functional materials]. 2012. no. S. S. 231-242.



**ACADEMICIA**  
**An International**  
**Multidisciplinary**  
**Research Journal**  
 (Double Blind Refereed & Peer Reviewed Journal)



**DOI: 10.5958/2249-7137.2021.01324.0**

## THE MORPHOLEXICON OF THE UZBEK LANGUAGE AS A SOURCE FOR THE CORPUS

**Ural Menglievich Kholiyorov\***

\*Senior Lecturer of the Department of Uzbek Linguistics,  
 Termez State University, UZBEKISTAN  
 Email id: xoliyorov@tersu.uz

### ABSTRACT

*The article analyzes the issue of morpholexicon, which is considered a necessary database for corpora. Morpholexicon is compared with grammatical dictionaries. World experience, theoretical views and research in the Uzbek language have been studied. In addition, the initial works on morpholexicon is described, and in the article the number parts of speech of the Uzbek language is described for the first time. The results are presented on the basis of tables and graphs, and proposals for further work are developed.*

**KEYWORDS:** *Corpus, Grammatical dictionary, Morpholexicon, Automatic Morphological Analysis, Digital Indexes, Morphoclass, Morphological Dictionary.*

### INTRODUCTION

Attention to the state language in our country has increased to the level of one of the priority tendencies. Therefore, preserving our mother tongue, to enrich, along with increasing the effectiveness of practical use of it, further improving the status of the state language, to achieve wide usage of Uzbek language in modern information and communication system, for this to study of our national cultural heritage, increasing electronic resources in education of mother tongue, as well as, to achieve the unrestricted use of these resources by educators, to collect cultural heritage serving national and spiritual education –native language materials on a platform have become an urgent task. In the implementation of this task, exactly the language corpora, especially the Educational corpora takes the main place.

For this the formation of the most necessary morpholexicon for the corpora is an important component.



### Analysis of literature on the topic

A number of monographic studies and articles have been discussed about the principle of creating a morpholexicon in world corpus linguistics, method, theoretical basis and software tools. [8, 13, 12, 10, 9]. In world linguistics there is also the experience of creating grammatical dictionary, in practice it is observed that grammatical dictionary of several languages is created. We discuss about grammatical dictionary of natural language, morpho lexicon, its features as well as the possibilities of using them in the processing of natural language

**Grammatical dictionary**-a dictionary covering the total lexeme of a particular language, all their grammatical forms. A.A. Zaliznyak's grammatical dictionary [12] not only shows the grammatical changes of modern Russian words (noun, adjective, number, declension, conjugation of verbs), but also serves as a reverse dictionary. In addition to there are all the variants of diversification and conjugation about large volume of theoretical and descriptive information except list of words in introduction part of dictionary. [19]. The features of diversification proper nouns are expressed in the next filled edition. Although the dictionary was published in 1977, it has been reprinted several times with additions and corrections. The dictionary is available in paper and electronic versions, the electronic version is used in instruments of processing natural language: orthographic editing, machine translation, automatic referatization. A.A. Zaliznyak's grammatical dictionary is a fundamental study of morphology. Information about group, stress, genus, view of every words, transitive and intransitive (for verbs) are attached [18]. The author himself gives the dictionary the following definition: "The grammatical dictionary shows the grammatical changes of modern Russian words. The dictionary contains 100,000 words arranged in reverse / inversion: the word is in the order of the letters at the end of the word, not the beginning letter. Each word is marked with an index / index referring to the grammatical information: the user diversify and conjugate interesting words through this index based on the rules of diversification and conjugation. The first edition of the dictionary to the present, the changes in the Russian language are taken into account, filled [18].

The information on the word changes of the general morphology of the Russian language given in Wikislovar is based on the dictionary of AA Zaliznyak. The indexes proposed by A. Zaliznyak were taken into account in the formation of the paradigm of word changers: numbers, written letters in the Latin alphabet are based on the classical method of indexing words (Zaliznyak's principles). Even in the automatic morphological analysis of the word assimilation, the same system is preserved [20]. According to A. Zaliznyak's Grammar dictionary and Wikislovar, numerical indices and accents ending in hard vowels, ending in soft vowels, as well as *z, k, x, ж, u, y, u, y* and *y* multi-letter indexes are included. There is a need to enter this data into the index, which provides information about thematic property in the process of compiling the morpholexicon of the Uzbek language.

But since the emphasis in the Uzbek language often does not differ in meaning, it is not necessary to enter an index indicating the word accent. Morpholexicon is a database that covers a specific language lexical, in which information about its category affiliation, grammatical feature is attached to the lexeme, adapted to the natural language processing process. Such a database is available in electronic form and serves as a linguistic support of various means of processing natural language (automatic translation, linguistic corpus, morphological, semantic, graphemic analyzer).

Based on our observations, we can say that the morphological dictionary contains indicators of change of the word belonging to a category, belonging to a grammatical category, variation of the stem and its relation: these characters serve as a search filter; returns the result to the query with the exact, desired, information. A grammatical dictionary serves to describe the grammar of a particular language; its main function is not automatic processing of natural language. And the morph lexicon is distinguished by the fact that it fully covers the language lexical, is available as a database, is a linguistic supply of natural language processing tools. The morphological dictionary of language and morpholexicon are complementary information banks.

A.M.Galieva, A.R.Gatiatullin, studying the importance of the morphological category of the verb in the construction of the model of Turkish word form suffixes [9], describe the possibility of performing morphological analysis through the base.

If a word in one of the specified Turkic languages is entered in the data entry window of the software, the result window shows the sequence of morphemes and morphological categories according to the word morpheme structure. It may seem that the designation of morphemes and morphological categories in a certain word forms is superfluous. There are certain reasons for this: In Turkic languages, the same morpheme (grammatical form) can represent several categories [9].

For example, in Uzbek, *-ган*, *-иб*, *-ди* represent different grammatical categories depending on their position. Therefore, the suffixes morpholexicon such forms require a special description. Depending on its position, it is the task of the morphoanalyzer, not the morpholexicon, to show what the same form represents. There are special studies on the position of additives in the morpho analyzer [17], therefore we will not dwell specifically on this issue. There are several articles on the theoretical foundations and practice of morpholexicon formation [14, 1]. D.Selegey, T.Shavrina, V.Selegey, S.Sharovlar in the article “Автоматическая морфологическая разметка корпусов русской язычных социальных медиа: обучение и оценка качества” [14] problems of categorization of words in the language of media materials, the types of automatic category detectors, their advantages and disadvantages are discussed and develops suggestions and recommendations for their use, categorization of words that occur in the language of these materials. I.A.Bolshakov, E.I.Bolshakova in the article on the creation of an automatic morphoclassifier of Russian proper nouns [6] expressed valuable views on the automatic differentiation of word groups; they can be used in the formation of the morpholexicon of the Uzbek language. I.A.Bolshakov, E.I.Bolshakova writes about giving information about the belonging of compound names to the category: «42 percent of the morpholexicon, known as the Crosslexics of the Russian language, consists of compound names. Compound nouns can consist only of a noun, but also of a noun, adjective, number, pronouns, adverb. For example: *точка зрения, вид на жительство, право быть избранным, свободная экономическая зона, свободно конвертируемая валюта, семь смертных грехов, теория вероятностей, математическая статистика.*

During the gradual development of cross-lexicon, it became clear that this morpholexicon was enriched with 15 percent of the words present in A. Zaliznyak's dictionary. When the user performs a survey of compound names or enter compound names for analysis, in the result window he can see the change in the paradigm of the agreements of this word, even the names that do not exist on the basis of Crosslexics” [6]. The authors also share their experience in

morphosystem separation. The morphosins they suggest are specific to the Russian language: *генус, одушевленность /неодушевленность* and etc.

A. Fadoua, B. Siham's article «Morpho-Lexicon for standard Moroccan Amazigh» also describes the experience of composing the morpholexicon of the Moroccan language [1].

### Research methods

Methods of classification, description, comparison, statistical analysis were used to cover the research topic.

### Analysis and discussion of results

The following is a description of the practice of composing the morpholexicon of the Uzbek language for the educational corpus of the Uzbek language on the basis of the study of the theory and experience of morpholexicon in computer linguistics.

In order to perform a search based on morphological features in the educational corpus of the Uzbek language, the corpus database must contain a table containing information indicating that all words in the Uzbek language belong to a category – the morpholexicon of the Uzbek language. We used the dictionary “Explanatory dictionary of the Uzbek language” [15] (more than 80,000 words and phrases) published in 2000-2006 to form the morpholexicon dictionary. This dictionary lists a total of more than 80,000 words and phrases, but the dictionary - those listed as keywords – makes up 32,500 lexemes; the remaining 47,000 units are compound words, phrases, and commonly used phrases based on the same lexeme. Therefore, the morphology of the Uzbek language is developed in the following four stages.

First stage: 32,500 lexemes from the Uzbek dictionary were included in the morpholexicon database; they were accompanied by information about belonging to the category.

The second stage: 4700 words were allocated from the dictionary of the Uzbek language from The Dictionary pair and repeated words of T. Jumaev in co-authorship with T. Valiev which were published for schoolchildren and contain 8000 units, [4] and included in the morpholexicon. Since the compound words belong to a different category, they were also given information about their belonging to the category. A new 32500 joint, double and repeated words were introduced into the morpholexicon base with 4700 Lexis: as a result, the base of the morpholexicon, prepared in the second stage, amounted to around 37200 lexical quantities.

Statistical analysis of the morpholexicon base has so far shown the following result:

<b>№</b>	<b>Parts of speech</b>	<b>amount</b>	<b>percent</b>
<b>1</b>	<b>noun</b>	22599	60,62
<b>2</b>	<b>adjective</b>	7179	19,26
<b>3</b>	<b>verb</b>	3949	10,59
<b>4</b>	<b>adverb</b>	1856	4,98
<b>5</b>	<b>imitation word</b>	800	2,15
<b>6</b>	<b>Interjection</b>	244	0,65
<b>7</b>	<b>pronoun</b>	182	0,49
<b>8</b>	<b>Modal word</b>	132	0,35
<b>9</b>	<b>polunctional word</b>	108	0,29

<b>10</b>	<b>postposition</b>	106	0,28
<b>11</b>	<b>conjunction</b>	52	0,14
<b>12</b>	<b>Particle</b>	45	0,12
<b>13</b>	<b>number</b>	30	0,08
	<b>total</b>	<b>37282</b>	<b>100</b>

The above statistic is the first morpholexicon to be implemented, which may certainly be free of minor errors and omissions. But these indicators give a preliminary idea of the category of lexemes in the Uzbek language. When you give the words of the existing base in percentages, the following form the view:

The third stage still requires processing, so the amount of content in this lexicon is unknown. At this stage, the Explanatory Dictionary of the Uzbek language and all the phrases given in the explanatory phrase logical Dictionary of the Uzbek language are distinguished and information about their belonging to the category is attached.

In the fourth stage, the compound names given in the explanatory dictionary of the Uzbek language are selected and the information on belonging to the category is attached. The content of this lexicon is also determined when the database is ready. All of these processes require manual labor: if all of these units are included in a database, they can be used in a variety of linguistic operations. In addition to information about the affiliation of words to the morpholexicon of the Uzbek language, it is necessary to attach grammatical symbols (morphos ins) based on the characteristics of the Uzbek language.

The group of morphos ins is different for each parts of speech. Sh.Hamroeva develops a system of morphological, syntactic and semantic tags while studying the problems of grammatic tapping of corpus material[16].The complexity of the system of tags proposed by Sh. Hamroeva makes it difficult to automatically annotate words.The experience of corpus linguistics shows that the simplification of the system of tags simplifies the practice of annotation (tagging).

## CONCLUSIONS AND SUGGESTIONS

During the examination and preliminary testing of morpholexicon, the following problematic cases were identified.

First of all, the word homonym cannot be identified only by information about belonging to the category on the basis of morpho lexicon. The morpholexicon database shows the homonyms present in the language; a tag belonging to the category is assigned, but this information is not sufficient to identify the homonymous unit in context (in the case of a grammatically formed).Grammatical formation is the most important factor that helps to distinguish the homonymous unit; only this requires the activation of a morphological-syntactic analyzer, in particular the development of a homonymous unit filter.This work will be the subject of a separate study.

Second, in the morpholexicon, language units that reflect the feature of polyfunctionality in the Uzbek language were identified, and they were marked as polyfunctional in the database on their belonging to the category.Naturally, this also leads to a lack of clear indication of affiliation to the category. The meaning of such unity is realized only in the text.The issue of automatic determination of the category of polyphonic words also requires special study. The primary and

secondary functions of the word categories in the Uzbek language [7], computer processing of polyphonic words and suffixes [3, 11, 2, 16] were the objects of Special Research. However, in Uzbek computer linguistics there is no development of the algorithm for automatic detection of polyfunctional words. Therefore, we will analyze this issue specifically in subsequent studies.

#### REFERENCES:

1. Fadoua A., Siham B. Morpho-Lexicon for standard Moroccan Amazigh /MATEC Web of Conferences 210, 04024 (2018). – CSCC 2018 // <https://doi.org/10.1051/mateconf/201821004024>
2. Gulyamova Sh. An'anaviy tilshunoslik va kompyuter lingvistikasida polifunksionallik masalasi // Davlat tili – ijtimoiy taraqqiyot va milliy yuksalish mezoni (O'zbek tiliga Davlat tili maqomi berilganligining 31 yilligiga bag'ishlangan respublika ilmiy-amaliy konferensiya materiallari). – Buxoro, 2020-yil, 16-oktabr. – B. 369-377.
3. Gulyamova Sh. The problem of polyfunctionality in the traditional and computational linguistics // Middle European scientific bulletin. – Volume 5, October 2020. ISSN 2694-9970. IFSIJ Impact Factor: 5,985. – P. 104-107.
4. Jumayev T, Valiyev T. Qo`shib yoziladimi, ajratib (Maktab o`quvchilari uchun). – Toshkent, 2006. – 76 b.
5. Абжалова М. Таҳрир ва таҳлил дастурларининг лингвистик модуллари. Монография. – Тошкент: Нодирабегим, 2020. – 176 б.
6. Большаков И.А., Большакова Е.И. Автоматический морфоклассификатор русских именных групп // Компьютерная лингвистика и интеллектуальные технологии: По материалам ежегодной Международной конференции «Диалог» (Бекасово, 30 мая–3 июня 2012 г.). Вып. 11 (18): В 2 т. Т. 1: Основная программа конференции. – М.: Изд-во РГГУ, 2012.– 774 с. – С. 81-93.
7. Ботирова А.Э. Ўзбек тилида сўз туркумларининг бирламчи ва иккиламчи вазифасининг функционал-синтактик таҳлили: филол. фан. бўйича фалсафа доктори (PhD) диссер. автореф. – Қарши, 2018. – 56 б.
8. Володин А.П., Храковский В.С. Об основаниях выделения грамматических категорий // Проблемы лингвистической типологии и структуры языка / Отв. ред. В.С.Храковский. – Л.: Наука, 1977. – С.42-54.
9. Галиева А.М., Гатиатуллин А.Р. Обозначение морфологических категорий глагола в моделях окончаний тюркских словоформ // Компьютерная обработка тюркских языков. Первая международная конференция: Труды. – Астана: ЕНУ им. Л.Н.Гумилева, 2013. – 340 с. – С. 171-181.
10. Гибадулин Р.Я., Гибадулин Я.Н., Сакаев А.Р., Закиев М.З., Саламатин И.М. Электронные словари тюркских языков // Компьютерная обработка тюркских языков. Первая международная конференция: Труды. – Астана: ЕНУ им. Л.Н.Гумилева, 2013. – 340 с. – С. 156-159.

11. Гулямова Ш. Полифункционаллик хусусида // “Ўзбекистонда илмий-амалий тадқиқотлар” мавзусидаги онлайн конференция. 15-август. № 19. – Тошкент, 2020. – Б. 46-48.
12. Зализняк А.А. Грамматический словарь русского языка. Словоизменение – М.: Русский язык, 1980. – 880 с.
13. Плуныян В.А. Общая морфология: Введение в проблематику. – М.: Едиториал, 2003. – 384 с.
14. Селегей Д., Шаврина Т., Селегей В., Шаров С. Автоматическая морфоразметка корпусов русскоязычных социальных медиа: обучение и оценка качества // Компьютерная лингвистика и интеллектуальные технологии: по материалам международной конференции «Диалог 2016» Москва, 1-4 июня 2016. / URL: [https://www.academia.edu/26571774/Автоматическая\\_морфоразметка\\_корпусов\\_русскоязычных\\_социальных\\_медиа\\_обучение\\_и\\_оценка\\_качества](https://www.academia.edu/26571774/Автоматическая_морфоразметка_корпусов_русскоязычных_социальных_медиа_обучение_и_оценка_качества).
15. Ўзбек тилининг изоҳли луғати. 5 томлик. – Тошкент: Ўзбекистон Миллий энциклопедияси, 2000-2006.
16. Хамроева Ш. Ўзбек тили морфологик анализаторининг лингвистик таъминоти. Монография. (Электрон китоб) – GloeEdit, 2020. – 244 б. – Б. 168.
17. Хамроева Ш. Ўзбек тили муаллифлик корпусини тузишнинг лингвистик асослари. Филология фанлари бўйича фалсафа доктори (PhD) диссертацияси. – Бухоро, 2018. – 165 б.
18. <https://gramdict.ru/>
19. [https://ru.m.wikipedia.org/wiki/Грамматический\\_словарь\\_русского\\_языка\\_А.\\_А.\\_Зализняка](https://ru.m.wikipedia.org/wiki/Грамматический_словарь_русского_языка_А._А._Зализняка)
20. [https://ru.wiktionary.org/wiki/Викисловарь:Использование\\_словаря\\_Зализняка](https://ru.wiktionary.org/wiki/Викисловарь:Использование_словаря_Зализняка)

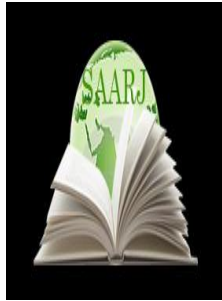

**ACADEMICIA**  
**An International**  
**Multidisciplinary**  
**Research Journal**  
 (Double Blind Refereed & Peer Reviewed Journal)



**DOI: 10.5958/2249-7137.2021.01325.2**

**SPECIFIC ASPECTS OF THE FORMATION OF PRACTICAL  
 KNOWLEDGE IN THE TEACHING OF THE COURSE OF TECHNICAL  
 MECHANICS**

**Yulduz Akhmatovna Suyunova\***

\*Researcher,  
 Karshi Engineering Economics Institute,  
 UZBEKISTAN

**ABSTRACT**

*In the article, the directions of preparation of Future Machine-Building bachelors in higher educational institutions for the profession on the basis of technical mechanics are considered. After the author's graduation, the problems of professional training of machine-building bachelors were analyzed..*

**KEYWORDS:** *Technical Mechanics, Professional Training, Engineering Activities, Mechanical Engineering.*

**INTRODUCTION**

The research carried out and the fact of Life shows that in the process of using modern equipment and equipment brought about by heavy and light industrial enterprises with the aim of increasing the work productivity, a number of problems arise. As a reason, it can be seen that in the absence of mutual integration of education and production sectors.

In recent years, several resolutions have been adopted by the president to link the integration between education and production. The work carried out to carry out the issued decisions indicates that for all mechanical specialties it is considered a universal science. The science of technical mechanics is the science of the alphabet of engineering specialists.

**Purpose**

In the science of technical mechanics –theoretical mechanics, resistance of materials, theory of machines mexanizm, theoretical knowledge of machine details, as well as the study of complex issues that determine the external and working forces formed in the materials, the forces generated in the machine and mexanizm structures, the details of machines and mexanizm, the

Basic Rules for the methods of calculating their types and functions. The science of technical mechanics is included in the block of general professional Sciences, as a general scientific science that gives the basis of Special Educational Sciences of general professional education, which provides the basis of knowledge. In science, machines and circuits are studied by linking the calculation of details and structures with scientific and experimental methods. The science of technical mechanics is based on the acquired knowledge. Therefore, its most important task is the formation of practical knowledge in students.

A number of researchers and Methodists-educators concluded that the main goal of teaching the course "technical mechanics" is to study "theoretical mechanics", "construction of buildings and structures with static elements", "theory of machines and circuits", "fundamentals of machine details and design" and similar special disciplines in a cross – examination. It is based on a number of fundamental disciplines to deep master the science of technical mechanics, complete the solution of theoretical and practical issues; chunanchi is believed to be the maximum "link" to higher mathematics, physics, informatics, engineering computer graphics, Materials Science and other sciences [7, 12-14-b.]. It provides a basic understanding of the methods of solving a large number of issues related to the work of various construction structures and their calculation, the Design Calculation of machine details, the study of mechanical movements of material bodies and mechanical interactions.

### **Scientific novelty of the article**

Practical knowledge is considered as a means of opening up the scientific method, thereby providing students with the motivation to acquire knowledge and prepare them for the fulfillment of the purpose and constructive activity in the surrounding world [1].

It was noted that the exact picture of the scientific method of cognition, which determines the tasks of formation of practical knowledge in relation to the course of "technical mechanics", which will be conducted on the basis of Higher Education, will allow students to acquire the necessary knowledge, skills and skills, will appear on the basis of exactly substantive materials [9].

Analyzing the definitions and opinions of various authors on the formation of practical knowledge, taking into account the fact that it is aimed at preparing students of a higher educational institution for professional-practical activities, we have based the following definition: practical knowledge is knowledge that allows applying theory in solving practical problems [9].

When we say practical tasks-we understand the calculation and graphics, laboratory work, various test tasks in a practical description, etc.

The basis of the formation of practical knowledge among students of technical specialties is the rules of an active approach to education.

The science of "technical mechanics" is a "productive" educational environment that allows the formation of practical knowledge among students of technical specialties. For this reason, it is necessary that the teaching of technical mechanics is closely related to special subjects with a focus on practice.



Thus, the formation of practical knowledge in the course of "technical mechanics" in students of technical specialties is an important factor in further ensuring the effectiveness of teaching them special subjects.

In this regard, the students are:

- \* change (deformation) or immutability of machine and construction parts in shape and dimensions under the influence of external forces;
- \* gear, chain and belt transmission;
- new directions in the design of modern machines;
- to determine the dimensions of materials through machine details and knots, compounds, roller bearings, moulds;
- \* calculation of strength of machines and structures and their parts;
- to have an idea of the mechanical properties of stretching and compression materials;
- using modern design tool for machine details and specifications;

must have relevant skills. This is a list of the basic knowledge obtained from the course "technical mechanics", which is necessary for students in the process of obtaining technical specialties.

The results of our research confidently show that the formation of practical knowledge among students of technical specialties is necessary step by step, that is, at the beginning of the process of teaching students-a special course "mechanics", and then – when directly studying the course "technical mechanics", further development of this process is necessary.

The need to introduce a special course "mechanics" depends on the following circumstances::

- \* lack of preparation of students in mechanical and general technical sciences;
- inadequate student's ability to work independently;
- \* high requirements imposed by the state educational standards for the preparation of graduates of technical specialties for the profession [10].

In fact, The conducted experience-test results show that in the performance of tasks with a practical description in technical mechanics, students make mistakes, encounter a number of difficulties associated with the formal assimilation of certain technical terms, physical sizes, formulas, the inability to apply theoretical knowledge in practice, that is, during the study of technical mechanics, practical knowledge among students of technical specialties

Thus, practical issues of technical mechanics are an important factor in the professional orientation of education in the training of future specialists in technical mechanics.

Thus, it was necessary to establish the task of the course "technical mechanics" as the formation of practical knowledge of students. It is important that such a goal is set and constitutes the subject of our research.

Using the solution of the problem of understanding in the proposed education, we distinguish the following stages of the management of the educational process for its basic unit::

- event recording;
- create high quality model;
- to determine the means of quantitative characterization of the phenomenon;
- characteristic of the result of the study of the phenomenon.

**Results and practical applications.** Thus, according to our research conducted, a student with practical knowledge should be able to::

- to identify the different types of structures that are seen in the technical processes, to distinguish the exact dimensions that occur through these structures;
- distinguish the main ones that are important from the insignificant details that are distracting in the object or phenomenon, that is, drawing up a model, it can be not only one of the main models of the type of "material point", but also any model that is suitable for the given task;
- to distinguish objects and phenomena from their descriptive means, to find the descriptive means corresponding to the selected model, to bring a private description, if necessary;
- to predict the course of a particular event with other objects, under the conditions of other events, using the knowledge of the descriptive characteristics of the phenomenon under study.

Must be understood:

- state and meaning of descriptive instruments;
- to logically describe an ongoing event or process and to understand its causes and characteristics.

Must be mastered:

- \* general rules of theories and laws, areas of their application;
- basic physical quantities;
- limits to the validity of concepts.

Thus, an important educational task is the formation of knowledge about modern practical knowledge, modern technology and technical principles of production in students. At the beginning of the study, objects with different characteristics and phenomena with different aspects are selected. The most important function of mechanics is to explain the phenomena of nature, that is, to find the answer to the question "why this phenomenon happened exactly so, and not otherwise (for example, why when the bodies are compressed, an attempt voltage occurs, why the normal voltage is zero, etc.)". But before explaining the phenomenon, it is necessary to discover it, to distinguish it from a number of other different processes occurring in nature, to understand the scientific truth [2,3, 6, 8, 12, 13].

One of the first stages of scientific knowledge is the identification of these facts, in the process of which "what happens when the bodies are compressed or stretched, and how does it happen?the question "quot; is answered. At this critical stage, the student will be able to independently distinguish the phenomenon that is happening and "why...?the answer to the question "quot; will have to give a justification. Specialists are required to have sufficient preparation and

qualifications for the creation of modern machines and equipment, to identify them with theoretical, practical and experimental yuli.

The second stage is modeling. When we say directly about modeling, this logical step can not be overlooked. In order to formulate knowledge in the process of cognition, students must always be able to identify important characteristics in a particular case of the study of the phenomenon and not pay attention to a number of other, insignificant, insignificant, secondary characteristics. The main features and the ability to determine the abstract of the rest are important in the formulation of models and the determination of the forms of the appearance of related phenomena, the establishment of laws.

Modeling is a necessary stage of the process of scientific knowledge as the process of creating the ideal model of objects and phenomena for their study and explanation.

For example, for the logic of introducing a new value corresponding to logical thinking chains, it is necessary to carry out the following steps [11, 32-b.]:

- \* ultimately tracking the interactions of things and events;
- finding a new feature in a single thing or event;
- to determine the same characteristic of a particular group of objects or phenomena in others;
- naming this feature;
- to determine the different degree of manifestation of this feature in different things or phenomena;
- \* conclusion on the need to introduce a new character;
- add new character name.

The fourth stage is a feature of the results of the study of this phenomenon, and the second stage is an inalienable link with the construction of the model. Therefore, we can observe that this logical step is not sufficiently illuminated in the course of mechanics.

## CONCLUSIONS AND SUGGESTIONS

Based on the above considerations, we can conclude that the formation of practical knowledge in technical mechanics and the problem of the universal block of Sciences (technical mechanics) is not sufficiently complete solution. Thus, our research work showed that in order to increase the effectiveness of teaching technical mechanics to students of technical specialties, it is necessary to develop a special course program, a work program on technical mechanics, purposefully formulate practical knowledge of these programs in students, introduce them in.

## REFERENCES:

1. Altshuler, Yo.B. Formirovanie metodologicheskix i prikladnix znani uchatsixsya v prosesse izucheniya electrodynamics v kurse physical sredney scale: dis... the village. ped. What?- N.Y. Novgorod, 2003. - 215 P.
2. Mirzaxmedov B.M. Problema saderjaniya prikladnix vaprosav physical v raznix tipax srednix uchebnix zavedeniy: dis... D-ra pad. what? - Tashkent, 1980. - 240 s.

3. Nazarov A.A. Machine details, as well as integration of mathematics, natural-scientific and general-technical sciences. //Education, Science and innovation. - T.: 2018. - №3, - B 22-25.
4. Piece C. Izbrannie Psychologicheskie Trudi: Pierre s angl, I FR./ C. Pia-CE. - M.: Mejdunar. ped. Academy, 1994. - Six80s.
5. Rustamov M.M. Povishenie nauchnogo urovnya kursa physical Sredney scale na osnove ispolzovaniya teoretiko-metodologicheskix printsipov: dis... the village. ped. what? - Tashkent, 1987. - 178 s.
6. Setkov, V.I. Novy Vzglyad na dissiplinu" Technicheskaya mechanics " F.I. Setkov / / Srednee Professionalnoe obrazovanie. — 2005. - №2. - The C.12-14.
7. Suyunova Y.A. Stages of development of innovative engineering activity in the world // "Mughal knowledge without words" №1, 2021. 117-119 p.
8. Cherney, O.T. Formirovanie metodologicheskix i prikladnix znani kursa izucheniya it prosesse V studentov technicheskogo vuza V "Materialovede - Nie": Authoref. the dis...the village. ped. nauk: 13.00.02. - N.Y. Novgorod, .2004. - Twenty-three.
9. Chuslantseva, O.A. Kachestvo podgotovki specialista / o.A. Chuslantseva, I.A.Nikolaeva / / Srednee Professionalnoe obrazovanie. — 2001. - It's N10. - fuck you.33.
10. Shadiyev R.D. Methods and Forms to Ensure Understanding in Educational Process. Eastern European Scientific Journal. DOI 10.12851/EESJ201805.www.auris-verlag.de.

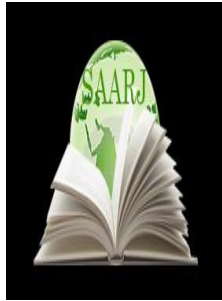

**ACADEMICIA**  
**An International  
 Multidisciplinary  
 Research Journal**  
 (Double Blind Refereed & Peer Reviewed Journal)



**DOI: 10.5958/2249-7137.2021.01326.4**

**PEDAGOGICAL FACTORS OF THE DEVELOPMENT OF SPEECH IN  
 CHILDREN WITH HEARING IMPAIRMENT IN THE PROCESS OF  
 LITERARY EDUCATION**

**Zulfiya Narbaevna Mamarajabova\***

\*Professor, D.Sc.,  
 Head of the Department of Deaf Pedagogy,  
 Tashkent State Pedagogical University named after Nizami,  
 UZBEKISTAN

**ABSTRACT**

*This article covers the analysis of the scientific and theoretical foundations of the development of children's speech with hearing impairments in the process of literary education. In the process of literary education, the essence of the pedagogical factors of the development of children's speech with hearing impairments is revealed.*

**KEYWORDS:** *Literary Education, Hearing-Impaired Students, Speech, Principles, Artwork, Methods, Knowledge, Skills, Literary Education Educational, Pedagogical, Developmental-Correctional Tasks, Speaking Ability*

**INTRODUCTION**

The educational, pedagogical, developmental-correctional, purposeful emotional perception of the world, ideological, aesthetic tasks of literary education are described, and the development of student speech as a tool of communication has a positive effect in the context of application of each of these tasks in interaction. V.K. Skatershikov distinguishes the cognitive, aesthetic, educational and communicative functions of literary education. In addition to these functions recognized by the general public, other functions have also been mentioned by the researchers [2; 37-p.].

If N.K. Gay offers expanded concrete-emotional understanding of the world [8; 463-p.], D.S. Likhachev offers educational-aesthetic [4; 237-p.], and M.E. Markov-compensatory, educational-pedagogical, social-organizing and organizational functions [5; 191-p.]. M.S. Kagan explains the diversity of the multifunctionality of art by linking it to the specificity of human life activity in its completeness and structural integrity. [6; 34-p.]. In the opinion of researchers

engaged in aesthetics, literary studies, philosophy, the value of a literary work is determined not only by its cognitive, educational and communicative functions, but also by its aesthetic effect - the ability to arouse "unselfish" enjoyment in a person. N.K. Gay emphasizes that in art, the process of perceiving oneself as both a creator and a person takes place [9; 456-p.]. In the acts of creativity and perception of the work is an excellent creative person, which means that as an object of aesthetic assimilation, perfect assimilation takes place in the surrounding world. In addition, Yu.M. Lotman's research emphasizes that the aesthetic value of art is the expression of its essence, since the aesthetic function integrates everything else [4; 70-p].

Literary education should be focused on the implementation of educational, pedagogical, developmental-corrective, purposeful emotional understanding of the world, ideological, aesthetic, tasks. The implementation of the tasks of literary education depends on the level of preparation of teachers and students, the correct establishment of partnerships to achieve a deep understanding of the specifics of fiction as the art of speech. The *task of literary education* implies the emotional perception of the work of art, the development of visual, logical thinking, creative imagination, the formation of a feeling of love and respect for educational national values, the upbringing of a spiritually mature person, *the corrective developmental task* of the reader implies the development of dactyl, oral, written speech. Among the educational task of literature education, the formation, lexical, grammatical aspects, residual hearing ability of the student are developed. In the process of literary education, speech development is carried out in three directions, such as the development of speech ability, speech activity and acquaintance with the structural system of speech.

Verbal ability develops in these lessons by mastering the meaning of the whole text by linking the meaning of words with other texts. From the types of speech activities, first of all, in addition to reading, the skills of speaking, hearing, seeing, writing, typing are developed. In reading lessons, students are introduced to the structure of speech, in the expression of their thoughts, on the basis of the presence of examples of words and phrases in the text and passages. In the process of reading the material, which is formed and varied in content, there is a wide opportunity to work on the correction of mental processes such as memory, attention, developing the ability to think in speech and connected speech.

The purpose of literary education is to teach the perception of the beauty of the world through art, the aesthetic task is to create and understand the delicate taste, beauty, the formation of feelings of enjoyment, the ideological task is to cultivate a high worldview and faith. takes

The educational-educational, correctional-developmental, purposeful emotional comprehension, aesthetic, ideological functions of literary education can be effectively realized only if the reader reads and understands what he reads. The level of perception of the work by students with hearing impairments, the level of speech activity on creative thinking based on the read works can be achieved by studying the perceptual features of the literary text, knowing the structure of the text, teaching psycho-semantic space. This approach is also effective in defining the content of education.

Only a purposeful and holistic perception of a work of art leads to the emergence of aesthetic experiences and the need to express it orally. Excessive rationalism in the analysis of the work in the classroom leads to a violation of the integrity of perception and a decline in aesthetic experiences. Therefore, the teacher can perform the tasks of literary education by applying the

interrelationships between the educational, pedagogical, developmental-correctional, purposeful emotional perception of the world, ideological, aesthetic tasks of literary education. A deep understanding of the peculiarities of fiction as the art of speech depends on the level of training of teachers and students, the correct establishment of partnerships.

In the process of literary education, children develop speech. If speech is the back of a medal, the front is a pedagogical, ideological and didactic system. According to VI Tyupa: "The superiority of communication over information, the development of speech means the readiness to teach the native language, the superiority over the formation of formed concepts" [6; 11-b.].

In the process of literary education, the teacher encourages the student to refer to the literary text from an unfamiliar point of view in order to fully understand the opinion of others, to fully understand the opinion of the classmate, allows the student to look at familiar works of art differently. Thus, the comprehension of the text leads to the understanding of the opinion of others, the understanding of the opinion of others, the organization of learning dialogues, the elimination of student egocentrism, the interest of students in each other, respect, the desire to hear the opinion of others.

Dialogue is a method of conversation that is recognized in all learning models as the basis of learning communication. But teachers do not always have a common understanding of the role of dialogue. In traditional education, teachers have always worked in a dialogical manner. In fact, they ask students questions, listen to their different answers, but this form of dialogue does not provide a learning dialogue.

V.A.Domansky distinguishes learning dialogue from traditional conversation: "Dialogic conditions (the difference between lesson dialogue and conversation-lesson, the teacher knows the answers to pre-asked questions) are created from the fact that is taught or learned by the student. It is definitely modeled by the teacher. "Dialogue is a free dialogue between two equal people in the field of culture, in which there are not rigid, but unpredictable examples of creativity" [4; 54-p.].

The factor that hinders the development of speech in children with hearing impairments in the process of literary education is related to the nature of the subjective interaction. The learning dialogue involves not only the teacher interacting with the students, but also the students interacting with each other. Primary school students usually in the early stages of education explain their ideas to the teacher, waiting for his response, evaluation. The teacher, on the other hand, communicates face-to-face with each student.

In the process of literary education, communication between students is established, a barrier called the 'sunflower effect' is overcome (students look at the teacher as if the sunflower were facing the sun, as if it were spinning). The establishment and development of equal rights for teachers and students will lead to a decline in the status of school grades. "Who understood what Alisher said? Do you agree with the princess? Why did Nodirjon think so?" With questions like, the teacher teaches each student to see their classmate as a partner, to work with them collaboratively, to hear the answer, to ask questions, to listen to the opinions of their peers. The learning tasks in the textbook aimed at solving learning problems help students to organize their collaborative work, involving children to pay mutual attention to their ideas. Children's ideas are written on the board, discussed, and artwork created by children is discussed. Such an organization of the learning process allows students to interact, work creatively in groups.

One of the barriers to organizing learning dialogue in the traditional learning process is to look at the child as a fable, explained by the teacher's lack of attention and interest in the students' experience. In this context, the teacher's unique knowledge carrier in the learning community, which is able to assess students, manifests itself in an authoritarian attitude that negatively affects children's access to equal dialogic attitudes. Traditional education does not take into account the many years of intellectual and intellectual skills that a child develops before coming to school and is mastered by school-age adults, books, computers. Many years of hard work (answers to the child's questions, views on problem solving, reading books, discussion of the plays he watched) will not be required to understand the world around the child, supported by the parents. It is this child who will no longer feel the need for personal intellectual and spiritual property and will need to develop. The child worries that his pre-school knowledge, skills, and experience are not needed in the classroom. As a result, the child learns that his personal impressions and opinions are not taken into account in the educational dialogue.

In the non-traditional lesson, the teacher's cooperation with the student prevails, rather than the "individual authority" of the teacher, and a healthy creative environment is created as a result of their joint creative and practical activities. In such an environment, the student acquires the knowledge and skills he or she needs to acquire through hard work, reflection, and thinking. In the process of literary education in this innovative system, the speech experience of students in preschool and school period serves as a basis for the development of speech of hearing-impaired children.

Developing students' speech is one of the main tasks of a modern special school. The development of students' speech is closely related to the process of developing thinking, imagination, learning creativity.

The solution to the problem of organizing educational dialogue in the process of literary education is to overcome the authoritarian approach. In doing so, the teacher must understand the uniqueness of the children and approach each child individually. In the process of literary education, the teacher enters into a natural learning dialogue with the student, at the same time demonstrating the form and methods of teaching the teaching material. Role-reading, acting, and selective reading methods can be used during the learning dialogue.

In the process of literary education, students are introduced to the world of literature through acquaintance with literary genres, folklore, works of art, biographies of writers. At the stages of literary education, the initially acquired theoretical knowledge, skills and abilities are developed. Students' knowledge is monitored on the basis of learning tasks. In the process of performing them, it is necessary to master the literary text, to understand its elements. On the basis of educational dialogue the student develops the ability to aesthetically perceive the literary text, to distinguish the author's individuality through the text.

We describe the following methodological requirements for the development of speech in children with hearing impairments in the process of literary education:

1. Development of student speech through the interrelated application of each of the educational, pedagogical, developmental-correctional, emotional comprehension, ideological, aesthetic functions of literary education.



2. Achieving a deep understanding of the peculiarities of fiction as a verbal art in the implementation of the tasks of literary education through the correct establishment of cooperative relations between teachers and students.
3. Educational dialogue in literary education is formed on the basis of knowledge, skills and abilities available to the student. It is of course modeled by the teacher, the dialogue is a free dialogue of two equal people in the field of culture, not a rigid idea, but a creative dialogue based on vivid, unique, original views and analysis of creative samples.
4. By eliminating authoritarianism and monologism in the development of speech of hearing-impaired students, natural communication is established as a result of lively communication between students, the so-called "sunflower effect" is eliminated (students give up the situation of staring at the teacher forgiven). The teacher should help each student to see his classmate as a partner, to work with them collaboratively, to hear their answers, to ask questions, to analyze the answers of their peers.
5. The student's personal impressions, opinions, personal experience should be taken into account in the formation of the educational dialogue in the process of literary education. One of the barriers to the development of speech in children with hearing impairments is the view of the child as a fable, i.e., the lack of attention and interest on the part of the teacher to the students' intellectual and practical experience. In this context, the teacher's unique knowledge carrier in the learning community, which is able to assess students, manifests itself in an authoritarian attitude that negatively affects children's access to equal dialogic attitudes. Therefore, the student's personal impressions and opinions should be taken into account in the educational dialogue in the process of literary education.
6. In the process of literary education develops naturally through the formation of a natural learning dialogue through the teaching of educational material, the substantiation of students' opinions, their opinions, the attitude to their classmates. Therefore, in order for a teacher to engage in a natural learning dialogue with students, it is necessary to choose the right form and methods of teaching the learning material at the same time.
7. The development of students' speech in the process of literary education should be carried out in conjunction with the development of skills of aesthetic perception of the literary text. During speech development, role-playing, staging, selective, or interpretive reading is performed. In literary education, the educational dialogue involves not only the development of the student's speech, but also the formation of the skills of aesthetic perception of the literary text, the ability to see the author's individuality in the text. Through the learning dialogues organized on the basis of these requirements, it is possible to achieve the development of students' speech.

## REFERENCES

1. Voyushina M.P. Formation of the ability to analyze the creative work as a means of literary development of young schoolchildren: Dis. ... Kand. ped. science. - L., 1989. - 237 p.
2. Voyushina M.P., Kislinskaya S.A. Metamethodical approach to the formation of a cultural field of school. - SPb.: RGPU im. A.I.Gertsena, 2006. - 33 p.
3. Golovchits L.A. Izuchenie literaturnogo personaja v sedmyx- vosmyx klassax shkoly dlya gluxix detey.: Avtoref. kan. ped. science. - M.: NII Defectology, 1975. - 13 p.

4. Grigoreva T.A. Puti razvitiya prichinno-sledstvennogo myshleniya gluxix shkolnikov. Methodical recommendations. - L.: LVTs VOG, 1979. - 47 p.
5. Gukovskiy G.A. Izuchenie literaturnogo proizvedeniya v shkole. - L.: Prosveshchenie, 1966. - 266 p.
6. Demina A.V. Formirovanie dialogicheskoy rechi slaboslyshashchix uchashchixsya vo vneurochnoy deyatel'nosti: Dis. kand. ped. science. - Moscow, 2010. - 128 p.
7. Zikeev A.G. Work on lexicon in nachalnyx classes special (correctional) schools. - M.: Akademiya, 2002. - 170 p.
8. Zikeev A.G. Development of rechi slaboslyshashchix shkolnikov. - M.: Prosveshchenie, 1976. - 240 p.
9. Zikeev A.G. Development of recha uchashchixsya spetsialnyx (korrektsionnyx) obrazovatelnyx uchrejdeniy. - M.: Akademiya, 2000. - 199 p.
10. Komarov K. V. Methods of teaching Russian language in school for weak children. - M.: 1988. - 223 p.
11. Komarov K.V. Methodology of teaching slaboslyshashchix detey gramote. - M.: Prosveshchenie, 1990. - 268 p.
12. Marantsman V.G. Analiz literaturnogo proizvedeniya i chitatelskoe vospriyatie shkolnikov. Methodical manual. - L.: LGPI im. A.I. Gertsena, 1974. - 176 p.



**ACADEMICIA**  
**An International**  
**Multidisciplinary**  
**Research Journal**  
 (Double Blind Refereed & Peer Reviewed Journal)

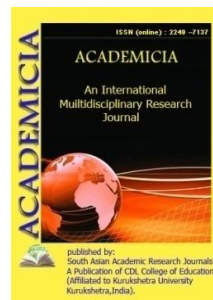

**DOI: 10.5958/2249-7137.2021.01327.6**

## TRADITIONS AND HISTORICAL ANALYSIS OF THE FOOD INDUSTRIES OF THE SURKHANDARYA OASIS

**Gayrat Abdulkhakimovich Mamarajabov\***

\*Senior Lecturer,  
 Department of General History,  
 Termez State University, UZBEKISTAN

### ABSTRACT

*In addition to the supra prepared by the craftsmen, there are a number of myths associated with the utensils used for baking such as bullets, sieve, rapid, encha, and kosov. The oasis artisans attached great importance to the cleanliness and purity of the cauldron, because their life could not be imagined without a cauldron. Copper and cast iron pots were used in the daily life of the oasis artisan family.*

**KEYWORDS:** *Cheese, Household Chores, Dishes, Supra, Chopped Soup, Bacon, Butter, Yogurt.*

### INTRODUCTION

In the material culture of the population of the Surkhandarya oasis, it is important to deeply study the features of technology made by artisans, as well as its functions in everyday life. It is only natural that the wonderful supra riddles made by local craftsmen will help the young housewife master the housework, prepare delicious food and earn herself a good reputation, as a result of which the hostess will become an adherent of honesty and cleanliness. All baked goods were prepared by the masters in the supra. According to local tradition, the supra was not left open and without flour, since the flour in the supra was a sign that the family's food would not be interrupted. Supra was popular with families of artisans and it was discovered as "Bismillahir Rahmanir Rahim". Old mothers taught young women that the Bismillah blesses every deed and that the devil does not interfere with what you do. When the work was done in Supra, it was collected by turning to oneself so that his blessings would surely remain with him. This tradition was followed in the Kashkadarya oasis [1.180]. When making dough in a supra prepared by artisans, a woman should have in her hand an "ashalol" (ashkhalol) ring. The handicraft bells in the oasis wore a ring as a symbol of purity. Not only in cooking, but also in other household

chores, women wore a ring with ashalole [2.18.]. There were fears that the bread would "bloom" if someone or a cat jumped over the supra. It has been said that if a woman leaves more flour after kneading during pregnancy, the unborn child will have more hair and less hair [4]. In the village of Koschinor, Denau district, before putting the child in the cradle, two women rolled him from side to side, and then wrapped him in the cradle so that the child would have a portion of food. When a girl was born in the family, her mother sewed her a supra. Because in our people, since ancient times, a house without a supra was considered a blessing. Therefore, there is a supra in every house. While the young brides simply lived on their own, an old and experienced mother stood by them at home and explained the blessings of the supra. Already now we see that in every house the supra is carefully placed in a special clean bag. Hence, the supra and associated rituals taught women to be chaste.

### Methods

In the village of Pandzhob, Baysun district, in the village of Pandzhob, Baysun district, a new bride came to the family in the crafts, dipped her hand into the supra, kneaded the dough with the addition [6]. It was a supra yadi ceremony, during which the bride's readiness for household chores, her ability to read, work hard and dexterity were tested. The idea of transferring to another social group, these rituals associated with preparing the bride for a new activity, were practiced in other regions and are called "supra saldi" [7.41.]. Among the Tajiks of Faizabad, the bride was presented with a supra in her right hand and "thin bread" in her left hand with the intention of becoming a good housewife [8.117.]. It was then that the supra was written, in which the bride was told to knead the dough for the cake. The mother-in-law poured butter on the bride's hand, and the bride kneaded the dough. The mother-in-law spread the dough and baked oshi ugro (chopped soup) thinly. The guests drank chopped soup and praised the young bride as a good hostess. In addition to the supra prepared by artisans, there are a number of myths associated with the utensils used for baking, such as bullets, sita, rapid, enchkha and kosov. For example, in the village of Khazarbog in the Denau district, families of artisans did not pay attention to the rapid, saying: "May the blessings of the house not rise, may our work not go to the left." In the villages of the Altynsay region, if a girl has two locks in her hair, her mother sews a lock on her forehead with the words: "My daughter should not have two marriages." In the village of Khazarbog in the Denau district, during the ceremony of a "boring woman" calling for rain, artisans at night poured rapids into streams or springs, saying: "This is the biggest." Among the inhabitants of the oasis, ammunition made by artisans was not erected, because the ammunition was set when the dead person left the apartment. Since the families of local artisans are the breadwinners of the people, great attention is paid to keeping the utensils used for cooking clean and wrapped in a specially sewn blanket or separate tablecloth. In addition to sheep and goat skins, artisans also used their belly as a container for tail fat, butter and yogurt [12.140]. The abdomen was thoroughly washed, turned out and hung up with a puff. Once the belly is well dry, it is soaked in plenty of salted yogurt. After standing for 10-15 days, not a trace of the demon remained in it, and it turned into a ready-made dish. The amount of oil placed in each belly depended on its size [13]. The oasis artisans attached great importance to the cleanliness and purity of the cauldron, because their life could not be imagined without a cauldron. As soon as the pot is removed from the oven, it is placed on a specially prepared stove and the neck is closed with a lid. The pot is washed immediately after cooking. The washed pot is based on the belief that "there is always desire." The necks of pots and pans are always closed so that the devil

does not lick them. There is a rumor that the bottom of the pot was not broken, and the saying “if the bottom of the pot is broken, the angels will fly away”. In the village of Laylagan, Sherabad region, families of artisans believed that feeding the birds with food or grain in a pot would increase the welfare of the house and make it unattractive [14]. To protect the young bride from all sorts of calamities and disasters, a pot was placed in the corner of the chimpanzee. The craftsmen in the oasis worked on the pot. For example, wounds inflicted on the body of a small child are inoculated with pot black. A child feared by experienced artisan elders drank water from a cauldron. They rubbed his forehead with a cauldron so that he would not fly when carrying a small child at night. The neighbors vaccinated the patient, lit a lamp, adding a pot of blackberries to the side. The artisan families strictly adhered to the Udim and Irin-Sirim, while the breast of the lactating woman was vaccinated with one of the kitchen utensils, such as an elbow, a rapida, or a pen, by first tapping the four ears of the pot and then touching the ground. and then to the woman's chest. If the moon is darkened or the earth shakes, something gets into the cauldron (usually cappuccino) [17]. The masters paid special attention to the funeral rites. Including. Funeral ceremonies also performed rituals associated with the cauldron. On the day of the death of the deceased, the pot of food (gruel) was turned over for three days [18.161.]. To wash the deceased, the water was heated in a new cauldron and after washing it was turned upside down and some ash was sprinkled on it, as the people believed that ash would bring relief [19]. At the Tajik craftsmen Koragin and Darvaz, the water cauldron was thoroughly washed with ash or sand to wash the deceased and turned over overnight. In some villages, a cotton swab was placed over the ears of an inverted pot, claiming that "whiteness" would bring relief. In Kulob, Tajik artisans sprinkled an overturned cauldron with ash or flour with the goal of "so that the dead don't come out again, let the light come on after that." In general, in the house where the victims went out, not only a hot water boiler, but also other boilers were overturned for up to three days.

## RESULTS AND DISCUSSION

Copper and cast iron pots were used in the daily life of the oasis artisan family. Since the cast iron pots created by the craftsmen were cast and heavier than copper, more copper pots were used. That is why copper sandpits, teapots, bowls, basins, handkerchiefs, tuffons and samovars are made of copper. In Sherabad there were special coppersmiths who made various types of pottery. For example, Kurban Misgar is a famous artisan, whose ancestors were also engaged in this profession, and in the 20th century, the descendants of the master continued the profession of a coppersmith [20]. In the principality of Sherabad, experienced craftsmen made beautiful tufdons with the famous oriental cap, which was called dashoy-tufdon [21.66.]. Thanks to the painstaking work of the craftsmen, the place of the knife among the iron kitchen utensils is fragmentary. For example, in the village of Hamkon, Sherabad region, knives made by the master and blacksmith Abiramat Bobo were highly valued for their sharpness and irreversibility. Knives made by the craftsmen of the Boysun Center are also popular, and this tradition continues to this day. Knife myths have survived among the artisans of the oasis. In particular, they believed that if the knife struck, the enemy would multiply, and if the blade was directed upward, it would bleed out. It was customary to hold the knife while moving, trying not to touch the tips of the knives so as not to provoke a quarrel, and nail it to the ground if the tips of the knives touched each other. During prayer at the table, a knife was removed from the table so as not to cut the prayer. He rubbed the kirna with a knife to cut the kirna (kinna). Measures were taken to

prevent this, they say, if the girls cut the knives, they will cut their own happiness. Similar myths still exist today. For example, in wedding ceremonies, people with ill intentions believe that these young people will not be happy if they turn their knives upside down during the wedding ceremony [23.42.]. The knife was a constant companion of the young man. An example of this is the following. After the bread had been broken, the young man approached the girl for a "magic game." That is, the young man came and talked to the girl after dark. As a result of the conversation, if the girl became pregnant and the young man went on a journey without knowing it, the marriage was concluded by placing a knife in the middle of the young man, thereby removing the stigma. Here the knife served the young man symbolically. In other similar customs, we see that a knife is a constant companion of a young man. From the Uzbeks of the Ferghana Valley, the bride's brother demanded "a knife" or "money for a knife" when he brought the bride to the groom's house. For the knife prepared by the groom, they gave "money for the knife" if the knife was not prepared [25.41.].

### CONCLUSIONS

Particular attention was paid to highlighting the traditions associated with artisans, the attitude towards kitchen utensils, that is, our values, such as care and cleanliness in relation to them. The table was created as a source of food for artisans, to prevent waste, to create an image of ethnic traditions and life of the inhabitants of the oasis, focusing on the ethics of education, the criteria of education. The regional disposition of artisans also influenced their farming methods. Thus, an analysis of the kitchen utensils used in the daily life of artisans and the customs associated with them shows that they have both territorial and historical characteristics.

### REFERENCES

1. Boriev O. and others. Shown work.-p.180.
2. Ibragimova M.Yu. Traditional clothes and adornments of the population of the Surkhandara oasis (late 19th-early 20th centuries). Abstract of thesis for Candidate of Science. historical sciences. T., 2004.-p. 18.
3. Field records, Sherabad region, Navbog village. 2021.
4. Field records, Oktepa village, Jarkurgan region. 2021.
5. Field records, village Koschinor, Denau region. 2020.
6. Field records, Panjob, Boysun region, Khufor village, Sariosiyo region. 2020.
7. Ashirov A. Some comments on the genesis of traditional wedding ceremonies ... - p.41 .; Zununova G. To the question of the ritual ritual of the Uzbeks ...- p.74 .; Tashkent mahallas: traditions and modernity ...- p.108 .; Kislyakov N.A. Marriage rites and ceremonies ... - p. 134 .; Ashirov A. Ancient beliefs and rituals of the Uzbek people ...- p.95.
8. Mardonova A. Wedding celebrations in the Tajik Faizabad. // History and ethnography of the peoples of Central Asia. Monday, Donish. 1981.-p.117.
9. Field records, Khazarbog village, Denau district. 2020.
10. Field records, Sairak and Marmun villages, Altynsay region. 2020.
11. Field records, Khazarbog village, Denau district. 2020.

12. Karmysheva B.Kh. Uzbeks-Lokays of southern Tajikistan ...- p.140.
13. Field records, villages Chilanzar, Shurob, Boysun region. 2020.
14. Field records, Lailagon village, Sherabad region. 2021.
15. Field records, Akkurgan village, Jarkurgan region. 2021.
16. Field records, Besherkak village of Baysun region, Khufor village of Sariosiyo region, Nilu village. 2020.
17. Field records, Muzrobot village, Muzrabot region. 2020.
18. Karmysheva B.Kh. Arksaic symbolism in the funeral and memorial rituals of the Uzbeks of Fergana. // Ancient rituals of belief and culture of the peoples of Central Asia. M. Nauka, 1986.-p.161.
19. Field records, Khojaulkan village, Sherabad region. 2021.
20. Field notes, Sherabad. 2021.
21. Tursunov S.N. Wine. Uzbek named after A. Navoi Mil. library T.2006.-p.66.
22. Field records, Hamkon village, Sherabad region. 2021.
23. Ashirov A. Some comments on the genesis of traditional wedding ceremonies ... p.42.
24. Field notes, Gozimulla village, Bandikhan district. 2021.
25. Ashirov A. Some considerations regarding the origin of traditional wedding ceremonies ... p.41.



**ACADEMICIA**  
**An International**  
**Multidisciplinary**  
**Research Journal**  
 (Double Blind Refereed & Peer Reviewed Journal)



**DOI: 10.5958/2249-7137.2021.01328.8**

## NAMES OF THE INHABITED LOCALITIES OF THE TAKHTAKUPYR DISTRICT

**Akmaral Sakhratdinovna Serikbaeva\***

\*Assistant Teacher,  
 Department of Kazakh Language and Literature,  
 Karakalpak State University,  
 UZBEKISTAN

### ABSTRACT

*This article is devoted to the oikonyms of the Takhtakupyr region. Takhtakupyroikonyms are formed from ethnonyms: 1) oikonyms, formed from Karakalpak clans; 2) oikonyms, formed from Kazakh clans; There are also oikonyms formed from numerals and adjectives. Information about the reason for the name of the Takhtakupyr region, Borshitau and the Karaterenlake is given.*

**KEYWORDS:** *Toponym, Oikonym, Genealogy, Village, Anthroponym, Ethnotoponym.*

### INTRODUCTION

The formation of toponyms in the Takhtakupyr region has a separate history. Toponyms of the Takhtakupyr region, with a 90-year history, seem to be an interesting topic for researchers because until today the name of the region, localities, water bodies have not been fully explored. The Oikonyms of the region keep the secret of a century-old history in their names.

The Takhtakupyr region is located in the southeastern part of the Republic of Karakalpakstan along a large road leading to the neighboring Kazakhstan Republic. In the west it borders on the Karauzyak region, in the north-west with the Muynak region, in the north-west and southeast with the Republic of Kazakhstan, in the south-eastern part with Yellikkala, in the south with the Beruni region.

The history of the origin of the toponym of the Takhtakupyr region is associated with the construction of a wooden bridge, in other words, the construction of a bridge made of wood. The bridge was commissioned in 1904. In those years, the location of the Takhtakupyr region was a large road connecting with Khiva, Urgench, Kungrad, Khojeyli, Turtkul and Chimbay for merchants going with a caravan. They went through Takhtakupyr to the cities of Kazaly and Kyzylorda in Kazakhstan. The merchants of these cities passed through this Takhtakupir. The



caravan passed along the shallow lake "Bosayozek" (the current name is "Kuuanyshzharma"), since then there was no bridge. Residents communicated by building a small boat out of black willow on both sides of the coast. During these years, there were many people who came for permanent residence; the eastern and western parts of the lake were led by KhozhametBols (volost). In 1903, under the leadership of KhozhametBols, residents of both banks built a bridge across the lake. Thus, the construction of a wooden bridge over Lake Bosayosek was a great historical event. Since that time, the people called the name of this area TakhtayKopir - Takhtakopir [1].

The Takhtakupyr region was organized in 1928. Although 90 years have passed since then, it has not lost its name and is one of the leading regions of the republic.

### **Main Part**

Knowledge of the history of the origin of localities and reservoirs is interesting to everyone. Especially the study of the history of the origin of the name of one's place of birth, the disclosure of the meaning of each name reinforces the patriotic feeling towards the native land. The name of the localities and reservoirs of the Republic of Karakalpakstan, including the Takhtakupyr district, in other words, toponyms reveals the secrets of the centuries-old history of the people. So, having information about the economy, about the way of existence, according to the toponyms of a certain area, one can talk about the history of the descendants located in this area.

In onomastics, oikonomia is a general set of names for localities (settlements). Oikonyms are considered one of the types of toponyms like the history of people, society. They appear for various reasons, i.e. they have a peculiar history. Each oikonym is a fruit of its time; they were born in connection with historical events. Although the time of the appearance of the oikonyms is not indicated, signs of that time can be seen in their contents. It can be seen by its meaning and structure. Based on the teaching of history, it can be noted that the history of the appearance of toponyms is directly related to historical periods. The study of oikonyms is of particular importance.

In connection with gaining independence, oikonyms and large physical and geographical names of the republic are transformed and many of them acquire new names.

The toponymic system of any region has been created over many centuries. The history of the people is reflected in the language. Each name is history, and place names can be called a mirror of history. If the meaning of each name, a long history, the mystery of birth - if we fully prove everything, then certainly everyone seeks to know this. Similar to this, there is a history of the name of the Karaterenlake, which we want to tell about.

Lake "Karateren" located in the village of Borshitau, Takhtakupyr region of the Republic of Karakalpakstan, for centuries fed the people with its fish: carp, catfish.

They say that earlier there was a padishakhstvo (state) under the lake. This area could not be conquered by any enemy. Since the padishahism was located in the lowland, which was surrounded on four sides by a straight cliff, the enemies could not go down. The padishah of this area was very smart and took care of the people. Because of the love (of the shepherd bakhtashi) of the daughter of the padishah, the city remained under water. When the lovers barely got out of the water and ran away along the shore of Lake Borshitau, a stone falls on them from the mountain, and the lovers remain under the stone. The population was drowned by water and the

padishakhism remained under water. Those who managed to escape from the flood remained alive, and those who did not have time remained under water. In order to achieve the love of one, he destroyed an entire population.

Until now, on the slopes of "Borshitau" there is a tombstone for two lovers.

The name "Karateren" (Black depth) comes from the reason that the sun's rays and the feet of mankind do not reach the bottom of the lake; therefore, so far, what is at the bottom of the lake due to the depth remains a mystery.

Another characteristic feature of the names of localities in the Takhtakupyr region is the wide distribution of oikonyms, named after various clans and tribes, as well as nationalities.

Most of the population of the region are Karakalpaks and Kazakhs. Therefore, there are more oikonyms in the region, formed from the generic names of the two nationalities.

Annaul is a village in the Karateren region. Anna is one of the clans of the Karakalpaks.

Bessaryaul is a settlement of the region on the territory of Atakol and Karaoi.

Kepeaul is a village of the district in the territory of Atakol.

Kanzhigalyaul is a village located at a distance of 10 km from the district.

Kanlyaul is a village in the region inhabited by Karaoi. People of Karakalpak clans live in this village.

Karamoynaul is a village located on the territory of the settlement of the Takhtakupyr and Karateren regions.

Kypshakaul is a village in the settlement of Karaoi district.

Muytenaul is a village located on the territory of the settlements Karaoi and Karateren of the region.

Shalzhuhtaul is a village in the settlement of Karateren. Shalzhyuyt is one of the clans of the Karakalpaks.

Shomishliaul is a village of the Atakol settlement. Shomishli is one of the clans of the Karakalpaks.

Yrgaklyaul is a village located in the territory of the settlement of Karaoi district.

Zhakayimaul is a village located in the village of Mulik. Zhakaim is one of the clans of Kazakhs. It was named because the people of the Jacaim clan lived for a long time.

Kazakaul is a village in the settlement of Takhtakupyr. The village is so named because there were many Kazakhs here.

Karasakalaul is a village located in the village of Mulik. Karasakal is one of the clans of Kazakhs.

Tolengitaul is a village of the fourth village. Tolengit is one of the clans of Kazakhs.

Khojaaul is a village located in the village of Mulik. I go one of the families of Kazakhs.

Shomekeyaul is a village located in the settlement of Mulik district. Shomekey is one of the clans of Kazakhs.

In the study of oikonyms, named by the name of the genus groups, it turned out that the name comes from the names of the representatives of those genera that make up the majority.

With the internal classification of oikonyms on the territory of the Takhtakupyr region, along with ethnonyms, there are oikonyms named in connection with the species, numeral anthroponyms.

Anthroponyms and place names are very closely related. The semantic basis and methods of education are similar [2].

Borshitau is a settlement located in the north of the Takhtakupyr region.

Early times between Khiva and Kyzyl kum were the cities of Kyzyl kala and Dugisken, which were unmatched. There was a road crossing the endless sands of Kyzyl Kum (Red Sand) in the northern part of Karataua, which is the intersection of nine roads and the center of trade. Kyzyl-kala was a resting place for merchants. Having sold salt, loaded onto camels, exchanging goods, returning the caravan, led by Baray, unexpectedly stumbles upon a magnificent place. On one side the lake is like a sea, on the other side there is a hill like a blackish ram. They, dropping camels to their knees, just wanted to rest a little when they suddenly heard a crying child's voice from the side of the mountain (hill). Then, after making a fire in different places, they start looking for a child. At dawn, they find a gray wolf (bori) in a den of a gray wolf (bori), a very tired and dying child of about two months old. A child found in a gray wolf's den is called Borshi. The big hill where the child was found turns out to be a caring one who has a brand (seal) in the history of a noble mountain. They say people named their first-borns Borshi and this area Borshitauy (mountain Borshi). It is also said that to this day one can sometimes hear the cry of a child and the howl of a wolf at the foot of the mountain.

Akishtam - this area is located in the village of Kungradkol and is considered anoikonym named after a person. It was named in connection with the name of the person Akysh.

Atakol - located in the village of Atakol. According to information, an old-timer named Ata lived on the shore of the lake. Therefore, atanynkoli (grandfather's lake) is called Atakol.

Balkiaul - located in the settlement of the Karaoi region. It was named in connection with the name of the girl Balka.

Daukara - on the land of Takhtakupyr there was a settlement called "Daukarazherleri" (the land of Daukar). According to oral folk art, Daukar is the son of Chimbay [1].

Dautsay is an oikonym located in a district in the village of Mulik.

Adilaul is a village located in the territory of the Atakol settlement. Reportedly it was named after an old man, Adil.

Kayypaul is a village located in the village of Takhtakupyr. It was named for the man Kaip.

Pirniyazaul - located in the village of Takhtakupyr. It was named after PirniyazSultanov, the head of the farm.

Rametaul is a village, a settlement of the Takhtakupyr region. It was named after the name of Brigadier Ramet.

Turmanaul is a village in the Takhtakupyr region. It was named for the old man Thurman.

Khozhametaul is located in the village of Atakol district. It was named after KhozhametBolysa, who supervised the construction of the wooden bridge.

Shanghai is a village located in the settlement of Marzhankol district. Previously, the sunflower was grown here by a man nicknamed Shanghai of Korean origin.

Oikonyms derived from numerals:

Birinshiaul is a village located in the village of Takhtakupyr. The name of this village is named for the reason that it was seen first among the villages located one after the other.

Kyryktesik is a village located in the settlement of Karateren district. It was named after the name of the house with a forty hole.

Jeti to communicate is a village located in the village of Takhtakupyr. It was named after the name of the hostel built for the newlyweds.

Tortinshiaul is a village located in the west of the village of Zhanadarya district. The name of this village was named for the reason that it was seen as the fourth among the villages located one after the other.

Oikonyms named in connection with the species:

Akkesekaul is a village located in the village of Takhtakupyr. It was named after the name of the white earth of the soil.

Akkol is a village located at a distance of 10 km from the settlement of Takhtakupyr. There are several information about the name Akkol: 1) Due to the salinity of the lake, which can be seen from afar as white; 2) By the name of a person who moved here from the Aktobe region of Kazakhstan from the Tortkar clan.

Karaagash is a village located in the village of Takhtakupyr. There is a black electric pole at the entrance to the village. The name of the village is associated with this pillar.

Karaoi is a village located in the village of Takhtakupyr. If you look at this place from afar, this place looks like a black lowland. According to one more data, i.e. in the work of Hikmetulla Ayymbetov entitled "Takhtakupyr at a greater crossroads" the name goes back to the trees and forests, which can be seen from afar as a black fog.

Karateren is a settlement named after the name of the Karaterenlake, located on the territory of the Takhtakupyr region.

Kungradkol is a settlement named after the name of the lake, located in the Kungrad region.

Zhanadarya is a village named after the name of the river, located in the Takhtakupyr region.

Oikonyms named in connection with their appearance:

Makpalkol is a settlement named for the beautiful, velvet-like view of the lake. The name of the lake became the name of the village.

Marzhankol - in connection with this name there are several oral folk arts: 1) In connection with the transparency of the lake water as marzhan-coral; 2) The harvest of rice obtained on this land gave a bountiful harvest as marzhan-coral, in this connection the village was named.

Kumaul is a village located in the village of Marzhankol. Since the village is located at the foot of the sand, it is named so.

Oikonyms associated with plant names:

Pishenkol - a lot of reeds grew on the shore of the lake, a person passing through this area had to bend the upper part of the reeds. Currently, this lake does not exist; the area located at the bottom of the dried lake is called Pishenkolauls.

Kendirli is a village located in the village of Kungradkol. The origin of the name is due to the fact that a lot of kendyr (hemp) used to grow here and in connection with this plant the village was named.

Jidelik is a village located at a distance of 8 km from the Takhtakupyr region. There grew a lot of zhiyde and a village named with the name of this plant.

Mulik - the name of this population is associated with the action of Kospanbatyr, who guarded this village saying "this is my people, my property" mulk-property and in this connection the village was named. At the foot of the village is Kospankum (Kospan sands).

## CONCLUSION

It is no accident that they say that "the name of lands and reservoirs is a letter of history." The topic of toponyms in which language was not necessarily indicates its relation to the geographical environment and nature. This means that the history of the names of toponyms provides linguistic and geographical information.

## REFERENCES

- [1] Abdimuratov K (1965). *Nege send atalgan?*, Nukus.
- [2] Januzak T. (2006). *Kazakh onomasticases*. Vol. 1, Alma-Ata.
- [3] Rasuljanovna, I. N. (2019). THE PHENOMENON OF LACUNARITY AS THE LINGUACULTURAL ISSUE. *PROSPECTS OF WORLD SCIENCE-2019*, 226.
- [4] Ashiralievich, V. A., & Vasilovna, M. K. (2020). The interactive means of learning oriental languages. *Asian Journal of Multidimensional Research (AJMR)*, 9(3), 78-86.

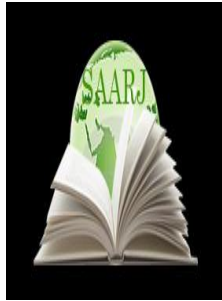

**ACADEMICIA**  
**An International  
 Multidisciplinary  
 Research Journal**  
 (Double Blind Refereed & Peer Reviewed Journal)



**DOI: 10.5958/2249-7137.2021.01329.X**

## THE EFFECT OF APPLYING THE ADVANTAGES OF THE INFOGRAPHIC FORMAT IN THE PROCESS OF MEDIA LITERACY EDUCATION

**Hilola Ibragimova\***

\*A second level Independent Researcher,  
 Uzbek University of Journalism and Mass Communications,  
 UZBEKISTAN

### ABSTRACT

*It should also be noted that teaching the new generation in the old way does not justify itself; therefore, the textbook content of this generation should be supplemented with various anthologies, laboratory workshops, a set of assignments, multimedia resources and other innovative technologies, in addition to “teaching just to read”. Infographics are also a fairly effective format in these processes. This article describes in detail the methods and effectiveness of the use of info graphics in the process of media literacy education.*

**KEYWORDS:** *Media, Media Literacy Education, Infographics, UNESCO, Oxford Encyclopedia, Electronic Media, Mass Media, Digital Media, “Ted Talks”, “Data Redrawing”, QR-Code, “History Of The World”, DELL Company.*

### INTRODUCTION

The world today cannot be imagined without the media. The media plays a special role in human life. Whereas in the past people used to wake up, wash, sit at a table and read a newspaper or get information on the radio and television, now we dive into the information space through gadgets before we even have time to open our eyes. Every second new piece of information arrives. We have a phone, a tablet, a TV in our house, a radio in our car, a computer in our office, all of which does not allow us to be disconnected from the media world, even if only for a little while. Today we have become the inhabitants of the “media island” and we can’t even imagine that there could be a different life outside of this island; and we can’t imagine living without the media.

## The Main Part

"Media" is derived from the Latin word "media", which means 'middle ground' or 'intermediate', more precisely "common information intermediary".

As it developed, the media has made people's lives easier, and began to satisfy the demand for information in any way; it began to play an important role not only in the form of information but also in the formation of knowledge and skills. At the same time, the proliferation of information channels, in particular the emergence of the Internet and the freedom to disseminate information on it, have brought out the formation of citizen journalism as a factor play an important role in society; this has made it necessary for people, especially young people and children, to develop the ability to select and analyze data, to distinguish reliable and accurate information. It is on the basis of this task that a new concept of media literacy education has emerged.

The main stage in the development of media literacy education dates back to the end of the last century. During this period, a very convenient and fast channel of information transmission, the Internet and mobile phones, developed. Such factors as democracy and the convenience of mass communication, the difficulty of controlling this situation by the state or other organizations, the popularity of technology devices began to affect the social and economic life in communities.

According to the Oxford Encyclopedia, "Media literacy is the study of the media. Media literacy education is linked to the media texts being created and disseminated. It develops the ability of learners to analyze to interpret and evaluate the content of media texts. The study of media is usually done in a practical way, i. e. in connection with the creation of media texts. Media literacy education serves to increase media literacy through the study of the media."<sup>1</sup>

UNESCO defines media literacy education as follows: media literacy education is the study of the theory and practice of knowledge in modern media.<sup>2</sup>

In 1982, UNESCO adopted the Declaration on Media Literacy Education. According to this, "Media literacy education is closely linked with all types of media (print, graphics, audio, screen, etc.) and various media technologies. It educates people on skills such as understanding how to use mass communication in the social consciousness, mastering the ability to use the media while communicating with other people.

The word "media literacy education" first appeared in the territory of the CIS in the 80s of the last century. Although this concept has not been widely used in Uzbekistan, there have been various opinions and researches on media literacy education. In particular, in the dissertation of Sh. T. Khalilova, defended at the Uzbek State University of World Languages in 2001 on "Pedagogical conditions for the use of mass media in the moral and aesthetic education of students" (on the example of Uzbek radio broadcasts), the establishment of a radio studio at school, the organization of trainings "Young Orators", "Young Correspondents", as a result of which students raised the issues of listening to the media, including radio and active participation in it, the formation of knowledge, skills and abilities. Similarly, K. A. Farfiyeva's dissertation on "Peculiarities of the formation of social perceptions in students under the influence of the media" (on the example of television), defended at the National University of Uzbekistan named after MirzoUlugbek, studied the influence of the media on public opinion.

Clearly, the concept of media literacy education is broad; its definition is not limited just to the knowledge that shapes the ability to use the media. A. A. Jurin defined this concept within three categories:<sup>3</sup>

1. A pedagogical subject that studies and teaches the impact of the media on children and adolescents and develops theoretical issues, preparing students for an encounter with the world of the media.
2. A joint practical activity of teachers and students, preparing children and adolescents to use the media, to understand the role of the media in the world.
3. A part of education that provides knowledge about the role of the media in understanding the world and its cultures and develops the ability to work effectively with media information.

The breadth of the concept of media literacy education, which also includes the educational nature of the media, can be seen through its directions. Russian scientist A. Fedorov, who has studied media literacy education in depth, divides media literacy education into the following main areas (perceptions):

1. Media literacy education prepares future professionals for the world of press, radio, television, cinema, video and the Internet - journalists, editors, directors, producers, actors, cameramen and others.
2. Media literacy education prepares future teachers who conduct media culture courses in educational institutions.
3. Media literacy education is a part of general education of pupils and students studying in schools, secondary specials, (vocational) institutions, higher educational institutions or independently functioning centers (special, voluntary, circle, etc.).
4. Media literacy education in other educational establishments and centers that organize meaningful leisure time of students (houses of culture, extracurricular activities, aesthetic and artistic education, clubs in the community).
5. Distance learning for adults, students and pupils using the press, television, video, DVD, Internet.
6. Independent, continuous media education. (This direction is theoretically practiced throughout an individual's life).

From the aforementioned considerations, it can be clearly seen how important the media literacy education is. In a sense, media literacy education helps the public to keep pace with the times, with the news in the media. Because of this, media literacy education itself should be transmitted to students and the audience in new, modern formats. Therefore, through research, we will look at how effective the new format – the infographics can be in media literacy education.

Medialogists studied media and media technologies and conditionally divided them into 5 types.

1. The first media is writing.
2. Print media - printed publications, lithography, and photography.
3. Electrical media - telegraph, telephone, voice recording.



4. Mass media - cinema, television.

5. Digital media - computer, the Internet.<sup>4</sup>

The latest generation media types, such as television and then the Internet, have reached an audience faster than their predecessors. Many researchers point to visualization as the reason for this. Indeed, visuality is one of the most important elements of resource attraction.

Because of their visuality, Infographics have become one of the best formats of communication today, as well as their ability to present information in a concise, brief, meaningful way, that's, in an exact way that an individual wants to express a thought or an idea.

## RESULTS AND DISCUSSIONS

Dividing the use of infographic into media education into two categories can help to shed light on the topic more clearly and comprehensibly. In media literacy education, infographics can be used both in teaching media and in transmitting knowledge through the media.

In teaching media literacy, it is possible to use infographics as a practical task for students in explaining media topics and creating textbooks on media literacy education.

Today's students' attitudes and requirements for the acquisition of knowledge and skills have changed significantly; unlike the previous generations, today's students get bored of "dry" texts quickly and can't just hold their attention by using only these materials. According to research: A large part of the human brain provides the capacity to process visual data – the ability to see. In fact, 50% of the brain depends on the function of receiving information through vision.<sup>5</sup>

Experimental practices also confirm that the brain sees and absorbs the most basic information via visual sources. It is only natural therefore, that the saying: "a picture is worth thousand words" is common.

"An ordinary person can remember seven numbers in a sequence, " said Webster. "But this person can also remember a thousand numbers in a sequence if the figures are presented in the form of a line graph."<sup>6</sup>

Therefore, the use of infographic materials in future media lessons will help to attract the attention of the student. It also enhances the ability to understand infographics in the media.

The article "Infographics in training" on the site synergycorp.ru provides the following claim on the use of infographics in the teaching process: "Training courses created with the help of infographics meet several important requirements simultaneously: they train the student to absorb the maximum amount of information in a short period of time, to demonstrate freedom during the lesson, and to develop memory and visual perception without experiencing boring 'squeezing'."<sup>7</sup>

While the information in the infographics is easy to retrieve, it requires the learner to concentrate well on the visuals provided. Without this, the information given in some types of infographics cannot be easily assimilated. For example, the infographic "Extinct and Fossilized" in the book "History of the World"<sup>8</sup> contains a lot of information. If this information was given in a text form, it would be at least 3 to 4 pages in length, in which a few pictures would have need necessary to accompany the text. This would have made it difficult for the reader to form an imagination. The learner would have to blindly assimilate this information. In the

aforementioned infographic, however, the reader searches for each piece of information on his or her own. He looks at the period, tries to analyze the type of animal, its structure, and how it differs from the animals before and after it. This ensures that the information the reader receives is well stored in memory. At the same time, the student develops the ability to analyze the information provided.

Practice has also confirmed that infographics are effective in the learning process and give a number of positive results. For example, Gary Rob Lamb and his colleagues talked about how to add infographics to science education in high school. First of all, their main goal was to form information literacy in the process of teaching graphical data representation. Infographics have been used in a variety of activities (e.g., “reading aloud and thinking”, “data redrawing”) and in presenting own projects by high school students. In particular, in a “reading aloud and thinking” lessons, teachers will display infographic materials and explain how to read the data, interpret their meaning, and understand the message contained (hidden meaning). In a “data redrawing” class, students will be able to visualize the ideas they see.<sup>9</sup>

Indeed, infographic preparation can also be used in the educational process as a separate pedagogical technique. We know that the "cluster" method is widely used among pedagogical techniques. Creating infographics can be seen as an improved version of the cluster method. In this case, the teacher with students can prepare an infographic in the form of a seminar based on the topic.

Infographics can also be given as a special assignment for students. However, first of all, it is necessary to explain to students the essence of infographics, its difference from ordinary visualization. It is not just an image given as a form of information such as visualization, but it carries additional information. In order to work infographically independently, first of all, it is necessary to study the topic in the textbook in depth. This prevents the student from merely doing a superficial study of the subject. Then the idea of infographics is considered. This helps to enrich the reader’s imagination. Often in hopes that students can master the topics well, the teachers ask students to take notes of the topics.

Teachers often claim that taking notes is equivalent to reading a book three times. In contrast, creating infographics requires students to work on the topic in the same way as they read it 30-40 times. They worry about how to present each piece of information on the topic. This allows one to re-read the information and think about it relentlessly, so that no information is neglected in the preparation of the infographic, which certainly leads to the desired outcome that the reader fully masters the topic.

In the West, even in ordinary schools, teaching using infographics has become commonplace, says the article "Infographics in training" on synergycorp.ru. The article also contains the following sentences. “DELL has conducted research among students and faculty at universities in the United States, China, and Germany. The results showed that 9 out of 10 respondents said that the use of infographics in the course would increase its effectiveness. Eighty-two percent of respondents said it would be better to use these technologies more than they do today.”<sup>10</sup>

The important role that the infographics play in the process of media literacy education is well reflected in and confirmed by the opinions of Canadian scientists. According to them, “Giving assignments on infographics can greatly inspire students to make a good use of all the communicative skills without a direct help of a teacher. It's also a real exercise in digital

communication skills.” According to the researchers, this is content formation and content production. In the preparation of infographics, the ability to critically analyze the content of information (or content analysis), to identify the characteristics and needs of the audience, and to design the message is developed. All of this enhances the level of professional communication skills in any field.”<sup>11</sup>

Another senior class teacher who uses infographics in her classes, Carissa Peck of California, says that she instructs her students to prepare infographics as an alternative to traditional essays. She also asks the students to analyze each other’s infographics at the end of the lesson, sometimes noting that several infographics are combined and generalized.

There are also a number of advantages to using infographics in textbooks.

With infographics, the textbook will have a colorful and unusual look. “The brain is designed to receive what sets it apart from others. We think of the brain as a computer’s hard drive. For it to work actively and efficiently, the memory must not be filled to capacity. To fully maintain optimal speed, the brain filters all the information that enters and as soon as it receives the information, it removes about 99% of the information from the sensory organs. The main criterion in this selection is that the information received is different from the information normally received by the brain before. The brain’s attention is drawn to new and unusual things.”<sup>12</sup>

## CONCLUSION

Infographics is a format that meets the needs of the modern audience. In today's information age, it is considered very difficult for people to obtain textual information, especially when the material contains large amounts of it. Now, despite the level of interest the information appears to generate, most people become bored of it after reading the first few pages, and most of these people do not make the effort to read the information to the end or go to the end without reading the information in the middle. Scientific experiments have proven that it is possible to hold a person's attention for only 10 minutes, regardless of how interesting the material can be.

Infographics help to obtain and absorb pieces of information easily. Also, pictorial information is received faster and easier than text. “Every letter in a word is a symbol. To read a text, the brain must first unravel the shape and sound of the letters stored in memory one by one. Then the sounds in the brain are connected and imagined how the word is formed. It is necessary to draw conclusions by imagining how the sentence is formed after the words, then the paragraphs are formed, and the content of the general text. Although this process takes place within a few seconds, if we compare it with the process of image reception, it is observed that in the textual form, there is more mental strain. Therefore, using infographics, in a sense, can physically simplify the understanding and reception of the information for the audience.”<sup>13</sup>

Because infographics present the information clearly and concisely, the process can prevent possible misunderstandings and misconceptions from arising. To put it simply, for example a word of apple does not describe what it looks like (in most cases, it is a general word without a specific detail or details; In fact, it is not possible to interpret every object. ) Because only the word itself is presented, everyone sees an apple of a different shape and color. In contrast, when the object is presented in the infographic, because the author's image is illustrated rather than stated, the audience gets the same image as the author is imagining.

It also has the advantage of firmly storing the data in the brain and of long-term storage of it there. 70-90% of image information is stored in human memory. This also prevents the books from becoming too extended or bulky.

Infographics can also play an important role in predicting longevity in media literacy education processes. Because it is able to store large amounts of information, it enriches them in school textbooks with information learned in previous classes, allowing the student to constantly revisit even old topics.

For example, in the literature on media literacy education, the presentation of chronological infographics about the stages of media formation, video infographics about media types, or interactive infographics allows the reader to get better acquainted with the world of media.

Just as infographics can be used in all fields, it can also be used in all science textbooks. We also know that today textbooks provide links using QR-codes, in which way readers are given a possible view of the infographic on a topic in the textbook or a video infographic on the infographic itself. This will help the reader to take an interest in the subject and learn more about it.

Textbooks can be used to prepare infographics on each topic or on large general chapters. That is, on the basis of information on each topic separately and combining them into a larger chapter.

The same applies to infographics for electronic textbooks. It is known that an e-book read with the help of gadgets quickly tires the eye. Therefore, they should be designed to be quick and easy to accept. They are also created to avoid large volumes of text. In this regard, infographics are useful in electronic textbooks.

In printed publications, it is possible to use mainly simple types of infographics. If we look at foreign textbooks, most of them are “ted talks” (video lectures of famous and smart people) or various videos in the form of audio and video are put on the book on the disc. In this way, video infographics can be presented in addition to printed publications. This means that simple and video infographics can be used in printed textbooks.

In e-textbooks, it is possible to combine simple, click infographics, if the book is intended for online use, in which case it can be both interactively and through the possibility of transition to video infographics.

Because of this specific feature, infographics are useful in all respects for media literacy education processes; in fact, enriching the media literacy education processes as well as the textbooks with modern materials is the main factor in determining the effectiveness of those processes and text books.

## REFERENCES

1. Dorr, A. (2001) Media Literacy. In: International Encyclopedia of the Social & Behavioral Sciences. Vol. 14 / Eds. N. J. Smelser&P. B. Baltes. Oxford, 2001
2. UNESCO, 1984. Media education. Paris: UNESCO.
3. Zhurin A. A. Integration of media education with the course of chemistry in secondary schools // Media Education. 2005. No. 1
4. DjumanovaSanobar. Media literacy education as a product of mass communication. Master's

dissertation. Tashkent. 2014

5. MIT website. MIT research – Brain Processing of Visual Information. (<http://newsoffice.mit.edu/1996/visualprocessing>)
6. Denise Grady. The Vision Thing: Mainly in the Brain. Discover magazine. (<http://discovermagazine.com/1993/jun/thevisionthingma227>)
7. Smikiklas M. The Power of Infographics. USA. Indiana: Indianapolis, 2014. – P. 31
8. <https://synergycorp.ru/articles/11/232/>
9. Dafelippo V., Ball D., The history of the world in infographics. Alpina Publisher, 2017
10. <https://venngage.com/blog/how-to-use-infographics-in-high-school-classrooms/>
11. Farfieva K. A. Social Media as a factor in formation of scientific thinking in youth. European Journal of Research and Reflection in Educational Sciences. Vol. 8 No. 10, 2020. – Pp. 52-56.
12. Farfieva, K. A. (2021). Theoretical Fundamentals Of Scientific And Innovative Thinking In Adolescents. *The American Journal of Social Science and Education Innovations*, 3(04), 431-437.

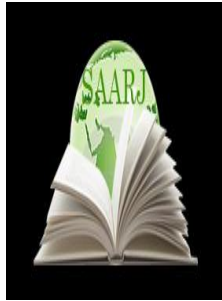

**ACADEMICIA**  
**An International**  
**Multidisciplinary**  
**Research Journal**  
(Double Blind Refereed & Peer Reviewed Journal)



DOI: **10.5958/2249-7137.2021.01330.6**

## **EFFECT OF TUMAT BIOSTIMULATOR ON AUTUMN GRAIN WHEAT YIELD AND ITS QUALITY**

**Muqumjon Yaqubjonovich Djurayev\***; **Ilyosbek Inomovich Usmonov\*\***;  
**Dilpuza Ergashboyevna Xoldarova\*\*\***

\*Senior Teacher,  
Doctor of Philosophy on Agricultural Sciences,  
Department of Plant Science,  
Andijan institute of agriculture and agro technologies,  
Andijan, UZBEKISTAN

\*\*Independent Researcher,  
Department of Plant Science,  
Andijan institute of agriculture and agro technologies,  
Andijan, UZBEKISTAN

\*\*\*Independent Researcher,  
Department of Plant Science,  
Andijan institute of agriculture and agro technologies,  
Andijan, UZBEKISTAN

### **ABSTRACT**

*According to the results of the study, 100 ml of winter wheat before sowing with the stimulator "Tumat" navigate Asr. It was observed that the germination rate increased by 10.4-10.6% per 1 ton of seeds during the processing stages of the plant. In the developmental phases, it increased the cold tolerance of crops in the cultivated area, accelerated plant metabolism, and resulted in plant growth and development at 57 quintals of grain per hectare, with an average yield of 2.6 quintals per hectare more than the control option.*

**KEYWORDS:** *Tomato, Winter Wheat, Accumulation Tube, Growth And Development, Harvest*

## INTRODUCTION

In order to increase the yield of grain in the country in recent years, it is recommended to treat it with various organic and biological additives. Great attention is paid to the use of substances that affect the growth and development of plants in the cultivation of abundant and high-quality products from agricultural crops.

These indicators are physiologically active substances, metabolic processes in plant ontogeny, in particular photosynthesis, respiration, enzyme activity, biosynthesis of amino acids, nucleic acids, proteins and phytohormones, metabolism, accumulation and distribution of nutrients, crop growth and development, formation of crop organs, are factors that can have a major positive impact on productivity and product quality. It is known that in order to accelerate the assimilation of phosphorus and potassium mineral fertilizers applied to crops by planting, nutrient suspension through the leaves accelerates the development of the plant root system and assimilation of nutrients due to expansion and thickening of the leaf surface.

**Results of the investigation.** Taking into account the above, the professors of the Andijan Institute of Agriculture and Agrotechnology on a trial basis conducted a new biostimulator "TUMAT", which allows to increase the resistance of winter wheat to diseases and insects, grain quality and high yields. The experiment was conducted in 2019-2020 on the allocated field experimental field of the farm "Sardor mirishkor" Andijan district in the variety of winter soft wheat "Asr".

The experiment was conducted in 4 variants, 4 repetitions.

1- variant control

2- variant 200 ml of Baikal stimulator is applied to 1 ton of seed wheat before sowing. was treated by mixing at the rate of 30 liters of working solution.

3-variant the stimulator "Tumat I" is applied to the plant during the vegetation and accumulation phases of the vegetation period at the rate of 1 l per hectare. processed.

4-variant the Tumat II stimulator is 200 ml per ton of seed grain. 1 l per hectare in the accumulation and tubing phases of the plant, treated in moderation. treated with a rod sprayer at the expense of.

In the comparison (standard) variant with Baikal biostimulator 200 ml per hectare. The seeds were processed into grain as well as during harvesting and threshing.

According to the analysis of the results of the observation of the 2019 experiment, in the control variant of germination and accumulation phases, 75% germination occurred on October 15, 75% accumulation phase on November 20. In the experimental variants, 75% germination occurred on October 20-25, in 3-4 variants, the accumulation phase occurred on November 10-15. The difference in control was 5-6 days.

Thus, when pre-sowing winter wheat was treated with Tumat I stimulator, the germination rate increased by 10.4-10.6%. During the developmental phases, it increased the frost resistance of the crops in the cultivated area, accelerated the metabolism in the plant, and created favorable conditions for the growth and development of the plant. In the experiment, the height of the winter wheat stalk was 22.8-23.6 cm in the control (unprocessed) and standard Baikal variants on

April 3, 2020, and 24.5-27 cm in the experiment with Tumat I. The next variant "Tumat II" is 28.2 cm when applied to the plant during sowing and harvesting before sowing, and in these variants it is 1.7–5.4 cm compared to control. was high.

When analyzing the length of the spike, the control variant was 7.6 cm, and the experimental Tumat I seed was 8.2 cm. The seed and vegetation period of "Tumat II" in the processed variant is 8.6 cm. was observed to be 0.6–1.0 cm longer than the control variant.

According to the results of the experiment, the following data were obtained when studying the effect of the biostimulator "Tumat" on grain yield.

Based on the results of the experiment, the following conclusions can be drawn to the production: In the conditions of light gray soils of Andijan region, before sowing of winter wheat with germinating seeds "Tumat I" at a rate of 1 l / ha, germination of seedlings 10.4-10.6 It was found in the experiment that the number of healthy seedlings from the winter increased by 61.2-67.1, with an increase in the level of resistance of grasses to external environmental conditions and diseases.

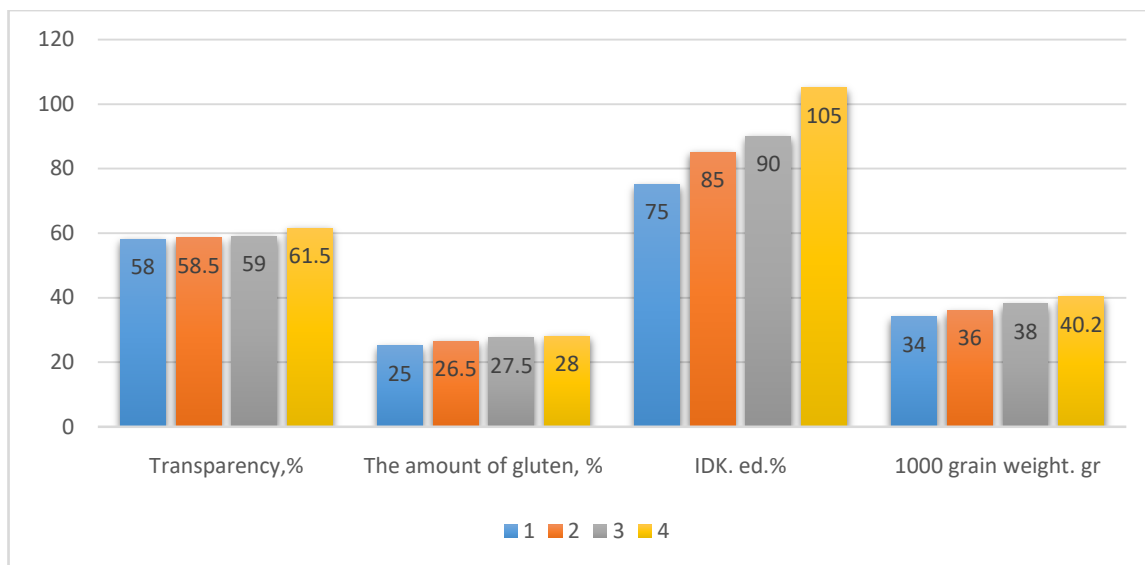

**Grain quality indicators on the variants of the experimental variety "Asr".**

## CONCLUSION

When the grain of winter wheat is inoculated with the stimulator "Tumat I" and processed in the phases of harvesting, tubing, the good development of the root system, plant growth and development is accelerated, the height of the stem is 1.7-5.4 cm and the length of the spike is 0.6-1. It was observed that it was higher than 0 cm.

Before sowing of winter wheat with the stimulator «Tumat II» 100 ml. For 1 ton of seeds, 57 quintals of grain per hectare was harvested during the harvesting stages of the plant, and an average of 2.6 quintals of additional grain per hectare was achieved compared to the control option.



Grain quality indicators revealed that grain transparency increased by 3.5%, gluten content by 3%, transparency in Baikal by 0.5%, gluten content by 1.5%, IDK in Baikal by 10% compared to control.

**REFERENCES:**

1. Djurayev M.YA., Ismatullayeva M., Asatullaev F., Vliyanie normy mineralnyx udobreniy i metodov poliva na biometricheskie pokazateli povtornyx posevov // Life Sciences and Agriculture elektronnyy nauchno-prakticheskiy journal Izdaetsya ejekvartalno s marta 2020. str.781 .
2. Djurayev M.YA., Atabayeva M., Hosilbekov J., Growth and development of Secondary crops in areas subject to Irrigation erosion // ACADEMICIA: An International Multidisciplinary Research Journal India, 2020-August, Issue 8, Vol. 10, pp: 466-469.
3. Djuraev M.Ya., Xoshimov I., Effektivnost metodov poliva povtornyx kultur v zemlyax, podverjennyx irrigatsionnoy erozii // Aktualnye problemy sovremennoy nauki zhurnali. Moscow, 2018 №4 p. 162-165. kent 2008.- №4(8). –p 26-28.

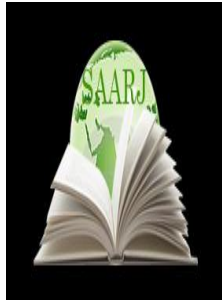

**ACADEMICIA**  
**An International**  
**Multidisciplinary**  
**Research Journal**  
 (Double Blind Refereed & Peer Reviewed Journal)



**DOI: 10.5958/2249-7137.2021.01331.8**

## BIO ECOLOGICAL PROPERTIES AND SIGNIFICANCE OF CALIFORNIA RED WORM

**Shohista Qobiljonovna Yuldasheva\*<sup>\*</sup>; Bekzodjon Ergashaliogli Soyibnazarov\*\*<sup>\*\*</sup>**

\*Professor of Biology,  
 Candidate of biological sciences,  
 Fergana State University, UZBEKISTAN

\*\*1<sup>st</sup> course in Master's degree,  
 Fergana State University, UZBEKISTAN

### ABSTRACT

*The California red earthworm was created as a result of hybridization of different breeds of earthworms in the Eiseniafoet. Red worms are suitable for domestic and industrial cultivation and are also used to feed poultry, fish, animals and fur animals. California worms have the ability to process food faster and more completely than ordinary earthworms. As a result of processing one ton of substrate, the growth of biomass of 600 kg of biohumus and worms reaches 100 kg. California red worms develop over a three-month period and reach sexual maturity. An important factor in their lives is a constant average temperature, humidity and adequate food.*

**KEYWORDS:** *California Red Worm, Anesthetic Species, Vermicompost, Biomass, Germofradite, Population, Biohumus, Substrate.*

### INTRODUCTION

Uzbekistan is a world leader in agricultural production. The production of this product in accordance with the needs of the population is growing every year. Earthworms make up the bulk of soil biomass. It is well known that earthworms play an important role in soil formation and maintaining its natural fertility.

There are thousands of species of earthworms, which are grouped into three categories according to their natural behavior and living conditions:

1. Anecic
2. Endogeic
3. Epigeic.

Anecic species — almost always build vertical holes to a depth of 1.5–2 m. They feed on organic matter fermented to a certain extent on the soil surface and turn it into humus. If anecic species are deprived of permanent habitat, then they cease to reproduce and grow. They play a very important role in soil formation. Their main species are *Lumbricus terrestris* and *Aporrectodea longa*.

*Aporrectodea* is used as an excellent bait for fish due to the size of the *longa*.

Species such as *Apodeodea caliginosa* feed on soils that are less saturated with organic matter, mineral particles of soil with high mineral content, and decomposed organic matter. As it moves through the soil, they mix it and ventilate it. It is also of great importance in enrichment with nutrients and microflora.

Epigeic species usually live in the organic matter-rich layers of the topsoil, under leaf clumps or rotten tree trunks.

They are exposed to climate change and predators. A typical representative of this class, known as the California red worm, is the *Eisenia foetida*.

Usually used for vermicomposting - mainly *Eisenia foetida* (California red earthworm) or *Eisenia andrei* worms.

This type of worm can be found in old manure or compost piles. Their distinctive feature is the red lines that are variable and clearly visible.

The red worm is suitable for domestic and industrial cultivation and is also used to feed poultry, fish, animals, and fur animals. When worm biomass is added to the feed, the feed value increases by 20-25%. Worms also contain 67% protein and 20% fat.

Of all the earthworms present in the world, only a few are suitable for artificial breeding.

However, according to their characteristics, the most economically viable species are worms belonging to the genus "Red Worms".

The red earthworm in California was created as a result of hybridization of different generations of earthworms in the *Eisenia foetida*. This generation was developed in 1959 at the University of California. It reaches a length of 10 cm, a diameter of 3 to 5 mm, and a body weight of up to 10 grams. 2 worms are capable of breeding up to 1.5 thousand per year. The new generation emerges in 21 days, and puberty occurs in 90-120 days. After 1.5 months, the worm population doubles.

California red worm - dark red, elongated, cylindrical, flattened on the abdomen and divided into pieces, each of which has two feathers. The weight of an adult worm is in the range of 0.2-1.0 g. Body temperature is 19-20 ° C. California worms are 4 times more fertile than "wild" earthworms.

It breeds 18-26 times a year, unlike its wild cousins, which breed only 4-6 times a year. Adults live 10-15 years.

California worms have unique characteristics:

- They live in a substrate saturated with organic compounds, not in the soil;
- Consumes twice as much food per day. Approximately 600 kg of vermicompost is obtained as a result of processing one ton of substrate, the increase in worm biomass is 100 kg;

A population of 1.5-2 thousand worms filled with 2-3 m<sup>3</sup> of compost can provide garden areas (3-4 hectares) with 2 tons of primary fertilizer.

California worms are hermaphroditic but cannot fertilize spontaneously. However, as a result of mutual fertilization of two earthworms, an egg or capsule is formed in each of them. After 14-21 days, depending on the air temperature, 2 to 20 worms emerge from each capsule or jar, and 20-21 worms can emerge when grown in a greenhouse.

California red worms develop over a three-month period and reach sexual maturity. An important factor in their lives is a constant average temperature, humidity and adequate food.

The number of young worms depends on the temperature in the habitat, but the sexual activity of these worms decreases in the cold months, reaches maximum productivity in the mild season, and decreases again in the warm months.

When the temperature is 19 to 20 ° C, the worms increase humus production and sexual activity. Extremely cold (0 ° C) and very hot (above 42 ° C) temperatures are dangerous for the life of California worms.

California earthworms love the heat. It weakens the instinct of self-preservation at low temperatures and therefore does not penetrate deep into the freezing depth when the habitat cools, but accumulates in large quantities and freezes safely. Therefore, this type of worm needs to be moved to a warm room in winter.

California earthworms have the ability to process food faster and more completely than ordinary earthworms. As a result of processing one ton of substrate, the growth of biomass of 600 kg of biohumus and worms reaches 100 kg.

Biogumus - (vermicompost) - obtained by processing of organic matter (manure, straw, leaves, silage waste, hay, food waste, meat, fruit and vegetable industry, utilities, poultry manure) by worms is a high molecular weight organic compound, rich in nutrients - a biological material that is sticky and odorless black and brown in color.

The worms mainly process the manure of farm animals in an environmentally friendly way, turning it into valuable humus.

Biogumus improves soil structure and its water-physical properties. Contains high amounts of water-soluble forms of nitrogen, phosphorus, potassium and other elements. The soil, together with biohumus, has the property of accelerating plant growth. Biohumus retains moisture up to 70%, which significantly reduces the amount of watering and protects against moisture during the dry period. Overdose of this organic fertilizer does not lead to negative consequences for plants.

Biogumus is widely used in fertilizing all types of crops, in floriculture, horticulture, soil regeneration, as well as in insect control.

California red worm is the most optimal solution for waste disposal, which allows you to get a natural organic fertilizer, vermicompost, which is able to regenerate even "dead soil".

Vermicompost is an organic waste processed by worms that passes through the stomach, changes, breaks down into amino acids and is saturated with vitamins, enzymes, macro- and micronutrients and other biologically active substances.

Comparison of the effects of vermicompost with organic fertilizers (humus and peat) showed that vermicompost is more effective than them. The addition of vermicompost increases the yield of beets by 27%, potatoes - by 19.7%, compared with humus.

Studies have shown that biohumus has a multifaceted positive effect on the agrochemical, physicochemical and biological properties of soils. Biohumus is absorbed directly by plants, where it accumulates large amounts of salt and trace elements, growth substances, vitamins, antibiotics, 18 different amino acids and beneficial microflora.

The chemical effect of biohumus is neutral.

Humus can be used for all crops due to the presence of a complex of nutrients. It serves as a new type of fertilizer, especially for those who require a balanced concentrated form of nutrients in terms of chemical composition.

Biohumus is an environmentally friendly organic fertilizer. Biohumus contains all the necessary nutrients, trace elements, enzymes, soil antibiotics, vitamins, growth hormones - in short, everything necessary for plant growth.

It has a biohumus-granular structure, which does not contain pathogenic microflora, helminth eggs, weed seeds. When incorporated into the soil, the development of processes specific to healthy soil is normalized. Biohumus is easily absorbed by plants during development. It also has properties such as moisture and hydrophilicity. This organic fertilizer is several times more than the humus-containing manure.

In short, biohumus: restores the natural fertility of the soil; binds heavy metals and radionuclides in the soil; prevents plants and soils from accumulating nitrates; provides strong immunity in plants; shortens the fertilization time of seeds; increases vitamin content; increases productivity by 1.5 times; improves plant growth and flowering; increases the diversity of tree leaves, flowers, lawn grasses and protects plants from drying out.

#### REFERENCES:

1. Abduraxmonov G; Tursunov L; Normuxammedov A. «Обоxygenumate и его применение в сельском хозяйстве Узбекистана». 2002.
2. Бовкун Г.Ф; Попкович Л.В; Трувеллер К.А; Мамеева В.Э. «Вермитехнология и селекция компостных червей на бряншине». 2002.
3. Битютский Н.П; Кудряшева Н.В; Соловеева дождевых червей на доступность микроэлементов растениям», 2004.
4. Винаров А.Ю., Семенов А.Ю., Ипатова Т.В., Эрина Т.Э. «Новая технология получения биоорганического удобрения», 2002.

5. Касатиков В.А., Касатикова СМ. «Действие вермикомпоста на агрохимические свойства почво" и уражайностселскохозяйственныхкультур», 2002.
6. Лукин СМ., Эрмакова Л.И. «Влияние систем землепользования на численност и биомассу дождевых червей в дерновоподзолистой супесчаной почве».2004.
7. Меер ВЖ. «Механизм контроляпопуляции компостного червя Eiseniafetida». 2004.
8. Симиненкова В.А., Петрова Г.В. «Биологические особенности красного калифорнийского гидрида дождевого червя в зависимости от плотности их засемнияорганосодержахих субстратов». 2002.
9. Терехенко П.В., Рохас Б.О. «Изменение биогумуса в зависимости от режимов храшния».2002.
10. Mavlonov O.M., Axmedov G.X. Tuproqzoologiyasi. - Toshkent: Universitet. 1992. - 78 b. 5
11. Rahmatullaev A.Yu., Mavlonov O.M.  
Yomgirchualchanglariningagrotsenzozlardavertikal tarqalishi. Fan, tibbiyotvatexnolog, jur.  
1999. Na3: 5-7.

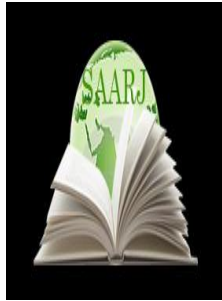

**ACADEMICIA**  
**An International**  
**Multidisciplinary**  
**Research Journal**  
 (Double Blind Refereed & Peer Reviewed Journal)



**DOI: 10.5958/2249-7137.2021.01332.X**

**TO THE QUESTION OF EVALUATION OF QUALITY INDICATORS OF  
 FUR PLATES FROM WASTE**

**Ergasheva N\*; Akhmedov B.B\*\*; Nigmatova F.U\*\*\*; Shomansurova M.Sh\*\*\*\*;  
 Galeeva A.R\*\*\*\*\***

\*PhD Student,  
 Tashkent Institute of Textile and Light Industry,  
 UZBEKISTAN

\*\*Associate Professor,  
 Tashkent Institute of Textile and Light Industry,  
 UZBEKISTAN

\*\*\*Professor,  
 Tashkent Institute of Textile and Light Industry,  
 UZBEKISTAN

\*\*\*\*Associate Professor,  
 Doctor of Philosophy in Technical Sciences,  
 Tashkent Institute of Textile and Light Industry  
 UZBEKISTAN

\*\*\*\*\*Master Student,  
 Tashkent Institute of Textile and Light Industry,  
 UZBEKISTAN

**ABSTRACT**

*The problem of processing and rational use of waste from leather and fur production in recent years has become especially urgent all over the world. The use of fur waste for the manufacture of products, a wide variety of fur waste and the resulting plates sets the task of determining their properties and conducting appropriate tests to predict quality indicators at the design stage.*

**KEYWORDS:** *Fur Production, Modular Design, Innovative Technologies, Resource-Saving Technologies, Karakul Breeding, Fur Haberdashery, Ornamental Composition, Leather Fabric.*

## INTRODUCTION

The problem of processing and rational use of waste from leather and fur production in recent years has become especially urgent all over the world. This is due to the fact that in the production process of natural leather and fur semi-finished products a significant amount of waste is generated, containing up to 50% protein substances and other by-products.

The efforts of manufacturers of fur and leather products are aimed at reducing material losses and rational use of waste. To do this, they plan to produce small leather goods, use patchwork technology, combined cutting according to rational layouts of patterns, use various types of equipment that provide low-waste cutting technology. However, it is not possible to achieve full utilization of waste. A significant part of them have not yet found application and are taken to dumps, which, in addition to material losses, leads to environmental pollution.

The main reason for the incomplete use of waste generated in the process of cutting fur semi-finished products and leather materials is that they have a complex irregular shape and are characterized by a wide variety in size and configuration. This is due to the type of semi-finished product, the configuration and size of the skins, their quality, cutting methods and other factors. Another feature that complicates the process of processing waste of fur semi-finished products (FSFP) and leather materials is their belonging to different topographic areas of skins. Depending on this, the waste has different indicators in terms of the degree of density and height of the hairline, the direction of the hair and the thickness of the skin tissue, which greatly complicates their use for the manufacture of high-quality products. As a result, more than 50% of natural fur waste at fur factories remains unused and is an important resource conservation reserve [1].

The use of FSFP waste in the manufacture of products, a wide variety of the latter and the resulting plates sets the task of determining their properties and conducting appropriate tests to predict quality indicators at the design stage.

The aim of the study is to increase the efficiency of using waste of fur semi-finished products generated in the manufacture of products from natural fur. The object of research is a fur flap and FSFP waste of various sizes.

## RESEARCH METHODOLOGY

Various methods of making fur skins and plates are currently known. The selection of the flap into the plates was made from homogeneous groups of fur, taking into account the requirements for fur clothing.

The traditional way of using FSFP waste for clothing is the manufacture of fur plates collected from the largest fragments of fur skins (mainly peripheral areas and inter-medical waste), the shape and size of which depend on the waste used. The flap of most of the semi-finished fur product is cut into pieces having various geometric shapes, as well as into lobe and transverse strips. In this case, the waste must be of high quality, with a uniform hairline, the direction of which must be taken into account when forming a fur plate.

A flap of the astrakhan-lambskin group is sorted according to the type of curl. Such a flap is cut into pieces of any shape. At the same time, defects of the scalp and skin tissue are removed. In this work, the manufacture of fur plates from the flap was carried out according to the traditional



method: sorting, cutting off and fitting the flap in size, stitching the strips into plates of specified sizes and shapes (rectangular, square, trapezoidal, etc.), moisturizing and straightening, leveling each row and eliminating wrinkles, drying and performing traditional finishing operations [2]. For the processing of fur waste, a flap of high-value parts of skins was taken: mink, muskrat, astrakhan and broadtail.

Strips of the largest possible size were cut from the furrier's flap and parts of the skins. Then the strips were connected to pieces of a skin flap 2,0 cm wide. chalk, measuring ruler, patterns, weight, and other tailor's tools by hand.

For a complete assessment of the quality of fur plates, it is important to reasonably select a set of quality indicators, not missing a single significant indicator, but at the same time not overloading the complex with insignificant ones, which could lead to an increase in the cost of the quality assessment process. When starting the choice of quality indicators, it is necessary to study their nomenclature and classifications in accordance with [3]. These standards provide a wide range of quality indicators (QI). However, the standards do not include the entire range of QIs, but only those that have a certain weight and meaning. When selecting, it is also necessary to take into account the indicators characterizing the purpose of future products and indicators (parameters) that affect the processing of raw materials. The comprehensive assessment methodology [4] provided for:

- Selection of the nomenclature of quality indicators of the evaluated products;
- Determination of the values of these quality indicators;
- Comparison of the values of the selected quality indicators of the evaluated products with the base ones.

The choice of quality indicators consisted of two stages:

- Preliminary selection of indicators;
- the final selection of a set of indicators.

As a result of the analysis of the literature and preliminary selection, the following set of QIs was obtained for a comprehensive assessment of the quality of fur plates from waste ( $X_i$ ):  $X_1$ -thickness,  $X_2$ -breaking load,  $X_3$ -breaking elongation,  $X_4$ -surface density,  $X_5$ -wear resistance,  $X_6$ -heat resistance,  $X_7$ -rigidity,  $X_8$ -air permeability,  $X_9$ -vapor permeability,  $X_{10}$ -drape,  $X_{11}$ -elasticity,  $X_{12}$ -softness,  $X_{13}$ -artistic and coloristic design,  $X_{14}$ -texture,  $X_{15}$ -mass,  $X_{16}$ -abrasion,  $X_{17}$ -deformability. [5] ...

For the selection of the most significant properties, the weight of the above QIs was established using the method of a priori ranking [5]. The expert assessment was carried out with the participation of leading specialists in the leather and fur industry and scientists working at the specialized departments of TITLI. The number of experts ( $n$ ) was 12, indicators of properties ( $m$ ) 17. The results of the questionnaire and their mathematical processing are shown in table 1.

The degree of expert agreement was assessed using the concordance coefficient  $W$  (1). The value of this coefficient can be in the range from 0 to 1. In our case, the calculated value of the coefficient of concordance was  $W = 0,62$ .

$$W = \frac{\sum_{i=1}^n (S_i - \bar{S})^2}{\frac{1}{12} m^2 (n^3 - n) - m \sum_{j=1}^m T_j} \quad (1)$$

The practice of conducting expert assessments of quality established the following ranks of qualification of the concordance coefficient:  $W = 0$  there is no consistency of expert opinions,  $W = 0,4 \dots 0,6$  is a significant connection, with  $W \geq 0,6$  there is a strong connection. Analysis of the results of evaluating the properties of fur plates showed that there is a significant connection between the opinions of the respondents, since  $W = 0,62$ . The experts' opinion is not accidental, since the calculated value of the Pearson- $\chi^2$  criterion at a significance level of 5%  $\chi^2 = 119,04$  is greater than the tabular value  $\chi^2_{\text{tab}} = 26,3$ , which is confirmed by the above figures.

**TABLE 1. MATRIX OF RANKS FOR ASSESSING THE QUALITY INDICATORS OF CANVASES FROM PMP WASTE**

Quality indicator number	Эксперты												$S_i$	Weight factors
	1	2	3	4	5	6	7	8	9	10	11	12		
1	11	14	14	14	10	11	11	11	10	10	10	11	137	0,0411
2	12	10	12	15	8	6	12	14	7	11	15	12	134	0,0429
3	3	3	2	3	11	1	2	3	5	6	3	3	45	0,0974
4	6	2	3	2	4	9	3	2	4	3	7	2	47	0,0962
5	15	5	4	9	14	2	5	5	8	5	8	5	85	0,0729
6	2	6	6	4	6	7	6	6	14	2	6	6	71	0,0815
7	10	8	8	10	13	10	10	4	15	12	14	10	124	0,049
8	14	15	9	8	5	8	8	8	9	13	13	8	118	0,0527
9	9	12	11	11	9	12	9	9	13	9	9	9	122	0,0502
10	1	1	10	12	7	4	7	12	1	1	2	7	65	0,0852
11	13	13	13	13	2	13	13	13	3	14	12	13	135	0,0423
12	4	9	7	5	1	5	4	10	6	7	5	4	67	0,0839
13	5	4	1	1	3	3	1	1	2	4	1	1	27	0,1085
14	7	11	16	7	15	15	14	16	11	16	16	14	158	0,0282
15	8	16	15	6	12	16	15	15		15	4	15	153	0,0313
16	16	7	5	16	16	17	17	7	12	8	11	17	149	0,0337
17	17	17	17	17	17	14	16	17	17	17	17	16	199	0,0031
$T_i$														
$\sum_{i=0}^n S_i = 0,6$ * 1)	153	153	153	153	153	153	153	153	153	153	153	153	1836	1

The results obtained allow us to make the following preliminary conclusion about the significance of the selected quality indicators. Seven quality indicators are significant and they are arranged in the following row in decreasing order of importance:

- 1) artistic color scheme -  $X_{13}$ ;
- 2) elongation -  $X_3$ ; [7].
- 3) surface density -  $X_4$ ; [8].
- 4) drape -  $X_{10}$ ; [9].
- 5) softness -  $X_{12}$ ; [10].
- 6) heat-shielding properties -  $X_6$ ; [11].
- 7) wear resistance -  $X_5$ . [12].

Figure 1 shows an a priori diagram of the quality indicators of fur plates, built on the basis of expert assessment data.

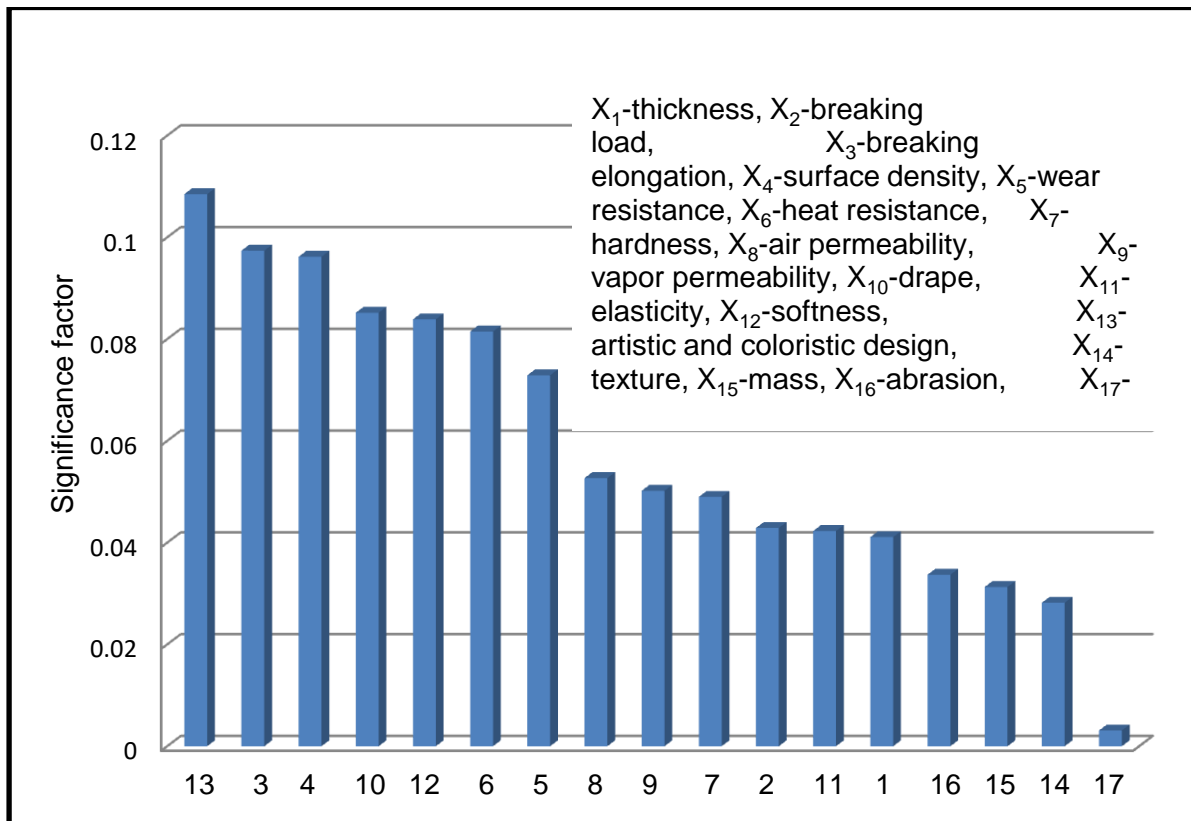

In the first place, the experts determined the aesthetic requirements of the materials made from the recruited fur flap, therefore, their artistic and coloristic design should be at a high level, and the products should be light and soft, which is indicated by the surface density and softness. Plates must meet modern fashion trends, provide expressive appearance, beauty and conformity to the consumer's appearance. Along with this, the elongation-plasticity of fur skins, which determine the quality of furrier production processes and the shape of the future product, are important for the considered plastinof FSFP waste.

When carrying out calculations, the relative weightings of significant indicators were also calculated.

In accordance with the selection of the QI nomenclature, to assess the quality of harvested fur plates from fur skins waste, experimental studies were carried out on various semi-finished products of FSFP. The following properties of the plates were experimentally determined: density, thickness, heat retention, mechanical properties and drape [13].

In accordance with the made choice of the nomenclature of QI of fur plates from waste, at the next stage of work, a comprehensive assessment of all working samples of fur plates was calculated. Considering that quality assessment is the first and main stage in the development and operation of the quality management system and clarification of the nomenclature of properties and QI products, an objective comprehensive assessment of the quality of experimental samples are the most important stages in organizing fur production, including in the manufacture of outerwear using fur waste. Since the experimental samples are intended for the top of the coat, they are used as the base QI material for the comparative assessment of waste in accordance with the recommendations of TsNIISHP [15]. selected woolen fabric with the following characteristics: elongation-23%, surface density-450g / m<sup>2</sup>, drape coefficient -65%. To convert the natural indicators of the quality of experimental samples into dimensionless, the following formula was applied:

$$Z_i = \frac{X_i}{X_{i\text{баз}}} \quad (2)$$

The data for calculating the definition of complex quality indicators are given in Table 2.

Таблица 2

Name of experimental samples	Quality indicators				Complex indicator Q
	Artistic color scheme, points Z <sub>1</sub>	Elongation, % Z <sub>2</sub>	Surface density, gr/m <sup>2</sup> Z <sub>3</sub>	Drape * Z <sub>4</sub>	
Astrakhan	5	0,96	2,16	1,41	2,48
Karakul + lining	5	3,13	2,30	1,39	3,07
Broadtail	5	1,26	0,92	1,42	3,06
Swallowtail + lining	5	1,13	1,18	1,41	2,28
Nutria	4	2,22	2,16	-	
Nutria + lining	4	2,19	2,32	-	
Mink	5	2,21	1,08	1,40	2,53
Mink + lining	5	0,30	1,24	1,39	2,09
Relativeweight	1,4875	1,3353	1,3190	1,1672	

\* The drape of the experimental samples was determined by the disk method.

To determine the complex quality indicator Q, the formula was applied:

$$Q = \frac{\sum_{i=1}^n Z_{ji} * \Psi_i}{\sum_{i=1}^n \Psi_i} \quad (3)$$

Thus, the studies carried out have shown that all samples of fur plates have a certain level of quality, which is reflected by the value of the complex quality indicator, in turn, these quality levels are not lower than the base material indicator. At the same time, it is necessary to highlight the astrakhan fur with a lining as the best in terms of a comprehensive indicator of quality, followed by a broadtail, astrakhan, mink, broadtail with a lining and a mink with a lining. conduct their comprehensive quality assessment.

## REFERENCES

1. Innovative Design Methods in Fur Production. N.D Ergasheva, F.U. Nigmatova, Sh. Madzhidova G. Eshonkhonova, L. Kuldasheva. International Journal of Advanced Research in Science, Engineering and Technology Vol. 7, Issue 3, March 2020 Copyright to IJARSET
2. Terskaya L.A. Technology of cutting and sewing fur clothes / L.A. Terskaya. Academy - 2015 .-- 272s
3. GOST 4.186-85 Product quality index system
4. GOST 15467. Product quality management. Basic concepts, terms and definitions. Standardinform -2009.
5. Golovteeva A.A., Kutsidi D.A., Sankin L.B. Laboratory workshop on the course of chemistry and technology of fur leather.-M .: Legprombytizdat, 1982, -312s.
6. GOST 938.19-71; Leather. Tear test method (with Amendment N1)
7. 7.GOST 22596-77 Load at break of leather fabric N
8. GOST 938.20-71. Leather. Method for determining the apparent density);
9. GOST 26666.6-89 Artificial knitted fur. Method for determining the drape;
10. GOST 19878-2014 Furs, fur and sheepskin-coat products. Marking, packaging, transportation and storage;
11. GOST 9758-86 Method for determination of heat resistance;
12. GOST 17076-2: 2011 Leather - Determination of wear resistance.
13. 6. N.D Ergasheva, F.U. Nigmatova, B. B. Akhmedov, M.Sh. Shomansurova, N.A. Vakhobov, L. N. Kuldasheva. Research of Quality Indicators of Fur Plates from a Fur Flap. Turkish Journal of Computer and Mathematics Education Vol.12 No.7 (2021), 1095-1103 1095
14. Orlenko L.V., Gavrilova N.I. Configuring materials for clothes: Textbook.-M .: FORUM: INFRA-M, 2006.-228 p.
15. 15.S. Solovyov A.N., Kiryukhin SM. Assessment and forecasting of the quality of textile materials. - M .: Light and food industry, 1984., p. 215.

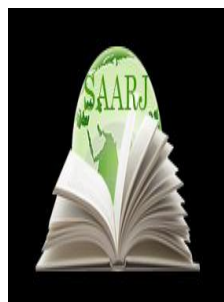

**ACADEMICIA**  
**An International**  
**Multidisciplinary**  
**Research Journal**  
 (Double Blind Refereed & Peer Reviewed Journal)

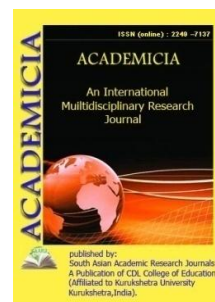

**DOI: 10.5958/2249-7137.2021.01333.1**

**QUANTITY IN PHYSICS ON THE LAWS OF ELECTROLYSIS**  
**PROBLEM SOLUTION TECHNOLOGY**

**Yusup Ganievich Makhmudov\***

\*Professor,  
 Doctor of Pedagogical Sciences,  
 Department of "General Physics", Termez State University,  
 UZBEKISTAN

**ABSTARCT**

*This paper describes the technology of solving quantitative problems in physics on the laws of electrolysis. Faraday's technology for selecting, constructing, and solving interdisciplinary problems on the laws of electrolysis is described in a consistent, logical manner.*

**KEYWORDS:** *Electrolysis, Electrolyte, Electrode, Anode, Cathode, Substance, Mass, Charge, Time, Solution, Conductor, Contact.*

**INTRODUCTION**

**1-** question. Electrochemical equivalent of chromium  $0,18 \cdot 10^{-6}$  kg / Kl, if 1 Kl of electric charge passes through the electrolyte, how much chromium is released during electrolysis? What if a charge of 20 Kl and 0.2 Kl is passed?

Given:

$$k = 1,8 \cdot 10^{-6} \text{ kg/ Kl}$$

$$q = 1 \text{ Kl}$$

$$q_1 = 20 \text{ Kl}$$

$$q_2 = 0,2 \text{ Kl}$$

$$m = ?$$

$$m_1 = ?$$

$$m_2 = ?$$

Answers:  $m = 1,8 \cdot 10^{-7} \text{ kg}; m_1 = 3,6 \cdot 10^{-6} \text{ kg}; m_2 = 3,6 \cdot 10^{-8} \text{ kg}.$

Formula:

$$m = kq$$

$$m_1 = kq_1$$

$$m_2 = kq_2$$

Solution:

$$m = 1,8 \cdot 10^{-7} \text{ kg/Kl} \cdot 1 \text{ Kl} = 1,8 \cdot 10^{-7} \text{ kg.}$$

$$m_1 = 1,8 \cdot 10^{-7} \text{ kg/Kl} \cdot 20 \text{ Kl} = 3,6 \cdot 10^{-6} \text{ kg}$$

$$m_2 = 1,8 \cdot 10^{-7} \text{ kg/Kl} \cdot 0,2 \text{ Kl} = 3,6 \cdot 10^{-8} \text{ kg}$$

**2-** question. Water is obtained from oxygen and hydrogen in the laboratory (by electrolysis, of course). How much oxygen is released at the anode and how much hydrogen is released at the cathode when a current of 1.2 A passes through the circuit in 30 min?

Given:

$$I = 1,2 \text{ A}$$

$$t = 1,8 \cdot 10^3 \text{ c}$$

$$m_{O_2} = ?$$

$$m_{H_2} = ?$$

Formula:

$$m_{H_2} = k_{H_2} \cdot It$$

$$m_{O_2} = k_{O_2} \cdot It$$

$$k_{O_2} = 8,3 \cdot 10^{-8} \frac{\text{kg}}{\text{Kl}}$$

$$k_{H_2} = 10^{-8} \frac{\text{kg}}{\text{Kl}}$$

Solution:

$$m_{H_2} = 10^{-8} \frac{\text{kg}}{\text{Kl}} \cdot 1,2 \text{ A} \cdot 1,8 \cdot 10^3 \text{ c} = 2,16 \cdot 10^{-5} \text{ kg.}$$

$$m_{O_2} = 8,3 \cdot 10^{-8} \frac{\text{kg}}{\text{Kl}} \cdot 1,2 \text{ A} \cdot 1,8 \cdot 10^3 \text{ c} \approx 1,8 \cdot 10^{-4} \text{ kg.}$$

Question.  $m_{H_2} = 2,16 \cdot 10^{-5} \text{ kg};$

$$m_{O_2} \approx 1,8 \cdot 10^{-4} \text{ kg.}$$

3- question. At what layer thickness of metal parts with a surface area of 120 cm<sup>2</sup> is nickel plated with a current of 0.3 A for 5 hours? The valence of nickel is 2, the molar mass  $58,7 \cdot 10^{-3} \text{ kg/mol}$ , density  $9 \cdot 10^3 \text{ kg/m}^3$  equal.

Given:

$$t = 1,8 \cdot 10^4 \text{ c}$$

$$\rho = 9 \cdot 10^3 \text{ kg/m}^3$$

$$S = 1,2 \cdot 10^{-2} \text{ m}^2$$

$$d = ?$$

$$m = ?$$

Solution:

The mass of nickel that separates on the surface of the product  $m = \frac{Aq}{nF}$  on the other hand,  $m = \rho Sd$ .

So,  $d = \frac{m}{\rho S}$  will be. If we find the mass and layer

thickness:

$$m = \frac{58,7 \cdot 10^{-3} \frac{\text{kg}}{\text{mol}} \cdot 1,8 \cdot 10^4 \text{ c} \cdot 0,3 \text{ A}}{2 \cdot 9,65 \cdot 10^4 \text{ Kl/mol}} = 1,65 \cdot 10^{-3} \text{ kg.}$$

$$d = \frac{1,65 \cdot 10^{-3} \text{ kg}}{9 \cdot 10^3 \text{ kg/m}^3 \cdot 1,2 \cdot 10^{-2} \text{ m}^2} = 1,53 \cdot 10^{-5} \text{ m.}$$

Answers:  $d = 1,53 \cdot 10^{-5} \text{ m}; m = 1,65 \cdot 10^{-3} \text{ kg.}$

4 - question. When oxidized (fermented) water is electrolyzed at a temperature of 270 C and normal atmospheric pressure, what is the minimum amount of electricity that a battery should have in order to release 5 liters of oxygen?

Given:

$$T = 300 \text{ K}$$

$$V = 5 \cdot 10^{-3} \text{ m}^3$$

$$\rho_o = 10^3 \text{ kg/m}^3$$

$$T_o = 273 \text{ K}$$

$$k = 8,29 \cdot 10^{-8} \frac{\text{kg}}{\text{Kl}}$$

$$q = ?$$

Solution:

We find the amount of electricity required for electrolysis

from this relationship:  $m = kq; q = \frac{m}{k}$ .

The mass of oxygen released  $m = \rho_o V_o$  formula,  $V_o$  the

volume is the Gay-Lussac law  $V_o = \frac{VT_o}{T}$

can be found from. This,  $q = \frac{VT_o \rho_o}{Tk}$  (1) will be

we perform the calculation by placing the numerical values of the quantities in formula (1).

$$q = \frac{5 \cdot 10^{-3} \text{ m}^3 \cdot 273 \text{ K} \cdot 1,43 \text{ kg/m}^3}{300 \text{ K} \cdot 8,29 \cdot 10^{-8} \text{ kg/Kl}} \approx 7,8 \cdot 10^4 \text{ Kl.}$$

In fact, the capacity of a battery is measured in Ampere · hours, but we have expressed its unit in Coulomb, considering SI.

Answer: Battery charge  $7,8 \cdot 10^4$  Kl should not be less than.

**5-** question. Gelvano-plate is used in the manufacture of matrices of gramplates. Initially wax form (shape)  $0,8 \text{ A/dm}^2$  coated with copper for 30 min at current density. In this case, the current separation is 90%. The next coating process  $5 \text{ A/dm}^2$  at a current density for 20 hours. In this case, the current separation is 95%. The surface area of a gramophone record  $3 \text{ dm}^2$  if so, how much copper will be consumed on average to obtain a single plate matrix?

Given:

$$I_1 = 80 \text{ A/m}^2$$

$$I_2 = 5 \cdot 10^2 \text{ A/m}^2$$

$$t_1 = 1,8 \cdot 10^3 \text{ c}$$

$$t_2 = 7,2 \cdot 10^4 \text{ c}$$

$$\eta_1 = 90\% = 0,9$$

$$\eta_2 = 95\% = 0,95$$

$$S = 3 \cdot 10^{-2} \text{ m}^2$$

Solution:

Indicates how much of the mass of the substance released during electrolysis is the pre-calculated (by current) mass,  $\eta = \frac{m}{m_{\text{account}}}$

in this  $m_{\text{account}}$  Determined from Faraday's 1st law. The mass of copper separated in the primary coating

$$k = 3,3 \cdot 10^{-7} \text{ kg/Kl} \quad \eta_1 = \frac{m_1}{m_{\text{account}}} \text{ in this}$$

$$m = ?$$

Can be determined from the relationship. Given that  $I = iS$ , we obtain:

$$m = \eta_1 k J_1 S t_1$$

In the same way we create the expression  $m_2$ :

$$m_2 = \eta_2 m_2 \text{ изоб.}, \quad m_2 = \eta_2 k J_2 S t_2$$

The total amount of copper extracted

$$m = m_1 + m_2 = kS (\eta_1 J_1 t_1 + \eta_2 J_2 t_2)$$

will be. We calculate this expression by substituting the numerical values of the quantities.

$$m = 3,3 \cdot 10^{-7} \text{ kg/Kl} \cdot 3 \cdot 10^{-2} \text{ m}^2 \cdot (0,9 \cdot 80 \text{ A/m}^2 \cdot 1,8 \cdot 10^3 \text{ c} + 0,95 \cdot 500 \text{ A/m}^2 \cdot 72 \cdot 10^3 \text{ c}) \approx 0,34 \text{ kg.}$$

Answer: It takes about 0.34 kg of copper to make one matrix.

**6-** question. The surface of metal objects is electrolytically coated with  $20 \mu\text{m}$  thick silver. A current density  $2,5 \cdot 10^{-3} \text{ A/cm}^2$  If so, how long will the electrolysis take?



Given:

$$h = 20 \text{ mkm} = 2 \cdot 10^{-5} \text{ m}$$

$$J = 2,5 \cdot 10^{-3} \text{ A/cm}^2 = 25 \text{ A/m}^2$$

$$\kappa = 1,118 \cdot 10^{-6} \text{ kg/Kl}$$

$$\rho = 10,5 \cdot 10^3 \text{ Kl/m}^3$$

$$\mu = 108 \cdot 10^{-3} \text{ kg/mol}$$

$$F = 9,65 \cdot 10^4 \text{ Kl/mol}$$

$$n = 1$$

$$t = ?$$

Solution:

1-method. We solve the problem using Faraday's

law 1 for electrolysis.  $m = kIt \Rightarrow t = \frac{m}{kI}$  (1).

We find the mass and current using the following formulas:

$$m = \rho S h \quad (2); \quad I = jS \quad (3).$$

(1) to (2) and (3) of take away

$$t = \frac{\rho h}{nJ} \quad (4) \text{ is formed.}$$

Now we calculate by substituting the numerical values instead of the quantities to the right of formula (4).

$$t = \frac{10,5 \cdot 10^3 \text{ Kl/m}^3 \cdot 2 \cdot 10^{-5} \text{ m}}{1,118 \cdot 10^{-6} \text{ Kl/Kl} \cdot \text{A/m}^2} = 7,5 \cdot 10^3 \text{ c.}$$

2-method. If the numerical value of the electrochemical equivalence is not given, then the

problem can be solved on the basis of Faraday's unified law.  $m = \frac{A}{F} \frac{\mu}{n} It$ , from here  $t = \frac{mF \cdot n}{\mu I}$

(1) formula is formed. Mass and current strength using the above formulas, that is 1-method:  $m$

$= \rho V = \rho Sh$ ;  $J = IS$  in that case  $t = \frac{\rho h F n}{AJ}$  (2) derived from the formula.

Now we calculate by substituting the numerical values instead of the quantities to the right of formula (2).

$$t = \frac{10,5 \cdot 10^3 \text{ kg/m}^3 \cdot 2 \cdot 10^{-5} \text{ m} \cdot 9,65 \cdot 10^4 \text{ Kl/mol} \cdot 1}{108 \cdot 10^{-3} \text{ kl/mol} \cdot 25 \text{ A/m}^2} = 7,5 \cdot 10^3 \text{ c.}$$

Answer: For silver  $7,5 \cdot 10^3 \text{ c}$  or about 2.1 hours.

7- question. From fermented water through an electrolytic bath (during electrolysis)  $27^\circ \text{C}$  temperature and  $10^5 \text{ Pa}$  at pressure  $1 \text{ dm}^3$  How to charge to get gas?

Given:

$$p = 10^5 \text{ Pa}$$

$$V = 1 \text{ dm}^3 = 10^{-3} \text{ m}^3$$

$$F = 9,65 \cdot 10^4 \text{ Kl/mol}$$

$$T = 300 \text{ K}$$

$$q = ?$$

Solution:

First, we determine the amount of gas (in molar):

$v = pV/RT$ , by erda  $R = 8,31 \text{ J/(mol}\cdot\text{K)}$  in the electrolysis of water, hydrogen atoms are released twice as much as oxygen

atoms. The amount of hydrogen  $V_1 = 2V/3 = \frac{2\rho V}{3RT}$ .

Given that a gaseous hydrogen molecule is made up of two atoms, we create the charge we are looking for according to Faraday's laws.

$$q = F \cdot 2 V_1 = \frac{4FpV}{3RT}$$

Now we calculate the numerical values instead of the quantities involved in the equation.

$$q = \frac{4 \cdot 9,65 \cdot 10^4 \text{ Кл/мол} \cdot 10^5 \text{ Па} \cdot 10^{-3} \text{ м}^3}{3 \cdot 8,31 \cdot 10^3 \text{ J/(мол К)} \cdot 0,3 \text{ К}} = 5,2 \cdot 10^3 \text{ Кл.}$$

Answer:  $q = 5,2 \cdot 10^3 \text{ Кл.}$

It is advisable to address the above issues in order to determine the extent to which students have mastered the theoretical knowledge, practical skills and competencies acquired in the subjects of physics and chemistry.

#### REFERENCES:

1. Voronkov G.Ya. Electricity in the world of chemistry. –М.: Knowledge, 1987.
2. Manolov K. Great chemists. Translation from Bulgarian. Vol. 1. –М.: -Mir, 1985.S. 262-279.
3. Mahmudov Yu.G. A set of questions on the laws of electrolysis. -Tashkent: New edition, 2015.
4. Mahmudov Yu.G. Application of electrolysis laws in agriculture. // Magazine "People's education". №8-2008. -В. 31-32.
5. Мусабеков Ю.С.,Черняк А.Я. Выдающиеся химики мира. –М.: Книга, 1971. С. 116-121.
6. Omanov Kh.T., Rasulov K.R. Chemical evening "Faraday, electricity and chemistry". // "Chemistry at school" magazine. -No. 3, 1991. S. 66-68.

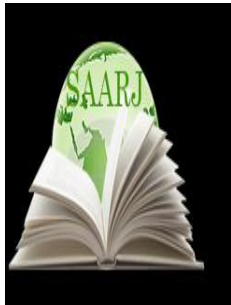

**ACADEMICIA**  
**An International  
 Multidisciplinary  
 Research Journal**  
 (Double Blind Refereed & Peer Reviewed Journal)



**DOI: 10.5958/2249-7137.2021.01336.7**

## READER-SPECIFIC ASPECTS OF THE FORMATION OF ECOLOGICAL CULTURE IN YOUNG PEOPLE

**Umida Abduvahabovna Bovanova\***

\*Independent Researcher,  
 Teacher of the Institute of Entrepreneurship and Pedagogy Denov,  
 The Republic of Uzbekistan, Surkhandarya Region,  
 UZBEKISTAN

Email id: [umidabovanova@gmail.com](mailto:umidabovanova@gmail.com)

### ABSTRACT

*The aggravation of global problems, the deterioration of the ecological situation, the emergence of more and more natural disasters, the wasteful and disrespectful attitude to the nature of individuals require increased attention of society to environmental problems. These problems can be solved only by increasing the general ecological culture, value attitude to nature and the formation of an ecological worldview in all people. The ecological culture of a society is understood as a system of social norms, values, human relations in the field of environmental protection and harmonious development. One of the elements of ecological culture is an ecological attitude towards the natural world - an efficiently practical, strong-willed, environmentally healthy behavior in accordance with the laws of interaction with humans in nature, legal norms, moral norms. Therefore, this article analyzes the features of the formation of ecological culture among students from a scientific and practical point of view. It was also revealed from the pedagogical point of view that the peculiarities of the ecological culture of students are reflected in their understanding of the ecological situation, understanding of the essence of the content, their attitude to public life.*

**KEYWORDS:** *Global Problem, Modern Education, Ecological Situation, Ecological Consciousness, Ecological Knowledge, Ecological Need, Ecological Culture, Ecological Worldview.*

## INTRODUCTION

The 21st century is characterized by a change in the quality from material products to products of traditional activity, an increase in the need for resource-saving technologies and an increase in the problems of environmental balance. In our country, this transition is complicated, first of all, by a sharp change in socio-economic formation, which determines the development of a new attitude to life problems and the potential of the individual. At the same time, science and the potential for it monandly intellektual have been developing for decades. Therefore, it is necessary to start as early as possible to create optimal conditions for the development of the first society and the creative potential of each individual. The established practice of educating young leaders in the field of Science, Technology, Culture and others, the introduction of new requirements in teaching them to creative thinking is one of the pressing issues. This opens up new horizons for the development of the pedagogical science system and teaching practice in our country. In particular, it is important to improve the attitude of schoolchildren to knowledge, to develop cognitive interests, to develop Natural Sciences in harmony with pedagogical knowledge, which have great potential for the formation of the scientific worldview and the modern scientific landscape of the world, Planet, ecocentric consciousness.

In natural science at the beginning of the XXI century at the end of the XXI century, natural social-humanitarian knowledge was acquired on an individual basis. The basis of this trend is characterized primarily by the fact that the individual himself - has become a common and dominant object of their research. In this regard, we must not forget that natural sciences have great opportunities for the formation of a scientific, creative worldview in young people. After all, knowledge of the laws of nature, the direct understanding of the harmony of the laws of inanimate and living nature and social processes motivate them to take into account in all spheres of human activity. Without a new vision of the world and the role of man in it, thinking about the fate of the future generation creates a much more complex landscape. The solution of environmental and social problems of both global and regional character requires only the creation of a new type of culture, the harmonization of education and training with the modern process of providing quality ecological knowledge. To do this, it is required first of all to formulate the environmental consciousness of young people, to update them the appropriate stereotypes of personal behavior, to form an active civil position of the individual in solving various problems.

An important problem of modern education is the expression from the understanding of the principles of consistency, continuity and integrability of knowledge in the study of natural phenomena. The first and most important level in the education system, which creates the foundation of the future education of young people, is formed in the system of preschool and primary education. Therefore, serious changes in the content of primary education began in the 90-ies of the XX century. Even at that time, the primary goal of preschool and primary education was called the development of the personality of the child. In addition, today, special attention is paid to the individualization of education and the creation of an educational environment in which each child feels comfortable and develops at an acceptable level.

One of the important problems faced by educators in preschool institution and primary education system is to ensure continuity in the absorption of natural science knowledge of children of preschool and primary school age. To solve it, it is necessary to seriously update the content of Natural Science Education by integrating modern scientific knowledge into educational

processes. This is greatly facilitated by the effective use of the changing character of modern education, which requires the inclusion in the kindergarten and primary school curriculum of the educational direction "Man and nature", which is composed of Natural Sciences and social sciences, philosophy and other fields. For this, it is important to effectively implement the technology of environmental culture development in young people.

### **LITERATURE ANALYSIS AND METHODOLOGY**

The need for the formation of ecological culture in young people is associated with a number of subjects and sub-factors. At a time when the concept of deepening democratic reforms in society and the development of civil society is being implemented, the role of youth in the solution of environmental problems is increasing. Also, global, regional, local, national environmental problems are among the factors that adversely affect the development of society. Zero, A.V. Asgirosov rightly pointed out, "a country without an ecological culture is dangerous not only for its inhabitants, but also for the inhabitants of other countries. After all, production and economic waste, which pollute nature, do not know the National Border. From our point of view, low levels of ecological culture and environmental consciousness, old views contrary to the existing ecology create problems with the preservation of such a large number of nature. In such conditions, issues of formation and increasing environmental culture of our youth play an important role.

Sh.E. Khamrokulova noted that "as environmental education works are carried out inseparably, the development of environmental competence in students before each educator stands as one of the main issues. Scientists interpret environmental competence differently. From the age of schoolchildren, due to their social characteristics, the interpretation of environmental competence – environmental knowledge, qualifications and skills, in view of which students will be able to correctly apply them throughout life. If the reader is able to approach the side-surrounding events from the point of view of causing harm or not causing harm to nature, correctly analyze the result of observations and try not to cause harm to nature itself in practice, then each educator, or employee, will be performing his duties correctly. In our view, in order to form an ecological culture in the reader-youth, it is necessary, first of all, to study the heritage of the people's historically composed values in relation to nature. Then it is possible to create a system of rules for changes in the life of society, protection of the environment and rational use of all types of Natural Resources. The pollution of the environment is also the reason that educational work on the protection of nature in the education of people is not adequately conducted.

To be kind and fair to the environment, to the nature does not bring much benefit to the self of teaching, teaching, of course. It should be used, applied practically in knowledge and education. Therefore, S.HeAsKistaubaev rightly pointed out, "it is important to develop a holistic pedagogical-didactic technology that ensures the coordination and continuity of the activities of institutions dedicated to environmental education and training and to look for potential opportunities for their introduction into life".

The organization of effective environmental education of Primary School students gives them the opportunity to protect the environment, keep it clean and increase its wealth. This process is meant to lead a healthy life and leave an ecologically clean environment for future generations, environmental education and Environmental Protection are first and foremost the protection of future generations of the nation. M.K. According to Shirinov, " environmental education in the

primary classes is carried out during lessons and extra-curricular times. In extracurricular times, ecological education is formed in the process of conducting Saturdays, conversations, fairy tales, taking students on a trip to nature Bay, Nature museums. In the course of the lesson, students receive environmental education through the story of the teacher and the topics expressed in the textbooks." Therefore, the state policy of the population in the field of environmental education is aimed at providing conditions for the ecological upbringing of the population of competent state bodies and coordinating the activities of state, public organizations on the formation of the general and ecological culture of individuals and society. The main goal of environmental education is to educate the students and young people in the spirit of high environmental education, to properly organize the trends of strengthening their ecological culture and formation of healthy attitude to the environment, and on the basis of this, to effectively organize the system of protection and rational use of the beautiful nature of our country.

Ecological culture is an integral part of a secular and national culture, which includes a set of norms and methods of social relations, moral values, interaction of society with the environment, and which has become an inheritance for the formation of environmental knowledge and consciousness in the social consciousness and morality of people. Therefore, on the basis of raising ecological culture, it is important to educate generations who will contribute to healthy life, the growth of the spirituality of society, sustainable socio-economic development, environmental security of the country and the individual. In this sense, M.S."Man and society are responsible for the preservation and protection of the environment, natural and social riches in general. This can only be achieved by means of educating people's environmental ethics and culture. The upbringing of an ecological moral culture of a person is the most important factor that ensures the development of society, rational use of nature, which constitutes an important direction in solving existing environmental problems. Therefore, the issue of environmental ethics and culture education is one of the important ways of solving problems that threaten the head of humanity, including the lives of the population of Uzbekistan".

The formation of ecological culture in schoolchildren-young people is a rather complex process, requiring Komplex-systemic concomitant use of various methods, means. Therefore, the process of raising the ecological culture of people in the process of education can be conditionally divided into two directions: the first is the formation of an ecological culture with the ability to feel bevoista, rational understanding of the uniqueness and beauty of nature in schoolchildren-youth; the second is the development of ecological culture by knowing the essence, content of spiritual and moral and cultural factors that reflect nature. This, in turn, is the need to develop rational perception of nature, which requires the ecology of all sciences. This task entails the generalization of the theoretical and practical aspects of alternative views on the educational process in the society and the constant implementation of it in all its directions.

## **DISCUSSION AND RESULTS**

At present, it is important theoretical and practical to bring into being the aspects of environmental culture in youth, the forms of its manifestation and, finally, its manifestations in practice. The peculiarity of the ecological culture of young people is manifested in their understanding of the ecological situation, understanding of the essence of the content, expressing their suitability for their appearance in social life. The formation of ecological culture in young people is closely connected with the fact that our country has entered a new stage in its development, with its efforts to take place among the developed democratic countries. At the

same time, the protection of the ecological situation on the borders of our homeland is not only the task of state organizations, but also the work of the general public and youth.

In this regard, it should be noted that in accordance with the strategy of action on five priority areas of development of the Republic of Uzbekistan in 2017-2021, the expansion of production of environmentally friendly products; mitigation of the negative impact of global climate changes and the construction of the Aral Sea; provision of modern facilities for the elimination of waste; prevention of environmental problems that harm the environment, the health and the gene pool of the population, etc., is defined as a priority task.

The maintenance of ecological balance, the cleanliness of the environment, the Prevention of situations that have a negative impact on human health and labor activity are largely dependent on the social activity of the public, youth. In the conditions of modernization of all sectors of the economy, the construction of a democratic and legal state, as well as the development of civil society, the social activity of young people increases, the direct participation of each member of society in the rational use of the natural resources available in our country. In the strategy of further development actions of the Republic of Uzbekistan in 2017-2021, the issue of "prevention of environmental problems that can harm the environment, health and gene pool of the population " is of particular importance.

The environmental situation in the territory of Uzbekistan and constant monitoring for its further improvement are one of the strategic issues in the interests of the youth of our country. This process requires the efficient use of Natural Resources, the transmission of mined minerals to consumers without losses, the wide and productive use of modern technologies in their processing to ensure efficiency. One of the peculiarities and linkages of this issue with the youth ecological culture is the possibility of using the experience of using natural resources in developed countries, taking into account the development of the economy in a globalized environment. Also, the relevance of the formation of the ecological culture of young people is associated with the further improvement of the use of available land, water, biological resources, the features of intensive development of economic sectors. Effective use of natural resources requires the improvement of the legal framework, which is regularly associated with the ecological process. Such a concerted approach to the problem is the globalisation of environmental issues, the close link between the solutions of issues arising in the process of the use of Natural Resources in the regions.

The formation of ecological culture in the reader-youth is largely associated with their environmental consciousness, education, spiritual and Educational Directions. Consequently, this can be done only when the principles of ecology of social, economic, spiritual spheres of development of society are complied with the normative-legal norms of their legality. This conscious activity of man forms an ecological culture only in the destiny that has become an ecological need. Reader-the ecological culture of young people does not form spontaneously in a stichy way. This process is measured by the level of his knowledge, how he can analyze socio-environmental problems, his attitude to the natural environment, his environmental range and the breadth of his outlook. The fact that the ecological culture of the reader-youth interacts with other types of Culture legal, aesthetic, moral, political, economic culture can be explained by the fact that there are no any social phenomena that are not directly or indirectly related to this form of culture.

When it comes to the ecological culture of the reader-youth, their style of thinking in the formation of this process is measured by the fact that its spiritual-moral, socio-historical traditions of nature protection, that is, historicity, succession, science, how they absorb and use systematic prints wisely. This process is also closely connected with the spiritual and educational activity of young people. This activity is associated with the preservation of the external environment with ecology, with modern talabi, with human health. Therefore, the essence and content of environmental culture is manifested in the process of deep understanding of the unity of Man and nature, understanding of the true essence of internal legal, necessary connections between human life, activity and the external environment, adherence to it in practical activities, genuine humanity, observance of the laws, principles of existence.

The ecological culture of the reader-youth is manifested in the connection of scientific and theoretical knowledge about the degree of tamoxification of the ways of educating its ecological quality, qualities, the balance of the biosphere with the goals and objectives of nature protection in practical activities. The true ideological nature of this form of culture, the other side of its enlightenment, is connected with the appropriation of the universal values of this ecological thinking. Therefore, today the importance of developing criteria for assessing the level of environmental awareness and cultural development of young people is enormous. Because, the use of new techniques, technologies and raw materials in production, the need for the development of environmentally competitive products will force entrepreneurs to think more broadly and deeper into the environment. Teaching them to think at the theoretical level of environmental consciousness leads to the penetration into the essence of environmental processes and the creation of various scientific ideas, theories, principles, models, concrete programs and plans on the basis of knowledge of the laws of ecological equilibrium of the biosphere. Transform them into a broad mass of people, that is, to convey them to all layers of the population in a simple and understandable way form a national ecological way of thinking.

A necessary condition for ecological cultural activity is the awareness of the responsibility of each individual for the future of nature and society. Bunda performs two tasks in which cultural values are interrelated; that is, it coordinates the possibilities of the subject of man with the object of necessity, and also harmonizes his personal and social interests. Accordingly, ecological culture, on the one hand, consists in the informal transformation of Man Into Nature, limiting the freedom of Will, on the other hand, is a factor that stimulates the activity of Nature Conservation. That is, it should be regarded as a social phenomenon that ensures the positive activity of the individual. The mutual unity of these is the necessary basis for the management of human ecological cultural activities . These factors also embody the requirements of nature protection and create the opportunity to manage the environmental actions of an individual Komplex. The issue of the impact of environmental culture on the development of society is widely covered in the scientific literature, there is a complex of alternative views.

The main task of ecological culture is to educate young people on the ecological attitude to nature and become a component of general education. Accordingly, on the one hand, the degree of development of socio-economic relations in different societies can be determined, in a certain sense, by the criterion of cultural attitude to nature. On the second hand, environmental education is in the interests of its protection through the culturing of the educational process.

The formation of human spirituality on the basis of ideas of humanism in ensuring environmental stability, the rise of political and legal culture, the embodiment of human consciousness and



consciousness of self-esteem and love for Living Nature gives a positive result. Without an ecological balance, there will be no peace, tranquility, memorabilia, the population will not be able to live comfortably, freedom will be limited, the observance of laws, people's jipsizlik, interest in life will be slowed down, mutual affection between people will eventually disappear, the political, legal structure of the state will be disrupted.

The general purpose of research in the field of ecology is considered to harmonize nature and Human Relations. In this process, the transformation of scientific knowledge, that is, the transition of the scientific knowledge system to a new complex system, creates new prospects. After all, as we observe the transformation in science (changes in the object, subject, interaction and connections, the amount of knowledge, the increase in its species, the transfer, mastering and storage of knowledge), we can see that it develops in harmony with the relations of Man and nature. As a result, this reflection is expressed in the study of the interaction of Man and nature in the study of science. In such scientific research, different approaches to nature and Human Relations appeared. In the vast majority of these collisions, a person is also a part of nature, and his attitude to nature is shown to change and develop. In fact, the evolutionary dialectic character of the interaction of Man and nature is characterized by the fact that again the following types of this interaction are noted separately: to look at nature as a simple object, which can be influenced only by classical methods; the second type, to look at nature as a subject of dialogue. But such interaction can become a bottleneck at any time due to the fact that it does not have a deep character; the third is the degree of coevolution of Man and nature, in which man and nature are interrelated, recognized as one whole, and this is now being developed and interpreted as the main way of preserving man, nature.

In general, the role of environmental education and upbringing is important in preventing environmental problems. The main purpose of environmental education is to form in students a conscious attitude to the problems of nature and the environment. The younger generation should not be limited to studying today's environmental problems. They need to anticipate the consequences of existing environmental problems and organize their activities accordingly. To do this, you need to learn to seek knowledge and follow it. Ecological culture is a part of the world culture, a deep understanding of the importance of environmental problems in human life and its future development is the protection of nature and the environment. Highly spiritual and ecologically cultured people should adhere to the following: to imagine the integrity of nature and society, to treat it consciously, to prevent pollution of the biosphere, to use its resources sparingly and pass it on to future generations, national traditions to know habits, to be intelligent, tasteful, prudent, to have a culture of behavior, to have spiritual, political, legal, ecological knowledge, and so on.

## CONCLUSION

The general trend of the present period shows that all segments of the population, especially the youth, are acquiring a new ecological culture. At the same time, two trends are taking place under the influence of specific factors: first, the current state of the ecological situation, the nature of nature protection practices require people to objectively comply with the requirements of a new ecological culture. This is because inert thinking leads to catastrophe in an increasingly ecological situation on a global scale; second, it is observed that the ecological culture of all segments of the population, especially the youth, is becoming an active subjective factor.

**LIST OF USED LITERATURE:**

1. Girusov A.V. Culture as a way of developing society and preserving the natural environment./In the book: History. Culture. Civilization. - M.: 1991. - p. 9.
2. KhamrokulovaSh.E. Issues of improvement of environmental education and training in secondary schools. ACADEMIC RESEARCH IN EDUCATIONAL SCIENCES VOLUME 2 | ISSUE 3 / 2021 ISSN: 2181-1385 Scientific Journal Impact Factor (SJIF) 2021: 5.723.[www.ares.uz](http://www.ares.uz)
3. KistaubaevS.He The role of national values in shaping the ecological worldview of the individual. Author of the dissertation of the doctor of Philosophy (PhD) in philosophy. - Samarkand, 2019. -B.18.
4. Shirinov M.K. The technology of using the controversial lesson in giving environmental education to students. // MODERN EDUCATION / SOVREMENNOE OBRAZOVANIE 2016, 9. - B.48.
5. Yayboeva M.S. Moral and moral principles and criteria of ecological relations to nature. "Science and Education" Scientific Journal. May 2020. - B.594. [www.openscience.uz](http://www.openscience.uz)
6. Decree of the president of the Republic of Uzbekistan "on the strategy of actions for further development of the Republic of Uzbekistan" № PF-4947 on February 7, 2017 // [www.lex.uz](http://www.lex.uz)
7. Decree of the president of the Republic of Uzbekistan "on the strategy of actions for the further development of the Republic of Uzbekistan" / / collection of legislation of the Republic of Uzbekistan, 2017, 6-th, 70-th article).
8. Lemeshev M. Ya. Nature and we. - M.: 1989. - p. 112.

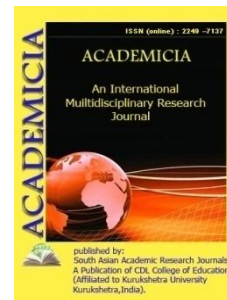
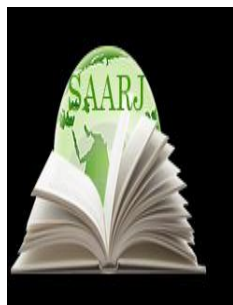

DOI: **10.5958/2249-7137.2021.01338.0**

## TYOLOGICAL FEATURES OF STUDENTS' LEARNING ABILITY IN THE STUDY OF MATHEMATICS IN HIGHER EDUCATION

**Otabek Samandarovich Matchonov\***

\*Senior Lecturer,  
Doctor of philosophy (PhD) in physics and Mathematics,  
Tashkent Chemical-Technological Institute,  
Tashkent, UZBEKISTAN

### ABSTRACT

*This article is devoted to the study of the typological features of students' learning ability in the study of mathematics. Proficiency is a comprehensive criterion, which gives us a definitive picture of the availability of the necessary knowledge, skills and abilities of the student, but at the same time, this criterion does not contain information on the cause of deficiencies in LP. And the more variety of content and form of educational material passes through his perception and practice in changing situations of activity, the more this ability will be richer in skills, stronger, more consolidated and more mobile in his activity”.*

**KEYWORDS:** *Proficiency, Level Of Proficiency, Learning Ability, Perception, Objectivity, Integrity, Constancy, Categorical Nature, Meaningfulness.*

### INTRODUCTION

In pedagogy there is no precise interpretation of the concept of “proficiency”. The pedagogical dictionary defines proficiency as “the result of learning, which includes both the present storage of knowledge available to the day, and the established ways and techniques of acquisition thereof”. Thus, proficiency is both a basic component for further learning and result of learning at each stage of learning.

According to S.I. Arkhangelskiy, proficiency is defined as - “one of the essential qualities of the learner, reflecting his ability to operate with knowledge and skills in solving of theoretical and practical problems, which he acquires acting on specific educational material. And the more variety of content and form of educational material passes through his perception and practice in changing situations of activity, the more this ability will be richer in skills, stronger, more consolidated and more mobile in his activity”.

We will distinguish student proficiency as high, medium and low. The level of proficiency (LP) shall be characterized as follows:

High LP - the student deeply and completely possesses the content of the educational material and conceptual framework; is able to link theory with practice, to illustrate by examples. Quickly and rationally solves the assigned tasks, clearly and briefly states the answers to the questions posed; can justify his/her judgments on the issue presented. The answers are independent.

Average LP - the student deeply and completely possesses the content of the educational material and conceptual framework; is able to link theory with practice, illustrate with examples, but the content of the answer has some inaccuracies (minor errors) in the presentation of theoretical and practical material, is less particular and complete; mistakes are corrected by the student after further questions from the teacher.

Low LP - the student shows incomplete knowledge and understanding of the main provisions of the educational material, makes inaccuracies and significant errors in the definition of concepts and basic formulas, is not able to justify his/her judgments, there is a violation of the logic in presentation. The answer is characterized by a low level of independence.

Proficiency is a comprehensive criterion, which gives us a definitive picture of the availability of the necessary knowledge, skills and abilities of the student, but at the same time, this criterion does not contain information on the cause of deficiencies in LP. The criterion that gives us information about the reasons why the student has difficulties in the learning process, and as a consequence, LP shortfalls, is learning ability.

In the psychological dictionary, learning ability is defined as individual measures of the speed and quality of human learning of knowledge, skills and abilities in the process of learning.

Z.I. Kalmykova treats learning ability as one of the main indicators of mental development, understands it as a system of intellectual qualities of mind, which determines the productivity of learning activities under other equal conditions (the initial minimum of knowledge, a positive attitude to learning, etc.).

Learning ability is based on: the level of development of cognitive processes of person - perception, imagination, memory, thinking, attention, speech; the level of development of his spheres - motivational and volitional and emotional; development of learning activity components derived therefrom - clarification of the content of educational material from direct and indirect explanations, mastering of the material to the degree of active application.

We shall consider the typological features that underlie learning ability. First we shall consider such characteristic of the learner cognitive processes development as perception.

Perception (from Latin perceptio) - from the pedagogical point of view, it is a cognitive process that forms a personal world view.

The main properties of image formed in the process and as a result of perception are objectivity, integrity, constancy, categorical nature, meaningfulness.

Thingness - a characteristic feature of perception thingness is that as soon as we focus on a certain object, the entire perceived space is instantly divided into an image of the object itself and an image of the space surrounding the object.

Integrity - unlike sensation, which reflects individual properties of the object, perception gives a holistic image of it.

Constancy is the ability to perceive objects as relatively constant in shape, color and size, and a number of other parameters regardless of changing physical conditions of perception.

The categorical nature of human perception manifests itself in the fact that it has a generalized nature. The perceived object is named, and therefore classified, belongs to a certain category. The subject generalizes with others of the same name.

The meaningfulness of perception. Human perception is closely related to thinking. Apperception of an object means to mentally name it, i.e. to refer it to a certain group, class, to generalize it into a word. Even when we see an unknown object, we try to establish similarities with familiar ones in it.

Any lesson of the teacher with the student, necessarily consists of various techniques to enhance perception. The lesson material is written on the blackboard or in the textbook, the most important formulas are underlined, which is a way to separate the information being studied from the common flow, i.e. thingness. When solving problems, all possible options are necessarily examined. For example, when studying a function for extremum and monotonicity, all extremum points are searched for, and accordingly the information obtained as a result of this study will be complete, i.e. holistic.

Each topic necessarily contains several problems on the studied subject, so the same types of objects, such as points of extremum, are sought for different functions, changing their number and nature, for some functions, they may simply be absent.

Here such properties of perception as constancy and categorical nature are manifested. The result of study of each topic is the ability of each student to independently find not only solutions, but also ways to solve problems, i.e. to independently identify significant characteristics of the studied object, to relate them to the existing hierarchy (for example, with the classification of break points or types of solutions of differential equations), which means meaningful perception of the studied material.

## **CONCLUSION**

After the object under study has been isolated from its environment as a coherent, complete image, correlated with other similar ones, and classified, the information obtained must be stored. The memory stores information. We shall consider memory as a cognitive process.

## **LIST OF USED REFERENCES:**

1. Andreev V.I. The pedagogy of creative self-development. – Kazan, 2012
2. Osmolovskaya I.M. “Didactics: Textbook for Higher Education Institutions”. Publishing House: Akademiya, 2006

3. Zotova I.V. Formation of communicative skills of students in the educational process // Problems and prospects for the development of education: Proceedings of the V International Scientific Conference. (Perm city, March, 2014) - Perm city: Merkuriy, 2014 - p. 202-204.
4. Cheredov I.M. The learning process: methods, forms. Monograph. Omsk city: OmGPU Publishing House, 1997.
5. Kalmykova Z.I. Productive thinking as the basis for learning / - M. Pedagogika, 1981 – 200p. fig. 20 cm

## Editorial Board

**Dr. B.S. Rai,**  
Editor in Chief  
M.A English, Ph.D.  
Former Principal  
G.N. Khalsa PG.College,  
Yamunanagar, Haryana, INDIA  
Email: balbirsinghrai@yahoo.ca

**Dr. Romesh Chand**  
Professor- cum-Principal  
CDL College Of Education,Jagadhri,  
Haryana, INDIA  
Email: cdlcoe2004@gmail.com

**Dr. R. K.Sharma**  
Professor (Rtd.)  
Public Administration,  
P U Chandigarh, India  
Email: sharma.14400@gmail.com

**Dr. Mohinder Singh**  
Former Professor & Chairman.  
Department of Public Administration  
K. U. Kurukshetra (Haryana)  
Email: msingh\_kuk@yahoo.co.in

**Dr. S.S. Rehal**  
Professor & chairman,  
Department of English,  
K.U. Kurukshetra (Haryana)  
Email: srehal63@gmail.com

**Dr. Victor Sohmen**  
Professor,  
Deptt. of Management and Leadership  
Drexel University Philadelphia,  
Pennsylvania, USA.  
Email: vsohmen@gmail.com

**Dr. Anisul M. Islam**  
Professor  
Department of Economics  
University of Houston-Downtown,  
Davies College of Business  
Shea Street Building Suite B-489  
One Main Street, Houston,  
TX 77002, USA  
Email: islama@uhd.edu

**Dr. Zhanna V.Chevychalova, Kharkiv,**  
Associate Professor,  
Department of International Law,  
Yaroslav Mudry National Law University,  
UKRAINE  
Email:zhannachevychalova@gmail.com

**Dr. Kapil Khanal**  
Associate Professor of Management,  
Shankar Dev Campus,  
Ram Shah Path T.U. Kirtipur, NEPAL.  
Email:kapilkhanal848@gmail.com

**Dr. Dalbir Singh**  
Associate Professor  
Haryana School of Business, G.J.U.S & T, Hisar,  
Haryana, INDIA  
Email: dalbirhsb@gmail.com

**Nadeera Jayathunga**  
Senior Lecturer  
Department of Social Sciences,  
Sabaragamuwa University, Belihuloya,  
SRI LANKA  
Email: nadeesara@yahoo.com

**Dr. Parupalli Srinivas Rao**  
Lecturer in English,  
English Language Centre,  
King Faisal University, Al-Hasa,  
KINGDOM of SAUDI ARABIA  
Email: vasupsr@yahoo.com

## Categories

- Business Management
- Social Science & Humanities
- Education
- Information Technology
- Scientific Fields

## Review Process

Each research paper/article submitted to the journal is subject to the following reviewing process:

1. Each research paper/article will be initially evaluated by the editor to check the quality of the research article for the journal. The editor may make use of iThenticate/Viper software to examine the originality of research articles received.
2. The articles passed through screening at this level will be forwarded to two referees for blind peer review.
3. At this stage, two referees will carefully review the research article, each of whom will make a recommendation to publish the article in its present form/modify/reject.
4. The review process may take one/two months.
5. In case of acceptance of the article, journal reserves the right of making amendments in the final draft of the research paper to suit the journal's standard and requirement.

## Published by

### South Asian Academic Research Journals

A Publication of CDL College of Education, Jagadhri (Haryana)  
(Affiliated to Kurukshetra University, Kurukshetra, India)

Our other publications :

South Asian Journal of Marketing & Management Research (SAJMMR)

ISSN (online) : 2249-877X

SAARJ Journal on Banking & Insurance Research (SJBIR)

ISSN (online) : 2319 – 1422